

The Australian COMMODORE REVIEW

3

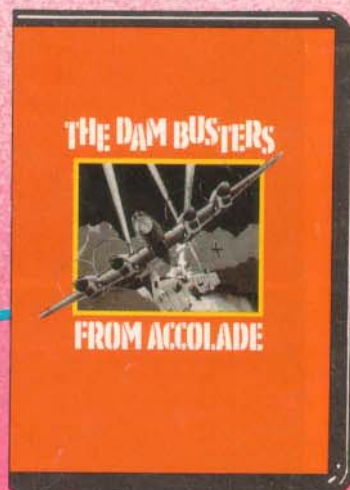

The Commodore 64 Music Maker.

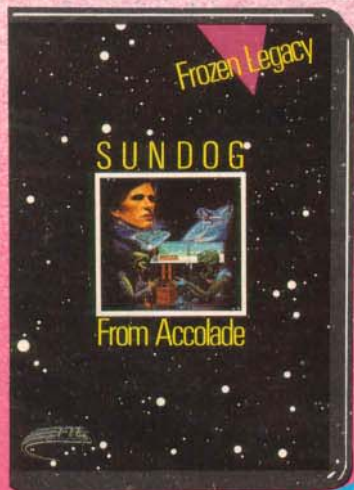
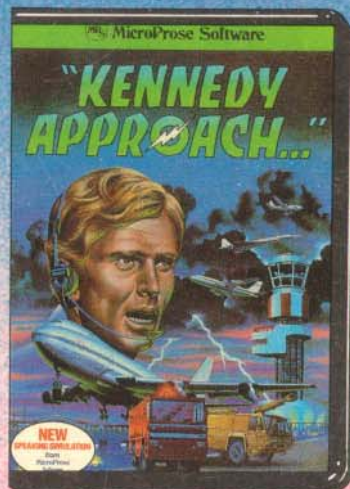
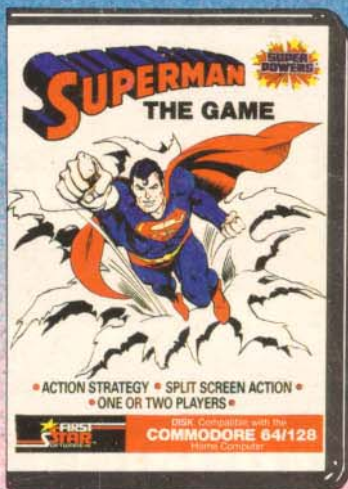
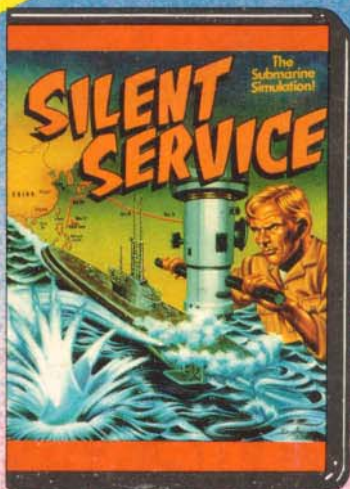
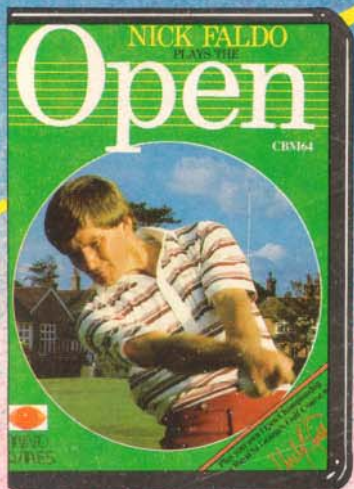
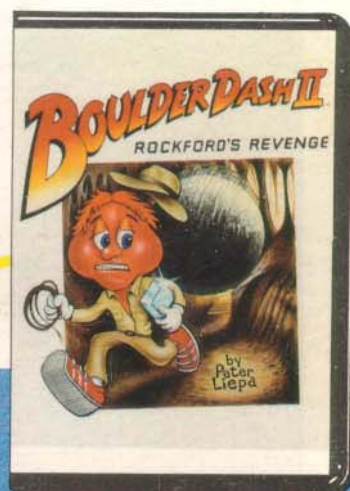
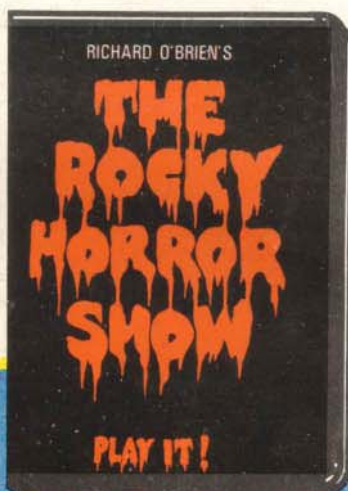
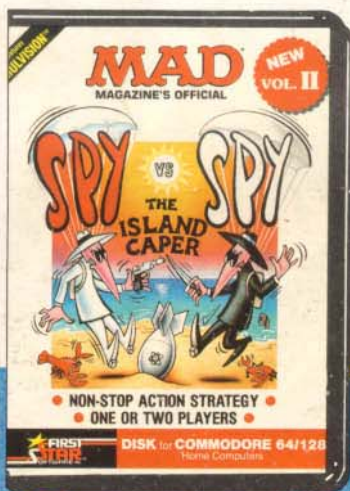
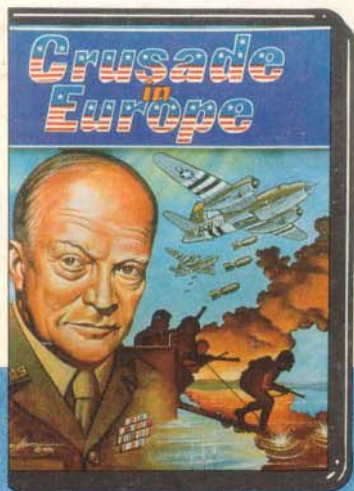

The Keyboard For The Keyboard

Well, it's not exactly 'clip on Chopin', but the Commodore 64 Music Maker certainly adds a new dimension to home computers. It's the 'keyboard' for the 'keyboard'. Just clip on and play. Music Maker comes with instructions and easy-step melody book to enable you to explore the wonderful world of music at your own pace and in your own time. In fact, it's so much fun that music

lessons may never be the same again. Music Maker encourages musical adventure and experiment, and that, in our opinion, is a good place to start experiencing the magic of making your own music.

Talk to your nearest Commodore dealer today about the simple, easy way to turn your Commodore 64 computer into a Music Maker.

 **commodore**
COMPUTER

Keeping up with you.

Contact your nearest Commodore dealer or Commodore Business Machines
Sydney:(02) 427 4888 Melbourne:(03) 429 9855 Brisbane:(07) 393 0300 Perth:(09) 389 1266

BMS/CC373

The Australian COMMODORE REVIEW

Vol 2 No 7 October



**The Australian
Commodore Review**
Top Rear, 4 Carrington Road,
Randwick, NSW 2031
Phone: (02) 398 5111

Published by:
Saturday Magazine Pty Ltd

Publisher: Gareth Powell

Editor: Andrew Farrell

Advertising Enquiries:
Ric Richardson
or Brenda Powell
Phone: (02) 398 5111
Top Rear, 4 Carrington Road,
Randwick, NSW 2031

Subscription Manager:
Tina Spathos
Phone: (02) 398 5111

Distribution:
NETWORK

Printed by:
Ian Liddell Commercial Printing

Contents

EDITOR'S PAGE

2 Editorial

NEWS

3 Ram Rumbblings
6 Hot Stuff

HARDWARE REVIEW

8 Voice Master
12 Epson GX-80
16 Fast Printer

GOOD ADVICE

9 Buying a second
hand computer
30 Do's and Don'ts



COMMUNICATIONS

14 Want a 'Nice
Modem?'

BOOK REVIEWS

18 Bookshelf

PROGRAMMING

27 CP/M and the
C128
40 Commodore 64
Printcodes

SPREADSHEETS

34 Profitable
Computing

READERS' QUERIES

46 Adventurers'
Corner
48 Letters

EDITORIAL

Editorial

Hello again, this month has seen me return to the Stone Age practice of actually programming the Commodore 64 to do something in preference to buying off the shelf software. At first I was afraid that all was forgotten, and I would never have that knack of writing a program, the dimensions of which were reasonably large in the time limit I was working to.

Well, as it turned out, I managed. Yes, that old skill of injecting numerous bugs (or features) into a program that grew so rapidly I have now forgotten how it works. I refer to our newly operational BBS, or ACRIBBS as it is better known.

If you haven't called it yet, please do so, as there is already plenty happening on the 11 (yes, more than any other BBS is Oz) message areas! You can also find

out about cheap holiday deals, and order some very inexpensive hardware. Just repeating that number to call - (02) 982-8252.

The Commodore 128 is still not yet here, and to add to the misery of that, latest news is that the 1571 will not be available for release with the unit when it does arrive. This could be a major drawback as the stand in disk drive is nothing more than an up-graded 1541. It will only use one side of a disk, so the capacity will be less.

It is also reasonable to assume that the unit will be nowhere near as fast as the 1571. Many potential owners have dubbed the psuedo drive the 785.5 Drive (Only half the real thing..)

Amiga fans are continually groaning in



Andrew Farrell

anticipation as more information comes to hand with regard to this brilliant machine's capabilities. Gareth Powell managed to confuse things a little with a brilliant article a few months back that, unfortunately, suffered from cutus maximus. Our layout artist managed to remove several vital lines from the bottom of each column.

Gareth has promised me (haven't you?) that an update on the Amiga will be published soon in a form that is both readable and in Gareth's usual style, entertaining.

DIRECT SUBSCRIPTION

The Australian COMMODORE REVIEW

*Make sure of getting
your copy - take out a
subscription now!*

Please enrol me for issues subscription to the Australian Commodore Review, commencing
with the issue. I enclose a cheque/money order for \$

OR my Bankcard number is

Name:

Address:

..... Postcode

(Please print in BLOCK letters)

Rates within Australia:

Subscription rate for 6 issues: \$18.00

Subscription rate for 12 issues: \$36.00

The Australian Commodore Review

Top Rear, 4 Carrington Road,

Randwick, NSW 2031

RAM RUMBLINGS

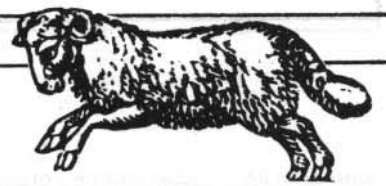

Now Mozart's keeping up with the Commodore

While "Amadeus" is packing them in at the cinema, other would be Mozarts are seated at their home computers playing his music. That's right, not pianos but computers.

In September, Commodore Business Machines released "Popular Classics", the first in the series of Music Maker Playalong Album Programs for the Commodore 64.

"Popular Classics" contain 12 computer recordings including such famous classics as

- * "Hungarian Dance No 5" - Brahms
- * "Sonata in C Major," - Mozart
- * "Concerts No 1 B Minor" - Tchaikovsky
- * "Emperor Waltz" - Strauss

The series with its multi level programming is designed for beginners and musicians alike.

Using the musical keyboard overlay the Commodore "pianist" can play any of these famous works.

In single-key mode, he can tap out the timing. Each note of the melody will play,

together with the accompaniment.

Prompting on screen and computer-controlled timing are added in Rehearsal Mode. With this tutoring budding Mozarts can quickly become proficient.

The chance to display talent comes with Performance Mode. A few beats to the built-in metronome and the Commodore musician plays the entire melody along to the accompaniment. He can speed up or slow the tempo according to his ability or preference.

By connecting the Commodore 64 to a Midi equipped keyboard further sophistication is possible.

"Playalong albums" have 3 musical parts to the melody which can be dired to different channels on the Midi. This allows the keyboard sound to be "split" into different "instruments".

If all this sounds too much like work, then our weary musician can relax, put his feet up, pour himself a drink and select Concert Mode. Now he can listen to his favourite classics while watching exciting screen graphics.

Selections can be played in any order or repeated if desired.

To enjoy "Popular Classics" stereo or quadrophonic Commodore 64 music

lovers only have to plug their computer into the home Hi Fi to fully appreciate these musical arrangements.

And for those who like their music a little more contemporary Commodore will simultaneously release "Pop Hits" and "The Beatles."

Each Commodore Music Maker Playalong Album comes complete with User Guide, Music Book and both Cassette and Disk. Music Maker play along albums are available from Commodore dealers at a cost of \$25.00 each.

"Maestro!"



Now it's computers by video

Commodore has brought new dimension to computers by establishing an information packed video aimed at the amateur and those who have developed an emotional barrier against computers. It means you can learn about your new computer in the comfort of your own home.

Called "Understanding your Commodore 64" the videotape features computer boffin, Mick Collin who takes first time computer users on a quick tour of the Commodore. Everything is explained in simple terms.

He introduces the central processing unit, the memory, the colour video



RAM RUMBLINGS

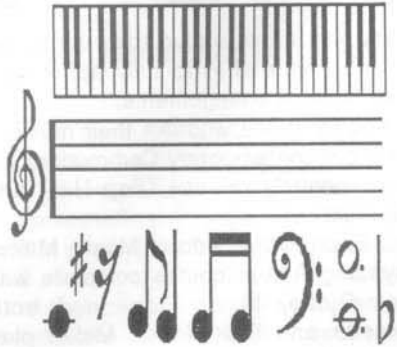

display, the octave three voice music synthesizer and the built-in BASIC language of the computer. Such technical references usually leave the layman confused, but not the way Mick Collin explains them.

He explains the functions of the monitor, the external memory device and the printer and discusses the best equipment for the job.

The video also helps the new owner of a Commodore 64 to become comfortable with computer fundamentals such as menus, cursors, and function keys.

Even if you can't type, Mick recommends a program which will do the trick. And to make the learning operation more interesting, he points out that a person can invest in a word invader game.

Once all the basics have been dealt with, the flexibility and versatility of the

"Even those who already operate a Commodore 64 could benefit"

Commodore 64 is introduced.

Even those who already operate a Commodore 64 could benefit, as the video is the beginning of a true learning centre.

The range of uses the Commodore 64 can be put to, transforms the exercise

into an entertaining, exciting yet challenging experience.

After watching the video for a short period of time you become familiar with the idea of developing your own programs. Of course these directions are in their simplest form, but provide a challenge and a sense of accomplishment for the beginner.

The videotape includes explanations of most applications the Commodore 64 can be used for, such as:

- * a word processor.
- * receptacle of information by connecting it to a telephone system to collect information from other computers.
- * an educational tool.
- * a personal or home management support.
- * an aid in a small business operation.
- * a control for a security system, to name a few.

Mick Collin also discusses two programs that are unique to Commodore 64.

By incorporating programs such as Music Composer or Music Machine, Mick

"By using a koala pad or a light pen, you are taught how to create and colour graphics by computer"

explains how the Commodore can be turned into a music generator.

The other program is devoted to designing graphics. By using a Koala Pad or a light pen, you are taught how to create and colour graphics by computer.

Both programs have been based on exciting learning concepts and ensure the operator will have lots of creative fun while learning a number of valuable skills.

Once the useful hints and tips offered through "Understanding your Commodore 64" have been adopted you will only be hindered by the extent of your imagination and resourcefulness.

The videotape is available from Commodore dealers.

Managing your finances on C64

Now you can manage your finances on a Commodore 64.

A new program from Commodore allows investors, home owners and businessmen to calculate interest payments, dividend payments and profit margins on investments.

The *Financial Advisor* helps you make complex financial calculations in a matter of seconds, covering areas such as loans and investments.

The program, which is loaded into the computer from a cartridge, allows

"Helps you make complex financial calculations in a matter of seconds"

calculation of costs and benefits of five common financial arrangements - periodic deposit accounts, periodic

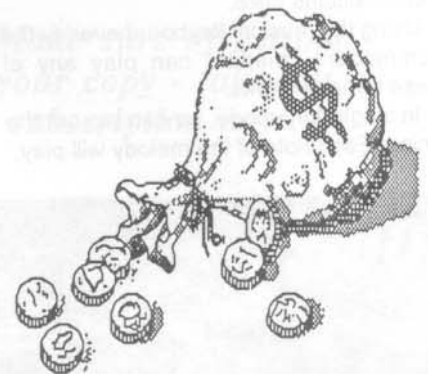

withdrawals, instalment loans, stocks and bonds.

It has been designed to be easy enough for a child to use with a menu format that simply requires input of values.

Financial Advisor also has a calculator mode which allows users to make any calculations they require and then

RAM RUMBLINGS

transfer the results into the calculating program they require.

Instalment loans can be calculated to provide information on payment amounts, future balance, initial deposit level, number of years over which the loan will be repaid or the annual interest rate.

Four menus are available within the program - allow Financial Strategy to be planned, to undertake a Current Strategy (without affecting the financial strategy being used), to choose one of nine Compounding Periods, or to undertake Transaction Period calculations.

Each menu can be accessed by typing a simple command into the computer.

Values and answers developed in the Financial Advisor can be transferred between the screen display and a bank of 100 memory registers.

The values can be stored and then re-loaded from memory storage in the computer.

The Periodic Deposit calculation is based on a type of interest bearing account into which regular deposits will be made.

You can then calculate the Future balance (what the balance will be the end of a specified time), Initial Deposit (what deposit you must make to achieve a specified future balance), Periodic Deposit (how much your periodic deposit must be to achieve a specified future balance), Number of Years (how long you must continue to make deposits to reach the specified balance), and Annual

Interest (what the annual interest rate will be to allow you to reach your goal).

Periodic withdrawals can also be calculated in *The Financial Advisor* - a valuable tool for calculating items such as retirement fund payments or even regular withdrawals from cheque accounts etc.

Instalment loans can also be calculated on *The Financial Advisor*, complete with a calculation of the amount of interest you pay over the term of the loan.

The Stocks segment of the program helps you keep track of the value of your stock, including indications of present value, the amount of dividend, dividend growth, and annual interest.

Using the Bonds section of the program will allow you to answer questions about your bond Investments, including calculation of maturity value and the present value of the bond as well as indicating the coupon payments to be made periodically, how many years until the bond matures, and the annual interest rate to be expected in earning from the bond.

Priced at \$36, *The Financial Advisor* is ideal for financial advisors, businessmen, household budgeters and to secondary school teachers helping their students understand commercial transactions in investment areas.

The Financial Advisor is available through Commodore dealers and is produced by Commodore Business Machines.

From Nags to Riches!?

Winning at the Races Using Your Computer is an all Australian book on racing systems designed specifically for Australian racing conditions.

It is not a book about computers but it does provide insight into how computerised number crunching can discover patterns to turn the odd losing tippie into an educational winning scheme.

Autor, Paul Worden bought all the racing systems available, assessed their potential and then developed his own system based upon the system that

he found to be most reliable. All programs are written in Microsoft basic and graphics and syntax have been avoided. The programs have been run and tested and even if you have never owned a computer, you will find it totally understandable.

You will be able to analyse odds structures, write systemettes, learn to make profit out of betting on several horses, write complex evaluation programs and much more. The book contains completed programs on speed rating, multiple betting, equine evaluation and betting simulation as well as short

"Even if you have never owned a computer, you will find it totally understandable"

utility programs. Each chapter deals with a different aspect of horse racing as it is applied to personal computers.

The only way to beat the bookmaker is to have better information and process it faster, hence the utilisation of a computer. Worden explains the rules of the systems and application of information and appropriate systems.

While Worden states that it is not foolproof, with an 80% success rate in the past 18 months, it certainly provides an edge on most betting systems used to select the winning combination.

Winning at the Races With Your Computer is not written just for computer owners or horse race enthusiasts, it is written for anyone who is interested in game simulation where an outcome is governed by a large number of factors.

PAUL WORDEN

Paul Worden was born in Plymouth, England in 1943 and moved to Australia in 1959. After a varied career as a meat inspector, technician and more recently, a photographer, Worden is now self employed writing computer programs and a few magazine articles.

He is married and lives in Portland, Victoria and his main ambition is to be self sufficient from his computer racing analysis!



HOT STUFF

This month has been one almighty rush, however there have been a few interesting game releases which we recieved moments before going to press. Although we had little time to give them a thorough going over, a few of our avid game players had these comments to make.

SPY VS SPY II

Mad magazine's official entry into the software market some time ago saw a great success at hand, and now they have taken the *Spy Vs Spy* theme even further with the sequel - "*The Island Caper*". Improvements include far more complex scenery and rather than rooms the scenario is spread across an open area which scrolls by as the players move about.

The same split screen method of dual play is employed, an idea that has been a great success for both *Epyx* and *First Star Software* in several recent games. Play begins when both players parachute onto a tropical island in search for the buried remains of a missile. During this desperate race, each *Spy* may also construct booby traps in order to slow his opponents progress down.

To help in your quest, at great expense to your country, you are equipped with a super duper Island Trapulator. It is able to do all sorts of nasty things as well as help you find your way about the place. Unfortunately your opponent is equally

well equipped so caution must be taken when moving about this island.

At the game start you may select one or two players, the difficulty level, intelligence quotient of the computer (one player mode only), and the escape sub location (revealed or hidden until the end).

The trapulator is used with the joystick as is movement throughout the game. Items of interest include coconut bomb, gun, rope snares, napalm and island map. Various natural nasties must also be avoided including volcanoes (I forgot to tell you there's an active one on this island!), quicksand and shark attacks.

During confrontations with both *Spy's* the game changes to a hand-to-hand combat mode, where words are used to battle out supremacy. This involves a fair degree of violence such as smashing your opponent in a friendly manner about the head, face and torso. As this is a family magazine, we won't go into the obvious effects of such action.

Spy Vs Spy II has excellent graphics and sound, and not unlike the original version, is a lot of fun to play. We could recommend it to any avid game player, and it is especially fun with two players.

Commodore 64

Game: *Spy Vs Spy II*
 Publisher: *First Star*
 Distribution: *OziSoft*
 Price Cassette: \$29.95

Graphics :96
 Sound :95
 Playability :90
 Lasting Interest :99
 Value for money :90
 Overall :92

Reviewed by Andrew Farrell

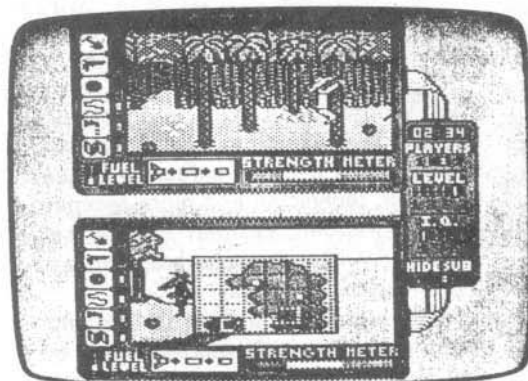

Kennedy Approach

Here's an air traffic control simulation that will really keep you busy. *Kennedy Approach* features high quality speech synthesis, and excellent three dimensional graphics. You control the approaching air traffic during various weather conditions and even the odd flight emergency.

Other variables must also be considered as you direct the various aircrafts safely in and out of the airport. The 21 page manual explains the program operation in great detail. The access code for each aircraft, including the Concorde, Boeing 707, 737 and Cessna Skymaster are all there in the action.

Each of these fit into one of three categories of planes that you will encounter - light planes, jet airliners, and supersonic. (I'm sure you can guess which one goes where!) The screen display consists of a top on view of the control area. Various pieces of information about incoming traffic is displayed at the top of the screen.

Landscape features and moving traffic is indicated by small icons moving (or not moving) across the screen. Terrain features are mountains, storms and restricted zones - all of

which must be considered throughout play. Flight plans are provided for each flight, and there is also the pressure which mounts as the time clock at the upper left corner ticks by.

Good graphics, fantastic sound and by far one of the better simulations around. Full review next month.

Mig Alley Ace

Yet another in the flight simulation gender, *Mig Alley Ace* is a full on dogfight type game. The action includes Head to Head confrontations with the now famous split screen method of having two players in action at the same time. Each player



flies his own jet fighter equipped with various cockpit instrumentation to help pin the enemy down.

There's a speedometer, engine power, radar display and altimeter. The airspeed indicator is essential if you plan on keeping up with your opositions manouvres, so keep an eye on it during play.

Using a joystick to fly your planes, you may do all sorts of tricky things to outrun the enemy. These included loops, turns, High-G turns, and even Hi-Yo-Yo's (what ever they are!) You may climb, dive back left and right and fire your weaponry from the joystick.

The keyboard is used to alter power settings, and trigger a bail out. The horizon is the only visible landscape, apart from all those nasty enemy planes. Overall, it looks like a bit of fun.

Voice Master

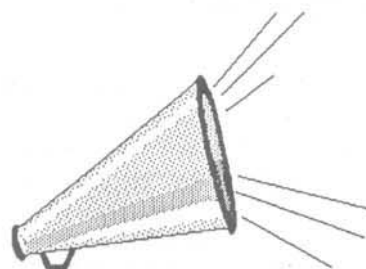

Now They're Even Talking To Us

A STEP beyond voice or speech synthesis is now available in a device called Voice Master.

Released by a company called Covox, the unit is described as the ultimate human-to computer interface.

Voice Master is a voice recognition/speech, reproduction/voice harp.

Through it, users can reproduce their voice on the computer, using a process called 'digitisation', where the user speaks to the computer using the module provided.

The speech is then encoded.

The computer can play it back when requested, in a BASIC or machine language program for example. Even on a small computer, a good copy of the user's voice can be re-created.

Novelty

This feature certainly adds a great deal of novelty to games or business software written at home.

It is possible to 'train' the computer to recognise voice commands.

The user speaks a word once or twice and Voice Master

"Certainly a fast way to learn foreign languages."

averages out the sounds using a system called by the manufacturers, Dynamic Time Warping.

When the user is giving commands it compares this record with what is being spoken to see if there is any similarity.

In a educational application, for example, a student would hear the computer say a word in an accent which is not the robotic voice generated by American or Japanese speech synthesisers. The student could then be asked to type in the correct spelling or translation for the computer to check the answer - certainly a fast way to learn foreign languages.

Voice Master is provided with a synthesiser module, headset with microphone, and earphone and software on disk.

The module performs the digitisation of the voice and then sends it to the software in memory, or transferred as a file to disk.

Voice Master makes it easy to use speech in commercial programs, as the module is not needed for voice reproduction,

nor are there any lengthy programs.

The recognition capabilities are also excellent for any use the user can think of, although the module is needed for this application.

Read Out

There is also a data checking program which reads out the data statements in the program, while the programmer is checking them off the printer listing - a sort of 'right-hand-man' to help the debugging of the program.

Voice Master costs \$149.95, and is a comparatively inexpensive way to get voice reproduction and recognition on the Commodore 64.

The demonstration unit was supplied by VicWest, phone (02) 445 2152.

COMMODORE 64 OWNERS

FREE! Software Catalogue

The Strategic Software Club posts catalogues listing the latest Commodore 64 software at discount prices, free to members six times per year.

To join (no charge) ring (02) 957 6667 or simply fill in the attached form and send to Freepost 67, P.O. Box 742, North Sydney, N.S.W. 2060. (No stamp required.)

Strategic

Software Club

169-185 Miller Street, North Sydney



NAME.....

ADDRESS.....

.....TEL.....

Genuine one owner, with log books - going cheap!

Australia's computer market is awash with orphaned machines looking for new owners. Although purchasing one of these pre-loved units may have its pitfalls, considerable savings can be made. Andrew Farrell investigates further to discover what you should know before buying.

Second hand car yards have a distinct reputation which, thankfully, has no parallel when it comes to purchasing a second hand computer. Although the cost of entering into the world of computers has dropped dramatically over recent months, both home hobbyists and business people are discovering that a second hand machine may not be such a bad thing. The local market is only just starting to heat up, however overseas,

"The machine should be available for testing and closer examination"

specialist shops selling used computers have long been very popular.

Even sceptics will agree that buying from a reputable dealer does have its advantages. He will normally be able to provide you with a warranty if need be. The machine should be available for testing and closer examination, which is important if you don't plan on getting caught with a lemon.

Prices vary greatly with the units condition and extras that are included. Most second hand buys are only

"Hardware usually decreases in value fairly rapidly"

available as complete systems, including disk drives and a monitor. Normally this will also include software bundled in to clinch the deal.

Some discretion is needed in this area, as legally only original copies of

programs may be sold. The previous owner should also have destroyed any archive copies that were made. Software prices vary greatly, depending on the quality and or existence of documentation.

Hardware usually decreases in value fairly rapidly, however some brands maintain their worth for longer periods of time. This will vary with the machines reputation in general, the existence of clones or imitation units, and service and

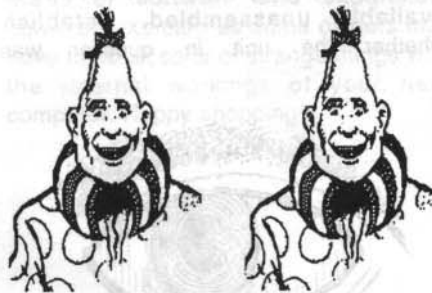

support available. Computers that are no longer produced or have been replaced by an upgraded model are most prone to devaluation.

The classifieds of computer magazines and newspapers are a good place to start looking, however all too often going rates tend to be inflated by sharp falls in the current retail price. Recent buyers do not quickly realise the falling worth of their equipment, and as a result tend to ask exorbitant amounts. Including the supposed value of software owned may

not necessarily reflect a good buy, as old games tend to hold little or no value.

Likewise, business software that will be of no use to you is pointless owning. Be aware of what you really can use and need. Most of all, close inspection of the prospective devices is a must.

Things to watch for when buying are numerous. A few simple tests can reveal if any major problems exist, however

"Be aware of what you really can use and need."

smaller hassles often surface once the machine has been purchased. Disk drives become noisy and unreliable as they near the end of their working life.

Be sure to load up a few programs to ensure all is well. If the drive has problems reading some disks, the head may be out of alignment, which may be an expensive adjustment to have made. A unit that has been recently serviced should be running perfectly. Most computers which have a drive test program will confirm the devices condition.

Keyboards are also prone to heavy wear and tear. Check each key as a rule, noting any which may appear difficult to obtain a response from. Typical characters to receive extra wear are the letters E, T, A and S. Faults may be



caused by particles becoming lodged beneath the key caps, or more likely by worn rubbers and springs. A well used keyboard is a sure indication that the computer has been through hard times. Some owners don't take care in keeping

GOOD ADVICE

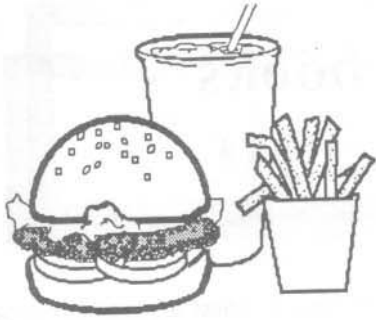

smoke, food and liquids away from the computer. A quick glance between the keys will tell where the unit in question has spent most of its service years.

Often taking a friend along for a second opinion can be a great help - preferably someone with a good knowledge of micros. Always be sure you are given the necessary leads, power supplies, manuals and a receipt stating the amount paid and warranty period - if any.

Second hand stores may be a good source of spare parts. If you are electronically minded, old VDUs may be an inexpensive answer to your monitor needs, however be sure to see the unit

"Always be sure you are given the necessary leads, power supplies, manuals and a receipt"

working before making a decision. Monitors have a nasty habit of deteriorating rapidly in quality once they near retiring age. Common problems are: high voltage drop outs, causing the screen to occasionally shrink; voltage variations, causing strange distortion and headaches if used for long periods of time; and deterioration in the sound amplifier where fitted.

Printers are also available in plenty on the second hand market. Ranging from humble printer/plotters to 500cps main frame monsters. Ensure the unit has all the right interfaces included, as there are some variations around. Do a print test and watch for any dots missing on certain letters. This may be an indication that the print head is damaged or worn - an expensive item to replace.

Stepper motors also wear out, causing sluggish line feeds, erratic spacing and

overprinting. Try outputting about 40 lines of text for a simple test of any of the above problems. Loose components, broken paper releases or tractor feed sprockets can be a big hassle later on.

Modifications

Sometimes the previous owner may have carried out small modifications to the units standard design. This may be in the form of a memory upgrade, additional ROMs or an internal interface of some description. For this reason, if you are aware that it is possible to expand the systems capabilities, establish exactly what is hidden beneath the casing, if possible by looking.

Bodge soldering, loose wires and badly planned additions are worth watching out for. Even a simple change may be turned into a maze of messy cables and connections with dry or cracked solder joints if it was carried out by an inexperienced person.

Kit computers are also worthy of a close examination under the bonnet. Although not as popular as they were some 12 months ago, many computers have been available unassembled. Establish whether the unit in question was

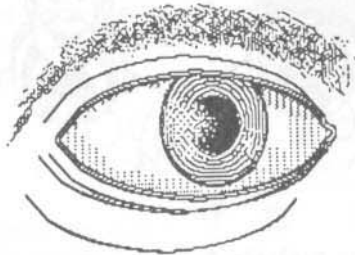

assembled by the user, and if so, the quality of the job carried out. It doesn't take an electronics engineer to spot a blatant lack of dexterity on the previous owners part.

Occasionally massive changes to the computers design increase the likelihood of failure at a later date. All this should be kept in mind when assessing the units true value. Never accept the advertised price as most owners and dealers ask

more than what they expect to get to allow for bargain hunters.

I contacted a few dealers to discover the extent to which second hand stores are operating in Australia. It appears that they are few and far between, although many dealers do have second hand units from time to time.

One shop that is doing big business in used computers are the Computer Exchange, in Chippendale, Sydney. Kass Mahdovi, store manager, believes

"There is plenty happening on the second hand scene"

that there is plenty happening on the second hand scene.

He deals in everything from \$200 micros to \$10,000 mainframes. With experience like that, the Computer Exchange seemed like a good place to start. They have a full showroom set up, where potential buyers may view the offerings and test or examine the machines on display.

The Exchange doesn't handle many of the smaller computers that have seen better days, such as the Sinclair, TI, Atari and Vic 20. However, the Commodore 64 is a popular unit, and represents the lower threshold of their range.

Smaller computers don't really have much appeal, and hold little value. A Sinclair ZX-81, Vic 20 or Atari 400 would be lucky to fetch \$50 to \$100. This is little wonder considering a brand new Vic 20 is just \$69, whilst the Atari, Sinclair and TI range have long been discontinued.

Occasionally these and other units do appear in the store, however these are

"Smaller computers don't really have much appeal, and hold little value. "

mainly on consignment from private owners who display their computer in a special area. For a commission of 15% the Computer Exchange are happy to display whatever you have to sell.

A Commodore 64 will fetch from \$120 to \$250, extras such as a disk drive,

GOOD ADVICE

cassette player, software and special interfaces will add to that figure. An Apple II/E with disk drives and screen may fetch \$1500, however a brand new look-a-like also available from the Exchange costs just \$1700.

IBM PC's, and the many compatible units, sell for around \$2500-\$3000. An imported look-a-like, brand new, will cost you \$2200 with a six month warranty. Other machines in the store include Archive, Digital Rainbow, DEC, National and Rank.

You may also purchase disk drives and printers ranging from the smallest to the largest. A Corvus 10 megabyte hard disk sells for \$800-\$900 - and a five megabyte version for \$500-\$600. Single floppy drives are available for as low as \$150 brand new. Occasionally people import a peripheral before they realise that it won't

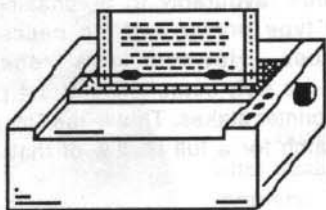

work on their machine. Thus many items are sold in original condition.

Of course, the onus is on you to make it work with your computer, so take care. Unless you know exactly what you're after and what you're getting, you have little chance of connecting alien peripherals successfully.

The printer range starts from as low as \$90 for a Brother HR-5, up to \$5000 for a large line printer. MX-80 type clones sell for \$300-\$400 brand new. With all hardware, a warranty is sometimes included, but normally available as an optional extra.

Warranty periods start at seven days and extend to one year. \$50 will buy you a six month service contract on an Apple II/E - with amounts varying from unit to unit, depending on their condition and included extras. Heavy duty expansion

cards and the like tend to add a lot of overhead to warranty costs.

Pittwater Distributors, at Dee Why in Sydney had a few second hand Commodore Business Systems on hand when I contacted them. At the moment an 8032, with hard disk and 8250 dual disk drive, printer and no software will fetch upwards of \$6000. They expect to sell much more second hand gear toward the end of this year with the release of new machines from several suppliers.

Indeed, this will probably cause a sharp rise in the number of owners attempting to upgrade to the bigger better models. At the same time, the value of second hand machines will be forced down by the sudden influx in units available. If this is coupled with a price drop in the retail value of current models, then we could see some very inexpensive buys surfacing toward Christmas.

With a little care and thought, buying a second hand computer can be a great way to get into micros on the cheap. As long as you know what to look for, chances are that a tried and tested machine will work better anyway. Additional savings can be made in the areas of software and expansion, however take care as some owners may have done all sorts of strange things with the internal workings of your next computer. Happy shopping!



YOU BEAUTY



C128
COMMODORE'S LATEST IS
HERE. RUNS C64 SOFTWARE,
C128 SOFTWARE, CP/M

TRADE - UP ON OUR
SPECIAL INTRODUCTORY
OFFER

\$499

PLUS YOUR OLD C64
AS TRADE - IN
R.R.P. \$699

the
Computer Spot

MLC CENTRE SYDNEY
21a GREENWAY ARCADE
TEL 235 2455

PARRAMATTA
TEL 635 6020

SOFTWARE
LATEST ARRIVALS

ISLAND CAPER (SPY VS. SPY II)
KENNEDY APPROACH
SUPERMAN - THE GAME
HARD BALL (BASEBALL)
THE GOONIES

QUALITY PRODUCTS
AT LOWEST PRICES TOO!

Epson GX-80

'Perhaps the 1526 wasn't what everyone was after.. could the Epson GX-80 be the answer? Andrew Farrell examines further.'

A printer is an invaluable addition to your computer system. It makes way for many practical uses that would otherwise not be possible. The recently released Epson GX-80 has all the features you would ever expect to find on a printer in the under \$500 price bracket.

However, it also out-performs some more expensive units by leaps and bounds. Housed in an attractive beige

"all the features you would ever expect to find on a printer in the under \$500 price bracket."

case, the GX-80 is a smart looking device, and maintains a sleek low profile image - even with the optional tractor feed fitted.

Unlike many other printers on the market today it requires nothing in the way of expensive interfaces, which are prone to incompatibility with some software. Instead the GX-80 uses what is known as a personality module. This allows it to be used with other computers apart from the

"it also out-performs some more expensive units by leaps and bounds."

Commodore range by replacing the cable between the computer and printer.

For use with a Commodore system, the printer connects directly to the serial port without any further complications.

At power on, the GX-80 will act just like a true Commodore printer, with the added extra of being noticeably faster. However

it supports several print modes that are truly unique.

In what is known as 'Near Letter Quality' mode, the print quality is excellent, virtually comparable with a standard daisy wheel. There is a near draft mode, for printing ordinary work, emphasized and double strike, condensed and high-resolution graphics modes.

These may be selected using the dip switches or alternatively by a simple procedure of pushing a combination of the 'On-Line', 'FF' and 'LF' buttons, mounted at the top front of the unit.

Various modes may be combined to produce emphasised near letter quality,

and other combinations, examples of which you will find nearby.

The dip switches also allow the device number to be set, paper out, form length and tractor feed options to be selected.

In action the GX-80 prints bi-directionally, although the actual speed at which this takes place could not be found in the manual. The ribbon sits firmly in place and we had no problems with it becoming snagged or caught during removal and installation.

One nasty problem is that the disk drive appears to hang when the printer is connected but not on-line, making drive access rather difficult. This problem exists with several other printers and printer interfaces, but it is apparently a software problem. Perhaps Epson get their printer ROMS from the same place that Commodore do?

Overall the Epson appears to be a very good alternative to your standard Commodore steam train. It also compares favourably to purchasing an MX-80 type printer and the necessary interfaces. However, we recently received a new contender for first prize on the printer stakes. That is the Riteman C+. Watch for a full review of that next month.

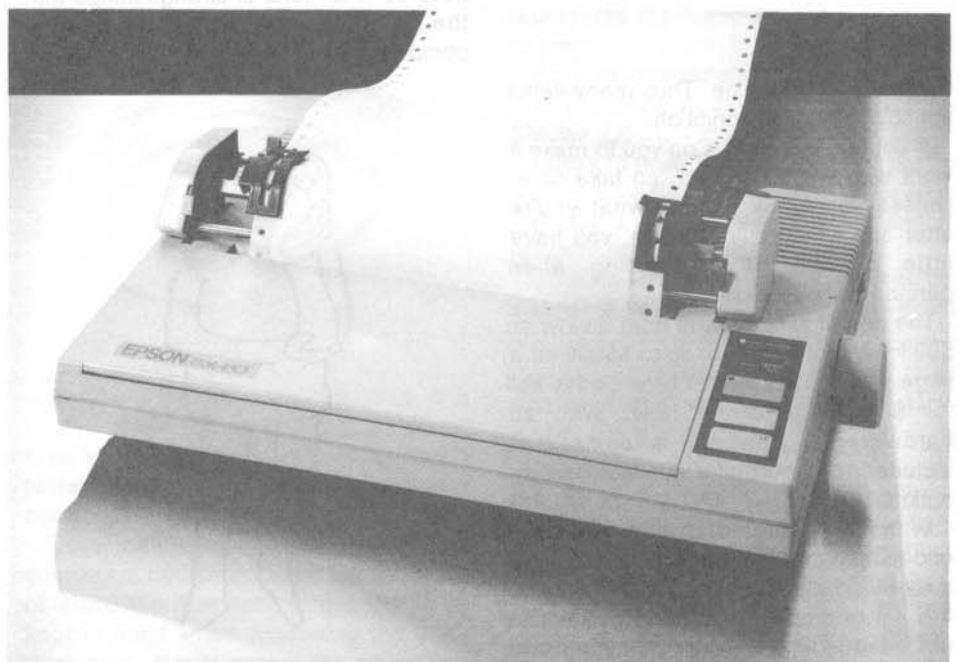

Businessmen & Hackers finally see eye to eye on printers.

Businesspeople will welcome it as a new price break-through in near letter-quality printers. Hackers will welcome it as a whole new standard in low-cost printers.

On appearances, you'd never suspect it was a low-cost printer. And when you see its superb, near letter-quality printing, you'll find it hard to believe that the recommended retail price (excluding sales tax) is under \$440!

The Epson® "NLQ Special" gives you so much more than you've learned to expect from a printer in this price range.

It offers superb, near letter-quality printing in a variety of type styles and sizes.

It prints up to 100 characters per second, and includes a 1024 byte input buffer which reduces the time your computer is tied up during printing.

It produces charts and graphics with a crispness and definition that's seldom been seen on a printer in this price range.

It comes with standard friction feed, optional tractor & cut sheet feeders, and uses standard interfaces.

In its GX-80 configuration, it emulates Commodore, Apple and IBM printers and operates directly with these computers without modification.

In LX-80 configuration, it offers a variety of built-in word processing functions – so you can produce professional-looking documents even without word processing software – and is compatible with almost all other computers.

There is so much more to the Epson GX-80 and LX-80 that you won't find on other low-cost printers.

Call in to your nearest Epson dealer and see what's so special about the "NLQ Special."

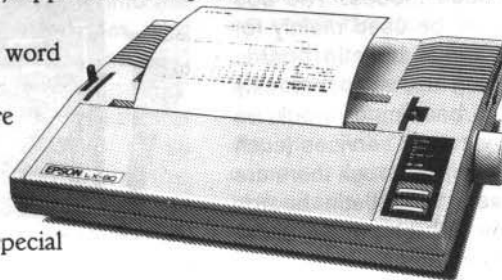

The "NLQ SPECIAL" by **EPSON**
AUSTRALIA

Epson Australia Pty Ltd, 3/17 Rodborough Road, Frenchs Forest. Sydney (02) 452 5222. Melbourne (03) 543 6455. Brisbane (07) 832 5400.

*Registered Trademark of Epson Corporation. EPS0051/R

Want a "Nice Modem?"

Riding on the sudden wave of popularity in both bulletin boards and videotex services which are starting to become available in this country, electronics companies are releasing modems as quickly as they can get them to market.

A new Western Australian company with the strange and friendly name of 'The Nice Computer Company of Australia' has made an apparently successful attempt to enter this highly competitive market by releasing (yet another) modem based on the AMD7910 'World Chip' modem I.C.

The modem called 'The First Nice Modem' boasts as it's features the following baud rates:

- Bell 300 baud answer/originate
- Bell 1200/5, 5/1200 baud (with/without equalization)
- CCITT 300 baud answer/originate
- CCITT 1200/75, 75,1200 baud (with/without equalization)
- CCITT 600/75 and 75/600 baud

The Bell modes are those used mainly in the United States; so if you are feeling rich you can phone America and talk to the hundreds of bulletin boards which have appeared there over the last few years. The CCITT modes are those which are used by most other countries in the world, including Australia.

The modes which are of concern to most of us in this country are the CCITT 300 and 1200 baud modes. The 300 baud modes would be used mainly for talking to the various bulletin boards which are cropping up, almost weekly now. The 1200/75 baud mode would be used mainly for videotex services (such as Telecom's ViaTel), although there are some databases and bulletin boards appearing now which are taking advantage of this mode.

Something to watch when buying a modem is that it has both the 300 baud originate and answer modes (some of them only have the originate mode), otherwise if you want to talk to a friend (or transfer a program) via the modem, you won't be able to, because one of the modems must be in answer mode.

A useful facility which has been included is the reverse Videotex (75/1200 baud) mode. This means that you can talk to someone who only has a 1200/75 baud modem.

There are two versions of 'The First Nice Modem' available, one plugs directly into the back of a Commodore 64 (or SX64), and the other which has an RS232 connector on the back so it can be connected into any computer including the IBM PC, Apple, Osborne, Kaypro etc.

The modem itself comes well presented and laid out, in a light grey case with two

toggle switches, 5 indicator leds and a rotary mode selection switch. It also has it's own telephone, and power supply. This last feature will be of particular interest to SX64 and C64 owners, because some of the modems available which draw power from the user port can damage the computer's power supply.

The modem is compact - 200mm x 160mm x 70mm - unobtrusive and very easy to install and use.

A pleasant surprise is the clearly written and informative manual, which not only tells you about the modem, but also tries to tell you about data communications in general. A list of some of the bulletin boards available in Australia is also included in the manual - a 'nice' touch.

The clear, easy to read front panel has indicator leds for all of the signals you

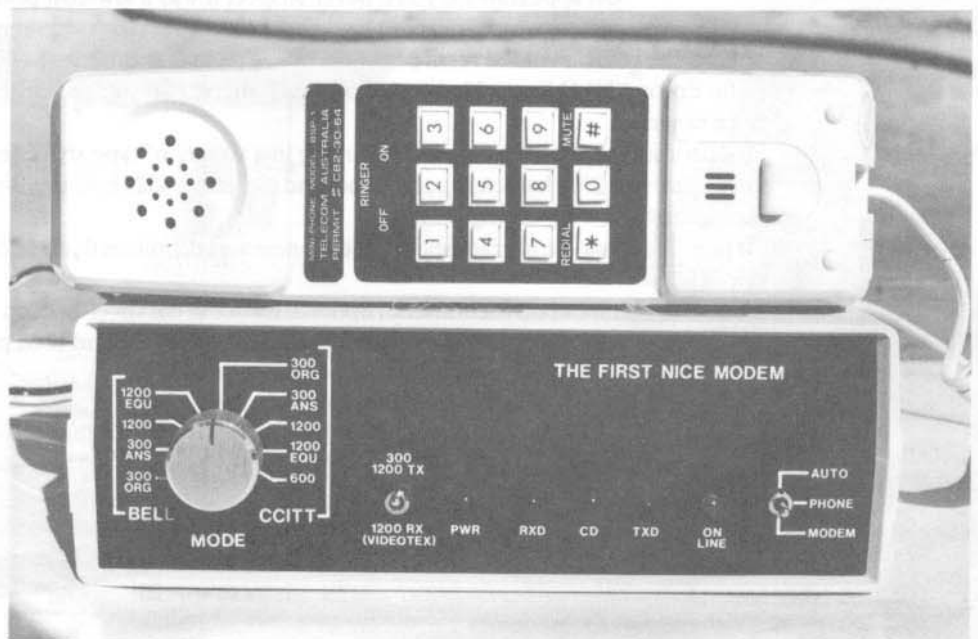

need to see, i.e Power, Received Data, Carrier Detect, Transmitted Data, and whether the modem is on or off line. In fact it looks very impressive when you are using it having the leds on the front panel flashing in synchronous to the incoming or outgoing data.

All of the baud rate changes are taken care of by a single rotary switch, and a toggle switch.

The modem has been designed in a uniquely different way to most of the other modems available. The difference is that where most (I don't know of any

"All of the baud rate changes are taken care of by a single rotary switch, and a toggle switch."

other modem that does use this method) modems make use of the RS232 'back channel' (the 75 baud 'back channel' is transmitted or received on pins 16 and 14 instead of pins 3 and 2) which means that you need to use differently wired (and therefore different) cables for the 300 baud, videotex, and reverse videotex modes.

The First Nice Modem enables you to use the one cable for all these modes. Since you cannot transmit on the main channel (pin 3) when transmitting on the back channel the simple solution is to transmit on pin 3, instead of pin 16 (enabling you to use the same cable) and put a switch on the front panel to switch

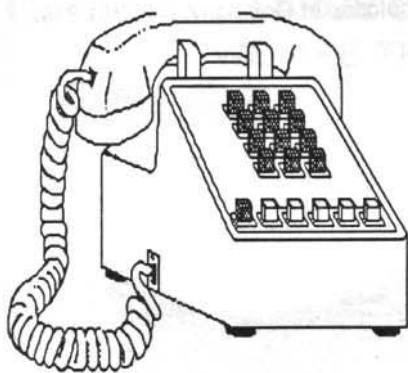

the RS232 connector into the 'correct modes' (similarly for receiving).

The modem is fully Telecom approved and plugs into any standard Telecom telephone wall socket. A useful feature is the telephone mounting bracket which comes with the phone, and enables you to mount the phone on a wall near the computer. The phone can also be used as a normal telephone when the modem is not in use.

The Commodore 64 version of The First Nice Modem includes free terminal, file transfer, and videotex software. The software is of a high standard and quality.

The file transfer software uses the almost standard Ward Christensen protocol, and not only includes 300 baud file transfer, but by making use of the videotex and reverse videotex modes

"The software is of a high standard and quality."

you can also transfer files at 600 and 1200 baud, so you get all the advantages of a 1200 baud modem without having to spend at least three times the money of this modem to buy a 1200 baud full duplex modem.

The modem also has the capability to autoanswer (under software control), so if you want to start your own bulletin board you can.

Two options which I believe are

"The modem also has the capability to autoanswer"

planned, but not yet available are modules both of which will plug into the RS232 connector of the modem (and draw power from the modem, so you won't need any more power points), one which will enable the modem to autoanswer without software control (for those computers which do not have the necessary control lines). The other option is a baud rate converter, so that computers and terminals that do not have split baud rate capabilities will still be able

to take advantage of the 1200/75 baud modes (to use videotex services or transfer files at 1200 baud, for example).

The modem comes complete with a full 12 month warranty, and is very good value for money. The recommended retail prices (including sales tax) are: \$299 for the Commodore 64 version and \$279 for the RS232 version.

The unit would look equally at home (and be equally useful) in a personal computer and business environment, and with the sudden popularity of modems would make a great Christmas gift for a personal computer enthusiast.

Anyone interested in getting more information about the modem, or wanting to order one can do so by contacting The Nice Computer Company of Australia, GPO Box S1517 Perth 6001. * The company is also looking for distributors of this modem throughout Australia.

Glossary

Modems: abbreviation for modulator/demodulator, which involves converting the digital signals from the computer into sound signals for transmission across a standard telephone line, varying two tones in sympathy with the signal sent, called modulation.

Demodulation is the reverse - taking the tone, and from the variation, recreating the original digital signal.

Baud Rate: a measure of the number of bits of information transferrable in one second. Therefore, 1200/75 baud means 1200 bits are transferred in the forward direction every second, while only 75 are received in the backward direction.

Duplex: a term used to determine the method in which data is passed down the telephone line such as half or full duplex. Full duplex indicates each computer can transmit and receive files at the same time. Half duplex means one computer can either transmit to, or receive from, the other computer, but not at the same time.

Fast Printer With Quality At Low Price

by J. McLean

This Modern Little Wonder Doesn't Cost The Earth

The addition of high-speed, quality printer adds a lot of flexibility to computers, allowing printouts of program listings, letters, invoices and all sorts of other information.

The normal price range is usually well out of the reach of home computer owners.

Even the cheaper dot-matrix printers start around \$350 and end up in the low thousands.

About to fill a gap in this market is a new release from Silver Reed.

The Silver Reed Color Pengraph EB50 is a lightweight typewriter/printer the size

of a briefcase. It operates on batteries or mains and cost only \$368.

A 16-character liquid crystal display (LCD) offers easy visual control, and it is possible to correct mistakes on the line in memory. An optional black corrector set is also available.

There are three print sizes and a choice of Courier and Italic text fonts. Multicoloured concentric, pie or line graphs can be printed in any combination of four colours.

The typewriter uses four ballpoint pens to produce letter quality type in black red, green or blue, with up to 160 characters a line possible on 220mm wide paper.

Text may be entered horizontally or vertically.

Of course, the use of pens and not printer ribbon means carbon copies are not possible.

Extra Copies

However, when the typewriter is used as a printer connected to a computer extra copies are easy to get.

The unit is particularly good at producing graphs because of the way the coloured points are moved.

Because both horizontal and vertical movement is permitted, the unit can

"Text may be entered horizontally or vertically."

create graphics by down-loading the information from a computer. Combined with colour, this can produce interesting pictures or text.

The EB50 doubles as a printer when required.

Software to drive the EB50 may be necessary for some computers, such as the Commodore 64.

The print mode is capable of only 14 characters a second, but the speed compares favorably to the lower-priced daisy-wheel printers.

The unit is capable of handling only one page at the time, but the machine should not be considered as a full document handling printer.

The operation is quiet and avoids the noisy chatter often associated with the higher speed printers.

The machine can use any standard paper, unlike those printers requiring thermal or special types of paper.

As the unit also has an inbuilt calculator, this unit would be useful in an office environment and at home or at school.

The EB50 is produced by the Silver Seiko company of Japan. It can be put through its paces at the Plain Paper Photocopier Company, (02) 361 8492.



commodore THE BIGGEST SELLING COMPUTER

EPSON

THE BIGGEST SELLING PRINTER

THE ALL NEW **GX-80** 9-Pin Impact Dot Matrix Printer

NOW YOU CAN TEAM YOUR COMMODORE WITH EPSON'S PRINTER QUALITY

Recommended Retail \$528.00

OUR PRICE **\$379.00**
P.I.C. Interface & Cable **\$50.00**

XIDEX DISC'S
D/S D/D \$34.95
S/S D/D \$32.50

- 100 CPS
- PICA
- Near Letter Quality
- Enlarged
- Condensed
- Double-strike
- Double-strike emphasised
- Graphics
- Tractor Unit (option)
- Cut Sheet Feeder (option)
- Friction Feed Standard

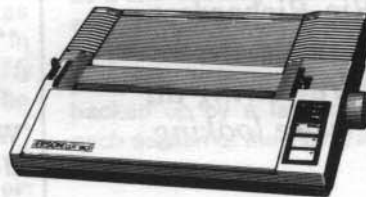

COMPUTER

(02) 267-8181

Ground Floor, Mirvac Trust Bldg.
Entrance at: 185 Elizabeth St and
160 Castlereagh St, SYDNEY



- Telegraphic Transfer
- Bank cheque
- Finance
- Cash



commodore
computer centre
PC, CBM8000, B700
VIC-20 & 64

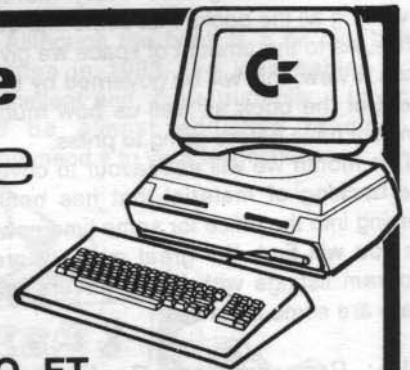

LARGE COMPUTER DISPLAY — 3000 SQ. FT.

WE ARE THE EXPERTS, COME AND SEE US FOR:

SALES

- Every conceivable accessory
- Huge range of programmes (particularly education)
- Direct connect typewriters
- 17 different printers
- Serial & Parallel Interfaces
- Monitors: colour and monochrome
- Touch tablets
- Plotters
- Disk Drives (4 different & includes compatibles)
- Desks, printer stands
- Books, labels, magazines (huge range)

SERVICE

- Prompt repairs by friendly experts
- Disk drives aligned (specialty)
- Easy access
- Plenty of Parking
- Open Saturday mornings
- Established 1968
- Repairs accepted by mail (include phone number)

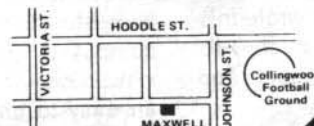

Maxwell OFFICE EQUIPMENT (VIC) PTY. LTD.
162-164 NICHOLSON ST. ABBOTSFORD VIC.
(near Hoddle Street) Telephone: (03) 419 6811

FOR SPECIAL
CONCESSION
BRING
THIS AD

Bookshelf

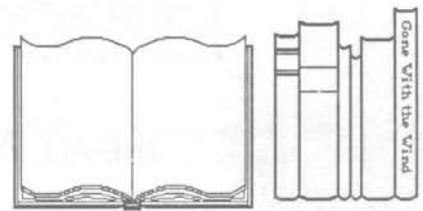

by Ric Richardson

A new section - hopefully every month - reviewing all the books that come into our office. But we're looking for help from our readers next month!

Because we all tend to dislike typing in programs, there has been a tendency for us here at *Australian Commodore Review* to veer away from the printed programs that we find in most books. But, at the same time it will be a long while before programs are available as software as cheaply as they can be obtained from a book on the subject.

On this basis we are going to run a new section in the magazine every month reviewing all the books that come into our office. As to the amount of space we give each review, this will be governed by the merit of the book as well as how much time we have before going to press.

This month we will endeavour to cover the backlog of material that has been coming into the office for some time now. As you will find, the great majority are program listings with flashy covers but there are some surprises.

Title: *Programmers Desk Reference for Commodore 64 Basic.*
From: Prentice-Hall
Price: \$29.50

Another addition to the stable which exists between the *Commodore User Guide* and the *Programmers Reference Manual*. This is a very dry presentation with a smattering of extras, of note a section on dealing with that tyrant - the 1541 disk drive. The lady who wrote this book, Miss Mona Reinhardt, has gone to great lengths to make it thorough and informative.

After going through quite a few books

in this area, I find the main drawback that it has no central theme of application to illustrate the benefits of what you are learning. On the other hand it sure is nice to read a user aid where you are not continually running into little, yet irritating, mistakes.

Title: *The Illustrated Computer Dictionary and Handbook*
From: Educational Supplies Pty Ltd
Price: \$1.00

At first glance it makes you wonder what audience the book is aimed at. The book seems to cover so many different areas. But as you get into it you'll find that it is informative and interesting.

In overview, the book is an explanation of the different terms that you run into in the computer industry rounded off in these headings: How a Computer Works, Peripherals, History of the Computer, Programming Languages, Basic Commands, Structured Programming, Keyboards and Special Keys.

It's good to see someone who has a sympathetic attitude towards people who are trying to grapple with the idea of computers. The use of cartoons and humour make for easy reading and the arrangement of the information in alphabetical order makes for easy access to headings. I found particularly interesting the way that so many different computers are used and the varying instructions and controls are explained in an easy to understand way. All in all a must for anybody who has friends who

COMPETITION

We at the *Australian Commodore Review* are not the "LAST WORD" when it comes to reviewing books. The offer goes out to you, our readers, to review these books for yourselves, PERMANENTLY. Therefore, any of our readers who can take a pen to paper and impress us with their expertise in review, using less than 35 words, will be eligible for loan, ad infinitum, of the titles in this review. Yes, we're giving them away.

like using computer lingo or is new to the industry.

Title: *The Bumper Book of Games for the Commodore 64*
From: Pitman Publishing
Price: \$9.95

In a book that has better presentation than most we find William Roberts, the author, has got together with a lot of enthusiastic young programmers and compiled quite an extensive range of programs from simple to advanced, that could be all labelled as arcade type. These have been printed out straight from a 1520 printer plotter, then accompanied by introductory comments as well as some cartoons.

I find the book especially good for younger hackers who don't have the money in the first place to buy programs outright and who would like to have a

variety of games cheaply and in doing so be entertained with its cartoons. Nothing startling, but by no means a fizzer.

Title: Games Commodore 64 Computers Play
From: Addison-Wesley Publishing
Price: \$11.95

A book with the basics as far as presentation. But, what it has lost in presentation it has gained in the quality of the games that it contains. The co-writers have got together some arcade type games from a bunch of young programmers and balanced them out with some simulation and adventure programs. Examples of arcade action can be found in games such as Astromash and Ghostie which use the graphics and the sound generating capabilities of the Commodore 64 to the full. Leaper has programmable characters and also nine levels of difficulty in playing.

These programs are balanced out with several simulation games. They range from commanding a fighter group in the Royal Air Force to managing a property called "Sunnybrook Farm". A program like this seems out of place in a games book, but let me give you some of the details of the game to see if it appeals to you. It's based on a re-creation of all the problems and hard work involved in running a farm, trying to make enough money to cover overheads and battling with the weather, unions and equipment breakdowns.

During each year you will have to decide if you will borrow money from the bank, replace capital equipment, buy or sell land or sheep, irrigate your land and crops, give in to union demands, which crops to sow and then wait to see how the weather affects all this hard work.

Does this sound like your bag? Then maybe it would be worth your while to trot down to a computer bookshop and have a look at the programs for yourself.

Title: The Commodore 64 Program Book.
From: Phoenix Publishing
Price: \$22.00

Yet another book of listings. But out of this group, I find it to be the most likely to

succeed. On top of this it lays claim to the widest variety of programs. There is "Chequebook" just waiting to be used with the household accounts or even in a small business. There are a few flight simulations as well as the obligatory arcade favourites. The author, a considerate fellow, has gone to some length to look after us with explanatory notes, ways to beat the program as well as a line directory that explains the way each program works, line by line. The invitation to personalize the program with your own colours or whatever else, is backed up by a layout that separates each section of the listing into its various functions.

Title: Brain teasers for Basic Computers
From: Phone ACR

The first part of the book is a series of questions that are later on answered by using simple programs that somehow along the way demonstrates the marvellous potential of computers. Definitely one of the best examples I have seen of showing how programming a computer is done. Take for instance the second question;

"Young Jamie had been in a mischievous mood, and had succeeded in exasperating his form master all

afternoon. Consequently he had been given an extra piece of homework in order to direct his energies in a more academic direction.

He had been given the following four numbers and he had to find the largest number that could be divided into these numbers that would in every case leave the same remainder: 1731, 5363, 7179, 9903.

Jamie thought the task would be easy, but he was soon to find it was a lot more difficult than he had imagined. What was the number that he was after?"

```
Try this for a solution:
10 FOR N = 1731 TO 1 STEP - 1
20 LET R = 1731 - R
30 IF R > N THEN GOTO 20
40 LET A = 5363 - R
50 LET B = 7179 - R
60 LET C = 9903 - R
70 IF A/N - INT(A/N) <> 0 THEN GOTO 12080
80 IF B/N - INT(B/N) <> 0 THEN GOTO 120
90 IF C/N - INT(C/N) <> 0 THEN GOTO 120
100 PRINT N
110 STOP
120 NEXT N
```

Although the book is a bit old, being written in 1983, the idea behind it is excellent and, quite truthfully, I found it to be almost addictive reading. I commend it to your inspection.

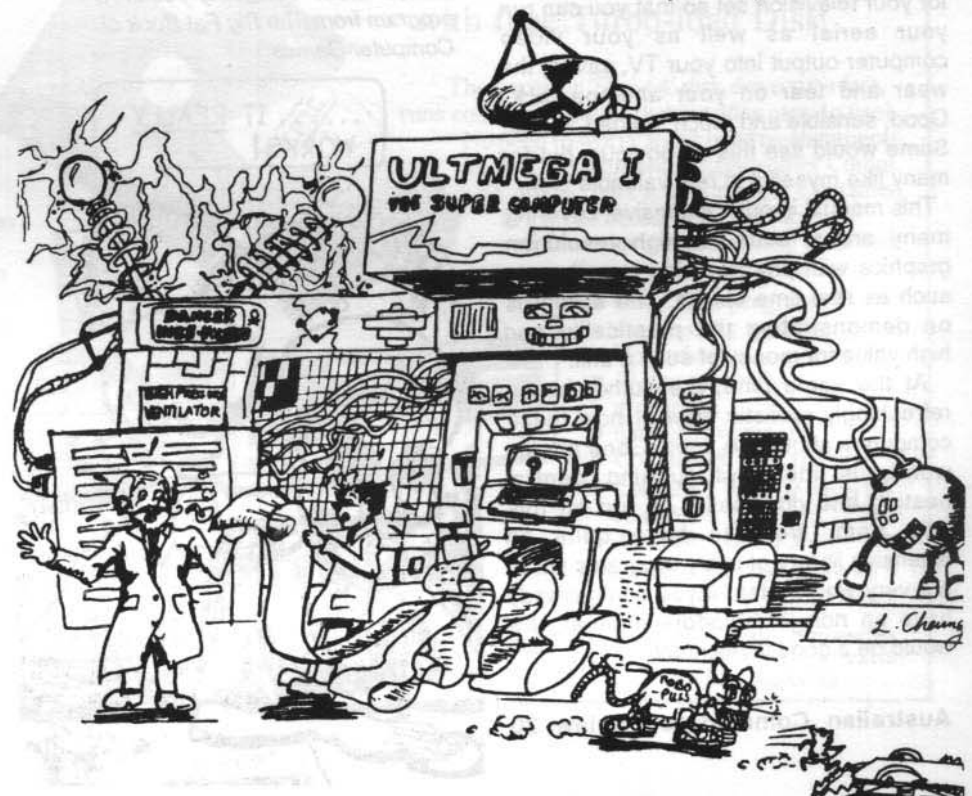

Title: *60 Programs for the VIC 20*

From: Pan Books

Price: \$14.95

After thumbing through the book my usual next step is to investigate the introduction or preface. From this we learn that the authors were determined to provide a listings collection that offered real value for money.

The great bulk of the contents are arcade type games, with more merit than most. The listings are generally short and sweet, approximately 120 lines long. Although this looks to be a daunting task when multiplied 60 times it must be remembered that they represent literally hundreds of hours of fun.

Title: *Getting the Most out of your VIC 20*

From: Penguin Books

Price: \$10.95

In the early days we saw what were almost outright copies of the manuals that came with the computers. They had only the advantage of better layout and a flashy cover. This book is not of this genre. Besides the basics, it also has a wide range of user tidbits that really do make computing that much easier. Simple little things like getting a "splitter" for your television set so that you can run your aerial as well as your video computer output into your TV, saving the wear and tear on your antenna jack. Good, sensible and much needed advice. Some would see this as obvious, but for many like myself it is real valuable stuff.

This manual is quite extensive, covering many areas, such as high resolution graphics with programming experiments such as real time clocks. The accent is on demonstrating the practicality and high value for money of such a unit.

At the same time, the author has a refreshingly realistic view of how these computers should be used. Gone are the wondrous ideas of running central heating and door-bells. To top off this little gem, we also have quite an extensive library of utility programs which are very well written. If you don't already have a non-Commodore manual, this would be a good investment.

Title: *Commodore 64 Basic Programming with Technical Applications.*

From: Prentice Hall of Australia (Brookvale)

Price: \$25.50

Out of the potpourri before me, the information that lies between these covers really seems to stand out. The reason for this is that we have our friend the 64 being used, for once, for a more serious endeavour. Serious endeavours? Yes, this kind of presentation would not seem out of place in high schools and universities. Why? Consider some of the applications that illustrate Basic programming. We have listings that evaluate mathematical functions and then visualize them on a plotting graph to demonstrate those aspects of the 64.

Although the language is decidedly technical, it is at the same time refreshingly direct and to the point, uncumbered by superflous information. The opening chapter, covering the history of computers and their emergence in 20th century living, should appear in every book on the subject as it is a necessary step in helping the reader to become familiar and therefore more comfortable with this new world. We also

Cartoon from "Telepathy Tester" a program from The Big Fat Book of Computer Games



see the return of the flow chart and some interesting electrical diagrams from inside the 64.

A no-frills, face the-the-facts type of presentation for the studios at heart.

Title: *Extended Basic for the Commodore 64*

From: Interface Publications

Price: \$4.95

Do you enjoy programming? Well, here is a little booklet to make your life easier. Contained are a series of commands that are designed to cut corners for you. Examples of these are:

HGR-which creates a high-resolution screen mode.

DRAW-which plots a line from one point to another.

BACKUP-a utility for making security copies of machine code and other general backup duties either on cassette or disk.

OLD-which retrieves any program you have NEWed.

CHEAT- so you can slow down the speed of machine code arcade games to clock up impressive scores.

KILL- a command that shuts down and then restarts the 64 without using the power switch.

All this plus advice on how to make up your own commands. Some good ideas for a few bucks. Definitely worth a peek.

Title: *I Wish I Knew...About the Commodore 64.*

From: Pitman Publishing.

Price: \$18.95

If user aids are meant to be people orientated, this effort would be a business man's version. A presentation that is very professional. Clean straight forward layout that is devoid of the usual cartoons. Generally a book with the bare essentials, not an enthusiast's book. It obviously misses the mark when claiming its audience as being parents and their children in the home situation. If you want the basic facts or just want to get on with the business of computing with a minimum of fuss, this is your kind of book.

Continued on page 22

Here it is:

*

Our THIRD issue of The Australian Commodore Review on disk!

*

All on disk ready to use: Perpetual Calendar, Simons Basic Doodler, Further documentation on Electronic Card File PLUS Constructabricks - specially for the kids. More disk utilities. Fast DOS. Latest Bulletin Board Listing PLUS

A surprise piece of sample software to taste-test - see if you like it .And lots, lots more. All on one disk - for only \$12.95!

And if you missed out on our FIRST and SECOND Disk Magazines, now's your chance! There are still some available, and you can have both the first and second disk magazines for the total price of \$20, plus 50 cents postage.

To: The Australian Commodore Review

Top Rear, 4 Carrington Road, Randwick, NSW 2031. Phone: (02) 398 5111

Send me.....copies of the THIRD issue of your disk magazine at \$12.95 (plus 50 cents for postage and packing).

Send me.....copies of the SECOND issue PLUS.....copies of the FIRST issue at \$20 for the pair, (plus 50 cents for postage and packing.)

I enclose a cheque/money order for, OR my Bankcard number is.....

Name.....

Address.....

.....Postcode.....

Back up & Stay up!

Back up Commodore with the new ISEPIC

(pronounced Icepick). This revolutionary hardware/software combination allows you to bypass (Commodore-64) any disk protection scheme. Now you can back up all your precious Commodore 64 software! The ISEPIC saves the protected program as it runs in the 64's memory which then becomes accessible for complete inspection and alteration. ISEPIC can automatically create a compact, auto-booting, fast-loading file which is completely unprotected and self-contained. Comes complete and ready to run, just plug into expansion port.

- Programs load faster than originals
- Eliminates drive "knock" due to protection schemes
- Place multiple programs on a single diskette

\$149



New Release - Skai 64 Super Drive with free Turbo-load Disk

The superior 'Skai-64' disk drive runs fast, runs cool, runs more reliably and is easy to use! No need to worry about head re-alignments and overheating which plague other Comm. 64-drives, ours is guaranteed. Contained in a metal casing which reduces RF-radiation and has externally mounted device address switches.

- Over 2000 programs successfully tested
- Upgradeable
- 10-day money back guarantee
- 6 months warranty
- Compact & easy to use

• Long & reliable drive-life **Now only \$299**

Benson Computers

PTY. LTD.

* Purchase these two products together and you will receive a box of Logitec floppy diskettes!



177 Barkly Street, St. Kilda, Vic 3182
Phone Orders: (03) 534 0794

Australia wide deliveries
Mention this ad for extra
FREE diskette

BCbc002

BOOK REVIEWS

Title: Commodore 64 Games Book.

From: Melbourne House.

Price: \$19.95

Yet another book of games. An effort that is obviously been compiled with a budget in mind. Just the same it does have all the elements that make for a success. It has thirty games that each have a picture copied from the screen during play, brief notes on what the game is about and an outline of the listings explaining how each line works. It should be mentioned that we run into golden oldies like Space Invaders in it's most basic form. The games are fairly uniform in size throughout. Another for the collectors library.

Title: The Best of VIC 20 Software.

From: Sybex.

After seeing Mr Blackadar's comments when reviewing his book on 64 software, this compilation is easily of the same standard. Not meaning to be negative about an excellent book, I do see a problem with the title as it assumes that enclosed are the only programs worth looking at. The facts show that in the time it takes these books to be published, some of the worlds best, most professional products can be put together and topping the software charts. None the less, the great majority are oldies but goodies. Mr Blackadar does have a realistic and informative technique of laying out the facts for us. As we've seen in other books, we have the obligatory dissection of software into arcade, adventure, music, education, home management as well as a concluding chapter called "Going Beyond". After seeing more complicated versions of these games on high capacity computers there can be a tendency to be negative about the inheritant restrictions of these versions in comparison. This is avoided throughout the book. For instance, Shamus is reviewed for its merit in using the VIC 20's capabilities to the full. It is obvious that this man has reviewed a lot of software by his flair at highlighting good and bad points as well as his ability

to be balanced about the plusses and minusses of working with various computers. If you are new to the VIC and you would like a good reliable source of advice on the software to buy, this is worth your while.

Title: Commodore 64 Computer Graphics Toolbox.

From: Prentice Hall

Price: \$23.95.

Amongst the big pluses of the 64 is it's graphics and this book is 'as it claims' a short cut to the use of these. The book shows you how to create cartoon characters, calendars, game boards and helps you develop a series of utility programmes for your own games.

The underlying psychology is that people learn more by doing and therefore, the writing style is more sympathetic than most. The normal chain of learning is followed. We examine a case program, have it explained for us, are encouraged to type it in and see how it works, but here is where this book excels. Instead of just pointing the finger and saying "here is a good place to personalize the program", the author gives you a series of options and suggestions. This is, in my experience, the only sure way of giving a hacker true programming confidence. The utilities that you can use range from programs that throw dice to simulations of bouncing balls.

Of particular interest are the drawing programs that allow you to design your own video masterpieces, all this with the ease of single key commands. Nice clean layout makes for easy studying and therefore easy learning.

Title: The Big Fat Book of Computer Games.

From: Interface Publications

This book is thick. On first inspection, it looks to be a hackers dream. The programs inside look to be longer but more compact. Wait a minute!! Close inspection shows us that there are commands that we aren't used to. Oh No! The introduction tells that the programmes were compiled on an IBM PC and that continually throughout the text you need to convert program instructions

if you want to use them on a 64. Sorry to say, a step backwards for what was looking to be an excellent book. If you can overlook this problem, then there are a lot of things to look at. I found of interest, a good light-hearted sense of humour. You also get the feeling that there has been more effort used with this project. For example, the originality of the illustrations.

Let me give you a run-down of the contents: there are space orientated arcade type games, adventure games of note a program called "Magicians Maze", war games, dice games, brain twisters, simulations, of note programmes called "Wall street trader" and "The Voyages of Magellan". The explorer of note who was first to circumnavigate the globe.

Lets have a look at it. First up, we are given a report from the first mate.

Captain Ferdinand report for week one. Heading south from Spain with a crew of a hundred a twenty men.

Proximate of the Canary Islands.

The treasury holds 208 dubloons.

The galley stores 111 sacks of food that will last nine weeks at sea.

Your options, to inspect the hold, trade with the natives or set sail for the next port.

If luxuries such as this are available from the programs, you may wonder whether the listings are humungus. For the amount of action you get the programs are as short and sweet as possible. Generally, if you can overlook the command conversion factor, this effort represents a better investment of time than most other books.

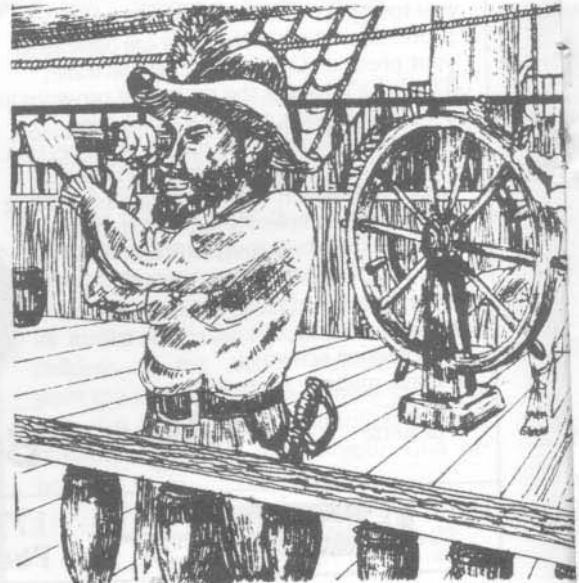

SOFTCENTRE

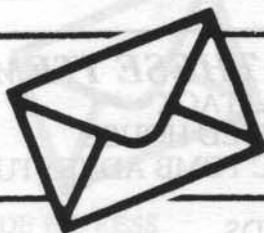

MAIL ORDER LIST

BOOKS

C64 SUB ROUTINE COOK BOOK

This one won't tell you how to bake apples or skin peaches.
15.95

INSIDE COMMODORE DOS

The book that puts you into the picture of C64 Dos. Very thorough.
34.65

MUSIC AND SOUND FOR THE C64

A book no C64 user should be without
Lots of ideas and info.
26.95

THE COMMODORE 64 SURVIVAL MANUAL

Contains one of the best chapters on troubleshooting we have ever seen. Something for everyone.
15.95

BUSINESS

ABRACALC|HOME MANAGER

Great little spread sheet program of up to 1040 cells + extras (D).
39.95

COMPLETE FINANCIAL ACCOUNTING

Accounts Payable for C64
Accounts Receivable for C64
General Ledger for C64
139.00 each

INSTA WRITER, MAIL, FILE
Word processing which is easy to learn yet powerful to use (D).
69.95

WIDGET TRACKER
1500 item inventory control package. Supports range of printers (D) 139.00

UTILITIES

GRAPHICS WORKSHOP 29.95

TAPE ALIGNMENT KIT 24.95

Unleash the music in your Commodore 64

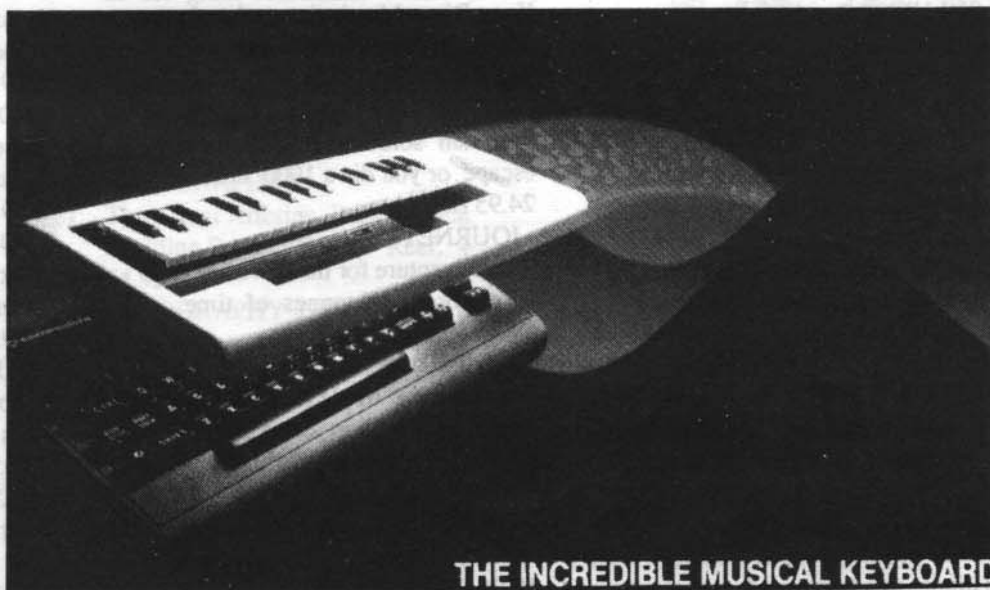

THE INCREDIBLE MUSICAL KEYBOARD

MUSIC

INCREDIBLE MUSICAL KEYBOARD

Unleash the music in your C64. Music Processor included (39.95).
69.95

KAWASAKI SYNTHESIZER

Transforms your computer into a programmable synthesizer and sound processor.
59.95 (D or C)

KAWASAKI RHYTHM ROCKER

Creates space sounds and hi-resolution colour graphics.
49.95 (D or C)

MUSIC PROCESSOR

Create, edit, record and compose your own musical arrangements.
39.95 (D or C)

MUSIC VIDEO KIT

Make your own music videos with this powerful graphics processor.
59.95 (D)

3001 SOUND ODYSSEY

Complete tutorial on musical synthesis.
49.95 (D or C)

I have carefully looked over the entire range of software and hardware being offered in this mail order list, and believe that it is of good quality and excellent value for money.

Andrew Farrell, Editor

SOFTCENTRE

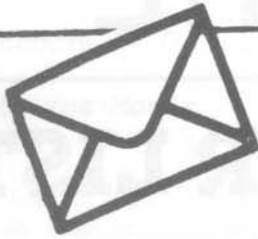

GAMES

ADVENTURE QUEST
Explore middle earth and reach the black tower. 200 locations. Text. 29.95 (D or C)

ASYLUM
3D mazes will stretch you to the limits in this top class adventure 39.95 (D) 29.95 (C)

BOZO'S NIGHT OUT
Old time drinking songs get you in the mood to stagger home! 14.95 (C)

CONAN THE BARBARIAN
Your goal is to find and destroy the villainous Volta. 7 levels. 39.95 (D)

DALLAS QUEST
Hi-Res adventure. JR Ewing takes you in search of 2 million dollars 39.95 (D)

DRAGONRIDERS OF PERN
Alliance forming and battle constitute this fast paced game. 19.95 (C)

DUNGEON ADVENTURE
200 locations and 100 puzzles will keep you off the streets. Text. 29.95 (D or C)

FAX
Trivia, trivia and more trivia. Great game to help make enemies! 39.95 (D)

FIRE ONE
Destroy the enemy from down below. Fast paced submarine action. 29.95 (D)

GHOSTBUSTERS
You've seen the movie now you too can get slimed. Back off man! 29.95 (D or C)

GILLIGAN'S GOLD
Collecting the gold is the easy part of this arcade beauty. 14.95 (C)

GYPROD
Shoot off into space to shoot up alien planets. Action plus. 14.95 (C)

SPECIAL LOW PRICES ON THESE ITEMS

BUG BLASTER	14.95	BAT ATTACK	9.95
GUARDIAN	14.95	HAUNTED HOUSE	9.95
EAGLE EMPIRE	14.95	AZTEC TOMB ADVENTURE	14.95
PANIC PLANET	14.95	BRANDS	9.95

HIGH NOON
Keep Rig + Mortis the undertakers happy as you clean up the town. 14.95 (C)

INSTITUTE
Freudian solutions may help you escape or you die a 1000 deaths. 24.95 (D)

JOURNEY
Text adventure for those with real hard noses and tonnes of time. 19.95 (C) 24.95 (D)

JUMPMAN
See the Aust. Apple Review for low down and up top of this game 29.95 (D)

JUNGLE QUEST
Atari have it, Apple have it, and now you too can rescue Jane. 19.95 (C) 24.95 (D)

LOCO
Split screen action as you chug away through 9 levels of play. 19.95 (C) 24.95 (D)

MONTY MOLE
Become a mole intent on spending a warm winter and battle for fuel. 19.95 (C) 24.95 (D)

NATO COMMANDER
What is it like to be on the other side? You can change all that. 29.95 (C) 34.95 (D)

OIL BARONS
Board game as well as software. Dallas at home. Big game. 69.95 (D)

PEANUTBUTTER PANIC
Arcade game for the younger set from the Children's TV Workshop. 39.95 (D)

PITSTOP
Classic car driving action game. Strategy and nerve are necessary. 19.95 (C)

POGO JOE
Jump your pogo stick across 32 screens of cylinders. Fast paced. 19.95 (C) 24.95 (D)

POLE POSITION
Experience the thrills of Formula 1 as you race against the clock. 29.95 (C) 39.95 (D)

POTTY PIGEON
Make your home to the tune of great music and superb graphics. 19.95 (C) 24.95 (D)

QUO VADIS
I don't know, but someone sure does! Catchy title in any case. 29.95 (C) 34.95 (D)

RETURN TO EDEN
First Level 9 game with graphics. 250 locations, many puzzles. 29.95 (D or C)

SNOWBALL
Huge adventure with over 7000 locations awaiting you! Text. 29.95 (D or C)

SON OF BLAGGER
Sequel to Blogger. Continues in the tradition of its predecessor. 19.95 (C) 24.95 (D)

SPACE ACE 2101
Strategic arcade real time game. Trade before you fight. 19.95 (C) 24.95 (D)

SPY HUNTER
Hunt spies till the cows come home and the chickens roost! 29.95 (C)

SPY vs SPY
Classic from Mad now comes home. Ingenuity + steady hand required. 29.95 (C) 34.95 (D)

STRIP POKER
R rated computer game - sizzling graphics! Have to see to believe. 29.95 (C) 39.95 (D)

SOFTCENTRE

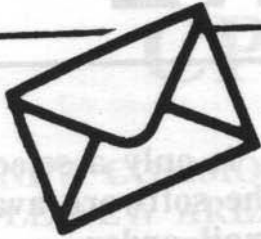

SUICIDE EXPRESS

The future of the human race is in your hands once again. Arcade.
19.95 (C) 24.95 (D)

THEATRE EUROPE

Combination of strategy and arcade action in this popular new game.
29.95 (D or C)

ZIGGURAT

The most bewildering maze ever created. Is there a way out?
24.95 (D)

LEARNING

CONCENTRATION

Hours of fun for all the family. Memory building game on computer.
19.95 (C) 24.95 (D)

COUNTING

For toddlers from 3 - 6. Gets them going. 1-2-3 at a different level.
14.95 (D)

DINOSAUR DIG

Play 5 games as you learn about these great extinct creatures.
39.95 (D)

EARLY SEA EXPLORATION

Discover who put Australia on the map and where they were going.
14.95 (D)

EASY TUTOR

10 lessons in BASIC to help you to become the computer expert.
39.95 (C) 44.95 (D)

EXPLORERS III

Keep tracking over the Blue Mountains and around Van Diemen's Land
14.95 (D)

EXPLORERS IV

Beyond the mountains with Oxley, Hume and a cast of a few more.
14.95 (D)

EXPLORERS V

A riddle solved and expanding horizons - inland sea and centre.
14.95 (D)

EXPLORERS VI

Go west young man. Exciting times in the great Australian west!!
14.95 (D)

FRENCH IS FUN

Not if you live in South Pacific! A good program for learning.
14.95 (C)

GEOGRAPHY I

The Great Artesian Basin, Great Dividing Range, Barrier Reef, +
14.95 (D)

GEOGRAPHY TUTOR 1

Introduction to Aust. physical geography. Learn maps + mapping.
14.95 (D)

GRAPHS 1

Graphic information explained. For 10 to 13. Also avail. GRAPHS 2.
14.95 (D)

.pa

HANGMAN V

800 words from Australian lists for the 10 to 12 year olds.
14.95 (D)

HANGMAN VI

Great graphics and sound as in Hangman V, but for the 11 to 13s.
14.95 (D)

ITALIAN IS FUN

Learn the phrases before you go, and in the privacy of your home.
14.95 (C)

LEARNING BRIDGE MADE EASY

Personal tutor who won't abuse you for playing the wrong cards.
69.95 (D)

MAP READING 1

Where are you and where are you going? I don't know but this does.
14.95 (D)



MEMORY TRAINER

Fun for all as you increase recall of numbers, words and lists.
14.95 (D)

MONKEY MATH

Graphics and animation add excitement to learning maths - younger.
29.95 (C) 34.95 (D)

ON SEA AND ON LAND

From Captain Cook to George Bass for the 10 to 13 year olds.
14.95 (D)

PLAYFUL PROFESSOR

Basic arithmetic. Correct answers bring you closer to gold!
29.95 (D or C)

PROBLEM SOLVING 1

For 8 to 10 year olds. Teaches key words and helps problem solving.
14.95 (D)

SET THEORY

Nothing to do with jelly, but sets the mind with set theory!
14.95 (D)

SHAPES

For toddlers 3 to 6. Animation, graphics and sound teach shapes.
19.95 (D)

THE GREAT BALLOON RACE GAME

Learn about the air and climate from your balloon. Skill + chance.
14.95 (D)

THE WATER CYCLE GAME

Scientific learning game with superb graphics for 1 - 4 players.
14.95 (D)



SOFTCENTRE

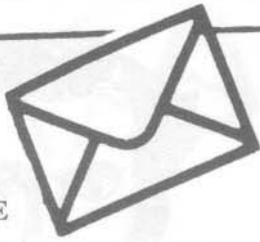

HARDWARE

COMPETITION-PRO

Sturdy construction with 2 large buttons for positive firing.
39.95

GRAPPLER CD

Intelligent printer interface with a wide selection of commands.
195.00

SUPER SKETCH

Create video graphics on screen as easily as drawing on paper.
109.95

SUPER SKETCH PAD + PRINT DUMP

Same as the Super Sketch Pad but with printer software included.
129.95

SUPER STIK

Looks rude, sounds rude, but it's a great little wowser!!
24.95

TECH-SKETCH

Light pen that turns your VDU into canvas. Store 48 pics to disk.
99.95

This is only a selection of the software available for mail order.

If you don't see it, write to us enclosing a stamped addressed envelope.

As advertisements must be prepared well ahead of publication time, prices are subject to change without notice.

ORDER FORM

Postage and packing on each item: please add: 1.25 for software
1.50 per box blank disks
2.50 per book
3.75 for hardware listed

Please apply for bulk rates.
Orders greater than \$475 obtain a FREE subscription to ACR for 1 year, or FREE postage and packing.

Please list each item that you require, then add your name and address and post together with cheque or Bankcard number to:
BEAGLE C.S. P.O. Box 233, Woollahra, NSW 2025
(02) 389 9767

NAME.....	ITEM	COST
ADDRESS.....
.....
.....

Payment * Cheque enclosed Add pBp -----
or * Bankcard

TOTAL

..... bankcard expiry date signature



CP/M and the C128

THE NEW COMMODORE 128 HAS CP/M AND THIS WILL OPEN UP A WHOLE NEW AREA FOR THE USER. BILL DONALD ANSWERS SOME OF THE QUESTIONS YOU MAY HAVE ABOUT CP/M, AS IT IS LIKELY THAT MANY OF YOU HAVE NOT EITHER SEEN OR USED IT BEFORE.

CP/M is an operating system. It is not a programming language, as I have heard one dealer describe it to a prospective buyer.

In effect, the C128 Kernel ROM which holds the code for the machine's

"This program is written in 6502 code which switches on the Z80 processor and switches off the others."

operation in native 6502 processor syntax, is switched out and replaced with the code for the Z80 processor.

This code is not held in a ROM, but is loaded into the machine from the CP/M System disk.

What is the System Disk?

The system disk contains the bootstrap loader program for configuring the C128 to a CP/M machine. This program is written in 6502 code which switches on the Z80 processor and

"The system disk also contains the various utilities which are supplied as part of the CP/M system."

switches off the others. The Z80 then continues the process of loading further configuration code, this time in Z80 form.

The machine can now read or write only Z80 based code.

The system disk also contains the various utilities which are supplied as part of the CP/M system. These include an assembler, simple text editor monitor

and file transfer program amongst others. Why do we have to use a Z80 Processor?

In short, for historical reasons. Way back in the Jurassic (or dinosaurs, if you like) period of microcomputers in 1973 the very first microprocessor was made commercially available by INTEL. This was the 4040 which had an enhanced instruction set, until finally the limitations of a 4-bit chip were swept away with the introduction of the 8008. This series of 8-bit processors followed the same pattern of development, ie 8008--<8080--<8085--<Z80.

Very soon after the introduction of the 8080, it was realised that the use of these relatively powerful processors would be limited without some means of standardised control. The year 1975 arrived and a former employee of INTEL (who apparently were not interested) expanded this concept by developing what is now known as CP/M.

Can any Z80 Based micro run CP/M?

Theoretically yes. CP/M has a structure of code which makes it possible to transplant easily on Z80 machines: The three basic elements of a CP/M implementation being the CCP (Console Command Processor), the BDOS (Basic Disk Operating System) and finally the BIOS (Basic Input/Output System). These are laid into memory in a co-ordinated sequence with the user program area always starting at \$100. The latter is termed the TPA or Transient Program area. The machine's Zero Page is additionally reserved for CP/M.

Of the three elements, CCP BDOS and BIOS, only the BIOS source code has to be specific to the machine in question. Since this is held in RAM on the

C128, it is perfectly possible (provided you know your way around CP/M) to edit or rewrite the BIOS to include customised routines or change the parameters of the peripherals, if for instance, you decided on increasing the number of disk drives or include a daisy wheel printer.

How do you recognise when the C128 is running in CP/M mode?

If the C128 has already booted-up the system disk then look carefully at the cursor. You should see the following if the machine is running CP/M:-

A<

The "<" is flashing and this is the CP/M prompt. The "A" signifies that the user is utilising disk number A. Note that the vital thing about using CP/M is that you are ALWAYS logged on to a disk. This is of fundamental importance in grasping how to operate in the CP/M environment. If the system disk is booted up from a cold start you will see on the monitor, the copyright notice from Digital Research Inc as well as the system size in bytes.

Digital Research is the company formed by Gary Killdall, the originator of CP/M after he left the disinterested INTEL company. Seemingly every industry has its parallels, and the CP/M and INTEL story always reminds me of the wretched Decca Records Co. executive who gave the thumbs down to a recording contract to the Beatles in their formative days, he did not think they would be a success commercially. DR quite cleverly, do not sell the CP/M system, but license it to the users such as you and me. This is the purpose of the registration card, and although registered users are informed that they will be kept

up to date with developments in CP/M, I do not think I would be alone in saying that this side of the bargain is definitely not kept.

Is CP/M easy to use?

The answer to this one is probably bound up with what you have been used to. If you used computers before 1980, then the answer will be yes. CP/M has been around for a very long time in computer history time scales and therefore represented the state-of-the-art during that period. These days, particularly those of us who have been used to Commodore micros, expect full screen editing, simple file transfer techniques between peripherals and comprehensible disk error messages. These are not part of the CP/M system.

"CP/M has never won any award for user-friendliness"

Hence it is not without reason that the other name for CP/M is "Confuses People Most"!

The clumsiness of the system can be overcome to a large extent by the software which is available for it, but CP/M has never won any award for user-friendliness.

If it is that bad then why have Commodore selected it?

In the deep dark recesses of the corporate mind of Commodore, the answer will be money (meaning more of it for Commodore). Because of its age, it represents an established operating system which has had most (note the word most) of the bugs ironed out. To develop from scratch an operating system costs millions, and since this would be built on to a technically obsolete 8-bit chassis in the shape of the Z80, there is your answer.

It is rather analogous to the motor industry, where similar financial constraints apply on developing engines and gearboxes. You, the user are not interested in the fact that the Falcon gearbox is made by Nissan and is used also in the Mazda 323, or that the

Commodore taxi taking you to the station has an engine built and used by Opel.

The same benefits of spare parts availability extends back into the microcomputer world in terms of software availability. In other words, the economies of scale resulting in the use of standardised operating systems reflects a function of the amount of available software.

What sort of software is available?

Other than hard core pornography or aspects of Cartesian philosophy, there is a piece of CP/M based software for 99% of all applications. The beauty of CP/M software is that there is a huge, and I mean huge, amount available in the public domain. Like most public domain software very careful filtering will reveal the little gems, but bear in mind that the bulk of it is now old hat in programming terms. Greater than 75% of it has originated from the USA, which accounts for the heavy American overtones in some areas.

The public domain software writers of pre-1981 did not have the Commodores Ataris or Spectums at their disposal and in the main aimed to produce serious programs for their machines running CP/M. If they did produce any games

"Virtually every programming language known to man is implemented on CP/M"

they tended to be more directed at the educational area, so don't look for arcade hits. Most of the best games appear to be adventure types. The majority of the so called business programs in the public domain have no real use to European users since they are based on American corporate practice. The same applies to the communication programs which use the Bell Telephone system's frequencies and only support 300 baud (ho, ho).

However, if you are into programming both at high level and at assembler level

then the rewards are overwhelming. Virtually every programming language known to man is implemented on CP/M and if the inclination takes you, then the

"Virtually every programming language known to man is implemented on CP/M and if the inclination takes you, then the skies are the limit"

skies are the limit. Get hold of back issues of *Dr Dobbs Journal* and you are on the way to some real programming.

It is a peculiarity of CP/M that the standard system assembler only supports 8080/8085A op-code. This has the advantage that you are introduced (assuming you know 6502 code) gently into Z80 land since 8080 code is really a cut down version of Z80 code. However, there are many Z80 assemblers in the public domain.

What about commercial software?

What is available is good: *WORDSTAR* represents the leader in wordprocessors with *DBASE II* holding the flag in databases, the ubiquitous *VISICALC* carrying the honours in spreadsheets. It would seem that an application program for anything is available under CP/M, but it is sold on the assumption that you have plenty of money.

Where can I get this public domain software?

The best source is a CP/M User Group. Note that they can only supply the software on 8 inch disks, although they can also offer a copy service which caters for 5.25 inch disks. The cost for this service is very small since the disks hold more than what we are accustomed to in the way of 1514 disks, this represents extremely good value for money.

Needless to say, you have to be a member of the group to gain access to the CP/M library, but, the whole exercise is financially painless. If you do not wish to wait too long for the disk, then there are other commercially run sources of public domain CP/M software who can usually be found in the small adverts at the end of the non-specific microcomputer magazine.

The amount of public domain software can be gauged from the following facts. The CP/M User Group library has a total of 173 volumes. Since these are all 8 inch disks holding up to 241k of data, you can see there are no small quantities involved. If you really want to get into software I would suggest that you join the specialist group of the New Jersey Amateur Computer Club in the USA. Their library has 217 volumes as of January 1985.

I would ask you to bear in mind that, in common with all user groups, they are run by volunteers and that delays may occur in fulfilling your requests. Any correspondence should include a stamped addressed envelope, and remember, do not take these people for granted, they are not paid for their work.

Similarly, a user group is only as good as its members, so if you do come up with a useful program, then put it into the library.

What can CP/M do on the C128?

Because the C128 can bank-switch 64K into RAM and support 80 column display, the prospects with CP/M are very good indeed. The bulk of the software, both public domain and commercial is written with 80 column display in terms of colours unless you are prepared to add to the program machine code.

The 64k RAM is a strong feature of the C128 since this is the maximum size of RAM that CP/M can cope with, unless, once more, you are prepared to dig around the BIOS. The disk format represents no problem since Commodore have at last recognised that they must follow the market. The Osborne disk format selected by them in the CP/M

"The whole problem of disk formats arises from there being no industry standard for 5.25 inch disk. For the 8 inch disks, the problem does not arise since there is a standard, the one established by the originators of floppy disk drives, IBM."

mode must be one of Commodore's better decisions, since it is a very popular disk format for CP/M.

The whole problem of disk formats arises from there being no industry standard for 5.25 inch disk. For the 8 inch disks, the problem does not arise since there is a standard, the one established by the originators of floppy disk drives, IBM.

At the time when the smaller 5.25 inch disks became available IBM were not involved with the personal computer market. The microcomputer manufacturers did, in the main, continue with the IBM technique of using frequency modulation as a means of storing data on floppy disks. Unfortunately, Messrs Apple and Commodore decided to use the group code recording method which resulted in total incompatibility with everyone including themselves.

Ironically, Commodore do use a variation of FM for data storage...on the humble C2N cassette unit. However, they have seen some of the light, and for the C128 a standard disk format is used (in CP/M mode only).

Needless to say, the Commodore IBM-PC clone is fully compatible and uses the industry standard MS-DOS, they obviously were taking NO chance with that machine.

Can the C128 be linked to the C64 running CP/M?

No.

There are no insurmountable reasons why not. The two could be linked together through their User Ports and files transferred given that there is a resident file transfer program which defines the

C64 as a listener, and the C128 as a talker.

This can overcome the great problem with running the C64 under CP/M due to the total lack of software for the machine in this mode.

Will the C128 support printers other than Commodore when running CP/M?

The answer here is a reserved no. By this I mean that the C128 will not directly connect to a Centronics type printer such as the Epson RX series other than through the User Port and with some

"Although the detractors of CP/M can point to better operating systems such as GEM, MS-DOS or even TOS, they fail to recognise that these are meant for 16-bit machine environment. More importantly, none of these can match the utter weight of available software."

programming.

Do not worry though, one of the first programs you will get involved with if you decide to modify the BIOS will entail a printer routine. In fact the BIOS will already incorporate code for this, it just needs slight changes.

I thought CP/M was dead.

Surely this a retrogressive step?

No, good old CP/M refuses to lie down and die. It has its good points as well as the bad. Although the detractors of CP/M can point to better operating systems such as GEM, MS-DOS or even TOS, they fail to recognise that these are meant for 16-bit machine environment. More importantly, none of these can match the utter weight of available software, which ultimately, does, for better or worse, determine the life expectancy of any microcomputer.

There are a number of very good books on CP/M and, with the editors' permission, I hope to provide a review of these soon.

Do's and Don'ts of Computer Use

by Joe Rotello

If you have recently purchased, or plan to purchase, a new Commodore home computer, or, perhaps, lucky you, you have received one as a holiday present, then you'll want to heed these tips on how to set up your micro system and keep it humming.

Before you install your first home computer or upgrade an existing system, it is important to consider the environment in which the micro will operate. You should ask yourself and answer the following questions before you set up your microcomputer.

1. What am I using the computer for?
2. Where will my micro be located, and what precautions should I take to ensure a successful installation?
3. How and where will the accessories and supplies be located?
4. What happens when I want to change or expand the existing setup?
5. How can I limit data and financial loss should the unthinkable happen?

Home computer users defend their lack of computer planning by saying, "It's not worth the extra planning" or "I can always take care of those items later." Funny how many times we wish that we had taken that extra hour or so for planning, and how "later" never really seems to come in today's rush world.

Purpose

The reason you selected your Commodore computer in the first place plays an important part in the entire computer installation. For example, was it for a home use like database interfacing or an educational aid for the kids? Different purposes may dictate a different approach to questions 2-5.

How use affects installation is, perhaps, best described by a couple of choice situations. For example, if you

use on-line database services like *CompuServe* or *The Source*, you must have access to one or more telephone lines now or in the future.

If you plan to expand your system with floppy or hard disk drives, printers, plotters and other accessories, you will have to accommodate these items, as well as paper, disks, power outlets and other required basics.

If you have little or no idea why you bought your Commodore micro in the first place or how you intend to use it, how can you effectively plan for it? Once you define the computer's purpose, only then can you proceed to the next area of concern.

Provisions

Items you might consider under the heading of provisions include general location, ventilation/heating/cooling systems, proper lighting and flooring,

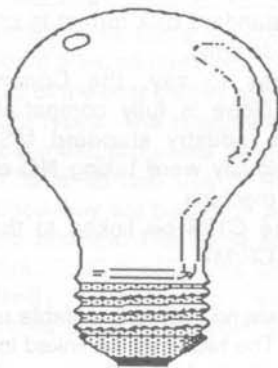

computer furniture and availability of sources of clean electrical power and telephone lines.

The very first step is to size up the overall room or area where the computer system will be located. Questions to ask yourself regarding location include:

1. Will I have sufficient working room, especially if I add to the system later? What about sufficient storage room for supplies?
2. Is the area well-lighted but not so brightly lighted that glare off the video or TV screen will become a problem? Is the

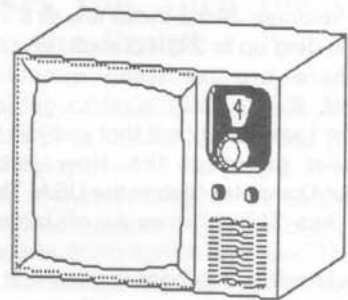

area cooled/heated to the extent that the computer (and you) will not overheat, freeze or suffer from lack of sufficient ventilation?

3. Are there sufficient electrical outlets? What about other household appliances? Are any outlets in the computer area shared with any other electrical noise-producing machines like air conditioners, heating devices or universal motor-driven devices like sewing machines?

4. Where are telephone lines and outlets located? If necessary, can they be easily modified to interface with the computer and its modem? Are there any extensions on the telephone line?

Problems associated with poor lighting will take their toll later, after the system has been used for an extended period of time. Take the time now to detect and solve these problems.

Rearranging existing lighting or installing track or fluorescent lighting may solve the lighting problems. Carrying out such improvements now will be very time and cost-effective. You won't have to fix the lighting at a later date when you will be too busy to do anything about it anyway. And your vision will not suffer

GETTING MORE OUT OF YOUR COMMODORE 64.

Your Commodore 64 can be used to access dozens of data bases around Australia and the world.

Find out all sorts of information, from weather to stock-market prices, even 'shop-at-home'.

The ACME Software MICRO-MODEM III plugs into your phone socket.

The software is called 64 TALK. This cartridge allows your Commodore to access information . . . anywhere in the world.

The ACME Software communications package.

The last word in computer communications for your Commodore 64.

Available now from your Commodore dealer

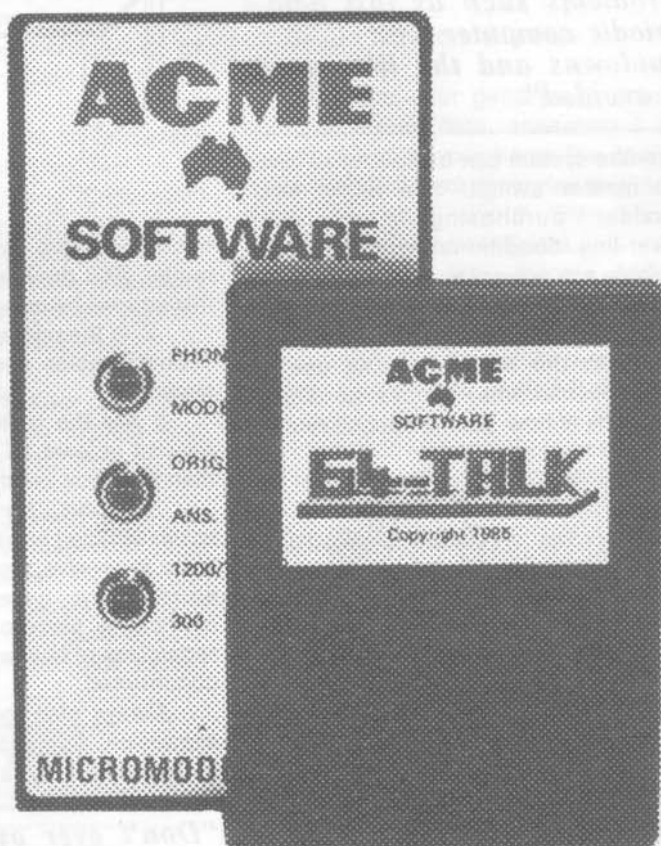

ACME SOFTWARE

PO Box 3, Brighton North, Vic., 3186. Tel: (03) 596 6732.

GOOD ADVICE

from poor lighting and many hours spent squinting at the computer terminal.

Problems such as lost data, periodic computer shutdowns and the like can be avoided if you take the time to survey the area, its power outlets, and prospects for clean power before setting up your Commodore.

Be sure to put each computer or peripheral on its own power outlet, or, better yet, install a multiple power outlet so that each item has its own outlet, yet

"Problems such as lost data, periodic computer shutdowns and the like can be avoided"

the entire system can be controlled from one master switch. You might also consider purchasing a low-cost power-line conditioner to reduce or eliminate any power-line problems.

Speaking of Telephones.

With the ever-increasing use of telephone modems, it pays to take a close look at how your telephone relates

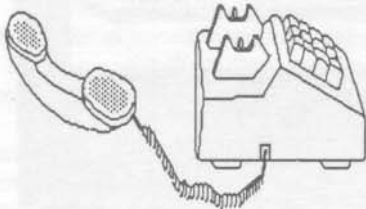

to the computer system. Place the telephone in a convenient spot and try to have a private, non-extension phone line. (Picking up an extension phone will terminate your computer data transmission).

(Please note: the higher-speed 1200-baud modems work with standard phone lines such as those feeding most homes, even though the modem data speed itself has been increased. In the past, such high-speed modems only worked properly if the phone lines were conditioned or rented expressly for modem use from the telephone companies. That is generally no longer the case, since the technical quality of

phone lines exceeds that of even four or five years ago.)

Computer Furniture/Tables.

Next, consider the following questions before installing tables or computer work stations.

1. Is the table and video monitor platform at a proper and comfortable working height? Is the table area large

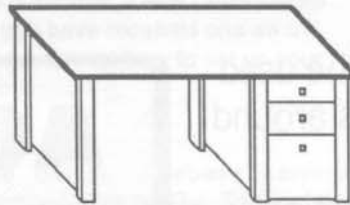

enough for the micro, video monitor, printer, disk drive and other accessories that you will be using?

2. Is the printer within easy reach to connect cables and change or remove paper?

3. Are the tables sturdy? Will they support at least 35 percent more weight than they look like they will?

In short, be sure to get firm, well-assembled furniture. It does not have to be expensive, just well-connected and sturdy once assembled. Don't ever overload a piece of computer furniture regardless of how well it may seem to be constructed.

Always plan for computer furniture expansion. Someday - and a lot sooner that you think - you are going to add to

"Don't ever overload a piece of computer furniture"

your setup. Don't run out of table room today for something that you will do tomorrow.

Flooring.

Computers are remarkably sensitive to static electricity. The type of flooring that you use is very important to the life of your micro setup (not to mention your sanity).

Cushioned vinyl flooring is quiet, attractive and easy to care for, but expensive. Carpeting composed of

naturally low or non-static material can be used as an alternative.

Another method is to install a large static mat over the carpet under the immediate computer zone. The electrically conductive plastic mat is grounded via a small slender wire to the power line electrical ground and is perhaps the best safeguard against static.

Another option is to locate one or more antistatic buttons or small conductive foam pads on the computer furniture. These items are also grounded and act to drain off any static charge that you may transmit to the equipment.

Most importantly, when using antistatic products, make it a habit to discharge yourself before touching a piece of equipment. Although it seems all shoes carry some type of charge, try not to wear those with man-made soles of smooth or hard rubber. They seem to be the worst as far as static is concerned. On the other hand, Hush Puppy or other similar soft-sole shoes seem to be best.



I do not recommend the use of antistatic spray except in emergency cases. The effectiveness of the spray is temporary, and the dry chemical mist can sometimes find its way into disk drives or other equipment.

Accessories and Supplies

Computer accessories and supplies like paper, disks, printer ribbons and other material form the lifeblood of any micro system. Bad supplies can lead to computer self-destruction.

First, take a good look at how and where you will store unused paper, blank disks, tapes and new printer ribbons. A clean, fairly cool, dust-proof storage environment for these supplies is

GOOD ADVICE

essential for the preservation of the paper and disks, but also to the proper overall operation and well-being of your micro equipment.

Properly covered disks, preferably in their own sleeves and boxes, should be able to stand up on shelves or in drawers. Excess paper stacked vertically so as not to curl or bend.

Operational procedures play an important part in the successful setup and operation of your Commodore. Use this computer do's and don'ts checklist to ensure that both computer and you operate without breakdowns.

DO.....

- * Provide adequate natural or fan-forced ventilation for your micro system.
- * Keep new and in-use disks and tapes away from any magnetic source.
- * Vacuum on a regular basis, keep unnecessary windows closed and cover equipment when not in use.
- * Quit banging on the keyboard.
- * Use computer disk and other components as if they were the last ones in the world.
- * Get the user manual out of the garbage, read it at least once and keep it within reach.
- * Maintain or have inspected at regular intervals any part of the micro system subject to any wear and tear.
- * Select chairs and desks so that you do not tire quickly or have to squint at the video display.

DON'T.....

- * Store or operate your Commodore system in heat or direct sunlight.
- * Store disk and tapes near motors, telephones or other magnetic sources.
- * Allow accumulation of dust or smoke particles to collect on or near your micro.
- * Fold, spindle or use for dart practice any computer disk or other component.
- * Use any new equipment without reading the user's manual at least once.
- * Let disk drives, printers or keyboards get dirty or stay broken too long.
- * Use uncomfortable chairs or desks that are of improper height.

To keep printer ribbons, tapes and other accessories from drying out or being contaminated with dust, store them in sealed plastic bags or other

moisture-proof packaging.

Never store computer hardware, accessories or supplies in the sunlight or near a wall or space heater. It seems that just about anything connected with or to computers has a nasty habit of not wanting to cooperate, especially when their ambient temperature is in excess of 125 degrees.

Future Changes

If you have carefully planned and executed your Commodore computer installation, changing, expanding or adding to your setup should now be far easier to accomplish.

Let's review the areas to be concerned with when it comes time to expand:

Computer furniture - Expansion requirements here generally consist of adding tables or other required platforms. Keep in mind that the structural integrity of the furniture is more important than the looks. Also, peripheral equipment has to be easy to reach.

Power outlets - Plan for additional power outlets. When you expand your setup, you'll simply tap into these outlets.

Accessories - Keep in mind the proper placement of new equipment and other accessories or supplies. Also, follow good electronic practices when routing power and signal cables. And ensure proper ventilation for the new items,

"Follow good electronic practices when routing power and signal cables."

especially if the equipment has to be stacked on top of or under your existing setup.

Safeguards

As surely as the sun rises, cats meow and computers compute, you will come face to face with the unthinkable. In fact, think of this as "The Day After," but in a more computer-oriented sense. In this light, the following caveats cannot be repeated often enough:

1. Always have complete and accurate receipts and records of model and serial number, date of purchase and replacement costs for every piece of computer hardware and software.

The effort you spend compiling accurate data regarding dates, prices paid and other individual data on your Commodore is small compared to the time, lost data, worry and money involved should you have to prove a purchase or verify a serial number at some future date.

2. Make many copies of this data, keep it up-to-date and store one copy at the microcomputer site, another elsewhere in your home and a third copy at your bank or other safe-storage facility.

3. Do not store this data only in a computer file!

4. If you ever generate important computer-based data, especially if the data is critical to your home life, always make sufficient backup copies and store them as you would the above non-computer-generated data.

5. Handle the micro setup, accessories and disks as if they were the last ones in the world. You don't have to go overboard, but if carefully treated, the system and its data should last longer than your car.

In fact, following the above steps may well be the only thing more important than

"Handle the micro setup, accessories and disks as if they were the last ones in the world."

your subscription to *The Australian Commodore Review*.

Epilogue

In conclusion, installing, upgrading or moving a Commodore home computer may take more work and thought than you originally anticipated.

As you have probably noticed, the main recurrent theme of this article is indeed a simple one: Preplanning your micro installation is the most time and money profitable approach to take. Taking the time to survey, arrange and rearrange before you proceed may save you lost time and frayed nerves later on.

The rewards for putting out that extra effort now will eventually be converted into dividends. You may have to wait an extra day, pay an extra dollar or build an extra project, but, in the long run, isn't it really worth it?

Profitable Computing

by *Alfred Rose*

The object of this article is twofold, it takes the reader step by step through the stages of constructing a spreadsheet for investments. It is also a review of using "CALC RESULT Advanced" for this purpose.

Profitable investment results from good timing based on accurate update information. The spreadsheet described in detail in this article provides at a glance the information required.

Though I have a CBM64 and "CALC RESULT ADVANCED", the details given will apply to most computers used with a spreadsheet. With early versions of spreadsheets such as "VISICALC", it was not possible to compile a sheet with

'After working on other spreadsheets, I found using "CALC RESULT ADVANCED" like changing from a standard popular car to a Roll's-Royce.'

tax calculations. This was because they would not handle formula with the terms "IF THEN ELSE," "GREATER THAN" and "LESS THAN".

After working on other spreadsheets, I found using "CALC RESULT ADVANCED"

like changing from a standard popular car to a Rolls-Royce.

When you first use CALC RESULT it is important to spend a few hours getting to know the program and setting up your master disk. Once the object of the "User Register" is grasped, the user begins to appreciate why you have to work through the routine of making a master disk to suit your own particular requirements. The original master disk contains HELP sheets in eight languages and a choice of eleven different printers. To save space and to speed up operation, on the work disk you only include the language and printer that you require. An excellent manual guides the user step by step through the initial stages.

As opposed to CALC RESULT's one page, CALC RESULT ADVANCED can use up to 32 pages (worksheets), each page divided into rows and columns. The intersection between the rows and columns create thousands of cells. In every one of these cells you can enter a number, words or formula.

Because of the amount of work to be covered, only a brief outline of how the program handles the data will be given and the other functions will be introduced as we construct the investment spreadsheet.

Data Handling

CALC RESULT stores data in three places.

(1) In RAM, the CBM's internal memory,

which can store two (two thousand cells) at a time.

(2) In the work area, located on the program disk, which acts as a temporary storage area and extra memory to the RAM. When the internal memory is full, certain pages are moved to the work area. This ingenious arrangement not only extends the computer's ability to handle large spreadsheets but allows you to quit an incomplete sheet, without losing the data.

(3) Completed work is saved on a data disk.

Full use is made of the CBM64 function keys and a very neat plastic template is provided to label these keys. To use the CALC RESULT commands, press function key F7.

The Investment Sheet

Having worked through the Tutorial lessons in the manual you are ready to form your investment sheet. Page 1 (see example) is designed to keep a record of shares (equities) and gilts (government stocks). Examination of the example sheet will show that it is packed with useful data: what you have paid for each investment, how many units, the unit cost and most important the percentage of profit and loss and amount involved.

Let us work through the various entries. You will notice on the second line of Page 1 the Dow Index (USA), FT30 Index, All share Index and the Exchange Rate. Each number must be inserted in a separate cell, as they will be referred to by formula in producing valuable statistics. These figures must be included when updating the sheet. This updating should be carried out every week or month depending on how active your portfolio is. All this information is given on the front page of the Financial Times or on the business pages of CEEFAX.

Next, refer to the line starting "EMF(CRES)." All labels are entered by first pressing the space bar - this distinguishes labels from data and formulas. Working along this row, enter the name of the holding and the quantity. Under the unit cost enter the formula

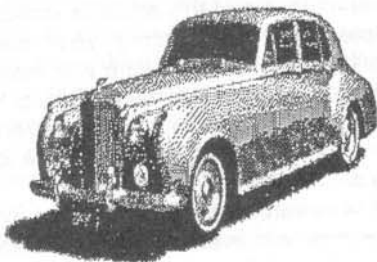

It's Not How Little It Costs



It's How Much You Get.



At last, the world's number one selling computer in a pack. The Commodore 64 now available in a family pack at a very affordable family price. \$700 value for just \$499. You get the powerful Commodore 64, plus datacassette and joystick, four software programs: Money Manager, An Arcade Game, Rolf Harris Picture Builder and Introduction To Basic (a teach yourself program). A great gift for the whole family who work and play together.

commodore
COMPUTER
Keeping up with you.

Contact your nearest Commodore dealer or Commodore Business Machines:
Sydney:(02) 427 4888 Melbourne:(03) 429 9855 Brisbane:(07) 393 0300 Perth:(09) 389 1266

SPREADSHEETS

D6/B6 and under the total cost enter the full cost including all expenses. The unit value is entered from the price columns of the daily paper.

It will save time if you enter your holdings in the order that they appear in the newspaper, but keep unit trusts and gilts grouped together. The formula to be entered under total value is B6*(E6/100), under profit F6-D6 and profit percentage G6/D6*100.

The profit figures are after all expenses, but of course to realise your profit you will be involved in selling cost. These are taken into account under the "SOLD" table on page 2 of the spreadsheet.

Now we can experience the marvels of "CALC RESULT" - we will never have to type these formulas again on this page! To repeat these formulas for each holding we just carry out the instruction to REPLICATE on each column in turn. Not only will the formula be repeated for each investment, but by asking the program to treat them as RELATIVE. The

reference numbers will be altered for its respective row.

After REPLICATING, you can edit any formula which refers to a share held in a currency other than sterling. Two examples of this are given in the case of Sony and Std Oil: these are entered from the newspaper in dollars. So the formula entered at position F14 is B14*E14/E2 and at F15, the dollar, against sterling, on the second line of the sheet.

Statistics

The table so far will enable you to monitor your portfolio, so that you can

"you can see at a glance when you are making a reasonable profit."

see at a glance when you are making a reasonable profit. You can also use colour to highlight gilts that have been held over one year, so that a tax free

profit can be taken.

We will now complete page 1 with statistics that can be used to ensure that we maintain a balanced portfolio.

The reference numbers given will of course be for this particular portfolio. But it will act as a guide for your own sheet. On your sample sheet enter the following formulas:-

Total cost of shares SUM(D6:D15)
 Total cost of gilts SUM(D16:D18)
 Total cost of Investments.....D20+D21
 Present value of shares SUM(F6:F15)
 Present value of gilts..... SUM(F16:F18)
 Total inventory valueD23+D24
 Profit on shares D23-D20
 Profit on gilts D24-D21
 Total profitD26+D27
 Percentage profit gilts D27/D21*100
 Percentage profit shares... D26/D20*100
 Total profit percentage.... D28/D22*100
 Percentage of change of FT.....
 (C2-C32)/C32*100
 Percentage of total gilts D24/D25*100
 Percentage of total equity.....
 D23/D25*100

PAGE 1								
DATE	MAR2ND85	F/T	ALL SHARE	\$EXCH.RATE	H59	PROF	MAR85	H35
DOW	1299.36	975.00	605.82	1.08				
SHARE	NUMBER	UNIT COST	T/COST	UNIT VAL.	TOTAL VAL	PROFIT	PROFIT%	
EMF(CRES)	1700.00	0.63	1077.84	181.50	3085.50	2007.66	186.27	
MG JAP S/C	3030.00	0.50	1500.00	65.80	1993.74	493.74	32.92	
GEC	1000.00	1.99	1994.07	198.00	1980.00	-14.07	-.07	
MARSHALL	2000.00	0.38	757.89	38.00	760.00	2.11	.28	
JARDINE(ER	2023.00	0.94	1894.51	121.00	2447.83	553.32	29.21	
UNISON TEC	2500.00	0.11	268.08	40.00	1000.00	731.92	273.02	
BRITOL	500.00	1.83	915.00	205.00	1025.00	110.00	12.02	
H&S BANK	2500.00	0.65	1622.20	104.00	2600.00	977.80	60.28	
SONY	330.00	7.86	2594.47	18.75	5742.46	3147.99	121.33	
STD OIL	75.00	21.24	1592.77	62.75	4367.75	2774.98	174.22	
TRES2%IL88	19757.74	1.03	20359.61	110.13	21758.21	1398.60	6.87	
6%FUND1993	36800.00	0.69	25494.41	76.88	28290.00	2795.59	10.97	
TRE5%86/89	23097.98	0.80	18381.38	81.63	18853.73	472.35	2.97	
TOTAL COST OF SHARES.....			14216.83					
TOTAL COST OF GILTS			64235.40					
TOTAL COST INVESTMENTS.....			78452.23					
PRESENT VALUE SHARES.....			25002.28					
PRESENT VALUE GILTS			68901.94					
TOTAL INV. VALUE.....			93904.22					
PROFIT ON SHARES			10785.45					
PROFIT ON GILTS			4666.54					
TOTAL PROFIT.....			15451.99					
PERCENTAGE ON GILTS PROFIT			7.26					PERCENTAGE VALUES.
PERCENTAGE ON SHARES PROFIT...			75.86					%IN GILTS 73.37
TOTAL PERCENTAGE....PROFIT			19.70					%IN EQUITY 26.63
F/T 5TH APRIL 1984			865.40					
PERCENTAGE OF CHANGE OF F/T...			12.66					

SPREADSHEETS

At this stage I must make it clear that the sheet can be constructed with a very simple, low cost spreadsheet on almost any computer. The only formula that may require alteration are those starting with "SUM". Reference to the manual will soon solve the problem. The method described in detail only applies to "CALC RESULT".

Sold Investments

In compiling this sheet Page 2, you must use a spreadsheet capable of handling the formula mentioned in an earlier paragraph.

The first part of this sheet is a record of all investments sold in this financial year. The formula will be the same as that used on Page 1. Profit is now calculated after all expenses and is given in row 14.

In order to simplify the tax calculations, the example is for a married man over 65, with no dependents. The only income is from investments and pensions. Once the principles are grasped, the sheet can be simply adapted for your own particular circumstances.

The first tax calculation is for capital gains tax. Enter this year's allowance of

5600 and the rate at 30%. Now enter the following formula:-

Amount below allowance.....
IF F14<C16THENF14-C16ELSE0
 Rate subject CGT.....
IF F14<C16THEN0ELSEF14-C16
 CGT E18*B18

Gilts held over twelve months are not subject to capital gains tax, so they must be entered in a separate section. Use the formula as outlined in Page 1. Then enter the following:-

Gains before CGT.....F14+F23
 CGT before indexation.....G18
 After Tax Gains G25-G26
 % after Tax GainsG27/C26*100
 Income C/F..... B43
 Age Allowance
 IF B43 > B48THEN0ELSEB45-B49*.6667
 Married Man Personal.....
IF B43<B48THEN0ELSEB46
 Taxable Income..... E30-(E31 + E32)
 Gross Income SUM(B32:B37)
 After Deductions.....B39-B41
 Over FringeIF B47THENB43-B47ELSE0

Under Income Tax Enter:-

IF E34<=D37THENE34*E37ELSED37*E37
 IF G37-D38>0THEND38*E38ELSEG37*E38
 IF G38-D39>0THEND39*E39ELSEG38*E39
 IF G39-D40>0THEND40*E40ELSEG39*E40
 IF G40-D41>0THEND41*E41ELSEG40*E41
 G41*E42

Total Income Tax.....SUM(F37:F42)
 Capital Gains TaxG18
 Total TaxF44+F46

In the column headed "Subject To Higher Tax" enter the following:-

IF E34-D37>0THENE34-D37ELSE0
 IF G37-D38>0THENG37-D38ELSE0
 IF G38-D39>0THENG38-D38ELSE0
 IF G39-D40>0THENG39-D40ELSE0
 IF G40-D41>0THENG40-D41ELSE0

The various allowances are entered from Tax Tables. These can be obtained from your tax office or any of the many tax books published every year. The sheet is updated at the beginning of the tax year, by reference to the newspaper the day following the budget.

Care must be taken to ensure that every entry is made in the same cell as shown in the example sheet. As a final check Page 1 uses ROWS 1 to 35 and

THE COMPUTER SHOP ON

VIATEL

CLEMENS M. COMPUTERS

TROPICAL ARCADE, CAIRNS

070 51 5600

PHONE NOW FOR VIATEL MODEM SPECIALS!

UPGRADE YOUR COMMODORE 64 & 1541 SYSTEM WITH COCKROACH PRODUCTS

TURBO-ROM PRICE: \$42 (inc. postage etc.)
 Cockroach has replaced the cassette and RS232 in the normal ROM with more useful code for the 1541 disk user. (A switch is provided to return to normal ROM should you need to load from cassette or use a modem.)

1. FAST LOAD—The COCKROACH TURBO-ROM will load virtually ALL commercial software with speed improvements up to 600% (NOTE: Improvement varies from program to program.)
2. DOS WEDGE—@ to read error channel. @ \$ to list directory to screen (without disturbing memory).
3. FAST FORMAT built-in—The command @ F.NAME, ID will format (with verification) a disk in 30 secs (about 3 times normal speed).
4. SCREEN DUMP—The Commodore/F7 combination gives a screen dump to the printer even whilst program is running.
5. FAST SAVE—Save three times faster (verified).
6. Extra commands in immediate mode:-
 ZAP—Cold start
 OLD—Recover Basic program after NEW or cold start.
 MON—Jump to monitor if in memory. (MONAD but can be customised).
 SCREEN COLOURS & MESSAGE may also be customised if required. (\$5 extra)

COCKROACH TURBO-ROM is a single chip (with an attached switch) which plugs into the socket presently occupied by your KERNAL ROM.

WRITE LIGHT KIT PRICE: \$17 (includes postage etc.)
 See and hear when the drive is actually writing to a disk. No more twiddling your thumbs wondering if it has hung up!
 Requires some expertise with a soldering iron (9 solder joints).

TRACK GAUGE PRICE: \$18 (includes postage etc.)
 See instantly which track (or half track) is being read or written to. Requires some mechanical knowhow.

TURBO-64 UTILITIES DISK PRICE: \$22 (includes postage etc.)
 For owners of our acclaimed TURBO-64 EDITOR. The utilities disk provides:-

1. TURBO-64 file copy onto standard disk.
2. AUTOMATIC MULTI LOADER
3. FAST NEW of TURBO-64 disk
4. FULL STATUS SCREEN of each TURBO-64 program. Or dump to printer
5. SCREEN EDITOR—Change any item on TURBO-64 menu screen

TURBO-FAN PRICE: \$45 (includes postage etc.)
 This is a cooling fan which simply clips to the top of your disk drive and extracts the hot air—preventing premature failure due to overheating. A must for schools, etc.

ALSO AVAILABLE:
 TURBO-64—FAST LOAD SYSTEM \$47 (including postage)
 TURBO-ROACH—Three minute backup for unprotected disks \$37 (inc. postage etc.)
 TURBO-64 LABELS \$2.50 per pack (20) including postage.

COCKROACH SOFTWARE, P.O. BOX 1154, SOUTHPORT, 4215
 Telephone: (075) 32 5133 A/H (075) 32 4028

SPREADSHEETS

Page 2 ROWS 1 to 49, both sheets use columns A to H.

A number of interesting and profitable exercises can now be carried out by altering income and capital gains figures and seeing the effect it could make to your tax bill.

Conclusions

In order to give CALC RESULT a severe test and to produce something useful, I have included a large amount of formula. It has been very difficult for me to fault the program, I even did a number of silly things, but it is so "user friendly" that the error messages soon put me right.

The only fault I could find, was that the saving and loading routine is rather slow. But this may not be entirely the fault of the program, as the CBM64 disk unit is not very fast. One of the reasons for the time taken in saving is that everything goes through the work disk and then onto the data disk. This does, however, save some time, as when you switch on the computer, with the cartridge inserted, the worksheet is displayed as it was when you switched off, without having to press any keys. The system also safeguards your work and provides more memory.

Using a computer to monitor my investments has resulted in very good profits over the last seven years. It could do the same for you.

Page 2

SOLD84/85 DATE 19/1/85 PRESS REPLICATE 3 TIMES.

COMPANY	NUMBER	COST	UNIT COST	TOTAL SALE	PROF/LOSS	%PROF/LOSS
DIPLOMA	500.00	55.00	0.11	2633.46	2578.46	4688.11
BP	2000.00	8700.00	4.35	10200.00	1500.00	17.24
STERLING	2000.00	649.00	0.32	1225.98	576.98	88.90
BRIT/TEL	800.00	400.00	0.50	737.44	337.44	84.36
BRIT/TEL	800.00	400.00	0.50	784.00	384.00	96.00
JAGUAR	500.00	825.00	1.65	1121.40	296.40	35.93
EXCO	500.00	2470.00	4.94	3074.93	604.93	24.49
		13499.00		19777.21	6278.21	46.51

CGT ALLOWANCE.....	5600	AMOUNT BELOW ALLOW.	0
TAX RATE..	0.3	GAIN SUBJECT CGT....	678.21
		CGT.....	203.463

COMPANY	NUMBER	COST	UNIT COST	TOTAL SALE	PROF/LOSS	%PROF/LOSS
TRES12/86	17117.00	15000.00	0.88	18381.36	3381.36	22.54
TOTAL SALE		38158.57	GAINS BEFORE CGT....		9659.57	
TOTAL COST		28499.00	TAX BEFORE INDEXATION		203.46	
GROSS GAIN		9659.57	AFTER TAX GAINS.....		9456.11	
% GAIN		33.89	% AFTER TAX GAIN....		33.18	

GROSS INCOME		INCOME C/F		TAX RATE		INCOME TAX		SUBJECT TO HIGHER TAX	
NORWICH...	779.52	AGE ALLOWAN	0.00						
HAMBRO....	231.68	PERSONAL..	3155.00						
PENSION...	2836.60	TAXABLE..	6900.29						
UK BANK 84	724.77								
\$ BANK 84.	318.12	TAX BRACKETS :-							
DIVIDENDS.	5164.60	LESS THAN	15400.00	0.30	2070.09	0.00			
GROSS INCOM	10055.29	NEXT	2800.00	0.40	0.00	0.00			
DEDUCTIONS	0.00	NEXT	4900.00	0.45	0.00	0.00			
AFTER DED.	10055.29	NEXT	7500.00	0.50	0.00	0.00			
AGE ALLOW.	3955.00	NEXT	7500.00	0.55	0.00	0.00			
PERSONAL..	3155.00	ALL ABOVE	38100.00	0.60	0.00	0.00			
FRINGE..	8100.00	TOTAL INCOME TAX....			2070.09				
TOP LEVEL	9300.00	CAPITAL GAINS TAX C/F			213.99				
OVER FRINGE	1955.29	TOTAL TAX .			2284.08				

New Avtek MultiModem II

Australia's top selling modem is now 5 ways better

1. Fully Viatel compatible.

Multimodem provides the 1200/75 baud rate necessary for Viatel and the new generation of high speed databases.

With Multimodem you won't be left out in the cold.

2. Fully integrated baud rate convertor (optional).

Multimodem II provides 1200/75 baud communications for computers such as Commodore, IBM, Osborne, Kaypro and Microbee which do not support split baud rate as they stand.

Note: in order to operate on Viatel you will need special software. Avtek can supply software for a number of machines. For other machines, please contact your dealer directly.

3. Internal expansion buss. A Multimodem first. As developments come along, Multimodem will handle them.

4. Auto answer facility is a true 'ring detect' circuit.

Multimodem II can actually sense an incoming call and respond immediately.

It is completely independent of the strength of the ring voltage.

5. Interfacing is easy.

Multimodem now provides front and back channels that are fully integrated.

No need for special cables when using 1200/75 and other split baud rates.

And Multimodem II still incorporates all the features that have made it Australia's first choice.

1. Advanced digital filtering and signal processing.

Multimodem II provides the highest standards of data integrity. You will get reliable data transfer on lines where other modems simply cannot function.

2. Multimodem never requires adjustment.

Complex

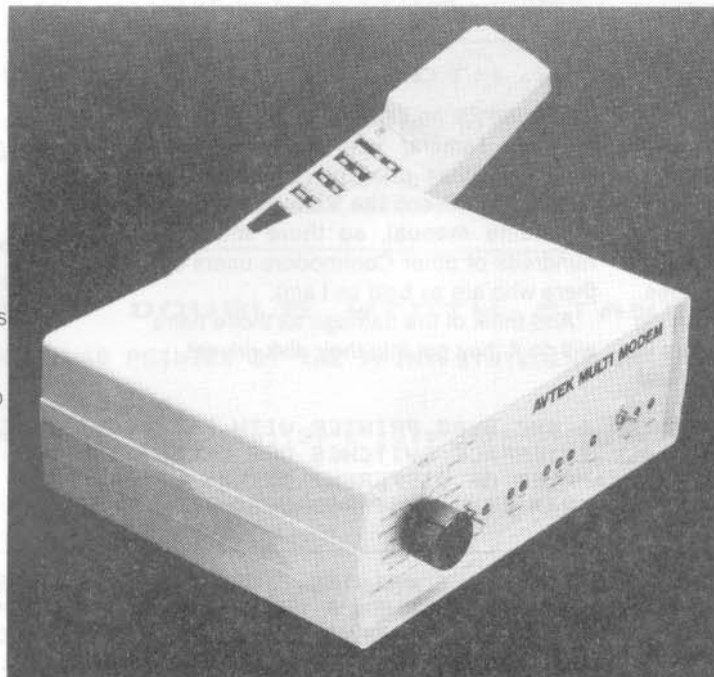

modulation, demodulation and filtering are performed by crystal locked filters. Critical analogue adjustments give way to crystal locked precision.

3. Australian and US standards at the flick of a switch. CCITT and Bell standards let you talk to any database or other computer in the world.

4. Full Analog and digital loopback facilities. Fast testing of line, computer, cabling and modem.

Multimodem II **\$365.00**

Multimodem II inc. auto answer **\$399.00**
 Multimodem II inc. auto answer plus baud rate convertor **\$485.00**

Minimodem II.

New improved version of the famous Minimodem provides the reliability and digital filtering of the

Multimodem. Features include:

Now provides Viatel (1200/75 baud rate) and 300/300 full duplex as standard.



Commodore VIC 20 and 64 version now available. These plug directly into the user port. No need to buy expensive RS232 adaptors.

Can be powered by the computer directly (for example MicroBee and Commodore).

On 1200 baud (e.g. Viatel) special equalisation is available for improved results on poor phone lines.

Minimodem inc. power supply **\$199.00**
 Minimodem (suit Commodore user port) **\$235.00**

Brilliant New Software for Viatel

Avtek brings you brilliant software at reasonable prices:

For IBM PC (and compatibles), NEC III, Apricot, Sanyo MB550 and 555, Wang PC and TI Professional.

Black and White **\$169**
 Colour **\$275**

Better Viatel for the MicroBee

There are other Viatel modifications for the Bee, but they are hardware/software modifications and they are a compromise.

Our software is undoubtedly the fastest and easiest way to put your MicroBee on Viatel. Written by Conal Walsh, famous MicroBee software developer, it provides superb, fast, Viatel access on your MicroBee without the need for messy hardware modifications.

MicroBee Viatel Software **\$49.50**
 3.5" or 5¼" format, please specify

Modem Cables

1.8 metre male to male **\$35.00**

1.8 metre male to female (suit IBM etc) **\$35.00**

Cables are also available to suit most other non standard RS232 ports (e.g. Macintosh) ring for details **\$45.00**

AVTEK

Electronics Pty Ltd
 Phone (02) 427 6688
 for the name of our dealer nearest you.
 Or write to us for further details at: **PO Box 651 Lane Cove NSW 2066**

Commodore 64 Printcodes

by Michael Noblet

"Commodore 64 Printcodes" was produced by a program I have written to illustrate how to achieve various modes of printing on a BMC BX80 printer with a Xetec Graphics Printer Interface. The program is 20 blocks long and the printout of it takes just under 2 A4 pages.

I found myself tearing my hair out trying to understand the manual as it appears to have been written in Japanese and

translated by an illiterate academic who is more familiar with Swahili than English. Other printers (including the AMUST DT80 and the VIZA use exactly the same manual, so there must be hundreds of other Commodore users out there who are as bald as I am).

And think of the damage all those hairs will do if they get into their disk drives!



PRINTED ON A BMC BX80 PRINTER WITH XETEC GPI INTERFACE
(ALL INTERFACE SWITCHES OFF EXCEPT 2 & 3)

THIS PRINTOUT GIVES EXAMPLES OF DIFFERENT STYLES OF PRINTING THEN LISTS THE PROGRAM LINE THAT PRODUCED THE EXAMPLE.

NOTE THE USE OF THREE FILES TO THE PRINTER. THE SECONDARY ADDRESS 4 ON FILE #2 MEANS THE INTERFACE IS TRANSPARENT WHEN A PRINT COMMAND IS SENT ON THAT FILE. FILE #3 SETS UP A COMMAND CHANNEL TO SEND SPECIAL INTERFACE COMMANDS. PRINT STATEMENTS HAVE BEEN ABBREVIATED BY USING THE VARIABLES IN LINES 40-80:

```
30 OPEN1,4:OPEN2,4,4:OPEN3,4,15
40 E$=CHR$(27):Y$=CHR$(1):N$=CHR$(0):DY$=CHR$(14):DN$=CHR$(15):CN$=CHR$(18)
50 P$="THE EXAMPLE ABOVE WAS PRINTED BY THE PRINT STATEMENT IN THIS LINE:"
60 T$="THIS IS AN EXAMPLE OF ";S$="STANDARD PRINT":I$="ITALIC PRINT"
70 X$="XETEC PRINT":Q$=CHR$(34)
80 PT$="THE EXAMPLES ABOVE WERE PRINTED BY THESE LINES:"
```

THIS IS AN EXAMPLE OF STANDARD PRINT

THE EXAMPLE ABOVE WAS PRINTED BY THE PRINT STATEMENT IN THIS LINE:

```
310 GOSUB 3000:PRINT#1,T$;S$
```

THIS IS AN EXAMPLE OF UNDERLINED STANDARD PRINT

THE EXAMPLE ABOVE WAS PRINTED BY THE PRINT STATEMENT IN THIS LINE:

```
330 GOSUB 3000:PRINT#1,T$;E$-"Y$;"UNDERLINED ";S$;E$-"N$
```

THIS IS AN EXAMPLE OF ~~REVERSED STANDARD PRINT~~

THE EXAMPLE ABOVE WAS PRINTED BY THE PRINT STATEMENT IN THIS LINE:

```
350 GOSUB 3000:PRINT#1,T$[RVON]REVERSED ";S$;"[RVOF]"
```

THIS IS AN EXAMPLE OF EMPHASISED STANDARD PRINT

THE EXAMPLE ABOVE WAS PRINTED BY THE PRINT STATEMENT IN THIS LINE:

```
370 GOSUB 3000:PRINT#1,T$;E$"E";"EMPHASISED ";S$;E$"F"
```

THIS IS AN EXAMPLE OF DOUBLE WIDTH STANDARD PRINT

THE EXAMPLE ABOVE WAS PRINTED BY THE PRINT STATEMENT IN THIS LINE:

```
390 GOSUB 3000:PRINT#1,T$;DY$"DOUBLE WIDTH ";S$;DN$
```

THIS IS AN EXAMPLE OF

EMPHASISED DOUBLE WIDTH STANDARD PRINT

THE EXAMPLE ABOVE WAS PRINTED BY THE PRINT STATEMENT IN THIS LINE:

```
410 GOSUB3000:PRINT#1,T$:PRINT#1,E$"E";DY$"EMPHASISED DOUBLE WIDTH ";S$;DN$;E$"F"
```

THIS IS AN EXAMPLE OF CONDENSED STANDARD PRINT

THE EXAMPLE ABOVE WAS PRINTED BY THE PRINT STATEMENT IN THIS LINE:

```
430 GOSUB 3000:PRINT#2,T$;DN$"CONDENSED ";S$;CN$
```

THIS IS AN EXAMPLE OF

EMPHASISED ENLARGED CONDENSED STANDARD PRINT

THE EXAMPLE ABOVE WAS PRINTED BY THE PRINT STATEMENT IN THIS LINE:

```
460 PRINT#1,E$"E";"EMPHASISED ";E$"F";DY$"ENLARGED "DN$;:PRINT#2,DN$"CONDENSED "
CN$;S$
```

THIS IS AN EXAMPLE OF *ITALIC PRINT*

THE EXAMPLE ABOVE WAS PRINTED BY THE PRINT STATEMENT IN THIS LINE:

```
480 GOSUB 3000:PRINT#1,T$;E$"4";I$;E$"5"
```

THIS IS AN EXAMPLE OF *UNDERLINED ITALIC PRINT*

THE EXAMPLE ABOVE WAS PRINTED BY THE PRINT STATEMENT IN THIS LINE:

```
500 GOSUB 3000:PRINT#1,T$;E$"4";E$"-Y$;"UNDERLINED ";I$;E$"-N$;E$"5"
```

NOTE THAT IT DOES NOT SEEM POSSIBLE TO PRINT REVERSED ITALICS.

PROGRAMMING

THIS IS AN EXAMPLE OF *EMPHASISED ITALIC PRINT*

THE EXAMPLE ABOVE WAS PRINTED BY THE PRINT STATEMENT IN THIS LINE:

```
540 GOSUB 3000:PRINT#1,T$;E$"4";E$"E";"EMPHASISED ";I$;E$"F";E$"5"
```

THIS IS AN EXAMPLE OF *DOUBLE WIDTH ITALIC PRINT*

THE EXAMPLE ABOVE WAS PRINTED BY THE PRINT STATEMENT IN THIS LINE:

```
560 GOSUB 3000:PRINT#1,T$;E$"4";DY$"DOUBLE WIDTH ";I$;DN$;E$"5"
```

THIS IS AN EXAMPLE OF

EMPHASISED DOUBLE WIDTH ITALIC PRINT

THE EXAMPLE ABOVE WAS PRINTED BY THE PRINT STATEMENT IN THIS LINE:

```
590 PRINT#1,E$"4";E$"E";DY$"EMPHASISED DOUBLE WIDTH ";I$;DN$;E$"F";E$"5"
```

THIS IS AN EXAMPLE OF *CONDENSED ITALIC PRINT*

THE EXAMPLE ABOVE WAS PRINTED BY THE PRINT STATEMENT IN THIS LINE:

```
610 GOSUB 3000:PRINT#2,T$;E$"4";DN$"CONDENSED ";I$;CN$;E$"5"
```

THIS IS AN EXAMPLE OF

EMPHASISED ENLARGED CONDENSED ITALIC PRINT

THE EXAMPLES ABOVE WERE PRINTED BY THESE LINES:

```
640 PRINT#1,E$"4";E$"E";"EMPHASISED ";E$"F";DY$"ENLARGED "DN$;  
650 PRINT#2,DN$"CONDENSED "CN$;I$;E$"5"
```

IT IS ALSO POSSIBLE TO USE THE INTERNAL CHARACTER GENERATOR IN THE XETEC INTERFACE TO PRINT ANOTHER VERSION OF STANDARD AND DOUBLE WIDTH PRINT.

THE COMMANDS "IY" AND "IN" ARE SENT ON THE COMMAND CHANNEL TO TURN THIS MODE ON AND OFF RESPECTIVELY.

THIS IS AN EXAMPLE OF XETEC PRINT FROM THE INTERFACE

THE EXAMPLE ABOVE WAS PRINTED BY THE PRINT STATEMENT IN THIS LINE:

```
730 GOSUB3000:PRINT#1,T$;:PRINT#3,"IY";:PRINT#1,X$;" FROM THE INTERFACE";:PRINT#  
3,"IN"
```

THIS IS AN EXAMPLE OF

ENLARGED XETEC PRINT FROM THE INTERFACE

THE EXAMPLE ABOVE WAS PRINTED BY THE PRINT STATEMENT IN THIS LINE:

```
760 PRINT#3,"IY":PRINT#1,DY$"ENLARGED "X$" FROM THE INTERFACE"DN$:PRINT#3,"IN"
```

THIS IS AN EXAMPLE OF **SUPERSCRIPT** - USEFUL FOR FORMULAE LIKE $E=MC^2$

THE EXAMPLES ABOVE WERE PRINTED BY THESE LINES:

```
780 GOSUB 3000:PRINT#1,T$;:PRINT#1,E$"S"N$"SUPERSCRIPT"E$H";
790 PRINT#1," - USEFUL FOR FORMULAE LIKE E=MC";E$"S"N$2"E$H"
```

THIS IS AN EXAMPLE OF **SUBSCRIPT** - USEFUL FOR CHEMICAL NAMES LIKE H_2SO_4

THE EXAMPLES ABOVE WERE PRINTED BY THESE LINES:

```
810 GOSUB 3000:PRINT#1,T$;E$"S"Y$;"SUBSCRIPT";E$H";" - USEFUL FOR CHEMICAL ";
820 PRINT#1,"NAMES LIKE H";E$"S"Y$;"2";E$H";"SO";E$"S"Y$;"4";E$H"
```

this is an example of standard print

the example above was printed by the print statement in this line:

```
310 gosub 3000:print#1,t$;s$
```

this is an example of underlined standard print

the example above was printed by the print statement in this line:

```
330 gosub 3000:print#1,t$;e$"-y$;"underlined ";s$;e$"-n$
```

this is an example of ~~XXXXXXXXXXXXXXXXXXXX~~

the example above was printed by the print statement in this line:

```
350 gosub 3000:print#1,t$[RVON]reversed ";s$;[RVOF]"
```

this is an example of emphasised standard print

the example above was printed by the print statement in this line:

```
370 gosub 3000:print#1,t$;e$"e$;"emphasised ";s$;e$"f"
```

this is an example of double width standard print

the example above was printed by the print statement in this line:

```
390 gosub 3000:print#1,t$;dy$"double width ";s$;dn$
```

this is an example of

emphasised double width standard print

the example above was printed by the print statement in this line:

```
410 gosub3000:print#1,t$:print#1,e$"e$";dy$"emphasised double width ";s$;dn$;e$"f"
```

THIS IS AN EXAMPLE OF CONDENSED STANDARD PRINT

the example above was printed by the print statement in this line:

```
430 gosub 3000:print#2,t$;dn$"condensed ";s$;cn$
```

this is an example of
emphasised enlarged CONDENSED STANDARD PRINT

the example above was printed by the print statement in this line:

```
460 print#1,e$"e";"emphasised ";e$"f";dy$"enlarged "dn$;:print#2,dn$"condensed "  
cn$;s$
```

this is an example of *italic print*

the example above was printed by the print statement in this line:

```
480 gosub 3000:print#1,t$;e$"4";i$;e$"5"
```

this is an example of *underlined italic print*

the example above was printed by the print statement in this line:

```
500 gosub 3000:print#1,t$;e$"4";e$-"y$;"underlined ";i$;e$-"n$;e$"5"
```

note that it does not seem possible to print reversed italics.

this is an example of *emphasised italic print*

the example above was printed by the print statement in this line:

```
540 gosub 3000:print#1,t$;e$"4";e$"e";"emphasised ";i$;e$"f";e$"5"
```

this is an example of *double width italic print*

the example above was printed by the print statement in this line:

```
560 gosub 3000:print#1,t$;e$"4";dy$"double width ";i$;dn$;e$"5"
```

this is an example of
emphasised double width italic print

the example above was printed by the print statement in this line:

```
590 print#1,e$"4";e$"e";dy$"emphasised double width ";i$;dn$;e$"f";e$"5"
```

PROGRAMMING

THIS IS AN EXAMPLE OF *CONDENSED ITALIC PRINT*

the example above was printed by the print statement in this line:

```
610 gosub 3000:print#2,t$;e$"4";dn$"condensed ";i$;cn$;e$"5"
```

this is an example of
emphasised enlarged CONDENSED ITALIC PRINT

the examples above were printed by these lines:

```
640 print#1,e$"4";e$"e";"emphasised ";e$"f";dy$"enlarged "dn$;  
650 print#2,dn$"condensed "cn$;i$;e$"5"
```

it is also possible to use the internal character generator in the xetec interface to print another version of standard and double width print.

the commands "iy" and "in" are sent on the command channel to turn this mode on and off respectively.

this is an example of xetec Print from the interface
the example above was printed by the print statement in this line:

```
730 gosub3000:print#1,t$;:print#3,"iy";:print#1,x$;" from the interface";:print#  
3,"in"
```

SCREENPLAY

BITMAPPER II

SCREEN PLAY present a remarkable piece of software to benefit owners of 802, 1526 or MCS 801 printers ...

BITMAPPER II.

BITMAPPER II allows owners of these printers to get print outs of HIGH RES pictures designed on either BITMAPPER II or on many other programs.

BITMAPPER II offers these facilities:

It allows you to draw high resolution pictures on your screen using LIGHT PEN, JOYSTICK or KOALA PAD.

You can easily use text (normal or double sized) on your picture. BITMAPPER II even allows the use of redefined characters to aid in your picture design!

Pictures created on BITMAPPER II can be saved onto disk for later use or change.

File support (included with BITMAPPER II) allows you to use high resolution pictures from other programs with BITMAPPER II and then print them onto paper! (as long as the picture is saved to disk as a sequential file).

The best feature of BITMAPPER II is its ability to allow 802 and 1526 printers to perform as graphics printers!

BITMAPPER !! is available for your Commodore 64 on diskette only and is priced at \$34.95.

Order your copy from SCREENPLAY Computer Software

52 Queen Street, Norwood
SA 5067 or phone (08) 315501
Price includes postage

**BACK ISSUES
of The Australian
Commodore Review
are available for \$2
each as follows:**

**Vol 1 Nos 1 to 5
and 7 to 9**

Vol 2 Nos 1 to 4

**Write to us saying
which issues you want
and enclosing a
cheque, and we will
post them back to you
by return.**

**For enquiries ring Tina
Spathos on
(02) 398 5111.**

**The Australian Commodore
Review,
Top Rear, 4 Carrington Road,
Randwick, 2031**

ADVENTURERS' CORNER

Adventurers' Corner

Dear ACR,

Currently I am playing *Entombed* and I am having a great deal of trouble finding the TORCH. I have enlisted the help of some of my friends to try something I may not have thought of but I am still "In the Dark". I have tried for about 4-5 hours to no avail. Please help, I haven't much hair left!

Enclosed is a map covering all rooms up to where I am stuck. I haven't enclosed the details of how to pass through each room as I think you are smart enough to find out rather easily. If not, give me a ring on 080 4647.

Yours faithfully
Richard McMahon

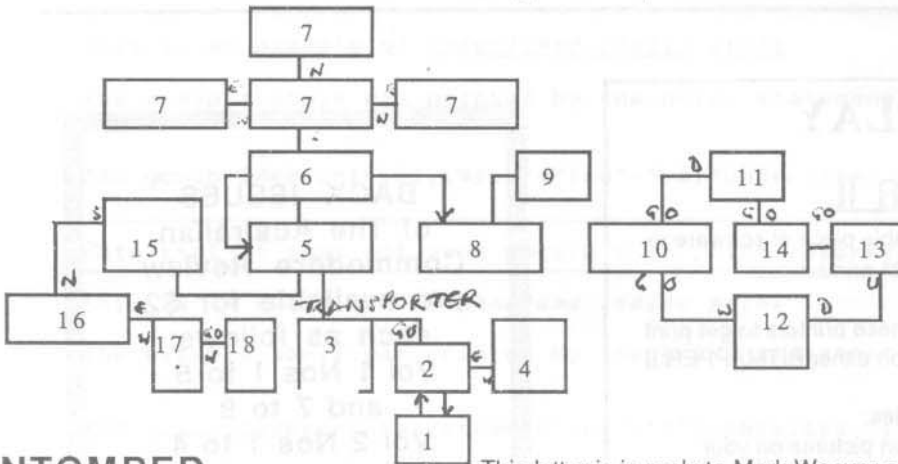

ENTOMBED

From Whip:-

Right, Up, Right, BUG ROOM EXIT,
Left, Right, Up, Right, Forward, Right,
SNAKE ROOM with Puzzle-

With a whip a note shall chime
And you will find & light to shine!

Left, Left, Right, Forward, Right, BULL
ROOM EXIT, Right, MUMMIES ROOM
with bowl of fruit, Left, Forward, Right,
IDOL ROOM, Left, Left, STATUE ROOM
EXIT, Right, Forward, Right, BIRD ROOM
with Puzzle-

To free the mummy of it's curse
Find the Knot of Isis first

Right, INSECT ROOM with puzzle-

A room of Pools ye shall get Past
When each in order stand thee hast

Right, Forward, Right, GHOST ROOM
?, Right, Forward, Right, BOLDER ROOM
EXIT, Left, Forward, Right, BEATLE
ROOM ?, Right, Forward, Right, 3 POOL
ROOM EXIT, Right, Up, Right, DARK
SNAKE ROOM, Left, Right, Keep Right
(or Up to STATUE ROOM with Knot of
Isis), Forward, Right, MAZE OF
INVISIBILITY with Puzzle -

The Cobra guards the way ahead
But it doth fear a book that's dead!

Left from maze, Not Forward, Keep Left,
Not Up, Forward, COBRA ROOM EXIT.

GO BRIDGE
SOUTH
GET MOUSE
NORTH
WEST
REMOVE CLOAK
THROW CLOAK
GO GATE
WATER PLANT
FILL JAR (IF JAM JAR DOESN'T FILL
RETURN TO POND)
WATER PLANT
GET CLOAK
CLIMB BEANSTALK
DROP MOUSE
GO PATH
GO VALLEY
NORTH
THROW ROPE, CLIMB ROPE
GIVE DWARF CLOAK
TAKE BOX
DOWN
GET ROPE
SOUTH
EAST
GO HARBOUR
GO BOAT
LOOK BOAT
GO (CABIN)
GET (WHATEVER IS IN THERE)
GO HATCH
NORTH
GO ISLAND
LIGHT TORCH
GO HOLE
GET JACKET, UNLIGHT TORCH
UP

In the game there is an error so hit
RETURN then RUN/STOP real fast and
type the following
LO=46:X=27:GOTO9000 then return.
This should put you on the beach or into
the water. If you are in the water then
type "swim"

then continue with
GO FOREST
NORTH
EAST
CLIMB STATUE
GET DIAMOND
DOWN
(FIND A WALL)
INSERT DIAMOND
LIGHT TORCH
GO PASSAGE

This letter is in reply to Mark Weaver of
Tasmania who is having problems with an
adventure game called "Aztec Tomb".

Dear Mark,

I have played the adventure in question
and have completed it. I have typed the
necessary commands to complete the
adventure.

First go outside building
CLIMB BUILDING
GET WOOD
DOWN
SOUTH
DROP WOOD
(GO TO POND AND LOOK FISH)

ADVENTURERS' CORNER

LETTERS

Dear ACR,

Recently, I obtained the Scott Adams adventure, *Pirate Cove* for the VIC-20. Now I have finally completed the game, I thought you might like a map and suggestions, tips etc, for your *Adventurer's Corner*.

PS. Thanks for the great magazine

Pirate Cove - key to map

Area Objects to be found

1. Start : Crackers, Sneakers, Bottle, Rug, Nails, Keys.
2. Alcove : Book, Note, Flyer.
3. Window ledge : Nothing.
4. Attic : Bag, torch, Matches, Bottles.
5. Beach : Sand, Small ships keel and mast.
6. Lagoon : Anchor.
7. Ocean : Salt water, Fish.
8. Meadow : Mongoose.
9. Shack : Parrot, Chest.
10. Hill : Nothing.
11. Crack in rock: Nothing.
12. Caves : Nothing.
13. Pit : Crocodiles.
14. Cavern : Sails, Lumber.
 In Shed : Wings, Shovel, Hammer.
15. Beach : Bottles.
16. Graveyard: Bones, Bottles.
17. Field : Box, Stamps.
18. Monastery : Snakes, Dubloons.

Pirate Cove hints and tips

- * In area 1, only pick up the sneakers and bottle of rum. Go up the stairs.
- * In area 2, get a book and a secret door will open. In the book is a note and an advertisement. Only the book is necessary.
- * In area 3 it will be necessary to have sneakers on so you don't slip.
- * In area 4 you will find a bag which contains matches although this won't be so obvious at first. A torch is also there for when you get to areas 11-14. On your second visit, which will become necessary, to area 4 you will come

across an empty bottle and something else!

* Area 5 contains two things that are a must.

* Area 6 contains an anchor. Though you will need a shovel from area 14 to dig it out. It is an idea to wait till the tide goes out and to wear water wings (area 14) before getting the anchor.

* Area 7 is just ocean and more ocean! You will have to go back to the attic (4) to get a bottle. Go back to 7 and put salt water and a fish into the bottle to get past the crocodiles in 13.

* Q is a meadow. I wouldn't worry about the mongoose. If you send him after the snakes in 18 he won't turn out to be what you think he is!

* In 9 you will have to give the rum to the pirate in order to make him leave his chest. The keys to the chest are in 1, but you will have to go to 14 and in to the shed to get a hammer to undo the nails in the rug and underneath you will find the keys!

* In 10 you will find entrances to the caves.

* In 11 you will find a crack which leads into cavern. Go to the shed and get the hammer and water wings, go out the crack, deposit them, go back, get the sails and deposit them, after you have left of course.

* In 12 you will find a direction to go down. Having done this you will find yourself in a pit with some crocodiles. The only way to get past them is to give them the fish from 7. If you get the keys from 1 you will be able to unlock the door in the pit and get the shovel and lumber.

* Now that you have all the necessary items to build a ship you will need plans to build by. You will find plans and a map in the chest. When you build it you will need the following: the crackers (to keep the parrot with you), the parrot, the sneakers, the map, the shovel. Do not take the book otherwise the pirate on the ship will not let you go to Treasure Island. Type in SET SAIL and you are off to Treasure Island.

* In area 15 is a beach. If you dig here you will uncover some rum bottles. The Pirate will grab these and leave but will be found in area 16.



* Area 16 is a graveyard and nothing of interest is here. If you dig you will find some mouldy old bones. If you dig in 15 the pirate will be here. Wake him and he will go to the ship.

* 17 is a field. If you dig here you will find a box which contains stamps. Take the stamps.

* Area 18 is a monastery and contains dubloons and some deadly Mamba snakes. The only way to get rid of them is to give them the parrot which will attack the snakes and drive them off.

* Now that you've got the stamps and the dubloons, go back to the ship and SET SAIL. When you reach Pirate Island, get the book, say YOHO and you will arrive in 3. Go to 1 and deposit the two treasures (stamps and dubloons) and you will have completed the adventure!

Map Note:

Each time you leave the island you will arrive on 3 and each time you leave 3 you will arrive on 5.

GO means that the only way to get to that particular area is to use a GO statement.

Climb means what it says.

The letters N.S.E.W.U.D, mean of course, North, South, East, West, Up, Down. The letters at the end of each area mean that you can go that way.

Areas with an arrow mean that you can only go one way.

LETTERS

Letters

Yarra Valley
Commodore Users Group
PO Box 176
Lilydale Vic 3140

Dear Sir,

Recently, we have formed a user group in the Yarra Valley area of Melbourne. The group meets on the first Tuesday of each month at the Melba Hall, Cnr Market & Castella Streets, Lilydale at 8pm. The group is affiliated with the Melbourne Central Commodore Users Group. Enquiries can be directed to:-

Secretary Barrie Vickers 735-0638
Librarian Jon Hall 725-0176

Would you please include the group in your magazine's listing of user groups.

Yours faithfully
B.N Vickers
Secretary

Dear Editor,

Referring to Vol 1 No 4 of the Australian Commodore Review an article on a game program titled *Matrix* by Scott Wilcox appeared.

At the end of the article he (Scott) mentioned he would be interested to hear from anyone with *High Scores* on that program or any other program for the Commodore 64.

I am submitting two programs for possible publication, unfortunately they are not witnessed or timed for length of play. However if you require proof of scores I will be only too happy to send you a copy of the prog's with score on.

I can say without a doubt that they are 100% true and correct. The two prog's. are listed below:-

Lode Runner : -1,013,875
Oil's Well : - 167,270

As I plan to have another go at a later date I'll get a witness to be present while I

play as the high score can be verified as true and correct.

Yours sincerely
Malcolm Lennard

Ed: We believe you! Any contenders?

An advertisement this size in the **DEALER DIRECTORY** costs only \$45 per issue.

Dealer Directory

**Datapunch
Bureau Service**
6/168 Main Road
Blackwood, SA 5051
(08) 278 8662

The complete Commodore
supply and advice
service.

Specialists in software.

Womongong (042) 61 2307
Sydney (02) 456 2518
CHEAPEST PRICES AROUND
Computer paper, etc
Xidex floppy disks, Cassettes,
Printer Ribbons, Disk storage boxes,
XIDEX
Turning prices upside down
MAGNETIC MEDIA AND ACCESSORIES
MAGBOLO

COMPUTER WAVE

325 George Street Sydney
(02) 29 1631

for

PRINTERS-CABLES
EDUCATIONAL SOFTWARE
QUALITY GAMES
COMMUNICATIONS
EXPERTS

Commodore Makes Software For Every Member Of The Family.



Almost.

Commodore make software for people. All kinds of people. Software for fathers, mothers, brothers, sisters, uncles, aunts, nieces, nephews, grandparents and even brothers-in-law who fix cars. Everybody. Software for fun, profit, homework, housework and officework. We do not however, make software for dogs. Yes, we are working on it, but as research in this area is fairly limited, we're calling for all the help we can get. If you have any suggestions please contact your nearest Commodore dealer.

C **commodore**
COMPUTER

Keeping up with you.

Contact your nearest Commodore dealer or Commodore Business Machines:
Sydney:(02) 427 4888 Melbourne:(03) 429 9855 Brisbane:(07) 393 0300 Perth:(09) 389 1266

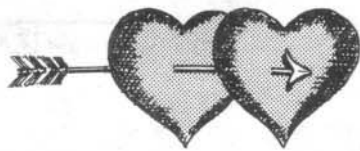

The perfect match...

COMMODORE RITEMAN

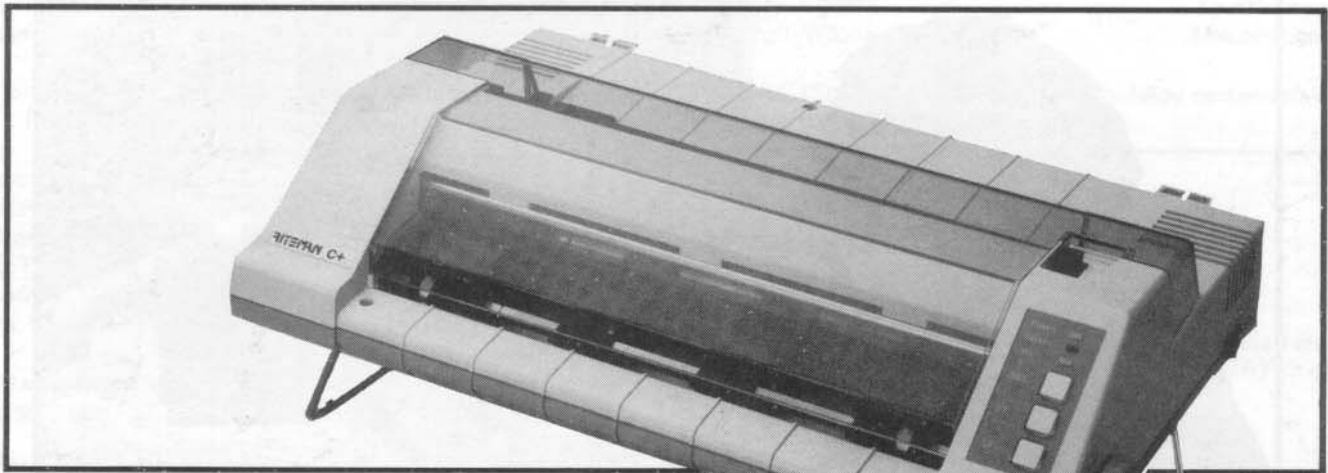

COMPARE THESE SPECS BEFORE YOU BUY...

FEATURES	RITEMAN C +	COMMODORE PRINTERS								
		MPS 801	MPS 802	MPS 803	VIC1525	VIC1526				
PRINT SPEED (CPS)	105	50	60	60	50	60				
BIDIRECTIONAL PRINT (COLUMN WIDTH)	YES	NO	YES	YES	NO	YES				
40 CHARACTERS PER LINE	YES	YES	YES	YES	YES	YES				
80 CHARACTERS PER LINE	YES	YES	YES	YES	YES	YES				
66 CHARACTERS PER LINE	YES	YES	YES	YES	YES	YES				
132 CHARACTERS PER LINE (PAPER HANDLING)	YES									
FRONT LOADING FOR EASY PAPER SETTINGS	YES	<h1>NO</h1>								
BUILT-IN PRINTER STAND	YES									
PRINT ON POST CARDS (SOFTWARE COMMANDS)	YES									
DOUBLE STRIKE	YES									
EMPHASIZED	YES									
COMPRESSED	YES									
UNDERLINE	YES									
SUPER/SUBSCRIPTS	YES									
ITALICS	YES									
DOUBLE DENSITY BIT IMAGE (CHARACTERS)	YES									
9X9 FONT	YES									
TRUE DESCENDERS	YES									
ITALICS	YES									
COMMODORE GRAPHICS (OTHER FEATURES)	YES						YES	YES	YES	YES
SINGLE DENSITY BIT IMAGE	YES						YES	NO	YES	YES
EXPANDED	YES	YES	YES	YES	YES	YES				
REVERSE	YES	YES	YES	YES	YES	YES				

Plug-compatible with Commodore* computers. 2 software built-in: Commodore* & Epson compatibility.**

If you own a Commodore computer...or are thinking about getting one...you're going to want the Riteman C+ dot matrix printer. You'll really appreciate that added convenience, versatility and economy. Its unique front loading design lets you use plain paper of any thickness, eliminates positioning and aligning problems and keeps continuous-feed paper away from entangling cables and connectors. Just compare the spec. table...complete with a built-in Commodore interface and all necessary cables and connectors...the Riteman C+ is the RIGHT printer for your Commodore system.

*Commodore is a registered trademark of Commodore Business Machines Inc.
**Epson is a registered trademark of Epson America Inc.

Distributed exclusively in Australia by:

anitech
A DIVISION OF THE ANI CORPORATION LTD (INC. IN N.S.W.)

ADELAIDE: (08) 356 7333 BRISBANE: (07) 275 1766
HOBART: (002) 34 4511 MELBOURNE: (03) 795 9011 & 795 5111
PERTH: (09) 277 7000 & 277 1944
SYDNEY: (02) 648 1711 & 648 4088 AUCKLAND: (09) 444 2645