

The Australian COMMODORE REVIEW

UTILITIES - programming tools working for a living



Freeze Frame Mk III
 Quickdisc+ II
 Dolphin Dos

Games:
 Titanic
 Leader Board
 Now Games
 Critical Mass

Registered by Australia Post, Publication No NBG 665
 *Recommended retail price

**AMIGA
SECTION**

BISSO

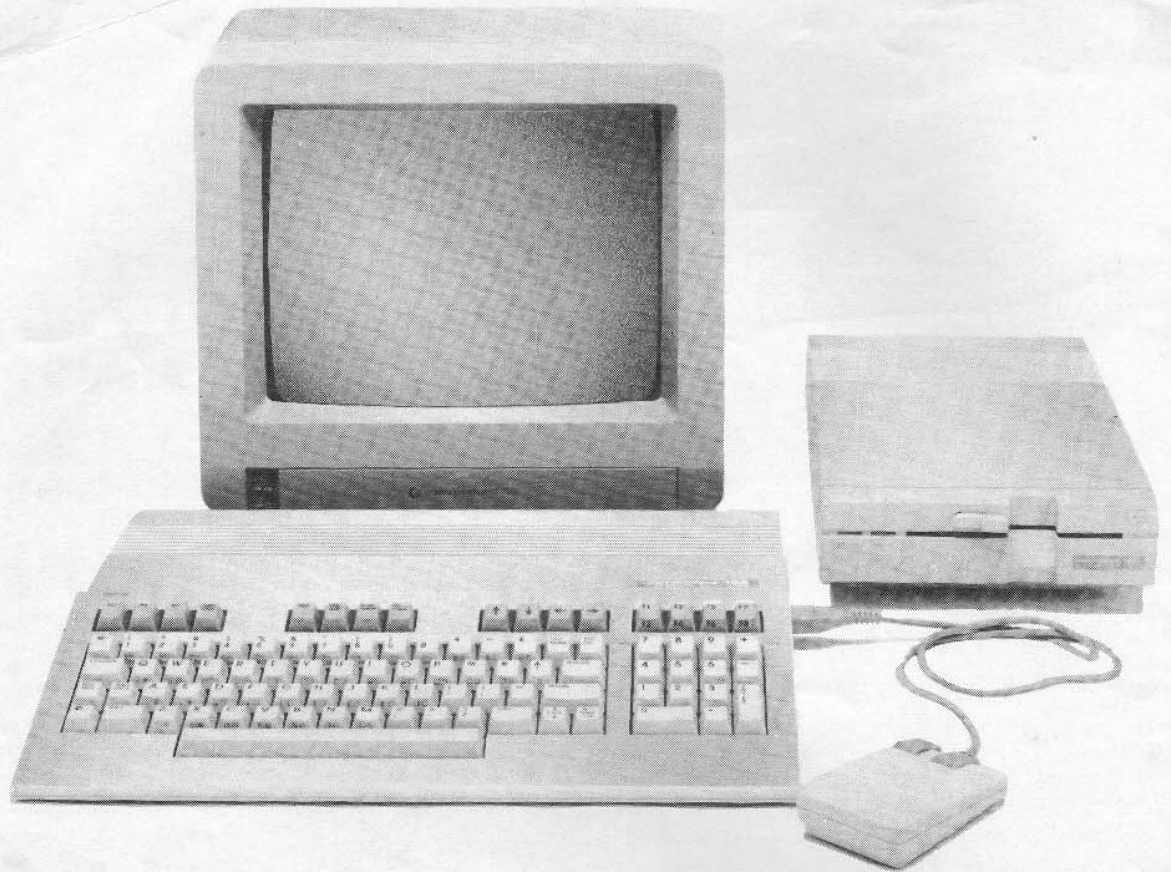

The Commodore 128

...so powerful, it's 3 computers in 1



It's a productivity computer!

The Commodore 128 will amaze you with its new generation of powerful yet easy to use productivity software. Like 'Jane', which allows you to follow simple symbols instead of typing complicated commands. And because it's so easy to learn, you'll have the 128 working hard in minutes! You get 128K of RAM both 40 and 80 column displays, and 16 colours for graphics.



It's a family and education computer!

Switch to Commodore 64 mode and you can use more than 3,000 software packages proven on the Commodore 64, The World's No. 1 selling computer. That's power – power for studying, word processing, education, home accounts, programming, fun and games and much, much more.



It's an advanced business computer!

The Commodore 128 lets you use software packages like 'Wordstar, dBase II and Supercalc', all in 80 columns. The Commodore 128 gives you all the computing power most businesses will ever need now or in the future.



Power without the price. \$699.

CONTENTS



The Australian Commodore Review

Vol 3 No 10

October 1986

FEATURES - UTILITIES

- Utilities* - Speedy program developers use a Toolkit - 4
- Which utility* - distributors, prices etc - 7
- Freeze Frame Mark III* - the best yet? - 8
- Quickdisc+ II* - latest of the fastload cartridges - 9
- Dolphin Dos* - Porsche performance - 10
- Capture Cartridge* - easy archiving and eprom burning - 24
- The Printer Connection* - firsthand user experience - 14

SOFTWARE REVIEWS

- Out-Think* - ideas processor for the 128 - 22

BOOK REVIEWS

- C-128 Programmers Reference Guide* - rush out and get it! - 13

PROGRAMMING

- 1520 Drawing Machine* - Superexpander for your 1520 printer/plotter - 43
- Scroll those Screens* - a fundamental games programming technique - 35 **24**

REGULAR APPEARANCES

Amiga Column

- Software Overview 16
- Beginners Guide to the Amiga 18
- Amiga Programmers Guide 20

- Ram Raumbings 3
- Adventurer's Realm 40

Letters 47

Hot Stuff

- Titanic 26
- Leader Board 27
- Now Games 29
- Critical Mass 32
- World's Greatest Football Game 48

The Australian
Commodore Review
Top Rear, 4 Carrington Rd,
Randwick 2031
Phone: (02) 398 5111
Published by:
Saturday Magazine Pty Ltd
Editor: Andrew Farrell
Advertising Enquiries:
(02) 398 5111
Subscription Manager:
Linda Hasn (02) 398 5111
Distribution: NETWORK
Printed by: Ian Liddell Printing

Editorial

IT SEEMS YOU CAN ALWAYS go one better. Faster, cheaper, more features. Occasionally one wonders just what it was that the original model had to make it such a big hit.

When I bought my Vic 20 some years back, it would have been unthinkable that a machine such as the Amiga would ever roll off the production lines of the same company.

Utilities are no exception to this rule.

From the first inklings of a faster DOS, to the twin cam, turbo blasters that bolt on and promise to load your software faster than you can replace the worn head, there is simply no comparison.

Of course, if you're not inclined to big time add ons with flashing lights and GT stripes, you can always go for the halfway approach; these may still

offer the same results. Software speed-ups are on the drawing boards - a few prototypes passed through our In/Out baskets, yet never qualified for the big time.

This issue Vince Morton takes a look at the latest offerings to hit the scene in the utility world. Some are faster, a few are cheaper, and all have more features than their predecessors. You're bound to be impressed.

Telecomputing for beginners is back this issue, and we found the Zork I maze map. You thought we had lost it for good, didn't you?...

Our sister magazine, *Home Computer GEM*, is alive and well. Issue number three has hit the streets, and the ball keeps on rolling. There's some interesting music software reviewed, along with a swag of games and a regular Commodore



Andrew Farrell

column - so why not check it out.

Next month we'll be taking a look at Commodore's latest family pack, their much acclaimed music expansion system and a close look at what Viatel has to offer Commodore users. So stay tuned for further fantastic developments.

**DIRECT
SUBSCRIPTION**

**The Australian
COMMODORE REVIEW**

*Make sure of getting
your copy - take out
a subscription now!*

Please enrol me for issues subscription to The Australian Commodore Review, commencing with the issue. I enclose a cheque/money order for \$

OR Please charge my Bankcard or American Express card, number

Expire date

Name:

Address:

.Postcode

Rates within Australia:
6 issues \$18.00 (including postage)
12 issues \$34 (including postage)

**We accept Bankcard and
American Express**

To: The Australian Commodore Review,
Top Rear, 4 Carrington Road,
Randwick, NSW 2031. Tel (02) 398 5111

RAM RUMBLINGS

Print Shop Library Disk One

PRINT SHOP is a program which prints out letterheads, signs, graphics, etc on a 801/1525 (I got it right this time) and other printers. *Print Shop* is a truly remarkable program. Now Broderbund software have released an addition to the *Print Shop* program, labelled *The Print Shop Graphics Library*. On the disk are 120 new graphic designs, ranging from educational designs, animals, star signs to special occasions and holidays. The actual designs are very professional, really pushing the printer to its limits where graphics are concerned. Although this disk is a smashing idea, I cannot really see it sell well, mainly because of its outrageous price. \$50 is way too much, considering the actual *Print Shop* program costs only a couple of more dollars.

The price is the only disadvantage of the disk, it is an excellent product which expands the horizons of the *Print Shop* program, if not the actual computer and printer. If you can afford it, buy it - but make sure you buy *Print Shop* first.

Adventure Notepad

Superior Software/Mountain Valley Software.

This new product is a must for all adventure gamers.

Come on, tell the truth, how many of you out there draw maps of adventure games and write notes on little pieces of paper that happen to be close by. Honestly, take a look at your adventure folder - it resembles a waste paper bin. *Adventure Notepad* is a special pad designed for mapping, with space for notes. Each page contains over 80 squares for mapping, with space for notes. Each page is a huge A3 size. Each pad contains 40 pages, which should take you through plenty of adventure games. The pad also can be used when planning adventure games before actually programming and typing in the program. A useful tool for all adventurers.

Price \$8.

by Michael Spiteri



Cable Prices Plummet

If you have recently had to buy connecting cables to wire up your printer or modem to your PC, you'll know just how expensive those innocent looking cables are! Despite their unassuming appearance, they carry a viper like sting - to the pocket of the unassuming purchaser. Prices range from \$50 to \$80 each.

LOGO Computers of Drummoynne have come to the rescue with a range of top quality, fantastically inexpensive cables. Both serial and parallel species are catered for, all at prices you can afford, according to Peter Klanberck of LOGO.

Price is based on quantity, and goes as low as \$6.50. However the one-off price is still very low at \$25 each for a parallel printer cable suitable for IBM PCs and compatibles.

LOGO also carry a wide range of intelligent printer switch-buffers - known aptly as Print Managers and straight print switches. Prices are enough to make the competition cringe!

For further information call (02) 819 6811.

Frank Conner presents

dfile 128™

designed specifically for
COMMODORE C128 COMPUTER

A FULL FEATURED DATABASE FOR:

- * GENEALOGY STUDIES
- * INVENTORIES
- * MAILING LISTS
- * FINANCIAL REPORTS
- * SCIENTIFIC DATA ACQUISITION, CALCULATIONS

GENERAL RECORD KEEPING FOR
HOME-OFFICE-EDUCATION.

- * FAST MEMORY MANAGEMENT
- * SINGLE OR MULTI-DISK DRIVES
- * 80 COLUMN RGB/40 COLOUR MONITORS
- * UNLIMITED FIELDS TO 225 CHRS
- * MULTI-FIELD SEARCHES/SORTS
- * 16 COLUMN REPORTS/4-UP LABELS
- * UTILITY PROGRAMS AVAILABLE

michaelsoft™

A COTTAGE INDUSTRY OF HOMESPUN SOFTWARE

Available from Toyworld, Melbourne, Software 64, Croydon, Vic. & Ray Cross Electronics, Boronia 2422 (03) 2422 or mail order direct from

Frank Conner, 17 Amanda Crt, Seville, 3139, Victoria.

Phone: (059) 64-3793

TRADE ENQUIRIES WELCOME

24 hour Bulletin Board (059) 64 3126

Available on Microtex 666

Utilities

Speedy program developers use a Toolkit

by Andrew Farrell

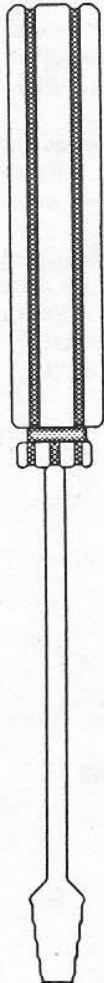

Writing a program is a creative exercise. Like a sculptor's tools or a painter's brush, are the many utilities that can be put to work. They take the mundane parts of programming and make them far simpler. Performing tasks that would take hours to do by hand. Creating graphics, sound and the management of your program requires careful planning.

Using a toolkit, much of the mathematics of building sprites, custom character sets, or the guesswork of making music can be alleviated. Commodore endowed the 64 with a crude BASIC. Most of the machine's features are not well supported. Because of this the need for a helping hand here and there is even greater.

Due to the large number of machines sold, many enthusiasts have produced some extremely useful aids to programming. Many are directed specifically at disk users, in the area of general maintenance and tidiness. Files need to be moved, copied, erased, renamed. Directories become cluttered, need alphabetising or rearranging.

For all these tasks, much commercial software is also available. Commodore themselves collated a Programmer's Development Kit not long after the 64's release. Since then, a single disk of Programmer's Utilities has been made available based on one of the three disks in the original kit.

Selling for around \$28, it contains some useful material. A machine code monitor that allows memory to be examined and your own assembly language programs to be written, is included. The

version I have contains two, each one located in a different area of memory. That way, if one conflicts with what you are doing, the other should be out of the way.

Pet Emulator comes in handy if you have access to any old PET programs. Once run, it configures the C64 in a similar way to the older Commodore machines. Whilst not all PET software will then work, most of the better programs will at least load properly.

DOS Wedge, also included on the demonstration disk which comes with the 1541, is an invaluable help to using your

disk drive. It adds a range of additional commands for simple one or two keystroke loading of files. It is also possible to send DOS commands in a simple manner as well as obtaining a directory without destroying the file in memory.

A rudimentary character editor allows you to create your own character set. As each letter is being edited, it is displayed in full, in an enlarged form on the screen. Each of the dots or pixels which make up the character are displayed in the squares of a small grid. This method is fairly standard for all character editors. Special keys allow you to rotate and shift the grid for some really wacky effects.

Similarly, the sprite editor allows the definition of up to 150 sprites, in single colour mode. Once designed they may be viewed moving about the screen, to see how they might look once part of a real game or whatever program you have in mind. When you are satisfied with your designs, both the sprites and characters may be saved to disk for later use.

Sounds may be toyed with using **SIDMON**, a crude but effective means of playing with the registers in the SID chip. Waveforms, ADSR filters and various other attributes may be modified. Once you have a good sound, simply jot down the register values to include in your own programs.

A screen editor is very useful for business software. Dates, numbers and alphabetic or alphanumeric entries may be controlled and confirmed quickly and simply. Whilst this routine is not without its fair share of bugs, it works effectively most of the time.

There's a few other bits and pieces on the utility disk, which change from time to time. You may obtain a copy from most user groups, who are incidentally an excellent source of public domain utilities. The price should be no more than the cost of a blank disk - if that.

Graphics

Character editors and sprite editors are often available separately. **Graphics Master**, a simple cassette utility for sprite and character design, sells for \$19.95. The better commercial packages allow for animation and the design of full colour sprites.

Before mentioning this next product, it would only be fair to state that I am biased toward it. I wrote it, and find it the most easy to use simply because it conforms to what I thought were the most necessary features. The best I can do is mention what it does, and let you judge for yourself.

Okay, so what's on it. Well, the program is virtually fully

UTILITIES

menu driven. There's a character editor, sprite editor, sprite animator, animation editor, hi-res graphics routine, split screen generator and more. Tutorials, help screens and the list goes on.

The best part about it, is that all the routines are supported by a program that

tells you how they work. Each of the editors may be accessed from the main menu, and when you have finished playing around with your designs, you can return to the main menu with a single keystroke. Such elegance has never been seen before in a toolkit such as this - which is why it was named **The Graphics Workshop**, for that is more what it is.

From the character editor, you may also design shapes consisting of several characters joined together. Individual characters may be rotated, reflected, shifted and reversed. They may also be copied, deleted, or saved to disk for inclusion in your own programs. The sprite editor has similar features, with the addition of multicolour mode.

Once you have designed your sprites, move to the animation editor, and you may view a series of sprites. They may be fully animated, such as the example included of a car driving along, chugging out puffs of smoke as it goes. The program which does all the animation is a utility within itself and may be included in your own software. It manages all the movement of sprites, and is interrupt driven.

This means that the animation takes place without any efforts on behalf of your program. It is a background task.

Another useful utility is the split screen generator. This allows you to have two background colours - normally not possible, and to have a redefined graphics area in the center.

Hi-res graphics may be obtained using a simple utility that will draw lines in single colours on the hi-res screen. Great for mathematics programs that require plotting and line drawing. It's all reasonably simple to use, and comes complete with tutorials on disk that explain the various principles of redefined characters and sprites.

The **Graphics Workshop** is in many ways a halfway step between a crude graphics editor and the joy of a full on extended language. These could also be viewed as utilities, with Ultra-Basic and Simons Basic being the most popular. Both add a vast range of additional commands to BASIC for simple design of music and graphics. However they are not transportable. You need the original language to use any programs written in them, which is a major drawback in some respects.

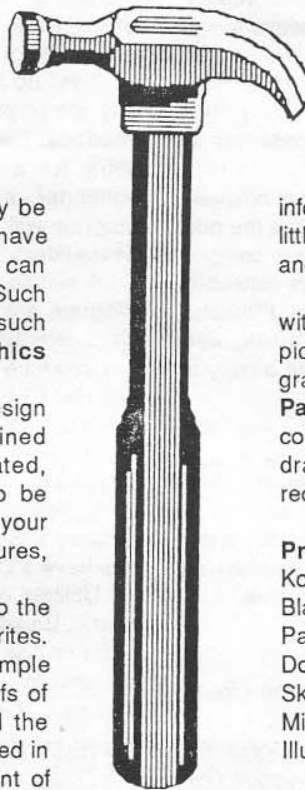

Staying in the graphics theme for a moment, there are many programs of the doodle genre which make designing colour high resolution graphic pictures very easy indeed. These may be integrated within your own software if you know how. The **Koala Pad** documentation includes

information on how to do this, whilst others require a little investigation and could easily be the subject of another article.

Doodle is great for mixing text and graphics, with facilities to expand and shrink parts of your picture. This is an option not usually found on graphics software on the Commodore. The **Koala Pad** is more suited to free hand drawing, with more control over the colour aspects. Another popular drawing program is the **Sketch Pad** and more recently **Blazing Paddles**.

Program	Distributor	
Koala Pad	Imagineering	Touch Pad/Paddles
Blazing - Paddles	Computer One	All
Doodle	CW Electronics	Joystick/Track Ball
Sketch Pad	OziSoft	Trace Pad
Micro-Illustrator	Commodore	Light Pen/Touch Pad/Paddles

Overall, **Blazing Paddles** would probably represent the most complete graphics utility. It allows the mixing of text and graphics and has many of the features of the micro-illustrator. Most of all, you may use a wide variety of mediums to draw with including the most accepted, which is the touch pad.

Music

Music is another area where a large number of utilities exist to make design easier. The **Kawasaki** range is probably the most famous, however, little or no allowance is made for including your compositions in your own software. **Music Composer** is similar, however that too is a stand alone product. Imagineering's **Music Construction Set** allows some inclusion of your creations in your own software, however that has a few problems.

Synthy 64 is similar, but once again, inclusion within your own software is difficult. I tend to think that it ceases to be a utility once you can't use it in your own programs. Perhaps the tried and tested **SIDMON** is the best place to start.

Perhaps there is a good market for a product to do that job. As yet, I couldn't name one that does. Although many allow you to make some great sounds and some okay tunes, none make inclusion within your own programs an easy task. Most people revert to the use of extended BASICs for making music. These often have commands such as **PLAY**, which give ample control over the music capabilities of the 64.

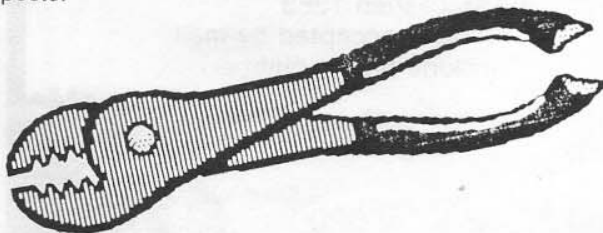

UTILITIES

Other utilities that are invaluable to the programmer are the compiler and disk editor. In Australia, compilers are not readily available. **Petspeed** was distributed by Commodore some time ago, and whilst it was not the best of compilers, it was ample for many applications. Compilers change BASIC code into machine code, or machine code with a run time library. This greatly increases the speed of execution as less code has to be interpreted.

DTL Compiler is about the best around. It is not officially distributed by anyone, however some stores may have the odd one or two. It has the added flexibility of being able to compile BASIC extensions. It also replaces the low garbage collection routines, greatly speeding up large BASIC programs. Pittwater Distributors, makers of software such as **Cashbook**, use DTL extensively and may be able to help you locate a copy in Australia. They can be contacted on (02) 981 3014.

Disk utilities would have to include all the various fast load cartridges - of which there are many. **Epyx Fastload** is very popular, as is the **TurboDos** from Cockroach software. The **1541 Express** is another goodie. ROM replacements tend to be the best way of speeding up the drive as well as adding the DOS wedge mentioned earlier. However, some circuit boards are not socketed, making any changes rather expensive.

Printer utilities

Printer utilities are invaluable. In my search for one I found

not only a printer utility, but a whole suite of very useful programs. The package is the **Cardco Super Printer Utility Disk**. It sells for around \$69.95, and is available from Compushack stores and most other OziSoft dealers.

It will do hi-res screen dumps for the 1525, MPS-901 and any other printer properly interfaced using a Cardco-G+ interface. There's also software to do banners and posters. A utility for a 24 Kilobyte printer buffer - within the actual computer, a real boon for long program listings. Another program will give your 1525 or MPS-801 true lower case with descenders.

A simple wordprocessor, mailing list, calculator and index program are included. There's a doodler and a very useful cross reference program. This is excellent for long programs. It will produce a complete table of all variables used, Goto, Gosub, PEEK and POKE statements and more. Great for keeping track of what's going on.

A few other smaller utilities do things such as ASCII conversion, to and from CBM to standard ASCII. There's also 20 digitised hires pictures for you to print out. All in all about 50 programs. Sounds like good value for money - an ideal utility if you have a Cardco-G+ interface.

Utilities can save time, make life easier and cause total chaos. Be sure you know what something does before you run it. Some disk utilities can cause fatal errors when mis-used - so beware. Watch out for more programmers' aids coming your way soon. Until then, happy hacking.



commodore
computer centre



AMIGA, 128, 64, VIC20 PC10, PC20 and CBM8000

LARGE COMPUTER DISPLAY — 3000 SQ FT. • WE ARE THE EXPERTS, COME & SEE US FOR

SALES

- Every conceivable accessory
- Huge range of programmes (particularly education)
- Direct connect typewriters
- 17 different printers
- Serial & Parallel Interfaces
- Monitors: colour and monochrome
- Touch tablets
- Plotters
- Disk Drives (4 different & includes compatibles)
- Desks, printer stands
- Books, labels, magazines (huge range)

SERVICE

- Prompt repairs by friendly experts
- Disk drives aligned (specialty)
- Easy access
- Plenty of Parking
- Open Saturday mornings
- Established 1968
- Repairs accepted by mail (include phone number)

Maxwell
OFFICE EQUIPMENT (VIC) PTY. LTD.

162-164 NICHOLSON ST., ABBOTSFORD
(near Collingwood Town Hall)
Telephone (03) 419 6811

FOR SPECIAL
CONCESSION
BRING
THIS
AD

Which Utilities

by Andrew Farrell

A bountiful supply of programmers aids and utilities fills the shelves of computer stores. From kitchen can openers, mixers, blenders, and processors to disk fixits, picture printers, and track and sector editors the only difference is the room of your house you'll find them in.

When choosing the best tool or aid to suit the job, the considerations are speed, functionality, power and price. If you want to juice carrots you don't use a hand held blender. So too, if you're into writing full machine language programs, a one line assembler won't do the job.

Lately a few very novel utilities have turned up, usually under the banner of 'construction kit'. There's a pinball construction kit, an adventure construction kit and an arcade construction kit. More recently the very successful game

Boulder Dash has found its way into the construction kit genre. Yes, design your very own screens to play on your own or challenge your friends.

We haven't really included graphics drawing programs here, although OziSoft is releasing a smart package called *Image System* which sounds very promising. It boasts zoom, rotate, and twist capabilities using 3D graphics plains. Epson compatibles are supported with an expected retail price of \$49.95. Full review of it and other graphics based programs soon.

Over past issues we have reviewed a variety of utilities, including a look at a few of the latest and a few older, more staid varieties in this issue. To cap it off, here's a complete list of everything that we could find - please note that price and availability may vary slightly.

Utility	Type	Distributor	Price
Capture Cartridge	EPROM burner	Lion Electronics	\$88.95
Cockroach Turbo ROM	DOS speed up add on	Cockroach Software	\$42.00
Dolphin DOS	DOS speed up add on	Micro Accessories	\$169.00
Fast Load	Epyx DOS speed up add on	ECP	\$49.95
Final Cartridge	DOS speed up add on/printer & disk utilities	ComputerScope	\$139.00
Freeze Frame II	DOS speed up add on	Micro Accessories	\$99.00
Graphics Workshop	Sprite/Character Editors/Utilities	Prime Artifax	\$10.00
Laser Basic/Compiler/Genius	Extended Programming language/compiler/utilities	OziSoft	\$59.95/ \$69.95/\$59.95
Megasoft Utilities	Various disk & program aids	Pactronics	
Power Cartridge	Disk toolkit, monitor, print dumps, fastdos.	Ozisoft	\$149.00
Programmer Basic Toolkit	Epyx programming utilities	ECP	\$59.95
Quickdisc+	Fast loader plus utilities	Micro Accessories	\$49.95
Super Printer Utility	Cardco hi-res screen dumps	OziSoft	\$69.95
Vorpel Utility Kit	Fast Dos & Utilities	ECP	\$59.95

Freeze Frame Mark III

reviewed by Vince Morton

SO YOU THOUGHT all the memory freeze type backup cartridges were the same, well here comes one that definitely offers more.

This is the latest and best in the freeze-frame evolution and offers features the opposition cannot touch, and more is on the way, so read on.

When you turn on your 64 or 128 (yes it works on the 128, unlike some other backup cartridges) you will get a black screen with a number of options in white.

The bottom of the screen offers three Utilities:

- D - Directory.
- F - Format disk.
- C - File copy.

D List the disk directory to the screen (space bar will pause the listing) and then prompt DISK COMMAND, allowing the use of any normal disk command ie SO:,I,V etc. Pressing the RETURN key will return to main menu.

F Formats a disk in 20 seconds, and then prompts DISK COMMAND as above.

C Copies files up to 248 blocks long at 7-8 times normal speed. The directory will be listed on file at a time and the option to copy given with y/n input required. Multiple output is available.

Back to main menu there are three options:

- M - Configure Memory
- R - Normal Reset
- S - Subsequent Parts

R Reset the memory to normal configuration - for those programs that check memory as part of the protection designed to thwart these type backupcartridges.

M Configure memory, for those programs that do not check.

Having now used either of these options, the computer will now reset to Basic ready for loading of the program for Freeze Framing.

Operation from here as per the earlier Freeze Frames. Once the program is loaded and at the point at which you wish it to restart, press the button on the cartridge and the screen will go stripey.

There are now three Options available:

D - will store the program on disk with fast reload (reload ,8,1).

S - will store the program on disk with normal speed (reload ,8).

T - After pressing RECORD and PLAY will save to tape in turbo format.

After saving to disk with D or S you will be prompted for a program name for your new program.

One of the bugbears of memory based copiers has been tape based programs which load the main program and then subprograms later, these were almost impossible to make a backup of.

Enter the S COMMAND - Having Freezeframed the main program, re enter the Freezeframe menu and select S - Freezeframe III will now transfer the extra parts from tape to disk.

The documentation is precise and well written and contains several hints and tips.

Overall a very good product which by far outstrips the opposition on both price and performance.

Oh yes, I nearly forgot the more to come promised earlier. On the earlier Mk I and Mk II the backup copy was divided into five files. The Mk III Freezeframe is now three files long and with the aid of a Utilities Disk soon to be available, this may be condensed into a single file. Owners of Mk II Freezeframe may upgrade to Mk III for a small fee, for details contact Micro Accessories of S.A. or one of their dealers in each state.

PRICE: \$ 99.00 from Micro Accessories of S.A. or their dealers.

NOTE: FREEZEFRAME MK III is designed to work with DOLPHIN DOS, loading a Freezeframed program in less than 15 seconds including searching and uncompression.



*"... far outstrips
the opposition
on both
price and
performance ..."*

UTILITIES

Quickdisc+ Mark II

reviewed by Vincent Morton

ENTER THE LATEST ENTRY on the fastload cartridge market, Quickdisc+ Mk II from Micro Accessories of South Australia, priced at \$49.95 and available from their dealers in all states.

Enough of the adverts, let's see how this cartridge compares with our old friend the EPYX and the COCKROACH Turbo ROM. On speed of loading the Quickdisc is comparable on most of my old standards, but did jump out in front on *Easy Script*, as it ignores the parameters set by the program and continues to fastload, resulting in quite considerable time saving as the chart shows.

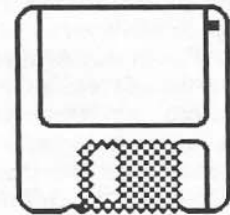

PROGRAM	NORMAL	EPYX	COCKROACH	QUICKDISC
Jumpman	100.2	21.0	16.9	19.8
Database Plus	71.9	19.9	13.8	17.2
Volcano	92.1	21.0	19.9	19.9
Volcano (lse)	22.8	22.8	22.7	22.7
Hunter On Ice	86.0	36.9	20.8	21.7
Pitstop II	145.3	33.5	30.0	31.8
Easy Script	62.9	59.0	54.5	13.5
Beachhead	141.8	67.6	41.2	37.6

I used the Quickdisc on both the 1541 and the Skai Super Drive with no problems at all. The Quickdisc supports all the shortened commands used on the EPYX, plus more.

@ = Open 1,8,15,	\ = Dev 8/9
% = Load ,8,1	@Q = Quit Cartridge
/ = Load ,8	SYS56904 = Restart
= Load ,8 : run	<- = Save ,8

The four function keys have also been used by the cartridge for the following functions:

F1 = List
F3 = Run
F5 = Load":",8,1
F7 = Display directory.

This can be a small problem with some programs, which themselves use the function keys, as the programming of them can become confused.

There are several other extras that come with the Quickdisc which deserve a mention.

@P - Turns the user port into a Centronics printer interface, with the aid of the correct cable.

Reset Switch - One of the fastest acting, most reliable I have seen.

@C - File copier - reads the directory and you select with a yes or no. This is 7/8 times normal speed and will copy files up to 248 blocks long with an option of multiple output, a very impressive file copier.

@B - 3 minute backup of unprotected disks.

@H - Help menu gives all the above information and more.

The save and replace bug is overcome with the Quickdisc.

Overall the Quickdisc+ Mk II is definitely a viable proposition as a fastloader at a reasonable price and I have found it in use more than the EPYX Fastload, although I must admit there are one or two programs that the Quickdisc won't load, and I switch back to the EPYX.

I can recommend the Quickdisc to anyone looking for a cheap fastload system, and it has one other advantage, you will be buying AUSTRALIAN.

*"... there are
one or two
programs that
the Quickdisc
won't load ..."*

Dolphin Dos

reviewed by Vince Morton

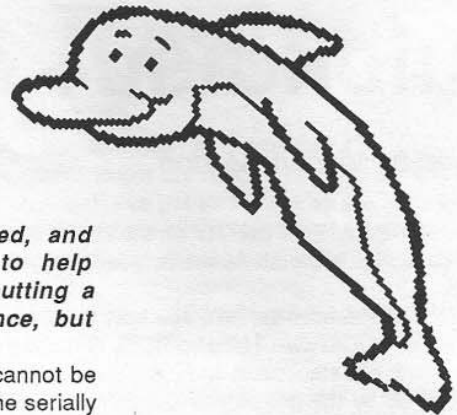

THE 1541 LIKE THE Volkswagen is not famous for its speed, and hence the multitude of cartridges and modified kernal ROMs to help the poor 1541 on its way. The effect of these add ons is like putting a set of twin carbs on the Volkswagen, it improves the performance, but it certainly doesn't make it into a Porsche.

One of the main factors affecting the transfer speed of the 1541 which cannot be addressed by the add ons, is the fact that all data is transfered one bit at a time serially into the processor, which means eight bits for each character in line one after another.

Let's just suppose we were able to transfer all eight bits of a character at once through a parallel input from the 1541 to the processor. Logically this would mean that we could load data 800 percent faster (theoretically at least), add to this the fast load technology available in the above add ons, and hey presto we are suddenly using Porsche running gear in our Volkswagen.

Dolphin DOS is the embodiment of the above principals, and believe me it really does give Porsche performance to the 1541 Volkswagen.

Installation

Dolphin DOS comes in two parts, firstly a changeover kernal ROM with switch (a'la Cockroach) which switches from normal kernal to Dolphin kernal, and as in Turbo ROM there are no cassette commands in Dolphin mode. Installation of this part should cause no problems unless of course you have a soldered in kernal ROM.

The next stage of installation requires that you have the right model of 1541, and there is about 95% chance that you have. This is the 1541 end of the conversion, and it requires the removal of two I.C.s from there sockets and replacement with a small printed circuit board. The two removed I.C.s are then placed into the new p.c. board in their original positions. A short lead with a switch attached is used to switch in/out Dolphin DOS, and the switch should be mounted into the 1541 cover. Another lead emanates from the p.c. board and this one goes to the user port of the 64/128.

The installation instructions with Dolphin DOS are quite well written, with diagrams and start up tests incorporated.

"...this would mean that we could load data 800 percent faster..."

Speed tests

Now that Dolphin DOS is installed we are ready to see just how fast it is. I used the same old favourites for standardisation, and included the old tested products so that a complete comparison accross the board can be made, this may seem a little unfair on the old add ons, but remember that although they are lower in performance they are also lower in price.

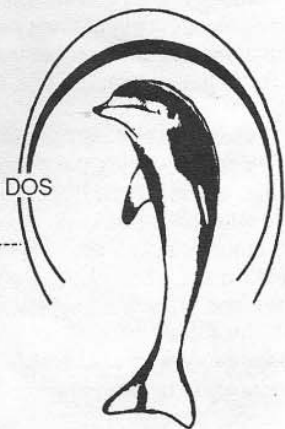

PROGRAM	NORMAL	EPYX	COCKROACH	QUICKADISK + II	DOLPHIN DOS
Jumpman	100.2	21.0	16.9	19.8	04.3
Database Plus	71.9	19.9	13.8	17.2	03.2
Volcano	92.1	21.0	19.9	19.9	05.8
Volcano (Ise)	22.8	22.8	22.7	22.7	10.8
Hunter/Ice	86.0	36.9	20.8	21.7	04.3
Pitstop II	145.3	33.5	30.0	31.8	08.7
Easy Script	62.9	59.0	54.5	13.5	04.2
Beach-head	141.8	67.6	41.2	37.6	07.9

Your key to communications!

for
Commodore
64/128

The **MICROTEX** Communications Package



GIVING YOU
ACCESS TO:

Telecom
VIATEL

- 100's OF PROGRAMS TO DOWNLOAD
- COMPUTER NEWS
- HARDWARE & SOFTWARE TIPS
- TEleshopping
- INTERACTIVE STRATEGY GAMES

and much much more!!!

PACKAGE INCLUDES:

- PUSH BUTTON HANDSET
- MODEM
- VIDEOTEX COMMUNICATIONS SOFTWARE
- TELESOFTWARE DOWNLOAD
- TERMINAL COMMUNICATIONS SOFTWARE
- MICROTEX 666 SUBSCRIPTION
- FREE MEMBERSHIP TO CLUB 64
- FULL INSTRUCTION BOOKLET
- AND IT'S AUSTRALIAN MADE

To order or for more information
simply phone our hotline

(03) 419 0300

Information Solutions

31 Victoria Street, Fitzroy Victoria 3065

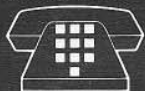

Viatel is a registered trademark of Telecom Australia



UTILITIES

As you can see we have definitely reached Porsche performance, but not without some minor problems, as a couple of programs required loading with a ,8,2 as they dropped into monitor whilst loading ,8,1 other than that, all went fine.

I did run a test with some Sequential files and found that the claims made in the manual of speeds ten times faster loading were quite correct, and also very impressive. Saving of files is also vastly improved with Dolphin DOS.

What else do you get?

1. The function keys have been programmed for the following.

F1 - LIST	F2 - SYS\$0(Monitor)
F3 - RUN	F4 - VERIFY
F5 - LOAD"0:**",8,1	F6 - SAVE"@:
F7 - \$ (Display Directory)	F8 - @X (Dolphin DOS status)
C=F1 - OPEN4,4:CMD4:LIST	C=F3 - Back scroll in Monitor
C=F5 - Fwd scroll in Monitor	C=F7 - LOAD ,8,2

The use of all of these may not be immediately obvious, but read on for more explanation.

2. All disk commands are abbreviated, with the use of the @ sign replacing OPEN1,8,15" and the loading of a program requiring only LOAD"Program name without the closing quotes to load a program with ,8,1. The @ sign also combines with X to give some more disk commands applicable only to Dolphin DOS.

@X - Dolphin DOS Status	@XT - Sets tracks (35,40,AUTO)
@X9,8 - Sets Device address 9	@X8,9 - Sets Device Address 8
@XL - Write protects a file	@XU - Unprotects a file

3. There is a screen editor with thirteen commands used with a combination of the CTRL key and a normal key. This function also has the ability to switch in or out the function key programming.

4. A fairly comprehensive Machine Code Monitor is included for all the M/C buffs, and it uses two of the function keys to scroll either forward or backwards through a program, very handy.

5. The & key has been given two new uses, &Number - will display the number in decimal and hex. &* - will restore a Basic program after a NEW (same as OLD).

6. The RESET and RESTORE are given several new functions, which are detailed in the manual, and are too numerous and complex to list here.

7. The final additional feature of Dolphin DOS is the ability of the user port to become a Centronics interface with the aid of the right cable. To get the most out of this facility it will require a user port expansion board, so that both Dolphin DOS and printer may be plugged in. This item is on the drawing boards, and will be available from Micro Accessories or their dealers at some time in the future.

Conclusions

As you can see the Dolphin DOS not only gives Porsche performance to the 1541, it also gives quite a few of those luxury extras that we associate with an upmarket product. I have had my Dolphin DOS for about two months, and have demonstrated it at a few user groups. The reaction to Dolphin DOS on these occasions has been either single syllable outputs like "WOW" or just plain stunned silence, which is quite a recommendation on its own.

I guess the final line to this all comes down to individual choice and finances, if you are happy with twin carb performance on your Volkswagen, and only want to pay around \$50.00 then buy a Quickdisc+ or Fastload or Turbo ROM.

If however you would like Porsche performance and can afford the \$169.00 price tag then contact Micro Accessories of S.A. or your local dealer and get yourself what I personally consider to be a really great product.

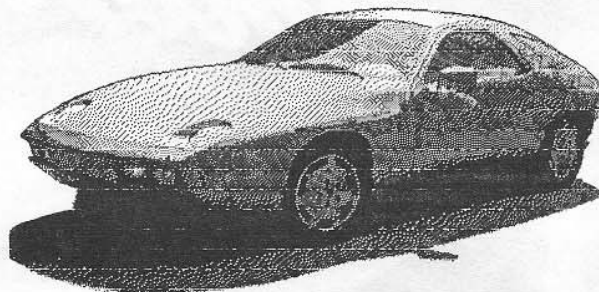

"... the claims made in the manual of speeds ten times faster ... quite correct..."

C-128 Programmer's Reference Guide

by Paul Blair

IT'S ARRIVED, so you should go out and get one.

How's that for the shortest, most succinct review on record? I could probably stop there, because if you have been waiting, you won't want to hang around to read the rest of this. So, off you go....

If there is anyone still reading this, the news is that Bantam Books have published the *Programmer's Reference Guide* (PRG) for the Commodore C128. By the time you read this, it will be on sale at the usual outlets for a shade under \$45 RRP.

Why get excited? if you are one of those users who couldn't care less about the vitals of your computer, and are not interested in writing your own programs, go on with whatever you were doing. The rest of you, pay attention.

Homily #1 - If you want to make full (even efficient?) use of your C128, then you will need a copy of the C128 PRG on the bench beside you. Period.

Information is the good oil, useful for greasing programming wheels. Non-information is where stuff is left out, or poorly covered. Mis-information is a time bomb, waiting for the unwary.

Homily #2 - For the most part, you will find the PRG has worthwhile information, a bit of non-information, and practically no mis-information. In the world of computer books, that's high praise.

Reference guides are just that - resource for information. Where does the information come from? In the case of the C128 PRG, the answer is - directly from Commodore. Using notes prepared by the C128 design team, Larry Greenley has drawn together what he saw as the most useful information that you, the user, would need.

If you are an old hand (i.e., had a Commodore machine before 1984) you will find this new trend difficult to comprehend. The C64 PRG was pretty good, the C128 PRG is even better. All I

can say is enjoy it. I hope it's the way things go from here on in.

WHAT'S IN IT...FOR ME?

Given my home-grown definition of a PRG, one of the decisions that must have faced the PRG editorial team was how much of the C64 mode to cover, given that a C64 PRG exists. The decision seems to have come down pretty much on the side of C128 mode, with appropriate reference to C64 mode where the operations of the C128 impinge. This seems a reasonable compromise, so if you have a C64 PRG already, hang on to it.

This created a few minor problems, because the C64 mode, and the two C128 modes (40 and 80 column) can get a trifle difficult to sort out in the body of the text. The solution is simple enough - read carefully. But maybe a margin stripe to indicate the application of each paragraph could be included in a later issue. Equally important was the lack of distinction between Basic 2.0 and Basic 7.0 keywords. The book that comes with each C128 is clear on this point, using different colours to make it clear which goes with what.

The PRG dives straight in at the deep end, so I suggest you study the computer handbook first, if only to catch up on some of the Commodore conventions. Old hands need not bother, they will be aware of them. After an easy going whip through the Basic 7.0 commands, it's straight into C128 graphics in Chapter 4. To continue with deeper explanations on graphics, jump on to Chapter 8. In between comes three chapters on machine code, nicely presented and instructive, as well as useful.

Greg Perry had a look at the next part which goes into details on handling the video chip (8563). He felt that it lacked some depth of explanation, but at the same time he told me that he did learn

some things he didn't know before. For a guy who has a heap of experience in the video line, his comment is worth noting. At the same time I was reading the chapter on input/output (I/O), which I thought too skimpy. Where was the explanation of the fast serial bus? OK, there is some detail in the disk drive manual, but the computer end of the action is not to be found. To put it another way, there was nothing for me to refer to. I warned something here ... there is a warning not to use your cassette with the disk drive plugged in at the same time, because data could get messed up. Bad luck for C128D owners...

After those couple of hiccups (wich are pretty easy to fix), system architecture is explained. This is an essential part of learning to use the full power of the C128, and this section will help you a lot.

Memory maps for both C64 and C128 come next. They are accurate and very useable.

CP/M, as implemented by Commodore, gets a large section to itself. Now, I'm not into CP/M (I have difficulty spelling it!) and frankly can't tell you whether the amount of detail provided is warranted, or the information is good or bad. It's there, anyway.

TO SUM UP...

One of the Seven Joys of Man (I'm not sexist, that's how an author defined them, long ago) is unwrapping, and if you like you C128 and wish to love and cherish it, use it effectively, and maybe get some satisfaction in return, peel the plastic wrapper off a C128 Programmers Reference Guide. In my view, you won't feed and care for your C128 properly without it.

The Printer Connection

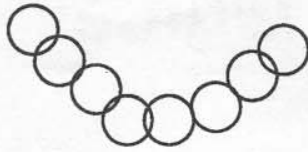

from Eric Holroyd

I got my Commodore 64 as a Family Pack way back in October '84 and it took me no time at all to learn that the tape drive was painfully slow. After a few weeks of using tape I invested in a 1541 disk drive and was thrilled with the speed improvement it gave. Then, in the December '84 issue of "Commodore" I read a review of *Turbo 64* from Cockroach Software by Paul Blair.

He referred to "those clever lads at Cockroach" and was so enthusiastic about the product that I sent off my money straightaway to get one for myself. It was all true, folks! Yet another thrilling improvement in operating speed, and it wasn't long before I'd converted all my favourites to Turbo-loading. What a treat to use Turbo 64 disks, single-key load from a menu as well as the faster loading times already written about by Paul Blair.

Then an entirely unconnected thing happened, my drive ceased to function properly, ie wouldn't load properly and it transpired that I needed to have a re-alignment done. The technician told me that the drive pulley is of a die-cast metal which is a "push-fit" on a silver steel shaft (both these metals have different heat-expansion rates!) and due to the heat which can be generated in a 1541 the head becomes misaligned due to continued banging against the end-stop caused by old-fashioned copy-protection methods. One way to minimise the future occurrence would be to use a cooling fan to keep the temperature down and therefore stop the drive pulley slipping on its shaft due to heat-expansion.

I was still thinking over the technician's advice when I happened to see another Cockroach Software ad offering a cooling fan designed for this very job, sent off for one, and have had no further trouble with the drive going out of alignment.

When the fan arrived it also had a note advising of the new Cockroach *TurboRom*... needless to say I got one straight away and was amazed and astounded by the remarkable increase in loading, saving and verifying speeds it accomplished. The built-in DOS wedge plus screen dump etc proved to be very handy too.

By this time I was a confirmed (and very satisfied) Cockroach customer so it was only natural that when I bought a 128D I'd get a *TurboRom* to speed up the 64 mode.

The 128 is a very good machine, although some things aren't as compatible as Commodore would like us to believe (if you buy a 128 hang on to your 1541 drive to use with it as well as using the marvellous 1571 drive) and I'm now using both the old 64 and the 128D on the same desk with my trusty Gemini 10x stationed between them. (The 10x is interfaced with a Xetec Super Graphics unit which is a whole fantastic story in itself.)

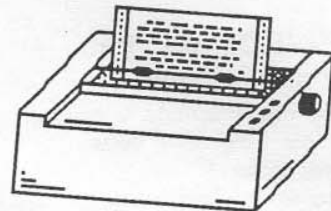

Using two computers with only one printer presented some problems as obviously I could only have it hooked up to one unit at a time and I was tempted several times to disconnect the serial cord from one unit to reconnect to the other whilst still switched on! I resisted the temptation as all kinds of nasty things can apparently occur if you do that, so in each case where I'd forgotten to change the leads over first I had to power down, swap leads and then re-load whatever I was doing.

I was just about coming to my wits' end when I read in one of the American magazines that there's a switchbox available over there for \$29.95 which would do the trick. Unfortunately our dismal dollar exchange rate makes that into around A\$65 by the time you add US\$10 for airmail so I decided to ring up Cockroach and ask if they knew of a similar product here in Australia.

They didn't, they said but were prepared to make one for me as I was quite well known to their order department by this time, and less than two weeks later I had this lovely little switch box arrive in the mail which I hooked up to the two Commodores and I can now switch between them with no more trouble than flipping a switch! Beauty! It cost me just under half of the American job above and although it's not yet a regular item on the Cockroach list I'm sure they wouldn't mind me giving them a plug and suggesting to anyone else wishing to connect one printer (or one disk drive for that matter) to two computers they should write to Cockroach Software, Box 1154, Southport, Qld 4215.

I probably sound like a paid salesman for the company, but such is not the case. I'm just a satisfied customer who likes to pass on good things about suppliers to others who may be interested. After all, we're only too willing to tell people about a bad deal so why not spread the word about a good deal too?

Incidentally, when I got the switchbox from Cockroach, there was this short note enclosed ... It seems that they're working on this cartridge/disk idea to capture pictures from any program and either print them out on your printer or make a slide show plus other effects. Looks like I'll be sending them another cheque soon because this *Graphic Pirate* is apparently due for release some time in October.

It looks like Cockroach will be around for some time to correct and I for one hope that they are. Their innovative product always priced right, should ensure it.

Micro Accessories of S.A.

THE UTILITY SPECIALISTS

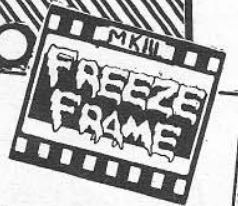

DISC DISECTOR V5.0

Now the **FIFTH** generation of the country's leading disc back-up/utility package is available. This latest version includes many more "PARAMETERS" to handle the latest highly protected discs.

"EVESHAM 3 MINUTE NIBBLER" is the latest version of the infamous "Evesham Nibbler" now boasting even more power and speed. Will now copy even the most highly protected discs in 3-4 minutes. Handles the latest types of disc protection completely automatically. This often involves the protection "PARAMETER COPIER" which adds the vital secret use of the "PARAMETER CHECKER" for (This is the code that the highly protected programs check for (This is the important difference that makes this the best). At the time of going to press this program copied virtually every disc program available for testing including the latest in games and business software.

"DUAL DRIVE NIBBLER" allows the use of two drives to make even faster back-ups. Incorporates device number change software so no hardware mods necessary.

"NOVA TRANSFER" will transfer to disc the latest Nova Load programs including multi part loaders. A very useful utility that also includes routines to transfer "Summer Games II" and "Beach-Head II" to disc.

"DISCO" will transfer standard speed load software to disc. "TRANS OD" allows you to save a fast load system to your own discs.

"DOUBLE BACK UP" is a very fast two drive back up. As well as these important newcomers all the old favourite utilities which have helped earn "Disector" such a large following are included. These include Menu Maker (selective), Fast Format, Unscratch, Disc Monitor, Disc Orderly, Fast File Copy, Index, etc., etc.

The whole package is menu driven and has its own fast boot system built in for your convenience. Pays for itself the first day you receive it.

ONLY \$49.95

Customers with earlier versions may return them along with a payment of \$9.95 to receive V5.0

Programs are CBM 128 and 1570/71 compatible in '64 mode.

Floppy Disks

S/S BOXES OF TEN \$18 each



ANTIKNOCK DEVICE

This package incorporates a new drive stop for your 1541 that will end for good the dreaded "woodpecker". The fitting is very easy and a test program is provided to check the fitment. Helps prevent future alignment problems and makes your drive purr with satisfaction.

ONLY \$19.95

AND THEN THERE WAS 300

DOLPHIN DOS THE DIFFERENCE IS STAGGERING

Like everyone that has had the pleasure of seeing this system in operation you will be amazed by both the speed and ease of use. It is compatible with the majority of commercial software, speeding up both the program loading and SEQ/REL files. Fitting requires the insertion of two sub assembly boards, one in the 1541 and one in the '64/128. This does not normally entail soldering, although a small amount will be necessary with some machines.

ONLY \$169.95

If you require further information please send SAE for fact sheet. Operates with the CBM 64 or 128 in '64 mode with 1541 disc drive.

- #### THE FEATURES
- 25x FASTER LOADING (PROGRAM FILES)
 - 12x FASTER SAVING (PROGRAM FILES)
 - 10x FASTER LOADING (SEQUENTIAL FILES)
 - 8x FASTER SAVING (SEQUENTIAL FILES)
 - 3x FASTER LOAD AND SAVE (RELATIVE)
 - (These figures do not allow for searching)
 - Easy DOS commands from function keys.
 - Fast formats 40 tracks giving 749 blocks free.
 - Centronics driver software inbuilt.
 - Machine code monitor.
 - Can be switched out if necessary.

MICRO ACCESSORIES OF S.A.
UNIT 8, HEWITSON RD
ELIZABETH WEST
SOUTH AUSTRALIA
5113
Phone (08) 287 0191

Made under licence to EVESHAM MICROS
Manufactured in S.A.
Offers subject to availability

Send cheque, Postal Order or Credit Card No. Credit Card orders accepted by phone. Callers welcome. Wide range of goods stocked. Trade enquiries welcome. Plus \$2.00 P&P.
DEALER NETWORK AUSTRALIA WIDE

THE BEST IN BACKUP METHODS IS NOW EVEN BETTER

NOW HANDLES PROGRAMS THAT LOAD SUBSEQUENT PARTS

"Freeze Frame MKII" must have been the world's most powerful and most successful backup product. The success of "Freeze Frame" convinced, is the most advanced and easy to use backup product in the entire world.

Now the "MKIII" version has moved "Freeze Frame" well ahead of the "opposition". As well as its unfailing skill in handling every memory resident program available for testing up to 1st July 1986 it will now transfer from tape to disc the vast majority of programs that load subsequent parts.

- #### FEATURES
- TAPETO DISC
 - DISC TO DISC
 - COMPLETELY SELF CONTAINED, NO EXTRA SOFTWARE NEEDED
 - FILES COMPRESSED FOR ECONOMY OF STORAGE SPACE
 - 128/128D COMPATIBLE IN 64 MODE

OPERATING "FREEZE FRAME"

"Freeze Frame" is simplicity itself to use. It is cartridge based so is simply plugged into the cartridge port. When the computer is switched on a message is displayed, pressing "RETURN" will clear the computer back to the normal start up screen. Software can now be loaded from tape or disc completely as normal. The latest version of "Freeze Frame" will, to the best of our knowledge, allow ANY software to load and run normally (unlike competitive products).

- "Freeze Frame" can be brought into operation at any convenient point by pressing the button on it. You can then do one of three things:—
1. Pressing "D" will save a working version of the program in auto booting very high speed reload (many programs reload in less than 30 secs).
 2. Pressing "S" will save to disc with a standard reload speed that can be used by non 1541/70/71 drives U.S. spec. machines, etc., but perhaps more importantly by most fast load cartridges and systems. Use "Dolphin DOS" to reload anything in less than 10 secs. (Also suitable for U.S. spec. machines.)
 3. Pressing "T" will save a working version of the program in memory to tape. This incorporates a high speed reload at approx. 2400 baud.

IT'S AS SIMPLE AS THAT
ALL PROGRAMS SAVED WITH "FREEZE FRAME" CAN BE RELOADED INDEPENDENTLY OF THE UTILITY

ONLY \$99.00

Owners of earlier versions can return them and upgrade for £14.95.

SERIOUS WARNING: THIS IS AN EXTREMELY POWERFUL PRODUCT AND IS STRICTLY FOR PERSONAL USE. DON'T COMPARE IT WITH ANY OTHER PRODUCT, NOTHING ELSE OFFERS THE POWER OF "FREEZE FRAME".

Made under licence to EVESHAM MICROS
Manufactured in S.A.
Offers subject to availability

Send cheque, Postal Order or Credit Card No. Credit Card orders accepted by phone. Callers welcome. Wide range of goods stocked. Trade enquiries welcome. Plus \$2.00 P&P.
DEALER NETWORK AUSTRALIA WIDE

Amiga Column

by Craig Schuettrumpf

THE AMIGA personal computer is supported by some amazing creative software. This month I would like to give an overview of what is available (and coming soon) and its advantages.

Because of the Amiga's advance graphic, animation and sound ability a considerable amount of creative software has been released. Packages utilizing these unique abilities have given very powerful tools to the professional and enthusiast alike. With the range of software covering professional music generation through to animation tools no specific market for the Amiga can be defined, thus making the Amiga PC truly flexible in application problem solving.

The majority of software has been generated in the United States and U.K. Software development companies saw the Amiga as a powerful machine in design needing specialized software to utilize its unique features. As the Amiga picks up momentum in the market more Software houses will join the list of developers. Companies like ELECTRONIC ARTS have generated first class creative software packages including professional paint packages through to Amazing Arcade games.

We are reaching that stage when there will be an Amiga Software boom where a lot of software and peripherals will be introduced.

Business software

Applications are now available for accounting, wordprocessing spreadsheets, telecommunications, information management, outline processing, statistical analysis, investment analysis and project management.

Chang's lab's Rags to Riches series includes a general ledger, accounts payable and accounts receivable. This package is sold in a modular form allowing the user to design their own system.

Textcraft is a very simple but powerful wordprocessor for the Amiga. It is icon driven with mouse commands for page setting, changing fonts, underlining etc. A full featured simple wordprocessor. *Scribble* is another wordprocessor more advanced than *Textcraft*.

Spreadsheets are able to be generated on your Amiga using *Unicalc* or *VIP Professional*. These are high powered spreadsheet design packages utilizing speed and ease of use.

VIP Technologies is developing an outline processor, a wordprocessor, statistical analysis program, a spreadsheet program, a project manager and desk top publishing program,

all of which will be capable of sharing files. *VIP professional* is available now with similar features to *LOTUS 1,2,3*.

Databases are currently being completed with products like *Datamat*, *Superbase* and *Acquisition* fully utilizing the Amiga's filehandling and multilisting abilities. These databases incorporate IFF format data input abilities. This enables 'picture' files to be parted from paint and digitizer software packages. Now you can have a database which has both a picture and description of what you are cataloging.

With the release of *Sidecar* due by the end of the year the large catalog of MS-DOS base product will also be an option to the business orientated user.

Graphics software

Several development companies are supplying software packages that utilize the unique 4096 colors, high resolution, graphics and custom chip of the Amiga. As a result professional tools have been made available inexpensively.

Graphicraft is one, Commodore's graphic package for the Amiga. This is a cheap but powerful introduction to Amiga computer design.

Electronic Arts have released a series of products for the Amiga. One very powerful graphic design package is *Deluxe Paint*. This is driven by the mouse utilizing pull down windows for modification and saving library commands plus a control panel with commands like draw and brush size modification. This package is easy to learn.

A similar package is available from Aegis Development Inc. called *Aegis Images*. This has features including draw and paint fill. Other special effects include colour graduation and a finger painting option that lets you smear colours across the screen.

The professional would find both packages advantageous to use together as files are compatible and each has unique features to apply to design.

Impact is a presentation business graphics program from Aegis that lets you create a series of three dimensional images for presentation or printing. This will be available soon.

For people looking for CAD (computer aided design) several packages are available.

Aegis Draw is a powerful CAD package allowing computer design to be done simply. With commands similar to a paint package it includes specialized commands for sizing, accurate dimensioning rules and structured draw.

Future products include 3D modelling and 'Auto CAD' abilities. Titles like *Dynamic CAD* and *Aegis ProDraw* will have these advance features.

Deluxe Print creates customizing printing on dot matrix

AMIGA

printers and integrates with deluxe paint. Print cords, banners, business cards and calenders. A very flexible package utilizing the graphic ability with printing on the Amiga.

Sound software

Programs in the music area range from utilizing the internal voices through to soundscaping and MIDI control.

Several very powerful packages are available now. Because of the structure of the software involved information can be exchanged from one package to another.

Two packages are available unitizing the internal sound ability of the Amiga. These include *Music Studio*, *Music Craft*, *Music Construction Kit*, and *Instant Music*.

Music Studio is fully mouse driven. By using pull down windows and screen controls the user simply moves music notation and puts it on the staff. Four voices can be played at once generating chords and harmonics. By utilizing the internal in-built sounds it is simple to combine any instrument to generate effects. This package supports MIDI so scores can be used to control external instruments.

Instant Music is a simple music generation package that allows someone that knows nothing about musical notation to generate instant music. By using the mouse you can 'Jam' with the many in-built scores. You can write your own scores by 'pitching' the note graphic on the piano roll type screen. It comes standard with in-built sounds to use in generating music.

Two hardware devices are worth mentioning here. The MIDI adapter and sound sampling software. The MIDI adjuster is a small piece of circuitry that is added externally to the Amiga. MIDI stands for Musical Instrument Digital interface. This allows the computer to 'control' external midi equipped instruments. Because of the computer's speed and 'recording' ability full pieces of music can be controlled and edited. This interface retails for about \$150.00 and usually comes with the professional music packages.

Sound sampling is the ability to 'digitally' record information for modification and playback. Sound can be recorded by using a small hardware adapter and controlling software. The device will take both a microphone and line input. A lot of the sounds highlighted in sound design packages utilizing internal voices were generated using a sound sampler. Record instruments such as violins, dog barks, trumpets etc. and port them over to be used in *Instant Music*, *Music Studio* or the professional *Mimetics* package. This device is available now and retails with software for around \$390.00.

A professional music package utilizing both internal voices and MIDI control is now available in Australia. The *Mimetics Soundscape* package. This allows 16 track MIDI recording, the combination of internal sampling and MIDI control.

Video

Now the Amiga is capable of the PAL Video format. Amiga

images can be successfully 'dumped' onto video tape - another way of saving pictures.

This has opened the way to software packages such as *Deluxe Video Constructions Set* from Electronic Arts.

Deluxe Video allows the user to design their video productions utilizing the Amiga's graphic, animation and sound ability. It is the first design package that allow such features as rotation and 'flipping' of character and graphic information. The overtaping of text on graphics is possible utilizing the many in-built fonts.

Graphic images and the basis for animation can be ported across from *Deluxe Paint*, *Graphicraft* or *Aegis* images. Sound can be parted across from *Instant Music*, *Music Studio* or the *Sound Sampler*. Now there is a software package that will allow you to design anything from banners or presentations through to your own Music Videos.

In future months the above products will be reviewed in depth. I hope this has given you an insight into currently available creative products.

Next month I shall review *Soundscape* from Mimetics and give an overview of entertainment products available for the Amiga. Any further information you might need can be found by contacting me at 957-4778. Until next month.

BY COMMODORE®
AMIGA™

ATARI® 1040 ST
1 MEGABYTE POWER

commodore
COMPUTER

Wide range of hardware: Software accessories, Books & supplies
SPECIALISING DEALER
AUSTRALIA WIDE DELIVERY

The
Computer Place

NORTH SYDNEY
Tower Square
155 Miller Street
(02) 957 4690

BANKSTOWN
Cnr. Appian Way &
North Terrace
(02) 708 5843

Compute!'s Beginner's Guide to the

AMIGA

by Oliver Bartholemews

Gather round for I've a tale to tell. A tale of woe and shame. Almost a fable.

A young man, of very sound intellect, if less well supplied with common sense, set forth one bright afternoon to the stately halls of fame to seek his newest acquisition. The famed Amiga computer.

Beginning with confidence, software and peripherals, he set about installing this prodigious machine in his home. With much enthusiasm he wrote an article on his new Amiga. Then with zeal and vigour he hooked up via the switchboard and commenced to send data. 100 bytes arrived intact. The rest, well I think a dragon ate the telephone lines with them still on it.

The moral. He should have had Compute!'s Amiga manuals from CBS. And he should have read them for therein lies much knowledge of undoubted worth.

The Beginner's Guide to the Amiga is where I began.

Dan McNeill claims it is "the perfect beginner's guide to the Amiga personal computer from Commodore, everything from setting up your computer to choosing the right software".

He claims it will be a constant companion. He claims to examine "all the software available" (in a two page liftout) and then scrutinize the sound and graphics capabilities.

Well, after the history of the world part 3, we have three checks for Jack Tramiel and then he is put in the sin bin for buying Atari.

The history lesson over, Dan tours and sets up the Amiga machine. Helpful hints and tips, terms of common usage receive attention. Disks, windows, icons, scroll bars, menus. As Dan intended, this is an A1 book for an absolute beginner. He indulges in literary frolicking to illustrate an excerpt.

"Video: The Iridescent Plain.

"This screen is your first sight when you turn the Amiga on and it's impressive. Indeed the names of some of its items - sprites and playfields - suggest an elfin paradise, where imps dance and cavort."

The audio capabilities, its multitasking, emulations and expandability all receive a similar treatment. A brief foray into prose and then a simple overview and definition.

Chapter Three, I am sure, is modelled on the Kama Sutra. Subheadings include, in order, A Place out of the Sun, Plugging In, The Ports, Turning On, The Climax, and Final Precautions.

So now the Amiga is functional, Dan McNeill discusses in detail the Hardware. Again a beginner, an absolute novice, a "babe in computer woods" would find final comprehension in his easy flowing, if a touch verbose passages. Each major point is given a detailed example in everyday life.

McNeill uses contemporary quotes to sum up his sections. Part Two, Hardware, begins with this succinct quote from Andy Warhol. "Machines have less programs. I'd like to be a machine."

Figure 4-1. Elements of Human Problem Solving

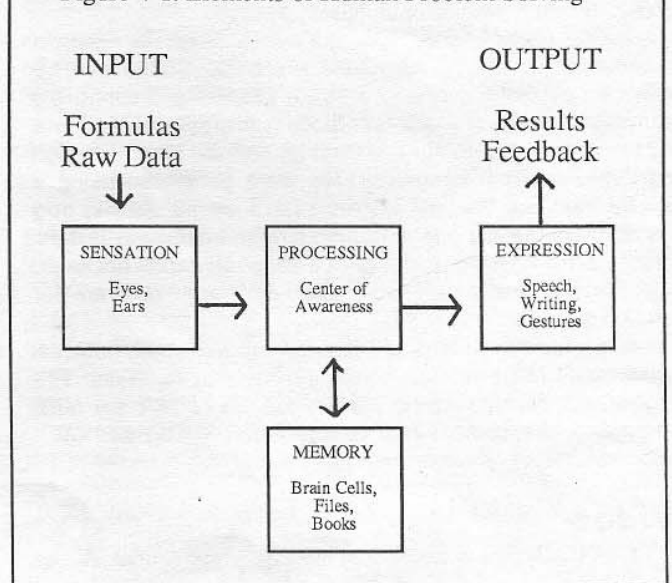

AMIGA

Part Three discusses Software. A very applicable quote is given. To a beginner it installs a state of mind which prepares you for the ideas and concepts to follow.

"The city of Sophronia is made up of two half-cities. In one, there is the great roller coaster with its steep humps, the carousel with its chain spokes, the ferris wheel of spinning cages, the death-ride with crouching motorcyclists, the big top with the clump of trapezes hanging in the middle. The other half-city is of stone and marble and cement, with the bank, the factories, the palaces, the slaughterhouse, the school, and all the rest. One of the half-cities is permanent, the other temporary, and when the period of its sojourn is over, they uproot it, dismantle it, and take it off, transplanting it to the vacant lot of another half city." Italo Calvino *Invisible Cities*.

For a beginner this book is all you could ever want. Even if you don't own an Amiga. The discussions cover generalities like the languages computers use. Fifteen pages are devoted to bringing binary to the people. I can only say that it does the task it is set to do. My wife now understands binary - there is hope for the rest of the world.

There in the pages lie the pith of Boolean Logic theory and the Gate theories. Ever wondered how the Hi-Toro people could get 4096 colours on screen at once? What is 'Hold and Modify' mode? How they can address 32 colours at once with only 40K of memory?

McNeill claims to review all software available for the Amiga. A vain boast? No. Again for beginners it is a wizard section. The software is grouped under sections. Operating Systems available, their highs and lows. Programming, the languages used. Word processing - the tools like margins, identification fonts and print applications and a review of one word processor package plus accessories, such as fonts, spell checkers and more.

Spreadsheets, what they are, why they are and what for plus the task and basic commands. Databases, an overview and structuring guide. The integration software for Amiga and its emulations. Here we are told honestly what Amiga can and can't do. Turn it into a PC. A little is sacrificed but at this price, it is worth it.

Under Games, we see the arcade games, simulator adventures and strategic games given a brief look. After all that is our job, not his.

Overall. This book will be a vital sidekick to anyone who needs to know more about computers in general and the Amiga's vast capabilities. Dan McNeill, although verbose, covers very well all the major areas with an efficient teaching skill. From modem use to MS-DOS history, it is all there and very well done.



Figure 4-2. Elements of Computer Problem Solving

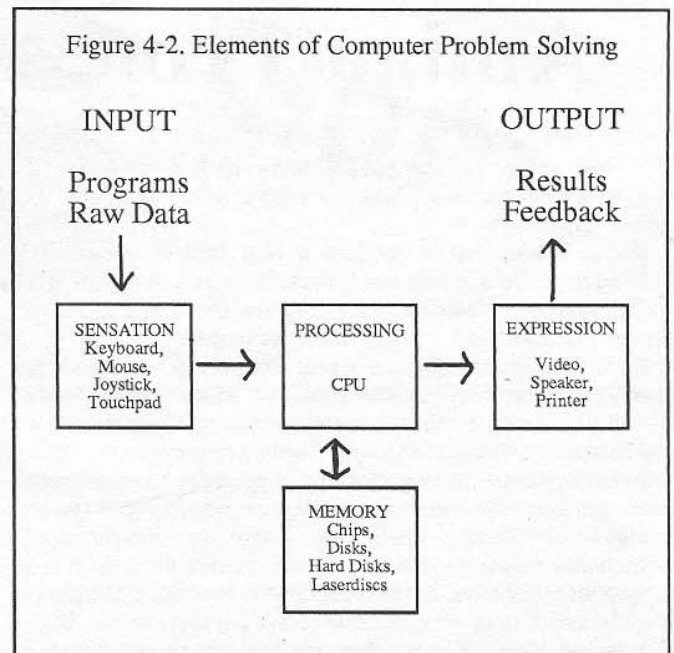

COMPUTE'S AMIGA TITLES



Compute!'s excellent range of Computer books are now available. Whatever your need, we have the book for you. Also available: INSIDE AMIGA GRAPHICS ADVANCED AMIGA BASIC

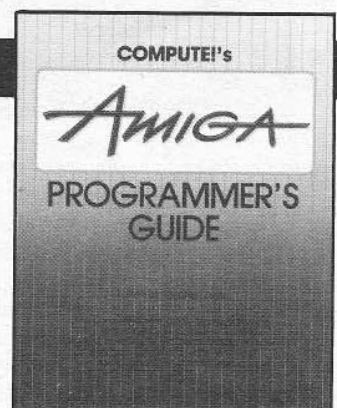

Now available from leading booksellers

CBS PUBLISHING AUSTRALIA Pty Ltd
9 Waltham Street Artarmon. Telephone 439 3633

Amiga Programmers' Guide

In any undertaking of very wide and diverse base, delegating the various areas to expert manpower has its distinct advantages.

For example, the Amiga has a vast task of generating stunning graphics and four channel stereo music of exceptional quality. Answer - delegate. Enter Agnes, Daphne and Portia and the task becomes realised within realistic time frames.

So too a book specified as a programmer's guide stands to benefit by delegation. Thus Compute! pooled the talents of nine computer journalists, novelists and programmers to supply a very comprehensive guide to programming the Amiga.

An eight section text explores and prompts by example a much improved comprehension of the commands and methods employed in Amiga programs. Logically set out and aesthetically pleasing, the book accomplishes its task. It is a comprehensive guide, not a bible, that is too much to ask, as the outer reaches of Amiga's power have yet to be explored.

Imagine. "Beam me up Scotty, it's time to go home. Our five year mission to explore outer space, to boldly go where no LCP has gone before, to advance the fame of truth, integrity and the Australian way of life is almost over."

So Dan McNeill, in a much condensed and economic style, introduced the Amiga. Its abilities, facade, rear panel, interface, audio and video powers and MIDI capabilities. The verbosity however has one last shot in the last paragraph.

"The Amiga itself is an open sesame for programmers. It unlocks an alluring new world, where software can glisten and sing as never before."

Roll Up! Roll Up! Yes, folks, get your very own shining, singing, dancing, BMX riding floppy disk package. Complete with a full set of ASCII characters to clean up after it. Wow.

C Regena, a monthly columnist in Compute! magazine and author of books, opens the door to Microsoft's Amiga Basic. The main variation in Amiga Basic is the additional commands to cater for the superior and diverse functions in the sound/graphics area.

The Basic section is in three parts. A dictionary of Amiga Basic commands, and brief explanations of each one. All parameters are shown and demonstrated. Following is a section on file processing commands and sub programs are included with most descriptions. In all a full and exhaustive coverage.

Charles Brannon, a program writer and programming editor for Compute!, is the man to explore Amiga DOS. The windows, ikons, CLIs and devices come under his electron microscope. A list of the most useful Amiga DOS commands and descriptions is included, leaving the impression that there must be a lot more commands of lesser usefulness.

A whole chapter is devoted to batch files, a quirk of Amiga DOS to enhance program power in this language. The idea is to simplify repetitive function and commands in a patch of code.

Chapter 5 has a red title page with a white heading. Graphics, Sheldon Leemon. This gentleman, a freelance writer based in Michigan, is an authority on Amiga DOS and graphics.

Apparently the Amiga has three levels of approach to graphics. One via the custom display chips, two via the operating system kernel and three via the user interface called Intuition! Intuition allows the multitasking capabilities the Amiga is famed for.

By examining the full set of graphics commands and the result they deliver, we are given an impressive tour of the artistic temperament of Amiga. Numerous Basic programs fully describe their functions.

The animation capabilities of the Amiga, much improved by the blitter chip (block image transfer) which is resident, use either sprites or bobs (blitter objects). Virtual sprites or VSprites make whole screenfuls available within limitations. The ways to create, manipulate, collision control and destroy objects are outlined with a natty little UFO, bob programs included, using acceleration, collision protection, and rebound. Pinball stuff.

Logical progression leads to the vast Amiga Sound by Philip Nelson. You don't have to be a programming wizard to make the Amiga talk. Included on the system disk is a utility which can translate raw English into "phonemes" and the result is impressive. Nelson includes a Speech Experimenter listing to let you type in any string, hear it spoken, see the resulting phoneme string and experiment with any voice parameter. The listing runs to three pages.

An intensive discussion of the Amiga's amazing sound manipulations follows with comprehensive tales listing Voice Channel Assignments, Voice Array Elements, Translate and Special Features and Voice Synchronization.

A 3 1/2 page listing for an Phoneme Builder sets you up to program the whole way including start up message.

Sound and Wave in Basic receives an entire section to itself with tables and diagrams to illustrate and teach. A Waveform Builder Program is included, four pages of code! Advance Sound and then Machine Language Sound follows with complete tables featuring. And not to disappoint, a three page Machine Language Sound Program and Machine Language Filemaker. Mr Nelson does a worthy job.

Chapters Six and Seven are devoted to Languages, Machine and C. I could add very little to the text except that you could not expect to learn C or Machine language in one chapter, albeit over 100 pages long. However the features, quirks and powers particular to the Amiga are documented and the compilers available for C and Machine are discussed.

Important features are the Index and Appendix. A full and exhaustive Index, an Amiga DOS command summary, full commands for the kernel routines and DOS commands under emulation plus a table of frequency values for the musical scale bulk out the last section to 60 pages of compact reference material.

On the whole, the combination of talent is evident in an economic and unpretentious book, well bound and presented. At \$37.95 from CBS (02 493 3633) it is a good investment.

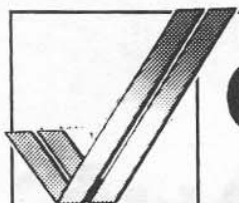

COMPUTERSCOPE



BY COMMODORE®

AMIGA™ AVAILABLE

Ask about our special Amiga software deals

C-64

*** MAIL ORDER SPECIALS ***

Dragon's Lair (C)	\$32.00
Give my regards to Hollywood (D & C)	\$19.95
Boulderdash (D & C)	\$19.95
Sorcery	\$14.95
Frankie goes to Hollywood (D & C)	\$14.95
Shadowfire (D & C)	\$19.95
Rocky Horror Show (D & C)	\$19.95
Superman (D & C)	\$19.95
Rendezvous with Rama (D)	\$29.95
Nexus (D)	\$32.95
Nexus (C)	\$27.95

Call or write for our free mail order catalogue.

Computerscope Mail Order
4/15 Florence St,
Hornsby, NSW 2077

(02) 477 6886

NEOS MOUSE	\$139.00
FINAL CARTRIDGE	\$139.00
PACTRONICS DISK DRIVE COMPATIBLE DRIVE FOR THE C64	\$299.00

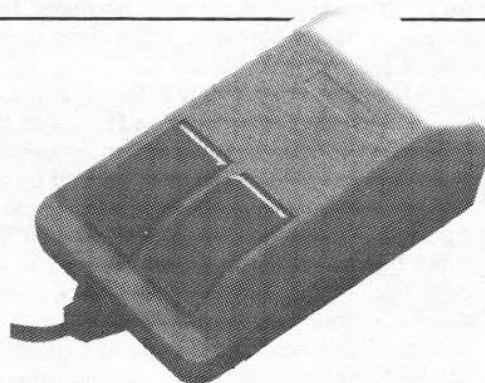

We stock a full range of Commodore compatible printers:
* Star * Riteman * Okimate *

Computerscope
4/15 Florence St
Hornsby, NSW 2077
(02) 477 6886

Computerscope
Shop 2, Cnr Kildare & Patrick Sts
Blacktown, NSW 2148
(02) 831 1718

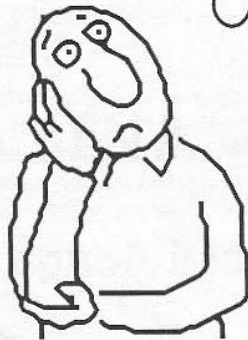

Out-Think

by K. J. McCoy

Computer: Commodore 128 in CP/M mode.
 Publisher: KAMASOFT, Inc. 2525 SW 224th Avenue,
 P.O. Box 5549, ALOHA, OR 97007, U.S.A.

It's great owning a computer which is so versatile that sophisticated software, available only for BIG BLUE and his mates, is now specially formatted for the Commodore 128. I am talking about *Out-Think* by Kamasoft, an ideas or thought processor which I have just discovered and now don't know how I did without.

We are all familiar with the serious applications which have been the prime reason that people give for owning a personal computer; the word processor, the data base and the spreadsheet. The first processes our words and saves reams of paper because all of the drafting can be done before committing a word to print. The data base processes information, many, like *Superbase*, with a great deal of panache. The spreadsheet is a numbers processor which provides all budding Allan Bonds with a powerful tool for predicting the money market or the Uriah Heeps of the diminishing resources of our bank accounts. Not so familiar to Commodore users, however, is the ideas processor because this is the first produced for the 128.

Out-Think is available only in CP/M format, and provides a really good excuse to use that new feature on the 128. You will need at least one 1571 disk drive, an 80 column monitor (you can use a 40 column monitor but it would be tedious scrolling across the lines all the time!). *Out-Think* comes with a very comprehensive manual which, would you believe, clearly outlines how it operates. Also contained in the package is another book called *Read Me First!* which allows you to install *Out-Think* on your 128, but more of that later.

An ideas processor allows you to organize your thoughts, to establish lines of relationships between ideas or information, to sort out the wood from the trees if you like. To get a picture of how *Out-Think* works, imagine a tree which starts with a trunk and spreads out into main branches, lesser branches and finally to leaves. This is the terminology which *Out-Think* uses. The main idea forms the trunk, the branches sub-headings and the leaves the detailed and particular information about topics associated with the branches. At any time you can shift branches, promote and demote them. You can add new leaves which are text areas of about 2K which can be edited at any time.

The following model will provide an idea of how *Out-Think* works:

- + Outline Processors
 - + Menu
 - * Topic Manager
 - + Outline Editor
 - + Brainstorming - getting ideas down
 - * Expanding and collapsing
 - * Inserting headings
 - * Moving
 - + Leaf Editor
 - . Editing
- * Search
 - . Through current file
 - + Global search
 - . Through other files on this disk
 - . Through other disks
 - . Transferring data
- + Printing
 - * Print format menu
 - . Printing whole file
 - . Printing a leaf
 - * Installing your printer

If you look at this model you will see that *Out-Think* uses both position and symbols to determine the importance and information available on each heading. Headings in the same column have the same status. The further a topic is moved to the right the less important it is. The symbols also tell how much detail is available, these will be explained in a moment. The view you have here is of the topic in the Outline Editor after it has been expanded. It can be collapsed so that the only things which appear are the headings in the left hand sub-titles column.

The symbols at the beginning of each line mean that there are varying amounts of detail available. The '+' indicates that there are branches from this heading; '*' means that this branch has a leaf; '.' means that there are no further branches to this heading. Topics and branches can be marked for moving and for referencing in searches.

SOFTWARE REVIEW

It is easy to see from this simple model how topics and sub-topics can be organized, and how relationships between ideas can be planned logically. The leaf editor is really a simple word processor, which, if you use a CP/M word processor like *Wordstar*, can be "boilerplated" into prepared text. Likewise, a store of these can be kept and transferred between files and topics, as required, in a search routine. This example barely scratches the surface of the capabilities of this program.

Editing with the 128 is simpler than for some other machines. *Out-Think* allows the user to set up commands similar to *Wordstar* or for *Perfect Writer* both of which have very complex command systems. The cursor keys on the 128 simplify this process to some extent. For example if you use the 128 cursor keys at the top of the keyboard you can move left, right, up and down a character at a time. If you use the left/right cursor key at the bottom, however, you can move back and forth across a whole line. This is much simpler for us Commodore lot than the *control* and *escape* key commands which the less fortunate Osborne/Kaypro *et al* users are stuck with.

Out-Think is a writing tool, a researcher's dream-come-true. It is a means to organize your ideas into an outline, to develop a theme, to program a thesis or to organize the administration of a business or school. *Out-Think* demo programs which come with the package allow you to set up weekly calendars with seven topics - Sunday to Saturday. In its collapsed form you would have on the screen just those days listed. To find out about details just cursor down to the appropriate day and expand it! On a word processor you would have to go past all of the other information before you singled out what you wanted or set a search pattern going. Monthly and yearly calendars can also be created. The lists produced by *Out-Think* are ideal because in their collapsed state you can see the over-all plan but you can instantly zoom in on areas where you need to find detail. Key-words can also be set up so that if you wish to find all the references to a given topic or name it will do that with ease.

The uses *Out-Think* can be put to are seemingly endless. It even provides a Flash-card Quiz option! By pressing F you can quiz yourself (or a class) on the information in a topic and then check the answers. It automatically makes up a table of contents (if you want) when it prints out a topic providing numerical information as to the status of each heading or topic and the page number where that will be found, as for example:



Outline Processing

1. Menus.....	1	
1.1 Topic Manager.....	1	
1.2 Outline Editor.....	2	
1.2.1 Brainstorming.....	2	
1.2.1.1 Expanding/Collapsing.....	3	
1.2.1.2 Inserting Headings.....	4	
1.2.1.3 Moving topics.....	6	
1.3 Leaf Editor.....	6	
1.3.1 Editing.....	7	
2. Search.....	9	
2.1 Through current file.....	9	etc.

Out-Think is the ideal tool for constructing a family tree. You would be able to collapse and expand at will sections of the tree, with enough room for anecdotal information and historical documentation. Other uses for *Out-Think* could be such things as scheduling in project management, preparing agendas or notes for speeches; the list is only limited by your imagination.

Before you can use *Out-Think* it must be installed on your computer. This is where the book Installation Instructions is very important. Upon loading *Out-Think* you are presented with a menu from which you tell it you are using a 128, how many disk drives you have, and special printer codes you might want to use and also which form of command you wish to use (*Wordstar* type or *Perfect Writer* type). This process is relatively straightforward and painless but keep your CP/M instructions from the 128 Users Guide handy so you find out how to format a CP/M disk and copy (PIP) files from the main disk. Once the program is installed on the copy disk, put away your write protected Master Disk because once *Out-Think* is run the installation instructions are ERASED from the disk and making further work disks becomes impossible!

On start up you can select the level of help you want available - and that is plentiful at level three. You can also secure your files from others; if you choose 0 no password is required. On the other levels if you get the password wrong you are unceremoniously taken back to the start up screen for CP/M.

The instruction manual, an excellent document, does assume the user has two drives. I have used the system with both one and two drives and find it supports a single drive quite well, provided you refer to drive 'A' (or to the virtual drive 'E' when using PIP). After initializing, there is little or no disk swapping to be done so one drive which has 220+K of memory is adequate.

Out-Think is a powerful tool designed to augment your word processor, data base and spreadsheet. It is fast and flexible and benefits from the speed of disk access through using the CP/M dos. Its printing options are comprehensive but it will not replace a good word processor, it is not designed to. Even if you don't use CP/M for any other reason on the 128 *Out-Think* will justify its presence.

At writing I don't think *Out-Think* is yet available in Australia. I sent direct to the address given above giving my VISA card number and had it back in my hot little hands ten days later. The cost depends on the value of the Oz dollar. It cost me \$65.00 plus postage. (The Oz dollar at that time was about US\$0.61). For what you get, it's great value for money!

Capture Cartridge

- easy archiving and eprom burning

by J. McLean and W. Sharpe-Smith

Manufacturers of software continue to protect disks, producing software that is damaging to the heads of disk drives and prevents the owner from having spares in the event of damage to software.

Capture is a cartridge used to produce Archival program disks and allows the additional convenience of providing easy manufacture of cartridges, for the speedy loading of programs.

Capture claims to provide a simple, foolproof method of making auto start cartridges when used in conjunction with the Promenade CI Eprom burner and any of the CPR family of cartridge kits.

If the original is protected, *Capture* simply and efficiently breaks the protection.

For use on the C64 (not the SX-64), the cartridge is placed in the expansion port and the original program loaded.

A button on the cartridge is pressed to "Capture" what information is in the computer at the time.

Lion Electronics import the unit from America.

Menu Options

There are five menu options, consisting of:

- 1. DISPLAY RAM.** *Capture* deals with memory in 2K sections. A RAM usage map is a list of RAM pieces *Capture* has marked as used. This is useful to look at where the program is put in memory, and useful for a hacker to change the program around. This is used by the experienced user, not the beginner.
- 2. CONFIGURE RAM.** Which writes on \$FF character to each memory location from 2048 on up, and then returns you to BASIC. This is used just before capturing data. It clears the memory ready to accept programs and accepts raw programs before returning to a standard screen. It overcomes the usual problem of having to enter a program and reset pointers before burning eproms.
- 3. MAKE PROGRAM DISK.** When you have paid your \$88.95, this is the main use. A sub menu requests information on the file name, device number and drive number. This will provide backups of many, but not all, disks in 2K chunks. The captured program is redrawn to a formatted disk. A separate file of the disk drive's RAM can be added to the disk as a sub-menu selection.
- 4. MAKE PROGRAM CARTRIDGE.** Using CPR Cartridge Kit and a promenade CI to make an eprom.
- 5. LOAD AND EXECUTE DISK PROGRAM.** Provides a convenient way of loading a desired program from disk and executing it automatically. Specifically, this allows regrouping of 2K chunks into larger chunks.

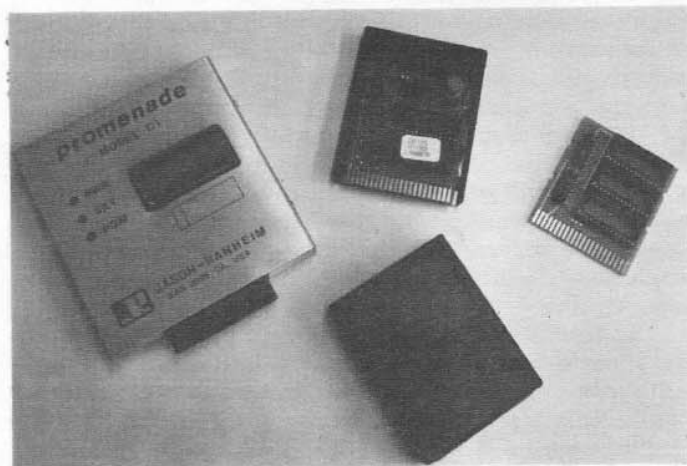

Limitations

Programs that will not "capture" successfully are ones where it is necessary for the disk to be constantly accessed. Some run time savings are effected. These can be considerable, but in more sophisticated programs, the savings are not large.

Pittwater Distributor's program, *Electronic Card File*, was chosen at random for comparison. This loaded in standard DOS in one minute, six seconds. The same program put through '*Isepic*' resulted in a run time of 20 seconds. *Cockroach Turbo Rom* loaded in 25 seconds, including typing the run command. Auto boot on *Isepic* saved a few seconds.

Capture's result was 56 seconds which was a substantial improvement, but not a top result.

Capture Cartridge Disk Archival resume

- 1. Ease of use.** The disk based dump of target program is easily executed, but extremely slow in operation.
- 2. Advantages.** Program may be saved in any state, e.g. loading, running, stopping, with added data etc. Forced error protection is automatically removed in the process.
- 3. Disadvantages.** The conversion process is very slow especially on the larger programs. The converted program stored on disk as a series of 2K byte files. The disk directory becomes excessively long, causing problems with loading, reading, sorting and printing of disk directories. Multiple 2 files cause excessive stopping of drive head, causing long load times and sometimes even complete load failure. *Capture* is incompatible with Epyx *Fastload*, (and probably others), but was OK with *The Final Cartridge* and *Cockroach Turbo Rom*. A program refinement will be made available free buyers at some future date to solve the 2K file problem.

UTILITY

Cartridge making

This is not cheap to set up. Your costs are a *Capture* cartridge for \$88.95, a Promenade Eprom burner for \$228, a CPR cartridge kit for \$36 and an eraser for \$80. A total of \$432.95 - now don't forget to buy your chips!

The main difficulty in burning Eproms is setting the program pointers, and it is not convenient if a boot must be written. This is usually the premise of the erudite programmer with a comprehensive knowledge of machine language to analyse the pointers.

A cartridge that meets the *Capture* claim of making simple, foolproof autostart cartridges is a wonderful vision indeed.

For anything to be called foolproof, you first need a fool, and John McLean offered his humble services in this area. Co-writer Sir William, having exceeded his three score and ten years, viewed the proceedings from a safe position to ensure the status quo. Proprietor John Fomenko was chosen to do the hard work. We chose *EasyScript*, which has reduced grown men to tears with other systems.

We used the recommended chip, which is the NEC 27256 (32K), and has proven to be essential, presumably due to the high quality. Then we followed a simple procedure. Firstly, we ran *EasyScript* from the disk. 'Configure RAM' option was run, which took only a few seconds. We then captured the information, a simple press of the button on *Capture*.

The Promenade burner was already plugged in the

computer's user port, and in response to on-screen prompts for control words to be inserted for the core eprom and data eprom we responded with 5 and 229. This is from the menu selection 4, MAKE PROGRAM CARTRIDGE option.

The numbers represent the burning voltage and is in the instructions. The red light on the Promenade glowed red for a minute or so and the screen moved to menu.

We installed the chip in the CPR3 unit, switched the computer off, then on. No SYS numbers are needed (auto-start) and in a few seconds three smug grins attested to the unit's success.

CPR units use one 'core' eprom one two 'data' eproms of 8, 16 or 32K capacity and can carry programs up to 64K.

Conclusion

The unit is worth the \$88.95 for the Archival advantages, particularly the ease of use. It is the least expensive of this type of cartridge.

The eprom advantages are a bonus and if the burning of eproms is not a priority, it should not deter you from buying. The unit comes with a 90 day guarantee. The demonstration *Capture* cartridge suffered from a dry joint, but Lion have always proven willing to exchange units.

Capture is available from Lion Electronics, 314 Great Eastern Highway, Midland, Perth WA 6056. (09) 274 4519. Dealer enquiries are also welcome.

NEW **stair** NL-10 WITH PLUG-IN INTERFACES

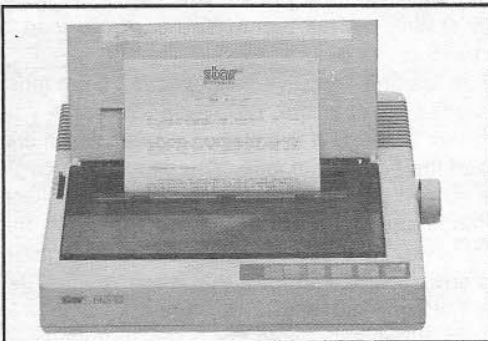

for
IBM,
PARALLEL,
COMMODORE,
APPLE IIc OR
SERIAL

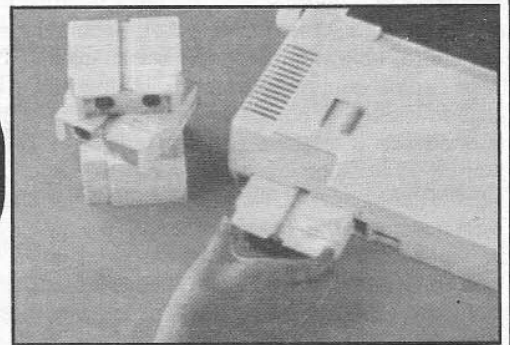

MANY MODELS OF PRINTERS IN STOCK
PRICES FROM \$410
SEE FULLY DEMONSTRATED AT

THE PRINTER SPECIALISTS

31 ELGIN STREET, EAST GORDON, NSW 2072.

(02) 498-7541 and (02) 498-3333. MAIL ORDERS WELCOME



TITANIC

by Daniel Farrell

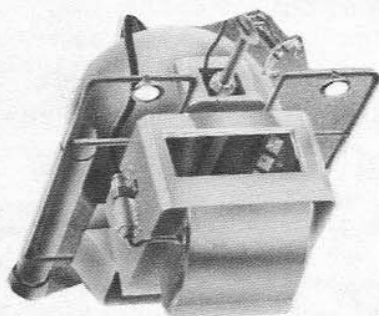

Australian Commodore Review Evaluation Card

Title: <i>Titanic</i>	Graphics:	88
Machine: <i>Commodore</i>	Presentation:	84
Publisher: <i>Electric Dreams</i>	Documentation:	86
Distributor: <i>Imagineering</i>	Sound:	82
Price: Disk \$38.60	Music:	78
Cassette \$28.40	Impact:	86
	Overall:	86

Comments: Rather sad implementation of several aspects, such as the objects with the Titanic. Impressive graphics with realistic effects.

On April 10th 1912 the *Titanic* sailed out of Southampton with 400 crew, 518 hotel staff and about 1300 passengers. Four days later at 11.40pm the Officer of the Watch was warned of an iceberg ahead. He quickly turned the helm to port, but unfortunately the *Titanic* didn't respond in time. A 300 foot (92 metre) hole was cut in her starboard side by the iceberg. The *Titanic* could apparently still stay afloat with five of its sixteen watertight compartments flooded, but the iceberg had flooded six. Captain Smith and designer Thomas Andrews started evacuating people immediately and ordered S.O.S. signals to be sent out. No-one came in time! About 1500 people went down with the *Titanic*.

Recently a small submersible went down to the *Titanic* wreckage and secured eight inflatable bags on the port and starboard sides. Because of a fault in its memory the positions of the bags were not recorded. Your job is to find the bags and press the button which will inflate the bags, and thus bring the *Titanic* to the surface.

At the start of the game the screen will appear with a calendar and five squares. The calendar shows the date, which will be the 15th April. The squares are your choices in the order of The Dive, The Finance Room, The Press Room, A Night's Rest, Saving and Loading. Once leaving a room you will automatically return to the calendar.

A Night's Rest: If you choose this square the date will change one day. Don't take a night's rest at random though, because you need as much time as you can get.

The Press Room: The Press Room consists of many faces on a wall asking questions which appear in a bubble. You have many choices for answers. Think about your answers because it will count later on in the game when you talk with sponsors.

Also in the Press Room are microphones and cameras, which have no purpose other than being part of the scenery. There is also a door which is used to exit through.

Saving and Loading: In this phase you can save your position simply by stating the file name. You can also load a position that you have saved before.

The Dive: Before starting The Dive I suggest you learn most of the remarks needed when in the *Titanic*. In this mode you start with a map of the *Titanic* and five places marked which are the four funnels and the hole in the side. You descend through the funnels or the hole to get into the *Titanic*. Once down there you can send things up to be sold or send things to the laboratory to be studied. Also you may move around through doors and up and down levels. I suggest that when you first get down to increase the light intensity. This uses a lot of power from your power unit. When exhausted this taxes your time.

When moving around and going through doors, be careful! Hitting walls can cost a lot when repair time comes, especially if you break the robot arm. To go through an open door, which are the filled ones, just line it up with your sub and push the fire button. To go through locked doors, which are the ones not filled in, you must drop the right articles in front of the door. This is a boring job if you don't have the right articles. I never found them.

If you forget the way back to the opening don't forget to use the S.O.S signal. After a telephone call rescuers retrieve you and the sub.

Overall I think this is a very good game with superb graphics and good music. This game is a must for all adventure game lovers and anyone who enjoys sitting in front of a computer for a while seeking entertainment. It Won't Let You Down, Or Will It.

ACCESS

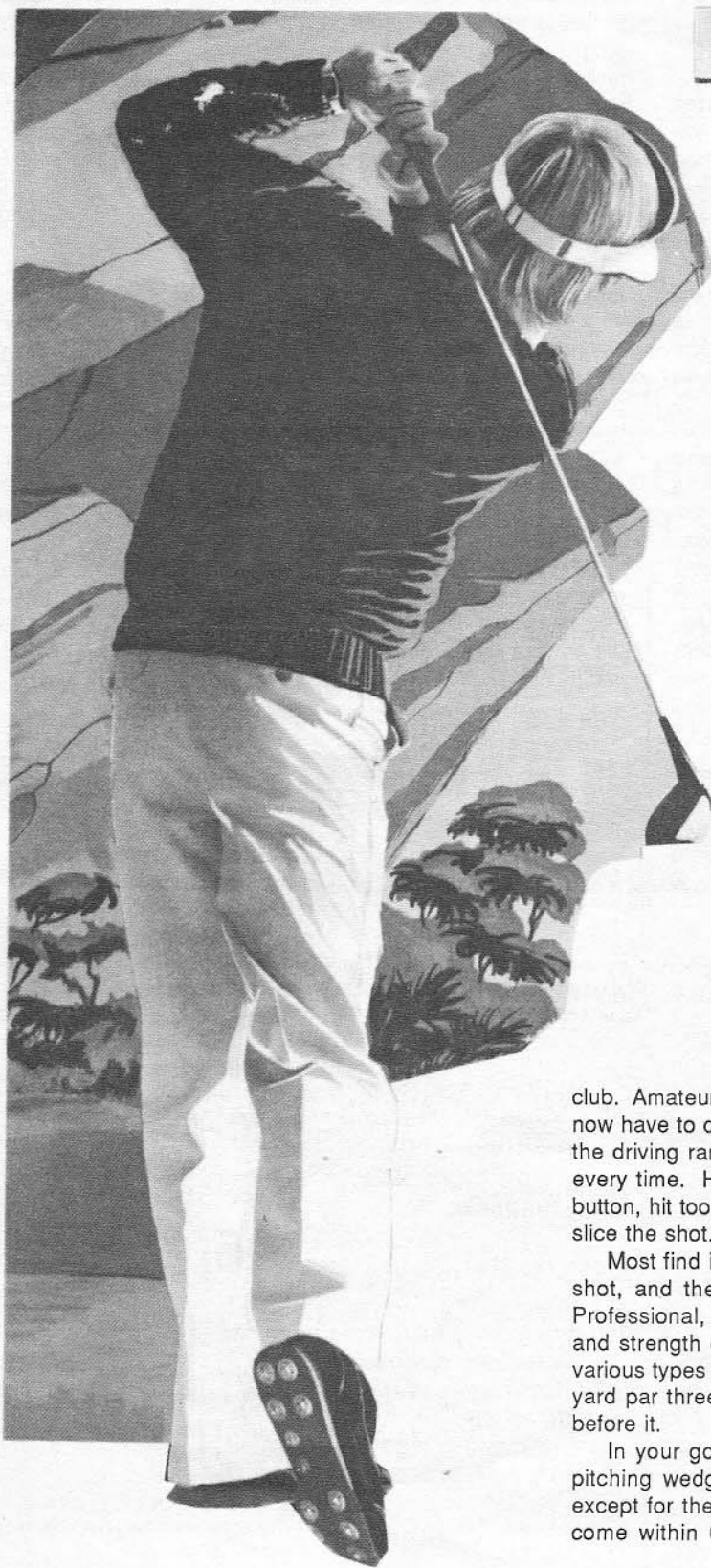

LEADER BOARD

by Phillip Dean

You may not be the 'Great White Shark', but now you can play a challenging 18 holes of golf at any time and return at the top of the leader board. *Leader Board*, the latest offering from ACCESS software (makers of *Beach Head I & II* and many others) is the most realistic golf game around. Very quickly you will be suffering the anguish of many golfers before you as you slice the ball into the water, or the joy of the Pros as you sink that 60 foot putt. *Leader Board* is not just a golf game, it's a golf simulator, with 3-D animation, and a true perspective view for every shot.

To be the champ, you have to possess concentration, coordination and control. You will need to judge distances, power of your swing, and which club, all correctly if you wish to come in under par, on the four different challenging courses.

Leader Board allows for up to four players, each being able to select from three different skill levels. There are four different courses of varying difficulty and you can play either 18 Holes, 36 Holes, 54 Holes or 72 Holes, providing numerous hours of challenging golf. There is also a Driving Range for those (which is everyone at first) who need a bit of help with their driving.

The three skill levels are Novice, Amateur and Professional.

Novice, being the beginner level, is not affected by hook, slice or wind, making every shot go straight, however it is still necessary to judge distances correctly, and choose correct swing and club. Amateur Level starts to make the game more challenging, as you now have to deal with the problems of hook or slice. With practice on the driving range, you can perfect your swing so that you hit straight every time. Hitting straight requires precision timing with the joystick button, hit too early and you will hook the ball, hit too late and you will slice the shot.

Most find it easier to allow for the hook or slice when lining up the shot, and then let the hook or slice bring the ball back into line. Professional, however makes this play even harder as the direction and strength of the wind comes into play. The four courses contain various types of holes, some 475 yard par fives, others as short as 67 yard par three, with each course being slightly harder than the ones before it.

In your golf bag you have 14 clubs - three woods, nine irons, a pitching wedge and a putter. You can select any club at anytime, except for the putter which is only used on the green (whenever you come within 64 feet of the hole). Each club is capable of hitting



different distances, ranging from 271 yards for the No. 1 wood to 83 yards for the pitching wedge providing you with an ample in between selection for each shot. Even the putting is realistically done, with the player having to take the amount and direction of slope into account for each putt.

The graphics are probably the best effort to come out of the Access group.

Leader Board combines 3-D animation, and a true perspective view, resulting in a superb display. The sound is very realistic, with good sound effects for the golf swing and when the ball lands in the water, however there is no overall sound track. The golfer himself and his stroke are extremely well done, with his swing being incredibly smooth. Probably the best feature of the game is not the quality of the graphics themselves, but the true perspective view you receive. The golfer is always situated at the bottom centre of the screen, looking straight towards the hole, therefore the view has to be redrawn for each shot so that you are looking at the hole.

In other words if you hook off to the left of the hole, instead of the hole remaining in a fixed position and the golfer moving off to where the ball is, the whole screen is redrawn so that the golfer is back in the bottom centre looking straight at the hole. For the complexity of such a feature, it is done with amazing speed.

Perhaps the only flaw of the game, and graphics, is that there are no sand traps and rough areas. It's either smooth fairway or water, however this does not detract from the playability of the game.

The game itself is very addictive, especially for people with a very competitive nature who enjoy beating par, and their own personal best. The three skill levels allow each player to progress through the game in accordance with their ability (so far I can only handle Amateur). If you choose to play a 72 hole game, you don't have to play the same course four times, you can play any combination to make up your 72 holes, so you could play a round on each course or two rounds on one course and two on another, or whatever you wish.

Scoring is done automatically, with the leader board being displayed after each hole.

Something worth noting is the protection scheme involved. Instead of an ingenious disk protection, which usually causes your drive to have a heart failure when trying to load, *Leader Board's* disk is not copy protected at all, so you can make as many backups as you like. This is very handy as it means the game should work on all drives (1541, 1570 & 1571). However to run the program, a small plastic device, known as a DONGLE, must be placed in the cassette port.

What about the SX with no cassette port, you say? Well it seems the game can tell when you are using an SX and therefore lets you run the program without the Dongle.

Well, if you're sick of chasing your ball off into the rough, or maybe you are more skilled at throwing your clubs in frustration than you are at hitting the ball, then *Leader Board* is for you. So put on your golf shoes, grab your clubs (or should I say disk) and hit the course, this could be your chance to go under par.

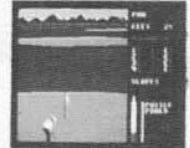
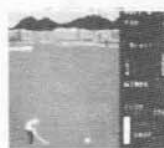
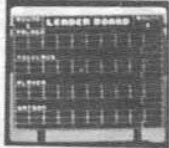

Australian Commodore Review Evaluation Card

Game: *Leader Board*
Machine: *Commodore 64/128*
Publisher: *Access Software*
Price: \$39.95

Graphics: 94
Presentation: 91
Documentation: 92
Difficulty: 95
Addictiveness: 97
Impact: 94

Overall: **95**

Comments: *Most realistic golf game ever, and perhaps most realistic sports game available. Numerous options provide varying difficulty levels, and make the game very addictive. True Perspective View Graphics, SUPERB!*

Now



by J. Mark Hunter

Games

Totally impressed - my first vivid reaction to the literal "gem" of a master package presented to us by Ozisoft.

It's called *Now Games*, and at \$24.95 for a six pack of sheer delight it's the best value in a long, long time.

Although the games are not new to the market, having been released previously as single game titles, there may be a lot of people that have not as yet viewed one or even all of the games. Accepting the disk for review, I was anticipating a long drawn out series of uniform game types, or a collage of third-rate programs.

But this disk is definitely not that at all.

Side one of the cassette features: *Lords of Midnight*, *Brian Bloodaxe* and *Strangeloop*. Side two: *Pyjamarama*, *Arabian Nights* and *Falcon Patrol II*. Assorted, varied, each distinctively different in their objectivity and presentation.

Lords of Midnight

Lords of Midnight has a facility which enables you to SAVE the game you are playing at any stage. When loading is complete, a screen will appear depicting the situation of Luxor the Moonprince and your quest will begin on the day of the Solstice itself.



Lords of Midnight

If you press "L" a screen will appear instructing you to LOAD the saved data of the game you wish to continue. Once the data has been loaded back onto your Commodore, the last screen of the game you saved will appear and you can continue your quest.

To abandon a game press RUN/STOP and RESTORE.

The role you play?

You, the player take on the role of Luxor the Moonprince. By virtue of the Moon Ring, you can control other characters that are loyal to you, move them through the landscape of Midnight and look through their eyes. Some of these characters are simply individuals, others are the commanders at the head of whole armies, still others are roadies and members of the band. When you move a commander, his army moves with him - not to mention the wife and kids.

The computer plays the part of Doomdark, the Witchking of Midnight and controls the characters and armies loyal to him. In addition, the computer also governs the actions of the independent characters and forces in the land of Midnight.

A choice of games

There are two distinct ways of winning over Doomdark. The first is by war, by sending armies north to the Plains of Despair (low rent district in the Land of Midnight), and seizing the Citadel of Ushgarek from whence Doomdark commands his foul hordes. In such a strategy, Luxor himself will play a major part as a commander in the field, he also wrote some of the screen play.

The second way of winning is by quest. By guiding Morkin, Luxor's son, to the Tower of Doom to destroy the Ice

Crown, the source of Doomdark's power. Morkin can have no army to help him on his journey, for the Ice Crown sends forth the Ice Fear which withers men's minds - similar to that of rock'n'roll wrestling, only not as strong. By virtue of his birth, half-human, half-fey, only Morkin can resist the utter coldness of the Ice Crown's power. Though I really don't know how being half-fey can help, for the actual meaning is Scottish, having strange other-worldly charm. Says nothing about built-in natural thermal underwear, at all.

The guide book made note that if you just prefer pure adventure, concentrate only on the quest of Morkin. The other sections of the game will continue on by themselves. The armies of Doomdark will

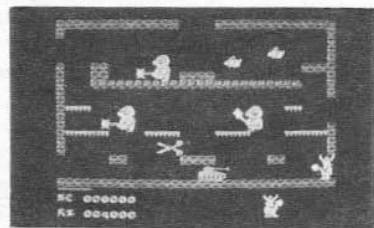

Brian Bloodaxe

still march south to conquer Midnight, but armies of the Free will defend themselves without your guidance, even though they will not make any counter moves. Or, if you prefer a pure war game, ignore the quest of Morkin and concentrate on the assault of Ushgarek.

I chose the former. First I played the three other characters all the way to their demise (it wasn't their fault, I just made strategically inefficient moves), Luxor the Moonprince, Corleth the Fey Rey and Rorthron the Wise, then pressed F3 which is the key for Morkin from Orkin.



How the game works.

The game proceeds by day and night and you commence at the Tower of the Moon.

During the day you can move, say Morkin, and the distance he travels depends on the difficulty of the terrain and whether he is walking or riding and his state of mental health. One important thing to remember - travel directly north, south-east or west and you are moving just one league at a time. When you move north-east, north-west, south-east or south-west you are moving along the diagonal of a square one league by one league, 1.4 leagues.

Night will fall for your character and, unless the THINK screen tells you of any exceptional circumstances, he will not be able to do any more until the following day.

Then you must press NIGHT. This lets night fall and the forces of Doomdark will move. There will be a pause while he "THINKS." The manual, in big type instructs: IF YOU DO NOT PRESS NIGHT THE GAME WILL NOT PROCEED! - okay, sounds fair, but do you think I could find the night key?...no way, Jose. I pressed the N key, nothing, even typing the full N-I-G-H-T...still - nothing. The game could go nowhere. So I got on the line to Ozisoft in Sydney and talked to Michael Ristuccia, their chief diabolical mind and programs coordinator, and within three seconds of me mentioning the words "NOW GAMES" he knew why I was there and informed me that it was merely a simple error. The printers had failed to include it on the manual. So know this intrepid adventure trekkers, to bring on the night you must press the zero key (0).

The Lords of Midnight is not a standard adventure game and controlling the characters does not require you to guess at the right phrase of command. Instead, you have four basic options, each available at the press of a single key:- LOOK, MOVE, THINK and CHOOSE.

Victory for Doomdark.

To win, Doomdark, or the computer, must achieve two objectives. First, he must eliminate Morkin, (as long as Morkin is alive the game will continue.) Second, he must subdue the armies of the Free.

If Luxor is killed you, the player, lose all control of the other characters in the game except for Morkin his son. If by any chance Morkin manages to find the Moon Ring that Luxor wore, he can put it on and you will gain control over those characters still loyal to the free. However, once he does this, Morkin will immediately become known to Doomdark and his quest will become almost impossible.

The Ice Fear and the Moon Ring The Ice Fear is Doomdark's greatest weapon. If strong enough, it may even cause characters once loyal to Luxor and the Free to desert to

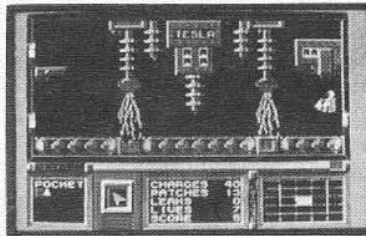

Strangeloop

Doomdark's control. The only shield against it is the Moon Ring that Luxor or Morkin wears. The closer a character or army to the wearer, the less will be the demoralizing affect of the Ice Fear.

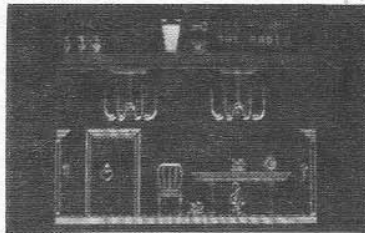

Pyjamarama

There is one drawback, the Witchking can sense the warmth of the Moon Ring and thus knows the wearer's location.

As Doomdark triumphs the ice-fear grows, but lessens as he is defeated. He will concentrate his force in the areas of most danger too.

Primarily, it is a very detailed and complicated game, but one that I found most intriguing and thought-testing. It is quite easy to see that a lot of hard work has gone into not only the actual writing of the program, but into the elaborate and interesting story behind the adventure.

Graphics are exceptional. With each new flick of the continue tab and compass direction the character moves into quite varied scenes. Frames are depicted by illustrations such as mountains, frozen wastelands and valley plains.

The pictures loom toward you, growing with each progression forward into the different lands, and during the loading interesting, quickly developing sketches grow vividly on the screen. The colours are average, no multi shades or hues, but drawings remain clear and well-defined. It's not quickly moving, but epic journeys take time and well-planned cogitation. There is also no music. But in such a situation you've got to listen for breaking twigs and the sound of the wind.

"Death in the Domain of Dreams and Kor and of Blood and of Herath. Ice trolls are abroad and Morkin must fight or hide. There are two hours of day remaining and Morkin is utterly invigorated. The Ice Fear is mild. Morkin is utterly bold."

"Do it, Morkin baby, do it. Do it for me!"

Pyjamarama

Wally has fallen asleep and is in the middle of a nightmare. Everything in his dream has been enlarged many times its normal size. (Sounds like my dreams). So you must help him find his alarm clock and wind it up to wake him out of his nightmare.

Wally can carry two objects at a time and to pick one up he must simply walk over it. He can exchange objects on his way too. He may need keys to open some doors but at most times jumping up at the doorknob has the right effect.

There is a glass of milk at the top of the screen that represents Wally's "Snooze Energy." This is depicted by Wally moving around or hitting or being hit by objects. Items of food lying around will top up the glass but when it runs out you will lose one of the three lives you are given.

Now what do you make of that?

Pyjamarama - I like it, it's cute. No really, I still think it's the best program of the whole pack.

WALLY

But at first I didn't. You start off in a room depicted by a green and yellow staircase and beach balls continually sliding down the banister. Your aim is to walk the many rooms of the house and avoid being sapped of energy.

You move from room to room by opening doors and entering into the next frame. Each room is excitingly different in the attitude of the space between the walls. Leave the first frame and you hit the kitchen area. Inside you get attacked by some kind of creepy crawly like a spider or something, or a big green hand can reach out of the floor boards and grope you to death. Or for a little more of an amusing technique, the programmer has runaway turkeys, cooked and on the platter leaping off the table and heading straight for your vital signs. Get the heck out of there, pick up a piece of nourishing cake off the floor and you're on your way to a further exploration.

Heading upstairs you enter the attic area where the floor is moving, sliding escalator style, and if you do not jump by pressing the fire button you will be carried away with the floor and deposited unceremoniously at the foot of the steps.

But the greatest screamer of all, when I really was thinking that this game was getting monotonous, was when Wally enters his brother's room and moves over to the joystick on the floor. He picks it up and I'm wondering what he's got in mind with that, when, on further, through the bathroom and some basement plumbing with flying axes, bats, ghosts and such he starts heading for a door marked "Video Games."

Now this is cool.

Bang! You're inside and hey, man, y'all's better duck your heads cos incredibly you find yourself in a video arcade with all the bad energy-sapping monsters that hassled you before all lined up in sequence and dropping every conceivable kind of sharp-edged object upon you!

Now this is absolutely true, but in my review of *Elektra Glide*, I mentioned something about "watch for fallen cutlery" unbeknown to the fact that in *Pyjamarama* that is exactly what you get, Herman! Your friend, Wally, and mine, has to attack back at the space invader-type objects and eliminate them

by shooting a series of knives and forks up to them.

It's great, I love it, and as soon as I get the rest of the games on the *Now Games* disc completed I'm heading on right back to it, fast!

It's a colourful program, with very realistic graphics. The music is enjoyable, and the antics of Wally the same.

Pyjamarama - the greatest fun anyone has had in his pyjamas since he put them on.

Tales of the Arabian Nights

Imrahil begins his quest aboard Sinbad's ship sailing the perilous waters of the Red Sea.

And you're on board too, checking out the scenery, and getting a tan. "Do you know what happens when you drop a white hat in the Red Sea? It gets wet!" No problem.

This game, they tell us, is inspired by the original tales of Scheherazade. It's called *Tales of the Arabian Nights* so I guess it wouldn't be inspired by M*A*S*H.

You're requested to guide Imrahil the Kalendar Prince through the perils of the many Arabian nights. On certain nights he must gather golden jugs engraved with letters and in the correct order spell 'ARABIAN.' At other times he rides on rafts and flying carpets through Arabia casting bolts of lightning at his foes.

Whoa, and in all of this a love story. Imrahil is after a girl called Anitra, a princess. And his quest for her is long and arduous - for many dangers lurk in the Arabian nights!

Nice little show. Well presented, colourful, setting the scenes as they seem to be with genuine Arabian flavour and style.

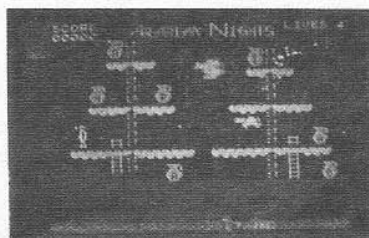

Arabian Nights

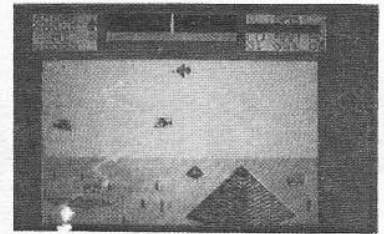

Falcon Patrol II

Opening frame has Imrahil darting around the decks and masts of Sinbad's ship, donned in turbans and genie pants. It takes a while to master the art of which letters to take in sequence for there are three A's and if you take the wrong one first you forfeit the ability to jump and leap like Errol Flynn around the ship. You crack up, and die.

Be on the watch also for giant, menacing ocean squid, flying vultures and cannon fire.

As well, there are cantankerous alligators willing to devour you as you ride your raft, and black cloud masses that drop on your head.

Bad news genies could also be a perturbable problem.

Using a joystick you move around, but with the fire button depressed you also have the ability to fly in long-winded leaps from level to level. The fire button also controls the bolts that Imrahil issues with great severity that cast spells on all noxious creatures.

The frames scroll from right to left as you move along, with Imrahil being a well-animated character in front of an eerie backdrop.

Game 3, of this brilliant package, *The Tales of the Arabian Nights*.

Tales by nights, flying carpet recharge by day.





Critical Mass

by J. Mark Hunter



You drag a hand across your face hoping to wipe away the fatigue, the sweat of contemplation of the fierce reality of the mission at hand. But it's still there, the vice-like grip of tension and unease. You blink your eyes a few times, then shake your head, 'C'mon, man, get it together now. There's work to do.'

Checking your instrument panel, you note that all systems are go. But of course they are, for you are the one that checked and rechecked every square millimeter of this rocket-propelled hovercraft before being deposited onto this bleak, treacherous asteroid millions of light-years from anywhere, isolated.

You set off at full speed, hurtling east towards the power plant. It is your mission to disable the anti-matter converter before it reaches its critical mass.

Because you are able to hover above the ground surface you are well-advantaged to reach high speed strike capability without fear of either radar or seismic detection through contact. Your craft is armed with a high-density light phasor that can penetrate all known energy protection shields.

The fatigue begins to quickly melt away as every nerve and sensory fibre becomes tuned to the dangers at hand. Your

total will become an insatiable thirst to survive and successfully complete this mission.

You know that as you approach the power plant the alien forces will be dispersed around the perimeter and deep inside, and in the early zones expect to encounter the long-distance raiders and mines. Easily you'll shoot them down with rocket turrets equipped to the craft. You grit your teeth and fly on.

The power plant will be heavily guarded by a protective wall, mines and amorphous clouds of molecular disorientation. To enter the power plant zone you will first have to shoot the robot guard on the inside of the wall, and keep on moving quickly for fear of being hit from the side with a guided plasma bolt. And next you'll fly towards the force gates which you will be able to disable, but only temporarily, and pass on through, ever-conscious of your own imminent destruction.

Once inside the power plant zone you will be drawn towards the energy transfer beam which you must destroy by shooting the prism-shaped energy concentrator in the middle of the device while it is taking in energy. But if you fail to hit your target quickly you'll be drawn into the beam and vaporized!

During this final stage you become vulnerable yet again, to the horrifying dust-colored clouds of molecular disorientation which will cling to your vehicle and deplete your energy.

Okay, you're getting closer. You loosen your seat belt to give you a little more breathing space and settle in for the attack. Only a quarter of a mile from the plant now - prepare! Prepare for the critical mass.

As you hurtle through the straights you work skilfully to avoid the rocks and mines on the asteroid's surface. And even if you do scrape a few, your hovercraft's built-in force-field protection system will cushion your impact when in collision with rocks and then, slowly, regenerate itself to full power.

The worse is over now, you begin to feel just a little more at ease. The plant will soon be in sight.

Crack! Suddenly you realize you're being shot at from behind. The force-field is also a protection from aliens but provides only limited protection and only for short periods of time.

You begin your personal assault, fighting ruthlessly against the robot aliens.

You begin to get the upper hand, but a massive charge from the attackers slams you fatally against a huge outcrop of rocks. A warning light and siren begins to blare loudly, another protection system built into the craft that detects such an implosion before it occurs and automatically ejects you from the craft.

As you begin to fall back again towards the ground surface, firing all the while at the aliens, you activate your emergency jetpack and swiftly fly on to a new ship in one of



**If you own an Apple IIc,
you'd have to add all this**



**to match the versatility, expandability
and higher intelligence of the
new Commodore 128**
(and it costs less too).

The new Commodore 128™ personal computer is breakthrough technology at a breakthrough price. It outshines the Apple® IIc in performance capability, performance quality and price. It is expandable to 512K RAM while the IIc isn't expandable at all.

And the new Commodore 128 has a numeric keypad built right into its keyboard that makes crunching numbers a lot easier. And the Commodore 128 has graphic and sound capabilities that far exceed those of the Apple IIc. But the most important news is that

the new Commodore 128 jumps you into a whole new world of business, productivity, education and word processing programs while still running over 3,000 programs designed for the Commodore 64.™ That's what we call a higher intelligence.

COMMODORE 128  A Higher Intelligence

 **commodore**
COMPUTER
Keeping up with you.

BEEMAN MAYRHOFER STOTT/CC422



the dome-shaped replacement pods that sends out a continuous homing signal.

But now you're totally vulnerable, with no force-field or weapon to protect you. A serious drain on your energy has begun and the seconds are eaten up in chunks of precious time.

The dangers never stop, the menaces from this forsaken asteroid too numerous to recall. You know you must especially beware of the giant asteroid worms that will leap from the ground and suck you under for their eternal meal!

Can you do it, baby? Will you make it through the mission and finally get back home, to the beautiful planet Earth so terribly far away?

Yes, a feat of incomparable skill. The most intriguing game of adventure and action since Infiltrator. Critical Mass is to me one of the hottest games around.

The control panel display on your screen is dynamically realistic. Every time you fail a mission the automatic printout is relayed to the frame and beeps along the screen just like a telex or tickertape machine.

The colours are very good, with frames scrolling from east to west as you fly to the right of your screen. Surface features are also very real and shaded into three-dimensional patterns.

It is a very hard game to master. Particularly difficult is the steering control on the hovercraft. Rather than driving leisurely across the planet's surface, you are floating freely above it, battling the effects of your own momentum at every turn.

There are five skill levels, starting at number one for beginner's play. After selecting your skill level at the start of the game you will be asked to choose a vehicle type. "Normal"

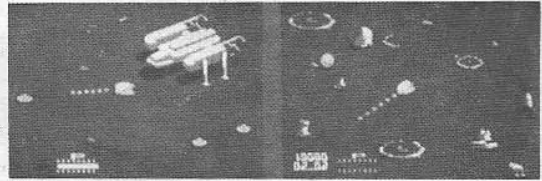

type vehicles have been included as an easy option for beginners. These have brakes to help you slow down, and are therefore much more manoeuvrable. However real hover vehicles only have the vectored (a mathematical term for a quantity that has both magnitude and direction, ie. velocity=speed in a given direction) flight. To stop you must turn around and then thrust briefly against your direction of travel. This "vectored" type flight allows you to turn the vehicle and fire in any direction while still maintaining the same flight path, and is superior to normal flight though more difficult to operate.

Your score will increase for each alien destroyed, depending upon the type. You get additional points for completing zones, but lose points for crashing into rocks. You start the game with an initial 2000 points.

Distributed by Durell software, Critical Mass is a powerful package of skill-testing interest. It's hard to master, but then, so far from home on a planet this ugly, you don't want to come back and do it again.

Australian Commodore Review Evaluation Card

Title: *Critical Mass*
Machine: C64
Publisher: Durell
Distributor: OziSoft
Price: \$29.95

Graphics: 83
Presentation: 90
Documentation: 87
Difficulty: 85
Addictiveness: 82
Sound: 74

Overall: **87**

All around
Australia avid
arcade adventurers
are buying

Australian
HOME COMPUTER G.E.M.
A Gareth Powell Publication

For all the latest
in graphics action
on your
Commodore



COMMUNICATIONS

second control on speed is provided by the amount of memory you have available.

If you have more Random Access Memory than the length of the program you are going to download, you can hold it in your Random Access Memory until transmission is finished. Then you can save it on a disk or a cassette, depending which sort of system you are saving.

But if your memory is smaller than the program you want, then you will have to download part, then suspend operations while you save that part to disk or cassette. Then load the rest of the program into the newly vacated memory.

Which can take a long time and can make your telephone bill mount up remorselessly.

The more memory the better. Anything over 32k of Random Access Memory is very workable, 64k is ideal, anything above is icing on the cake.

If your memory is smaller than 32k you might consider upgrading or confine your attentions to those programs that will fit into the memory you have available.

Personal computers can fairly easily be divided into three classes - 8 bit, 16 bit, and 32 bit. These are the different types of microprocessors - the main engine rooms of the personal computer - that they use. Their size does not always mean they are faster or more efficient - just that they can easily support a larger amount of memory.

Theoretical limits

The theoretical limit for an 8 bit machine is 64k of Random Access Memory, although this theoretical barrier can be got around through a system called bank switching. The theoretical barrier for a 16 bit system is about 1,000 or 1 megabyte. For a 32 bit system the sky, effectively, is the limit.

Typical 8 bit systems are the VZ 2000, the Cat, the Apple II and IIe, the TRS 80, the Commodore 16 and 64, the BBC and the MicroBee.

Typical 16 bit systems are the Commodore Amiga, IBM PC, the Apricot, the Wang PC, the DEC Rainbow, the Tandy 1000 and 2000 and literally dozens of others.

At the moment there is only one line of 32 bit machines available on the Australian market - the Macintoshes in their various configurations, from Apple.

No matter what machine you own there will be a modem suitable to use with it. In most cases the modem will connect to your machine through an RS 232-C interface. (Let's not get frightened by this technical jargon which is widely used by people in the computer industry to frighten amateurs. An RS 232-C connection is merely a type of connection with 24 pins that fits into a socket with 24 holes. Not all of the pins will always be used but they are available for different types of connections. An RS 232-C connection is simply an industry standard of connecting a computer to another piece of equipment. All beliefs to the contrary, there is no such animal as a standard RS 232-C plug, although some are more common than others. It is the method of connection which is always the same, not the shape of the plug. They are only designed to put you off.)

(Part 4 of Telecomputing in our next issue.)



INTERESTED IN COMMODORE COMPUTERS?

(C64, C128, AMIGA, PC-10)

CONTACT:

FAIRSTAR

A DIVISION OF FLEIG ENTERPRISES PTY. LTD.

Shop 4 Westfields
NORTH ROCKS, 2151
Telephone (02) 872 4840

For all 64/128 needs



COMPUTER CENTRE



65 Victoria Road
PARRAMATTA, 2150
Telephone (02) 683 4271

Business and School Systems

Adventurer's Realm

Dear Michael,

I must humbly thank you for naming me adventurer of the month. I'm not sure I wanted the title, but I appreciate it. Thanks!

One slight puzzlement, where was the Zork Maze Map? I've included a couple of maps just to help you out a bit. Also a few hints and clues. As for your sarcastic (!) comment about the opening screen of Catawombs, one of your nice readers wrote and helped me out. Even Adventurers' Extraordinaire aren't totally infallible, y'know!

By the way, you don't need to kill Gollum to complete the Hobbit. I've also included copies of a few solutions. Hope you can use them!

One of them is for the Hobbit, so that should help Ben Creek (Cheltenham, Vic.)

I only have one question. In Fahrenheit 451, what do you say to the engraver to get the report? His is the only piece of the puzzle I can't get. I've got all the way to the barricade and the guard keeps turning me away. Can anyone help me?

Well, that's about it. Again, thanks for the plug.

Yours sincerely,
Margot Stuckey
Marayong NSW.

Ed: Unfortunately Michael Spiteri couldn't quite make this month's deadline - mainly because our modem was playing up. I'm sure he'll find those tips very useful, thanks, Margot - the Zork I Maze Map is in this issue.

ZORK MAZE MAP

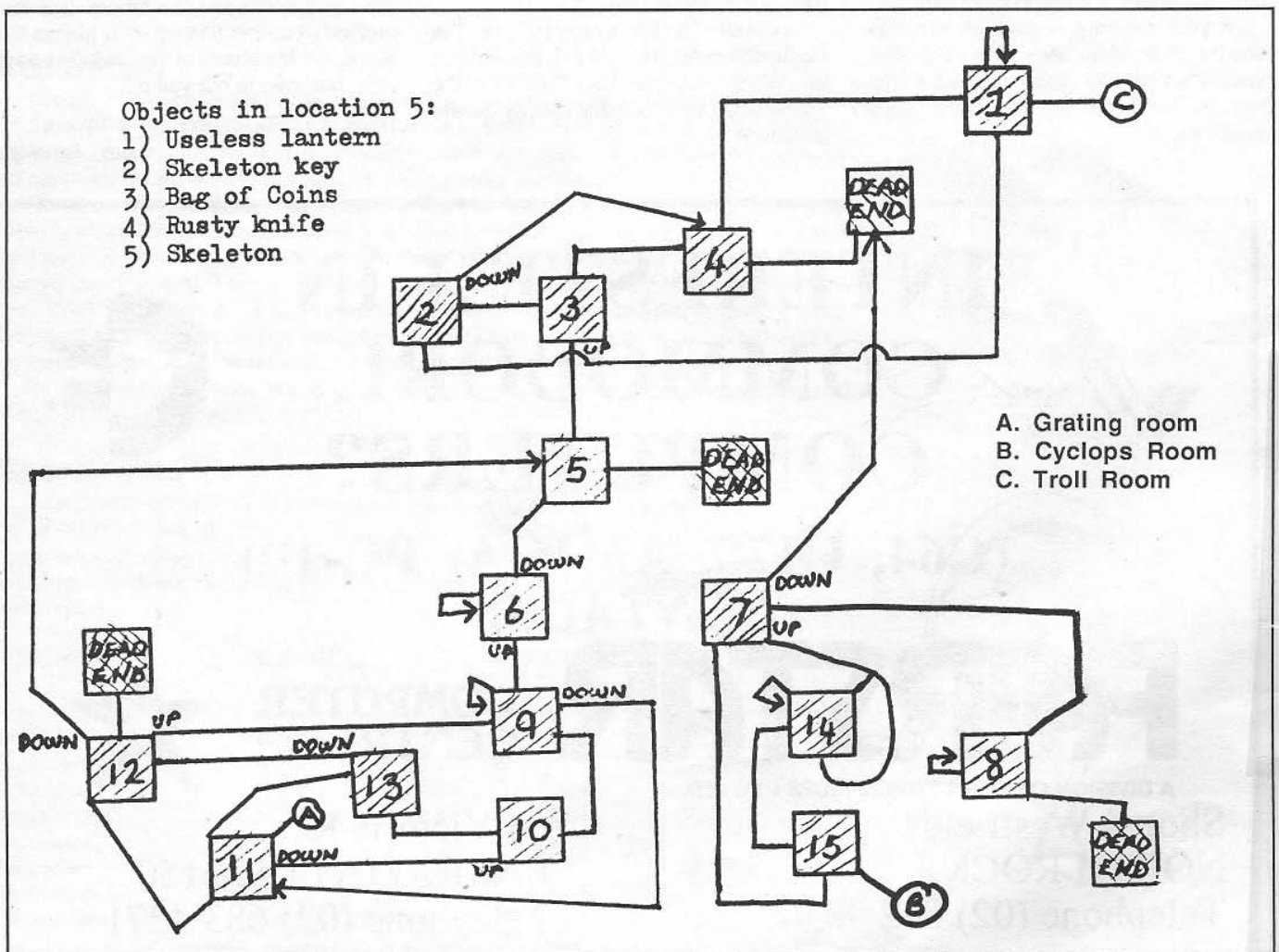

ADVENTURERS' REALM

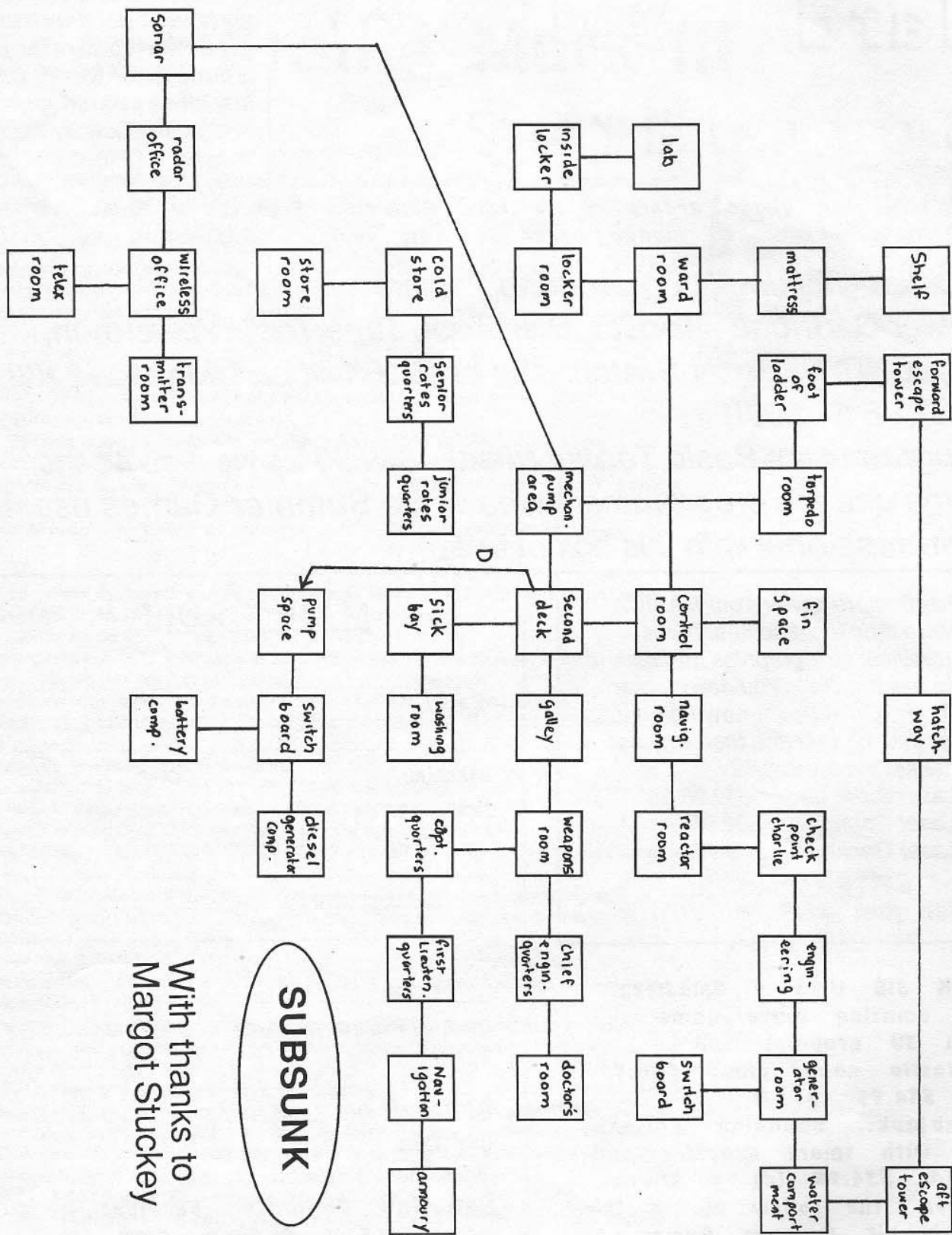

LETTERS

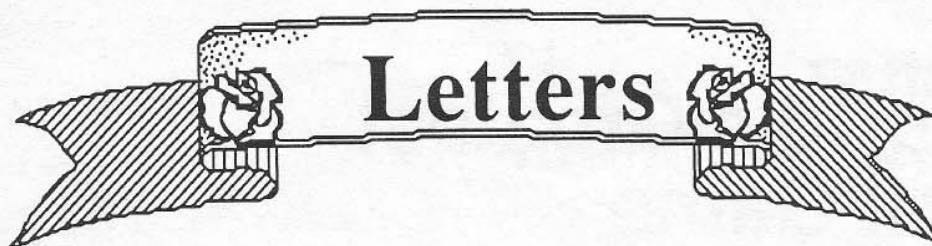

ASAP!

Mr Farrell,

The article "So You've got a New Printer" by Paul Blair, on page 34 of Vol 3 No 8 of *Australian Commodore Review*, contains a number of 'bugs' when used on a Commodore 64 computer, with a MPS 803 Commodore printer.

On running the program, you are asked what year you would like printed, and when you have answered are requested to press the space bar to confirm your choices. Upon pressing the space bar the program ended, just as pressing any other key does.

After removing the offending line (line 1360), I was able to proceed to the next question, on how many lines per page. Answering this and again pressing the space bar to confirm brought the program to a quick end.

Removing the offending line (line 1450), enabled the program to proceed. I was relieved when the title of the calendar was printed out, but then the monitor came up with a Bad Subscript Error message in line 1190. This was caused by the fact that MN\$ had 12 items and the Commodore required a DIM statement when using more than 11 items. Add line 1055 Dim MN\$(12), countered this bug, which lead to another Bad Subscript Error message, this time in line 1220. Again this was countered by another DIM statement, hence line 1056 DIM DY(12).

To my disbelief this bought forward another Bad Subscript Error message in line 1570. Some time was spent upon this bug, until I realised that this was a two dimensional array. Another DIM statement took care of this, line 1057 DIM MX\$(2,20).

This bought the printer to life, beauty I thought, my calendar at last. Shock of shocks, the printers gone mad, it produced Appendix 1. Adding CHR\$(15) to line 1660, the line now reads 1660 PRINT #1, CHR\$(EX)"[SPACE 4]MN\$(M)"[SPACE 12]" MN\$(M+1):PRINT #1, CHR\$(15), the effect of turning off the enhance mode produced Appendix 2.

Changing line 1080 so that the (:) colon signs were above the (+) signs of line 1090, produced the results in Appendix 3. The third and fourth month titles were not in enhanced mode as they should have been.

This bug was overcome by removing line 1060, and replacing the variable (EX) in lines 1490, 1500, and 1660 with (14).

Believe it or not this was the end of my troubles and I now have my completed calendar, which looks like the one in Appendix 4.

In conclusion it took the deletion of line 1060, 1360, and 1450. The addition of 3 lines -:

```
1055 DIM MN$(12)
1056 DIM DY(12)
1057 DIM MX$(2,20)
```

and the changing of 4 lines, which now read -:

```
1080 NN$ = "+"[SPACE 4]:[SPACE 4]:[SPACE 4]:[SPACE 4]:[SPACE 4]:[SPACE 4]:[SPACE 4]:[SPACE 4]:[SPACE 4]:[SPACE 4]:[SPACE 4]+
1490 PRINT #1,CHR$(14)"[SPACE 5]"COMMODORE[SPACE 2]COMPUTER[SPACE 2] CALENDAR":PRINT #1
1500 PRINT #1, CHR$(14)"[SPACE 18]MR$:FOR A=1 TO 4:PRINT #1: NEXT A
1660 PRINT #1, CHR$(14)"[SPACE 4]"MN$(M)"[SPACE 12]"MN$(M+1):PRINT #1, CHR$(15)
```

to get the program working. I would have thought that Paul would have tested his program on all Commodore computers and printers before saying that they can be used. In fact one wonders if Paul tested the program at all.

I hope this information helps any other frustrated programmers.

David Marsh
Kincumber, NSW

APRIL

SUN	MON	TUE	WED	THU	FRI	SAT
+	:	:	1	:2	:3	:4
+	:	:	:	:	:	+
+5	:6	:7	:8	:9	:10	:11
+	:	:	:	:	:	+
+12	:13	:14	:15	:16	:17	:18
+	:	:	:	:	:	+
+19	:20	:21	:22	:23	:24	:25
+	:	:	:	:	:	+
+26	:27	:28	:29	:30	:	:
+	:	:	:	:	:	+
+	:	:	:	:	:	+
+	:	:	:	:	:	+



The World's Greatest Football Game

by Johnno

It's late in the fourth quarter and Ball-Blazer Joe gets the ball and sends it flying at a hundred miles an hour downfield. Sammy Jump-Jet jumps for the ball over the line; reaching to the maximum Sammy gets the ball and it's a touchdown, he wins it for the Dodger.

Yes, all you *Touchdown* fanatics out there, who have been waiting for this game to arrive fresh from the arcades, may not be very disappointed. Although it isn't exactly the same as the arcade version, it comes pretty close.

This game from Epyx combines all the thrills of *Touchdown* and adds some very tricky plays as well. Not only do you get to control the man with the ball once he gets it, you also have to arrange the plays in which your team will outwit the opposition.

When you boot up your double sided game disk you will get an option of either **Play Game** or **Chalkboard** (which will be explained later in the review).

If you think the game will be just an arcade pushover, then select **Play Game** first. You will find that the game is not as easy as you think, it has a few nice touches to it.

You get a choice of how long each quarter is and the names of the two teams (recognised as home or visiting team). After

choosing what time limit you will have, the team with the ball will be prompted to press the fire button or space bar, this in turn will give a new menu of :-

Time-out: you only get three timeouts per half.

10: go to scoreboard.

Disk option: load or save the game, switch from play game to chalk board or vice versa.

EXIT: exit.

If you choose exit you will then be shown the play screen. After that the Kick-Off icon will appear at the bottom. Prompt it by pressing space or fire.

You then get a choice of which way to run, left, middle or right. Once chosen press space or fire to continue.

When you've chosen which way you are going, you will get a menu of plays. You either select the OK icon or TRASH CAN icon for the next play (that's if you have made any with chalkboard). You will now get a chance to try your plays you've made or the one play which is already present.

On choosing offensive and defensive plays you will then get an OK icon to enter the main kick-off screen. By pressing the keys from 0-8 you choose the speed at which the ball will be kicked. You then get the kickoff receiver down to where the ball is.

Now that the game has started you get a new play selection. For the offensive there are the options of: Run, Pass, Field Goal, Punt, and exit. The player will then be prompted with three or four simple menus. The screen can display 22 different plays but all up 120 plays. The defence will then choose a play and then select the OK icon to continue.

In the viewing side of the game there are three different views:- Sideline, Overhead, and Overhead close-up view.

Some people say that Gridiron or American football is 85% strategy and 15% physical. The Chalkboard menu lets you pit your wits in creating a play that you think will walk over your male or female counterpart player. So let's get into the menu side of choosing a play (by just looking at the instruction book and play book, it looks very mathematical). The menu consists of:-

Eye icon:- views plays from the play disk menu.

Plus icon:- to add/design a play.

Triangle icon:- to change a play.

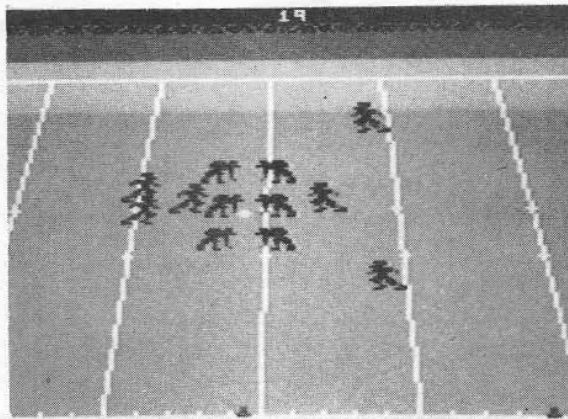
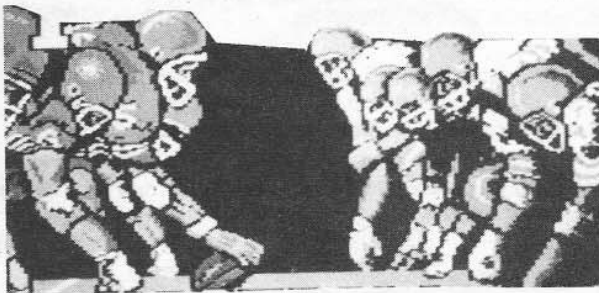



ULT E1U1

Trash Can icon:- to delete a play.

Disk icon:- to format a blank disk to store your plays on.

Football icon:- return to play game.

Exit icon:- exit the print option.

TV & CBM 64 icon:- print the diagram.

Square:- print the entire class of plays.

Looking at the instruction booklet I think I won't go into too much detail about the Chalkboard menu. But following is each selection on the menu in short detail.

EYE ICON:-

The eye icon lets you examine the plays which you have stored to disk. If you are lucky enough to have a printer you can select to print out your plays on paper and store in a file (titled Death Routines).

PLUS OR ADDITION ICON:-

This icon lets you add to your collection of plays. You choose what players go where and who gets what. These files can be stored to disk.

TRIANGLE ICON:-

To change a play, all you have to do is select the triangle icon and you can change a play stored on that particular disk. You get a choice - to rename a play or just redo the play.

TRASH CAN ICON:-

Delete is the option which most of you readers won't have to use. This icon only deletes plays, it doesn't restore them.

At any time during the chalkboard menu or during creating a play you can press restore to return to the main Chalkboard menu.

Looking through the playbook is enough, I learned a few little routines which I used against the computer. But as usual the computer creamed me once more.

If you like a good strategy game with a little action, this is the one for you. It comes with one manual and one playbook, and is a well designed game. I thought this Epyx game would have had graphics as good as *Winter Games*, but no one's perfect.

Australian Commodore Review Evaluation Card

Game: *The Worlds Greatest Football Game*
Machine: *Commodore 64*
Publisher: *EPYX*
Distributor: *ECP*
Price: *\$34.95*

Comment: An interesting game, that will be appealing equally for arcade addicts as it will be for strategic fans.

Graphics: 70
Presentation: 90
Documentation: 86
Playability: 78
Difficulty: 82
Sound: 50
Music: 76
Lastability: 70

Overall:

86

DEALER DIRECTORY

Cockroach Turbo-Rom

Price: \$42 (inc. postage etc.)
Speed up program loading and saving with TURBO-ROM, available for C64, SX, 128, 1541, 1570/1. Works with 1 or 2 Drives. Vic switch compatible.

Does not tie up cartridge socket. Works with printer connected. (Some fast loaders don't).

COCKROACH SOFTWARE,
PO BOX 1154,
SOUTHPORT, 4215.
Telephone: (075) 32 5133
A/H (075) 32 4028

Attention Job Hunters

An excellent position exists for someone with technical aptitude on the Commodore and/or Amstrad. Duties will be product support for a wide range of Pactronics peripherals, utilities and software and sales support for city and country clients.

Contact: Max Walters
(02) 734 879

Commodore 64/128

Maths Pack

A must for any student of mathematics at high school or university level.

- * Graph any function (X-Y or Polar co-ordinates)
- * Numerical integration/differentiation/ equation solving
- * Solve simultaneous equations (with up to 40 equations and 40 unknowns)
- * Numerical solution of first order differential equations
- * Least square curve fitting
- * Transform and graph any conic
- * Infinite series summation
- * Calculate loan repayments

Star Pack

- * A planetarium display of the heavens from anywhere on earth
- * Locate any object anywhere any time
- * Easy to follow instructions

Talking Sam

- * Is this artificial intelligence on the Commodore 64?

3 in 1 offer includes all three programs on one disk for \$24.95 from

Gary McCleary Software,
PO Box 24, Emu Plains, NSW 2750.

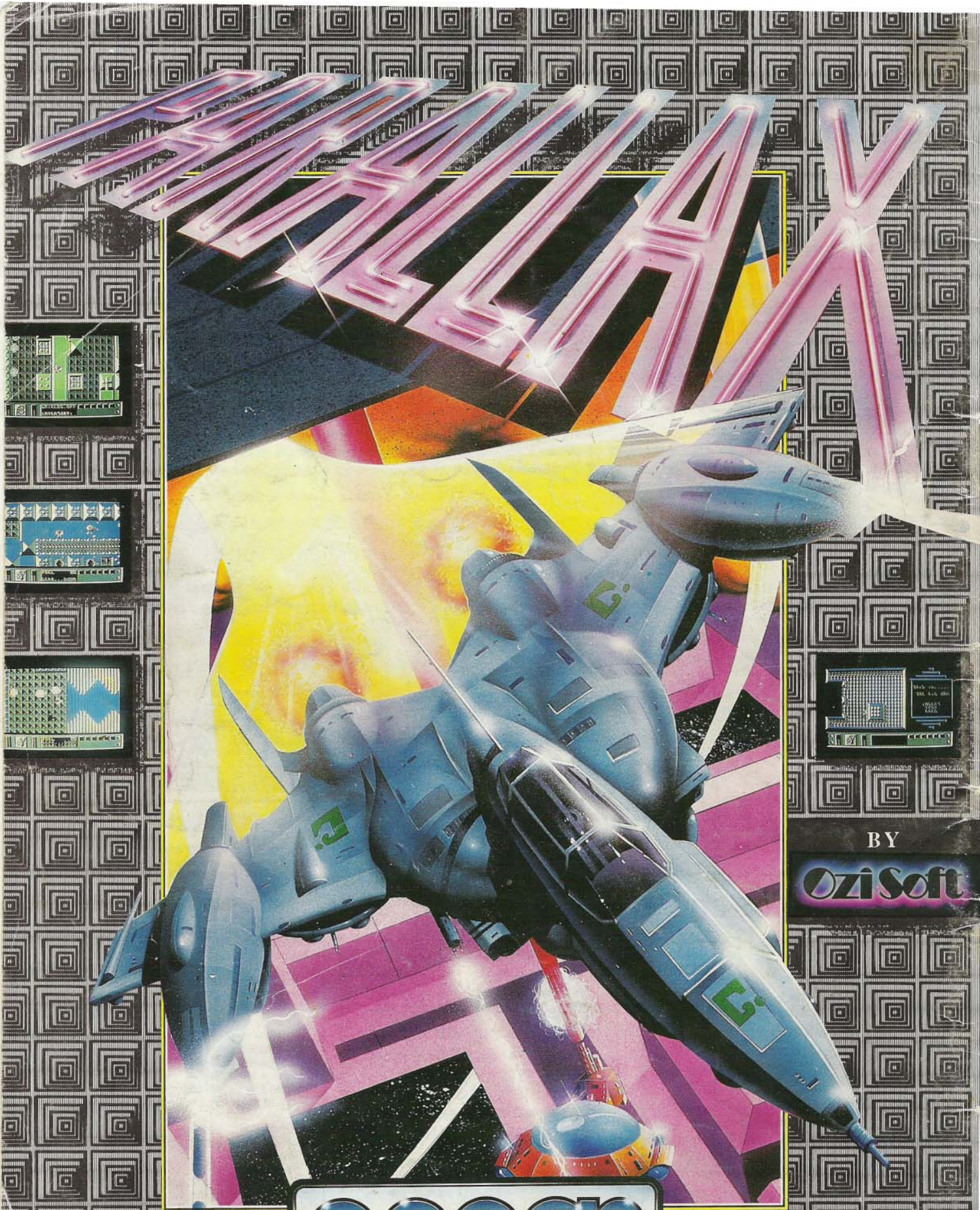

FOR
C64/128

ocean

Distributed by OziSoft
Suite 33 8/24 Kippax St.
Surry Hills NSW 2010
Phone: (02) 211 1266

BY
OziSoft