

COMMODORE and AMIGA REVIEW

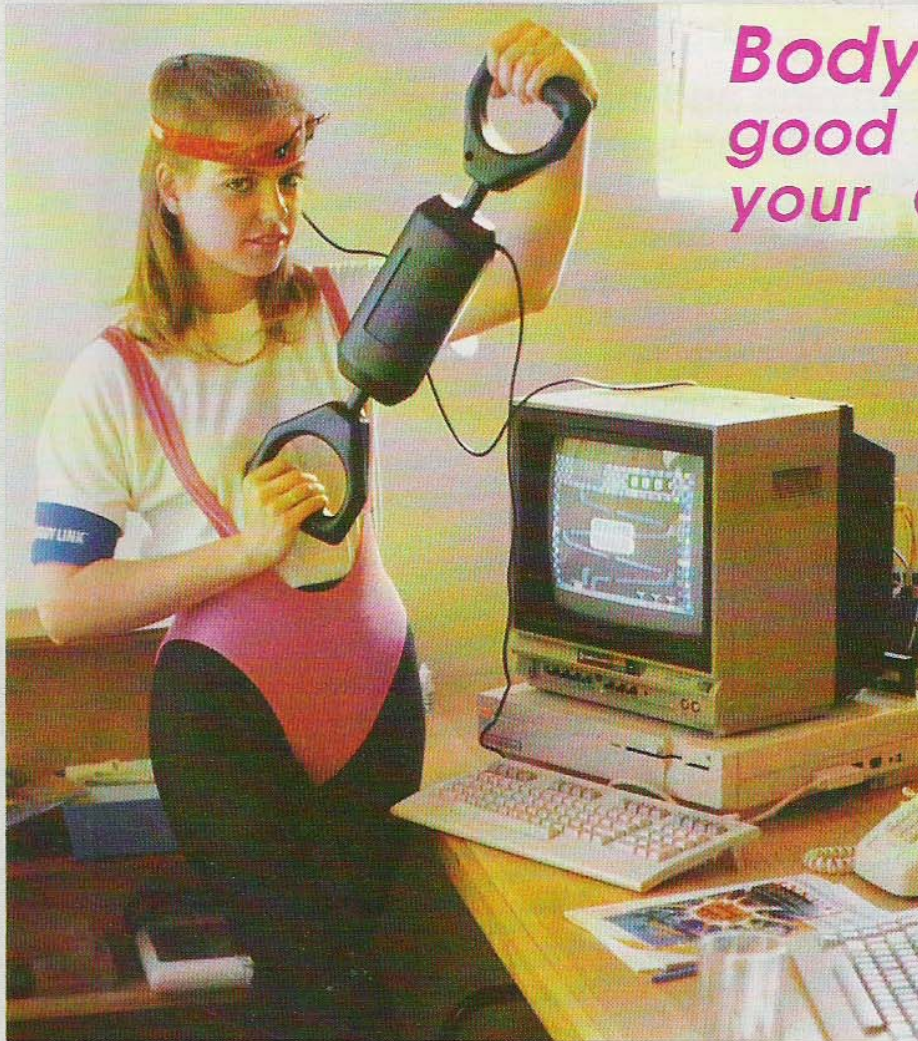

*Bodylink -
good health with
your Commodore*

**Fontmaster
128**

**Using Easy
Script &
Superbase**

GAMES:
Skate or Die
Que Dex
Track & Field-
The Tube
and lots more

**Amiga Section:
Using the RAM
Why I bought an Amiga 2000
T-bag disk collection**

'Education without Boredom !'

- RELIEF !!** Kids back at school - at last!
- PROBLEM !!** Kids having trouble with some subjects!
- RELIEF !!** Get them education software from Pactronics!

KIDS (and adults) love these programs
because

they are entertaining and interesting whilst educating
at the same time

From 7 to 70 you will find help in our programs, eg Maths,
Spelling, Biology, Chemistry, Physics, Geography - disk or tape

**** NEW** - MICRO MATHS, in-depth study of all mathematics
required for school years 9 - 11.



and

Look at our other software !

Ask for Pactronics's great range of economically priced *business, utility, graphics* and adult *games* . . . Just some examples:-

Business

KWIK Range
MAGPIE DATABASE
SWIFT SPREADSHEET
INSTANT RECALL

Utility

GEOSMAN
D & N CODER
TOOLBOX
MASTERLOCK
BLITZ

Graphics

ARTIST 64
GRAPHICS LABEL
MAKER
KWIK PAINT
MAGIC MOUSE

Games

GOBLIN TOWERS
WITCH HUNT
FORESTLAND
CATACOMBS
TEST CRICKET

*** NEW - IMPACT** for the Amiga and PC MS DOS - probably the best
selling game in the U.K., and now in Australia

Available from Grace Bros, Chandlers, Maxwells Office Equipment, Big W (education and Kwik range
only) and from leading computer retailers around Australia.

FOR THE NEAREST RETAILER IN YOUR STATE CONTACT:

N.S.W. : Pactronics Pty Ltd, 33-35 Alleyne Street, Chatswood. (02) 407 0261

VICTORIA : Pactronics Pty Ltd, 51-55 Johnston Street, Fitzroy. (03) 417 1022

QUEENSLAND : Pactronics Pty Ltd, 12 Stratton St, Newstead, 4006. (07) 854 1982

SOUTH AUSTRALIA: Baringa Pty Ltd, (08) 271 1066 ext. 6132

WESTERN AUSTRALIA: Pactronics W.A. 1/757 Canning Highway, Ardress (09) 364 8711

Mail Order - "Software To Go" - (02) 457 8289



The Australian Commodore and Amiga Review

Vol 5 No 1 January 1988

CONTENTS

HARDWARE

12. **Avtek Megamodem 12/123** - at least as good as the competition, and locally made
33. **Those black and white blues** - ever wondered how to make that old black and white set display your 64's welcome power-up message?
44. **Device number switch for 1541** - simple to use

SOFTWARE

5. **Bodylink - good health with your home computer** If you want to get fit, or learn to relax, this biofeedback program could be the answer.
8. **Fontmaster 128** - Word processing/desktop publishing for the Commodore C128
14. **Arcade Action - Hints & Tips, Track and Field, The Tube, Rampage, Flunky, Que Dex, Skate or Die**
26. **Flight Simulator II Scenery Disk 7** - If you like FSII you will love *Scenery Disk 7*.
28. **Yes Prime Minister** - A very tactical game, that captures well the spirit of the BBC series.
38. **C64/MPS 802 Publisher** - your 802 sings with delight while you reap the benefits of the superb graphics and Near Letter Quality fonts it will easily produce.

AMIGA REVIEW

between pages 24 and 25

TUTORIALS

29. **Using Easy Script Part 2** - your newsletter or sales report could be considerably enhanced if printed in columns
36. **Superbase 64/128** - practical aspects of using *Superbase*
41. **Machine Code Tutorial Pt IV** - the stack, the status register and the program counter.

Australian Commodore Review

21 Darley Randwick, NSW 2031

Phone: (02) 398 5111

Published by: Saturday Magazine Pty Ltd.

Editor: Andrew Farrell

Advertising: Ken Longshaw

(02) 398 5111 or (02) 817 2509

Production: Brenda Powell

Layout: Amanda Selden

Subscriptions & back issues:

Tristan Mason (02) 398 5111

Distribution: NETWORK

Printed by: Ian Liddell Pty Ltd

REGULAR APPEARANCES

2. Editorial
4. Ram Rumlings
46. Adventurer's Realm
40. Crossword
48. Back Page

Editorial

Software pricing ... too high?

A recent issue of Cursor, a newsletter of the Queensland Commodore Users Group, published an open letter to myself. They had this to say:-

The September '87 issue of The Australian Commodore and Amiga Review featured a review of the Amiga word processor LPD Writer on pages 2 and 3 of the Amiga Section, which concluded with the following comments:

"Software like this is dependant on you the purchaser. Australia is known as the pirate capital of the world, and some English and US software companies refuse to deal with us. I appeal to you all, for the sake of the industry, to purchase your software instead of stealing it. Because of our reputation in Australia, it is hard for the likes of Ozisoft and Imaginengineering to secure good software at a reasonable price. A recent visit to the USA proved to me that there is a ton of software out there - make it easier for dealers to get it."

After reading those words I felt like ringing you up and giving you the rough side of my tongue, but on reflection I felt that by sharing my thoughts with my fellow members and other Commodore users groups throughout Australia in this open letter it will get the attention which it deserves. (Somehow I cannot see it being published in your magazine, but I am prepared to be surprised!).

I am referring of course to ... the above statement, and would just like to know who supplied you with this rather interesting "fact". If it originated from your pen I'm sure that you are able to prove this statement, aren't you? However my guess is that it originated with one or more of our software distributors (i.e.

your advertisers).

Well, I am not in a position to either prove or disprove your statement, but I would like you to consider the following FACTS:

The Amiga program Scribble is advertised on Page 81, July '87 issue of Amiga World for US \$60.00. In Australian Personal Computer magazine, Oct '87, page 190, we see it advertised for AUS \$246.00! Yes, that's right, two hundred and forty six dollars!

I quote from the same issue of APC a review of WordPerfect for the Amiga (page 150): "The IBM version retails for

"that hoary old chestnut about the high cost of the software back-up services"

\$870.00, but is available from many dealers for under \$500.00"... true, several adverts in the same issue offer it for \$475.00. The Amiga version RETAILS for \$595.00 here, yet the best price I was quoted in Brisbane was \$525.00. Quite an anomaly isn't it?

You want more examples? Let's take the most popular Amiga program of them all - Deluxe Paint II. I quote you again from the same issues of these two magazines: in the USA you can purchase it for \$70.00 and here in Australia for \$245.00. (By the way, in the USA the manufacturer offered an upgrade service at reasonable prices when version II was released. Why was this upgrade service never offered in Australia?)

Now I could go on quoting you many similar examples of excessive price difference between the USA and Australia, but you get my drift, don't you?

And, if in response to these excessive prices, you now quote me that hoary old chestnut about the high cost of the soft-



ware back-up services being offered by the Australian distributors, I will give you some typical examples of these Australian software backup services:

Superbase for the Amiga has gone through several updates. The latest version is 1.046. Yet ... the Australian distributors have never advised any registered owners of this program about the

availability of upgrade version. In the light of prices charged for this program here in Australia I would hardly call that backup service, would you?

Another example appeared in a fairly recent edition of a newsletter from a Commodore Users Group situated just north of Sydney. One of their members described the problems he had with a faulty program in the "Pocket" series of software. After months and months of negotiating with the Australian distributors, he still didn't have a working copy. Oh yes, I realise that this was only a \$90.00 program, but the principle remains the same, or doesn't it?

No, as far as these so-called backup services are concerned, Commodore computer owners are not particularly impressed. In our own group many members have found that the only form of redress could be obtained by going back to the original manufacturer because local distributors didn't know or didn't want to know.

These are FACTS, Andrew, and on the strength of these facts I'd go as far as to suggest that, (with one or two exceptions), the REAL pirates are Australia's very own software distributors and, if they in turn get "pirated", this could be considered the logical outcome of their inflated pricing policies.

No, neither I, nor my group, the C.C.U.G. (Q) Inc., do condone the illegal copying of commercial software, but we feel that, if software was realistically priced, coupled with a decent backup service, the problem of software piracy would diminish very rapidly indeed.

As a commercial magazine editor your loyalties have to be divided between the interests of your readers and your advertisers. On the one hand you carry advertisements and reviews of products which purport to make back-up copies of protected software (who are we kidding, Andrew?), and on the other hand you fulminate against illegal copying of software. Somehow I feel that there are some contradictions hidden in there. Perhaps it's time that you reexamine your position on where to draw the line between these divided loyalties.

Firstly, it is not illegal to make a backup copy of a piece of software, providing that such is for your own personal use. Therefore, it is the manner in which backup utilities are used, rather than the tools themselves, which are the problem.

A carving knife is a deadly weapon, but they're not illegal, to the contrary, they're essential in the serving of any good Sunday roast. However, if you're caught running down the street waving the thing, and yelling threats to your neighbour, you can be arrested.

So to, if I walk into a user group meeting and find Freeze Machine being used to mass produce copies of some new game, then I would protest. Yet, on its own the Freeze Machine is not such a bad thing. Furthermore it is not the concern of the publisher, or editors of this magazine, as to the morality of our advertisers, and the quality of their prod-

“Not price, not demand, nor any other excuse can be used for an activity that is illegal. Pirating is illegal.”

ucts. We try to ensure that advertisers in this magazine are reputable, but we cannot ensure what their products are used for.

Not price, not demand, nor any other excuse can be used for an activity that is illegal. Pirating is illegal.

However, we may have a chicken and egg situation. The price won't drop unless reasonable quantities can be sold, and reasonable quantities can't be sold until the price drops. Someone has to give eventually. I predict it will be the distributors. Slowly slowly the prices will come down, as they already have.

Our writers are also entitled to their own personal views. The article to which you initially refer was written by Shane Drew, who until recently worked in a major Sydney computer store. His opinions were based on comment not only from distributors, but also concerned users who have seen the degree to which piracy on a mass scale occurs. I have also witnessed that the software collections of many Amiga users would barely contain two or three originals amongst hundreds of programs.

Pricing

Is software pricing to blame? Many dealers directly import packages from the USA and Europe. They do not have massive buying power, and therefore attract no discount on the stated overseas magazine prices. By the time the product is imported, duty paid, and profit margins established, prices take a dramatic hike.

Imagineering recently dropped the price on many of its Amiga lines. No doubt due to the increased size of the Australian Amiga market, and as a result the better price at which products can be landed in Australia. Yet, with the unstable Australian dollar, 20% sales tax, dealer margins, and freight costs, the re-

tail prices may still be exceedingly high.

My view

So what is my stand? Personally I believe that products should be properly supported. I also believe that many users expect far more support than they pay for. Distributors expect the dealers to know the product, whilst dealers expect the distributor to know the product.

I guess the whole reason so many magazines exist which do nothing more than explain how to use computers, and the many packages available on them, is because so little support is truly available from the suppliers and retailers. But then, you never really paid them for that support, you only bought the product, with manual to use as you see fit.

The only comeback you have is if the package doesn't do what is described in the documentation. Anything beyond that is free help, over the phone, that costs distributors dearly to give.

On expensive products such as *WordPerfect*, there can be no similarities drawn between IBM PC and Amiga versions. Recommended retail prices may vary on software, just as they do on stereos or cars. It's at the retailer's discretion. There's nothing new about that, and nothing abnormal about it either.

You have raised some very pertinent points, which I hope the relevant distributors take note of. But I can only repeat that the piracy situation is very real. US distributors have hesitated at going to the trouble of moving product into Australia. However, that situation is rapidly changing, as you will no doubt see as this year unfolds. ■

Andrew Farrell

Ram rumblings

Professional Page released

MUCH rumored, and long awaited, *Professional Page* for the Amiga is now released. Recommended retail is estimated at around the \$600 mark. A very reasonable price for a powerful desktop publishing package.

The colour separations module is expected next month, so stay tuned. We believe this package will turn the publishing industry on end as the cost of producing colour artwork is dramatically reduced.

Laser printers are also falling in price. An emulator of the prized page description language, PostScript, is to be released soon. Many manufacturers will be adapting it into their own machines and greatly undercutting the current price floor of over \$10,000. ■

Electronic Arts Australian branch

HUGE American software company, Electronic Arts are rumored to be setting up Australian offices within the next two months. We eagerly await an even better supply of product. However, even more exciting is the prospect of Australian software having a direct line into massive US markets. More details soon. ■

Public domain software

SUPPLIES of Commodore public domain software are once again open. Over 100 disks of educational programs are available. Various other utilities and business programs are also included.

There are many subject categories including Maths, English, Science, Geography, Technology and Computer Studies. For further information contact Prime Artifax on (02) 808 1860. ■

Make sure of getting your copy - subscribe now!

Australian Commodore & Amiga Review

Please enrol me for issues subscription to The Australian Commodore and Amiga Review, commencing with the issue. I enclose a cheque/money order for \$

OR

Please charge my Bankcard number.....
Expiry date.....

Name:

Address:.....

Postcode.....

Please tick applicable box:

RENEWAL

FIRST SUBSCRIPTION

Rates within Australia:

6 issues \$18.00, 12 issues \$34.00 (both including postage)

TO: The Australian Commodore Review
21 Darley Road, Randwick NSW 2031.
☎ (02) 398 5111.

FIRST, let me take this opportunity, even though it is a bit late, of wishing you all, Compliments of the Season, and a very happy and successful Bi-Centenary.

I suppose that the best way to begin 1988 is to tell you about up-coming products and give you details of very recently introduced software.

1. A fabulous new disk drive for the Commodore 64 should be available by mid to end February.

2. **IMPACT** - for the Amiga and PC Compatibles - plays like a dream, ends up like a nightmare (in as much as you never want to stop playing). Now in stock.

"GEOS - NEOS"

3. At last!!! Packtronics proudly announce that we can supply a new driver program for GEOS run by the NEOS MOUSE so all those lucky people who have bought one of our NEOS MOUSE & CHEESE in the past can now get easier and much better graphics with GEOS. Rather than inflate the price by making up a special new package, we are putting it into a plain wrapper, and it retails for only \$19.95.

4. Also for you GEOS users, we have the GEOS Manual. The only way to really get the maximum out of your GEOS; to understand its quirks and potential; to overcome difficulties and find new uses for it (comes complete with its own software).

5. **MAGPIE DATABASE**. This has been in stock since November and we have sold out 3 times since then. This is not surprising when you consider it is probably the most advanced system available for any home micro.

- Fully user programmable database management system.
- Operated by easy-to-use pop-up menus using just four keys.
- Can perform complex calculations on numerical data.
- Searches on any field, with wild card and part-field matching.
- Horizontal or vertical bar graph or scatter graph output.
- Help readily available from Help Disk.
- Works with one or two 1541 disk drives.
- Integral Centronics interface for parallel printer option.
- Instruction manual specially written for the first time user.
- Free application templates - Mailing List and Stock Control.

It really is a bargain at \$64.95.

Ask for any of the above programs at your local Commodore dealers, and if they don't have them, then demand they get them in for you, as no Commodore dealer should be without the great range of Packtronics' products.

G.B.F.N. ■

Bodylink

Good health with your home computer.



by Andrew Farrell

If you want to get fit, or learn to relax, biofeedback program could be the answer. What's it all about? Over-stressed and under-exercised, editor Andrew Farrell filed this report.

YOU'RE probably reading this article over a cup of coffee or a can of coke. Yes, despite our best intentions, we continue to flood our bodies with rubbish, and live fast paced overly stressful lives.

Here at the editorial offices of *Australian Commodore Review*, the pace varies from panic-stricken to chaotic. So, we're probably a good bunch of people to test out one of the latest gadgets that take us a step closer to self sufficiency in the security of our own house mortgage, or fifth floor security block apartment.

Amid the sound of velcro tabs, snap

IMMEDIATE FEEDBACK

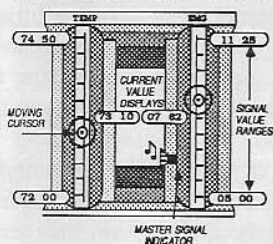

A moving cursor, signal values, and four modes of auditory feedback are available to you while you perform relaxation exercises.

fit sensors and several cartridges, a large box was spilled out onto the floor. Inside was one stress reduction package, and one muscle development package.

Egg Roll

One cartridge, named Egg Roll, appealed to my comical disposition, and I immediately tested it out.

Biofeedback works by measuring various body functions such as muscle tension, temperature and heart rate. In Egg Roll, a velcro strap with three EMG sensors is strapped across the forehead. After calibrating your personal levels of electrical activity in various states of relaxation and raising of the brows, you're ready to play.

Relax, and the bridge lowers, raise your brows and it raises. At the top of the screen a single duck waddles into view and lays an egg. By positioning the bridge, you can make sure the egg then has a safe journey down the chute.

Now I must relate a humorous experience. J Mark Hunter, esteemed games reviewer renowned for his ambiguity and flippancy, strolled into the room just as I was putting Egg Roll through its paces. Astonished that such a device even existed, he enquired as to what I was doing.

The opportunity was seized, and between myself and Adam Rigby we convinced the lad that by thought control we were playing a new breed of game.

Well, he was sceptical at first, but eventually we strapped the device to his own furrowed brow and put him to work trying to psych the Egg Roll software. It didn't work, and poor old Mark couldn't understand what all the laughter was about. We told him it must have been that Canadian mind on a different wave length.

To begin - plug the BODYLINK™ into a Commodore 64/128 computer, then plug the Temperature sensor, EMG sensor, and one of the software cartridges into the Bodylink.

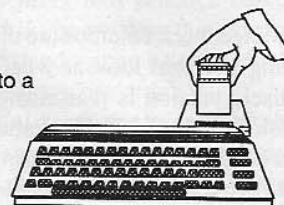

Peace of mind

So now you have an excuse to buy this thing - it's good for a bit of on the spot entertainment. But what of the practical value? Egg Roll was certainly a good start. Next for some serious bar graphs, blips and technical type information, we plugged in the Peace of Mind cartridge.

Now keep in mind that one of the strengths of this system is its ability to monitor a wide variety of signals. In combination with the right software it can be equally well used as a golf coach, monitoring the break of your wrist with each swing.

Stress reduction is only one facet of *Bodylink*, however it demonstrates well the sensitivity of the electrodes used.

We connected the same head band as used in Egg Roll, and also added the fingertip temperature sensor. From the main menu of the Peace of Mind software you may calibrate the temperature sensor, read a story, or perform Biofeedback.

FUN and FEEDBACK in the PEACE OF MIND GAME

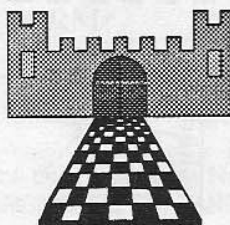

Use either your Temperature or EMG signal to control your progress in the quest for a long lost castle and the treasures it contains.

Difficulty is automatically adjusted depending upon your initial signal value.

File - Store screens on a disk or printer. Retrieve data and display it again at any time. Choose any stored signal to be the goal pattern for the adapt mode.

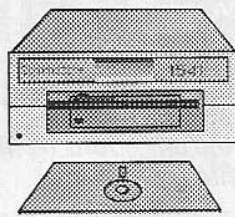

In Biofeedback columns are displayed, providing a visual look at what's going on. Muscle tension is read using a Biofeedback EMG sensor. This attaches to either a head band, electrode strip, or similar. In this way it's possible to vary the point from which the tension reading is taken. A small drop of electrode preparation fluid must be placed on each electrode for the best results.

You can also play a game, whereby your level of relaxation will allow you to progress toward a distant castle. First the software must sample a range of readings for a period of time, in order that normal levels can be calculated.

In graph mode a range of 3 or 30 minutes is displayed so you can review your body performance. Even simple changes in your position, a smile or a swallow, can cause some variation in the recorded readings.

Also included is the BodyScope cartridge. From it you can audibly monitor your body biofeedback. Just sit back and let it happen!

Bodylink BASIC provides programming commands to support the various sensors. You can then write your own software making use of each device.

A booklet on relaxation techniques

provides a good basis for experimentation. There's also a stress management work book so you can keep track of your improvements. The total Enhanced Stress Reduction package includes the BodyLink adaptor, complete with two input ports, temperature sensor, EMG sensor, Peace of Mind cartridge, BodyScope cartridge, audio cassette, and extensive documentation. The total price, \$625. A simpler version, without enhancements sells for \$255.

Without a doubt the price has to be this system's greatest downfall. Your entire computer system may only have cost as much as the package itself - something I think most people will have trouble justifying.

Comet

A little on the more affordable side is the muscle development gadget called Comet. At \$169 it falls into the maybe category. We tried it out, and found that despite the at first seemingly rickety construction, it works well.

Two booklets are included, the package manual and an exercise guide. Software is on disk or cartridge. Comet looks a bit like the classic body building apparatus called bull-

worker. The difference is this one is electro-mechanical. The only other item included is the sensor adaptor cable.

Comet plugs via the adaptor cable into joy-port one. LOAD

the software, and you're ready to play the game of strength. Calibration is important, and that's the first thing you do. That way, anybody can play it, from game reviewers right up to the publisher. (Gareth Powell declined the opportunity to test out the device. He was afraid he might break it ... over the editor's head.)

By pulling or pushing the Comet you control the altitude of a helicopter. Various obstacles appear on the screen through which you must guide the chopper. The result is that if you pull too hard when calibrating, the game becomes

Threshold - set a zone of any width and vertical position on the screen. When a selected signal enters the zone, the sound feedback changes and a timer is activated. Time inside and outside the zone is displayed at the end of a preselected time period.

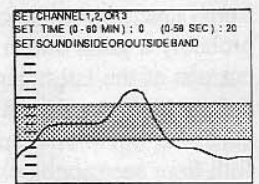

very hard to play. It does develop your muscles, but somehow it seems a little less enjoyable than taking a swim, running the dog, or taking the car for a drive. Does that mean the Comet is a flop?

BodyLink is expandable. One item from a particular package may be use in a different application within another. Comet may be used elsewhere, and various other attachments may be purchased to enhance further the facilities of the more basic packages.

Bodylink is probably of more use from an educational rather than practical point of view. Most home users wouldn't fork out the hard cash. For those who are considering, we recommend it. The documentation is well written and the entire package professionally put together.

For doctors, educational bodies, and everyone in between, very worthwhile.

For further information: Biofeedback Instruments PO Box 771, Parramatta, NSW 2150. Telephone (02) 872 1307 ■

BODYSCOPE™ SOFTWARE CARTRIDGE

A versatile program which converts your Commodore 64/128 computer into a three-channel, color oscilloscope with a numeric value display of a fourth channel. Any combination of four of the following Bodylog sensors can be used.

	Max #
Temperature	4
EMG	2
Heart Rate	4
COMET (Force)	4
GSR*	2
Limb Joint Angle*	4

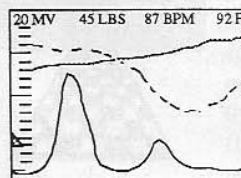

DEEP SCAN BURST NIBBLER

- The most powerful disk nibbler available anywhere, at any price!
- Burst Nibbler is actually a two part system - a software package and a parallel cable to connect the 1541/1570/1571 to 64/128 (state type).
- What gives Burst Nibbler its power? Conventional nibblers have to decode the data from the disk before it can transfer it using the serial bus - when non standard data is encountered they are beat. Burst Nibbler transfers data as raw GCR code via the parallel cable without the need to decode it so you get a perfect copy of the original.
- Will nibble up to 41 tracks ● Copy a whole disk in under 2 minutes ● Full instructions.
- Regular updates - we always ship the latest. ● Fitted in minutes - no soldering usually required.
- Full of 1/2 tracks. ● No need to buy parallel cable if you have Disk Demon/Dolphin etc.
- Cable has throughbus extension for other add ons.
- Whether to choose FastHack'em or Burst Nibbler? Fast Hack'Em is unbeatable value as an "all-rounder" - with nibblers, 1 or 2 drive copy, format, file copy, 1571 copy etc. etc., so if you have a more general requirement perhaps FastHack'Em is for you. Burst Nibbler is a pure nibbler second to none, for the reasons stated. So if it's just making backups you are interested in, there is no other product to beat it.

ONLY \$79.00

EPROMMER 64

- A top quality, easy-to-use EPROM programmer for the 64/128.
- Fully menu driven software/hardware package makes programming/reading/verifying/copying EPROMs simplicity itself.
- Will program 2716, 2732, 2764, 27128 and 27256 chips. 12.5, 21 or 25 volts.
- Fits into user port for maximum compatibility with cartridges/Superrom Board etc.
- Full feature system - all functions covered including device check/verify.
- We believe Eprommer 64 is the most comprehensive, most friendly and best value for money programmer available for the 64/128.
- Ideal companion for Superrom Board, Cartridge Development System, our kernel expanders or indeed any EPROM base project.
- Comes complete with instructions - plus the cartridge handbook.

ONLY \$139

BLAZING PADDLES

- A complete lightpen/graphics illustrator package.
- A fully icon/menu driven graphics package of a calibre which should cost much more.
 - Complete with a fibre optical lightpen system for pin point accuracy.
 - Multi feature software including:
 - Range of brushes ● Airbrush ● Rectangle ● Circle ● Rubberbanding ● Lines
 - Freehand ● Zoom mode ● Printer dump ● Load/save ● Advanced colour mixing - over 200 hues!
 - Cut and paste allows shapes/windows/pictures to be saved to/from tape /disk
 - Blazing Paddles will also work with many other input devices including; Joysticks, Mice, Graphics Tablets, Trackball etc.
 - Pictures can be saved from Action Replay and edited with Blazing Paddles.

Complete Blazing Paddles
& Lightpen ONLY \$49

Blazing Paddles available separately for \$39

CRACKER CHIP 32 For C64, 64C & SX64

- You never fail until you stop trying and all good things improve with time. These are the mottos followed by the authors of MEGAROM V3.0 and hence comes their latest, most ingenious programming feat, backed by a money back guarantee! Check out the unmatched facilities:
- One of, if not, the most compatible, reliable, and fastest serial loader available for the C64, loading on average 7 times faster than normal.
 - Fully comprehensive dos wedge V6.0 incorporating function keys, directory pause, and directory stop.
 - Now can be used with RS-232 i.e. modems etc.
 - Access machine code monitor at the flick of a switch with all the features you need including scrolling in both directions. More than 20 commands in total.
 - Memory Copier will copy the full 64K of RAM to disk in 2 files in less than 40 seconds.
 - Custom Copier will copy any RAM that you specify between \$0800 - \$CFFF to disk in one file, at turbo speed. All files saved in non-compacted format.
 - Graphics Grabber will capture any Multi-colour, Bit Mapped or Hi-Res screens to disk including sprites. Screens from anywhere in RAM can be saved, unlike many others.
 - Utilities on disk include Sprite Editor, File Copiers, Disk Back-up, Bootmaker, Graphics Slideshow, and over 150 popular program entry-points and cheat pokes!
 - Comes complete with detailed manual on how to back-up (crack) programs manually just like the pro's do! All is revealed in this easy to follow manual.
 - Update your old Mega-Kernal, or Mega-Rom to the CRACKER CHIP 32 for just \$19

All this plus more for ONLY \$69.00 + p&h

ALL NEW !!! COP THIS ... ACTION REPLAY MK IV

- Simple to use: just press the unstoppable reset button and make a complete backup to Tape or Disk at Normal or Turbo speed, in one file.
- All backups will reload at Normal or Turbo speed independently of the cartridge.
- Picture save any Hi-Res or Multi-colour screen to disk in Blazing Paddles/Koala format.
- Freeze the action then view the program with the monitor, add pokes for infinite lives etc., then restart or backup - great for customised versions of your programs.
- Unique sprite monitor - view the sprites, animate, swap, and restart or save the sprites.
- Transfer Multi-stage programs, sprite killer, sprite editor, fast format, automatic compactor, Warp 25 disk loader and much much more included in this great package.
- Guaranteed 100% to backup more programs than any other similar cartridge on the market or your money back - No Worries!

ACT NOW as initial stocks are limited
ONLY \$99.00 + p&h

3 SLOT MOTHERBOARD

- Save wear and tear on your Expansion Port
- Accepts 3 cartridges
 - Switch in/out any slot
 - Fully buffered
 - Onboard safety fuse
 - High Grade PCB
 - Reset button

VALUE \$49.00

DISK NOTCHER

- Quickly and easily double your disk capacity.
- Use both sides of your disks
- Simple to use. \$9

DIGITAL SOUND SAMPLER

- The new sampler allows you to record any sound digitally into memory and then relay it with astounding effects.
 - Playback forwards/backwards with echo/reverb/ring modulation etc.
 - Now with full sound editing module to produce outstanding effects.
 - Full 8 bit D to A and ADC conversion
 - MIDI compatible with suitable interface. (i.e. Datel unit for 29 Pounds see ad)
 - Live effects menu includes real time display of waveforms.
 - Line in/mic in/line out/feedback controls
 - Powerful sequencer with editing features
 - Load/save sample
 - Up to 8 samples in memory
 - Tape or disk (please state)
 - Complete software/hardware package
 - Com-Drum software is available separately to turn your Sampler II into a Com-Drum system as well as a sampling system
- Super Value \$129

MOUSE

- CBM 64/128 mouse.
- Wide compatibility with software including Blazing Paddles
- Works by mimicking joystick so will work in any joystick applications including graphic packages only designed for joystick.
- Functions on either joystick port.
- Optical system operation. \$99

CARTRIDGE DEVELOPMENT SYSTEM

- All the necessary parts to produce an 8K/16K auto-start cartridge
- Top quality PCB
- Injection moulded case
- Reset switch
- 16K EPROM
- "Cartridge Handbook" gives full details and tips on building and configuring the cartridge for many uses.

Great ... \$39

SMART CART

Now you can have an 8K or 32K cartridge that you program like RAM then acts like ROM!

- 8K or 32K pseudo ROM
- Battery backed to last up to 5 years (lithium battery).
- Simply load the program you require then flick the switch. The cartridge can then be removed just like a ROM cartridge
- Make your own cartridges including autostart types - without an EPROM burner.
- Can be switched on or off board via software.
- 1/0 2 slot open for special programming techniques
- 32K version has 4 x 8k pages
- Some knowledge of M/C is helpful - but full instruction are provided.

8K version \$49
32 K Version \$99

5 1/4" DS/DD 5 Yrs WARRANTY \$15.00 /BOX

Westend

Computers

(03) 350 5144

402 BELL ST., PASCOE VALE STH.,
VICTORIA, 3044



FREIGHT SURFACE \$3 EXPRESS \$7
AIR MAIL \$5 O/NIGHT \$9

Fontmaster 128

Word processing/desktop publishing for the Commodore C128

by Eric Holroyd

THIS is without a doubt the very best word processor I have seen for any of the three Commodore microcomputers with which I'm associated, ie the C-64, C-128 and Amiga machines.

I've tried out many different word processing programs and have always returned to the one I first learned and which I personally have found the easiest to use until I saw this one, and that's good old *Easy Script* on the C-64.

I do like a piece of software that's easy to use and which has been thought out with the user in mind. That's exactly what the programmer of *Fontmaster 128*, Marty Flickinger, has achieved here. I very quickly got it up and running without too much recourse to the manual as there are four on-screen menus called up by Ctrl, Logo key, Alt, and Shift/Ctrl which virtually tell all you need to know to run the software for most of your simpler word processing tasks.

When you open the package and read the instruction book before doing anything else (as all of us always do, don't we?) you'll see that the three disks are set up as single-sided disks and can therefore be used on the C-128 with 1541 or 1570 drives (or compatibles).

The use of two drives is supported, which is just as it should be with good business software. If you have a 1571 drive or use a C-128D with in-built 1571 drive you can use the proper double-sided disk format and Xetec (the publishers of *Fontmaster 128*) have provided a copy program to allow you to make a double-sided disk of the program master disk plus the fonts supplement disk. It's extremely easy to do this and you end up with a single auto-booting disk instead of two separate disks.

Fontmaster 128, by the way, is not

copy-protected as such but requires a dongle, or security key device, to be inserted in the cassette port of the C-128 to allow the software to run. This is a terrific idea, as you can make your legally-allowed backups of the program easily and quickly with whatever copy program you have handy, but pirating is obviated as any unauthorised copies put into circulation won't run without the dongle.

Having read the book and made your backups you're ready to load the program and go to work.

When the program disk is booted there's a message to change the display to 80 columns and after this is done the load continues, to quickly come up with a menu screen offering loading choices of: Word processor, System setup, Font creator, Character set creator, Text translator, Graphics converter or Back to Basic.

System setup

Obviously the first thing to do is run the System setup whereby you choose your printer and interface from a very comprehensive list (over 100 printers are supported) which has the added bonus of telling you just how good each type of printer is at doing various graphic and font printouts. In this mode you set up your favourite screen colours for all the displays you'll be working with plus establish any dip-switch settings which may be required on either your printer or interface. When it's all done you save it to the disk and it's then loaded in automatically every time from then on.

Just for that extra bit of convenience you may save two different setup files in case you work with different printers ie one at the office and one at home. You may switch between the two setups from

within the program. It's all very easy to do and before you exit this mode there's a "test this setup" feature which shows instantly if you've done it right. Just compare your printout with the one in the manual and you'll know immediately if all's well.

Once you've finished your setup file you're ready to use the features of this amazing program which, in addition to all the facilities offered by regular word processors, offers the following:

- Format text exactly as you want it, with over 70 easy-to-understand commands.
- Use up to nine special fonts at once (over 50 supplied) anywhere, any time.
- Three text heights, Tall, Normal and Micro.
- Italicise any font.
- Print in up to four columns.
- Create your own fonts.
- Bilingual feature and special fonts for foreign languages.
- Reverse the screen for foreign languages which read right-to-left.
- Define a "macro" of up to 64 keystrokes to use from a function key.
- Paginate with Decimal or Roman numbers.
- Automatic paragraph indentation.
- Use special line increments as al-

lowed by your printer.

- Cause printer to stop for insertion of paper when using single sheets.
- User-adjustable proportional spacing, underlining, superscripts and subscripts.
- Overlay two letters to form special characters.
- Four print pitches, (Pica, Elite, Alt & Konnect) each available in expanded, normal and compressed, and a lot more!

Most word processors allow you to "justify" or vertically align the right or left hand edge of the text as you print to make a nice, neat-looking job. If you're making that special sales presentation or annual report for the board meeting which requires that the printouts be bound into a book or folder you can specify "Edge Outside" which prints all text on even page numbers butted up against the left margin and on odd page numbers butted up against the right margin. It's all very easy and so very effective.

One of the greatest annoyances when I'm writing a long article is the amount of paper I can waste in printing it all out to see what it looks like only to find a problem in the second or third page. This then has to be corrected and the printout repeated. With *Fontmaster 128* there's no need for this as all you do is "mark" a block of text by pressing Ctrl/M at the beginning of the block, press the cursor down key to highlight as much of the text as you want to print, then press the printout button. Simple! No more paper (or time!) wasted.

This same feature of block marking is used to view your text on screen or prior to "cutting" it to "paste" somewhere else in the document. When moving blocks of text the program puts it into a memory buffer and you specify where you want it putting by moving the cursor to the new spot. You may put copy the same block of text into several different places

in your document if you need to once it's stored in that buffer too.

Gobble

I loved the feature called "gobble" (Ctrl/G) which does just that. It gobbles up unwanted text as long as you hold down the keys. If I wished to rewrite a sentence I'd use gobble, then Ctrl/I to switch on Insert mode which opens up the text to accommodate the rewritten sentence. The handy reference card which comes with the three-disk set shows most of the oft-used commands like these plus some of the font styles.

The reference/instruction manual is excellent and uses simple language to explain what does which. This is great for simple folks like me, and there's a fair bit of humour here and there in the manual which brightened up the learning process for me too.

I've previously reviewed another product from the Xetec company, ie their Super Graphics Senior printer interface, so I knew before I looked at this one that it would be of a pretty high standard. I wasn't disappointed, in fact was very impressed with the thoughtfulness that had gone into making it user-friendly.

Screen protection

I mentioned this earlier in the piece but there's one extra-nice feature that I should single out and which actually cares for your equipment. It's called Screen Protection and it can be switched out if you don't want to use it, although I can't imagine why you'd not want to.

What it does is change the screen's colours at regular intervals if you leave your C-128 unattended for more than five minutes to avoid damaging the screen. Users of automatic teller machines or video games players will have seen images "burned-in" to the phosphor of the monitor screen which are there even when not actually being displayed. Your own monitor could suffer the same fate if left with the same display for extended periods but Xetec's Screen Protection idea will prevent that. Simply starting to

work again returns you to your chosen screen colours.

The opening menu offers several choices as I said before, one of them being a file converter. This converts data files from other word processors to *Fontmaster 128* format so that you may reuse them by adding fonts and other special effects. I used this feature to add a graphic to my normal "letter blank" file which I use when letter-writing to print my name and address etc at the head of the letter. It now looks quite professional with a graphic inserted and printed in one of the fonts. I haven't settled on which font yet as there are so many nice ones to choose from.

Graphics

Graphics conversion from *Print Shop* is a snap, just load the conversion program from the opening menu and follow the prompts. Hi-res pictures, too, are a source of graphics to be used in *Fontmaster 128* and if you have any *Doodle* pictures you can use selected sections from those using the conversion program to save them to your data disk.

Owners of the Cockroach Software Graphics Utility package will have unlimited hires pictures captured from their favourite programs to use with this feature. Pictures made up from several *Print Shop* graphics are easy to make and store also and when you come to print out your masterpiece you may specify the exact point where the graphic is to be inserted and whether in normal or double width. It can be anywhere in the text which then automatically formats around it.

One thing I found to be a help which wasn't mentioned in the manual was to copy the file called "v.normal" onto my data disk, as working with one drive meant that the program would display "normal character set not found" after I displayed a file containing graphics which had to be loaded from my data disk. Apparently, after displaying to the screen the program returns itself to normal configuration, having just made a

WYSIWYG display using all the fonts, underlining, graphics and other special effects right there on the screen so that you see exactly what will finish up on your paper. This great display is in 60 columns and the cursor keys let you scroll across to see the full view.

Also on the opening menu are the Font Editor and Character Set Creator. Both are pretty sophisticated editors and are only limited by your own imagination. Make your own fonts if the 50 plus supplied aren't enough for you, or if you speak a language that's not catered for in *Fontmaster 128* then make your own character set to write and print in it. Don't forget that if your foreign language reads from right to left you can print it that way too!

Spellmaster 128

The third disk I mentioned above is *Spellmaster 128*, which is a spelling checker containing well over 100,000 words in its main dictionary. These are divided into five categories: Normal words, Abbreviations, British words, Proper names, and Vulgar words. You'll have to buy it to check which words are included in the last category but the British word section is included due to it being an American program and as such would have slightly different spellings for some words.

It's a good spell-checker and also allows the use of "wild card" matching for very fast searching for a particular word in the electronic dictionary whilst you're actually writing the document rather than running the full-on spell checker after you've finished. This is marvellous because you're able to use your computer's speed to look up a word rather than having to manually flick through the pages of your printed dictionary.

Also, as many computer users are involved in specialist fields, each with its own peculiar jargon, there's a facility to create your own "user

dictionary" to work in conjunction with *Spellmaster* and you're encouraged to make a backup of the master dictionary disk before you start to save anything else to it. Once again, a good idea and it's easily done due to there not being any copy protection.

When you run the spell-checker it first of all sorts through your document then displays (a) the number of words,

(b) how many unique words, (c) average word length and (d) average sentence length. (NB "unique" simply means words not repeated.) When checking is finished you're either advised that "no spelling errors" were found or you'll get a screen message telling how many errors were actually found and they'll be shown on screen with a flashing highlight. Choices at this stage are (I)gnore,

FONTMASTER 128

by Xetec

Here are some samples of what Fontmaster 128 can do:

- ◆ **Font changes can occur anywhere**
- ◆ Up to nine fonts can be used in the same file. Over 55 included on disk
- ◆ 12 standard pitches
Expanded Pica
Expanded Alternate
Expanded Elite
Expanded Konnect
Pica pitch
Alternate pitch
Elite pitch
Konnect pitch
Compressed Pica
Compressed Alternate
Compressed Elite
Compressed Konnect

Plus dozens of pitches in between!

- ◆ Proportional spacing
Regular vs. proportional spacing
Regular vs. proportional spacing
- ◆ Underlining is adjustable
- ◆ Superscripts (height is adjustable)
Type 1: E=MC²
Type 2: E=MC^e
- ◆ Subscripts (also adjustable)
Type 1: H₂SO₄
Type 2: H_eSO_e
- ◆ **Boldfacing is no slower** than normal text
- ◆ **INVERSE** text (white on black)
- ◆ Italicize *any font*
- ◆ Three text heights:
Tall
normal
micro

(With 3 heights and 3 widths, 9 character sizes can be made)
- ◆ Foreign languages:
БОЛЮЩЕ СПАСИБО. КОТОРИЙ СЕЙЧАС ЦАС?

Plus, use the included font editor to create your own good-looking fonts!

(R)eplace, (A)dd or (L)ookup.

If a highlighted word isn't misspelled but merely one of your specialist words just press (A) to add it to your User Dictionary. If it is a mistake you may replace it by pressing (R) and the text will adjust around your corrected word if it's longer or shorter. In the case of Lookup the program searches both main and user dictionaries for words similar to the highlighted misspelling for your reference. Once you see the word on screen you can abort the search with Run/Stop, which is the abort key in most modes of *Fontmaster 128*.

The *Spellmaster* booklet included with the package gives timing figures for a full search of the main dictionary using various disk drives. The 1581 drive (3.5" disks, not yet available in Australia)

takes 30 seconds. The 1571 takes 35 seconds. A 1541 would take 109 seconds, still not at all bad for searching through 100,000 words! If your drive will emulate a 1541 the same time applies or there's another setting you can default to when making your setup file initially. Both *Spellmaster* and *Fontmaster* support the two models of RAM expander made by Commodore for the C-128: model 1700 with 128k and the 1750 with 512k. With the latter you actually load both programs into the expansion RAM meaning that there's no disk swapping required, also the spelling check is much faster at around 15 seconds.

Conclusion

To sum it all up I'd say that this is a

most impressive package which is easy to learn, easy to use and gives extremely professional results. It's a very useful word processor for home or office and with the ridiculously low prices now being offered for the C-128 you could set up a fantastic word processing station with colour monitor and printer for under \$2000 to do all this and more, plus the ability to use all the other features of the Commodore C-128 and C-64 for your database or spreadsheet etc, and there's always the games.

Fontmaster 128 retails in Australia for around \$89.95 and is distributed by: Dastron Pty Ltd, PO Box 336, Leichhardt, NSW. Telephone (02) 712-3124. ■

Keep up with Commodore at Maxwell The Commodore Centre

The largest range
the very latest and
No. 1
for
SALES, SERVICE,
SUPPORT and HIRE

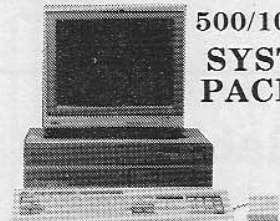

500/1000/2000
SYSTEM &
PACKAGES

Hard Drives 3.5" & 5.25" Drives, Parallel & SCSI Drives, Digitisers, EasyL, Penmouse, Synthesizers & M.I.D.I., Graphics & C.A.D. Music & Sound Samplers, Games & Business, Colour Dot Matrix, Thermal & Inkjet Printers, Desktop publishing, Modems, Screen Filters, A2000/A1000 Interfaces, A2088 PC Bridgeboard, A2090 ST506/SCSI Drive Controller

* NEW RELEASES *

Firepower, Land of Legends, Plutos, Gold Runner, Galactic Invasion, Hardball, Mean 18 Vol II, Desktop Artist, Animator Junior, Visawrite, Haicalc, Enigma, A500/2000 Tech. Manual, Amiga World November



C64/128

1201/1802/1901/ Monitors, 1541C/1570/1571 Disk Drives, Cartridge Expanders & Joysticks, 128 Ram Expansions, Lightpens, Mouse EPROM programmers & Blank Cartridges, Business, Accounting, Word Processing, Databases, Spread sheets, Inventory, Gen Ledger, Languages, CAD, Disk Care Kits, Multifunction Disk/CD Boxes

* NEW RELEASES *

Geocalc, Geo Publish, Road Runner, Super Sprint, Comics, Tanks, Tai-Pan, Exolon, Six Star Hits, Captain Zapp, Speed King, 5-A-Side Soccer, Warship, Plasmatron, Book of the Dead, Living Daylights, Temple of Doom, Freeze Frame III utility, Assembler Monitor, Advertiser, Sub-Battle



5/10/20/40
COLOR &
MONO
SYSTEMS

Hires Mono, Hires Colour, Business Software, Hard Drives, Hard cards, AGA cards, Multifunction Cards, Mouse & Joysticks, Ram upgrades, Package offers. Clock Cards, EGA Cards and Monitors, RS232 Cards.

● EXTENSIVE RANGE OF ENTERTAINMENT SOFTWARE ●

* MAIL ORDERS *

CALL (03) 419 6811 (6 Lines)
VIATEL Page 64266 or write to:
FREEPOST 2 (No stamp required)
162 Nicholson St, Abbotsford, 3067

MAXWELL 162 NICHOLSON ST., ABBOTSFORD 3067 • PHONE (03) 419 6811 • VIATEL 64266

Avtek megamodem 12/123

A review by Adam Rigby

HAVING used a totally manual 300 baud modem for some time, the progression to the all Hayes "AT" compatible 1200 baud modem was a delight.

The Avtek Megamodem came packaged in colourful box professing all the attributes of this little marvel. Little, by the way, is an understatement - weighing in at only 250gms and measuring 27mm (H) x 120mm(W) x 165 (D) this unit is compact. You hardly notice it sitting atop of your Amiga 1010 drive.

The unit comes in two models;

Avtek megamodem 12:

CCITT V21
BELL 103
CCITT V22 & BELL 212
Baud rates:
300/300
1200/1200

Avtek megamodem 123:

CCITT V21
BELL 103
CCITT V22 & BELL 212
CCITT V23 (Reversible)
Baud rates:
300/300
1200/1200
1200/75
75/1200

Unpacking the modem is easy enough, just unwrap and plug in. With the included documentation you should have no problems getting your modem up and running.

The user manual progresses through every point that could possibly arise whilst using the

modem, including a complete list of what to do if the modem appears to be faulty (point number one is READ THE MANUAL!).

Incidentally, Avtek offer a 12 month warranty period from date of purchase if registration is completed and posted.

Aesthetics are very important in both the office and home environments these days, so as always the manufacturer must meet the demands of the consumers. Avtek have done this very well and produced a very compact neat-looking modem. The modem is black in colour and has a series of indicator lights along the front panel - these show the various states of the modem such as auto-answer, on-line and high speed baud.

Using an Amiga 1000, the Megamodem was tested extensively as both a remote terminal and with existing B.B.S. In all cases the modem proved to be quite satisfactory and predictable.

Considering that the Avtek Mega-

modem is produced in Australia, you can expect you would receive an abundance more for your money than with imported competition. Product support is also easier to deal with when a local product is concerned.

Whilst I had some minor problems with the review modem (which was a prototype), Avtek were very quick in fixing these. In view of the fact that this modem is at least as good as the competition, and it is made here locally, I feel that Megamodem would be my first choice in buying a modem for my Amiga or PC.

Avtek Megamodem 12/123 is distributed by:
Avtek Pty Ltd, P.O. Box 651, Lane Cove, 2066
Ph (02) 712 3733 ■

NEW — Australian Commodore Review Disk Magazine No 9 available now !

*** Double-sided, now with more C128 programs ***

C64

14 graphics and music demonstrations from Compunet

Little Invoicer (compiled) - A fast jazzed up version of the program appearing in November *Australian Commodore Review*. Contains anti-garbage collect routine to eliminate waiting time on string garbage collection. Ideal for small businesses.

Sprite Clock - As appeared in October *Commodore Review*. Displays a clock in the border out of the way of your own program. Great for keeping track of time when you're working.

Sprites in the Border - All the routines and main program you need to write your own sprites in the border program. Complete with message editor and examples.

Also various games, utilities and graphics programs

C128

128 Disk Filer
Catalogues your disks to save time searching for a program. Ideal for expanding disk collections.

128 Block Reader
Find and read secret information on your disks. Every true hacker needs one.

Also three music programs

ORDER FORM

9

Name.....Address.....
.....Postcode.....
Cheque/money order.....Bankcard.....No.....Expiry Date

Signature..... Send me.....copy/s of Disk Magazine No 9 at \$12.00 each plus \$2.00 P. & P.
Post to : AUSTRALIAN COMMODORE REVIEW, TOP REAR, 4 CARRINGTON RD, RANDWICK, NSW 2031 (02)398 5111

"THE 3 BEST WAYS I KNOW TO INTRODUCE YOUR FAMILY TO THE WORLD OF COMPUTERS."

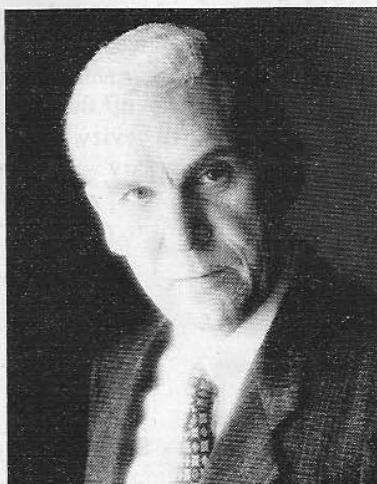

John Laws
John Laws

\$399 RRP.

The Commodore 64C Family Pack

Including: The Commodore 64C, the world's largest selling computer with over 7 million units sold worldwide and thousands of software titles available.

- 2 joysticks
- 5 software programs for games, entertainment, education and finance management: Wizard of Wor, International Soccer, Visible Solar System, Magic Desk, Financial Advisor.
- Superbly illustrated book on Australia's history.



\$649 RRP.

The Commodore 64C Pro Pack

The total personal computer package:

- Commodore 64C computer
- 1541 disk drive, enabling storage of information, and access to thousands of additional software programs
- Joystick
- GEOS Software to enable use of a mouse or joystick, making learning easier and faster.
- 15 software titles for games, entertainment and utilities.



\$999 RRP.

The Commodore Amiga 500

From the revolutionary Amiga range of computers, the Amiga 500 is the ultimate in home computing with superior graphics application. The Amiga 500 puts the fun back into computer learning.

- 512K internally expandable to 1Mb
- 4096 colours
- 4 independent stereo channels, built-in music and voice synthesiser
- Capable of multitasking (runs more than one program at one time)
- Hundreds of software programs available

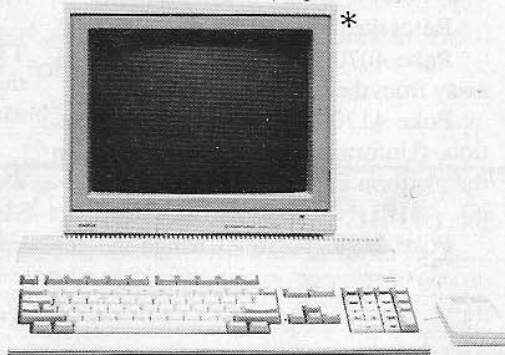

commodore
Available at all major department stores and authorised Commodore computer specialists.

ARE YOU KEEPING UP WITH THE COMMODORE?

*Monitor extra
John Singleton Advertising, COM022

Arcade action

WELL, it's a new year and that usually brings a lot of new products including heaps of new games. Looks like the C64 hits the spot with the game reviews this month, not to fear - the Amiga will have its own next time round.

On the hot releases front, the Amiga has some interesting new titles that most of us are anxiously awaiting. *Romantic Encounters* from Microillusions should be here by February. *Turbo*, a One to One auto racing game with plenty of op-

tions, is due out about the same time.

Imagineering carry some new products which are well worth a look such as *Powerpack Amiga*. (Which wasn't available at the time of publishing.) We are looking forward to seeing what this new game pack for our beloved machine is like. Also *Airborne Ranger* and *Thunderchopper* for C64 are hot off the production line. We hope to review most of this software in February - so watch out. ■

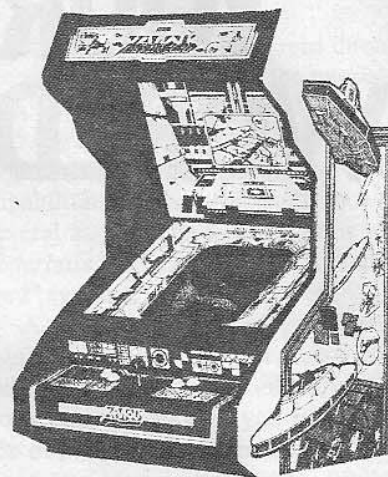

Hints and tips

THESE tips were sent to us by Stuart Hallam of Frankston, Victoria.

Ghosts and goblins

First get to the last level, where the zombies rise up from the ground and the bats are located. Go to the first ladder and position yourself half-way up, wait for a while and eventually you will see yourself running towards the princess. As well as this you get the bonus for completing the level, however, this could be a bug because it only occurs once per loading.

Pokes:

Reset then type.

Poke 4070,170 - Begin one section away from the start of each level.

Poke 4170,10 - Stop sprite detection. (Unfortunately you can't jump on the platform in the water on the first level).

Poke 2198, 1-250 - Change the co-

lour of the sprites.

Poke 12707,255 - Speed game up ten-fold.

Poke 12707,240 - Returns game to normal speed.

Poke 7777,0 - Stops all monsters moving.

Poke 7777,168 - Returns monsters to normal movement.

Sys 2090 - Initialises game to normal settings.

Bombjack

Reset then type.

Poke 4056,173 - for infinite lives.

Sys 2238 to restart.

TIP: After losing your last man, reset then type "sys 2243" to restart on the same level you were previously on.

Bombjack II

Reset then type.

Poke 10715,234 (return)

Poke 10716,234 (return)

Poke 10717,234 (return)

..For infinite lives.

Sys 15146 to restart game.

Feud

Reset then type.

Poke 16404,15 - For all ingredients at the start of the game. Poke 17204,15 - For all ingredients infinitely.

Poke 17591,1-40 - To move around with a different speed. 1 = slow, 40 = fast.

Sys 16384 - resets the game

Tiger mission

Mega Cheat: For cheat code hold down the following keys (use your nose if necessary)

CTRL, Commodore, 2, Q, R, L, I, K. ■

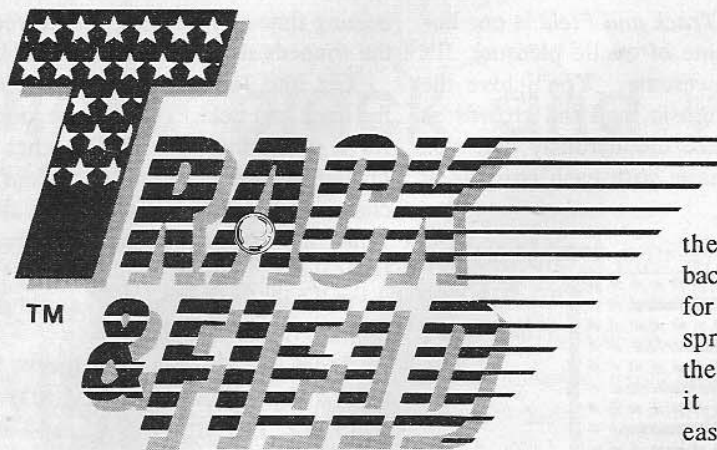

TRACK & FIELD

by J. Mark Hunter

VERY, very good. I'm pleased, I'm impressed, I'm satisfied. Six track and field events to make you sit up and take sweated notice.

You against either an opponent or the computer, *Track and Field* is a quality test of dexterity and timing.

The first event is the 100 metre dash. Determined on raw speed, your job is to move the joystick from left to right as fast as you are able. This gets the runner's legs blurring into speed and endurance to the winner's banner.

It takes a while to understand that what appears to be annoying is trying to get the joystick to respond correctly, is actually the most amusing half of the game.

I like the split screen depicting each runner on his particular track.

Say, you against the computer, you desperately try to keep up with the machined man that never tires and break the banner first. If you come in a late second your screen keeps pace with you until you meet up at the finish with the winner. Then the character waves his arms in the air as a gesture of victory, or smothers his face in the crook of his elbow at defeat.

Next event is the long jump. Here your first taste of real difficulty sets in. Flipping

You tend to be so concentrated on your running efforts and jump kind of late. Then, it's a matter of hitting the fire button the character halts at the line and holding it down until it reaches at least forty-five degrees. This is the best angle for a qualifying jump.

In the 100 metre dash the qualifying time is 13:00 seconds. In the long jump it's 7.00 metres.

You get so excited that you tend to falter every so often and foul with such oversteps of the mark. If you get three fouls in the game, you're dead.

You immediately go back to the be-

ginning and start working your way back up from the 100 metre dash.

On the javelin throw, you get up speed in the same way and at the mark heave the spear into the air at recommended 40 degrees. The qualifying distance is 72.50. The javelin is a good event, but on an increasingly harder scale it doesn't seem to be more difficult than the long jump.

However, the 110 metre hurdle run - I'll just type that again, the hurdle run is a look into major finance problems. Here you not only want to maintain your speed, but worry about getting those fat legs over the bars. If you knock one you trip onto your face and lose a lot of precious time getting back up. It's a great test of fitness though and a lot of fun. Qualifying time - 13.50 seconds.

Then, we move into the hammer throw. Very dizzying, yes. And, like the rest, moving the joystick back and forth gets you into the incredible thrusting speed necessary to accomplish a good, qualifying throw. The distance for that is 77.00 metres. But be careful of spinning too much or you'll foul. The sound effects on this one are excellent. It sounds like an army medical chopper starting up. Ideal angle is between 40 and 45 degrees. The screen changes as well. First you're watching the caged deck area where your man is starting to spin out, then, the throw takes you to a wide screen shot of the field and gridded perimeters of the outward distance. It takes a while to get the moves on this correct and release the fire button at the appropriate time.



Lastly, the high jump becomes the toughest jump of all. You start off by rapidly moving the joystick, then the computer takes over and controls your speed so that you can concentrate on the timing and angle of your jump.

All told, *Track and Field* is one humungous game of cyclic pleasure. It's somewhat awesome. You'll love the moves, the music, and the crowds as they cheer and thunderously clap you into their hearts with each struggle at

beating time and distance to take you to the winner's stand at the end of the play.

Get into *Track and Field* or get off the track and field. You've been looking for a game that eats cockroaches for breakfast - well, this is it. No aliens, no chance to leave the pilot smoking alone. *Track and Field* is for you, it's for everybody else.

Can I go now?! Thank you, and good night.

Track and Field is published by Konami and distributed by SLM (03) 699 6155 RR cassette \$29.95 and disk \$32.95. ■

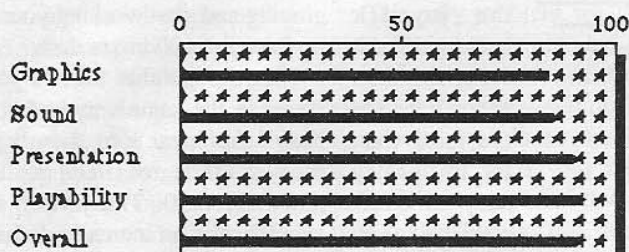

THE TUBE

by Sebastian Bass

THE YEAR 2523: the ship under your command, whilst returning from another mission, is sucked into a black hole. Surprisingly, however, you and your crew awaken to find another world on the other side. This is not all you find.

Yes, folks, it's an alien-made contraption, used to suck all the energy from ships such as your own.

By sheer chance, somehow you remain able to pilot your craft and thus stand a chance of making it through the contraption; better known as The tube.

The first frame is something of a novelty: you must simply shoot all of the objects coming towards you, which include ugly faces and whirlwinds. All the while, you are propelled towards a rectangular space, which is the next frame. It's virtually impossible to die in this stage, but it helps to shoot as many faces down as possible, as this increases your conservation of energy, which in turn makes it easier in the next frame where energy is rare.

Frame 2 finds your ship trying to negotiate a setup somewhat resembling Scramble in days of old. However, your ship has a shield, activated by one of the function keys. The shield drains the ship's energy at an alarming rate, and after the shield has been in use for any length of time, energy must be found if you are to make it out of the Tube.

Energy is obtained not by simply bombing fuel depots,

but by "docking" with other unfortunate s trapped in this alien

construction, who, for some reason would rather sit idly inside the Tube rather than attempt to get out.

The docking procedure itself is quite a

trauma. First you must find a ship in one of the holding bays, approach it in the correct manner, and then find the right pathway for your fuel, all of which is not as easy as it sounds. I'll tell you now that in order to dock, it's best not to sit atop the other craft, but rather better to rub noses with it.

After docking and refuelling, you are again confronted with more flying faces, this time it is possible to see that some of them look remarkably like angry Carmello Koalas. Then it's back to the Scramble simulation, made different this time by more energy fields, and more things to shoot. This pattern of scramble\dock\aliens continues eight times, until you are free to leave the tube forever.

The Tube consists of three basic frame layouts, only one of which is uniquely original. Apart from the Scramble frame, the docking phase seems to resemble *Xevious*, without the fun of high speed combat. Nonetheless, *The Tube* is good fun, providing different frames with different levels of skill required.

As far as graphics are con-
(continued on page 18)

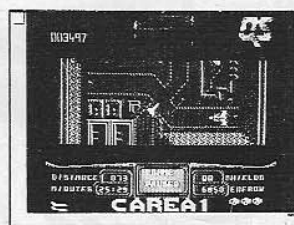
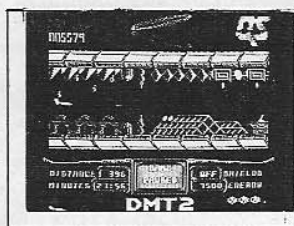

Commodore and Amiga Annuals 1988

*Now on sale - the most valuable
publications you could ever hope
to add to your magazine collection.*

In a special Annual edition, one each for the Commodore and Amiga
Computers, these provide the most exhaustive guide to
home computing in Australia.

Each Annual contains a comprehensive glossary of terminology
divided into special subject categories.

*Subjects such as communications, graphics, music, small
business and entertainment are given coverage.*

For beginners there's tutorials, and for the expert articles on subjects you've
only heard about - such as how to put sprites in the border.
Listings of software packages and comparisons of leading brands.

Don't Miss Them!

At \$5.95 they're bound to go fast

**Available NOW from newsagents and computer dealers
or direct from us**

To order your personal copy now, fill in the form at the bottom of this page and send it to:
Gareth Powell Publications, 21 Darley Road, Randwick, 2031. (Phone (02) 398 5111)

Name.....
Address.....
.....Postcode.....
Cheque.....Bankcard.....No.....Exp.....
Please Send meCopies of Amiga Annual 1988
Please Send meCopies of Commodore Annual 1988
at a cost of \$5.95 each plus \$1.00 P. & P.

cerned, *The Tube* shows up quite well. The initial stage of "attack of the mutant Koalas" is seen from inside the ship, with the parameters of vision alterable by the joystick. However the other two

types of frame are, whilst quite well done, nothing new. The sound effects in *The Tube* are compelling, and quite impressive.

The Tube displays high levels of pro-

gramming, not only in sound and graphics, but also in the use of sprites in the border. *The Tube* is one of the first games to utilise this new innovation, and actually pulls it off quite well.

No new ideas are presented in *The Tube*, it is really only an amalgamation of some ages-old themes and ideas. This, however, does not detract from the game's ability to amuse. Actually, I found *The Tube* to be quite a fun and challenging game.

The Tube is published by Quicksilver. ■

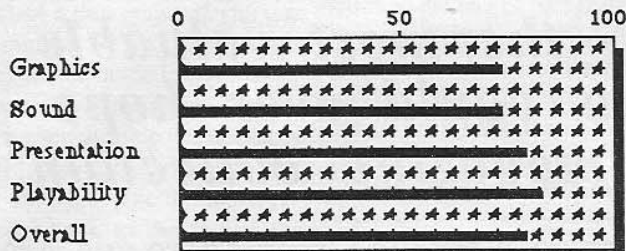

RAMPAGE

RAMPAGE is a game taken from the arcades - the conversion is a very sound one indeed. Anyone not familiar with this monster mania, please read on as Sebastian Bass explains the frightful functions of these fearful fiends!

Rampage is not so much a "shoot 'em up" game, rather a "squash 'em and destroy-as-much-as-possible" game. In it, you play the part of either Godzilla, King Kong, or Wolfman. Up to three players can play this game, and it doesn't really matter who is who, as all monsters have equal destroying abilities.

At the start of the game you and you two friends are ordinary, everyday people. However, with a large dose of Mega-Vitamin, you grow to huge proportions. This growth enables you to stomp police cars and tanks, punch helicopters, and, best of all, deck as many buildings as

you can.

To do all of these wonderful things, you must keep your strength up by eating almost anything; from goldfish bowls and televisions to the occasional person that happens to be caught unaware. If this sounds a bit too morbid for your liking, I must emphasize that it is purely a fun game. After all, 50 ft monsters don't often eat people, where I come from anyway.

To move on to the next city, you must have sufficiently destroyed all the buildings. The monsters actually stay

three days in each city, and throughout the course of the game, move through 50 cities. As each day is represented by a new screen, this makes 150 screens all told, which is quite an achievement.

After you have completed each day's destruction, a clue will appear on your screen, telling you how to make life easier for your monster.

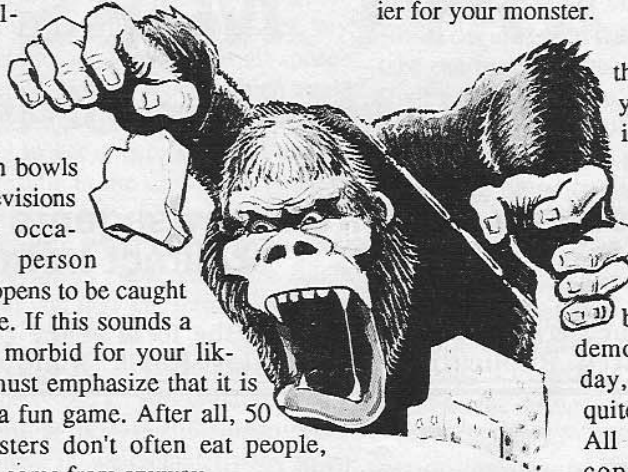

In order to get through each day, you must punch in windows and tear away framework, until the building collapses. There are several buildings to be demolished in each day, which can get quite hairy (get it?). All the while, helicopters, national guards (which actually make quite a nice meal), tanks and police are shooting at you. This actually makes you feel less

guilty about eating them.

Your monster can die if he is hit by too many bullets, or if he is caught in too many collapsing buildings. A damage display is underneath your monster's name, and once you have been killed as a monster, you return to your meek and mild-mannered human self.

Your punches are not restricted only to buildings; you may also punch your fellow monsters, which, after a while, will force them to return to their human selves. It's quite a good idea to kill the other two if you're playing a one player game, as you can then eat them once they return to being small again. This in turn will help you live longer, so it just may pay off to turn cannibal.

The game has one, two and three player options; two on joystick, one keyboard. Three players can advance a lot further than just one alone, because, although the other two monsters are controlled by the computer in the one player game, they never do as much damage as a monster with a human mind. As the monster trio advance through the various cities, they encounter an increasing number of aggressors who, for some reason, are a bit agitated about the destruction of their city. Their aggression grows until it simulates a full scale war against you.

Rampage is actually quite an amusing game, despite the morbid theme. The graphics are well done, giving Kong and his mates a gleeful expression as they set about their rampage of destruction, and a hurt look when they are punched. The movement of the monsters is quite smooth and easy to control. The windows in the buildings open to reveal the odd meal, and can be seen quite easily.

The background music is fine, but I really went for the sound of crunching stone, smashing glass and collapsing

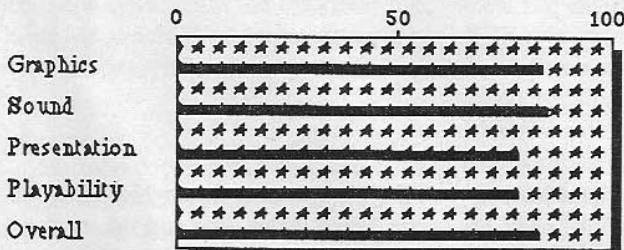

buildings. The sound effects really add to the game, all that's missing is Rachael Welsh's screaming, which we all could probably do without anyway.

All in all, Rampage is a very worthwhile game showing some marked improvements on a very old, raw theme. The blood lust and destructiveness of the game is neutralised by very amusing graphics and sound effects.

Published by Activision, Distributed by Questor (02) 697 8666.

RRP disk \$39, cassette \$29. ■

Commodore C64 PROBLEMS?

HERE IS YOUR NO FUSS SOLUTION
Exchange service for faulty boards

3 Months Warranty by return mail.

\$89.00 INCLUDES POSTAGE AND HANDLING

*Simply undo a few screws to remove your computer board from its casing and unplug power lead and keyboard connectors.

*Your board must be complete with all chips etc. and must be in a serviceable condition.

*CHECK your power supply is not at fault before sending your board.

*Your exchange board is sent by certified mail the same day we receive your board. Full re-assembly instructions included.

Mail securely packed board with remittance of \$89 to :-

PARCOM PTY. LTD.

FREE POST NO. 9 CARINA QLD.4152

PHONE (07) 395 2211

BANKCARD-CHEQUE-POSTAL ORDER

NAME.....

ADDRESS..... PC.....

PHONE..... PAY BY CHEQUE.....BANKCARD.....POSTAL ORDER.....

CARD NO.....

EXPIRY DATE.....

SIGNATURE..... DATE.....

FLUNKY

IN THIS game you play a menial servant at Buckingham Palace. The gist, the goose and the gander of the game is that, being an under privileged peasant involved in such a position you must be very submissive and follow all commands. But your real aim in your life of servitude is according to the makers of this Piranha software, to collect autographs of the different Royals who collect their mail at the London address.

As you perambulate the halls of the esteemed abode carrying out such duties as lighting the fires in the royal apartments and delivering messages, you get to meet some of the family. If you do as they ask they will reward you with the autographs you seek.

You may find yourself fulfilling all kinds of odd duties for Andy, Fergie, Charles and Di. If you are truly skilful as a Flunky you may even manage to wheedle a signature from the

Head Momma herself.

You start out with just a box of matches and your autograph book to help you, but there is room for one more article in your pocket providing it's small enough. You may find a bomb, a pistol or even a tug-boat could come in handy in this strange household.

Peril! The palace guards are mean machines, dealing out swift punishment if you should break any of the rules of the House. But they too can be avoided.

Getting into the game, we find the white-haired green-vested English person walking the corridors waiting for a com-



mand to appear on the screen. A request by some dude in the bathtub, who I guess they mean to be Prince Charles, for a boat, means that the flunky must be

controlled down another couple of corridors and through a few doors to get to this table that is accommodating a large vessel.

The flunky picks up the steamboat and carries it to the bathroom where the bubbled heir rubba-dub-dubs himself to cleanness. He gets the boat and flunk master is rewarded with an autograph.

The excitement doesn't actually build in this game because there is no foundation. It just flounders there waiting to be used. It never is.

The colours, the graphics and such are passable. They cannot be criticised

Graphics
Sound
Presentation
Playability
Overall

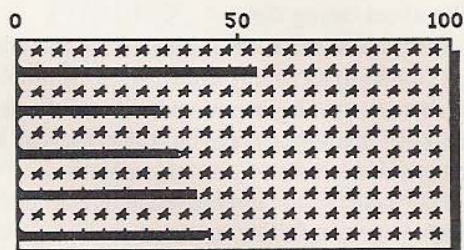

for lower than average grades in design. It was occasionally amusing to watch the routines of the characters but this all faded at the speed of light.

Flunky, moving in any direction around the screen, with the capabilities of picking up and putting things down, is a lousy excuse for a pleasant waste of time and you get about as much nutritional value from it as a rubber snake. The game is called Flunky, and my motto is: "You are what you play."

Editor's Note: Michael Spiteri has a different opinion of this game. Look out for his review in *Adventurer's Realm* in ACR February. ■

Que Dex

The quest for ultimate dexterity

Provoked by Adam Rigby

NOT QUITE the on the same scale as the Quest for the Holy Grail, but nonetheless ...

A title page with simply brilliant music playing was a definite pleasure. I have a surprise for you - whilst drinking my coffee I actually read the instructions so I knew what was happening when the game started - a first for the modern computer journalist.

The basic idea behind this game is similar to *Marble Madness!*, except there is considerably more strategy and varia-

tion. The game evolves around ten sections or planes to the game, each of which requires a different tactic or skill.

Looking at the game at the most fundamental level, the idea is to reach a GOAL (similar to *Marble Madness!*). To arrive at the GOAL many problems must be negotiated such as locked doors, electric seas, disappearing floors and multi layered platforms.

To overcome these many and varied obstacles there are multiple commodities that can be found. These are in the form

of keys, amulets, crosses which give you extra speed, extra time and the mysterious surprises. Also teleports and lifts are available to you as you journey through the ten planes.

In the first plane you control your little ball on five subplanes. These are more or less a training ground for you to get used to the style of play and the maneuverability of your metallic orb. These subplanes are very easy to negotiate as they tend to be extremely short and only really test your ability to cope with the

dexterity side of things.

Below I have included a basic description of the planes to give you an idea of the content and variation of the game.

Plane 1:

This plane contains five training sub-planes.

Subplane 1:

Follow the lane one square at a time, or you will be placed back at the starting square. Fall of the end into darkness to complete this subplane.

Subplane 2:

Follow the direction of the arrows and pick up the flashing white squares, consequently enter the hole of darkness to complete this subplane.

Subplane 3:

Avoid the electric sea and try to find the flashing squares that are scattered around. Again, find and enter the hole of darkness to complete the subplane.

Subplane 4:

Be quick and pick up squares. Yet again, enter the hole of darkness to complete the subplane.

At about this stage you are getting sick and tired of entering unfamiliar holes of darkness, not having any idea what is on the other side or whether or not it is safe, except on rumours from some tatty piece of software documentation.

Subplane 5:

Slalom around some pillars in the direction of the arrows in order to pick up the flashing squares that will activate the GOAL.

Plane 2:

Pick up the keys which will open the doors. Use the teleports but avoid the skulls to find GOAL. Watch out for invisible keys which only become visible when you move close to them.

Plane 3:

You will need to find four hidden amulets in this plane before the GOAL will even appear. Use the teleports to and avoid the electric seas.

Plane 4:

On plane 4 you can only move left or right - this creates a slalom racing effect. Race down the track as fast as possible avoiding blocks. Use the up and down lifts to your advantage as you only have a limited number of jumps available.

Plane 5:

Plain yellow squares will turn into patterned floor tiles and patterned floor tiles will turn into plain yellow squares when touched. Try to fill in the whole are with patterned floor tiles. Use the flashing squares to toggle the complete vertical line on or off. Black squares are safe. As you can see this type of arrangement makes the game have a Chinese puzzle type feel to it. This one is the most mentally demanding plane, which proved too much for me so I filed it away in to the "M" folder - for Maybe tomorrow.

Plane 6:

Extra "features" which are visible add extra jumps; other invisible "features" affect you or the play area, either positively or negatively. Progress through the level by determining these effects and using them to your advantage - and to make the GOAL appear.

Plane 7:

Once you have entered this plane, you have to complete it before going on to other planes. Pick up as many extra time units as possible to help you in your quest. This plane basically represents a bonus plane whereby you can pick up lots of extra time, the strategy is to choose the correct time to use this facility and not to waste this valuable piece of help.

Plane 8:

Pick up four keys in order to open one of two doors which lead to the GOAL. You'll need to be very quick as the floor disappears from beneath your very feet. This was another of my favourites - just as I had worked out a particular method of overcoming the problem at hand, the computer confronted me with a different pattern. This particular frame is a great challenge yet to be completed by myself.

Plane 9:

Pick up extra speed so that you can destroy all the cubes, however, this extra speed will not last forever and there is only a limited amount of extra speeds in the frame, so one must make haste. Avoid the flashing floor when it is illuminated.

Plane 10:

Jump from platform to platform. There are three different heights which can be recognised from the different shades of grey. You can only jump one step at a time without penalty. The GOAL is around - all you have to do is to find it. This is the most challenging of the frames as the multi-layered aspect of the plane makes it very hard to find the objective.

All the combinations of strategy, dexterity and a touch of luck in this software makes a very interesting game to play, as well as being a whole lot of entertainment bundled into a small packet. This game comes well recommended. The version I reviewed was on tape, presumably the package is available on disk.

Que-Dex was produced by Stavros Fasoulas. It is distributed by; Software Licensing and Marketing Pty. Ltd. 96-100 Tope Street South Melbourne.

(03) 699 6155

RRP d: \$32.95, c: \$27.95 ■

Micro Accessories of S.A.

ALWAYS A STEP AHEAD

What

FREEZE MACHINE

can do for you
NOW WITH "SINGLE PART SAVE"

- **Freeze . . .**
Totally unstoppable Freeze facility from the originators.
- **Fast Save . . .**
Saves in as little as 15 seconds. Nothing else can match this.
- **Multiple Save . . .**
Make as many saves as you want once frozen, in different styles if you wish.

- **Ultra Compact . . .**
The most efficient compacter? Our tests indicate this, as many as 5-6 games per disk.
- **Game Killer . . .**
Incorporates an effective routine to disable collision detection.
- **Independent . . .**
Even produces stand-alone Lazer files that reload in as little as 10 seconds.

- **Ease of use . . .**
Always a strong feature, now even more enhanced.
- **Multi-Load . . .**
Standard cartridge handles many games of this type. With the utility disk, even more!
- **Fast Format . . .**
Formats your disks in about 12 seconds.
- **File Copier . . .**
Built-in, fast-file copier will handle files up to 248 blocks long and is really easy to use.
- **Two Fastloads . . .**
A normal disk turbo at 5-7 times normal PLUS the

- astonishing Lazer at 20+ times normal . . . **BUILT IN.**
 - **Selectload . . .**
Just use cursors to scroll to the program you want to load and press a function key.
 - **Reset . . .**
Built in, so you can enter pokes for more lives etc.
 - **Tape Turbo . . .**
For quick save/reload on tape.
- NOW AVAILABLE \$108.90**



Quickdisc+

FAST LOAD PLUS UTILITY CARTRIDGE

After enjoying considerable success since its release we have now made some improvements to "QUICKDISC+" to maintain its position as the best value in the disk "speed up/utility" cartridges.

Fast LOAD (now 5-7 times normal speed). Works with majority of protected software. Can be switched in and out from the keyboard.

Fast SAVE at 7 times normal speed.

Fast Format takes just 20 seconds.

Fast Backup copies an entire disk in four minutes (not protected software).

Very Fast File Copier for selective file copying at HIGH speed. Now handles files up to 248 blocks long.

Improved DOS commands (DOS 5.1) makes for easy use of the disk drive e.g. **RETURN** will LOAD and display a directory without over-writing BASIC. **SHIFT RUN/STOP** will LOAD "0:" 8,1 etc. Very, very useful.

Incorporates **Centronics printer software** (user port) with **CBM graphics capability** (requires user port centronics cable). A **RESET** switch is fitted.

(We have found this to be "unstoppable", it even preserves the tape buffer).

NO MEMORY IS USED by this cartridge, it is totally "transparent" and uses special switching techniques.

"128" and 1570 compatible in '64 mode.
PLUS MANY MORE USEFUL FEATURES TO MAKE YOUR 1541 FAR MORE FRIENDLY TO OPERATE.

ONLY \$54.94
NOW EVEN FASTER



DOLPHIN DOS THE EFFECT IS STAGGERING.

Now established as **THE parallel operating system** for the 1541 disk drive. Hundreds of satisfied users include business, hobby and full-time programmers including the **Gremlin Graphics team**. The speed and efficiency is truly unbelievable, it is compatible with the **vast majority of commercial software**, speeding up both the loading of the program and of **SEQ/REL files**. (It is brilliant with Superbase, Easyscript, etc.) For non-compatible programs it can be **completely switched out**. It **DOES NOT** use a special disk format and your existing disks will be compatible.

FITTING

Fitting involves the insertion of two sub assembly circuit boards, one in the 1541 and one in the '64/'128. These normally just plug in, but on some '64s a small amount of soldering is necessary.

STOP PRESS

Dolphin DOS wins C.C.I. Oscar for best utility of 1986. First ever 100% hardware rating in Computet review. Many more software houses now using D. DOS include: Superior, Alligata, Adventure International, Thalamus and Domark.

- SOME OF THE FEATURES**
- ★ 25x FASTER LOADING (PRG FILES)
 - ★ 12x FASTER SAVING (PRG FILES)
 - ★ 10x FASTER LOADING (SEQ FILES)
 - ★ 8x FASTER SAVING (SEQ FILES)
 - ★ 3x FASTER LOAD/SAVE (REL FILES)
 - ★ E.G. LOAD 202 BLOCKS IN 5 SECS
- (These figures do not allow for searching)

ONLY \$169.00

Available for CBM 64 or '128 in '64 mode, please specify

EXTRAS AVAILABLE	
Kernal for '128 in '64 mode	\$40
User port expansion card (3 slot)	\$33
Dolphin Copy (Whole disk in 18 secs and lightning fast file copier)	\$33
Dolphin main board for second drive c/w lead	\$149

If you require further information please send SAE for fact sheet

Introducing the New FSD-2

Excelsior + Plus Commodore Compatible Disk Drive

Faster, quieter and more reliable than the 1541 and 1541C. Breakthrough Direct Drive technology. Guaranteed 100% Compatibility. It even enhances GEOS! Full One-Year Warranty.

NOW AVAILABLE \$364.95



DISK DISECTOR V5.0

Now the **FIFTH** generation of the country's leading disk back-up/utility package is available. This latest version includes **many more "PARAMETERS"** to handle the latest highly protected disks. This includes the latest **American and English software**. Be warned if you want to back up software by Ocean, Gremlin, Hewson, Domark and even U.S. Gold, whose protection schemes are **NOT** always the same as the American versions, then you **MUST** have "D.D.". At press date, we are **sure NO other advertised product will handle all these**, be it American or German.

INCLUDES THE FOLLOWING:
"EVESHAM 3 MINUTE NIBBLER" is the latest version of the infamous "Evesham Nibbler" now boasting **even more power and speed**.

Copies highly protected disks in **3-4 minutes**. Handles the **latest types of disk protection completely automatically**. This often involves the use of the "PARAMETERS", these add the vital secret code that the highly protected programs check for. (This is the important difference that makes this the best.) At the time of going to press this program copied **virtually all the English and American programs available for testing**, including the latest in games and business software.
"DUAL DRIVE NIBBLER" allows the use of two drives to make **even faster back ups**. Incorporates device number change software so no hardware mods necessary.
"EVESHAM 8 MINUTE NIBBLER" still very powerful and has been improved. Copies a few that the three minute version won't.

Many, many other useful utilities are included on the disk, including **SELECTIVE MENU MAKER, FAST FORMAT, FAST FILE COPY, NOVATRANS, DISK ORDERLY, DISCMON+, UNSCRATCH, ETC, ETC.**
The whole package is menu driven and has its own fast boot system built in for your convenience. Pays for itself the first day you receive it.

ONLY \$54.94

Customers with earlier versions may return them along with a payment of \$25.00 to receive V5.0. Most routines are CBM 128 and 1570/71 compatible in '64 mode.

Cockroach Graphics Utility - Cartridge and Disk ONLY \$75.90

Capture screens from games etc. Edit and modify captured screens.
Use graphics from Print Shop (2 or 3 block), Print Master and News Room (direct from Clip Art) in your own creations.
Make Print Shop (2 or 3 block) and Print Master graphics from any captured bitmap screen. Print out any captured screen (including sprites) on a variety of popular printers, including the OKIMATE 20 colour printer, 801/803, Epson, Star, BMC/Amust, etc.
Captured screens may be used in the powerful ROACH SHOW. This is the slide show which has extra fast loading without blanking the screen and has programmable display times.
Ideal for rolling demos or educational use.
Driver program to allow use of captured screens in your own programs.
Bit mapped screens are captured conveniently in KOALA or DOODLE format and may be edited with these programs, or via the Display Editor supplied on disk.
Conversion programs allow use of other drawing programs.
Sprites and character sets are saved separately.
Captured pictures may be saved in compressed form, for speed and efficient use of disk space, and also to establish a standard for use with the printer routines and the ROACH SHOW.

NOW AVAILABLE CARTRIDGE EXPANDER™ FOR C64™

QUESTION:
What is a Cartridge Expander?
ANSWER:
The Cartridge Expander extends the "GAME PORT" on the C64. Console by providing 3 additional cartridge "SLOTS" which will hold 3 of your favourite command modules.

QUESTION:
Can I use ATARI or VIC-20 Cartridges in the Cartridge Expander?
ANSWER:
NO. The C64 home computer will not operate with cartridges designed for other computers. The Cartridge Expander will not change the capabilities of the C64. You can operate any cartridge from the Cartridge Expander that runs in the console by itself.

QUESTION:
Why do I need a Cartridge Expander?
ANSWER:
The C64 home computer is made to operate only ONE cartridge at a time, however, there are several command modules that are more frequently used than others. Each time you "change" a cartridge, it causes wear on the connector within the computer, and eventually the connector simply wears out.
By using the CARTRIDGE EXPANDER, you can keep your favourite command modules plugged into the Cartridge Expander and select by using a switch rather than "unplugging" the cartridges.
The Cartridge Expander has a built in RESET button which can be used to reset the computer. Normally the computer is reset by turning the power off and on, or by plugging a new command module. The handy built in RESET button saves wear and tear on the console power switch.

ONLY \$69.00

ANTI-KNOCK DEVICE ONLY \$14.95

DOUBLE IMAGE V1.0.

The 1st of a Series of DISK based utilities designed specifically for the Australian market. Most imported products will not cope successfully with our locally produced games, so this is a must for backing up your disks.

MICRO ACCESSORIES OF S.A. UNIT 8, HEWITSON RD, ELIZABETH WEST SOUTH AUSTRALIA 5113 Phone (08) 287 0191
Made under licence to EVESHAM MICROS. Manufactured in South Australia
Offer subject to availability

Over 90 parameters of the most popular games available today. Compare this with the overseas disks.

1. Nibbler
2. 1.5 Minute Backup
3. Parameters
4. Disk Eraser
5. Compactor
6. Super Parameters

NOW COMPATIBLE WITH CBM 128, 128D
NOW AVAILABLE \$54.95

Send Cheque, Postal Order or Credit Card No. Credit Card orders accepted by phone. Callers welcome. Goods stocked. Trade enquiries welcome. Plus \$3.00 P&P
DEALER NETWORK AUSTRALIA-WIDE

Skate or die

Scribed by Adam Rigby

Grab your board, slip into your shades and get skat'n. Lester is in town and gonna teach yous a lesson.

PICTURE the editorial staff here at *Commodore Review*, eyes peering at phosphorous green PC screens, editing promising writers' work from all around Australia - a knock at the door breaks the silence.

"Courier for *Australian Commodore Review*."

Excited glances are exchanged across the room. After the initial disturbance, any thought of productivity for the rest of the day is abandoned.

Every action that now follows is a well-practised chain of execution. Andrew rummages through the filing cabinet until his gaze fixes upon the letter "J". He reaches down and retrieves a Wico joystick. Meanwhile, Vanessa (alias Madame Flutterby) finds a courier dispatch booklet and hurries to the door. As the courier mutters under his breath, I find myself booting up the Amiga and the C64 just to be sure we are ready.

Andrew and I struggled to rip open the courier box - soon joined by the cat, two dogs and the local scout group. The interesting point to note is that the cat, Tiger, is more vicious than even the scout group, and that includes the group

leader.

In the next few moments the room is silenced, eyes are opened wide - very wide. (A similar expression can be seen when you sit on something of whose origin or properties you are unaware, however one characteristic demands your attention - the fact that it is extremely sharp.) Andrew's shaking hand holds high a brilliant package that gleams in the sunlight - *Skate or Die*.

Reaching the game disk at the office is not easy. It involves negotiating Andrew Farrell's unique filing system. Anything from a receipt to a '76 Corona engine block has been seen

in the "R" folder. Not so long ago, Andrew disappeared for several days, we found him in the "Z" folder muttering strange words with an occasional reference to a Wumpus, and an uncontrollable spasm in his index finger.

Once the C64 was reached, joystick connected, phone taken off the hook and jug on the boil, we were ready.

Necks limbered, wrists readied and deep breaths taken as the 1541 whirred at its solemn pace.

The title page appeared and we were in awe, an absolutely wild sound track accompanied the graphic of the skateboarder, the finest you'll see and hear on the 64. Patience followed as the game loaded . . .

We prepared ourselves for the wait but to our pleasant surprise the game loaded reasonably quickly and we were

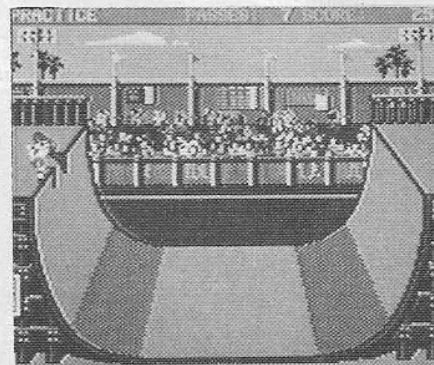

face to face with one very ugly dude indeed, similar to Jabba the Hut with a purple mohawk. This charmer runs the skate shop from which you either register to compete or "go practice". A variety of other tit-bits can be done at the skate shop such as viewing High Scores and changing your Skatey colour.

Once a mode is selected you are presented with a bird's eye view of the skate shop and surrounding streets - all of which lead to different fields of competition. All you do is skate over to the different areas of the screen and the drive whirs and presto, you're there.

The different fields of competition include the pool joust, downhill race, downhill jam, freestyle and the highjump. All of which are quite different in their game play and difficulty.

The pool joust

A chance at some mindless violence, not the alien blasting or scream of metal contorting in an onslaught of missiles, but just an opportunity to belt your "mate" with a boffing stick. A little bizarre, you declare, not if you're a skatey fiend.

Skating round an empty pool trying to biff a fellow skater is reminiscent of so many other sunny days when you did
(continued on page 25)

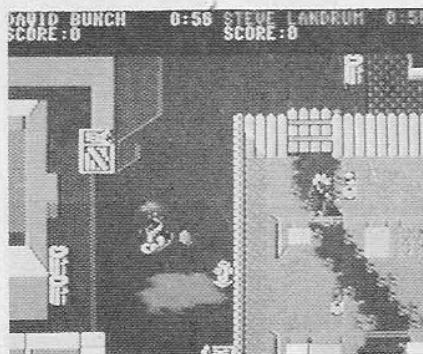

Australian

\$1.50*

Amiga Review

*T-bag disk
collection*

Using the RAM

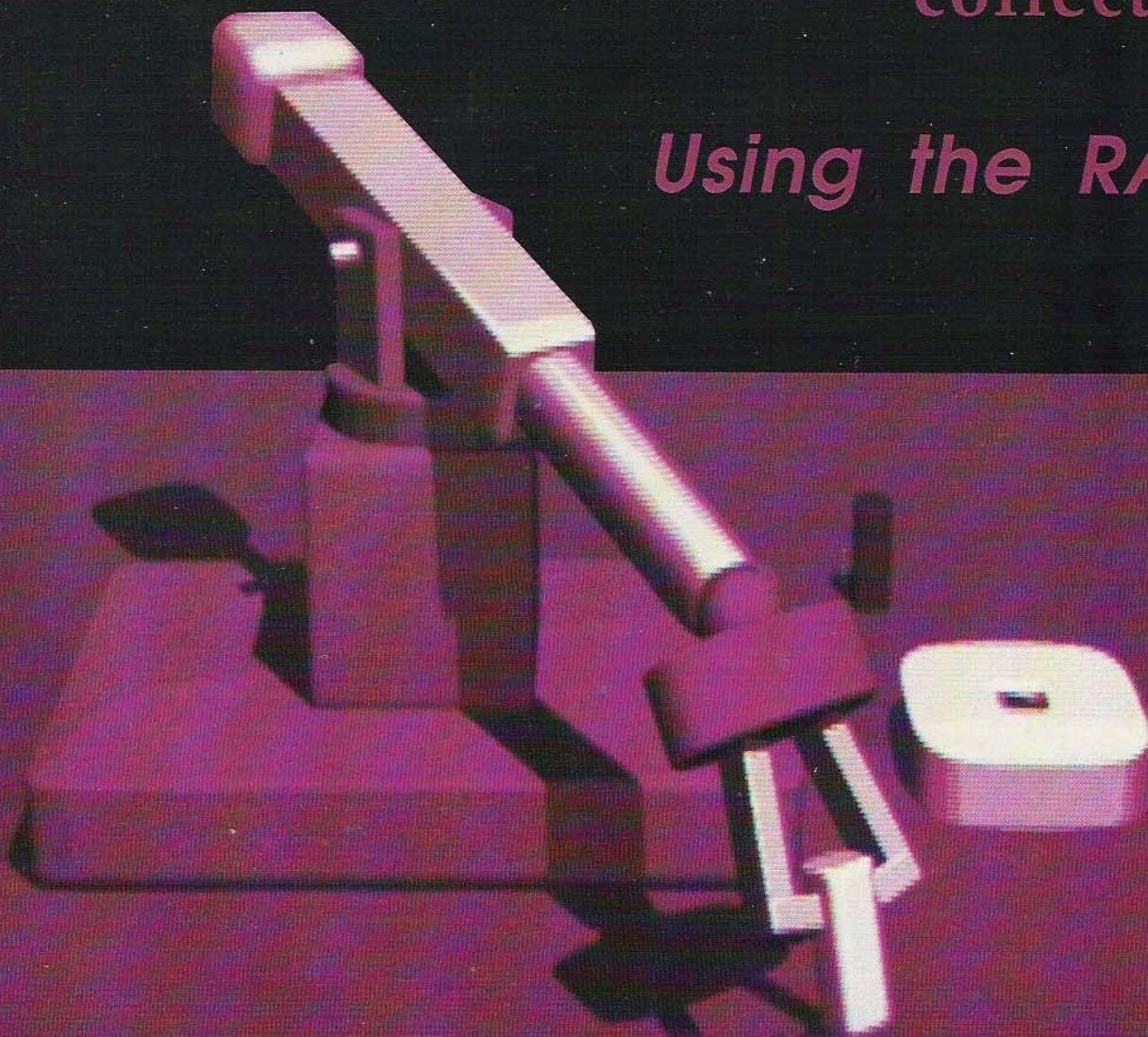

Why I bought an Amiga 2000

Vol 2 No 1

Inserted In The Australian Commodore and Amiga Review

TERRORPODS

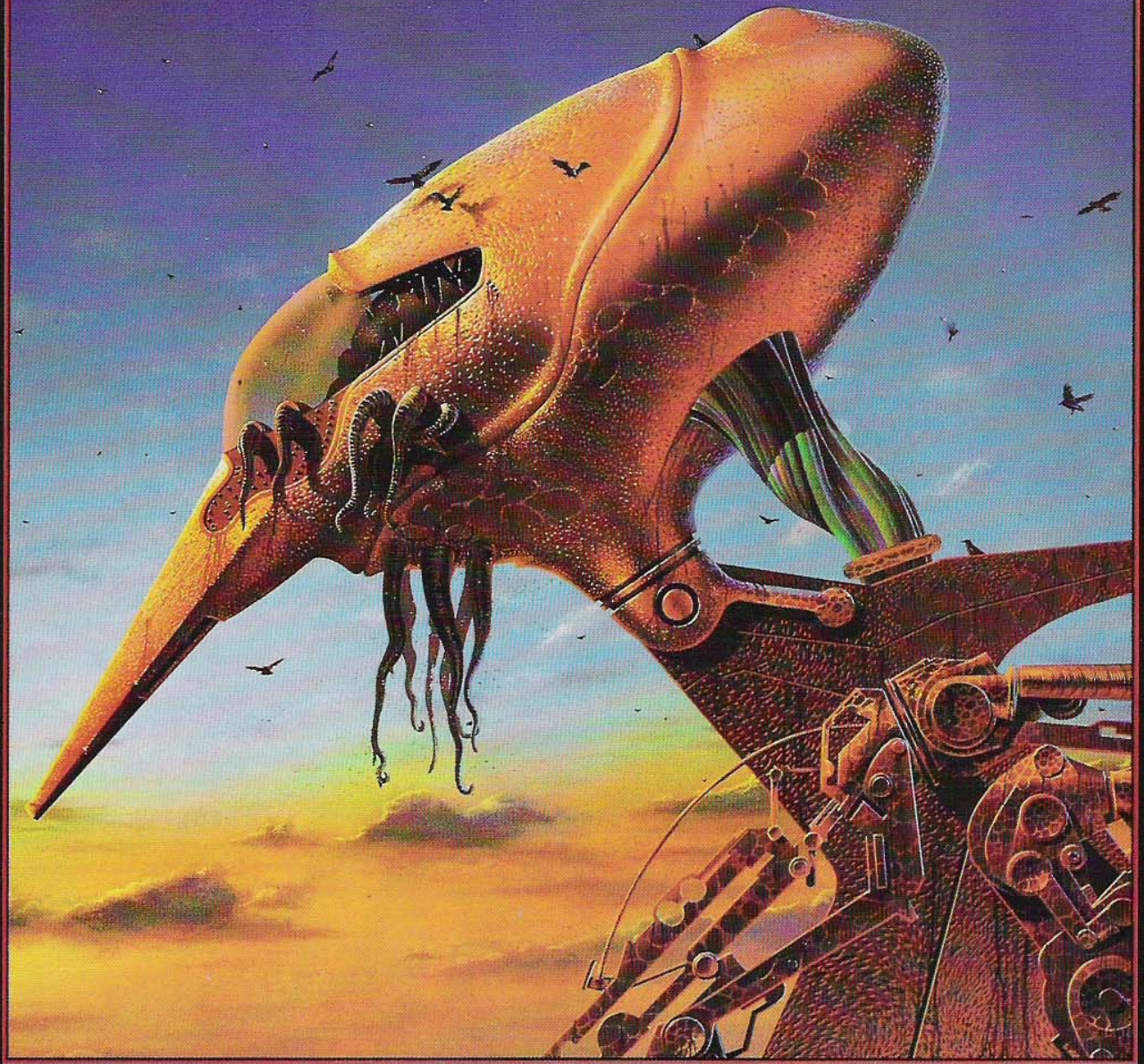

by

TRAKNOSTA

Distributed in Australia by Ozi Soft (02) 211-1266

MicroComputer Spot

Phone: 417 7395. Front 13 Gibbes Street, East Chatswood, NSW 2067

MAIL ORDER

Romper Room Alphabet (ED) Cass \$29.95 Disk \$29.95	Snow Queen (AD) Cass \$29.95	Swift Calc 128 (H) Disk \$99.95	Very First 128 (H) Disk \$29.95
Romper Room Numbers (ED) Cass \$29.95 Disk \$29.95	Sold Million 1 (AA) Cass \$39.95	Taipan (S) Disk \$39.95	Video Title Shop (H) Disk \$49.95
Rupert the Bear (ED) Cass \$19.95	Sold Million 2 (AA) Cass \$39.95 Disk \$49.95	Take 4 (AA) Cass \$19.95	Visa Star 128 (H) Disk \$199.95
Russion (ST) Disk \$54.95	Sold Million 3 (AA) Disk \$49.95	Tank (ST) Cass \$29.95 Disk \$39.95	Visa Writ 128 (H) Disk \$149.95
Sacred Warrior (AA) Cass \$29.95	Soldier One (AA) Cass \$34.95	Taipan (S) Cass \$29.95	Vorpall (U) Disk \$69.95
Sacred Armour (AA) Disk \$34.95	Solo Flight (SI) Disk \$44.95	Tarzan (AA) Cass \$34.95 Disk \$44.95	Word Class (Header Board) Cass \$34.95
Samantha Fox (ST) Disk \$54.95	Space Harrier (AA) Cass \$29.95 Disk \$39.95	Task Force (ST) Cass \$29.95 Disk \$39.95	War (ST) Cass \$34.95
Samurai (S) Cass \$34.95 Disk \$44.95	Spin Dizzy (AA) Cass \$24.95 Disk \$34.95	Tass Times (AD) Disk \$44.95	Warrior (AA) Disk \$39.95
Saracen (AA) Disk \$39.95	Sport 4 (S) Cass \$34.95	Tau Ceti (ST) Cass \$39.95 Disk \$39.95	Warrior 2 (AA) Cass \$29.95
Sarcel (AA) Disk \$34.95	Spy vs Spy 3 (ST) Cass \$29.95 Disk \$39.95	Teddy Bear (ED) Disk \$64.95	Warship (ST) Disk \$44.95
Scooby Doo (ED) Disk \$34.95	Squash (S) Cass \$29.95	Temple T. (AA) Cass \$29.95 Disk \$34.95	Way of the Tiger (ST) Cass \$39.95 Disk \$59.95
Scrabble (ST) Cass \$34.95 Disk \$39.95	Star Glider (SI) Disk \$69.95	Tempo Typing (H) Cass \$39.95 Disk \$39.95	William (AA) Cass \$24.95
Screen (U) Disk \$49.95	Star Paws (AA) Cass \$29.95 Disk \$39.95	Ten Little (AA) Disk \$29.95	Windham (AA) Disk \$49.95
Screen Play (AA) Disk \$29.95	Star Cross (AD) Disk \$29.95	Terror (AA) Cass \$29.95	Winnie the Pooh (ED) Disk \$39.95
Sentinal (ST) Cass \$34.95 Disk \$49.95	Star Glider (SI) Disk \$69.95	Thai Boxing 128 (S) Disk \$39.95	Winter Games (S) Cass \$34.95 Disk \$39.95
Shadow of Mordor (AD) Disk \$39.95	Starion (AA) Cass \$24.95	Thai Boxing (S) Disk \$29.95	Wiz Ball (AA) Cass \$29.95 Disk \$34.95
Shadows (AD) Cass \$29.95	Star Quake (AA) Cass \$34.95	The Dungeon (AD) Disk \$49.95	Wonder Boy (AA) Cass \$34.95 Disk \$39.95
Shanghai (ST) Cass \$39.95	Star Raiders II (AA) Cass \$29.95 Disk \$39.95	Thing II (AA) Disk \$39.95	Word Writer (H) Disk \$99.95
Shao Lin Cass \$29.95	Starter Pack (ED) Disk \$99.95	Tigers in the Snow (ST) Cass \$29.95	World Games (S) Disk \$39.95 Cass \$34.95
Shao Lin Disk \$39.95	Stickers (H) Disk \$49.95	Time Trek (ST) Cass \$39.95	Writer Pack (H) Disk \$149.95
Shards (AA) Disk \$44.95	Stiff Lip (AA) Cass \$34.95 Disk \$39.95	Titanic (ST) Disk \$39.95	Writers (H) Disk \$99.95
Shock Way (AA) Cass \$29.95 Disk \$34.95	Strike Force (AA) Cass \$39.95 Disk \$59.95	Top Gun (AA) Cass \$29.95	Xeno (ST) Cass \$34.95
Short Circuit (AA) Cass \$29.95 Disk \$34.95	Strip Poker (ST) Disk \$39.95	Tournament (S) Cass \$39.95 Disk \$39.95	Xevious (ST) Cass \$39.95
Sigma 7 (SI) Cass \$34.95 Disk \$34.95	Strip Poker Data (ST) Disk \$24.95	Trail Blazer (AA) Cass \$34.95 Disk \$49.95	Yie Ar Kung Foo (S) Cass \$29.95
Silent Service (SI) Cass \$39.95 Disk \$49.95	Sub Battle (SI) Disk \$39.95	Trap (AD) Cass \$39.95	Zoids (AA) Disk \$39.95
Simons Basic (U) Cass \$29.95	Summer Games II (S) Cass \$24.95 Disk \$39.95	Trivial (ST) Disk \$39.95	Zork 2 (AD) Disk \$29.95
Six Star (AA) Cass \$29.95	Sun Star (AA) Cass \$29.95	Typing Tutor III (H) Disk \$49.95	Zork 3 (AD) Disk \$29.95
Ski Writ (U) Disk \$29.95	Super Base 128 (H) Disk \$149.95	Typing Tutor (H) Cass \$15.95	Zynaps (AA) Cass \$29.95
Skyfox (AA) Cass \$29.95 Disk \$54.95	Super Base (H) Disk \$120.00	Ultima I (ST) Disk \$39.95	Zynaps (AA) Disk \$39.95
Skyrunner (AA) Cass \$34.95	Super Script 128 (H) Disk \$149.95	Ultima III (ST) Disk \$69.95	Zzap 1 (AA) Disk \$49.95
Slap Fight (S) Cass \$29.95	Super Script (H) Disk \$99.95	Ultima 4 (ST) Disk \$99.95	Zzap 2 (AA) Cass \$34.95
	Super Swift 128 (H) Disk \$99.95	Up Periscope (SI) Disk \$59.95	Zzap 2 (AA) Disk \$49.95

MAIL ORDER FORM

PHONE FOR LATEST NEW RELEASES

PRODUCT/PROGRAM NAME	COMPUTER	CASSETTE/DISK	QUANTITY	PRICE

For Software only, add \$2.00 for post or \$5.00 for courier. For hardware, call to arrange.

Send to: Microcomputer Spot
13 Gibbes Street, Chatswood, NSW 2067

We will exercise all reasonable care in the processing of your orders but we accept no responsibility for orders, monies or products lost or delayed in transit. Your order will normally be processed within 48 hours, but please allow 14 working days for the fulfilment of orders. Telephone orders are, of course, welcome, but unfortunately, COD terms are not available. Wherever possible, please supply a phone number where contact can be made within normal working hours. **PRICES ARE SUBJECT TO CHANGE WITHOUT NOTICE. DO NOT SEND CASH.**

Method of payment, tick for Cheque Postal Order
Tick for Bankcard Mastercard Visa AGC

Credit Card No. | | | | | | | | | | | | | | | | | | | | | |

Valid from Until end

Name as per card

TOTAL \$ _____
POSTAL CHARGE \$ _____
GRAND TOTAL \$ _____

For delivery:

Name

Address

Postcode

Telephone () Date Sent

Signature of cardholder



Editorial

I RECENTLY had the opportunity to view the Newtek Reel One demo disks. Three products were demonstrated. *Digiview*, *Digipaint* and a new release, *DigiFX*. Together, they go to make one of the least expensive yet most impressive presentation software suites available.

Video production companies are ecstatic. Take a look at it yourself if you get a chance. You will need a full megabyte of RAM, but rumours are that the Amiga 500 will have that as standard before too long.

Also on the short list of hot new hardware is the Amiga 3000 complete with 68030 microprocessor, the Amiga 2100 with the 68020 microprocessor, both announced at the recent Comdex show.

Workbench version 1.3 must be close, as US reviewers are making mention of the product in software reviews. Word has it that some software will still require version 1.1, or 1.2. As time goes by, we will all end up with a huge collection of system disks, and endless compatibility problems. All in the name of progress.

Andrew Farrell

Australian Amiga Review
21 Darley Road,
Randwick, NSW 2031
(02) 398 5111
Published by:
Saturday Magazine Pty Ltd.
Editor: Andrew Farrell
Publisher: Gareth Powell
Advertising: Ken Longshaw
(02) 398 5111 or (02) 817 2509
Production: Brenda Powell

Layout: Amanda Selden
Subscriptions & Back Issues:
Tristan Mason (02) 398 5111
Distribution:
Selected dealers
and as part of *Australian Commodore Review*
Printed By:
Ian Liddell Pty Ltd

Directory of Advertisers

IBC Able

10, 11 Commodore Business Machines

1 Computermate

OBC Computerscope

12, 13 Diskworks

6, 7, 8, Micro Computerspot

5 Proton

IFC Sector Software

4 Solid Software

2 Wilcom

Contents

- 2 Why I bought an Amiga 2000**
The reasons why, and the results after buying an Amiga 2000.
- 3 Using the RAM**
How to use and when to opt for extra memory in your Amiga.
- 4 Cruncher Factory**
Based on the old favourite Pac Man you wont be able to get to bed when playing this new game from Kingsoft.
- 14 New Products**
Report from COMDEX/November 87 Las Vegas
- 15 T-Bag disk collection**
Games, graphics, utilities and demo programs on a disk magazine.
- 16 What to add to your Amiga**
What is available for the Amiga at a reasonable price.

 **COMPUTERMATE**
WE'VE GOT THE MOVERS

**SOFTWARE &
ACCESSORIES FOR**

 **commodore 64/128**

 **AMIGA**  **ATARIST**

 **IBM[®]**

 **star**

We also distribute a full range of paper, ribbons, blank disks, joysticks, covers, printer stands, disk boxes, cables and air freighted copies of overseas magazines.

**DEALER ENQUIRIES ONLY TO
PH: 02-457-8118 FAX: 02-457-8739**

Why I bought an Amiga 2000

by Perry Gretton, Perisys Pty Ltd

I was one of the early buyers of the Amiga 1000, after setting my heart on one from the first report I read while it was still in the early days of development. I wasn't disappointed.

Within a couple of months I bought a Sidecar to give myself an IBM PC/XT at what I regarded as a reasonable cost. By adding an extra 256k and a 20 MB hardcard, partitioning it 15MB and 5Mb in the Amiga's favour, I ended up with a pretty useful system.

When the A2000 was announced I wasn't too concerned. It didn't seem to offer much more than what I already had, and it certainly wasn't cheap. However, when I began running out of memory and started to look at the options available, the A2000 became a serious contender.

In the end, I chose to replace the A1000/Sidecar combination with the A2000. Here are some of the reasons for doing so, and some of the problems I encountered along the way.

Costs

Let's begin by looking at the comparative costs. These are best explained by the table below (prices generally on offer as at October 1987):

As you can see the difference amounts to \$945. Put another way, the A2000 costs about 25% more than the A1000/Sidecar.

So what do you get for spending almost another thousand dollars?

The most obvious benefit to me is the extra 512K of memory which comes as standard on the A2000.

The battery-backed clock/calendar is also something I find particularly helpful, especially when developing programs and then forgetting which version I modified last.

Of course, the A2000 has a smaller footprint than the A1000/Sidecar combination, allowing me to reclaim some desk space. The A2000 also has a better keyboard. I never did like the one on the A1000. It was too small and didn't feel like most keyboards I'm used to. When I got the Sidecar, it became even more onerous to use, as the IBM keys were superimposed on the numeric keypad. You need to have a good memory for these if you're not used to an IBM PC.

Internal expansion

A less obvious benefit of the A2000, but what I regard as the real benefit in the long term, is the provision for internal expansion.

When I looked at ways of expanding the A1000, I asked around to find out how other people had got on.

It seemed there were problems with the Sidecar being on the expansion bus as quite a few memory expansion units do not provide a pass-through for the Sidecar. The internal expansion units weren't easy to install, sometimes requiring hardwiring to the motherboard, or didn't work with the Sidecar.

I felt that if I chose to go this way, I would be embarking on a long series of abortive missions if other people's experiences were any guide.

There are five Amiga expansion slots in the A2000, and four PC/AT (or XT) slots. I bought the A 2088 Bridgeboard and had it installed in one of the PC/XT slots.

Because of the way the slots are arranged, the Bridgeboard takes up an Amiga slot as well, so that I have four Amiga and two PC slots left (I could have chosen three slots each for the Amiga and the PC, but I'm expecting to make more use of the Amiga slots). I

dropped my hardcard into the PC slots and now have only Amiga expansion slots available.

There is also a CPU slot, should you wish to let another processor (e.g. 68020/68881) take over your machine.

It is when you consider the opportunities these extra slots provide that you realise the real benefit of the A2000. To try to achieve the same effect with the A1000 would lead to a proliferation of cables and boxes of all shapes and sizes, assuming that the A1000 is capable of supporting it all anyway.

Lest you think that it's roses all the way, there are some disadvantages with the A2000.

For example, Kickstart 1.2 is in ROM, making it easier and faster to boot the system. However, if you have software that runs under Workbench 1.1 (and, therefore, Kickstart 1.1), you won't be able to use it. One example is *Music Studio*. I'm told by the supplier that Activision is working on a version which will get round this problem, and this should be ready some time in December.

The keyboard on the A2000 doesn't slide under the system unit like the A1000's use to; so some of the desk space I saved has gone again.

Bridgeboard

The Bridgeboard doesn't come with a speaker. I'm having one installed, as I find it difficult to work without being beeped at when I make a mistake.

Talking of the Bridgeboard, it's widely known within the Amiga community that these units aren't too reliable. When I had mine installed, we got through four before it was realised the power supply on the A2000 had blown. Thereafter, the board worked quite well, but was eventually replaced after being tested for a different problem. During

the testing, the power supply blew again.

Apparently, early model A2000s have a power supply problem (a friend of mine had two replaced before he even left the shop after buying his A2000).

Another problem for which there is as yet no solution is a defective left sound channel. If certain frequencies are played, especially in harmony, there is a noticeable distortion on the left channel. Although only two components are involved, replacing either makes no difference. The fault could be software, as some programs play music without any apparent distortion.

An additional problem occurs with extra memory, although this can happen with the A1000 too. Some programs don't follow Amiga conventions for using chip and fast memories. Therefore, you have to select NoFastMem from the Workbench to disable the extra 512K of memory. Unfortunately, this doesn't toggle, and you have to reboot Workbench to get the memory back again.

All in all, I'm pleased with the A2000. It's a machine with tremendous potential, and I'm looking forward to the the add-ons that I'm certain will be coming onto the market in the next year or so. □

	A1000/Sidecar	A2000
System Unit only	\$1350	\$2995
A1081 Monitor	\$ 599	\$ 599
Sidecar (expanded to 512K)	\$1800 (approx)	
Bridgeboard (512K)		\$1100
Total	\$3749	\$4694

COMMODORE CHIPS AT VERY LOW PRICES

Our Chips are factory fresh, prime.
6526 - \$15.90, #6510 - \$17.60,
#6581 - \$20.30, #6569 - \$34.60,
#901225 - \$9.80, #901226 - \$16.40,
#901227 - \$16.10, #901229 - \$15.80,
#8721 - \$19.90, #8722 - \$15.75,
and many more.
Bulk order discount available

THE COMMODORE DIAGNOSTICIAN

A two sided laminated symptomatic chart for diagnosing faulty IC components on Commodore 64 and peripherals etc. An invaluable tool for those who want to do their own repairs, save money and down time. This diagnostic tool has just arrived from the USA where it has proved most effective. Price \$6.95 or free with any chip order of \$50 up.

WILCOM AUSTRALIA

PO Box 48 KYNETON, VIC 3444.

Telephone (054) 223329

PRICES SUBJECT TO CHANGE

Ewesing the RAM

by Tim Strachan



THE Amiga craves extra RAM (random access memory) and the original 1000's were released in the US with 256Kb and with 512 Kb here - this was like selling a car with two wheels and no juice. The 500 can be immediately upgraded internally to 1Mb while the 2000 comes with that standard.

However, it's soon obvious that that quantity can be added to with serious benefits and anyone who's greedy, or doing graphic intensive work like animations or desktop publishing, or simply wants to make the most of multi-tasking, will soon be looking for 2Mb. It's also very good for using a "Recoverable RAM disk" as I'll describe below.

The points made in this article however can be applied to those with 512Kb RAM with good effect, especially those with a single disk drive.

The 68000 CPU can address about 16 Mb of RAM, though Commodore has seen fit to reserve a large chunk of that for their own purposes.

Some people may not know that the very existence of a RAM disks provided for in the Amiga's Operating System is unusual among micro-computers - a normal IBM doesn't have one without buying special hardware and software, and nor do the Mac or the Atari.

You won't be aware of the RAM disk until you "mention" it, for example by entering `> dir ram:` in the CLI. Now if you check the Workbench screen you'll see a disk icon saying "RAM", which behaves just like a normal disk: you can open its window, copy things to it by dragging them from other disks, run programs that you put in there from the CLI or Workbench, and so forth. The RAM disk icon will stay around until you switch your computer off and on again.

Some general points about using RAM:

One quite simple way of using it is to simply copy a program into RAM and run it from there. You'll find a definite increase in speed and performance with most programs this way - *Pagesetter*, for

example moves a lot faster in refreshing the display, and if you also save your work to RAM there will be a greater speed-up (though be careful of Gurus when doing this, since RAM is volatile and disappears if you have to re-boot - the Recoverable Ram Disk solves this problem, as discussed below).

Going a bit further, you can copy various things into Ram from your start-up sequence: change it using a Text editor such as ED in the CLI. Now when you boot up you'll automatically have specific things copied to Ram.

One very useful thing to do is to copy your most used CLI commands over and then make the computer access them without looking on your Workbench disk. In other words, your can free up a disk drive. For example . . .

```
> makedir ram:c
> cd sys:c
> copy (dir:cd:copy:type) ram:c
> path ram:c add
```

The last command (path) is useful for telling the system to also look in the place you specify for its commands. You could have copied the whole C directory to RAM by entering

```
> copy to ram:c
which copies everything in the C directory to ram:c. And instead of using the Path command you could assign the C directory of the system to ram:c i.e.
> assign c: ram:c
```

Incidentally the more you load into RAM, the longer it takes - it's worth being selective.

A further benefit of expanded RAM is that you can have large amounts of data in memory, so you can play around with a huge spreadsheet, or pageset a very large document, or load a big animation into RAM and play without disk access. Likewise you can have a number of large programs running simultaneously and really get something out of multi-tasking.

Recoverable Ram Disk

One of the most useful utilities

around in the Recoverable Ram Disk by ASDG in the US. This is available on Fish Disk 58 and is Shareware (ie, you're morally obliged to send them a small donation if you use it regularly).

By adding "asdg.vdisk.device" to your devs directory along with a "Mountlist" as specified in the documents which accompany it, and by changing your startup-sequence as described you can copy anything into "VDO:" (virtual device, meaning it acts just like a real disk device).

With enough Ram you can copy your entire Workbench disk in and then remove your actual disk from the drive and use VDO: as a super-speedy system disk.

The difference between this and just copying things into Ram is that if you have a dreaded Guru you don't have to have cardiac fibrillations because when you re-boot you'll find everything there just as you left it.

I use the RRD for every session except a quick 10 minute session. It does take its time to load at the beginning but if you're going to be at the computer for a while it's certainly worth it, and of course you've got an extra drive to play with. The Starboard 2 by Microbotics has a similar utility as

part of their optional Multifunction Module.

Graphics

One problem you may find with FAST Ram (which is what all expansion Ram is, as distinct from the 512Kb of CHIP Ram which comes with your machine) is that some programmers mistakenly included graphics data in their software without specifying that this should be loaded into CHIP Ram. AmigaDOS tries to load everything into Fast Ram where the Custom chips cannot get at it. *Deluxe Paint* had this problem.

The solution is to run the Public Domain program FIXHUNK on the wayward program - this forces any "data hunks" to be loaded into Chip Ram.

So do yourself a favour, save up your dollars and buy one of the many expansion bards now available - you'll find reviews of some in previous issues of this magazine, and also in issues of MEGADISC. Likewise to get your hands on the Public Domain programs mentioned here, get onto a good Bulletin Board or ask your local User Group or order them from Megadisc - see the ad in this issue. □

AMIGA OWNERS

External disk drives. Top quality unit with 12 months' warranty. Wrap-around Marviplate case with no external screws. Round cable NOT flat ribbon cable. \$349.

General computer accessories - blank disks, storage boxes, mouse mats, ribbons, paper, quality joysticks, Amiga magazines, etc.

White's Computers
(02) 634 6636 anytime

37 Daphne Ave, Castle Hill, NSW 2154

Cruncher Factory

by Eric Holroyd

Since getting the Amiga 1000 three or four months ago I've been meaning to get down to some serious computing and learn more about the CLI, AmigaDOS, spreadsheets and other highly-important stuff, but every time I decide to be serious, along comes another great game which grabs my attention and keeps me busy just enjoying myself.

Such a game is *Cruncher Factory* from Kingsoft.

One of this game's authors is M. Aberle who's already given us that terrific *Demolition* on the Amiga (and that one really grabbed me!) and who I'm sure we're going to hear a lot more from on the games scene.

I've heard a rumour that Kingsoft is about to launch *Boulderdash* for the Amiga too, so those of you (like me) who were addicted to that one on the C64 can look for-

ward to renewing the quest for diamonds.

Ghosts

Cruncher Factory is obviously based on the old favourite, *Pac Man*, whereby you're rushing around a maze gathering up dots, eating powerpills and avoiding ghosts.

These latter, true to the genre, will kill you on contact but if you've had the aforesaid powerpill you can kill them for as long as the magic stays with, which is unfortunately all too short a time. You'll have some special music playing when you've taken the pill to signify that you now have the power to kill the ghosts.

As you're doing it though, watch out for them starting to flash as it signals that things are about to return to normal and

they'll then be able to kill you again. If you try for "just one more ghost" when they're about to revert to normal you're liable to get zapped for being greedy. It happens to me all the time...

There's some nice music playing during loading and title screen display, this is digitized and shows off the Amiga's remarkable sound capabilities again.

On the opening screen you're given the option to Enter the Game and Choose Level. Move the joystick side-to-side and the Enter Game wording changes to Level Editor, Scoretable or Highscores and select by pressing the firebutton.

Scoretable shows how points are scored, High Scores shows who's achieved what and Level Editor allows you to design your own screens if you've conquered the existing ninety-nine (yes, 99!).

I've currently got up to screen 19 with a score of 50360 and I've already found that, whilst the ghosts don't appear to have much intelligence to harass you on the earlier screens, they do learn pretty quickly and by the time you get to screen 14 they're hanging round you like a bad smell and take a fair bit of eluding.

Choose the Level you wish to start on by moving the joystick forward and back and once again select with the firebutton to take you into that level.

Cruncher Factory lets you play as a Solo Player, a Two Player team, or in a Two Player Competition. I haven't played it yet in competition mode but I can imagine that it would be an awful lot of fun ganging up on the little beasts.

General game play is good, as each screen is different to the last one, as opposed to *Pac Man* where you learned just one maze

then worked out your playing strategy to suit. You now have 99 mazes to learn, and there are some beauties!

As well as having excruciating mazes there are other traps which you'll come across. Ran-

dom blocks will suddenly appear and prevent you going where you'd just decided to go. The block stays for a while then disappears again, but not before it's destroyed your presence of mind and your carefully worked out strategy because you have to rethink and go another way, that's if you have the time...

Mazes

Some mazes are complete with flashing exits where you may slip out of one side and re-enter at the other side to do the most damage before slipping out again. In mazes with multiple exits though you never quite know where you're likely to come out and you might just meet the nasties as you emerge. Zapped again! Great stuff, and guaranteed to make you say "just one more time, then I'll go to bed".

On some screens you'll encounter invisible walls (try screen 14 for this) which just won't let you through. You'll have to learn where they are in order to get around to complete the screen and it's quite a job. Fortunately the game allows you to start at any level you select, so if you need to practice on a particular screen you may do just that.

Each screen has a display up at the top showing the current score, how many lives remaining, and the current level number. Every 5000 points you get an extra life and those 300 points for every piece of fruit certainly help to rack up the points. The fruit is only on show for a short time however, and always just where the ghosts are hanging around so in trying to

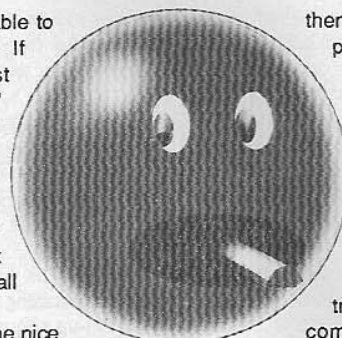

Solid Software's
LOTTOcheck

19 15 37

for the Commodore 64 & 128 Computers.
LOTTOCHECK is now available in 2 versions:

- TATTSLOTTO (45 numbers, AUSTRALIA),
- GO LOTTO (40 numbers, NSW),

Make your own luck! Numbers that have won 5, even 10 times more prizes than the statistical average, can easily be found with Lottocheck.

- With the PRIZE option you select a set of numbers or a System entry and Lottocheck goes through all past draws tallying up all prizes in each division, that would have been won with those numbers.
- You can select random numbers, which appear on screen as bouncing coloured balls.
- The GRAPH option produces a histogram of the frequencies of numbers drawn, up to the present.
- The powerful EVALUATE option lets you test theories and predict next weeks draw, using computed rankings of all numbers.
- Other options include list and print together with the usual database functions ADD, INSERT, MODIFY and DELETE which use professional fullscreen, form-like input screens, allowing you to update the database.
- Package includes program and data disks plus extensive handbook on Lottocheck, winning strategies, and the maths theory of LOTTO.

Comments from purchasers of Lottocheck:

'I think you have an excellent program in LOTTOCHECK.' J. Remess, Sandy Bay, TAS.

'It is very encouraging to see an Australian company taking such pride in their product.' Peter Nicholas Pharmacy, Hermit Park, QLD.

'The manual is excellent.' C. McCarty, Braddon, ACT.

Excellent value at \$59.00 each version (this includes postage, s.tax), payable by cheque, money order, Visa card, Mastercard or Bankcard.

I want to pay by _____

I want the _____ version (Aust. Lotto Block 6-45 or NSW 6-40).

Card No: _____ Expiry date: _____

Signature: _____ Date: _____

Name: _____ Address: _____



Solid Software,
P.O. Box 218,
Belgrave, Vic. 3160



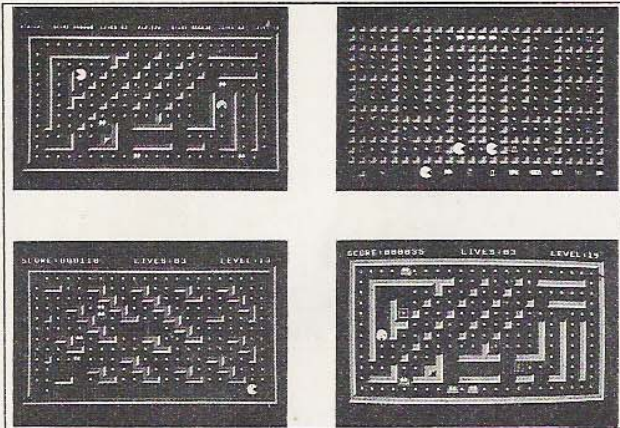

score points to get an extra life you may just lose the life you're trying to hang on to.

Keys

There are a few things you can do with some of the keyboard keys to make life easier or more interesting. The "block" which I mentioned earlier which impedes your passage can be removed by pressing the backspace key, and if you get tired or the phone rings the Spacebar will pause the game. The Escape key lets you quit a game altogether.

There are various combinations of keys which you're invited to try out for yourself and these include: the two red Amiga keys, the

numeric keypad's decimal point, Alt/Help and Ctrl/Alt. All kinds of interesting things happen including the Muncher himself becoming an Amiga ball and the Ghosts turning into Atari symbols! Try them all out for yourself, you'll be pleased with the results.

Whether you're a *Pac Man* freak or just like fast arcade games I'm sure you'll enjoy this one, it's a real joystick tester, very reasonably priced, and well worth adding to your games library.

Cruncher Factory is distributed in Australia by Questor (02) 697 8666 and its recommended retail price is \$28.40. Ask for it at your favourite supplier. □



MICRO ELECTRONICS PTY LTD (INC IN S.A.)

AMIGA 500

MEMORY EXPANSION

- * 512K
- * 1 MEG
- * 2MEG
- * Optional Real Time Clock
- * No Wait State
- * CMOS IC's
- * Low Profile
- * Attractive Colour (Matched to Amiga)
- * Easy Installation
- * Compatible with Recoverable Ram Disks
- * No External Wires or Connections

This unit provides Amiga 500 users with up to 2 Meg of Expansion Memory with no wait states. This means that it is as fast as the machine or faster. The clock provides an option for users without the internal ram to have a battery backed real time clock. The CMOS integrated circuits have low power requirements but maintain the speed of the Amiga. This means that the 500 user is provided with a fast memory expansion that is capable of being powered from the 500.

Installation is made very easy. All you need is a screwdriver to remove the side cover and insert the memory board. The finish on the unit is very attractive due to the low profile case and the colour matched chip resistant powder coating.



AMIGA 500

MEMORY EXPANSION

- ✓ 512K
- ✓ 1 MEG
- ✓ 2 MEG
- ✓ REAL TIME CLOCK
- ✓ UPGRADES

AMIGA 1000

MEMORY EXPANSION

- ✓ 512K
- ✓ 1 MEG
- ✓ 2 MEG
- ✓ REAL TIME CLOCK
- ✓ UPGRADES

AMIGA EXTE

3.5" EXTERNAL DISK DRIVE

- ✓ SINGLE
- ✓ DUAL
- ✓ TRIPLE

AMIGA

5.25" EXTERNAL DISK DRIVE

- ✓ SINGLE

ENQUIRIES TO YOUR NEAREST DEALER OR
1 POPE STREET, BEVERLEY S.A. 5009 Ph: (08) 347 2072

SAVE \$100
AMIGA 500
\$899.00

MicroComputer Spot

Phone: 417 7395. Front 13 Gibbes Street, East Chatswood, NSW 2067

C LIMITED
 22 and 33 Meg.
 Hard Disk for the
 Amiga
 from **\$1995**

commodore
PC SUPER SPECIALS
PC5 \$999
 includes Monitor and Able-1 software
PC10 \$1299
 2 x 360K D/D
PC20 \$1699
 20 Hard drive includes MS Dos 3.2 + GW Basic

FREE MONITOR WITH EVERY PC

MAIL ORDER
EPSON PRINTERS
 12 months warranty!

LX 800, with tractor	\$499.00
EX 800, with colour	\$1199.00
EX 1000, with colour	\$1399.00
FX 1000	\$999.00
LQ 850 (24 pin)	\$1199.00
LQ 1050 (24 pin)	\$1649.00

NEW

VOTED BEST VALUE
\$949.00
 ATARI ST

Accessories

3 1/4" DS/DD	\$29.95
5 1/4" DS/DD Perfect Disks	\$19.95
900 A4 Rediform Paper	\$39.95
Monitor glare filter	\$39.95
Monitor tilts swivel base	\$39.95
Mouse mats (extra thick!)	\$24.45
Joysticks from	\$19.95
Ribbons, LX80, GX80	\$13.95
MPS 1200	\$14.95
Ribbons, 801, 802, 803	\$119.95
Ergo Chairs	\$249.00
Desks, steel frame	

5 1/4" DS DD disk \$19.95
 Certified & Tested
Perfect
 5/8" INCH FLEXIBLE DISKETTE

commodore
Pro Pack
\$599.00
 Includes: Commodore 64 1541 Disk Drive, GEOS Software, Joy Stick and 15 pieces of software.

3 1/2" DISKS
 Lifetime Guarantee
 Double Sided
 Double Density 3 1/2"
\$29.95
 Box of 10

SAVE \$1000
AMIGA 2000
 with 1084 Colour Monitor.
\$2999
 *Please present this add to receive this amazing limited offer.



CITY
 Shop 3, 99 Elizabeth St,
 Sydney, NSW 2000
 Phone 221 1910

CHATSWOOD
 Shop G9, Chatswood Place,
 Victoria Ave,
 Chatswood, NSW 2067
 Phone 419 2333

PARRAMATTA
 Shop 21a, Greenway Arcade,
 222 Church Street,
 Parramatta, NSW 2150
 Phone 891 1170

BURWOOD
 185 Burwood Road,
 Burwood, NSW 2134
 Phone 744 8809

HORNSBY
 35F Hunter Street,
 Westfield Shoppingtown,
 Hornsby, NSW 2077
 Phone 477 6886



AMIGA HARDWARE

1010 Drives	\$429
1084 Monitors	\$589
1 meg Ram & Clock	\$599
2 meg Ram & Clock	\$899
Amiga 1000 kit	\$1899
Amiga 500	\$899
Amiga 2000	\$2495
Amiga Modulator	\$59.95
Amiga 500 1/2 meg RAM	\$279
C Ltd 22 meg Hard Disk	\$1799
C Ltd 33 meg Hard Disk	\$2295
Digiview	\$399
Fastdrive 20 meg	\$1995
Future Sound	\$399
Genlock - PAL	\$1699
Hard Disk Controller	\$799
Insider 1 meg	\$799
Internal 3 1/2 NEC	\$269
Midi i/face	\$99
Perfect Sound	\$169
Spirit 1.5 meg	\$999
Supra Drive 20 meg	\$1995
Time Saver	\$139.95
X1010 Drive	\$399

3 way cartridge x-pander	\$69.95
Dolphin Dos	\$189.95
Family pack	\$329
Mouse	\$79.95
Light pen	\$19.95
Pro-pack	\$599
64 power supply	\$39.95
128 power supply	\$74.95

PC HARDWARE

1084 colour monitor	\$589
1201 mono monitor	\$199
20 meg hard disk	\$799
20 meg hard disk card	\$999
33 meg hard disk card	\$1399
Joystick i/face	\$69.95
Logipoint & Mouse	\$369
Magic Mouse	\$149
PC 5 & Monitor	\$999
PC 10 dual disk drive & monitor	\$1299
PC 20 + hard disk & monitor	\$1699
TTL amber monitor	\$299
TTL green monitor	\$399
Amstrad PC 10 mono	\$1495
Amstrad PC 20 mono	\$1795
Amstrad PC 20 colour	\$2295
Amstrad PC H/O colour	\$3195

PERIPHERALS

Citizen 120D i/face	\$89.95
2E printer i/face	\$99.95
Wico 3 way joystick	\$73.95
500 JX joystick	\$39.95
Apple joystick	\$49.95
Auto twinfire joystick	\$29.95
Bat handle joystick	\$59.95
Bit bitzer E	\$479
Bit bitzer	\$399
Boss joystick	\$49.95
CBM joystick	\$19.95
Centronics pic	\$119.95
Challenger joystick	\$19.95
IBM joystick	\$59.95

200X joystick	\$34.95
Nice modem 64/RS232	\$299
Nice modem II	\$699
Nice modem III	\$599
Netcom modem 64	\$289
Amiga 2000 PC emulator	\$999
Pro 1000 joystick	\$29.95
Pro 200 joystick	\$19.95
Pro 5000 joystick	\$39.95
Quickshot 10 J/S	\$59.95
Quick shot 1 J/S	\$24.95
Quick shot 2 J/S	\$29.95
Quick shot turbo J/S	\$49.95
Tac 2 joystick	\$49.95
Track bull	\$49.95
UHF modulator	\$19.95
Viatel modem C64 (black box)	\$99.95
Xetec jnr i/face	\$124
Xetec snr i/face	\$179
Amiga printer cables	\$39.95
Amiga serial cables	\$39.95
IBM printer cable	\$39.95
IBM serial cables	\$39.95
Gender bender	\$49.95
Computer desk	\$299
Ergonomic chair	\$129
Computer covers all sizes from	\$9.95
Monitor stand	\$39.95
Printer stand	\$39.95

PRINTERS

Epson	
LX800	\$499
EX800	\$899
LQ850 (NEW!)	\$1099
GD 3500 laser	\$3495
FX1000	\$939
EX1000	\$1199
LQ1050	\$1495
LQ2500 plus	\$1795
Ex colour option	\$139
LQ2500 colour opt	\$139

Citizen 120D (includes i/face)	\$499
--------------------------------	-------

Commodore

MPS1250	\$449
DPS1101	\$429
MPS810-64/128 Colour	\$449
MPS820 - Amiga Colour	\$449
MPS1280	\$799
MPS2020	\$1199
LP806 Laser	\$3699
DPS6400	\$859

Star

NL10	\$549
NX10	\$539

Stationery

Perfect 5 1/2" (10) Disks	\$14.95
SKC 3 1/2" (10) Disks	\$39.95
Nashua 5 1/4" (10) Disks	\$39.95
Nashua 3 1/2" (10) Disks	\$49.95
(All above lifetime warranty)	
5 1/4" storage (100) Box	\$19.95
3 1/2" storage (80) Box	\$19.95
3 1/2" storage (60) Box	\$16.95
5 1/4" steel storage (10) Box	\$24.95
Paper A4 2000	\$59.95
Paper quarto 2000	\$59.95
Mouse mats (BIG!)	\$19.95
Printer stand 10"	\$39.95
Monitor stand	\$39.95

Epson Ribbons

GX, LX80, ribbons	\$13.95
LX800 ribbons	\$17.95
LQ800 ribbons	\$19.95
LQ1000 ribbons	\$29.95

Commodore Ribbons

801, 802, 803	\$14.95
---------------	---------

Call for others!

COMMODORE 64/128 HARDWARE

1084 monitor	\$589
128 computer	\$299
128D computer	\$899
1531 dataset	\$59.95
1541 disk drive	\$349
1571 disk drive	\$399
1802 monitor - col.	\$439

MicroComputer Spot

Phone: 417 7395. Front 13 Gibbes Street, East Chatswood, NSW 2067

MAIL ORDER

AMIGA SOFTWARE

Alien Fires AA... Epic Arc. Adventure Game \$49.95
 A Mind Forever Voyaging AD... Infocom Text Adventure...\$99.95
 A-Term U... Easy to use Terminal Pack. \$99.95
 Acquisition Database BU... Professional Fully Prog...\$699.00
 Adventure Construction U... Create & play own games...\$79.95
 Aegis Animator/Images A... Top quality graphics pack \$295.00
 Aegis Art Pack 1 A... Full of pics & animations \$199.00
 Aegis Draw A... Full feat. 2D CAD pack...\$345.00
 Aegis Draw Plus A... Updated extra features...\$449.00
 Aegis Images A... Quality drawing package \$149.95
 Amiga Pascal U... Metaconco version...\$249.95
 AmigaDOS Enhancer U... NEW 1.2 system! 3 disks...\$39.95
 Amiga Karate AA... Fast kung fu action game...\$69.95
 AmigaDOS Express U... AmigaDOS manual on disk \$69.95
 Analyse! B... Prof. qual' spreadsheet...\$199.95
 Analyse! II B... Just that little bit better! \$199.95
 Animal Kingdom ED... Great graphical education...\$49.95
 Arazok's Tomb AD... New adult graphic adv...\$109.95
 Archon AA... Animated chess type arc...\$89.95
 Archon II Adept AA... Part 2 of the original...\$89.95
 Arctic Fox AA... Arc. action in super tank! \$74.95
 Arena AA... Arc. game in various sports \$49.95
 Aztec "C" Compiler U... Programmers delight...\$679.95
 Barbarian AA... Fantastic new arc. game...\$69.95
 Balance of Power ST... Political world strategy...\$89.95
 BBS-PC U... Run your own B.B.S...\$225.00
 Borrowed Time AD... Icon driven adv. game...\$64.95
 Bratacus ST... Comic styled arc. adv...\$49.95
 Bridge 4.0 ST... Play professional Bridge...\$89.95
 Brush Works AA... Clipart collection 3 disks...\$79.95
 Bureaucracy AD... New infocom text adv...\$69.95
 Business Card Maker AB... Create & print your own! \$119.00
 Butcher AA... High quality graphics tool...\$79.95
 Challenger ST... Another gt space act. game \$39.95
 Championship Baseball S... Baseball simulation 3D...\$109.95
 Championship Basketball S... Two on two basketball sim...\$69.95
 Championship Football S... Fantastic 3D simulation...\$69.95
 Championship Golf S... Professional 3D golf...\$79.95
 Chessmaster 2000 AD... Best qual. 3D chess ever \$109.95
 Chessmate ST... 3D/2D chess game...\$99.95
 City Desk B... Desk top publish. pack...\$199.95
 Climate U... The ultimate disk utility...\$79.00
 Custom Screens U... Amiga basic utility...\$149.95
 dB Man B... Lotus 1-2-3 compatible...\$399.95
 De Ja Vu ST... Icon driven adv. game...\$99.95
 Decimal Dungeon ED... Educational junior high 5th \$49.95
 Deep Space AA... Arcade space conq. game...\$89.95
 Defender of the Crown ST... Best arc. game anywhere...\$99.95
 Deluxe Music Construction M... Desk top music/midi cont \$199.00
 Deluxe Paint II A... Best graphic pack. today! \$249.00
 Deluxe Paint Help A... Great tutoring package...\$54.95
 Deluxe Paint Utilities A... Art & utility package...\$64.95
 Deluxe Arts & Parts A... Art pack. for Deluxe Paint...\$59.95
 Deluxe Art Pack A... Seasons and holidays...\$59.95
 Deluxe Music Data Disk M... Rock 'n' roll data disk...\$59.95
 Deluxe Print A... Design & print signs cards...\$99.95
 Deluxe Print Art Disk A... Clip art pack vol. 2...\$99.95
 Deluxe Video A... Design & run video prods \$199.95
 Demonstrator A... Rcds all you do & replays \$69.95
 Demolition AA... Great new arc. shoot em up \$39.95
 Diga! U... Best term. software pack! \$169.95
 Digiview A... Software & filter only...\$399.00
 Digiview II A... Version 2 of the s'ware only \$69.95
 Digiview With Camera Panasonic WV 1410 Lens & Cable \$1275.00
 Digi Paint A... Prof. H.A.M. paintbox!...\$169.95
 Discovery - Maths ED... Space educational game...\$69.95
 Discovery - Spell ED... Space educational game...\$69.95
 Discovery - Trivia ED... Space educational game...\$69.95
 Diskwik U... Disk repair & utilities kit...\$89.95
 Dr XES ST... Computer therapy sessio...\$49.95
 Earl Weaver Baseball S... Arc./strat./sports game...\$109.95
 Explorer U... Machine code ed. monitor \$139.95
 Fast Fonts U... Great new fonts & utilities \$74.95
 FACC U... Speeds up disk access...\$69.00

Feary Tale ST... 3D graphic adv. great! \$49.95
 Financial Time Machine ST... What if? S'market game \$139.00
 Financial Cookbook B... What if? Calc. machine...\$99.95
 First Shapes ED... Best young educ. seen! \$49.95
 Flight Simulator II SI... Full featured simulator...\$115.00*
 Flight Sim II Scenery SI... Scenery disk No. II...\$79.95
 Flipside! B... Prints data o/p ut sideways \$139.95
 Forms in Flight A... 3D object CAD+stereo vis \$169.95
 Fortran 77 U... Programming language...\$260.00*
 Font Set 1 U... 8 new Amiga fonts+maker \$75.00*
 Fraction Action A... Educational 5th grade & up \$49.95*
 Galileo ED... Astronom. planetarium...\$119.95
 Gary Rayner Midi M... Midi Interface...\$99.00*
 Geography I ED... Educational...\$119.00
 Geography II ED... Educational...\$119.00
 Gizmoz Productivity V2 B... D'base diary games term. \$139.95
 Gold Run AA... Fastest space/arc. seen...\$74.95
 Gold Spell B... 80,000 word spell check...\$79.95
 Grabbit A... Screen cap. to IFF format...\$79.95
 Graphcraft A... Drawing package/editor...\$99.95
 Grand Slam S... 3D tennis simulation...\$59.95
 Gridiron E... Professional arc. sim...\$169.95
 Guild of Thieves ST... New graphic adv. game...\$74.95
 Hacker ST... Arc. comp. n'work hacking \$69.95*
 Hard Ball S... Top qual baseball game...\$69.95
 Hacker II ST... Part 2 of the original...\$69.95
 Hitchhiker's Guide AD... Infocom text adv...\$99.95
 Hollywood Hi Jinx AA... Infocom text adv...\$99.95
 Hollywood Strip Poker ST... Play poker with the ladies \$49.95
 Instant Music M... Real time music jammin' \$59.95
 Jewels of Darkness ST... 3 adv. games & graphics...\$84.95
 Karate Kid II AA... Kung fu arcade action...\$89.95
 Kamfgruppe ST... Strategic tank warfare...\$69.95
 Key Board Cadet E... Quality arc. typing tutor...\$99.95
 Kid Talk E... Quality educational s'ware \$49.95
 Kinderama E... Educational preschool age \$49.95*
 King's Quest I ST... 3D graphic arcade adv...\$49.95
 King's Quest II ST... 3D graphic arcade adv...\$69.95
 King's Quest III ST... 3D graphic arcade adv...\$69.95
 Knight Orc ST... A 3 part fantasy adv...\$69.95*
 Lattice "C" Compiler U... Programmer's seriously...\$245.00
 Lattice dBCH Library U... Programmer's stuff???? \$299.95
 Lattice Screen Editor U... Top quality screen editor...\$195.00*
 Leaderboard S... 3D golf simulation...\$79.95
 Leaderboard II S... Extra courses disk...\$45.00*
 Leather Goddesses AD... Infocom text adventure...\$99.95
 Lexcheck B... 100,000 word spell check \$119.95
 Lisp U... Programming language...\$159.00
 Little Computer People ED... Doll's house type sim/game \$59.95
 L.D.P. Writer B... Fantastic new word proc \$199.95
 Logistix B... Professional spreadsheet...\$399.00
 Macro Assembler U... Programmer's tool...\$249.95
 Marble Madness AA... Arcade quality game!! \$99.95
 Math Talk E... Quality educational s'ware \$49.95
 Master Type E... Typing tutor arc. style...\$79.95
 Maxicomm U... Quality terminal pack...\$129.95
 Maxidisk B... Desktop utilities...\$149.95
 Maxiplan B... Professional spreadsheet...\$349.00
 Mean 18 Golf S... 3D golf & construction kit...\$49.95
 Mega Disk Vol 1 V... Mag. on a disk, hints & tips \$19.95
 Mega Disk Vol 2 U... Mag. on a disk, hints & tips \$19.95
 Mega Disk Vol 3 U... Mag. on a disk, hints & tips \$19.95
 Mi Amiga Ledger B... Gen. ledger for home, bus. \$229.95
 Mi Amiga File B... Full feat. d'base system...\$249.95
 Mind Walker ST... Arc. game in human mind \$139.95
 Mindshadow AA... Icon driven graphic adv...\$59.95
 Modula 2 U... Programming language...\$171.76
 Money Mentor B... Personal financial system \$225.00
 Moon Mist AD... Infocom text adventure...\$89.95
 Mouse Trap AA... Arcade platform action...\$49.95
 Music Studio I M... Data disk for quiz master...\$169.95
 Music Student M... Music maker, midi cont...\$89.95
 New Tech Colour Book E... Educational tool...\$64.95
 OGRE ST... Strategic future battle sim \$99.95
 One on One S... Basketball simulation...\$79.95
 Organize! B... Fully feat. d'base system...\$199.95
 P.H.A.S.E.R. B... Home accounting system \$139.95

Page Setter B... Desk top publishing pack \$249.95
 Page Setter Laser B... Laser printer & P'script dvr \$79.95
 Par Home 1 B... Home fin. management...\$119.95
 Perfect Sound M... Stereo sound dig./ed...\$199.95
 Phantasie AA... D&D role playing game...\$79.95
 Phalanx AA... Great new arc. shoot em up \$39.95
 Portal AA... Epic sci-fi novel game...\$79.95
 Printmaster Plus A... Design & print signs cards \$79.95
 Printmaster Art 1 A... Data disk full of graphics...\$79.95*
 PRISM A... 4096 HAM graph. pack...\$139.00*
 Pro Video (PAL version) A... Pro character generator...\$399.00*
 Prowrite B... Wordpro with col. & graph \$299.95
 Quintette G... Anc. Chinese strat. game \$79.95
 Racter ST... Comp. conversationalist...\$114.95
 Read & Rhyme E... Educational 5 to 10 yr olds \$49.95*
 Reading 1 E... Educational...\$119.00
 Roadwar 2000 G... New strat. game from SSI \$99.95
 Rogue ST... Dungeons & Dragons adv. \$59.95*
 Sculpt 3D A... Prof. rendering pack...\$189.95
 S.D.I. G... Cinemaware classic...\$99.95
 Scribble II B... Qual wordpro dict merge...\$199.95
 Seven Cities of Gold ST... Arcade world explorer...\$89.95
 Shanghai ST... Marjong type tile strat...\$89.95
 Silent Service ST... Fantastic 3D sub. sim...\$79.95
 Silicon Dreams ST... 2 space adv. inc. graphics \$79.95
 Sinbad & Throne Falcon ST... Cinemaware classic...\$99.95
 Sky Fox AA... Action combat/flight sim...\$89.95*
 Space Battle AA... Great new arc. shoot em up \$39.95
 Space Quest AA... 3D arc. styled adv...\$109.95
 Speller Bee E... Quality educational s'ware \$49.95
 Star Fleet I A... Command star ship battle \$99.95
 Stationfall AD... Infocom text adventure...\$79.95*
 Starglider AA... Fast space arcade game...\$75.00*
 Strip Poker ST... A revealing game of skill...\$69.95
 Super Huey SI... Arc. helicopter sim...\$74.95
 Supertex II U... Viactl terminal pack...\$129.95
 Superbase B... Relational d'base system \$299.00
 Swooper AA... Quality arc. space game...\$49.95
 Surgeon SI... Operating theatre sim...\$119.95
 Talker B... Talking word proc...\$99.95
 Talking Colour Book E... Great for the younger users \$79.95
 Tass Times in Tone Town AD... Icon driven adv. game...\$89.95
 Terror Pods AA... Latest f'tastic space game \$79.95
 Temple of Apsahl Trilogy AD... Classic Dung. & Dragons...\$59.95
 Textcraft B... Wordprocessor/with tutor \$95.00
 The Bard's Tale ST... 3D Dung. & Dragons epic...\$99.95
 The Pawn AD... Adv. game/great graph...\$79.95
 The Publisher B... Desk top pub. pack...\$399.00
 Trinity AD... Infocom text adventure...\$79.95
 True Basic U... Programming language...\$399.00
 True Basic 3D Graphics U... Data disk files for True B. \$149.95
 TV Text U... Character gen. s'ware...\$199.95
 Ultima III ST... Epic D & D game...\$109.95
 Unicalc B... Spreadsheet package...\$199.95
 Uninvited G... De Ja Vu II, icon adv...\$89.95
 Video Vegas G... Video casino games, poker \$65.00*
 VIP Professional B... Lotus 1-2-3 type pack...\$399.00
 Vizawrite B... Desktop wordpro. fonts...\$299.00
 Vocabulary I B... Educational...\$119.00
 Winnie the Pooh E... in 100 acre wood, for kids \$69.95
 Winter Games G... Winter sports sim...\$69.95
 Wishbringer AD... Infocom text adv...\$99.95
 Word Perfect B... The ultimate word proc...\$679.95
 World Games G... Arcade world sports action \$79.95
 Write Hand B... Bus. styled word proc...\$225.00
 Zing! Keys U... Hot keys, sc. saver dump...\$129.95
 Zork I AD... Infocom text adv...\$99.95
 Zork II AD... Infocom text adv...\$99.95
 Zork III AD... Infocom text adv...\$99.95

AA	Arcade Action	SI	Strategy
S	Sport	SI	Simulator
AD	Adventure	U	Utility
H	Home	A	Art & Graphics
BU	Business	M	Music
ED	Education		

MicroComputer Spot

Phone: 417 7395. Front 13 Gibbes Street, East Chatswood, NSW 2067

MAIL ORDER

C64/128 SOFTWARE

1942 Cass/Disk (ST) \$34.95
 1943 Cass (ST) \$39.95
 221D Baker Street Disk (ST) \$49.95
 3 Musketeers Cass (AA) \$34.95 Disk \$49.95
 30 Games (AA) Cass \$39.95
 1943 (AA) Disk \$49.95
 500 CC (S) Cass \$29.95 Disk \$39.95
 5th Axis (AA) Cass \$34.95
 64 Talk (U) Cart \$99.95
 9 to 5 (H) Disk \$29.95
 Forever Voyaging 64D (AD) \$69.95
 Abracalc (H) Cass \$39.95
 Ace (SI) Disk \$44.95
 Ace of Aces (AA) Cass \$39.95
 Acrojet (SI) Cass \$34.95
 Action Pak (AA) Cass \$9.95
 Advanced Music Sys (H) Disk \$159.95
 Adventure (AD) Disk \$29.95
 Agent Orange (AD) Cass \$39.95
 Algebra (ED) Disk \$29.95
 Aliens (AA) Cass \$29.95
 Alleycat (AA) Cass \$39.95 Disk \$39.95
 Alternate Reality (ST) Disk \$39.95
 Amazon (ST) Cass \$29.95
 America's Cup (S) Disk \$49.95 Cass \$34.95
 Animal Kingdom (ED) Disk \$24.95
 Antroid (AA) Cass \$29.95
 Arac (AA) Cass \$39.95
 Arknoid (ST) Cass \$39.95 Disk \$39.95
 Arc of Yor (ST) Cass \$29.95
 Arc Pandora (AA) Cass \$39.95 Disk \$34.95
 Army Moves (ST) Cass \$29.95 Disk \$39.95
 Art Gallery 1 (H) Disk \$49.95
 Art Gallery 2 (H) Disk \$49.95
 Artist (H) Disk \$84.95
 Assault (AA) Cass \$29.95
 Assembler 128 (H) Disk \$79.95
 Assembler 64 (H) Disk \$29.95
 Asterix (AA) Cass \$29.95 Disk \$44.95
 Athena (ST) Cass \$34.95 Disk \$59.95
 Aussie Pak (AA) Cass \$29.95 Disk \$29.95
 Azimouth Align Kit (H) Cass \$29.95
 Boulderdash Con Kit (AA) Cass \$39.95 Disk \$39.95
 Boulderdash (AA) Cass \$19.95 Disk \$24.95
 Boulderdash 2 (AA) Cass \$29.95 Disk \$39.95
 Battle of Normandy (ST) Disk \$39.95
 Back to the Future (ST) Disk \$39.95
 Balblazer (S) Disk \$49.95
 Barbarian (AA) Cass \$39.95 Disk \$44.95
 Bards Tale II (ST) Disk \$64.95
 Bards Tale (ST) Disk \$79.95
 Baseball (S) Disk \$69.95
 Basketball (S) Cass \$29.95 Disk \$44.95
 Batalyx (AA) Cass \$29.95
 Battle of Britain (ST) Disk \$29.95
 Battle Front (ST) Disk \$49.95
 Bazooka Bill (AA) Cass \$29.95 Disk \$34.95
 BBS 128 (H) Disk \$119.95
 Best of Beyond (AA) Cass \$39.95
 Beyond Forbidden (ST) Cass \$34.95 Disk \$54.95
 Big Troub. Little Ch. (ST) Cass \$29.95 Disk \$29.95
 Biggles (ST) Cass \$34.95
 Blitzkrieg (ST) Cass \$24.95 Disk \$39.95
 Blue Max (AA) Disk \$49.95
 Bobs Term C128 (H) Disk \$129.95
 Bomb Jack 2 (AA) Cass \$24.95 Disk \$34.95
 Bomb Jack (AA) Disk \$29.95
 Bombo (AA) Cass \$19.95
 Bored of the Rings (AA) Cass \$39.95
 Bouncer (AA) Cass \$29.95
 Bounder (AA) Cass \$24.95 Disk \$29.95
 Breakthrough (AA) Cass \$29.95
 Bride of Frankenstein (ST) Disk \$39.95
 Brodebund Pak (AA) Disk \$39.95
 Budget Software (AA) Cass \$9.95
 Bug Blitz (AA) Disk \$39.95 Cass \$24.95
 Bugsy (AA) Cass \$39.95
 Bulldog (AA) Disk \$39.95 Cass \$29.95
 Bulletin Board (H) Disk \$74.95
 Bureaucracy 128 (ST) Disk \$59.95
 Cadpak 128 (H) Disk \$189.95
 Cadpak C64 (H) Disk \$99.95
 California Games (S) Disk \$39.95
 Camelot (AA) Cass \$24.95
 Captain Kelp (AA) Cass \$29.95
 Captured (AA) Cass \$34.95

Camers at War (ST) Disk \$49.95
 Cashbook (H) Disk \$129.95
 Cauldron 2 (AA) Disk \$39.95
 Cave Fighters (AA) Cass \$14.95
 Certificate Maker (H) Disk \$99.95
 Certificate Library (H) Disk \$59.95
 Chameleon (AA) Cass \$34.95 Disk \$29.95
 C'ship Basketball (S) Cass \$29.95 Disk \$44.95
 C'ship Football (S) Cass \$29.95 Disk \$44.95
 Chart Busters (AA) Disk \$34.95
 Chartpak 128 (AA) Disk \$119.95
 Chessmaster 2000 (ST) Disk \$99.95
 Clipart (H) Disk \$49.95
 Clipart 2 (H) Disk \$49.95
 Cobol 128 (H) Disk \$189.95
 Cobra (AA) Cass \$39.95
 Color Magic (H) Disk \$39.95 Cass \$29.95
 Colossus (ST) Cass \$34.95 Disk \$39.95
 Comet Games (AA) Cass \$19.95
 Comics (AA) Disk \$59.95
 Commando (AA) Cass \$29.95 Disk \$39.95
 Compubar (H) Cass \$29.95
 Conflict in Vietnam (ST) Disk \$44.95
 Confusion (AA) Cass \$24.95
 Core (AA) Cass \$29.95 Disk \$49.95
 Critical Mass (AA) Cass \$29.95
 Crossword (ST) Disk \$74.95
 Crypto (ST) Disk \$49.95
 Chrystal (AA) Cass \$19.95 Disk \$34.95
 Cyborg (AA) Cass \$39.95 Disk \$39.95
 Dan Dare (AA) Cass \$39.95 Disk \$39.95
 Dandy (AA) Cass \$34.95 Disk \$39.95
 Darkon (AA) Cass \$29.95
 Data Manager 128 (H) Disk \$99.95
 Database (H) Disk \$49.95 Cass \$49.95
 Deactivate (ST) Disk \$39.95
 Death or Glory (ST) Cass \$39.95 Disk \$39.95
 Deceiver (ST) Disk \$39.95
 Decimal Dungeon (ED) Cass \$24.95
 Defcom (ST) Cass \$29.95
 Defender of the Crown (ST) Disk \$49.95
 Delta Force (AA) Cass \$34.95 Disk \$49.95
 Deskpak 1 (H) Disk \$99.95
 Destroyer (ST) Disk \$39.95
 Detective (ST) Cass \$29.95
 Disector III (H) Disk \$89.95
 Donald Duck's Playground (ED) Disk \$49.95
 Doomworld (ST) Cass \$19.95
 Dr Who (ST) Cass \$39.95 Disk \$59.95
 Dracula (AA) Disk \$39.95
 Dragons Lair (AA) Cass \$39.95 Disk \$49.95
 Druid (AA) Cass \$29.95 Disk \$49.95
 Durell (AA) Disk \$39.95
 Eagles (AA) Cass \$29.95 Disk \$34.95
 Easy Script (H) Disk \$100.00
 Easy Spell (H) Disk \$80.00
 Easy Calc (H) Disk \$69.95
 Easy Mail (H) Disk \$29.95
 Eidolon (AA) Disk \$49.95
 Electroligne (SI) Disk \$34.95
 Elite (ST) Cass \$59.95
 Enduro Racer (S) Cass \$29.95 Disk \$39.95
 Europe Ablaze (ST) Disk \$49.95
 Explode (AA) Disk \$9.95
 Explorer (AA) Cass \$29.95 Disk \$39.95
 Fraction Fever (E) Cass \$39.95
 Freeze Frame V38 (U) Cart \$99.00
 Freeze Frame Utility (U) Disk \$49.95
 Freeze Machine (U) Cart \$169.95
 F15 Strike Eagle (S) Disk \$44.95
 Fast Load (U) Cass \$59.95
 Fast Trax (S) Disk \$49.95
 Field of Fires (AA) Disk \$49.95
 Fighting Warrior (AA) Cass \$24.95
 File Now (B) Disk \$29.95
 Final Cartridge (U) Disk \$169.95
 Fire Word (AD) Cass \$39.95 Disk \$39.95
 Fire Trak (AA) Disk \$39.95
 Fist 2 (S) Cass \$29.95 Disk \$39.95
 Flight Simulator 2 (SI) Disk \$109.95
 Fontmaster (H) Disk \$79.95
 Font Pack 1 (H) Disk \$69.95
 Football (S) Cass \$29.95
 Fort Apocalypse (ST) Cass \$29.95
 Fraction Fever (ED) Cass \$24.95
 Frankenstein (AA) Cass \$29.95 Disk \$39.95
 Fruity (AA) Cass \$29.95
 Flight Sim Data Disks (SI) \$79.95
 Future Knights Cass \$34.95 Disk \$49.95

G. Pascal (U) Disk \$79.95
 Galvan (AA) Disk \$39.95
 Game Killer (U) Cass \$39.95
 Game Maker (U) Disk \$64.95
 Garfield (ED) Disk \$69.95
 Gato (SI) Disk \$59.95
 Gauntlet 2 (AA) Cass \$19.95 Disk \$29.95
 Gauntlet (AA) Cass \$29.95 Disk \$34.95
 Geodex (U) Disk \$69.95
 Geos (U) Disk \$129.95
 Graham Gooch Crick (S) Cass \$29.95 Disk \$39.95
 Ghost & Goblins (AA) Disk \$39.95
 Glider Rider (SI) Cass \$34.95
 Golf Const Kit (S) Disk \$39.95
 Goonies (AA) Disk \$39.95
 Graham Gooch 128 (S) Disk \$44.95
 Great Escape (ST) Cass \$29.95 Disk \$44.95
 Green Beret (AA) Disk \$39.95
 Gunship (SI) Disk \$49.95 Cass \$44.95
 Gunslinger (ST) Disk \$49.95
 Hacker 2 (AD) Cass \$34.95 Disk \$39.95
 Hack Pack 128 (U) Disk \$129.95
 Hacker (AD) Disk \$39.95
 Hades (AA) Cass \$34.95
 Hands On C/P/M 128 (ED) Disk \$29.95
 Head Over Heels (AA) Cass \$29.95 Disk \$39.95
 Hitchhikers Guide (AD) Disk \$69.95
 Hitpack (AA) Disk \$29.95
 Hobbit (AD) Disk \$39.95
 Hocus Pocus (AA) Cass \$29.95
 Home Manager (H) Disk \$39.95
 Hot Pack (AA) Cass \$24.95 Disk \$24.95
 Howard the Duck (ED) Cass \$34.95
 Humanoid (AA) Disk \$39.95 Cass \$24.95
 Hyperball (S) Cass \$34.95
 Impossible Mission (ST) Cass \$14.95
 Indiana Jones (ST) Cass \$34.95 Disk \$39.95
 Indoor Sports (S) Cass \$39.95 Disk \$39.95
 Infocom Hint Books (AD) \$24.95
 International Karate (S) Disk \$39.95 Cass \$29.95
 Intro to Basic 1 (ED) Cass \$39.95 Disk \$39.95
 Intro to Basic 2 (ED) Cass \$39.95 Disk \$39.95
 Indis (AA) Cass \$34.95 Disk \$49.95
 Its a Knockout (S) Cass \$39.95
 Iwo Jima (ST) Cass \$29.95 Disk \$39.95
 Jack the Nipper (AA) Cass \$29.95 Disk \$34.95
 Jail Break (AA) Cass \$29.95 Disk \$44.95
 Jane 128 (H) Disk \$99.95
 Jet (SI) Disk \$99.95
 Judge Dredge (AA) Cass \$29.95 Disk \$34.95
 Jumpman (AA) Cass \$14.95
 Kage (AA) Cass \$29.95
 Kampfgruppen (ST) Disk \$49.95
 Karate (S) Cass \$29.95 Disk \$34.95
 Kettle (AA) Cass \$29.95 Disk \$34.95
 Keys on Typing (H) Disk \$49.95
 Kill Until Dead (AA) Cass \$29.95
 Knight Games (S) Cass \$29.95 Disk \$39.95
 Knuckle Busters (AA) Cass \$34.95 Disk \$39.95
 Konami Coin Op Hits (AA) Cass \$39.95 Disk \$44.95
 Krackout (S) Cass \$34.95
 Kwik Calc (H) Disk \$39.95
 Kwik Ched (H) Disk \$29.95
 Kwik Pak (H) Disk \$39.95
 Kwik Write (H) Disk \$39.95
 Labyrinth (AA) Disk \$39.95
 Laser Basic (U) Disk \$59.95
 Laser Compiler (U) Cass \$59.95 Disk \$64.95
 Laser Genius (U) Disk \$59.95
 Laser Script (B) Disk \$59.95
 Last Mission (AA) Cass \$29.95 Disk \$39.95
 Last Ninja (S) Cass \$34.95 Disk \$49.95
 Leader Board (S) Disk \$44.95 Cass \$34.95
 Le Mans (S) Cart \$34.95
 Levanth (AA) Cass \$29.95 Disk \$39.95
 Light Force (AA) Disk \$34.95 Cass \$29.95
 Little Computer People (ED) Cass \$24.95
 Little Robots (ED) Disk \$39.95
 Living Dead (AA) Cass \$39.95 Disk \$49.95
 Logo (ED) Cart \$80.00
 M 128 Debtors (B) Disk \$169.95
 M 128 General Ledger (B) Disk \$169.95
 M 128 Cash Book (B) Disk \$169.95
 M 64 Acc Receiv (B) Disk \$99.95
 M 64 Stock (B) Disk \$99.95
 M 64 General Ledger (B) Disk \$99.95
 M 64 Acc Payable (B) Disk \$99.95
 Mag Max (AA) Cass \$29.95
 Disk \$34.95

Magic (AA) Disk \$29.95
 Mandradore (AA) Cass \$49.95
 Maps of the World (ED) Cass \$39.95
 Disk \$39.95
 Marble Madness (AA) Disk \$69.95
 Mario Brothers (AA) Cass \$27.95
 Masters of the Universe (AA) Disk \$39.95
 Masters 2 (AA) Disk \$49.95
 Mastertronic (AA) Disk \$19.95
 Max Headroom (AA) Disk \$19.95
 McGraw Hill (ED) Cass \$11.95 Disk \$14.95
 Mega Apocalips (ST) Cass \$34.95 Disk \$49.95
 Mercenary (AA) Cass \$39.95
 Microcross (S) Cass \$29.95 Disk \$39.95
 Miss Elevator (AA) Disk \$49.95
 Montezuma (ST) Cass \$34.95 Disk \$44.95
 Mule (ST) Disk \$44.95
 Music Construction Set (H) Cass \$24.95
 Music Studio (H) Disk \$49.95
 Mutants (AA) Disk \$49.95
 Cass \$34.95
 Mutants (AA) Disk \$34.95
 Nemesis (AA) Cass \$39.95
 Newsroom (H) Disk \$99.95
 Nexus (AA) Disk \$49.95
 Nomad (AA) Cass \$34.95
 Nosferat (AA) Cass \$29.95 Disk \$29.95
 Ozi Double Pack (AA) Disk \$29.95
 Paperboy (H) Cass \$29.95 Disk \$39.95
 Paper Clip 128 (H) Disk \$109.95
 Paper Clip (H) Disk \$99.95
 Parallax (AA) Disk \$39.95
 Partner 128 (H) \$99.95
 Personal 128 (H) Disk \$69.95
 Petspeed 128 (H) Disk \$149.95
 Phantasia 2 (AA) Disk \$44.95
 Phantasia (AA) Disk \$44.95
 Photocopy (H) Disk \$39.95
 Ping Pong (S) Cass \$29.95
 Pirates (AA) Cass \$49.95
 Pirates (AA) Disk \$49.95
 Pit Stop (S) Disk \$19.95
 Plastmatron (AA) Cass \$29.95 Disk \$29.95
 Pocket Pack 128 (H) Disk \$199.95
 Pocket Filer 128 (H) Disk \$99.95
 Pocket Planner 128 (H) Disk \$64.80
 Pocket Writer 128 (H) Disk \$99.95
 Police (AA) Cass \$24.95
 Popeye (AA) Cass \$29.95
 Portal (AA) Disk \$44.50
 Power Cartridge (U) Cart \$149.95
 Power Play (AA) Disk \$49.95
 Print Shop (H) Disk \$99.95
 Print Master (H) Disk \$74.95
 Prodigy (ST) Cass \$29.95 Disk \$39.95
 Print Shop Companion (H) Disk \$84.95
 Print Shop Graphics I (H) Disk \$54.95
 Print Shop Graphics II (H) Disk \$49.95
 Psycastr (AA) Cass \$34.95 Disk \$39.95
 Pub Game (S) Cass \$34.95
 Quake (AA) Cass \$29.95
 Quartet (ST) Disk \$39.95
 Racing Destruction Set (S) Disk \$34.95
 Raid 2000 (S) Cass \$29.95
 Disk \$39.95
 Ramba (AA) Disk \$39.95
 Rana Rama (AA) Cass \$34.95
 Disk \$39.95
 Rasputin (AA) Cass \$29.95
 Realm of Impossibility (ST) Disk \$39.95
 Redhawk (AA) Cass \$29.95
 Disk \$34.95
 Renegade (ST) Cass \$29.95
 Repton (AA) Disk \$39.95
 Cass \$34.95
 Repton 3 (AA) Cass \$34.95
 Rescue on Fractalus (AA) Disk \$29.95
 Return to Eden (AD) Disk \$29.95
 Reus 1 (S) Disk \$44.95
 Risk (ST) Disk \$19.95
 Road to Moscow (AA) Disk \$94.95
 Road Race (S) Disk \$49.95
 Road Runner (AA) Disk \$39.95
 Cass \$29.95
 Roadwar 2000 (ST) Disk \$44.95
 Rock 'n' Wrestle (S) Disk \$34.95
 Rocketball (AA) Cass \$29.95
 Rogue (AD) Cass \$34.95
 Disk \$39.95

**THE WRAPS ARE ABOUT TO
COME OFF THE PERSONAL
COMPUTERS OF THE DECADE.**

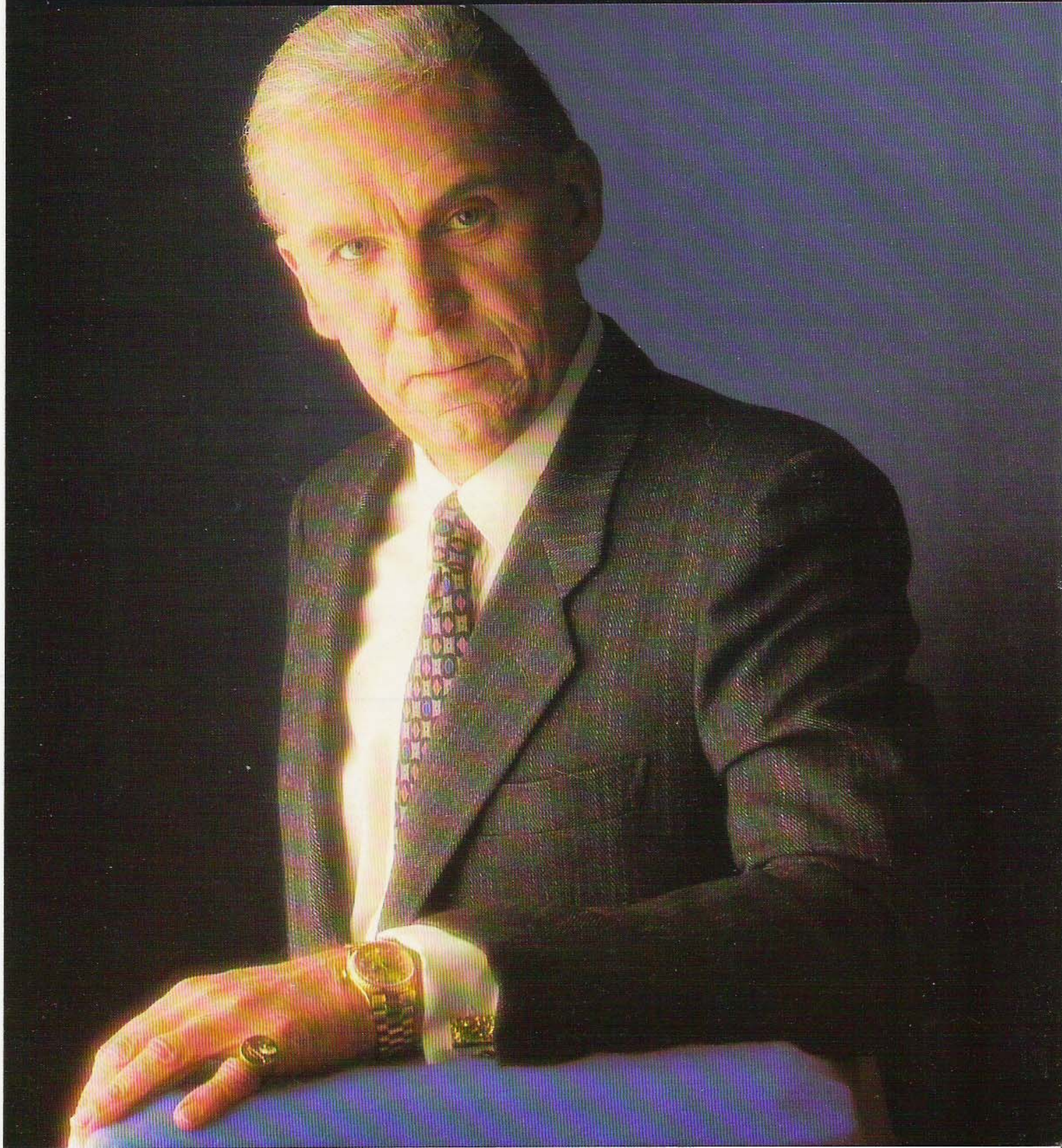

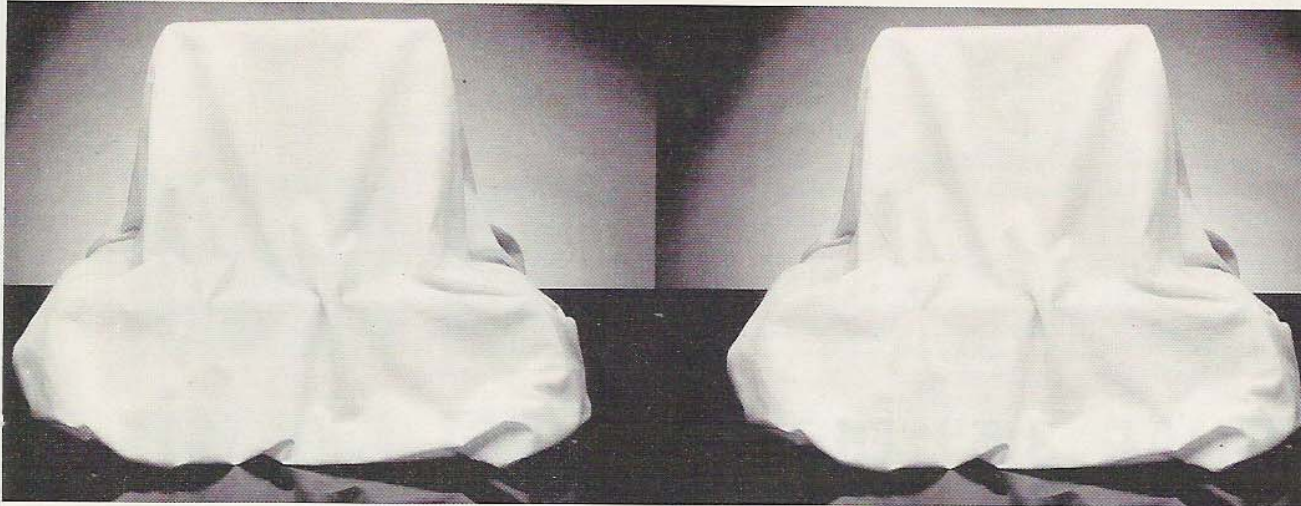

AMIGA 500
\$999* R.R.P.

A decade in the computer industry is like a century in any other industry, and conventional PC technology has been overtaken, not by product improvements, but by more advanced technology.

And that new technology has a name: AMIGA.

Soon all the advanced features of the AMIGA will be available for \$999* R.R.P.

Here are the features:

- 512K usable RAM for increased productivity
- Internally expandable to 1 Megabyte for advanced applications
- Superior GRAPHICS, SOUND and ANIMATION capabilities
- Multi-tasking for running different applications simultaneously
- Palette of 4096 colours
- 4 Channel, stereo sound output
- Music and voice synthesiser built-in
- Large range of software available (over 500 commercially released packages)
- Compatible with all commercially released AMIGA 1000 software**

AMIGA 2000
\$2999* R.R.P.

The Commodore AMIGA 2000 is the ultimate personal computer designed for use in Business, Industrial Control, Video and Graphics Applications. The AMIGA 2000 has set a new standard in price performance with outstanding GRAPHICS, SOUND and ANIMATION and capabilities that provide the power you need to improve the quality of your work for \$2999* R.R.P.

Here are the features:

- 1 Megabyte usable RAM for increased productivity
- Internally expandable to 9 Megabytes for advanced applications
- Superior GRAPHICS, SOUND and ANIMATION capabilities
- Multi-tasking for running different applications simultaneously
- Palette of 4096 colours
- 4 Channel, stereo sound output
- Music and voice synthesiser built-in
- Large range of AMIGA software available
- Optional IBM*** MS DOS Compatibility



ARE YOU KEEPING UP WITH THE COMMODORE AMIGA?

*Monitor extra
**Designed for AMIGA DOS 1.2
***IBM is a registered trademark of International Business Machines.

DISKWORKS

80 Meg
Hard Disk - Soon
CALL!

PTY LTD

**YOUR AMIGA 500, 1000 AND 2000
MASS STORAGE SPECIALISTS**

EXTERNAL 3.5" DISK DRIVES:

- * HEAVY DUTY JAPANESE DRIVE UNIT
- * 12 MONTH WARRANTY
- * SUPER SLIM-LINE : ONLY 1" HIGH
- * LOW POWER - 2.1 WATTS
- * DESIGNED IN AUSTRALIA
- * **DOES NOT CLICK** when diskette removed
- * QUALITY ROUND CABLE
- * DRIVE CAN BE DISABLED WITH SWITCH ON REAR
- * CAN BE POWERED FROM THE AMIGA OR FROM THE DRIVE'S OWN INTEGRATED POWER SUPPLY (requires 9v power pack)

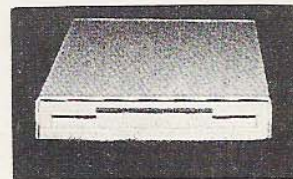

SILENT SERVICE

- SINGLE DRIVE UNIT
- UPWARD EXPANDABLE TO TRI-DRIVE
- MANY ADVANCED FEATURES (see above)

\$349

DEALER ENQUIRIES WELCOME

THE "DOWNUNDER"
DRIVES THAT WE'RE
EXPORTING ALL OVER THE
WORLD -

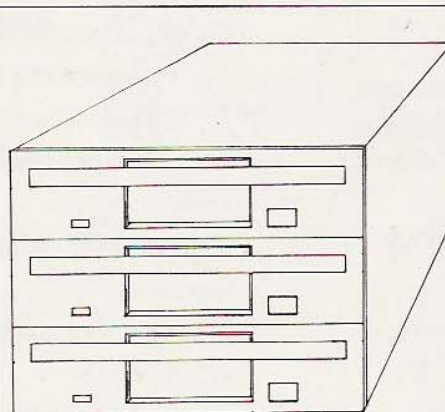

DISKWORKS

TRI-DRIVE

- AVAILABLE FITTED WITH ONE OR TWO OR THREE DRIVES
- 8cm HIGH TOTAL
- EACH DRIVE CAN BE SWITCH DISABLED
- LOGIC AND CONNECTOR TO ALLOW CONNECTION OF A 5 1/4" DRIVE

THREE DRIVES	\$739
TWO DRIVES	\$569
ONE DRIVE	\$369

LOOK OUT FOR ADS IN AMIGAWORLD AND AMAZING COMPUTING

DISKWORKS PTY LTD 8/5 GREENWICH RD ST. LEONARDS 2065
Tel: (02) 436 2976 P.O. BOX 1437 CROWS NEST 2065

PRICES SUBJECT TO CHANGE WITHOUT NOTICE

SPIRIT™
TECHNOLOGY

DISTRIBUTED IN AUSTRALIA BY
DISKWORKS
PTY LTD

INTERNAL RAM EXPANSION FOR A500 AND A1000

* 1.5 MEGABYTES OF FAST RAM

* BOARDS AVAILABLE PARTIALLY POPULATED

* 12 MONTH WARRANTY

FEATURES

- All internal SPIRIT memory expanders will *add to any external memory* for a total memory of up to 10 megabytes.
- All SPIRIT plug-in boards mount under the FCC radiation shield.
- All SPIRIT plug-in boards provide AMIGA DOS 1.2 autoconfiguration and zero wait-state FAST-MEM.

INBOARD Software includes:

- RAM disk
- Recoverable RAM program
- Error trapping
- Disk utilities
- Memory test
- ... and more

ELECTRICAL SPECIFICATIONS:

Power Consumption: +5 VDC
A500/A1000: Maximum 3.15 Watts

The versatile Spirit INBOARD Memory Expanders can be used in full Auto Config, Non-Auto Config, large RAM disk, or RAM Off modes.

INBOARD 500

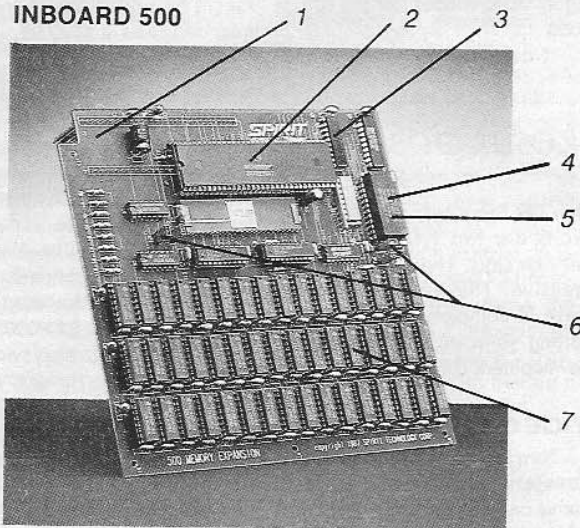

INBOARD 1000

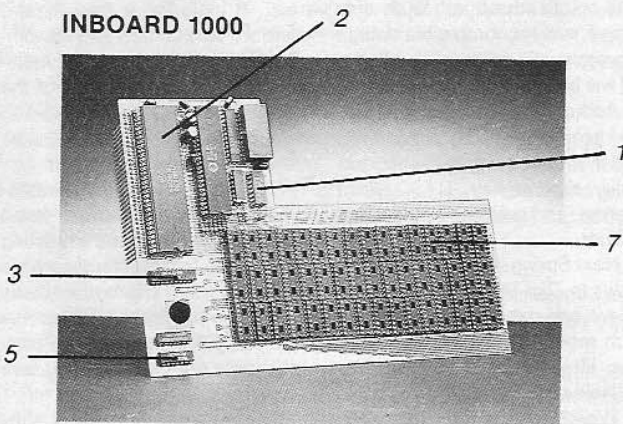

- ① Multi-layer PCB construction
- ② 68000 Processor socket
- ③ Data buffers
- ④ 2.4K battery backed RAM
- ⑤ Battery-backed clock/calendar includes leap year (optional on inboard 500)
- ⑥ Jumpers for memory configuration
- ⑦ Up to 1.5 meg - 48 DRAM chips, 256K x 1, 150 N.S.

1.5 MEGABYTES	\$799
1 MEGABYTE	\$686
1/2 MEGABYTE	\$573
Ø K	\$459

\$6 COURIER DELIVERY AUSTRALIA-WIDE

DISKWORKS PTY LTD

8/5 GREENWICH ROAD,
ST LEONARDS 2065
P.O. BOX 1437,
CROWS NEST. 2065
Ph: (02) 436 2976

DEALERS WELCOME

PRICES SUBJECT TO CHANGE WITHOUT NOTICE

Amiga new products

Report from COMDEX/November'87 Las Vegas

This was billed as the largest show of its kind ever, and it was. Over 100,000 dealers, manufacturers, distributors, and others from around the world spent at least part of the week at the world's biggest microcomputer show, November 2-6, 1987. COMDEX took over all halls of the Las Vegas Convention Center, plus the considerable convention facilities of Bally's Las Vegas Hotel, Caesars Palace, Las Vegas Hilton, Riviera Hotel, and Sahara Hotel.

The show featured some 53 conference sessions and over 1,600 exhibits. A daily 184-page newspaper and inter-hotel and convention centre cable TV network broadcast COMDEX news and interviews with participants, but the glut of information was impossible to more than partially absorb.

We brought back pounds of flyers, spec sheets, samples, catalogs, buttons, and even a 2-minute promotional videotape for the Amiga, produced by Griffin Bacal, Commodore's new US advertising agency. The tape features a song, based on the new slogan "Only Amiga Makes It Possible".

Commodore had the largest display area in the West Hall of the Convention Center, topped with the new Amiga logo, easily visible throughout the hall. Professionally assembled, the Commodore exhibit featured work stations setup by categories, to cover various interests such as desktop publishing, video, CAD, etc.

Although the Amiga 500 and 2000 were clearly the stars, I did notice a quiet area where Commodore was showing off new versions of their MS-DOS PC-10 machine.

It has a 14 inch wide footprint, and runs at three selectable speeds: 4.77 mhz, 7 mhz, and 10 mhz. The price hasn't been set yet, but will have to be competitive.

Sporting a "Not approved by the FCC" sticker, Commodore showed off their new 386 computer, the PC-60/40 with 5.25 inch 1.2 MB floppy and 40 MB hard drive, running at 16 mhz. It may be avail-

able by summer '88. Commodore got it there just in time for the show.

New monitor

One of the most pleasant surprises to see was the forthcoming A2024 Monitor from Commodore. It offers a stable 1,008 x 800 pixel resolution monochrome display,

"Only Amiga makes it possible"

and will work with all models of the Amiga.

All boards are inside the monitor itself, and all you need to do is install new custom libraries onto your Workbench disk.

Most Amiga software can already take advantage of the larger display area, and developers are being informed so they can correct any "problem" software. *City Desk* was up and running at the time. It looked great. Sometime in the first half of '88 you should be able to setup a professional quality desktop publishing station with a low priced Amiga 500 as the workhorse, providing a full page display and more at very high resolution.

Boards

We saw Commodore's "AT" Bridgeboard for the Amiga 2000.

It includes a 1.2 MB floppy, runs at 6 and 8 mhz, and should be available in early '88.

Another A2000 board caught our attention.

The 68020 card, possibly with a 68881 math co-processor already on board, will come with 2 MB of its own 32-bit dynamic (not static) RAM.

The final product may have a socket for an MMU (memory management unit), making it possible for you to run AT&T's UNIX operating system on an Amiga 2000. We believe Commodore is serious about this and is working on licensing rights for UNIX from AT&T.

This board will run at 14.3 mhz and will be available no earlier than February or March '88.

AmPVA

We also saw Commodore's AmPVA, being developed by the New York Institute of Technology. This is a broadcast quality genlock and frame grabber, supporting all video modes, for the Amiga 2000.

It consists of three boards.

One fits the video slot, the other two fit any two 100 pin Zorro expansion slots. The quality was impressive. The hardware is very close to completion, but the supporting software still needs more development time.

Video Toaster

NewTek announced the "Video Toaster" professional quality frame capture, genlock, and digital video effects system for \$799.95. It will be able to capture a full colour frame in 1/60th of a second, will let compatible Amiga software run in millions of colours, and will be broadcast quality.

Add-ons include: real-time image processing support, TMS 34010 video co-processor, pro quality chroma-key, NTSC paint program, and programmable video switcher.

Next Spring, expect to see upgrades to *Digi-View* and *Digi-Paint* that will add overscan support and much more. *Digi-FX*, NewTek's video effects software, should be available next Spring for \$99.95.

WordPerfect was showing off *WordPerfect Library* for the Amiga, due next March for about \$129. It includes a notebook, calendar, calculator, text editor, and a file manager.

Mimetics had their AmiGEN, formerly ImaGen, genlock device in action. The quality was quite good, especially when you consider its \$179.95 price tag.

B.E.S.T. Business Management accounting software is being upgraded again around January. The main addition will be a Payroll module.

NOTE: prices mentioned are in US dollars

Texture, MIDI music production software by Roger Powell, was shown for the Amiga at long last. It has been one of the finest packages in the MS-DOS world, and has been enhanced for the Amiga by Sound Quest, Inc. Announced price is \$199.95.

Colour laser printer

QMS, Inc. previewed a new colour laser printer based on a thermal process. This is a Postscript printer with very impressive quality output. The sample we have is fit to be the front cover of a slick colour publication. The price was not announced, but it should be close to \$20,000.

Gold Disk was displaying *Professional Page* for the Amiga, billed as "The Next Wave In Desktop Publishing". List price is \$399, shipping at the end of November. *Professional Colour Separator* will be available as a separate product.

We dropped by IBM's display area. It included a mini-theatre where we saw an IBM spokeswoman extolling the benefits of multitasking, something owners of the Personal System/2 will be able to do in the future when OS/2 will be released in its full incarnation.

The thing that was bothersome was that the spokeswoman sounded like IBM was inventing multitasking for the first time on a microcomputer. The button I was wearing on my lapel told the real truth. "Only Amiga Makes It Possible" now, and for the last two years.

There was a plethora of software and hardware for the Amiga, much more than we have room to even mention in this issue.

The Amiga is more than alive and well. The Amiga is thriving. We could see and feel the pride and enthusiasm of all of Commodore's employees and Amiga developers at the show.

It was interesting to see professionals in the industry "discover" the Amiga for the very first time. The Amiga's new slogan "Only Amiga Makes It Possible" could be subtitled "See And You Will Believe".

Amiga Review 14

The T-bag disk collection

A review by Eric Holroyd

THERE are several disk-based magazines available for the Amiga, including Australia's own excellent Megadisc, and I've seen quite a few of them in the 7 or 8 months that I've had my Amiga. All have something to offer and of course some have more to offer than others.

The T-bag disks from the Tampa Bay Amiga Group (T-BAG, get it?) have plenty to offer both new and experienced Amiga users as each disk contains some or all of these categories: Games, Graphics, Utilities and Demo programs.

I like this collection because it's easy to work with and because every edition I've seen has something that interests me.

Also, it's not at all expensive at \$5.00 per disk, or \$50.00 for a year's subscription. Those prices are in US dollars, and work out to approximately \$7.35 per disk or \$73.50 per year in Australian currency. Postage is included in the USA and I'm not sure how much extra (if any) is required for airmail postage to Australia but I recommend that you write and find out for yourself.

The address is:
Tampa Bay
Amiga Group,
c/o Jeff White,
1304 Four Seasons Blvd.,
Tampa,
Florida 33613, USA.

I have the complete collection up to number 12 and it's been a joy exploring them. I haven't yet been right through them all, and am currently up to about number 8.

Format

What makes them interesting is the format of the disks, which are self-booting after Kickstart is loaded and which support multi-tasking.

Almost everything can be controlled from the Workbench as all files run from icons and everything on the T-bag disks has documentation to teach you how to use it. The programs themselves are the best of Public Domain and Shareware and of course, some of them have been seen before on other

disks etc, but there's a lot that's new and interesting nevertheless.

Jeff White himself is quite an artist and there's a lot of his graphic work in the collection by way of pictures in the various slideshows and icons on some of the programs. One disk, #8, indeed has a special file called "Jeff's icons" and contains quite a number of really good icons for your own use when setting up your own disks.

The multi-tasking format has all the windows opening at the same place on the screen. This leaves the rest of the screen free for opening of other disk icons and copying files from one disk to another etc. To see the different windows just use the front and back gadgets to flip from window to window.

T-bag has set the disks up for DOS 1.2 and they use a Ram Disk icon. If you use a particular file a lot you may move it into the Ram Disk window

for super fast access. Picture files may be loaded this way and then by use of the front and back gadgets you can flip through the screens easily.

They recommend that you set up your workbench disks in the same way by using T-bag's drawers, suitably renamed for your programs, saying that once you become used to this system you'll find it very easy to work with and with two drives and some memory expansion it's even better.

CLI v mouse

The editor of the T-bag disks makes the point that if you've used computers before you're probably familiar with the CLI type of operation, but if the Amiga is your first computer then you'll be more comfortable with the mouse and icons.

In my case I'd never used

anything as complicated as the Amiga and felt happier (still do!) with the mouse than with CLI. Because of all this they decided on the disk format

and it works very well. If you're a dedicated CLI user then there's a CLI icon on every disk to get you into it if you wish.

The T-bag format therefore gives you the best of both worlds and even helps you to become more familiar with your machine by operating in this way.

Here's a small rundown on the contents of the first few disks:

T-bag #1:

Games: Yaboing, Alpha Puzzle, Flipper (Othello), Cosmiroids, Crystal Vision (mind-reading with a deck of cards and the Amiga)

Graphics: HiRes pictures, such as

Space Ship, and two Jeff White originals, Castle and Merlin.

Demos: Ball (pointer becomes an Amiga Ball), Sproing (six Amiga Balls bouncing around the screen), WClock (puts a digital clock in the workbench titlebar), Lens (magnifies the screen where the pointer is positioned), plus one called "150 windows" which makes that many windows on screen at once.

T-bag #2:

Utilities: FilePrint, DirUtil (di-



rectory manipulation utility), Browser (see directories), Note, Comm (modem program)

Videos: Made with *Aegis Player* and include Snapdemo (12 squares scrolling and unfolding to reveal a photograph. Amaz-

ing!), Knight (a knight charging on horseback with a lance. Very good, done by Jim Sachs of *Saucer Attack* fame), Bedroom (the knight and the lady in the diaphanous gown in front of the fire in *Defender of the Crown*).

Demos: Cube (blue cube revolving and zooming against a black background. Shadow work is great!), Rubik (a demo of the famous puzzle), 3D Stars (for which you need 3D glasses) and Moire (fabulous geometric patterns).

T-bag #3:

Graphics: Slideshow (tells how to make your own too by using their program and it's documentation).

Utilities: Font Viewer (loads all fonts from a disk to display them on screen), Dir Util III, Screen Saver, Cycle Pointer (colors change in your mouse

pointer), PopColours, DiskCat (a disk cataloger), ReAssign etc.

Demos: Boing 2 and Piano (keyboard).

I've catalogued several more but that should be enough to whet your appetite and give you an idea of what's available.

Write to the address above if you're interested in being a regular subscriber. It's certainly an inexpensive disk service for little more than the cost of a blank disk and cheap enough to cut out some of the unauthorised copying. Most Amiga owners should be able to afford this one. □

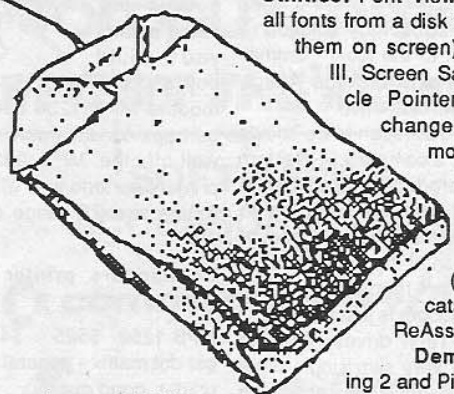
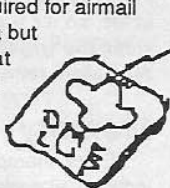

What to add to your Amiga?

by Adam Rigby

Once you've forked out the initial capital for your Amiga, you will probably be thinking of peripherals. External floppies or perhaps a hard drive, additional memory, modem and printer - all these extras give you a lot more power at, however, an increased cost. There are also good and bad buys.

What follows is an attempt to inform you about what is available for your Amiga at a reasonable price.

External drive

First let's start with what is a necessity to begin with - an external drive.

In case you didn't know, the Amiga is designed to have a disk with DOS commands in one drive - the Workbench disk. Using the CLI is very painful when using the internal drive only. If you wish to use another disk, you have to copy all the DOS commands to RAM and then access them through RAM - this turns out to be very long-winded.

The most obvious solution is to run down to the local Commodore dealer and buy the Amiga 1010 external disk drive.

But D-Tech (soon to be known as Omega), a company in Western Australia, produces a number of external drives for the Amiga which are both smaller and quieter. The reduction of the noise factor is most important to me as the 1010 from Commodore is just too loud.

The D-Tech drives range in size from a very slim single drive to a dual drive, which is about the same size as the 1010. The price of the single drive is \$349.

Diskworks also markets a competing drive for the Amiga, which sells for about \$349. A Tri-Drive, which they also produce holds up to three drives and has its own power supply. This unique drive comes for a very reasonable \$739.00.

The order of the next few purchases is a matter of the priority your requirements. But probably the next thing is either a modem or perhaps a printer. A printer would have a little more practical use to

begin with but modems are a lot of fun. In a business situation a printer is far more valuable for producing hardcopy of reports, accounting and documents. However if your primary use is for pleasure or hobby then perhaps the convenience of a modem could well suit you.

Printer

Anyway first things first, let's start with a quick look at some

printers.

Printers can vary in price from dear to ultra-expensive.

At the budget end of the market you could

buy a Commodore MPS 1250 dot matrix or perhaps for the more financially well-off, the MPS 2020. These printers perform well with both the Amiga and PC range of computers.

Commodore printer price list

MPS 1250 \$525 \$449 - Budget dot matrix - general purpose printer, good quality.

MCS 820 \$499 \$449 - Colour printer for Amiga, High quality results.

MPS 2020 \$1299 \$1199 - Extremely fast (300cps) high quality printing.

LP806 Laser \$3999 \$3699 - Commodore's laser printer.

Recently I had the opportunity to test a C.I.TOH 315 XP, and I was very impressed. The print quality was superb to say the least - in Letter Quality mode there was no way of telling that a dot-

matrix printer had produced this high standard. This printer is capable of emulating either an Epson FX-80+ or an IBM Proprint. This could be very useful if you have a number of computers at your disposal. Of course, the higher quality is worth more money - the 315 XP retails for about \$1800.00.

If you have the money to spend, a good quality printer will always find itself well used. The luxuries that go with the MPS

anything serious. Before anyone gets up in arms because they do use their modem for serious purposes, I must make a note that I have a modem and use it most of the time for nothing more than exploring BBS systems - only occasionally do I upload articles or do other practical tasks.

There are a number of modems available. The most valuable advice I can give you is that a Hayes modem is worth every cent that it costs. If you purchase a 300 baud modem, you find yourself pacing the floor for half an hour whilst a file is being downloaded - for a few extra dollars you can save a lot of time and perhaps some carpet wear.

Elsewhere in the magazine (in the Commodore section) there is a review of the Avtek Megamodem, which was tested with the Amiga for several days. The modem is very good value for money and works nicely with the Amiga. Also the Megamodem is produced here in Oz, so it's a good idea to consider the implications of buying Australian, rather than overseas.

Memory

Extra memory is very useful indeed - especially on the Amiga. Everyone knows that the Amiga is a powerful machine, but until you have seen it running three full programs at once you haven't seen its real power. It is astonishing.

Using the A2000 and three megabytes, we set up *Digal!* to ring up a BBS and download some software, meanwhile *Deluxe Music* played Hot & Cool Jazz whilst copy was typed on the PC side - thanks to a Bridgeboard. All this happened on one computer at one time. In fact without extra memory the Amiga loses a lot of its potential power.

The Spirit Board 1.5 Mb brings the Amiga up to a very useful 2Mb for only \$799 - this is available through Diskworks on (02) 436 2976. This would have to be one of the best quality, lowest-priced ways of expanding your memory capacity in one fell swoop. These are also available in one megabyte and half megabyte.

2020, and even the C.I.TOH, if you can afford them, are worth the extra dollars compared with the cheaper models.

Some people might say that the expense of the C.I.TOH and comparable printers is so close to the laser range, as to appear a waste of money. Well, there are other considerations to take into account, a laser printer is very costly to maintain. Anyone who has bought toner for their photo copier could relate to this fact.

In normal day to day use, toner needs to be replaced every five months. At \$240 a cartridge this represents a basic upkeep of at least \$500 p.a. If your needs require the power of a laser printer, then it is truly an amazing thing, but if not, a laser is a big overkill.

Modem

Back on the track, let's look at getting into communications. Modems are useful items that tend to be more for hobbyists than for

A + external drive +
printer + extra memory
= happiness?



MASTER YOUR **AMIGA**
WITH THE AUSTRALIAN
MAGAZINE-ON-A-DISC

MEGADISC

Numbers 1, 2, 3, 4 & **5**
5 AVAILABLE END OF JAN/

You'll get:

- * Indispensable information
- * How-to Tutorials
- * Free utilities & Programs
- * Reviews
- * Graphics and DeskTop Video
- * Desktop Publishing
- * Local Product updates
- * The latest from overseas
- * The best of Public Domain

and much more.

Ask your local dealer or order direct from:
MEGADISC DIGITAL PUBLISHING
P.O. BOX 759
CROWS NEST 2065.
TEL: (02) 959 3692

CONTRIBUTORS - Send programs, articles, re-views on disk and get 5 free PD and free MD!

★ Get any 4 issues of Megadisc for \$60!

SEND FOR subscriptions (\$90 for six issues), the Public Domain catalogue on disc (\$5) and Public Domain discs (\$5.50 each), as well as special compilations on specific themes: WP, GAMES, GRAPHICS, DEMOS-ONLY \$5.50

Ask about our Amiga Training Courses tailored to your specific needs with FREE PD software included in the training!

Send cheque or money order with your order for immediate delivery.

A1000 OWNERS - ASK ABOUT THE RAM EXP'N & HARD DISK UNIT

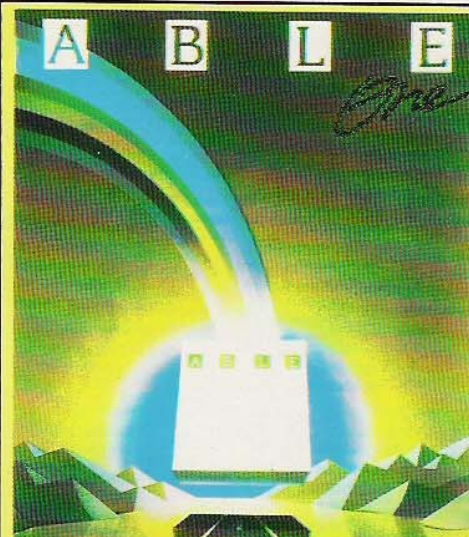

One

8 Powerful tasks for \$395

- Word Processing
- Spelling Checker
- Database
- Mail Merge + Labels
- Spreadsheets
- Graphics
- Communications
- Windows
- Price includes Tuition

"ABLE One is an absolute bargain.

It has the right range of modules and their sophistication makes a mockery of the price."

Australian Personal Computer,
April 1987: Revue of ABLE V3.2. Phone: 816 3700

Dealers Enquiries Welcome

'REAL TIME' ACCOUNTING

AMIGA + C64/128

BEST

IBM & Compatibles

"A TRULY INTEGRATED ACCOUNTING SYSTEM"

Order Processing	Inventory/Services Management	Purchase Orders
Invoice	General Ledger	Receiving
Accounts Receivable		Accounts Payable
Reports	Statements	Checks
	Reports	Reports

THE LOT, INCLUDING 6 HOURS TUITION : only \$995

WHAT THE EXPERTS HAVE TO SAY:

"It's a great concept, but how well does it work? The answer is brilliantly!"

"Boy is this system complete . . ."

"It is difficult to convey in print the exhilaration that comes from using the BEST system."

"The BEST Business Management system is an excellent piece of Amiga Business software. It is as thoroughly designed and executed as their other products."

"This program turns the AMIGA into an affordable accounting powerhouse".

"When I close my books for the Fiscal Year 1986, I plan to move my records into BEST."

Commodore Magazine, (US) Sep'87
Reviewer : Bob Lindstrom

Amiga World, (US) Aug' 87
Reviewer: Ted Salamone

DEVELOPED FOR THE AMIGA, NOW ON THE IBM PC, COMMODORE 64 and 128

Uses ALL Amiga options mouse, gadgets . . . even on IBM PC + AT!
Commodore 64/128 for \$149 ex Tuition

Redefines INTEGRATION:
1. BIG program, means no delays means no delays Stock, Debtors etc are ALWAYS up to date!

BEST Software

Dealers Enquiries Welcome

Fax: (02) 817 4129

P.O. BOX 215, GLADESVILLE 2111

Ph: (02) 816 3700

AMIGA SPECIALS

HARDWARE

AMIGA 2000 \$2495
IBM CARD \$1100
1084 MONITOR \$590
SCUSI CONTROLLER \$799
3.5 INTERNAL DRIVE \$299
A1000, A500 EXT DRIVE \$349
A500 MEM EXPANSION \$249
TIMESAVER \$145

SOFTWARE

VIZAWRITE \$199
PUBLISHER 1000 \$299
TEST DRIVE \$49
LOGISTIX \$199

**JANUARY 1988
CATALOGUE
NOW AVAILABLE
SEND BUSINESS
SIZE SAE TO
BLACKTOWN**

* PRICES SUBJECT TO VARIATION WITHOUT NOTICE*
* WHILE STOCKS LAST *

COMPUTERSCOPE

North Sydney
1st Fl Tower Sq,
155 Miller St,
Ph:957 4690

Blacktown
Shop 2,
1-3 Patrick St,
Ph:831 1718

(continued from page 24)

pretty much the same thing - life for a skater is never dull.

Rules for this game are simple - two go in, one comes out. You get five passes at your opponent, then he takes the boffing stick and the tables are turned. The first skater to score three slams on the other skater wins, but you have to be in front by at least two.

Right at this point in the game Mark decided to start singing. "Let's go biffing now, everybody's learning how. Com'on a biff safari with me."

I won't include any more of this musical interlude as it may be a health hazard for you and me both. I think he is homesick, poor guy.

Downhill race

It's a quiet day in the park. No bratty kids. No construction workers. No park rangers. No old men dressed up as clowns trying to lure young children with lollies. No pink elephants flying remote control gliders. Prime time for speeding downhill at a breakneck pace. Race against time and collect bonuses along the way. Skate under, through, on top of,

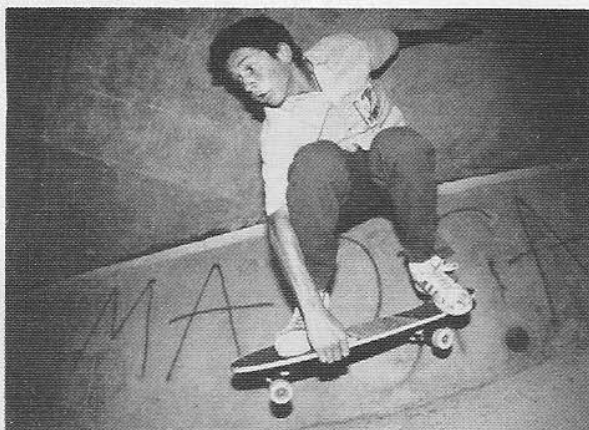
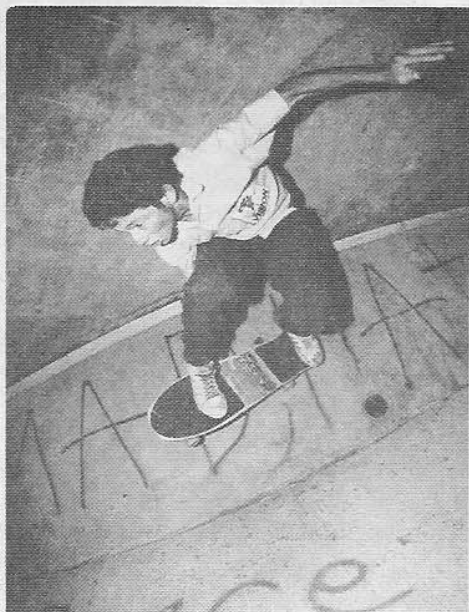

over, and along any number of "opportunities".

Downhill jam

Alley racing and mega destruction are the aim of the game. Pop soda cans, mash trash cans, bust a few bottles, crash flower pots and, hey, why not each other! You fight time and an unfriendly skater to reach the main street first.

The controls are like Downhill Race, with REGULAR and GOOFY foot options available. This time clicking while leaning the controller does the all the destruction work. Click and lean into the direction you're facing to punch, either high, middle or low depending on where you're leaning the controller.

Freestyle

There's a hundred feet of wood and steel, curved into a wide and smooth U-shape, just waiting for someone like you to try some incredible moves. Move the controller forward to back to choose your entry position. Sorry, no channel drops. The channel is slam territory in this event.

After you drop in, you'll have ten passes through the ramp, executing tricks at the left, right, or both ends. As you make a pass, click the button in the pump zones to increase your

speed and to select a particular trick. You'll also need to lean the controller either into the direction you're going or away from it.

This part of the game was definitely my favourite, with some really radical tricks possible. When a player is on the ramp the crowd watching him are in sympathy with his every move, eagerly awaiting the next unbelievable move that will be pulled off. Concerned faces watch the skater on the

ramp that holds him from a sheer twenty foot drop. Sounds dramatic? Well, it is, also it is extremely gratifying to complete a really difficult manoeuvre.

Highjump

Sheer guts event. No two ways about it. Go fast to get high. While you're in the ramp, move the controller rapidly in any direction to build speed - but you can

take a breather while you're in the air if you want. You get a maximum of five passes on the right side where the height marker is. Of course, you don't have to wait all five passes. To actually go for it and record the attempt, click and button at the highest point of your jump. If you time the click just right, your tweek will add a few inches. If not, it's time to bail.

As an ending comment, I would like to thank the producers, my manager, the cleaner and last but not least Tiger the Wonder Cat. Back on the trail of normality -

this a very professional piece of software, which will prove entertaining for many people as it did for the editorial office of ACR.

Skate or Die is produced and distributed by Electronic Arts. ■

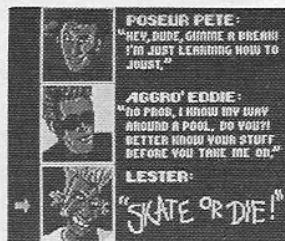

Flight Simulator II

Scenery disk 7 (C64 version)

by Peter Davies

I'VE BEEN a flight simulator enthusiast for as long as I've had a computer, and *Flight Simulator II* has been my favorite, ever since I was given a 10th generation pirate copy with no instructions.

I found my inability to 'fly' it correctly so frustrating that I spent \$90 just to get the instructions. And I've never regretted it.

As soon as I mastered the 'plane', I bought some scenery disks. If you like FSII you will love *Scenery Disk 7*.

For the money you get the disk, 12 pages of very clear instructions, suggested flight plans, four maps, and 115 pages of airport runway maps for 141 airports. Also the location and frequency of 130 VOR beacons, and ILS approach charts

for the 10 major airports. Not all of which are on the maps supplied.

If you don't know how useful those runway maps are, then load FSII, set coordinates N 15374, E 5805, and A 126 (L.A. International Airport). Now refuel

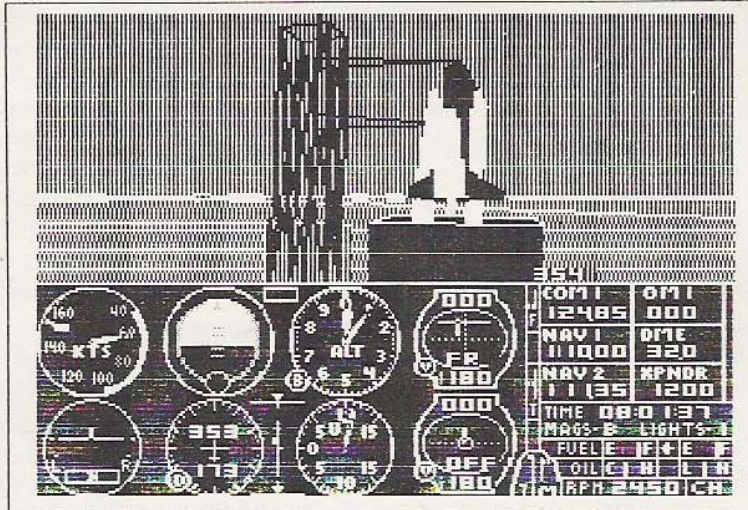

The space shuttle on its launch pad, Cape Canaveral

and take off on runway 11. At least with the maps you know where runway 11 is!

Scenery Disk 7 covers the east coast of the USA from Philadelphia to the Florida Keys; including Delaware, Maryland, parts of Virginia, North and South Carolina, Georgia, Florida, and the Bahamas.

Although FS II and Disk 7 are not quite continuous (there is a gap of about 20 miles) it is possible to fly from one to the other. Take off from J.F.K. International Airport on FS II. Turn to 240 magnetic, and climb to about 5000 ft. Two or three minutes after the disk access, swap over to *Scenery Disk 7*, and log in. Tune Nav 1 to 112.8 (Woodstown VOR) and set VOR 1 to 250. Use radar, and zoom out to the USA map. Fly down the highway until you get a disk access.

You should now be about 60 miles from Woodstown VOR. Flying on VOR bearing 240 should take you over Philadelphia, at the top of Delaware Bay. You can now either fly along the bay, or turn to 250° magnetic and fly over Baltimore and Washington. (Drop down to below 2,500 feet to get all the detail).

More features

In addition to the airports and beacons, the disk has more features than

The White House, Washington D.C.

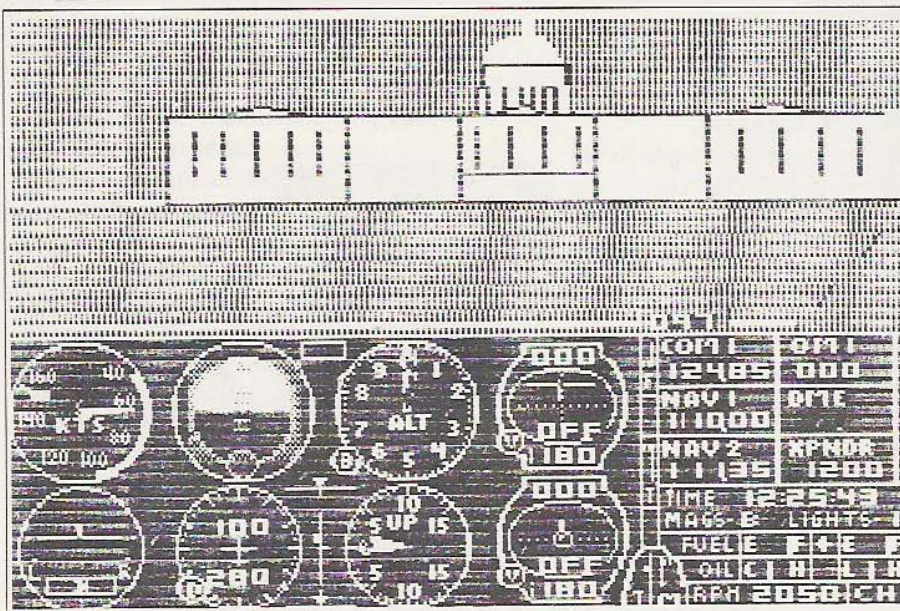

other scenery disks. The ground geography is very detailed, with many rivers lakes and islands marked. There is a very complex highway system, so if you have an atlas or a road map of the USA you can navigate by following the roads and railways. (It is not as easy as it sounds, but a lot of fun.) Some of these features are found on other scenery disks, but not in such detail or numbers.

Not all the rivers are marked on the maps, and none of the highways are, so I've spent many hours adding to the maps supplied. It will take several hundred hours to explore this one disk.

Unlike other scenery disks, and like the FSII disk, there are 'scenery areas' for sightseeing. The detail is better than FSII, but not as complex as the 'star' disks. None of the buildings are marked on the maps, but the instruction book tells you where to find most of them. It's too big to photo-copy, so eat your heart out, you pirates, you'll never find all the views!

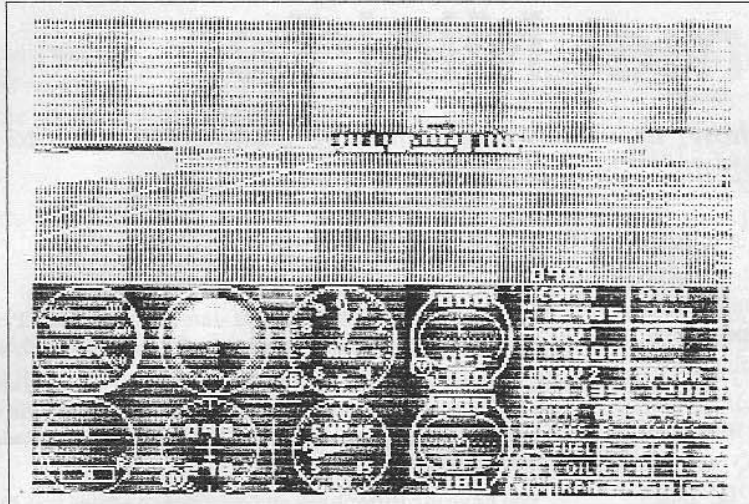

Capitol Hill,
Washington D.C.

Like FSII you can fly day or night, in all weather conditions. Night navigation over long distances (Philadelphia to Miami is over 1550 km as the crow flies) is a real test of skill.

There are a few features that I don't like with the scenery disks.

The radar will zoom out to give a map of the USA (great if you are lost), but it does a disk access; and another when

I've found a dozen or so buildings around Washington alone. I get a lot of pleasure beating up the White House. I'd love to do it with *Jet!*

The space shuttle on its launch pad is incredibly realistic. The shuttle landing strip is marked on the map, but not the launch pad. They are a long way apart, and, no, I'm not saying where it is.

I haven't completed all the recommended flights yet (there are 15, ranging from 30 mins to eleven hours) but I will, as they include most of the best scenery.

you zoom in, or revert to normal viewing; and the slow disk drive of the C64 makes frequent disk access annoying.

The small scale map of the USA is very useful, as it show the major highways. Flying down these highways will take you to most big cities, and this is an easy way to navigate cross country. Disk access aside, the improved radar view is very helpful.

When flying, only the nearby scenery is shown. As you reach the edge of the detail a fresh block appears, fortunately without a disk access; but it is disconcerting to see roads, rivers, airports and lakes suddenly appear on bare ground. Even worse, the bit you have just flown over often disappears. This makes ground navigation hard, but not impossible.

Like FSII, all the scenery areas require a disk access, but it seems to take slightly longer than FSII.

These are relatively minor problems, and don't greatly detract from the disk.

In short, *Scenery Disk 7* is by far the best of the scenery disks to date. If you like *Flight Simulator II*, then it is a must. ■

Central Miami.
Try flying around the sky scrapers.

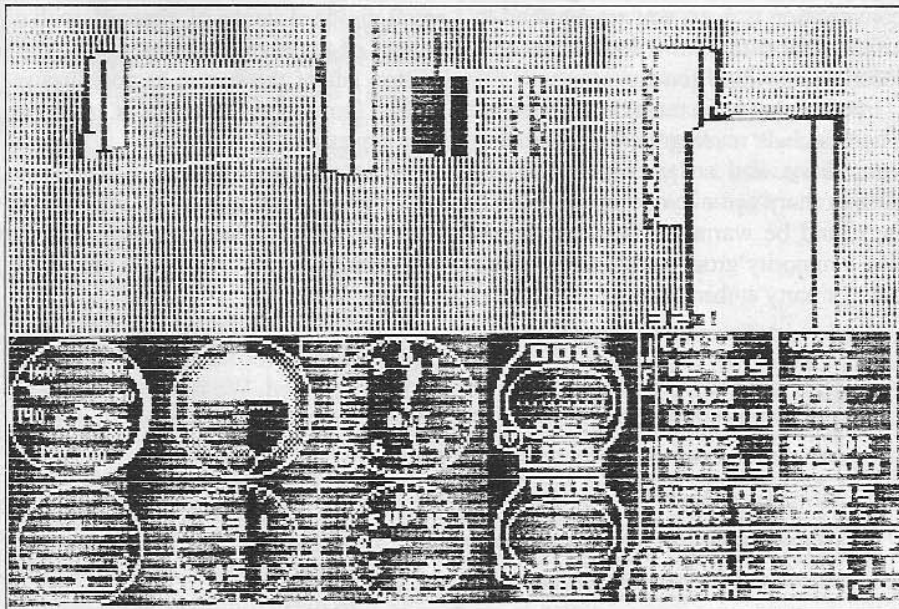

Yes Prime Minister

You've seen the TV show, now play the computer game. Often found watching the ABC himself, Andrew Farrell dived in at this game review.

I MUST confess, it was a brilliant series. Very few of the commercial stations ever offer much more than the across-the-street type drama, with all the false bubblyness that you'd expect from a soapie. If that's your style of evening entertainment, you won't like this game.

Yes Prime Minister is for serious people. As serious as politics ever is. Yes, almost smile-inducing, Prime Minister. This is hilarious. The public service exposed for all to see.

If you enjoyed the TV program, you'll be wrapped in the game.

So, that's the scenario. As the game LOADs, the usual caricatures are displayed as with the original BBC series. Shortly after, you're in your office. A small pointer controls all functions from here on. Plug the joystick in and you're ready to play - er, act.

As you move the pointer, the screen scrolls bringing new areas of the office into view. There's the British flag, an intercom system, two phones, a desk, with two drawers and other assorted attachments. Click on the appropriate item by pressing the fire button.

At times you will be called to the office of your colleagues Bernard and Humphrey. On more important occasions, there's even the odd trip to the board room. Matters are discussed in a conversational style. Your character answers spontaneously. However, the main thrust of the game is to be sure you make the right decisions. You will be helped a fair bit.

To make a choice, you will be presented with the options. Each one will be highlighted by a letter. Select the most appropriate answer us-



You've made it! As the Rt. Hon. James Hacker, MP, Prime Minister, you've reached the top of the greasy pole. But can you hold on to power?

Your aim is to steer the leaky ship of state through a turbulent week in Westminster. The opinion polls show which way the wind is blowing: will the nation present you with the ultimate accolade, or are you sliding into oblivion?

You have Sir Humphrey and Bernard to advise you, but your decisions are your own. Do you have the ability, the guile and the sheer political will to stay on top?

Will this do? Or should I mention the authentic real-time factors that keep the PM under constant pressure? Bernard

No. Reassure him by describing the extraordinarily imaginative interactive office environment created on the screen - he loves gimmicks. Humphrey.

ing the joystick or keyboard. When the conversation is over, you are returned to either your office, or a list of possible locations to which you can return.

Day to day tasks must be attended to. These include reading memo's, checking your diary, and answering the phone. Keep a sharp eye on your popularity ratings, and be warned. What may seem like a minority group can often turn into a major party embarrassment!

Graphics are more than adequate. A small digitised image of yourself, with a variety of facial expressions, appears in the top left of the screen as you discuss matter. Bernard and Humphrey are similarly depicted.

A very tactical game, that captures well the spirit of the BBC series. My only complaint is that side B of my disk was corrupt, and I could only play until Tuesday.

At the moment an Australian distributor has not yet been announced. We promise to let you know where it's available as soon we find out.

Recommended playing.

There, is a good deal of variation. No two days play the same, and there are many twists to every situation. ■

Graphics
Sound
Presentation
Playability
Overall

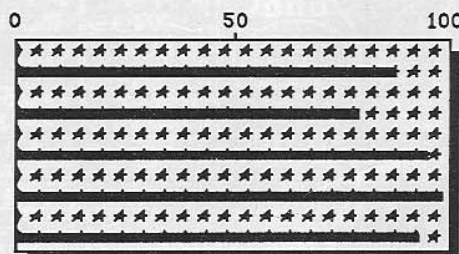

Using Easy Script

Part 2

by Eric Holroyd

THE response to Part 1 was encouraging enough for us to continue the series, in which we will endeavour to help you work your way to thoroughly understanding easy script.

In Part One I'd told how I set up my own version of *Easy Script* from my original disk using the Isepic cartridge. If you missed out on that article it's vital to the series, but luckily back issues are available from the ACR office. Phone Tristan on (02)398-5111 to organize it. (It was in the October issue.)

What I'd tried to show was how to set up a start-up file (this comes up as the startup screen automatically with my Isepic'd version) which you can create to set up all the common commands you're likely to need for most word processing jobs.

Don't worry if you haven't got an Isepic, just set up the file as I outlined it and save it to your data disk under the name "setup". Then, when you've loaded your *Easy Script*, press F1 then L (for load) and type "setup" on the status line. Your file should then load and you'll be ready to start work.

Document format

Document format will vary widely dependent upon the kind of work you're doing, but you'll mostly be using 66 line paper (US letter length) or 70 line paper (A4). The setup file from Part 1 allows for 66 line paper with an actual text length of 63.

You may like to vary the text length to accommodate bigger top and bottom margins to display headers or footers, page numbers etc. and we'll be covering that in Part 3 next month.

To make your text more readable you make like to vary the line spacing. This

is done with *sp1 to give one blank line between text and *sp2 for two blank lines. If you want to return to normal then *sp0 will do it.

Here's how to set up a letterhead to make your letter writing easier. Load your "setup" file, change the "nb" comment to "letter blank" then cursor down to the next blank line. Enter *ra1 (for Right Alignment) then your name and address in the following format:

John Q. Citizen
17 Apple Street
MARYVILLE NSW
2002
Ph (02) 324-5678

Press Return to give a blank line, then enter XX XXX XX (for date entry later), press Return again then enter *ra0 to cancel right alignment and enter "Dear XXXX,".

If you now do a video preview with F1/O/V you'll see the address at the right hand side of the screen when you scroll the viewing window across. It'll probably be a bit ragged and the way to line it up so that there's a nice neat vertical line at the left of the address is to use shifted spaces to "pad out" the lines all to the same length.

Cursor back up to John Q. Citizen and across to the end of the name. Hold down the shift key and press the Spacebar four times. The next line will need three shifted spaces, the MARYVILLE line is OK as it is so go to the following line and put three shifted spaces at the end of it.

You've pressed Return, of course, after each lot of shifted spaces so your screen should show a line of Returns (the less than sign) aligned vertically. If it doesn't you've used different spacings to those in my example, but it doesn't mat-

**Would You Buy a
HIGH TECH Product
from a LOW TECH
Store??**

- * Mail order by credit card
- * Mail order repairs
- * Professional help in choosing THE RIGHT product for YOUR needs
- * Trade-In
- * Finance/Commodore Credit Card
- * Open till 5.00 p.m. Saturday & 9.00 p.m. Thursday night
- * Sales tax exemptions - a specialty. T.A.P.

**GOOD PRICES TOO !!
PLENTY SOFTWARE**

ACCOUNTABLE COMPUTERS PTY LTD
11a Waverley Street
Bondi Junction, 2022
(02) 389 3419

ter as long as you now know how to adjust it.

Fix the date line the same way and video preview it all again to check how it looks.

If you now want to put the "ph" into italics as I've done on my own letterhead, then cursor to that line, and with the cursor at the start of the line, hold down Shift and press INST/DEL twice. This moves the text along to accommodate the italics command of Escape/4 as covered in Part 1. Now cursor past the "ph" and enter the cancel Italics command of Escape/5.

You'll notice that your shifted spaces have moved along four spaces but as the embedded Italics commands are not printed either to the screen in video preview or to the printer itself, then all's well.

When you're happy with the look of this page just press F1/F (for File) and the title of the document in the "nb" comment line will be saved to disk. You now have a file on your data disk which you load in and can use every time you write a letter. The dateline is in the correct place and all you have to do is enter 17 NOV 87 for example. Change the "nb" comment to something suitable, like "Mon 20 Oct 87" and you can save it in the same way as above when you've finished writing.

Loading

To load any of your files from disk you have two options.

If you know the exact filename you can load with F1/L and enter "filename" on the status line.

If you're not sure of the name press F4 to go to Disk Mode then +\$0 to load the directory. F1/L/F2 will then scroll a listing of the directory at the status line and when the right name comes up press Return to load it. Easy!

Incidentally, you may append one file to another quite simply by loading the first one and, with the cursor on the first blank line after this document, load the second one. (It's easy to put the cursor at the end of a document, F1/G/E means Go

to End).

Similarly, files may be merged by loading the first one, positioning the cursor at the spot where you want the merged file to go, press F1/I (for Insert) then load the second file. The text opens up to take the merged file.

Output was briefly mentioned above and is done with the F1/O command followed by the destination, either V for View or P for Print. If there's more than one page you should follow the "O" with "C" for Continuous and, in the case of output to the printer, an "X" if you want multiple copies. This prompts the status line to ask you to input the number of copies you want.

Disk functions

In "disk mode", which is entered with F4 as I said, and exited with Run/Stop, you have a range of normal disk functions like validate disk, rename a file, format a new disk etc. For the latter just enter "n0:diskname.id" and you'll get the familiar "Are you sure?" to which you enter "Y" or "N" as the case may be.

Don't forget that formatting a disk erases all data on that disk and that's the reason for asking if you're sure you wish to format that particular disk. It's too late once the process has started to salvage anything if you've made a mistake. To validate, or clean up, a disk that's had lots of saving and deleting, enter "v0" press Return and wait a little while.

Renaming is simply a matter of entering "r0:newname=oldname" and press Return. To delete a file enter "S0:filename" and Return.

There are two distinct commands for loading a disk's directory. The first one displays the directory on screen without disturbing the text in your computer's memory and is obtained with F4 then \$0. The second one is the one I described above, F4 then +\$0, and is used for "shortcut loading" of files or printing out of directories for reference purposes. Printing, of course, is done with F1/O/P.

Printing

There's a lot of control available to you when printing your documents. For instance you may specify how many lines per inch you want printed with the command *lpXX (where XX is the number of lines required).

Some printers don't generate a linefeed with a Return and if yours is one of these then specify a linefeed with *lf1 in your setup file. (Substitute 0 for the 1 to turn off linefeed if you need to). Also, some printers allow you to do a Backspace and if yours is one then F1/backarrow (next to the figure 1 at the top left of your keyboard) will do it.

Pitch may also be specified with *ptXX where XX is 6,8,10,12 or 15. If nothing is specified then *Easy Script* prints at 10 characters per inch. If ever you need the English pound sterling sign then F1/\$ should print it for you.

If you decide after typing in your text in upper case that you want a certain section to be printed in lower case then use F1/U with the cursor over the first character which you wish to be printed in this way. Cursor to the last character to be treated this way and again press F1/U. The text will then change between the markers and revert to the original after the second marker.

Forced pages

Sometimes your text will work out so that a new paragraph is just starting near the bottom of a page and may only print one or two lines before going to the next page. Under these circumstances you'd be better to make a "forced page" with the command *fp so that the new paragraph starts on the new page. You may indicate a specific point at which this is to happen by using *fpXX meaning that *Easy Script* will start a new page if there are less than XX lines remaining. This is handy if you've added a bit more text higher up in the document and aren't sure where it's all going to end up. I've used a number of Returns sometimes to "make the document fit" but that's very expensive on memory and it's

(Continued on page 32)

Don't miss out on these great bargains!

Australian Commodore Review Disk Mags Nos 1 to 7

Disk Magazine One

Features:

Forest Raiders - Full machine code shoot 'em up
Machine code paint, border, input and flash routines
Nice Lister - for readable listings on non-Commodore printers.

Recover II - for recovering deleted files,
and a catalog program - for getting a disk directory without losing your program

And More...

Disk Magazine Two

Features:

Programs demonstrating 3D graphic plots
A terminal program called Teleport
A tutorial on bits and bytes
Character editor - for designing your own custom alphabets and graphics
A full demonstration of Electronic Card File

And More...

Disk Magazine Three

Programs:

Hangman	Labyrinth
Calendar	Finance
Typing Practice	Roadblock
Bird Invaders	

Features:

Constructabrix - education and graphic construction program for younger users

And More...

Disk Magazine Four

Special Issue

Featuring:

Graphic Workshop - a complete design system for sprites, graphics, and character sets - with tutorials

Also:

Typing Tutor - a complete typing program
Works on errors, counts your speed

And More...

Disk Magazine Five

Our Biggest seller yet...

Featuring:

Utilities for using Newsroom on an MPS 802 plus printing disk cover with directories, writing signs, printing Doodle and Printshop pictures and more all on the MPS 802!

A demonstration of games in the future

And More...

Disk Magazine Six :

Featuring:

Games:	Home Inventory
Bert the Bug	Graphics:
Hangman	Light Fantastic
Demos:	Utilities:
Amiga Pharoah	1571 Utility
Space Harrier	DIR@828
Max Headroom	Disk Filer
The Pacer	Sade
	<i>And More...</i>

Disk Magazine No 7 - double sided, with some 128 software too - Featuring:

Utilities: Anti-Isepic, Sledgehammer, Fast Format, Renumber, PS/PM/NR, PS Printer, Graphics Editor.

Other: Joystick Tester, Irish Jokes, Convertor, Ultimate Writer, Home Finance, Oscilloscope, Dice Roller, Chord Maker, Dark Forest, Don Martin, Funny, Music Classics. **Demonstrations only:** Karate Kid II, Thrust Concert, 3D Demo, No More Heros, Recursion. **For the 128:** Bootmaker 128/64 Utility, Convert Basics utility.

Order Form

Name: _____
Address: _____
P/Code: _____
Cheque: _____ Bankcard: _____ M/O _____
No: _____
Expiry date _____

Please send me:

_____ copies Disk Magazine No 1 @ \$10
_____ copies Disk Magazine No 2 @ \$10
_____ copies Disk Magazine No 3 @ \$10
_____ copies Disk Magazine No 4 @ \$10
_____ copies Disk Magazine No 5 @ \$10
_____ copies Disk Magazine No 6 @ \$12
_____ copies Disk Magazine No 7 @ \$12
PLUS \$2.00 P+P TOTAL _____

Post to:

Australian Commodore Review
21 Darley Road
Randwick, NSW 2031

OR Use your Bankcard and
call us to order on:
(02) 398 5111

Please allow two weeks for postage and delivery

far better to specify the exact number of blank lines you need with the *bLXX command.

Columns

Easy Script will print your text in columns just like a newspaper if you use the Offset command *ofXX. The XX this time indicates the distance in number of characters from the left margin, ie printing will commence at the column that is the distance of the offset plus the left margin from the edge. You'll have to rewind the paper back to the top of the sheet to do the second pass.

It's worth a bit of experimentation on this one as your club newsletter or sales report etc could be considerably enhanced if printed in columns. You may also use the Vertical Offset command *vpXX where XX is the number of lines required say, on the title page of a document or the first page of a chapter. Turn it off for subsequent pages with *vp0.

There are a number of ways in which you may modify or delete unwanted text. The most common would be the Delete key itself which takes out the text and closes it up again automatically. To delete the character to the left of the cursor press the INST/DEL key. Holding it down will continue to delete characters until it's released. As they're deleted the text is adjusted so that no gap is left.

The opposite of this would be the Insert mode whereby you may enter new text at the cursor position with existing text opening up to accommodate it. Use F1/I for this mode. To delete the line at the cursor position press F1 then INST/DEL. Again, holding the keys down continues deleting lines until they're released. End the Deletion mode by again pressing F1. Inserting a blank line(s) is done similarly by holding down the Shift key then pressing INST/DEL.

The Erase command differs from Delete in that space is left where the text had been. To erase a character simply overwrite it with a space. Holding down the Spacebar erases everything until released. To erase a whole sentence use F1/

E (for Erase) then "S" for Sentence. This command erases everything to the next terminator and the text will not close up.

Exclamation and question marks are not recognized as terminators in *Easy Script*. Erase from the current cursor position to the end of paragraph marker (the less than sign) use F1/E/P (for Paragraph) and a space will appear where the text had been. To erase from the current cursor position to the end of the text use F1/E/R (for Remainder). To completely clear the screen use F1/E/A (for All).

would insert a hyphen after "fanfold" and put "paper" on the next line.

Tabs

The last thing this month is "tabs". These are used when working in columns of figures or statistics and are indicated with F1/T (and the status line displays Set Tabs) then H (for Horizontal) after positioning the cursor where you want the tab to be. Do this as many times as you wish across the screen and you may then move instantly to any position by

**“Your newsletter or sales report
could be considerably enhanced if
printed in columns.”**

Sometimes you may prefer that a phrase be treated as one word when it's printed and that it all appears on the same line without being broken up onto two lines. To get this effect, make a "linking" space with a shifted space as you did when setting up your letterhead. This will be shown on screen as a block joining the words together but it will be printed as a normal space. Note however, that if you make a linked phrase which is longer than a printed line *Easy Script* will have to break it onto the next line anyway.

If you type with the Shift/Lock key down to use upper case then all spaces will become linking spaces which could result in formatting problems. The correct way to get upper case is to use F5 which results in the status line displaying "Capitals On". F5 will turn upper case off again when you're ready. Hyphenated words are treated as a single word and you may get formatting problems with these too.

To ensure that hyphenation is carried out properly use a "soft hyphen" which is inserted in the text at the appropriate place with F1/- which then comes up on the screen as a thick line. If you entered "fanfold/F1/-/paper" the word would appear as "fanfoldpaper" if it would fit on one line but if not then *Easy Script*

pressing F7 to move through the various spots you've just specified or F8 to move to the tab directly below. This is known as setting tabs at columns along a line and you may specify Vertical tabs by using "V" instead of the "H".

To work with decimals and ensure that all the points are in line you may do this too. First of all press F6 to indicate to *Easy Script* that a tab is to be decimal (status line displays "D") then set the tab normally as already indicated. To display tab positions use F1/P and normal tabs will be shown on screen with a "/" whilst decimal tabs will be "#". Vertical tabs can not be displayed. To clear tabs from a document use F1/C (for Clear) and the status line will show "clear tabs" to which you have to enter "H" or "V" depending on what you're clearing. To clear all tabs use F1/Z (for Zero all tabs) and again you must press "H" or "V".

To save a document to disk and include the tab settings simply put a "+" sign at the end of the filename. Tab settings will still be there when you come to reload the document next session.

That's plenty for now, I hope you can use this new found knowledge to your advantage. Watch out for part three in this series. ■

Those black and white blues

by Andrew Baines

Ever wondered how to make that old black and white set display your 64's welcome power-up message? Andrew Baines opens up the inside of your ailing black and white.

WHEN we first bought our Commodore 64 in 1983, we plugged it into our black and white that's almost as old as me. We tuned in to channel one, powered up, and watched a fuzzy, faint signal on the screen scroll crazily up and down. No matter what we did, that picture was determined to stay.

In desperation, we read the manual. Now, normally the first time any manual is read, it is skimmed over very quickly and replaced in the box to die. This time was no exception, and it took us several reads before we came up with the answer.

VHF, UHF and FM

Back in the days of the introduction of television to Australia, the Federal Government decided, "VHF". So all the manufacturers of televisions made VHF televisions and the stations started transmission on the VHF band. VHF stands for Very High Frequency, and is what every television station except SBS is received on.

Then the AM radio band outgrew itself and rumours from overseas of stereo radio helped the Federal Government to decide to introduce FM radio. Immediately sales of FM radios went through the roof, with all the FM station's ratings quickly following.

By now, you might be asking, "What has this got to do with the black and white telly?" Everything. The Government, in all their wisdom, did not foresee the huge growth of the stations on the FM band. The result of all of this is we have UHF television, as the FM band is smack in the middle of the VHF band, interfering with channels 3, 4 and 5.

By 1990, all stations transmitting on these channels must have changed to UHF. The Government has even thought of telling the television manufacturers, and they have started to include UHF in their new sets, just a little late for the Commodore 64.

Let's face it, prices of anything these days are exorbitant, outrageous and totally unrealistic. Computers are no excep-

the answer most computer manufacturers have come up with is to put an RF modulator in to make, in effect, the computer a closed circuit television station (like the American cable services) it transmits on UHF (I've forgotten which channel).

Most Australians have a television, however old, tired or worn out. Television is big business, the recent media take-overs are testimony to this. Unfortunately, this has (helped by lots of other things) brought about a tremendous rise in the price of television sets. Even I remember the days when \$300 would buy the best 34cm colour set around, \$75 the best black and white (back then UHF hadn't been included in the set). Now you're looking at \$500 and \$200. Ridiculous prices.

Death of the black box

The way to get around buying a new set is to make a UHF to VHF down-

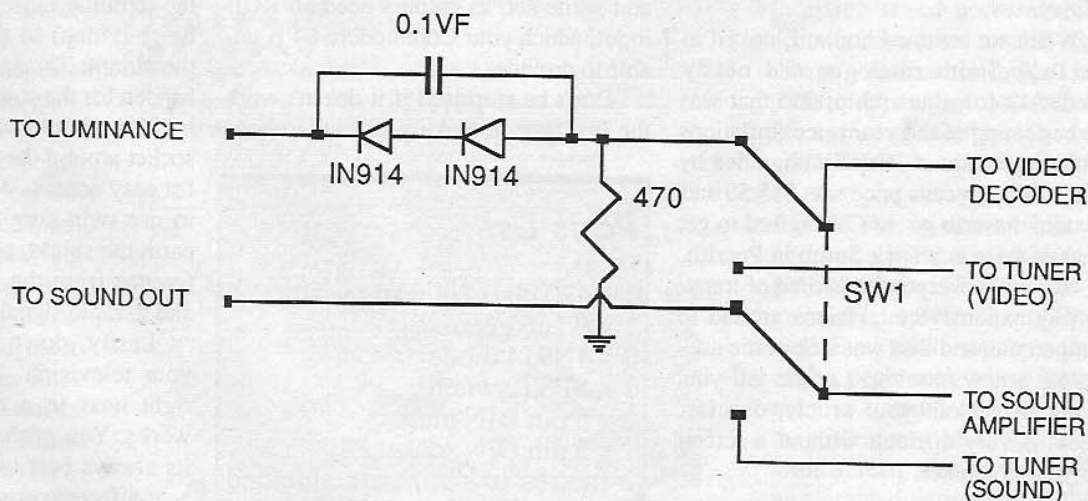

tion. Money for a monitor is scarce after the purchase of a computer, disk drive and printer (if you ever get that far). So

converter (maybe I got it wrong, I'm sorry if I did). That's exactly what we did for our black and white. And for three years

we put up with its continual insistence on distorting anything brought near it, radio signals, television signals, not to mention the computer signal.

It was not a particularly scientific device, only a black box, originally a Dick Smith kit. It had been through some very bad times, mostly when the tuning went out, and you had to literally pick it up and bash it against the desk to make the silly thing work again.

Then one day we took it on holidays with us, as is our habit. After setting the computer up, powering-up and finding that desk-bashing wasn't helping, Dad bought some solder from Ulladulla's Paul's Electronics to fix the culprit connections within that black box.

Solder needs a soldering iron for application, and \$12 seemed a little excessive for one job when we already had three at home. My Dad's the sort of person who can get around any problem to fix anything. So, the stove went on 'high', and an old nail was heated up as the soldering iron.

Normally, this would have been fine, but right next to a very heat sensitive integrated circuit it was far from all right. That was the end of our converter, and also to the use of the computer for that holiday.

When we returned home, I looked in the Dick Smith catalogue and nearly cried. \$12 for a new chip, and that was the beginning of the year price (inflation tends to hit hard at Dick Smith, aided by our dollar). Jaycar's price was \$15.50 and I would have to go to Carlingford to get it when there is a Dick Smith in Penrith.

By now, everyone was tired of transporting expensive televisions around to compensate, and Dad was sick of me asking for a new monitor. Let me tell you, trying to get out your article, due last week, is very difficult without a screen for your computer.

Bypassing the tuner

As a last resort, I went and asked a friend of mine what he did to make his Microbee, with no RF modulator, shine

its power-up message so constantly and without interference. He told me he had had his tuner bypassed, and gave me a small circuit. Overjoyed, I took the circuit home, and am now staring at the results on our old black and white.

The only problem was that the circuit he gave me required tapping into the circuit boards of the television to get to the video decoder. For those who don't know much about how the electricians work, but know how to make something out of electric parts and then make it work, this doesn't mean a thing. So I took the circuit diagram of the set (usually inside the set) to him, and he pointed to a spot on the diagram.

I suggest if you've got a friend like that, who understands how things work, get him to point out the video decoder to you, or try at the local television repair shop. If possible, get two or three opinions, to make sure.

Next step was to ask Dad if I could open his television. 'Only if you put a switch in so it can be a monitor and a television set,' was the reply. So, below, a complete circuit diagram and parts list is laid out (and it only cost \$6!). Please note that this will only work for a black and white set, as colours need an RGB input, which your Commodore 64 is unable to provide.

Don't be surprised if it doesn't work the first time, it took us three afternoons

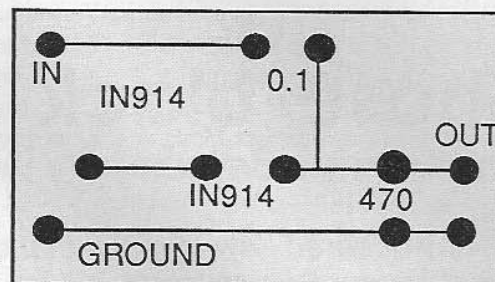

PC Board

of rewiring to get it right, but it was definitely worth it. Now I can flick the switch and watch the cricket while the printer is rattling out this article (something I've always wished I could do).

There are two connections to the Commodore 64, both come from the audio/video port, between the serial port and RF output. A diagram of the back of the plug is shown, for easy soldering. One connection is luminance, and the other is sound out.

On the television side of the circuit, you have to break into the television's circuit in two places; on our black and white, on to the volume control, the other to one of the circuit boards. Basically, you desolder the required wire or part (one connection only), and connect the video decoder line from the new circuit to the terminal closest to the tube, and the tuner (video) to the other one, closing the circuit. The same sort of thing must happen for the sound.

You should mount the switch and socket around the front of the television, for easy access. When wiring be careful to use twin core shielded wire, and to earth the shield, as this minimizes interference from the disk drive and printer and to radio signals.

Lastly, don't be afraid to desolder your television. We did several times right next to a transistor, which still works. You probably shouldn't do that, it's always best to put heatsinks on any heat-affected parts, just to make sure.

Anyway, after a bit of fiddling, the picture comes up crystal clear, much better than the bigger colour sets! Happy soldering! ■

Parts List

- 1 x 470 ohm 1/4 watt resistor
- 1 x 0.1uF ceramic
- 2 x 1N914 diode
- 1 x SPST switch
- 2 x 5 pin DIN plug
- 1 x 5 pin DIN socket
- 2 metres of twin core shielded wire.
- 1 x circuit board

What's the offer?

Any four disks for just \$30!

Public Domain Software Saturday Computer Services

Following the success of our special disk offer, we have decided to provide a new service to readers of *Australian Commodore Review*. Each month we will publish an up to date listing of our catalog. There will also be a more detailed listing of what is on one particular disk. You will be able to order any four disks for \$30.00 - that's including package and posting. Simply fill in the order numbers of the disks you want, and enclose a cheque or money order for thirty dollars made payable to Saturday Computer Services. Send to Public Domain Software, 19A Frederick St, Putney, 2112. Your order will be dispatched the same week we receive it.

Administration	AA	Mathematics	MH
Business	BA	Mathematics	MI
Business	BB	Mathematics	MJ
Computer Science	CA	Mathematics	MK
Computer Science	CB	Mathematics	ML
Educational	01	Mathematics	MM
Educational	02	Mathematics	MN
Educational	03	Max Subroutines	99
Educational	04	Miscellaneous	MS
Educational	05	Miscellaneous	MT
English	EA	Science	SA
English	EB	Science	SB
English	EC	Science	SC
English	ED	Science	SD
English	EE	Science	SE
English	EF	Science	SF
English	EG	Science	SG
English	EH	Science	SH
Francais	AF	Technology	TA
Games	GB	Technology	TB
Games	GC	Utilities	UA
Games	GE		
Games	GF		
Geography	RA		
Geography	RB		
History	HA		
Mathematics	MA		
Mathematics	MC		
Mathematics	MD		
Mathematics	ME		
Mathematics	MF		
Mathematics	MG		

I need more information!

No problem. Send the form below with NO MONEY and we will add you to our mailing list. Next month we're sending out a catalog crammed with goodies too hot to mention on these pages!

Call Us for top prices on blank disks, stationary, and office products.
Phone (02)808 1860.

*Limited Offer : Single Sided Single Density Blank Disks
In packets of ten, with labels and write protect tabs. NO DISK
BOX YOU WON'T USE!! - Price not to be beaten - \$18.95.
Reflex Photo Copy Paper - Great for friction feed printer on
screen dumps, letters or even for photocopying! -
Box of 500 Sheets only \$15.00.*

Detach and send to : **Public Domain Software**, 19a Frederick Street, Putney 2112

Name.....Address.....

.....Post Code.....

Daytime Phone.....Disk Required.....

Cheque or Money Orders Only payable to Saturday Computer Services!

Call (02) 808 1860 Now to reserve your order.

Superbase 64/128

by Peter Gallen

In this, and hopefully future articles, I intend to concentrate on practical aspects of using database managers and, specifically, Superbase, arguably the best designed for the C64 and C128.

Why a database manager?

THERE ARE a host of "database filers" or "record managers" available for the C64, so which do you purchase?

If your needs do not extend further than very simple applications, eg. name and address lists, then maybe Superbase is overkill and one of the "electronic card" type of databases is what you need and will satisfy your requirements. However, I suspect that as your files grow you will want to add extra fields or expand existing ones. Alternatively rearrange the whole system or link to a word processor.

To do these things you need a database manager. Even in this higher-price category there are several from which to choose. Essential requirements in this category include fast access to records, ability to totally reorganise the file structure as your needs dictate (designing database files is the most important step).

Next, you may need to import or export data to be used with word processors or terminal communications programs. If the inevitable crash or data corruption occurs, retrieval or reconstruction would be desirable (if not always workable).

It is in these categories that *Superbase* excels. It is also programmable - which means you can set up total applications, eg. accounting records for a small business.

Just think of the fun (and heartache) you can have writing your own programs to allow you to handle information the

way you want to, not the way someone else thinks you want to. It is a fact of life that few, if any, programs bought off the shelf will meet all your requirements. *Superbase* doesn't pretend to. It allows you as much control of its functions as you desire.

I have recently written an accounting package for my wife's business, eg. clients' details and invoice records. The beauty of *Superbase* is that for the first few months it operated with an absolute minimum of programming. This consisted of linking the two files for invoices to be printed. Since then it has grown into a complete set of programs to control all aspects from initial screens and menus to editing records and statement printing, using two disk drives.

This is the beauty of *Superbase* - it is truly "user friendly" in that you can have as much - or as little - programming as you require. Another feature is the compatibility between the two systems: I wrote and tested this application on my C64 for use on my wife's C128 - the only modifications were in screen design to accommodate the change from 40 to 80 columns.

An interesting fact I discovered by accident is that *Superbase* V.2 programs will run on the C128 in 40 column mode with NO changes. This is great for anyone updating to the C128 with its faster disk access and sorting times.

Starting out

I'll now assume that you have decided

to use *Superbase* and have read through the manual and attempted the tutorials. If you haven't, you have until next time to do so and if you have, you are probably confused but also intrigued by the capabilities of *Superbase*. It took me several attempts to come to grips with *Superbase* after using simpler "electronic card" systems, so don't be put off.

A must for serious programmers is *Superbase The Book* by Dr. Bruce Hunt, published by Precision Software. This book attempts to take you beyond the use of the already powerful menu functions into creating programs. Whilst I continue to find it invaluable, it is not an applications manual with programs ready to type in and run. I have three copies in various states of decomposition (I endorse Paul Blair's comment that computer books should have spiral binding!)

Dr. Hunt did not set out to provide an applications manual. What he has done, and very successfully, is provide short sections of code, fully documented, to solve particular problems. Your challenge is to think of uses for these various routines and incorporate them into your programs.

And this is where we come in. Not everybody has the time or patience to apply abstract programming routines to their own problems. Often one short routine can be applied to many different applications.

A brief example is in setting date formats: the manual tells us that dates can be treated as special numeric field types (and I still get a kick when the screen displays the day of the week when you type in the date). However, dates can be entered in two ways, "01jan88" or "jan0188". This won't usually cause a problem, unless you need to manipulate

the date as a text field in testing for some particular condition.

An example would be to test if the date corresponds to a requested month.

One way to test is to use MIDS (DATE\$,3,3) to obtain the month, but this will only work if the date is in the format "01jan88". OK, so you enter your date in this format and all goes well until the time you forget or someone else uses the program and enters "jan0188". Superbase will accept this as a valid date and things proceed until you do a search and don't get the results you expect!

To overcome this, it is best to insert the following into the system parameter section of the "start" program: 'xxxdate = "01jan88" '.

But, I have recently found that even this will only solve the problem in program mode, not direct mode. For some reason, Superbase will change (in direct

mode) previously entered dates to correspond with the last date format entered. I apologise for that digression, back to setting up our first database.

Setting up your database

Right. You are now comfortably seated in front of your computer, Superbase is loading and the manual is at your side. What is the first step?

TURN OFF YOUR COMPUTER! Yes, as I stated earlier, the most important step is to map out your database system. Until you have your thoughts properly focussed on what you want to achieve and how your reports should appear, don't turn on the computer. A few hours or even days spent designing your screens and files will save you much heartache and work later on.

And, when you think you are ready, set up a trial and enter some test data. Keep it simple, but try to cover extremes and also try to recover the information you want using simple searches and screen outputs.

I spent three weeks designing and testing different formats for a record album collection database before I was satisfied that it would do what was required.

Next time we'll work through the design of an address file and progress towards linking two files to save double entry of data and disk space.

If you have any suggestions for topics or application problems, please share them and maybe a Superbase applications forum will eventuate. Write care of Australian Commodore Review or direct to P.O. Box 115, Rozelle NSW 2039. ■

Dealer Directory

Cockroach Software

PO Box 1154, Southport 4215
Phone (075) 324028

Cockroach Turbo Rom \$42.00
including postage

Cockroach Graphics Utility \$69.95
including postage

UPPER YARRA VALLEY & LILYDALE COMPUTERS

7 Castella Street, Lilydale, Vic 3140
Phone: (03) 735 3734

We stock:-

- * Commodore Computers
- * Wide range of software
- * Joysticks
- * Disks
- * Latest Games

and Micro Accessories products

Everything you need for your computer at a reasonable price and with friendly service.

NASHUA DISKETTES CHEAPEST IN TOWN

5 1/4 DSDD \$17.50 + P.& P.
3 1/2 DSDD \$39.00 + P.& P.
Quad Density and 8 inch call

Printer ribbons made like new

I will re-ink your old fabric ribbons for less than half the price of new ones!
e.g. Epson \$4.00 + P&P

Phone Now

9 a.m. to 5 p.m. (047) 36 3364
After 5.30 p.m. (02) 636 2080

C64/MPS-802 Publisher

by Andrew Baines

MOST new printers come all stylishly packaged, with plenty of different fonts or typestyles, more than capable of producing the most sophisticated of graphics, and are very, very fast. This usually makes all MPS-802 owners very green with envy, and means their computer and printer is used less and less as they grow tired of using something they know is simply not up to scratch.

But now, with this new software package, your 802 sings with delight while you reap the benefits of the superb graphics and Macintosh quality Near Letter Quality fonts it will easily produce.

There are six main programs on this disk, all playing a different part in the formation of your published page. All are loaded with and use a fast-load system, which sits over the Kernal (the Kernal is switched out).

To copy this loader to your own disks, use a file copier to copy 'qd' and 'qdsys', making sure that they are the first two files on the disk in that order, and that the file you want them to load in first is called 'menu'. Be careful if you change the video bank, as using this loader puts it back to the default.

Near Letter Quality Printout

The first program, Near Letter Quality Printout, turns your MPS-802 into a real text printer. There are two different fonts available, with the NLQ Designer providing you with the ability to design your own, save them to disk and print your next masterpiece of verse or prose in your newly created font.

NLQ Printout takes a fair while, as it has to read the file from disk, find where that character's data is in memory, add it

to the buffer, and when the buffer is full, print the line. All this may seem tedious and very drawn out, but a patient person will find the results are worthwhile.

EasyScript or compatible files are required to ensure no garbage appears in the printing process caused by useless control codes. There are two variations of the normal text available. Both of these must be embedded in the text of the file. One is underlining, which is obtained by (while using *EasyScript*) pressing [F1]/[shift][8] to turn it on, and [F1]/[shift][9] to turn it off. The other is enhanced text (double width), and is turned on by pressing [F1]/[shift][:] and off by pressing [F1]/[shift];.

Enhanced text symbols must be placed on the lines before and after the desired text by themselves. This means that the whole line will be enhanced.

Underlining and enhanced text may not be combined, but underlining may be placed anywhere within the text, and it will only affect the text the symbols surround.

Upon booting, you will be asked to insert a font disk. If you don't want to use one of the ones supplied, I suggest you copy all the files associated with the NLQ programs to another disk, as there isn't much room left on the *Publisher* disk, and after loading the font, the program is loaded straight away.

Once loaded, you will be asked to enter the file name of the *Easy Script* file you want printed, and an option for numbering the pages will come up. Use this only if you are printing on A4 paper, as printer paper is not long enough.

There are two tab positions available, which can be set before printing by pressing 'y' after the 'tabs (y/n)?' prompt. Tabs are embedded in the text as up arrow (^). Tabs define the start of the next

column, legal values being from 0-639. If you only want to use one tab, put two up arrows in the one place, and set both tabs to the same number.

NLQ designer

The Near Letter Quality Designer allows the creative-minded person to design their own fonts. Use a joystick in port two to control the pointer. Point to the words in the control boxes on the right. Press the button to move the cursor underneath the pointer. If there is a control box function underneath, this will also be activated. Use the cursor keys for fine adjustment of the cursor, and the space bar for turning pixels on and off, and for slow activation of functions in the control boxes.

Each character has its own length, as all proportionally spaced NLQ fonts do. As you are designing new characters, those new characters' lengths must be adjusted. Simply click on the LEN box, or, for reviewing all the characters' lengths, click on ALLEN. If, for some reason, the screen becomes full of garbage, click on ALLEN to return it to normal.

If you get stuck, there are help screens available; just click on the help box.

802 Graphic Program

The 802 Graphic Program is a total rewrite of the original programs that appeared in the January 1987 edition of *Australian Commodore Review*, and on *Australian Commodore Review* Disk Magazine Number 5. The actual printing process is written in machine language, while the rest of the program is compiled for greater speed.

To print *Newsroom* Panels, Photos

or Clipart, reset while the desired screen is being displayed in *Newsroom*, boot the *C64/MPS802 Publisher* disk, and select '3' for this program. Then when the first selection is given, choose the type of screen in memory, and save it when the main menu comes up. Then you can print it, or use it in the *802 Pagemaker*.

When printing a screen (after selecting dump screen), and which size you would like your screen (sometimes this won't be asked as only one size is available), you will be asked how many columns in you would like the screen. For the fastest printout, use zero, as this means no spaces have to be printed before a line. You will also notice that no time is wasted by printing when there is nothing to print: if there is a blank line on the screen, the program will ignore it as quickly as the printer is able to perform a linefeed.

When you want to list a directory to the screen, press '5' from the main menu, and use space to pause the listing, and stop to end it. Hit any key after the listing is finished to return to the main menu.

Whenever the program asks you to make sure that the program disk is in the drive, please make sure that it is before you indicate to the program that it is. If, by accident, you press return and the correct disk is not in the drive, insert the correct disk, press 'home', 'down', 'down' and as many 'return's as it takes to get the ball rolling again.

802 Pagemaker

The *802 Pagemaker* allows printing of six screens from different programs on the same page, and is also menu driven. After selecting the screens from disk that you wish to print, the program will ask whether or not each file is a *Newsroom* panel or not.

Please note that this program only caters for *Doodles*, *Printshop* screens and *Newsroom* panels. Other hires screens can be printed, as long as they are between 31 and 33 blocks long, and have no strange format (a simple memory save

is best). The reason for the block numbers is the program uses the length of the file to determine whether or not the file is a *Doodle*.

Make sure the printer is powered up and full of paper before letting the printing go ahead, but if you forget, please don't remember while the disk drive is loading the files: this will really mess things up. Wait until the drive light goes out, and then try.

If, while printing, a 'file not found' message appears, insert the correct disk and hit any key to continue. This allows swapping of disks during the printing process. Don't panic if you have the right disk in and a file not found error comes up, sometimes it is necessary to load the second screen, and then the first screen. This occurs when a *Doodle* screen is printed. All of the printing process is written in machine code, while the rest of the program is compiled for execution speed.

Sign Writer

The Sign Writer originally appeared on Disk Magazine No. 5. It has been revised to ensure its user-friendliness and functionality. If you wish to load a character set (and you will first time it is run every time), leave the *Publisher* disk in the drive and press return. If you wish to use your own character sets, they must have the suffix '.chrset' tacked on the end, even if this means chopping off the original name because it is more than nine characters long.

Many different appearances can be gained by varying the character you use to print the sign in. This is only limited by the keyboard, and

BASIC's input routine. Control codes will be met with something close to disgust, but any shifted or commodore key that performs no function by itself is fine.

As the sign writer simply expands the character sets it uses, you may like to keep the size of the message as small as possible, for speed and appearance.

If the printer is not switched on and the program is printing, please wait until the title screen reappears, switch the printer on, and start over.

Directory Dumps will read the directory of your disk, both sides, and print the directories side by side on paper. This program is extremely simple, press return after asked to do so, and you'll be fine.

I hope these programs help bring you more satisfaction from your Commodore printer, and give you many more years of enjoyment and reliable service from it.

802 Publisher is available through Prime Artifax for \$19.95, call us on (02) 808 1860 and order your disk today. ■

**WIN SIX from 38 SOCCER POOLS using your
COMMODORE 64 or 128.**

SOCCER POOLS PUNTER

This fascinating program has been developed by ESCOM, to evaluate and predict a soccer team's ratings for playing SIX from 38 Soccer Pools. The extensive computer analyses for prediction are based on all past games **SCORE RESULTS** which are entered and stored in your computer weekly. Although complex, the program is not expensive, is easy to operate and disk and tape versions are available. **NO PROMISES OF MIRACLES - JUST A SIGNIFICANT EDGE!** If you believe in **SCIENTIFIC APPROACH**, then don't miss out to find out all about this program!

For full description and details please send a stamped self addressed envelope to:

**ESCOM Pty. Ltd.,
P.O. Box 381,
Alexandria N.S.W. 2015**

*** An interesting and comprehensive article about the program has been written in "The Australian", 10/11/87, page 52 computer section by Mr. Rory Gibson ***

Uncle Pete's latest Crossword Puzzle

THANK YOU all for your wonderful response to the latest crossword. There were some very original answers and some interesting comments attached to some of the entries. Special mention goes to David White of Cessnock, for the first entry received, unfortunately it was not 100% correct. Better luck next time David, it's good to see some local entries. J. Rodgers of Carlingford sent a nice follow-up letter to his/her entry asking for more puzzles (I wonder if the 'J' stands for Jolly?) Thank you for your letters and entries.

But the grand prize for the first correct entry goes to Dean Scully, of Moe in Victoria. Congratulations, Dean, keep up

the good work. The disk of utilities will shortly be heading your way.

I know there are many game freaks out there so this month's crossword is based on games and characters from them, and of course the prize this month is a disk full of Uncle Pete's favourite games. Get your thinking caps on and look up some of your old games and some new ones too.

Send your puzzle or copy to ...

P.O. Box 4
West Wallsend,
N.S.W. 2286

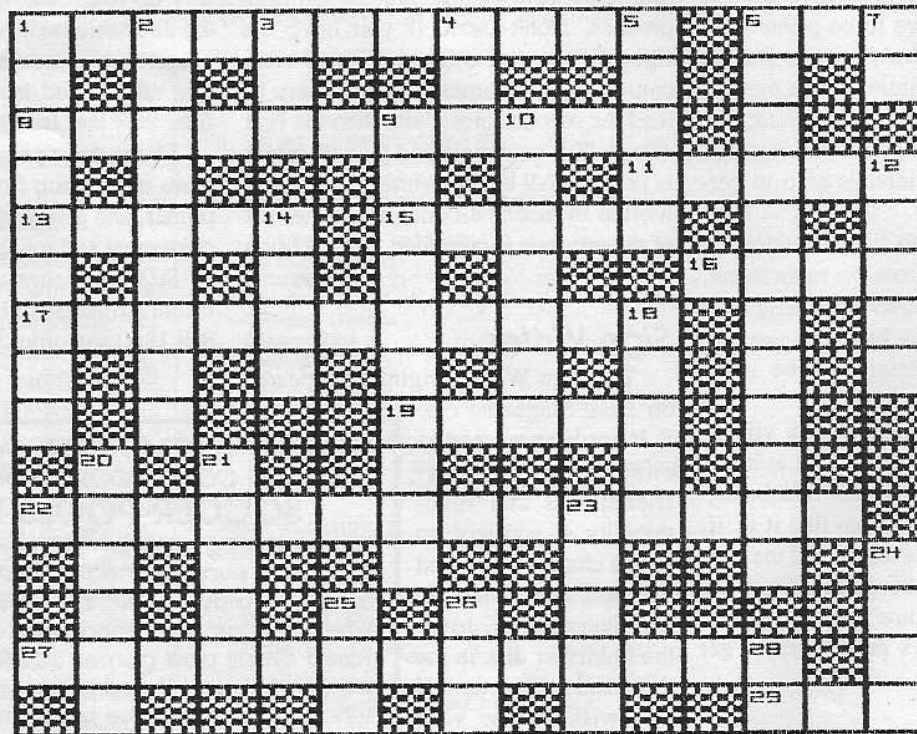

Across clues

- 1. Top golf simulation
- 6. Mr Dare's first name
- 8. Epyx sport simulation
- 11. Way of the
- 13. Wanderer and Shoot 'em up
- 15. Written Story
- 16. Stuck up person
- 17. A very long story
- 19. Strange little dog (Tass Town)
- 22. Punch up game
- 27. Dancing game and portable stereo
- 29. Six legged picnic guest

Down clues

- 1. Latest Karate Simulator
- 2. Military jeep action game
- 3. First woman
- 4. One and soiled and dirty
- 6. The of Pern
- 7. Negative
- 9. Another military shoot'em up
- 10. Impossible
- 12. of the Wood (and Hood)
- 14. Dan
- 18. Busters
- 20. Rider and Round Table
- 21. Person sent ahead and boy . . .
- 23. People from Switzerland
- 24. Way of the exploding
- 25. Desert . . .
- 26. Wierd Alien Lifeform
- 28. Inca Sun God

Part 4 Machine Code Tutorial

by Andrew Baines

In the fourth of his series on Machine Code, Andrew Baines looks at the stack, the status register and the program counter.

THIS month, we'll take a look at some more of the hardware aspects of the 65XX series. For the most part, we could get by without knowledge of them, but they can be very useful, so knowing about them is worthwhile. The first for this month is the program counter.

The program counter

The program counter tells the computer where it is up to in the program. It is a sixteen-bit register that holds the address of the instruction the processor is executing. We don't have to worry about it, and indeed, there is no way of accessing it directly anyway.

Every time a JuMP instruction or Jump to SubRoutine is executed, however, it is altered. This is fine for a JuMP instruction, the processor simply loads the program counter with the address following the instruction and continues from there. But a problem arises with the Jump to SubRoutine instruction, as the computer needs to remember where the JSR is so it can go back to it later on. How can this happen with a sixteen-bit address bus, and a sixteen-bit program counter?

An answer can be found by looking at memory locations \$0100 to \$01FF. This is where the stack resides. The stack plays a very important role in 65XX processors. It provides a temporary storage facility that is one page (or 256 bytes) in size. Its main use is storing the return address when a Jump to SubRoutine is encountered. I.e. when a JSR is executed, the address of the instruction after the JSR is 'pushed' on to the stack, the processor executes the subroutine, 'pulls' the return address off the stack and continues.

The 65XX's stack is a Last-in, First-

out (LIFO) structure, meaning the last thing to go in will be the first thing off. E.g. if you put \$40, \$50, \$55 in that order onto the stack, they will come out in this order: \$55, \$50, \$40.

The stack pointer is nine bytes long, and tells the processor where the next available position on the stack is. Nine bytes long? Yes, the extra byte is set to a one, placing the stack on page one.

Another interesting aspect of the stack is the fact that it starts at location \$01FF, and works its way down to \$0100. This means that if you could look at the stack pointer, and make sure it was nowhere near the bottom limit of \$0100, you could use the available space for other applications. The instruction for this is the Transfer the Stack pointer to the X register (TSX), and, to transfer back, the Transfer the X register to the Stack pointer (TXS). Note that these instructions only affect the first eight bits, and not the ninth. The ninth is always set, regardless.

Another point to realise is that if someone talks about the top of the stack, they are talking about the current memory location that the stack pointer indicates, regardless of whether or not that is less than the bottom of the stack, at \$01FF.

'Stacking' things until later can be very useful, especially when you only need a storage space for a small amount of time, i.e. only when you don't JSR while something is in the stack. To use the stack, there are four instructions; we'll look at two now, two later on.

The first is PusH the Accumulator (PHA) onto the stack. You must have the data to be put onto the stack in the accumulator before this instruction is executed.

The second is the Pull the Accumu-

lator from the stack (PLA) which will load the accumulator with the data on the top of the stack. Please note that this will destroy the current data inside the accumulator, so make sure you only use the PHA instruction if there is nothing of national importance in there.

What are the applications for the stack? Transporting data in between routines when the JSR instruction is NOT used; temporary data storage; storage of registers during interrupts, hardware, NMI, or other; and any others I may have missed.

Please realise that, while the stack holds great potential, it is a limited storage facility as it is only 256 bytes long, and your data must share the stack with the operating system.

The status register

"Another register?" Yes, but this is the last one. This register is multi-functional, and all the branch instructions depend on it.

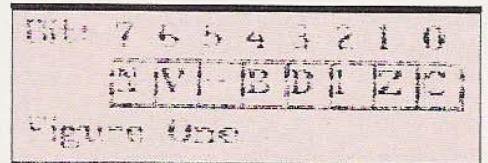

Figure one shows how the status register is set up, and the following explanations refer to the letters that appear in the figure, representing the different flags.

"N"

This is the negative flag, and it usually reflects bit seven in the accumulator. It is useful if you are decrementing the X or Y register, and you go past zero. Using the Branch on result Minus (BMI)

you can make sure the register never gets to \$FF (255 decimal). Alternately, the Branch on result Plus (BPL) can be used. An example of each follows.

Example of BPL.

LDX #5 ; Load the X register with the value (#) 5.

LOOP LDA #32 ; Load the Accumulator with the value 32.

STA 1024,X ; Store the Accumulator in the location 1024 (start of screen memory) plus the contents of the X register.

DEX ; Decrement the X register one.

BPL LOOP ; Branch on result Plus to LOOP. So if the X register is positive: i.e. the seventh bit is clear, we can branch to LOOP. But once the X register falls below zero, and becomes \$FF (255 decimal) the seventh bit is set, and the result is negative, meaning the branch will not take place.

RTS ; Return from SubRoutine.

Example of BMI.

LDX #250 ; Load the X register with the value 250.

LOOP LDA #32 ; Load the Accumulator with the value 32.

STA 1024,X ; Store the Accumulator in the location 1024 plus the contents of the X register.

INX ; Increment the X register.

BMI LOOP ; Branch on result Minus to LOOP. Since X is 250 to begin with, the branch will take place until X becomes zeroed.

RTS ; Return from Subroutine.

"V"

V represents the overflow flag. An overflow occurs when doing arithmetic, and the sixth bit of the accumulator overflows into the seventh bit. This usually happens when performing two's complement calculations (we'll get onto those later).

There are two branch instructions that make use of this flag. They are Branch on overflow Clear (BVC) and Branch on overflow Set (BVS). There is also an instruction which clears the overflow flag: Clear overflow flag (CLV). We'll deal with them later on.

"B"

The Break flag can only be set if a Break instruction initiates an interrupt.

The break instruction has its own interrupt sequence, which is alterable by changing the vectors at locations \$0316-\$0317 (790-791 decimal).

"D"

This is the decimal mode flag. The 65XX processor series has two methods of performing arithmetic. One is in binary, the other is in binary-coded-decimal (BCD). When this flag is clear, the computer is in binary mode. When the flag is set, the computer is in BCD mode. We will look at BCD later on.

The two instructions concerned with the decimal flag are Set Decimal mode (SED) and Clear Decimal mode (CLD).

"I"

Most know what an interrupt is. Because there are many ways on a Commodore 64 to create an interrupt, and there are many types of interrupts, the possibility of two or more interrupts occurring at the same time is quite large. This flag is set if an interrupt occurs or if the instruction Set Interrupt disable flag is executed, to make sure the computer is only interrupted by one source at a time. The Clear Interrupt flag (CLI) instruction allows interrupts.

"Z"

Remember the Branch if Equal to zero (BEQ) instruction and the Branch if Not Equal to Zero (BNE) instruction? Well this is the Zero flag, and the zero flag is set if the result of the last load or transfer was zero (it is clear if the last load or transfer wasn't zero).

It is also affected if a Compare instruction is executed before it. If the result of the Compare was that the two operators were equal, the zero flag will be set, allowing a BEQ. If they weren't equal, the flag will be clear, allowing a BNE. This means that this flag is the Zero flag UNLESS OTHERWISE STATED BY COMPARE.

BCC - Branch on Carry flag Clear.	JMP - Jump to address.
BCS - Branch on Carry flag Set.	JSR - Jump to SubRoutine.
BEQ - Branch if Equal to zero.	LDA - Load the Accumulator.
BMI - Branch on Minus result.	LDX - Load the X register.
BNE - Branch on Not Equal to zero.	LDY - Load the Y register.
BPL - Branch on Plus result.	NOP - No Operation.
BRK - Break. Generate an interrupt.	PHA - Push the Accumulator onto the stack.
BVC - Branch if overflow flag Clear.	PHP - Push the Processor status onto the stack.
BVS - Branch if overflow flag Set.	PLA - Pull the Accumulator from the stack.
CLC - Clear Carry flag.	PLP - Pull the Processor status from the stack.
CLD - Clear Decimal mode.	RTI - Return from Interrupt.
CLI - Clear Interrupt flag.	RTS - Return from Subroutine.
CLV - Clear overflow flag.	SEC - Set the Carry flag.
CMP - Compare to accumulator.	SED - Set Decimal mode.
CPX - Compare to X register.	SEI - Set the interrupt disable flag.
CPY - Compare to Y register.	STA - Store the Accumulator.
DEC - Decrement memory.	STX - Store the X register.
DEX - Decrement the X register.	STY - Store the Y register.
DEY - Decrement the Y register.	
INC - Increment memory.	
INX - Increment the X register.	
INY - Increment the Y register.	

"C"

The carry flag is probably the most extensively used of the flags by the user. It is set if the last arithmetic operation borrowed (or was greater than 255), or if the bit that 'fell off' the accumulator or the memory location during a rotate or shift was a one. The same rules apply for a clear carry flag, except in reverse. This flag can be directly set or cleared by means of instructions. The instructions are CLear the Carry flag (CLC) and SEt the Carry flag (SEC). The carry also has two related branch instructions, Branch on Carry Clear (BCC) and Branch on

Carry Set (BCS).

When a CoMPare is done, the Carry flag is set if the value (or the value in the memory location) is less than or equal to the accumulator. It will be zero if the value is greater. The same applies to the CPX and CPY instructions. Therefore, it is easy to test if a value is greater than or equal to another using the carry flag, if it is equal, using the zero flag, or if it is less using the carry flag again.

The status register can also be saved on the stack, using the PusH Processor status on to the stack (PHP), and Pull

Processor status from stack (PLP) instructions. This allows a CoMPare to be made in one routine, the result PusHed onto the stack, used in that routine, and then used again by a completely different routine (provided a JSR wasn't used to move to the second routine).

Remember that practice makes perfect, and if you try new things out, a better understanding can be obtained than by reading a magazine article!

To finish off this month, on the previous page is the set of instructions we have looked at so far, and a reminder of what they do. ■

NEW — Australian Commodore Review Disk Magazine No 8!

Utilities

Track and Sector — modify disks, find secret words, and modify programs directly using this brilliant utility. Every true hacker needs one.

Function Keys — how would you like 128 function keys on your Commodore 64. This program does it all.

Unscratched — did you actually erase a file lately? If so you need this nifty utility to bring it back.

Relocatable directory — if you need to see what's on a disk without losing your basic program use this little beauty. Specially written to sit anywhere in memory.

Tape Rename — if you need to rename a tape program without the hassle of loading and saving it, this is the answer. See article in this issue.

Games

A super special for issue 8. A complete machine language arcade type game. Excellent graphics and sound.

Home/Business

Calendars — need to find out a special date in the past and the future? This program will calculate the exact date and day.

Chequewriter — for a professional finish to your cheques why not print them out.

Screen clock — if you need to keep track of the time whilst you're programming this program displays the date and time at the top of the screen. Remains running even as you type.

Graphics

ESCOS version 2.99 — produce your own full screen pictures made by joining 112 separate sprites. A programming marvel!

Newsroom Camera

Clear Screen

Demos

Enterprise II

Eddie Murphy

Future Writer - Send musical letters to your friends using the program the experts use.

This is the one that programmers use to pass on special messages to each other.

Includes various character sets and a selection of music.

ORDER FORM

Name.....Address.....

.....Postcode.....Cheque.....Bankcard.....

No:.....Expiry Date.....

Signature..... Send me.....copy/s of Disk Magazine No 8 at \$12.00 each plus \$2.00 P. & P.
Post to : AUSTRALIAN COMMODORE REVIEW, TOP REAR, 4 CARRINGTON RD, RANDWICK, NSW 2031 (02)398 5111

Device number switch for 1541

by Joe Fixit

IN MY article "The Fast Change Button" which appeared in the August '87 issue of *The Australian Commodore and Amiga Review*, I invited you to contact me with ideas for future projects. The response was heavily in favour of some form of switch to make it possible to change the device number of 1541 disk drives.

I don't own a 1541 and had to borrow one from a brave soul so that the work could commence.

I discovered that several different printed circuit boards have been used in the lifetime of the 1541, fortunately though they are all essentially the same in the area of device number changing.

In all cases there are two pairs of pads on the p.c. board and it is merely a matter of shorting them out with a blob of solder or leaving them open-circuit to select from numbers 8, 9, 10 and 11.

1571 drives have a small opening at the rear through which it is possible to manipulate two tiny 'd.i.p.' switches (that stands for Dual-Inline-Package and describes the terminal arrangement). These two switches have four possible

"My main consideration in designing this modification was that it should be simple to use and complete in its operation."

combinations giving device numbers 8, 9, 10 and 11.

This is alright, I suppose, but it's not quite as simple as just flicking a couple of switches, it never is! Merely changing the setting of these switches has no effect at all until the power is switched off and then on again - a crude reset. The 128D has two reset buttons; one for the computer and one for the in-built drive. The in-built drive does not have d.i.p. switches! Stand-alone 1571 drives don't have a reset switch. 1541's don't have either facility.

Manufacturers of complex electronic equipment face many dilemmas when designing items for a mass market, and many compromises have to be made if costs are to be kept down. However, it is frustrating for the end users when fairly simple facilities are omitted. That's where people like myself come in with modifications.

My main consideration in designing this modification was that it should be simple to use and complete in its operation, i.e. it should not be necessary to do anything apart from selecting a device number with a single switch, no reset button to press, no special software to load, etc. I also thought that it would be nice if it

was obvious what number had been selected without having to decode several switch settings, and that the number should be retained when the power is removed.

The first thing to locate was a suitable switch with four positions. After looking through many catalogues I found that Jaycar Electronics had one (catalogue no. SS-0850) for \$1-50 and also Altronics (cat. no. S 2040) for \$1-10. I suspect that the two switches are actually the same, Jaycar being a distributor for Altronics which is a Perth-based company. I purchased from Jaycar.

These switches have two 'poles' (or separate switches) that move together. Referring to the circuit; S1b in conjunction with two diodes is connected to the pads on the 1541 printed circuit and selects the appropriate combinations. The two diodes connect both pads to ground for device number 8. Both pads are open-circuit for device number 11. As I mentioned before, just selecting a number does nothing, a reset is required. The rest of the circuit detects when the switch is moved and generates a reset pulse.

I.C.1 is a 555 timer. It is connected in an unconventional manner as an inverted monostable multivibrator - be careful how you say that in mixed company! Pin 7, an open collector transistor that is usually employed to discharge the timing capacitor connected to pin 2, is connected directly to the reset circuit and connects it to 0 volts for about one second when required. Pin 3 is the bipolar output of the 555 and is connected via R4 and a 1N914 diode to pin 2, the trig-

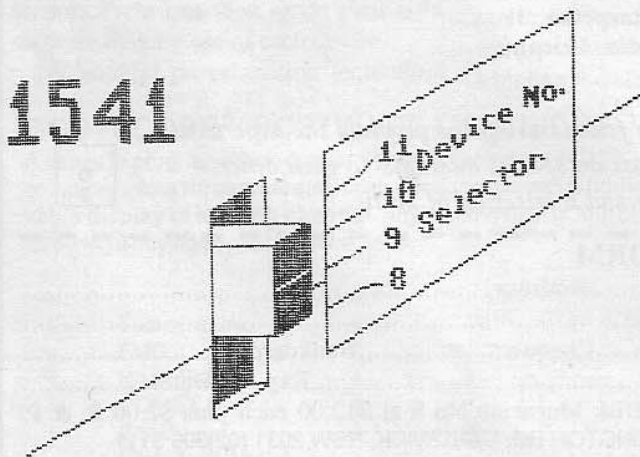

DEVICE NUMBER SWITCH FOR 1541 DRIVES

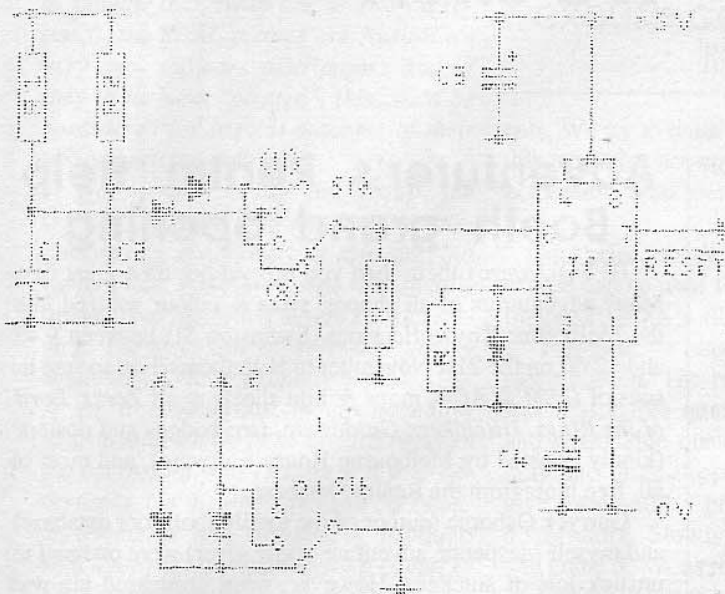

Parts:

R1 100K
R2 100K
R3 100K
R4 100K
R5 100K
R6 100K
R7 100K
R8 100K
R9 100K
R10 100K
R11 100K
R12 100K
R13 100K
R14 100K
R15 100K
R16 100K
R17 100K
R18 100K
R19 100K
R20 100K
R21 100K
R22 100K
R23 100K
R24 100K
R25 100K
R26 100K
R27 100K
R28 100K
R29 100K
R30 100K
R31 100K
R32 100K
R33 100K
R34 100K
R35 100K
R36 100K
R37 100K
R38 100K
R39 100K
R40 100K
R41 100K
R42 100K
R43 100K
R44 100K
R45 100K
R46 100K
R47 100K
R48 100K
R49 100K
R50 100K
R51 100K
R52 100K
R53 100K
R54 100K
R55 100K
R56 100K
R57 100K
R58 100K
R59 100K
R60 100K
R61 100K
R62 100K
R63 100K
R64 100K
R65 100K
R66 100K
R67 100K
R68 100K
R69 100K
R70 100K
R71 100K
R72 100K
R73 100K
R74 100K
R75 100K
R76 100K
R77 100K
R78 100K
R79 100K
R80 100K
R81 100K
R82 100K
R83 100K
R84 100K
R85 100K
R86 100K
R87 100K
R88 100K
R89 100K
R90 100K
R91 100K
R92 100K
R93 100K
R94 100K
R95 100K
R96 100K
R97 100K
R98 100K
R99 100K
R100 100K

C1 100n
C2 100n
C3 100n
C4 100n
C5 100n
C6 100n
C7 100n
C8 100n
C9 100n
C10 100n
C11 100n
C12 100n
C13 100n
C14 100n
C15 100n
C16 100n
C17 100n
C18 100n
C19 100n
C20 100n
C21 100n
C22 100n
C23 100n
C24 100n
C25 100n
C26 100n
C27 100n
C28 100n
C29 100n
C30 100n
C31 100n
C32 100n
C33 100n
C34 100n
C35 100n
C36 100n
C37 100n
C38 100n
C39 100n
C40 100n
C41 100n
C42 100n
C43 100n
C44 100n
C45 100n
C46 100n
C47 100n
C48 100n
C49 100n
C50 100n
C51 100n
C52 100n
C53 100n
C54 100n
C55 100n
C56 100n
C57 100n
C58 100n
C59 100n
C60 100n
C61 100n
C62 100n
C63 100n
C64 100n
C65 100n
C66 100n
C67 100n
C68 100n
C69 100n
C70 100n
C71 100n
C72 100n
C73 100n
C74 100n
C75 100n
C76 100n
C77 100n
C78 100n
C79 100n
C80 100n
C81 100n
C82 100n
C83 100n
C84 100n
C85 100n
C86 100n
C87 100n
C88 100n
C89 100n
C90 100n
C91 100n
C92 100n
C93 100n
C94 100n
C95 100n
C96 100n
C97 100n
C98 100n
C99 100n
C100 100n

IC1 555

All diodes
1N914

S1 2P4T
See text

©1987 Joe Fixit

ger input. Pin 6 is the threshold input, used here as the trigger.

At rest, R3 holds pin 6 at 0 volts, this causes pin 3 to stay at +5 volts charging C4 through the diode across R4.

The tricky part of the circuit was detecting, reliably, when the switch moves. For pin 6 to trigger it must be raised to at least 2/3 of the +5V supply.

Say that the switch is set to '8', R3 prevents C1 from charging to more than approximately +1V. C2 will have charged to +5V and when the switch is moved to '9' it will discharge through R3, briefly raising pin 6 to +5V. When this happens, pin 3 goes to 0V slowly discharging C4 through R4. Pin 7 pulls the reset line low. About a second later C4 will have discharged below 1/3 of the supply, so pin 3 goes to +5V, once again charging C4.

The two diodes were necessary because the switch contacts tend to short together between steps (make before break). This would discharge C1 or C2 before they had a chance to trigger pin 6. I have not been able to cause this circuit

to ignore a switch movement, so pronounce it reliable. Apart from selecting different device numbers it is also useful just as a reset switch by moving from, say, 8 to another position and back again. Very handy when your drive locks up.

Installation of the modification is made much easier by using the printed circuit that I have designed. The switch's connecting pins are on 2mm centres (instead of 2.54mm) and this makes it rather hard to work with if you are trying to use Veroboard, etc. The p.c.b. mounts directly onto the right-hand side of the chassis (as you face the front of the drive) and only requires the drilling of two holes.

I cannot stress too strongly that it is extremely easy to damage the drive if even the smallest fragment of steel should inadvertently find its way into it, not to mention what could happen if the drill should slip! You should remove the chassis to drill it.

With the board in place it is a simple matter to mark and file the plastic case to

clear the switch actuator. There are five connections to be made to the 1541's p.c.b.; +5 Volts, 0 Volts, Reset and the two device number pads. The unit that I modified had a p.c.b. assembly number #250442/46. I found convenient take-offs for: +5 V at the front edge of the board on the end of R4 nearest to C39, 0 V on the end of CR5 nearest R2, Reset at the back of the board on the end of R57 nearest to the back of the unit, and pads 1 and 2 are marked as such at the front left-hand corner between Q4 and Q5. These pads will need to have a small printed connection broken if your drive is (most likely) currently device number 8.

Other boards have similar arrangements and if you are already an experienced electronics constructor you should have no difficulty in locating the necessary connections.

The circuit information presented here is for your own private use only, not for commercial gain.

Inexperienced persons should not attempt this project due to the risk of damaging the drive mechanism. I am making this modification available through Microcomputer Spot at Hornsby (and perhaps the other branches?) and you should take your drive there to have this modification fitted. I have the facilities to perform this work efficiently and to a high standard. Turn-around time will be in the order of two working days.

I will be designing a similar mod. for the 1571 and am also working on a multiple joystick / trackball / paddle / port selector which can be used on a VIC-20, C-64, C-128, or AMIGA. Your suggestions are most welcome and may be addressed to me at Microcomputer Spot, Hunter Street, Hornsby, 2077. ■

Adventurer's Realm

by Michael Spiteri

WELCOME TO the Realm once again, Australia's only column dedicated to adventure & strategy games.

If you:

- a) Are stuck in an adventure game.
- b) Can help someone who is stuck.
- c) Can contribute some tips/maps/hints.
- d) Want to air your feelings on any adventure matter.

then write to:

Adventurer's Realm
1/10 Rhoden Court
North Dandenong
Victoria, 3175

If you expect a written reply, **ENCLOSE A STAMP.**

When writing to the realm, tell me your name (or Adventure Nickname), address, magazine you are writing to (*ACR* or *GEM*), and all relevant details of your query/hint/comment. Simple, eh? ■



Realm's maps and hint sheets

(Available now)

Hint Sheets:	Maps:
Zork I,II,III	Zork I,II,III
Lord of the Rings	Lord of the Rings
The Hobbit	Hitchhikers Guide
Castle of Terror	
Hampstead	
Hitchhikers Guide	

BOTH THESE LISTS WILL GROW

Adventurer's Realm Help Booth grand opening

IF YOU weren't there then you missed out on a great day. Many adventurers of all shapes, sizes & colour waltzed into the Melbourne Toyworld store (Swanston St) between 9.45 and 12.00 on the 21st November to help themselves to free issues of *GEM & ACR*, maps & hint sheets to all *Zorks*, *Lord of the Rings*, *Hitchhikers Guides* etc, free badges and posters (kindly donated by Melbourne House Software), and most of all, free hints from the Realm Database.

Garryck Osborne (author of the totally foolproof database) and myself (desperate adventure tipper giver) were on hand to unstuck lots of stuckees. However, what impressed me was that if I couldn't help out, another adventurer would jump in to the rescue with the tips required (just goes to show that adventurers ARE the friendliest people).

Martin Oakes of Toyworld had the honours of cutting the red tape and officially opening the Help Booth. This he did with a smile (and a nice heavy cash register in the corner).

The Help Booth will be open during normal trading hours, six days a week. Hint sheets & maps will be available from the Toyworld staff.

If you bring in this article you will be entitled to a 10% discount off the price of any software product from Toyworld.

You can also leave mail to the Realm at the special post box at the Booth. A printer might also be available so that you can get hard copies of the hints & tips.

Many thanks to the staff of Toyworld for their complete support. Also, thanks to Melbourne House, for supplying goodies at such short notice. Then thanks to Garryck, for creating an incredible m/l database in such little time. Finally, thanks to all who showed up on the day - we can now go ahead with plans for a Sydney Help Booth.

If you know of any store in the Sydney area that might like to participate in a Sydney Help Booth, please contact the Realm as soon as possible. ■

Zorker of the month

Snowball genius Arnold Lancaster of Kirribilli takes the very prestigious award this month for his problems in *Zork II* and *Zork III*.

Problems Problems Problems

Noel McAskill of Revesby, NSW is stuck in *Murder on the Mississippi*: "I have got to the end of this game using an alibi so I must have missed out on a few clues somewhere."

Craig Mathieson of Mooroopna, Vic is also stuck.

"In *Big Sleaze*, how do you open the safe and then the car? In *Borrowed Time*, after Bruce Light faints and awakes and says he will tell you what you want, what do you say? Is there any way of getting rid of the thugs that keep killing you? What is the key behind Rita's stove for?"

Mark Glendenning of Warrandyte, Victoria, is stuck in *Princes in Amber*.

"How on earth do I get past Eric once I have saved Deirdre and have got him on the ground after the duel? The location is a small grassy glade. Please help me."

Ex-Zorker Suzanne Parkes, Blacktown, NSW is stuck in *The Pawn*.

"1. How do I get past the Magicians Workshop?

"2. What do I do with Jerry Lee Lewis? Where do I find the keys to the safe and the wooden door in the Ice Tower?

"4. I have managed to get into the Deveil but he won't tell me what he wants!"

Ann Brownell came to the rescue of many troubled adventurers, however she appears to be locked in an Egyptian Room in *Mad Mummy*. Any helpers?

G. Pride of Wodonga, Victoria is stuck in *Bard's Tale II*. He is in segment 4, and wants to know the value of Rote actions.

Michael Lee of Berkeley Vale, NSW, is stuck in *Leather Goddesses of Phobos*. "How can I get to the battlecruiser

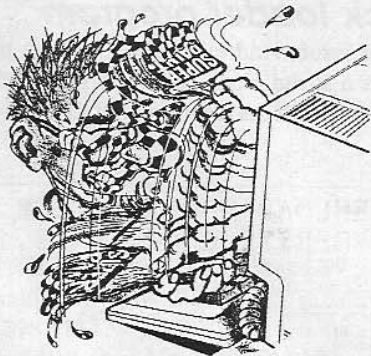

without either losing Trent or myself to the radium-flowered grenade?"

David Newmann is stuck in a few games.

"In *Labyrinth*, how do you get rid of the Goblin Guards and free Ludo? In *The Hobbit*, after claiming the treasure & killing Smaug, how do you make it back along the forest road without the pale bulbous eyes killing you? In *The Holy Grail*, how do you throw the



David Lear of Flagstaff Hill, South Australia, is stuck in quite a few games:

Underworld of Kyn: Kings Dungeon - what use is the chair? How do you fly the rug? How do you pick up the Crystal of Evil? What are the rope, strip & silk used for? Is the hall of darkness a dead end?

Ring of Power: "The only thing I can find a use for is the credit card to use the lift. How do I fix the hole in the boat?"

Red Moon: How do I use the gas mask and tubing to make a snorkel to get through the flooded caves? Is there anything in the Sarcophagus and how do you open it? What should you give the alchemist to buy his goods? How do you open the safe in the treasure vault? How do you remove the grate from the giant's forge?

Jim Fang of Forest Hill, Victoria, is stuck in a couple of games:

Guild of Thieves: "How exactly do I make a fishing rod?" *Bard's Tale*: "How do I get into Morgars Tower?"

"What is the significance of the Crystal Golem?"

Mark Horvath is stuck in *Colour of Magic*: "At Bel Shamrotho Altar, how do I kill it? I know you need a crystal, but where is it?" Also, in *Kobyashi Naru*, how do you stop drowning or getting shot? Finally, in *4th Protocol* "When building 17 is ready to secure, what is the order of the security measures?" ■

Adventurer of the month

Well, this is a first. Our ZORKER OF THE MONTH also picks up this award. Arnold sent in the complete map to *Snowball*, along with many hints (to be printed in an upcoming realm) Congratulations Arnold.

Help for recently troubled Adventurer's

THANKS TO all who went to the trouble of helping other adventurers in their plights. If you were stuck a few months back, your problem could be solved on these pages.

For: Andrew Sopar
From: David Newmann
Game: *Holy Grail*

Help: Give the pink shrubbery to the knight who says NIC to stop him saying this (can be found inside CAMELOT).

For: Alf Hoop
From: Jim Fang
Game: *Kings Quest III*

Help: The wand is in the wizard's office (in a locked cabinet). The key to the cabinet is on the top of the closet in the Wizards bedroom. To get into the cave you must be an Eagle (*MS: Singing Hotel California all the way there*). The wizard comes and goes. Note when he zaps you. You must transform the Wizard into a cat. He zaps you because he does not like you playing with magic. Hide all the

items under your bed in the room. Put the wand back and clean up his study.

For: Kevin Emery
From: Jim Fang
Game: *The Pawn*

Help: To get past the dragon, point to the shadows. Shine white at shadows.

For: G.T.
From: Gregory Paul
Problem: No games in Adelaide
Help: Try the Computer Centre off Adelaide Arcade.

For: Mark Horvath
From: Ann Brownell
Game: *ZZZzzzz*

Help: To cross the road you must first thumb a lift. You don't ever walk across the road.

For: Andrew Sopar
From: Ann Brownell
Game: *King Solomons Pt 1* and *ZZZZZZZZzzzzz* and *Mad Mummy*

Help: To cross the bridge, throw spear, go bridge. When the bridge starts to break, type RUN as quickly as you can. Type JUMP.

Help: To get into the mansion, first OPEN DOOR, CLIMB VINE, CLIMB DOWN, GET {funny little face}, GO WEST, WEAR TIE, ENTER BOX, OPEN HATCH, ENTER WAITER, REPLACE HAND and ANSWER PHONE. To get on the bus you need the sign from the mansion "RAISE SIGN".

Help: Make sure you have the Pike when you are at the cases and you will be able to open them.

For: Mario Mueller
From: Ann Brownell
Game: *ZZZzzzz*

Help: After dropping the bullseye on the bandit, you go west and down the pit

For: Gabor Jakob
From: Ann Brownell
Game: *Demon Knight*
Help: There is a key on the top of the post that is too big and too slippery to climb. ■

Back page bunkum

NO, we're not perfect (J.Mark Hunter has been heard denying this statement) therefore we make mistakes. Consequently we get a lot of frantic readers ringing up - who distributes such and such, or where are lines 1100 - 3000 in that program listing. Well, on this page we will clear up these slips of the Editor's pen and put all your minds at rest.

Comodem distributor

In the Christmas issue, the Comodem was reviewed but no distributor was given. In Sydney the distributor is Computermate Products (02) 457 8118, or you could ring Computronics International in Perth on (09) 221 2121.

Action Replay distributor

Also in the Christmas issue, we reviewed Action Replay Mk III cartridge - the distributor for this is Westend Computers (03) 350 5144

Sprite clock loader program

In the October issue, Andrew Baines wrote a pretty neat program that puts a sprite clock in the border. Well, er..um, we left the loader program out - sorry about that. Anyway here it is.

```
10 F=F+1: IFF=1THENLOAD"SPRITE CLOCK.C",8,1
20 IFF=2THENLOAD"SPRITE CLOCK.S",8,1
30 SYS49408
40 INPUT"hour";H
50 INPUT"minute";M
60 INPUT"second";S
70 POKE50003,H:POKE50004,M:POKE50005,S
80 PRINT"HIT ANY KEY WHEN READY TO SET"
90 POKE198,0:WAIT198,1:GETA$:SYS50000
100 POKE642,64:POKE44,64:POKE16384,0:NEW
READY.
```

COMMODORE PRINTERS

For every Commodore computer there is a Commodore printer that is designed to cover your specific needs whether you are an owner or user of a Commodore 64 or 128, an AMIGA 500, 1000 or 2000, a PC 5, 10, 20 or 40.

Commodore printers are designed to give you total compatibility with the rest of your computer system with built-in high performance and at the same time offering value for money.

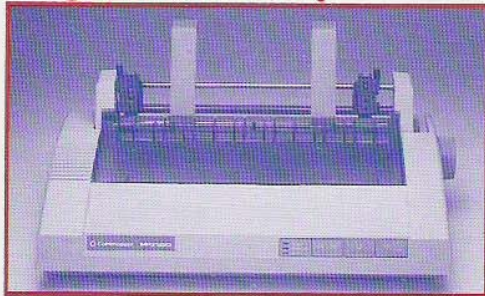

Commodore MPS 1250 Dot Matrix Printer



Commodore DPS 1101 Daisy Wheel



Commodore MCS 810/820 Colour Series

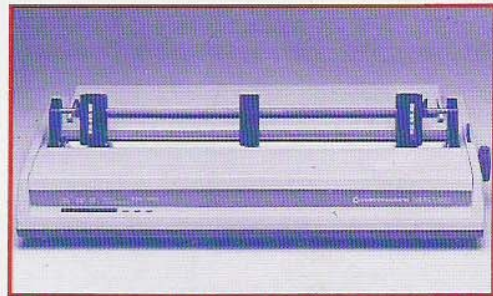

Commodore MPS 1280 Dot Matrix Printer

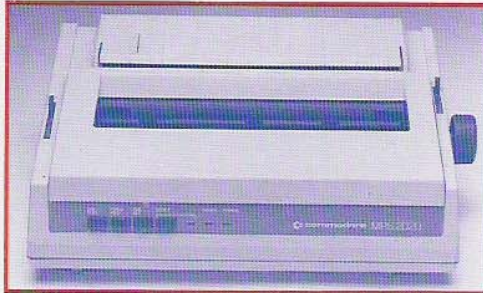

Commodore MPS 2020 Dot Matrix Printer

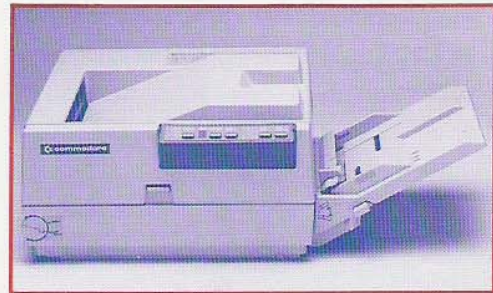

Commodore LP 806 Laser Printer

 **commodore**
COMPUTER

This document was produced on the Commodore LP806 printer.

FREEZE MACHINE



DISTRIBUTED BY
MICRO ACCESSORIES OF S.A.

