

The Australian **COMMODORE** and **AMIGA REVIEW**



**Colour
Printers
Reviewed**
Star, Citizen and
Panasonic

**RocGen Plus
Genlock Reviewed**

MediaShow - Entry Level Multimedia · AMOS Column

Build Your Own Mouse/Joystick Switch

Games: Utopia, Maupiti Island, Rodland & Star Goose

Make your Amiga a Star performer...

with a Commodore approved colour printer.



star
LC24-200 CL
Versatile and Stylish - 7 fonts, 13 pitch settings, 360 DPI - a top performer.



star
LC-200 CL
Affordable high speed colour - 6 fonts, 240 DPI, 5 pitch settings - top value.



star
LC-10 CL
Quality & reliability at an entry level price - 4 fonts, paper parking & colour!



Ask about our optional 3 Year Warranty

36 months of full parts and labour warranty for only \$36 (including the printhead)



star
MICRONICS

Computer Printers for the 90's

STAR Micronics Branches

NSW - Unit A, 107-115 Asquith St, Silverwater, NSW, 2141	Tel (02) 748 4300 Fax (02) 748 3527
VIC - Unit 14, 106 Ferntree Gully Rd, Oakleigh, VIC, 3166	Tel (03) 544 6676 Fax (02) 544 4231
QLD - 1st Floor, 39 Flanders St, Salisbury, QLD, 4107	Tel (07) 875 1551 Fax (07) 875 1287
WA - Unit 2, 20 Macadam Pl, Balcatta, WA, 6021	Tel (09) 344 2488 Fax (09) 345 3044
N.Z. - 64 Lunn Ave, Mount Wellington, Auckland, N.Z.	Tel (09) 570 1450 Fax (09) 570 1448

ALLEN COMPUTER SUPPLIES.

The people who care!

Not only the largest,
not only the best PD
Collection in Australia
BUT NOW
LICENCEWARE

Australia's only distributor of
DEJA VU (formerly AMOS)
Licenceware. Top quality software
at a price all can afford - \$8.00
Yes \$8.00. Contact us for details.

JIGAMANIA
JUNGLE BUNDLE
HYPNOTIC LANDS
PLAY IT SAFE
MAGIC FOREST II
THINGAMAJIG
INVOICE PRINTER
HARD DRIVE MENU
BUDBASE

And many more. (42 Titles)

- 1 All disks 100% guaranteed.
(We will replace or refund)
- 1 Ask about our very competitively
priced Commercial Software.
- 1 All PD disks \$5.00 per disk
All orders add \$2.00 p&p

Allen Computer Supplies
where you will get more for
your dollar!

Call us on (03) 725 3379

Fax us on
(03) 723 1780

432 Dorset Road,
Croyon Vic. 3136

Latest 3 Disk PD
Catalogue
\$6.00



The Australian Commodore and Amiga Review

VOLUME 8 NUMBER 12 DECEMBER 1991

General

- 4** Ram Rumbles. News.
- 16** Picking a Printer. Adnrew Farrell compares four dot matrix colour models.
- 20** Panasonic KX-P1124 - User Report. Alan Stuart decided it was time to upgrade.
- 34** Letters to the Editor. Text books and C64 machine code.

Amiga

- 6** Notepad. Special report on the Amiga laptop, and news about Technosound Turbo, Wordworth 1.1, ProWrite 3.2, and lots more.
- 14** Entry Level Desktop Video - the Rocgen Plus Genlock. Peter Ward investigates.
- 24** Media Show - Multi Media on a Budget. This program offers several unique features, as Andrew Farrell explains.
- 30** Hardware Project - Mouse/ Joystick Switch. A do-it-yourself switch unit to select between two or three different controller devices.
- 36** Hot Buys for Christmas. Looking for a gift, a bargain, some slick hardware or sizzling software? Here's a run-down.
- 40** Amos for Aardvarks. Wayne Johnson provides the latest on AMOS.
- 46** Workbench Potpourri. Useful

Workbench and CLI hints and tips.

52 Andy's Attic. Andrew Leniart provides hints, tips and general information of all types.

C64/128

- 60** The C64 Column. Owen James reports on re-usable sub-routines to add to your programming library, and readers' letters.
- 64** The GEOS Column. Owen James takes a look at new GEOS titles and desktop publishing, and your queries.

CDTV

70 CDTV: Feedback. What readers think. News. Plug-in keyboards and Karaoke.

Entertainment

- 72** That's Entertainment. News, Jimmy White's Whirlwind Snooker competition, Amiga and C64 hints and tips, letters, Shadow of the Beast full solution, Hall of Fame.
- 77** Game Reviews. Utopia, Jimmy White's Whirlwind Snooker, Rugby - the World Cup, Star Goose, Maupiti Island, Rodland.
- 77** Adventurers' Realm. Hints and tips, News, Problems and Help, The Dungeon.

71 Advertisers' Index

Amiga Public Domain

*One of Australia's most diversified
and extensive ranges available
Over 4000 Disks Catalogued*

Amaz, Amicus, Amiga Format, Amiga Nuts
Amigan, Amos, Amigoz, Best of Fish, Ceccc,
Compass, Crazy Joes, Eric Schwartz, Eagle
Faug, Fish, Fillet o Fish, Larson, Macro,
Nzamiga, Phoenix, Scope, Smaug, Snag, Tbag
17bit, Topik, Tobias Richter Agatron Anims
All PD \$2 - \$3 Each Inc Nashua Disk

3 Disk Catalogue \$4.00 Inc Postage

New: Hook Line & Sinker Fish Data Base
2 Disk Set only \$4.00

QUADRANT COMPUTERS

26 Rochester Way Dianella WA 6062
PO Box 380 Morley WA 6062

Tel (09) 375-1933 Fax (09) 375-1113
Mobile Tel All Hours (018) 918 608

Australian Commodore Review:

21 Darley Road Randwick, NSW
2031. Phone: (02) 398 5111

Published by:

Saturday Magazine Pty Ltd.

Distribution: NETWORK

Distribution

Printed by: Ian Liddell Pty Ltd

Editor: Andrew Farrell

Production: Brenda Powell

Design & Layout: Tina Goins

Subscriptions / back

issues: Darrien Perry (02) 398 5111

Entertainment Editor: Phil Campbell

ADVERTISING: Ken Longshaw

(02) 398 5111 or (02) 817 2509,

Mobile (018) 23 0912

Computer Man

The Amiga Supermarket

SPECIAL: Diskettes 3.5" DSDD Cheap \$6.99

MEMORY EXPANSIONS

512k with switch & battery	\$59.95
1Mb A1000/500 external/0	\$199.00
2Mb A500 Internal/0	\$120.00
2Mb A500 Internal populated	\$269.00
4 Mb A500/Internal/0	\$186.00
Accelerator card A500	\$649.00
Flicker Fixer A 500	\$549.00

HARD DRIVES

GVP 52Mb/Q A500 Series II	\$989.00
GVP 80Mb A500 Series II	\$1099.00
GVP 105 Mb Series II	\$1380.00
GVP A2000 HC8/42Mb/Q	\$749.00
GVP A2000 HC8/52Mb/Q	\$849.00
GVP A2000 HC8/80Mb	\$1150.00
GVP A2000 HC8 105/170 Mb	CALL
Amiga 500 computer	\$679.00
Amiga 2000	\$1279.00
Action Replay MK III 500/1000/2000	NOW IN

PRINTERS 9 PIN

Epson LX400	\$239.00
Panasonic KXP1180	\$279.00
Star LC10 II	\$319.00
Star LC15	\$549.00
Citizen Color GSX 200	\$399.00
Star NX 1000 Color/LC10 Color	\$369.00
Star LC 200 Color	\$429.00

PRINTERS 24 PIN

Brother M1324	\$449.00
Epson LQ400	\$419.00
Panasonic KXP1123	\$449.00
Panasonic KXP 1124	\$479.00
Star LC 24-10	\$489.00
Star LC 24-15	\$749.00
Citizen Color GSX 140	\$599.00
Star LC 24/200 Color	\$699.00

SPECIAL

Bubble Jet BJ 10 EX	\$549.00
---------------------	----------

Free cable this month

3.5in Internal Drive	\$130.00
3.5in External Drive	\$119.00

NO ONE BEATS OUR DEALS!

Put us to the test

SPECIALS FOR JANUARY & FEBRUARY

FISH 1 - 580	.99c
AMOS 1 -240	\$2.50
17 BIT 1 - 1450	.99c
General PD	.99c

018 911 011 or 09 328 9062

PO Box E265, Perth 6001

611 Beaufort Street, Mt Lawley Perth 6050 WA.

Editorial

I have been thinking about Amiga's future after speaking with all sorts of people. Obviously, as owners of Amiga equipment we all have reason to be concerned with its future. Will there be support, service and more importantly, something to upgrade to, are all things which come to mind.



Are IBM compatibles serious competition for the Amiga? PCs are cheaper than they were, and they seem to be having an impact as a home machine, but if you're looking for a machine which is a lot of fun, performs essential tasks to help justify the purchase - such as wordprocessing, and could also double as the best games computer in town, then there is no doubt you should purchase an Amiga.

If you would like to use your computer for desktop video, music, animation or programming, once again, the Amiga wins hands down. An IBM compatible is simply no competition by the time you add the necessary bits to bring it in line with an Amiga in these applications.

Furthermore, Amiga software is much less expensive than MS-DOS equivalents - a strange thing considering the MS-DOS market is many times larger.

However, it's the "can I bring my work home", "will it run IBM software" and "surely I need a real computer" consumers who are being easily coerced into going the PC way. Indeed, some of the aforementioned buyers are also going PC on the basis of price. This could turn out to be a nasty mistake.

It would not take much to show these people all the good an Amiga can do, like read/write and format MS-DOS 720K disks with a \$5 public domain program, run programs as good as most of the MS-DOS packages around and generally provide a platform for family enjoyment way beyond the realms of information processing. However three things are in the way. These people don't know about the Amiga, they are convinced they need IBM compatibility (although the Amiga can provide this) and at this time the Amiga is not price competitive.

The United States market is now dominated by the PC, but there is still a strong Amiga following even there. And of course, there's always Europe. Some 85% of all Amigas are sold there, and the home market is well and truly sewn up by Commodore. I am not concerned that the Amiga will be gobbled up by the upside down pyramid of MS-DOS and the patch-work architecture which is IBM compatibility. It's just a shame some people will end up with PC's - which might offer more sophisticated business software, a good choice of games (if they work with your chosen mouse and sound card) - but at the end of the day are not as much fun to use. And we all know that Windows is just no match for Workbench 2.0 - so why worry?

Andrew Farrell

Introducing the AMIGA® 500 FITNESS PLAN

GVP's New Series II™ A500HD8+ Puts A2000® Computing
Power and Punch into Your Amiga 500

IMPACT
Series II

By now you know that every Amiga 500 comes with that special built-in program called "Wait". Wait while your A500® loads software. Wait while you save files. Wait while you change disks. It doesn't have to be that way!

GVP's Series II A500HD8+ Takes Off the "WAIT"

GVP's Series II A500HD8+ 40-105MB Hard Drives work like the world's fastest runners to take the "Wait" off and to get your Amiga 500 racing along at data transfer speeds of up to 52 times faster than floppy disk drives. But getting rid of the "Wait" is just the beginning...

GVP's Series II A500HD8+ Turns Floppy Fat into HARD DRIVIN' Muscle

Because the Series II A500HD8+ uses the same custom VLSI and FA AASTROM™ technologies of it's powerful cousins - Series II A2000 SCSI + RAM - you get more than an amazingly fast hard drive. You get the storage space of 45 to 136 floppy disks, depending upon the model you choose.

You also get Series II's:

- ✓ Exclusive Game (Hard Disk disable) Switch for Full Games Compatibility
- ✓ A2000 DMA Data Transfer Speeds.
- ✓ FAST RAM expansion with up to 8MB of SIMM-Based Internal RAM Expansion
- ✓ "Mini-Slot" Access to All A500 Expansion Bus Signals for future expansion.
- ✓ External SCSI Port for adding up to 7 SCSI Devices
- ✓ Internal Fan for Cool, Reliable Operation
- ✓ External Mounting to Maintain Your Original Commodore Factory Warranty
- ✓ FREE Dedicated Universal Input Power Supply. Insures full compliance with Commodore's A500 power limitation.
- ✓ One-Year GVP Factory Warranty.

GVP's Series II A500HD8+ Keeps Your Amiga 500's Sleek Good Looks

GVP knows that no fitness plan is complete unless it keeps your system looking great. That's why your Series II A500HD8+ matches your Amiga 500's good looks line-for-line, curve-for-curve.

So get a GVP Series II A500HD8+ hard drive for your Amiga 500. Lose the "Wait" and Gain the Muscle.

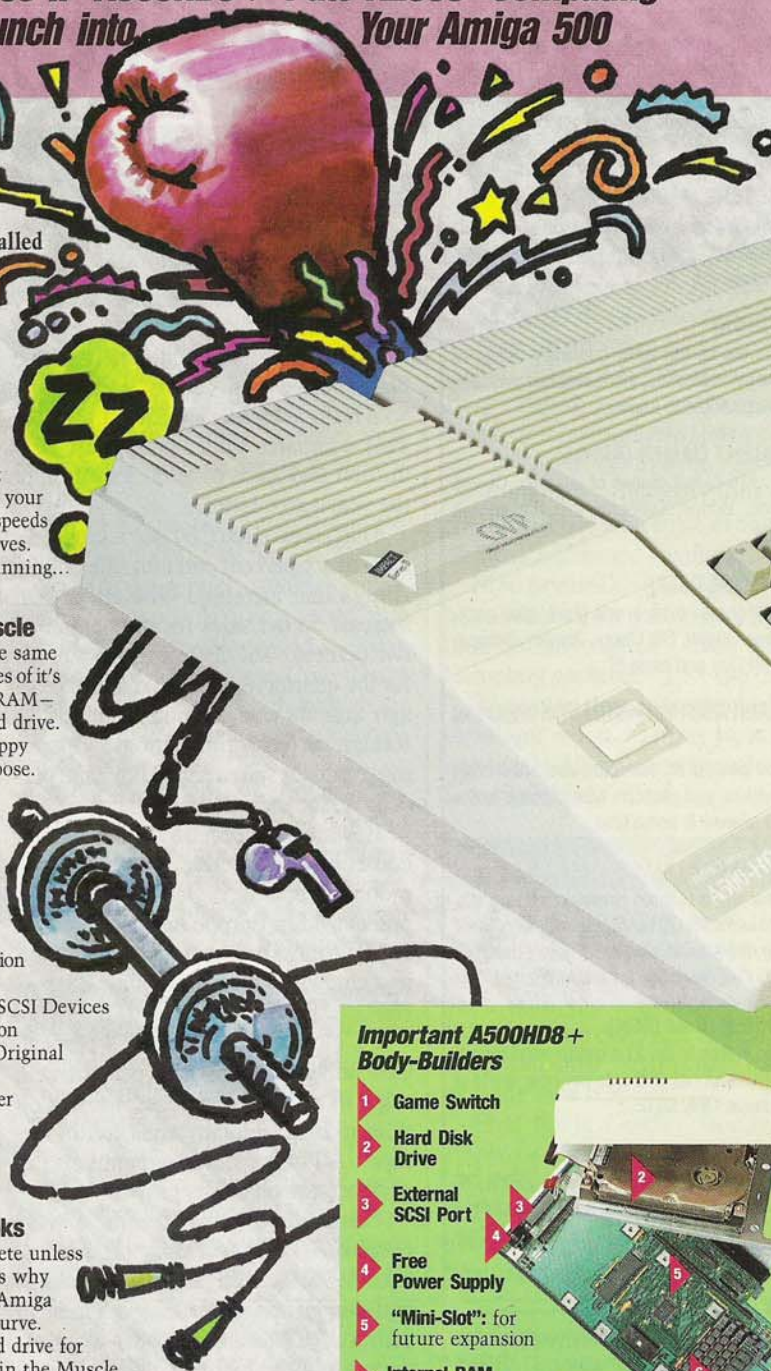

Important A500HD8+ Body-Builders

- 1 Game Switch
- 2 Hard Disk Drive
- 3 External SCSI Port
- 4 Free Power Supply
- 5 "Mini-Slot": for future expansion
- 6 Internal RAM Expansion: up to 8MB

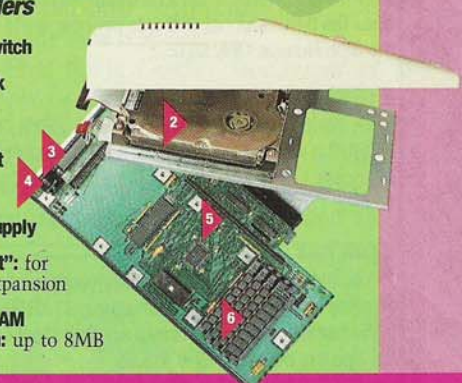

GREAT VALLEY PRODUCTS INC.

IMPACT and GVP are Trademarks of Great Valley Products, Inc. Amiga, A2000 and A3000 are registered trademarks of Commodore-Amiga Inc. UNIX is a registered trademark of AT&T, Inc.

Distributed in
Australia By



P O W E R
PERIPHERALS PTY LTD

1st Floor, 257 Hawthorn Road
Caulfield North, 3161
Telephone: (03) 532 8553
Facsimile: (03) 532 8556

TOP TEN

JACK NICKLAUS GREATEST 18 HOLES OF GOLF (AMIGA)

Tee off on the most challenging 18 holes of major championship golf with Jack Nicklaus, the master golfer who personally chose each hole. Only \$39.95

NECRONOM (AMIGA)

Remember when shoot-em-ups were smooth, fast and colourful? Those days are back with NECRONOM; 32 levels, 48 colours on screen, 11 scenarios, 50 frames per second animations, over 3000 frames in total. Brilliant!

THE MUNSTERS (AMIGA)

1313 Mockingbird Lane will never be the same. Help Herman, Grandpa, Eddie and Lily rescue Marilyn from the underworld.

GEM'X (AMIGA)

Over 400 levels of the most cunningly designed puzzle game ever released, this is instantly playable, but almost impossible to master.

5 INTELLIGENT GAMES (AMIGA)

Play the world's oldest games of strategy; Chess, Backgammon, Bridge, Draughts and the ancient game of Go.

THE BIG BOX (AMIGA)

10 of the best games ever, in one great value package; Teenage Queen, Stir Crazy, Jumpin Jackson, Purple Saturn Day and more !!!

P. P. HAMMER AND HIS PNEUMATIC WEAPON (AMIGA)

More than 50 levels of some of the cutest, most brain wracking ladders and platform type puzzles in the best arcade release in some time.

AMOS 3-D (AMIGA)

Enter the real world of three dimensional programming with the latest AMOS language extension. More than 30 new commands, plus a 3D object designer make AMOS THE language for the Amiga.

STUN RUNNER (C-64 DISK)

Travel ahead in time to the 21st century and experience the 3 dimensional, 900 mile per hour world of the Stun Runner. Only \$9.95.

EYE OF HORUS (C-64 DISK)

Walk like an Egyptian - Fly like a bird ... EYE OF HORUS is a unique mix of arcade and adventure set in ancient Egypt in the time of the Pharaohs. Only \$19.95.

STAR RAY (C-64 DISK)

21 combat waves on 7 worlds, super smooth parallax scrolling and thousands of hostile aliens; STAR RAY is the perfection of the horizontal scrolling shoot em up. See it to believe it! Only \$15.95.

Pactronics Pty Ltd, 98 Camarvon St, Silverwater, NSW (02) 748 4700

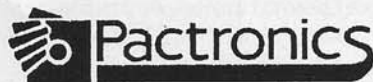

Ram Rumbles

Commodore Doing Fine!

For those interested in the future of their investment, here's a few facts on Commodore and the computer industry in general.

Commodore International Limited has reported first quarter earnings of \$5.3 million on sales of \$204.1 million. This compares with earnings of \$7.0 million and sales of \$200.3 million in the year-ago quarter.

Unit sales of the C64 line increased a total of six percent and unit sales of the Amiga line increased 40% for a total increase in net sales for the quarter of two percent. The decline in gross profit for the quarter as compared to the year-ago quarter was attributed entirely to foreign currency fluctuations. Operating expenses were reduced by nine percent versus the prior year.

Revenues exceeded \$1 billion on four consecutive profitable quarters. Commodore is now second in personal computers sold in Europe last year (behind IBM). Amiga unit volume increased 38 percent with sales increasing 23 percent.

PC clone revenues rose 14 percent. C64 unit growth rose 16 percent with sales increasing 4 percent, mostly on sales in East Germany and Eastern Europe. All major European markets experienced strong sales growth.

Commodore plans to offer a wide range of CDTV accessory products in fiscal 1992, including keyboard, genlock, and storage and networking devices. In addition, Commodore plans to introduce a new video card that will substantially enhance the colour capability of CDTV to over 4 million colours.

The Amiga line accounted for 55% of net sales in 1991 (53% in 1990; 45% in 1989). The Amiga 500 contributed to the majority of sales.

The PC line accounted for 28% of net sales during 1991 (29% in 1990; 24% in 1989). Unit sales were down 3% in 1991 but revenues increased 14%.

The C64 line accounted for 16% of revenues in 1991 (18% in 1990; 31% in 1989).

CDTV sales were nominal due to its release late in the fiscal year.

Market Share

	1991	1990	1989
Europe	84%	75%	69%
North America	11%	18%	24%
Asia/Australia	5%	7%	7%
Total European PC Market = 7,469,500 (SOURCE: Dataquest 4/91)			
OTHER	51.3%		
IBM	14.6%		
COMMODORE	11.8%		
(Last year CBM had 9.5%)			
OLIVETTI	6.7%		
APPLE	6.0%		
COMPAQ	5.7%		
AMSTRAD	3.9%		

Amiga at Work

* In Boston, Logan International Airport is upgrading its tourist information service with an Amiga 3000 system offering full motion videos, still frames of maps, pictures and illustrations, and weather and traffic updates.

* In Europe, similar Amiga 2000 and 3000 systems are already in use in Sweden at Scandinavian Airlines Systems headquarters and at Arlanda Airport in Stockholm.

* At Le Printemps, one of Paris' largest department stores, an Amiga 3000 display presents choices in the selection of wedding gifts.

* Amiga-generated titling, graphics and animation highlighted the 1990 World Equestrian Games in Stockholm, the 1991 International Ice Hockey Championship in Finland, and the 1991 European Soccer Championship in Poland.

* Commodore recently won a major PC contract in Belgium to supply the National Railways, in addition to a major project for Kreditbank.

#1 - AND DRIVE-ING HARD TO STAY THAT WAY!

IMPACT
Series II

Only GVP Factory Installed A2000 HC8+/52Q, 105Q or 200 SCSI Hard Disk+RAM Boards have a track record this good—over 20,000 satisfied Amiga® users and now a 2-Year Warranty!

Don't waste your valuable time or money building a SCSI+RAM Controller from parts . . .

Because of our unprecedented pricing structure you can now get GVP's, brand name, factory installed A2000 HC8+/52Q, 105Q or 200 at a very competitive price.

► **GVP's A2000 HC8+/52Q, 105Q or 200 — THE SAFEST CHOICE**

Look for the GVP Factory Installed Drive Seal . . . it's your assurance that your A2000 HC8+/52Q, 105Q or 200 has been installed and tested in GVP's own factory . . .

And the 2 year limited warranty protects you better *and longer* than any third party installed drive. And with third party drives you run the risk of a run around if anything does go wrong.

► **GVP's A2000 HC8+/52Q, 105Q or 200 — NOW 33% FASTER WITH FAAASTROM™**

All A2000 HC8+/52Q, 105Q or 200 have been redesigned and equipped with GVP's newest fastest SCSI Driver — FAAASTROM 4.0. Plus, we've also doubled Western Digital's SCSI Controller clockspeed to 14Mhz—for a tremendous, 33% increase in speed . . .

► **GVP's A2000 HC8+/52Q, 105Q or 200 — JUST LOOK AT THESE FEATURES**

- Custom chip design for the fastest possible data transfer rates and DMA performance—even in a multi-tasking environment.



- Easy-to-Install SIMM memory modules for configurations up to 8MB—and support BridgeBoard users with the 6MB FAST RAM.
- Support for virtually any SCSI device.
- Fastest and easiest SCSI installation possible.

► **GVP's A2000 HC8+/52Q, 105Q or 200 — JUST LOOK FOR THE GVP FACTORY INSTALLED SEAL**

Remember if the GVP Factory Installed seal shown in this ad isn't on your A2000 HC8+/52Q, 105Q or 200 box . . . it isn't the fastest, most powerful, longest warrantied, safest A2000 HC8+/52Q, 105Q or 200 you can buy.

Ask for and accept only GVP A2000 HC8+/52Q, 105Q or 200 with the *Factory Installed* seal. For more information call **215-337-8770**.



Up to 8MB
FAST RAM
Expansion

Factory Installed
3.5" Hard Disk
Drive

GVP Custom
VLSI Chip

GVP Factory
Installed Seal

GVP
GREAT VALLEY PRODUCTS INC.



Distributed In P O W E R
Australia By PERIPHERALS PTY LTD

1st Floor, 257 Hawthorn Road, Caulfield North, 3161
Phone: (03) 532 8553 Fax: (03) 532 8556
Amiga is a registered trademark of Commodore-Amiga, Inc.

Notepad Notepad Notepad

Special Report: Amiga Laptop Dream or Drawing Board

In recent times, there has been a bit of discussion about a possible Amiga laptop and of what happened to the German third party laptop shown in CeBitt so long ago. A German company called GigaTron said, back in 1988, that they were working on an Amiga laptop. In 1989 it was reported that GigaTron had shown two models at CeBitt Fair in Munich; one with a gas-plasma display and one with an LCD display - both 16 shade monochrome.

The company announced that the displays were capable of rendering every Amiga screen, though HAM wasn't the best and neither was half-brite. They stated that the screens were developed with the direct assistance of Commodore UK, who had expressed utter amazement that anyone other than CBM could make an Amiga motherboard.

The price was set at around \$3500 for the LCD model and \$4000 for the gas-plasma. Nothing further came out for over a year. The machine was a 68000 based but with two special slots, one for a modem or fax/modem and one for an accelerator.

Finally, a major publication printed in its rumours column that Commodore had killed the project with threatened lawsuits over the motherboard - they didn't want the competition. No confirmation of this has ever been obtained, and that is where it stands today.

Feasibility

Is a laptop Amiga feasible? Well, everyone else has one; IBM, Apple (which is reported to have three more in the works - one pen based), and Atari (which is reported to have two more in the works - one pen based) all have working laptops. Commodore makes a notebook 286PC with a 386 in the final stages of testing. Why no Amiga?

Well, the Macintosh is basically a monochrome system, so there is no conflict since colour is an add-on. MS-DOS machines have numerous monochrome setups, the most prolific being Hercules and VGA mono. The Atari has a couple of monochrome settings, too - so that really isn't a problem. The Amiga, on the other hand, has no basic monochrome setting (except for the dual-paged A2024 display for DTP). The Amiga touts colour and animation as major features. Can you see a monochrome Amiga? Yes, if you look hard enough.

Display Possibilities

The Amiga does have support for some super-hires monochrome screens (Viking & A2024 monitors) aimed at DTP. How many are out there and how many programs support them? Not many programs other than DTP itself support mono Amiga. High persistence phosphors and matrix displays

make animation impossible. Other modes are best used with colour - or are they?

The newest Amiga operating system, release 2.04, comes with the A3000 and has default colours in the grey scale. The 3-D embossed look is great and easily obtainable with a grey scale palette. Is this a "buffer" step, to ease the transition to possible monochrome Amigas?

The newest manual, the Amiga User Interface Style Guild stresses the ability of programs to look good on monochrome screens. What is Commodore up to?

Is monochrome necessary for a laptop?

Current colour LT technology is getting better. There are both VGA color (16 colours on a 640 x 480 screen) and better (4096 at once) currently available in quantity. Even better screens (one touted in a major PC publication as equal to or better than a regular monitor) are on the way. The barrier is price. Screen with case start at about US\$2500, not including computer - and that is rock bottom (in quantity, too). Expect to pay between \$3500 and \$4500 rock bottom for a colour Amiga LT (68000 based) with 16 color hires. Prices of \$4500 to \$5500 for full colour Amigas would be the norm. Expect introductory and list prices to be about \$1000 above those numbers - if one were produced in today's market.

Is colour necessary?

All laptops I have seen include an external monitor plug. I cannot see doing colour-intense art on a laptop. I can see finalising a multimedia script using *The Director* or *AmigaVision*, word processing, recalcing a spreadsheet, etc. while on a plane/train/automobile. Artwork is so time consuming that trying to cram it in on the plane before the big meeting is asking for trouble. A monochrome Amiga LT would be useful, and darned right powerful with an external video jack.

What processor?

Not the 68000, that's for sure. An Amiga LT should include a 16 MHz 68030/68881 combination to ensure

GVP Enters the **SOUND ZONE**

With the most powerful, comprehensive 8-bit Digital Sound Package to ever orchestrate an Amiga

Digital Sound Studio

The Affordable Answer to Your Audio Dreams

Record, Edit, Compose . . .

With a high-quality stereo sound sampler, A fast, powerful, easy-to-use sound editor, And a self-contained 4-track sequencer.

For all the sound effects and music you could ever imagine.

► **Record** sound samples from any source, including voices, noise, and pre-recorded instruments, to create your own instruments and effects.

► **Edit** sounds quickly in real time. Add effects like reverb and echo, run sounds backward, alter wave forms, cut and paste sound segments, create loops, eliminate pops and scratches.

► **Compose** easily using the DSS 4-track sequencer and your Amiga or MIDI keyboard. Draw from up to 32 instruments at a time, in up to four octaves with 8 different variable effects. Mix and modify sounds in real time as you compose, through direct interface with the sound editor.

DSS Stretches the outer limits of 8-bit sound

- Create your own 4-track, self-playing musical compositions.
- Make soundtracks for home video, animation or visual presentations complete with voice-over, sound effects and music.
- Analyze voice patterns and stereo separation.
- Analyze graphic equalization of real-time sound.
- Remove "pops" from old phonograph recordings.
- Create custom instruments and sound effects by collecting and/or modifying pre-recorded instruments, voice, or sounds from any source, and use them in your own compositions.
- Save your sound and music to disk or send it out via modem for replay on any Amiga.

Check out these unparalleled features

- ✓ AmigaDOS 2.0 compatible; written in assembly language.
- ✓ Multi-tasking operation.
- ✓ 68020 and 68030 compatible.
- ✓ Comprehensive tutorial manual helps even beginners get started right away.
- ✓ Intuition-based graphic interface makes operation easy.
- ✓ MIDI-in capability.
- ✓ Direct interface between sequencer and editor.
- ✓ Hold 32 sound samples in memory at once — all shown on screen so they are easy to manipulate.
- ✓ Effects and processing capabilities include echo, mix, filter, re-sample, sound data inversion, playing sounds backwards, loops, fade-in/fade-out and more.
- ✓ Manipulate sound samples in real time, as you listen.
- ✓ Create sampled instruments with 1, 3 and 8 octaves.
- ✓ HIFI recording for highest quality playback.
- ✓ Controls for faster/slower playback and filtering high frequencies during playback.
- ✓ Load and save samples, songs and instruments in multiple formats.
- ✓ Multiple effects for each note.
- ✓ Stereo and monophonic operation. Also convert mono to stereo or separate stereo.
- ✓ Auto-playing music modules.
- ✓ Real-time oscilloscope and spectrum analysis.
- ✓ Real-time reverberation.
- ✓ Graphic editing of wave forms through easy-to-use functions, including zoom in/out and precision controls for position, frequency and amplitude.
- ✓ Draw sound waves freehand using the mouse.
- ✓ Direct editing of individual sample numeric values.
- ✓ Maximum recording speed of 51,000 samples/second in stereo.
- ✓ Savable Preference settings.
- ✓ Saves in IFF, SONIX or RAW formats.
- ✓ Compatible with SoundTracker, NoiseTracker and SoundFX modules.



DSS

DIGITAL SOUND STUDIO

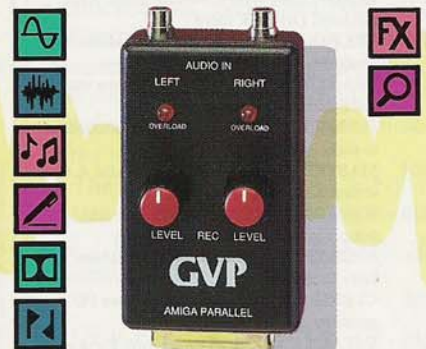

GVP
GREAT VALLEY PRODUCTS INC.

Distributed In P O W E R
Australia By PERIPHERALS PTY LTD

1st Floor, 257 Hawthorn Road, Caulfield North, 3161
Phone: (03) 532 8553 Fax: (03) 532 8556

Amiga is a registered trademark of Commodore-Amiga, Inc.

TEXTILE PRINTING

Use your home computer as a textile print shop.

With our special Heat Transfer ribbons, you can print your reversed graphic image onto regular printer paper, which becomes an iron-on textile transfer.

SELECTED PRICES for H.T. RIBBONS

Commodore MPS803	27.50
Citizen 120D/GSX140 mono	29.50
Citizen GSX 140 4 colour	49.50
Epson LX/LQ400/800	31.50
Epson LX80/86	27.50
Star NX1000 mono	27.50
Star NX1000 4 colour	39.50
Star NX/XB24 10 mono	31.50
Star XB/15 4 colour	44.50

* monochrome ribbons available in Black, Red, Blue, Green, Yellow

Lazarus Ribbons

70 Wolseley Rd tel: (02) 960 2737
Mosman (008) 24 9991
NSW 2088 fax: (02) 968 1276

AMIGA PD

CHOOSE ANY 4 OF THESE DISKS FOR ONLY \$16

- U202 **DCOPY** Fast & efficient disk copier. One drive or more.
- G100 **DRIP** Top quality game. A cross between Pipemania & Pacman.
- G104 **ZERG** Ultima-style adventure game. Also Pontoon, Daleks & more.
- G108 **YELP** Good game. Paint the grid, avoid monsters, collect bonuses.
- G113 **FRANTIC FREDDIE** Platform game with unlimited lives option.
- G120 **JUMPY** Addictive ball game and level editor to make your own.
- U204 **MASTER VIRUS KILLER** Powerful & easy to use. Knows 124 strains.
- U210 **ICON DISK** Icon designers & over 220 sample icons. All you need.
- B101 **AMIBASE** Good budget priced database. Easy to use.
- B102 **CLERK & BANK'N** Two of the best PD accounts & chequebook programs.
- D003 **IMPACT DEMOS 5** Demos from Europe. Great graphics & sound.
- E001 **TALKING COLOUR BOOK** Draw and colour in. Great for kids.

The latest and the best of Amiga PD. Free Catalogue with every order. All disks thoroughly checked. 4 Disks - \$16. Additional disks \$4 each. Quote the disk numbers you require and enclose cheque or money order payable to Brunswick Publications. We pay postage. Immediate delivery.
Order From: BRUNSWICK PUBLICATIONS
PO Box 458
Bondi Junction NSW 2022.

that it can run Unix V.4. The 030 would be better than the 020 because Unix requires a PMMU which is built into the 030 and separate with the 020 (68851 to be exact). Price may be a bit higher, but power consumption would be much better. CMOS is necessary in order to lengthen the battery life.

Ideal machine?

My ideal (but realistic) Amiga LT would consist of the following:

A 16 MHz 68030/68881 based machine shipped with 1 Mb chip RAM (DIPs for second meg) and 1 Mb fast RAM (with inline ZIP sockets for up to 16 Mb of fast RAM -- same as the A3000). I don't consider a built-in floppy necessary (I almost NEVER use mine on my A2000), so an external connector would be fine.

A choice of 40/60/80 meg hard drive

(2+") built-in is mandatory. A choice of paper-white VGA screen or colour for the rich people and fanatics. VGA, small parallel, SCSI and audio out (Y-split necessary for stereo) on the back.

A dedicated socket for a modem card and a single Zorro II slot. The keyboard should be based off of the Mac Portable or the IBM LT with a side jack for an external keyboard. A single joy/mouse port and clock.

Bring it in under five pounds (so I'm dreaming) and a battery life no shorter than three hours, two with intense hard disk activity. Price it at \$3000 for the 40 Mb mono and \$4500 for the 40 Mb colour (list). Modem card for \$99, fax/modem for \$199.

Hopefully Commodore will look favourably on the idea of a laptop Amiga, or at least encourage a third party to develop one.

Technosound Turbo

Kaotic Concepts is releasing the new "Technosound Turbo" sound sampler/sequencer package for the Amiga, from U.K. manufacturer New Dimensions.

The package includes hardware necessary for recording samples, and software for sample manipulation, and sequencing. The software allows the user to produce effects such as phasing, pitch-shifting, real-time echo, unusual vocaliser effects, and much more in full stereo.

The Technosound Turbo has received good reviews overseas and offers an excellent opportunity for the novice to enter the exciting world of sound sampling. It is available now from Kaotic Concepts for \$79. (03) 879 7098.

WordWorth 1.1

As predicted, *WordWorth* is receiving continued support from the publishers, Digita International. Version 1.1 will ship soon with a number of major improvements including a full postscript driver for the standard 35 Adobe fonts with accurate on-screen representation.

Page Preview has been added, with

support for displaying the text, graphics, margin guides, headers and footers.

There's now internal font support for some 140 printers, with special on-screen WYSIWYG version of all fonts. For fast typists there's a new quick-screen mode.

Picture scaling has been improved and there's now support for colour NLQ printing. All in all, a very worthwhile upgrade. All it needs now is footnotes! For more information call Pactronics on (02) 748 4700.

ProWrite 3.2

Another major upgrade to a popular wordprocessor is the release of *ProWrite* 3.2. The new version includes full in-built postscript support, jaggie-free dot-matrix output and a whole new look to the program. The options requestor now enables full control over screen colours, with colour support for graphics also improved considerably. *ProWrite* now has a handy speak option - either as you type or a whole document.

ProWrite claims to import and export *Professional Page Text* - part of the new improved file requester. For paranoid typists, there's now an auto-save option which will save your document every so

TechnoSound Turbo

Upgraded version of New Dimensions' acclaimed hardware and software stereo sound sampler. Simply plug your sound source into the unit and fire up the sampling software. New multi-tasking software features a MIDI sequencer, and a host of exciting special effects including real-time echo, phasing, pitch shifting and other voice synth effects. "...no-nonsense, low-cost, easy-to-use system..." 81%, Amiga Format, September 1991

\$79

2 Meg for A500

The 'V2000' expansion from U.K. manufacturer Virgo Developments contains a real time clock/calendar and up to 2 MB of auto-configuring Ram. The board plugs into the trapdoor expansion bay and connects to an internally fitted Gary adapter.

Unpopulated (0 Megabytes)	\$140
Populated to 0.5 Megabytes	\$178
Populated to 1.0 Megabytes	\$218
Populated to 1.5 Megabytes	\$258
Populated to 2.0 Megabytes	\$298

4 Meg for A500

The 'V4000' system is similar to the 2 Meg. system described above, with additional sockets allowing up to 4 MB of expansion RAM.

Unpopulated (0 Megabytes)	\$220
Populated to 1.0 Megabytes	\$299
Populated to 2.0 Megabytes	\$379
Populated to 3.0 Megabytes	\$458
Fully populated (4 Megabytes)	\$539

Both the 2 meg. and 4 meg. boards leave the main expansion bus free (e.g. for a hard drive).

Also from Virgo Developments:

3.5" External Disk Drive \$170

Protar Hard Drives

The Last Word In Amiga Hard Drives

The new **A500HD** series of SCSI controlled hard drives from the German manufacturer Protar are now available in Australia available. The standard drives contain high quality 24ms Seagate mechanisms, while the DC range use 19ms Quantum mechanisms with 64 kb cache. These superb drives use the main expansion port & perfectly match the Amiga styling. The optional PSU is only required when RAM modules are installed.

- high speed SCSI controller (900kb/sec or 5 times A590 speed)
- SCSI through port
- auto-booting, auto-parking, silent operation
- up to 8 MB RAM on board via Protar autoconfiguring RAM modules
- Games switch disables hard drive but retains RAM for memory hungry games, protecting the hard drive against viruses.
- **2 Year Replacement Warranty** on Quantum units (One Year for Seagate units).

A500 HD20	\$620	1 MB RAM module	\$75
A500 HD40	\$710	2 MB RAM module	\$145
A500 HD50	\$820	4 MB RAM module	\$323
A500 HD50DC	\$985	8 MB RAM module	\$646
A500 HD60	\$1015	Power Supply Unit	\$62
A500 HD80	\$1105		
A500 HD100DC	\$1175		

Protar 1/2 Meg. + Clock/Calendar

Top quality surface mount design. Disable switch.

\$75

C64

KCS Power Cartridge

- POWER RESET
Freeze and backup any program
- POWERMON
Powerful Machine Language monitor, that leaves ALL memory free for programming.
- Printer Tools
Screen-dumps, rotate print, self-detects printer interface.
- Powerful BASIC toolkit
more than 20 new commands.
- Disk Tools
Load 6 times faster.
- Tape Tools
Works 10 times faster

\$49



Kaotic Concepts

Pty. Ltd.

Trade Enquiries welcome.

Mail Orders:

Kaotic Concepts P/L
GPO Box 2150T or c/- Underbool P.O.
Melbourne 3001 Victoria 3509

Cheques/Money orders payable to 'Kaotic Concepts Pty Ltd'.

Phone orders: (03) 879-7098 or (050) 94-6358

Fax: (03) 819-5531 Please quote your credit card number, card type (Bankcard, Mastercard, or Visa) and expiry date. Please add \$3.50 P&H for all orders except for P.D. Paks & catalogue. Courier service \$10. E&OE

Cortex

A500/A1000 8 Meg Expansions

- Fit to expansion bus: warranty remains intact
- Fully implemented auto-configure
- Fully operational bus pass-through
- Uses standard 1M x 8bit or 1M x 9bit SIMMS
- Designed with A1000 compatibility in mind
- Zero wait states
- RAM test software

0 meg.	\$425
2 meg.	\$580
4 meg.	\$734
6 meg.	\$888
8 meg.	\$1042

P.D. Software Paks

Kaotic Concepts supports the intentions of public domain authors; namely to allow wide distribution of software with minimal copying charges. All Pak prices include postage and handling. These disks plus FISH and many more are available individually for \$2.50 plus \$3.50 P&P for any size order. Catalogue disks \$2.50 including postage. All disks supplied are Nashua brand. Blank disks \$15 per box of 10. Nashua disk boxes (hold 90 3.5" disks) \$17.00

Kaotic Arcade Parlour Paks: 5 disk Paks of arcade action \$12 per Pak

Kaotic Arcade Pak 1

Megaball, Missile Command, Sball, Dragoncave, Car, 7-Tiles, Grid-Runner, Rebound, Invaders, Mintblast.

Kaotic Arcade Pak 2

Sys, Slotcars, Tron, Cat & Mouse, Shark, Galactic, Worm, Ball, Moonbase, Mirrorwars, Steinschlag, Running, Drip, Spacewar, Cosmo2, Flaschbeitr, Blizzard.

Kaotic Arcade Pak 3

Pacman-87, Grl-Action, Hemroids, ST-Bash, Grav Attack, Eat Mine, Hovertank, Humartia, Triclops Invasion.

Kaotic Label Laboratory

2 disk set containing: Labelbase3, RLC210, Diskprint, SuperRetLab plus ready made labels. \$6

Kaotic Font Theme

3 disk set containing fonts and font utilities. \$8

Kaotic Brain Strain Games 7 disks full of the best Brain Taxing Games \$17

Kaotic Klip-Art 10 disk compilation \$23

Kaotic Concepts Kaos Kompilation 7 disks of stunning Mandelbrot and Julia sets \$17

Kaotic Icon Laboratory 2 disks full of Icon Programs and Icons and many icons ready to use

Iconify	Snap	Vernicon
Iconj	Iconmaster	Iconlab
Iconizer	Xicon	I.E.
Iconed	Image-Ed	Ifficon
Smarticon	Icon Maker	Iconmk
		\$6

Kaotic Games Paks 5 disks of playable demos \$12 per Pak

Kaotic Games Pak 1

Turrican II, Xenon II, X-out, Blood Money, Dan Dare II

Kaotic Games Pak 2

Gods, Magic Pockets, New Zealand Story, Flood, The Plague, The Secret of Monkey Island

Kaotic Game Pak 3

Hammerfist, The Power, Moonshine Races, Wipeout, Ghostbusters II, Mega-lo-Mania

Any 2 Games Paks \$23

Mega Kaotic Games Pak (all 3 Game Paks) \$34

many minutes provided you've stopped typing. If you haven't, ProWrite waits until you have. Clever stuff! For more information call Computermate on (02) 457 8388.

BYTE Magazine likes A3000UX

A few quotes from a review of the Amiga Unix machine, from Byte Magazine: "...The Amiga 3000UX greatly outperforms the equivalent NeXT and Mac with A/UX... it is much more suited to handling the graphics requirements of a graphical user interface like Open Look..."

MegaMicro Technology

Norm Jackson, long respected as a fine engineer/product designer for the Amiga market (he designed the MicroMags and Tiny Tiger for MAST, among other things), has released a product which he will market directly, called the SCRAM 500, a SCSI RAM controller for the A500.

According to his press release, its specifications include: tiny footprint; 0 to 8 megabytes of fast RAM with 1meg or 4meg chips supported; Ram configurable as 2, 4 or 8 Meg; Full, fast SCSI hardware and software - Syquest, tape and CD-ROM compatible and an accelerator upgrade path.

Sounds very good! This could be the way to make your A500 zoom at low cost - \$349 with no RAM, \$499 with 2 megabytes fitted. For more information, send SAE to: MegaMicro Technology, P O Box 511, Bondi Junction, 2022 or Fax: (02) 363 1246

Phoenix Update

An A-Max II hard disk driver for the Phoenix Board is now available, allowing A-Max to use a partition on the Phoenix Board's hard disk as a bootable Macintosh disk. The driver will be sold separately and also bundled with A-Max II.

The Phoenix Board SCSI driver now supports Commodore's SCSI-Direct pro-

ocol, which allows software to talk to any SCSI device (such as a tape drive, scanner etc) in a manner compatible with most SCSI controllers on the market. All current controllers from Commodore, GVP, MicroBotics, IVS etc. support the SCSI-Direct protocol. More information and programming assistance is available from Michael Warner.

Revision F upgrade now available to the SCSI controller - over 50% faster, and some bugs fixed. You can get a kit consisting of EPROM and disk for \$25.

Tape Backup: Michael Warner and Jon Potter are collaborating to produce a hard disk backup utility which will support SCSI streaming tape drives and floppy disk backup a la Quarterback. This utility will work with the Phoenix Board as well as most other SCSI controllers on the market. A demo version will be made available as soon as possible. Phoenix would like to hear from anyone with access to a SCSI tape drive interested in beta-testing the utility. Your name will go up in pixels! The Canon MO drive (see below) may also be supported.

Phoenix are considering development of support software for Canon's erasable Magneto-Optical SCSI drive, as used in the Next workstation.

Two Kickstarts on a Board

If you're trying to keep things compatible, Unitech Electronics P/L have a neat little bit of hardware called the KickBoard. It handles two Kickstarts on one board, making it easy to switch between the two. Will it work with Workbench 2.0? We'll wait and see - but it would certainly be worth having as there is the odd game or two which doesn't like 2.0. For more information telephone (02) 820 3555 or write to 8B Tummul Place, St Andrews.

Piranha Graphics

Simon Hart sent us in a letter with a very good-looking logo, and the following text: "Programmers: Need graphics, sound samples or music for any type of program or game? Call Piranha Graphics - we pride ourselves on producing

maximum quality work for low prices. Call Simon Hart on (03) 789 6544 for information or to ask about our demo disk." Address: 5 Ballymore Crt, Frankston, VIC 33199.

Desktop Publishing Bureau

Desktop Utilities is an Amiga-based postscript output and file transfer bureau. Files can be sent on disk, or uploaded in Postscript ASCII or certain document formats from any system to be printed at 300 dots per inch. They can read disks in Amiga, IBM (360 & 720K), Mac (800K) and Atari ST formats, and transfer files between formats on 3.5" or 5.25" disks.

Desktop Utilities operate a Bulletin Board and message line which are available most hours, seven days a week.

There is also a scanning service using Sharp scanners. For more information telephone (062) 396658 or Modem (062) 396659.

Digital Film Recorder Bureau

David Jacobs is accepting images for outputting on a Digital Film Recorder, which is basically *Digiview* in reverse. The Film Recorder separates an image into its Red, Green and Blue components and displays each component onto a high resolution black and white monitor. The exposure is taken by a camera through corresponding Red, Green and Blue filters.

This produces results that are free of the phosphor dot texture of normal colour monitors as well as giving better colour reproduction. David is also able to remove the dark raster lines that are visible in non-interlaced images.

For a sample slide, send \$1.00 and a SASE (Self Addressed Stamped Envelope) or for \$3.50 and a SASE. David will output one of your images as a sample. All Amiga display modes are supported including HAM, Overscan and Dynamic-Hires. In the near future, he hopes to offer full 24-bit (16.7 million colours) output. Creations, 120 McGilvray Avenue, Noranda, WA 6062. If you have any queries on the

MEET THE CHAIRMAN OF THE BOARDS

68030 Power, Up to 16MB RAM and SCSI Controller All in One

IMPACT
Series II

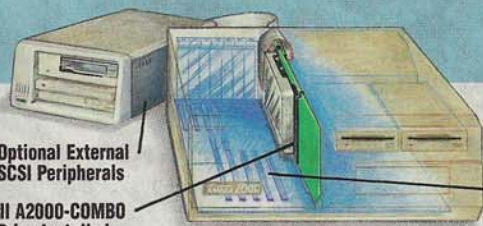

Optional External SCSI Peripherals

SERIES II A2000-COMBO + SCSI Drive Installed

All A2000 Expansion Slots Free

This single GVP SERIES II A2000-COMBO board gives you more power, performance and control over your Amiga® system than any 4 other boards out there.

You want to expand your Amiga's memory?... the SERIES II A2000-COMBO does it and does it big.

You want to make your Amiga faster than a speeding bullet?... the SERIES II A2000-COMBO does that too.

You want to use your Amiga with virtually every and any SCSI device on the market—from CD-ROM drives, to Magneto-Optical and tape-based storage devices?... the SERIES II A2000-COMBO does it all.

You want all the storage capacity of a 3.5", 500MB hard drive on a single card?... Yep—It's an option.

You want to save lots of time with your desktop publishing, ray-tracing, rendering and animation programs?... Nothing's faster than the SERIES II A2000-COMBO.

You want to use your Amiga as a special effects generator for broadcast

quality videos?... the SERIES II A2000-COMBO perfectly complements New Tek's Video Toaster™ special effects system.

Plus, when you install the SERIES II A2000-COMBO board directly into your Amiga's CPU accelerator slot, you still have all 5 of your original expansion slots open and free for other uses.

If that doesn't make the SERIES II A2000-COMBO the *Chairman of the Boards*, we don't know what does.

For more information on how you can put the Chairman of the Boards—SERIES II A2000 COMBO—to work for you, call 215-337-8770.

IT'S LIKE AN ENTIRE FACTORY ON ONE BOARD

Just look what you get from this workhorse, powerhouse:

- ✓ 33 or 22Mhz 68030 Accelerator
- ✓ Up to 16MB of fully DMA-able 32-bit wide memory expansion (13MB on 22Mhz model)
- ✓ High Performance, Auto-Booting, DMA SCSI Hard Drive Controller able to DMA directly into ALL memory
- ✓ SCSI Connector for External SCSI Peripherals
- ✓ Screen Icon-Based 68000 Mode Switch

Optional "Hard-Disk-Card" Conversion Kit

Converts the SERIES II A2000-COMBO board into a "Hard-Disk-Card" as well! Drive mounts on the back of the board, saving even more space!

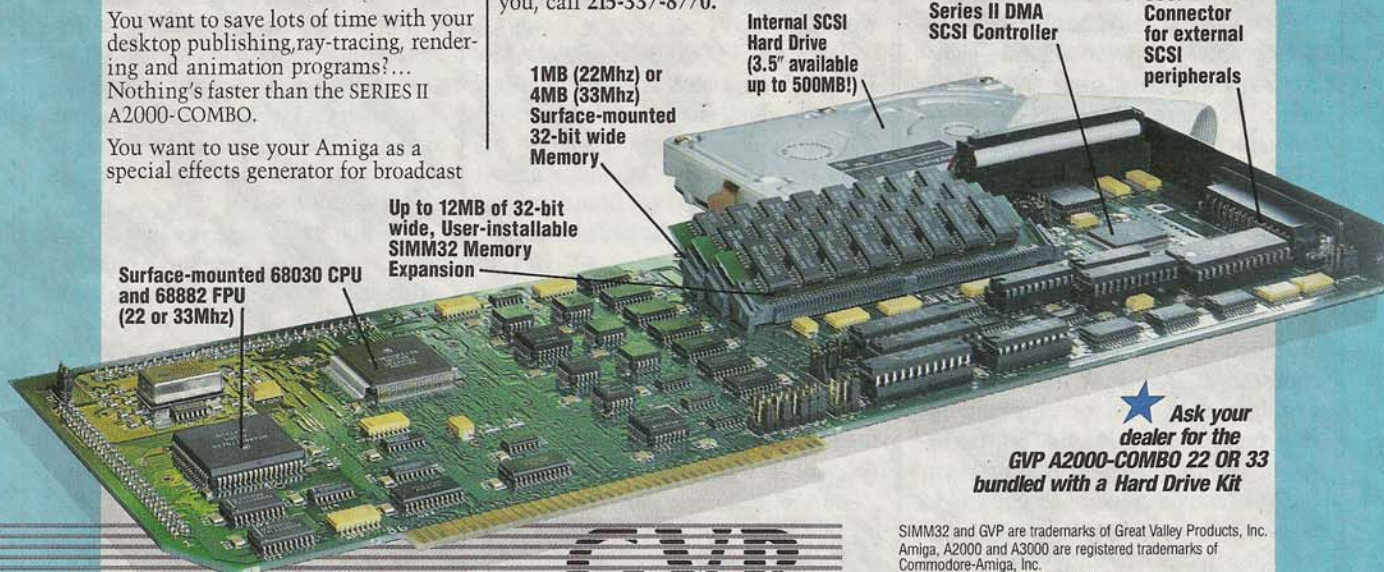

1MB (22Mhz) or 4MB (33Mhz) Surface-mounted 32-bit wide Memory

Internal SCSI Hard Drive (3.5" available up to 500MB!)

Built-in GVP Series II DMA SCSI Controller

SCSI Connector for external SCSI peripherals

Surface-mounted 68030 CPU and 68882 FPU (22 or 33Mhz)

Up to 12MB of 32-bit wide, User-installable SIMM32 Memory Expansion

★ Ask your dealer for the GVP A2000-COMBO 22 OR 33 bundled with a Hard Drive Kit

SIMM32 and GVP are trademarks of Great Valley Products, Inc. Amiga, A2000 and A3000 are registered trademarks of Commodore-Amiga, Inc. Video Toaster is a trademark of NewTek Inc.

GVP

GREAT VALLEY PRODUCTS INC.

Distributed In Australia By



P O W E R
PERIPHERALS PTY LTD

1st Floor, 257 Hawthorn Road, Caulfield North, 3161. Phone: (03) 532 8553 Fax: (03) 532 8556

output service, call David Jacobs on (09) 276-7850 between 8am and 5pm (Perth Time), Monday to Friday only.

Rexx Plus Compiler

For US\$150, you get a Compiler which the distributors claim gives greater speed, more built-in functions, better error messages and greater efficiency, in that the compiler generates re-entrant code. However, "Rexx" not "ARexx" is mentioned, and I've never heard of this company before, and there were two spelling mistakes in a short ad... so beware. More info from: Dineen Edwards Group, 19785 West Twelve Mile Rd, Suite 305, Southfield, Michigan 48076-2553. Tel: 313 352 4288.

RxTools

While on the subject of ARexx, this US\$55 program lets you easily design and build user interfaces into ARexx programs, linking the ARexx text interface to Amiga's Intuition interface - RxTools lets you handle Intuition manageably, giving you windows, gadgets, requestors, and more with minor pain. For more info: TTR Development, Inc., 6701 Seybold Rd, Suite 220, Madison, WI 53719. Tel: 608 277 8071.

Fractal Engine

With mainly games in mind, Psygnosis has shown this inventive new approach to programming - either the computer can recreate a fractal gaming world animation with some interactivity or a portion of the screen can be reserved for real-time fractal animation in full interactive mode. The hope is to merge both computer animation and real-time fractal technology into a quick interactive product. The technique could have quite widespread application in education as well as gaming. (See below for more on fractals.)

Schematic/PC Design packages

Centaur Software has shipped four new packages which are really two versions of a pair of complementary packages called *Pro-Net Personal* (US\$179.95) and *Pro-Board Personal* (US\$179.95). The first of these is the artwork generation half and is called an "intelligent, single line auto-router with high density capability", and has many features. The Professional versions of this pair cost US\$499.95 each and the basic difference is the post-processing capabilities, which are extensive.

For more information:

Centaur Software PO Box 4400, Redondo Beach, CA 90278. Tel: 213 5422226.

Art Department Modules

ASDG has released some new additions for their *Art Department Professional* image processing software.

Professional Conversion Pack - For US\$90, provides conversions for Targa, TIFF, and Rendition format 24-bit files, often used in high-end graphics workstations.

Polaroid CI-3000 Digital Palette for US\$4495 (!) which is a digital film recorder which guarantees accuracy to 24 bits, with an image resolution of 2048 x 1638 pixels. Provides camera backs for 35mm and Pack film; autofilm and 4x5 camera backs are also available.

The Polaroid CI-3000 Driver gives complete control over the beast from within ADPro, meaning that anything you can load into ADPro can be dumped to film in the CI-3000. So if you've got money, and need good images, this is the way.

South African Amiga Magazine

Peter Mazurek sent in a magazine called "AmigaSA" which he picked up on a trip round the Horn, mainly because it's the first mag he's come across which is bi-lingual, having mainly English articles but breaking into Afrikaans without warning from time to time, very

odd. Looks like we're well served for magazines here in comparison.

New Music Software from Blue Ribbon

Three new products have been announced from Blue Ribbon SoundWorks, the guys who brought us *Bars and Pipes*.

JAM! - Seems to be an imminent MIDI sequencer/music program for the rest of us, ie easy to use. It allows more than four sampled sounds at a time, mixes samples on the fly, includes a TurboSound editor, which means you can edit IFF samples to use with *Jam!* *Jam!* can be run together with *Bars and Pipes Professional*. Look for release in Australia early '92.

Bars and Pipes Professional now supports Sunrize Industries' sampling cards thanks to a new tool letting you access Studio 16 sampling. Each Sunrize sampling card will be released with the appropriate software. There's also a new Tutorial Kit which contains several tutorial lessons for *Bars and Pipes Pro*.

Pro Studio Kit is aimed at professional musicians and is an add on for *Bars and Pipes*. It contains an articulation modifier, DeFlam, DeGlitch, event smoother, Feels Good and a bunch of the things... (someone want to explain all about this to us?).

Finally, the Creativity Kit - (talk about spin-offs!) - Contains a bunch of extra tools such as Accent Randomiser, Auto Modulate, Riff-chord and others. For more information call Dataflow on (02) 331 6153.

New from Progressive Peripherals and Software

Diskmaster II - the old favourite is back, better than ever. I'm told it's very powerful and easily configurable. Watch for a full review soon - along with local competition, *Opus Professional*.

For video buffs, the *Video Blender* doesn't require TimeBase Correction, is configurable to PAL or NTSC and features include: 16 million colours; key-

ing; key in; black burst; loop through; stereo audio mixing; luma keying; sequenceable; genlocking and more. Should be available early '92.

IntroCAD PLUS - the easy to use CAD package now has an accelerator version to speed up use on an accelerated Amiga, along with numerous other improved features.

Ultra Design - called a professional CAD system - the release indicates that this is a very powerful package. For more information call Computermate on (02) 457 8388.

Compuserve

Fujitsu has been bringing Compuserve to Australia since July this year, to "provide substantial cost savings and local support for Australian and NZ subscribers", as they say. If you're willing to pay serious money per minute you can get on to all kinds of useful databases and networks and services.

New ones include World Report (350 stories each day); Sports Report; and Community Report (European, that is). You can also, for example, get all the quality British newspapers online, and they just started a special forum on the Soviet crisis. More info from: Stuart Broad, Tel: (02) 410 4453.

Hayes makes HAY Legally

Hayes Microcomputer Products, Inc., which "owns" the Hayes Commands Patents, sued Everex Systems, Inc. over its use of them without permission and won the case and \$2.5 million damages on the 21st August. Juicy for Hayes - now others are being careful to pay royalties.

Westcomp Computers Moves

Lou Lucano, who runs "the largest shop and is the biggest Amiga dealer in the Central West of NSW" wants to let you know that Westcomp are now to be found at:

96 Bentinck St, Bathurst NSW 2795.

Quality RapiSoft Public Domain

To celebrate one year of operation, RapiSoft is proud to announce three new Public Domain packs: *The RapiPack Vol #2*, *The Ultimate Games Pack Vol #2* and *The Dynamic Demo Pack*. All packs contain loading instructions and have been extensively tested for viruses. Prices include postage. Most orders are dispatched within 24 hours of receipt.

The Ultimate Games Pack Vol. #2

\$27

Following the success of our ever-popular Ultimate Games Pack, we are proud to announce another Games Pack. This pack contains eight disks full of Amiga Public Domain and Shareware Games. From action, strategy to role playing and trivia; there is something in this pack for everyone. Over 40 new games are crammed into the pack, some of which are: *BattleMech*, *Bullrun*, *Castle of Doom*, *Chess*, *Dtris*, *GridRunner*, *Invaders*, *Megaball*, *Rebound*, *Sky-Fight*, *TrekTrivia*, and many others! A small amount to pay compared to the amount of enjoyment you will get out of the pack. For only 68 cents a game, it's an offer not to miss!

The RapiPack Vol. #2

\$19

Ideal for both new Amiga users and veterans alike, the RapiPack makes an ideal Christmas present. Six disks full of quality software are contained in this easy-to-load pack, and full loading instructions are provided. The pack contains 2 disks full of games (*GridRunner*, *Invaders*, *Rebound*, *Moonbase*, *MirrorWars* and others), one disk packed with a variety of educational software, one disk containing a superb graphics and sound demonstration, and another containing a sound editor and sample sounds. Two utility disks contain a vast number of handy utilities which will make using the Amiga so much easier!

Dynamic Demo Pack

The Amiga's sound and graphics capabilities are unrivalled. This pack contains seven disks full of stunning sound and graphics demonstrations which will show off the inner power of your Amiga!

The demos included in the pack are:

- * Bartman Demo
- * Crusader's Demo
- * Madonna Slideshow
- * Puggs in Space
- * Scoopex Mental Hangover
- * Trilogy Mega Demo (2-disk set)

\$27

Other P.D. Packs

The Ultimate Games Pack Vol. #1
The Education Pack
The DTP (Desktop Publishing) Pack
...only \$27 each!

We have the complete range of Amicus, Amigan & Fish disks available, as well as DTP utilities, demos and GIF Pictures. All individual disks are only \$4 each

SPECIAL!

Buy any 3 \$27 packs,
get the 4th pack free!

Offer valid till 31st Jan 1992

Mail your order to:

RapiSoft
P.O. Box 19
Forest Hill Vic 3131

Fax Orders:

(03) 894-1137

All fax orders must be paid by credit card



Please send me the following:

- ___ copies of RapiSoft's Catalogue Disks @ \$5 per set
- ___ copies of Ultimate Games Pack #2 @ \$27 each
- ___ copies of The RapiPack Vol #2 @ \$19 each
- ___ copies of Dynamic Demo Pack @ \$27 each
- ___ copies of Ultimate Games Pack #1 @ \$27 each
- ___ copies of The Education Pack @ \$27 each
- ___ copies of The DTP Pack @ \$27 each

Total Amount: \$ _____

I enclose Cheque/Money Order for above amount,
OR Charge my Bankcard Visa MasterCard

Card No.: _____

Exp. Date: _____ Signature: _____

Name: _____

Address: _____

Suburb: _____ Postcode: _____

Entry Level Desktop Video The RocGen Plus Genlock

by Peter Ward

Not all that long ago, the number of genlocks available for the Amiga that would work with our PAL television standard could be counted on the fingers of one hand. Clearly things have improved since then as there is now a complete spectrum of PAL genlocks which would satisfy most users, whether a rank amateur video enthusiasts or broadcast quality production houses.

The RocGen Plus genlock will no doubt find a niche in the lower end of the market, if only due to its pricing (\$899). However, this genlock also has some attractive features which one normally associates with units in a significantly higher price bracket.

Documentation

The RocGen is shipped with a twelve page manual, demonstration disk and a handy titling software package, called "Home Titler". The manual, while not overly extensive, is sufficient to explain the installation and operation of the genlock. There is also a brief description of the Demo Disk and a "Question and Answer" section at the back of the manual. The only section where the

manual falls short is in the explanation of the KEY IN socket at the rear of the unit, but more on that later.

Software

The "Home Titler" software package is a surprisingly functional inclusion. The software is very similar to "PROTITLER" in both look and operation (though not as extensive). Titles can be easily created with effects such as multiple fonts, drop shadows, horizontal and vertical scrolling all being a mouse click (or two) away.

The package is very productive, with several pages of titles being easily created within a few minutes. Hopefully, bundled software is something we will see more of in future as hardware manufacturers seek ways to demonstrate the capabilities of their products.

More than happy with the goodies included with the RocGen, I then went on to examine the hardware in more detail.

The genlock case is of a sturdy metal construction, in an beige finish, which matches the Amiga colour scheme. There are two rotary dials on

the front cover, a Composite video IN, OUT, VIDEO THRU, KEY IN and RGB THRU connectors at the rear of the unit. These connectors are of the RCA type, and are common to most domestic VCR's.

There is also a "Video on" light on the front of the case, a feature many early genlocks lacked, which is very helpful in confirming the genlock is receiving a valid video input if or when you need to troubleshoot problems with your video set-up.

There is also a 12 volt DC power supply socket. Even though the RocGen can be powered from the RGB port of the Amiga, this addition would be of benefit to some users, such as taking the load off an already strained A500 power supply system.

Operation

After plugging the RocGen into the RGB port of an Amiga 2500, and connecting the monitor to the RGB through the connector, the unit was almost transparent in its operation. I found no major compatibility problems with the genlock attached in conjunction with the accelerator and hard disk boards within my system.

A slight bug occurred running *VistaPro* in the background, then moving a few workbench directories around, which resulted in a slightly scrambled control screen on returning to the *VistaPro* environment.

The RocGen is not alone here, as most genlocks attached to an '030 accelerated Amiga usually cause a weird artifact or two within the system with a genlock attached. The RocGen also takes a disliking to Hi-Res screens without external video being sent to the unit. The effect is a little like removing all the alternate scan lines on what would be a normal interlaced picture, and is visible on the RGB monitor and encoded video. Sending an external sync source to the genlock quickly fixed this problem.

There was one other snag. My initial use of the RocGen gave black and white output only!

I decided to open up the case to check if it wasn't something that could



be fixed with a tweak of a screwdriver. Sure enough the problem was isolated to the colourburst frequency adjustment pot in the RocGen. A tenth of a screwdriver turn later we were back in the land of living colour. Simple fix for some, but to a novice it would have meant a disappointing return to the dealer. My advice here is to ask to see the unit running as advertised while still with your dealer before you take delivery and part with your hard earned cash.

Basic operation of the RocGen is very straightforward. The unit is plugged into the RGB connector of your Amiga, then your Amiga monitor can be plugged into the Genlock. In this configuration you get an RGB and Composite video output of your Amiga graphics from the RocGen, as the unit has an internal sync generator. The VIDEO OUT plug can then be plugged directly to the VIDEO IN of a VCR to allow recording of your Amiga graphics.

Moving right along, the main use for a genlock is usually to superimpose graphics or titles over a live or taped video source. This configuration requires a composite video source (gained via the "Video out" on your VCR or Camera) to be plugged into the VIDEO IN plug at the rear of the unit. The VIDEO OUT plug of the RocGen then sends a combination of Amiga graphics and video to your VCR or TV monitor. Depending upon how the two rotary dials are adjusted at the front of the RocGen, the output effect may be varied.

For example, you can have titles overlaid on top of video or video visible through "keyholes" in your Amiga graphic. Titles may be faded in and out. Video can be faded in over an Amiga graphic and so on.

Key Support

To aid the video production process, the RocGen also has a VIDEO THRU connector, which loops the incoming video through the genlock without it being affected by the Amiga which aids monitoring of the incoming video. There is also a KEY IN connector. Unless you have a video production mixer or switcher (read: big bucks) this feature is of little use to the amateur videographer.

Out of interest I tried to make use of this connector with a Panasonic MX-12 Hi-Band video production mixer. Frankly I couldn't get the RocGen to work via the KEY IN connector, and freely admit to possibly not sending the correct signal to this connector. However, if the RocGen can perform some sort of luminance keying, the manual is extremely cryptic in describing just how it is achieved.

Examining the quality of the encoded output of the RocGen revealed a few surprises. Without an external sync source I could only describe the composite signal as "ordinary". There was bleeding and cross colour distortion on just about every screen I could send through the unit. A convergence pattern was not a pretty sight. Vertical "rainbow like" artifacts could be seen on the composite output of the RocGen. The situation changed somewhat when a high quality external video signal was put through the RocGen. Colour bars were evenly saturated and showed little bleeding, there

was minimal "dot crawl" or cross colour distortion. The convergence pattern I had previously sent through the RocGen now recorded cleanly, and in general I'd have say the result was good.

Similarly, Video-8 and VHS taped material sent to the genlock performed well, and despite some very domestic quality footage, the RocGen had no problems locking to the signal and the subsequent output recorded cleanly. There is a lesson to be learnt here: in many genlocks "internal sync" equates to "low end". The RocGen fortunately takes and preserves a high quality external sync source, so if you have good quality video equipment the RocGen will at least preserve your investment.

Conclusions

Overall the RocGen Plus genlock, despite having a few teething problems, performed very well when used in conjunction with good quality domestic video equipment. The dual faders on the front of the unit allowed some very professional looking dissolves to be created using little more than a Handycam and VCR.

For those about to wade into the waters of home video production, the addition of the RocGen to your Amiga is certain to add spice to your next production.

Distributed by Matrix (02) 550 4688.

Why is Computermate the market leader?

- Customer Service
- Product Knowledge
- Availability
- Product Support
- Value
- Largest Range



Australia's Leading
Distributor of Software
and Accessories for

● AMIGA ● C64 ● IBM

Phone (02) 457 8388
Fax (02) 457 8739

Software for the small business, home, office, personal user and schools.

Picking a Printer

Printer technology has gone mad. Even base models are now packed with more features, buttons and fonts than what was once considered a top class machine. Andrew Farrell compares four dot matrix colour models.

In the past, in printer comparisons like this, we have attempted to include a huge range of models and often ended up with such diversity that there was no clear winner.

How things have changed. Modern printers now tend to share a similar range of features, price tag and look. What's more, options such as colour are now standard features. So, it should be a little easier to compare the leaders.

To help do this we devised a test created in *Professional Page* to output a range of graphics and text to the printer. The results appear on page 18 and 19. In all cases the output density was adjusted to half the maximum to allow for the colour and greys.

Printer Basics

Getting ink onto paper was once the domain of a few skilled people. Now anyone can churn out reams of professional looking text. Print technology has become an affordable commodity, and the methods have improved considerably over the very early impact printers we once had to shout over.

These first models bashed the ribbon with the shape of a letter stored on a daisy wheel or on larger models on a spinning drum or chain. They were noisy,

slow and inflexible beasts which have long fallen by the wayside.

Stepping forward in time we come to the early dot matrix printers. These create an image using pins which independently strike the ribbon from a moving print head to create a matrix of dots which in turn form the necessary characters. Early models were crude, noisy, slow and by today's standard, expensive. However as time went on, they have become fast, high quality, affordable and reliable and remain the mainstay of printer technology.

The latest models offer 24 pin detail, colour, excellent near letter quality print, 360 dots per inch (DPI) graphics and a range of built in fonts. Although the resolution of these printers is indeed higher than your average laser printer, I can assure you that the quality still lags behind.

Nevertheless, at around \$500-\$1,000, even the most expensive models represent good value for money and excellent performance. It is this kind of printer that is commonly chosen for home use and is readily available from most computer outlets.

During the onward march of dot matrix technology, a number of other print methods surfaced, some good, some plain horrid.

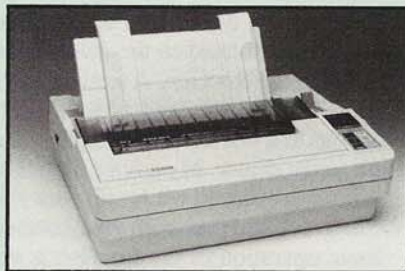

Citizen GSX-140

Thermal transfer was popular for a while and is still used today by the fax machine. It is quiet, compact and reasonably reliable. But the drawbacks are that the paper is expensive, it fades and some models had dreadful problems with heads wearing out. Thermal printers are not readily available today.

Ink Jet technology has survived from early days of blotchy, messy output to the now sophisticated brilliance of full photographic colour images. If you want top quality colour output, the inkjet is the way to go. These machines pump ink onto the page in four colours - cyan, magenta, yellow and black. The same four colours are used for creating full colour images in traditional printing.

The ink moves through the tiny ink jets, which may become clogged from time to time, and splats onto the page. The splatting bit has improved over the past twelve months, and now these machines are happily doing all sorts of high resolution output. Expensive, but beautiful quality. Some dealers carry these printers, but not many.

Laser printers are not for your average household wordprocessing requirements. They are expensive to run, and to buy (\$1500-\$4500), even a low end model.

Of course, we all know that laser

Star LC24-200



Star LC200



printers work like photocopiers. The toner is transferred to a drum and then onto paper by creating a static attraction between the two mediums. Toner produced better results than your regular carbon ribbon used in a dotmatrix printer - it is far more consistent and holds solid black areas much better.

However, for real serious work, the resolution is still not quite typeset quality. Characters, although appearing crisp to some, upon closer inspection have actually got slightly furry edges. Still a lot better than dot matrix and a tad more consistent than the results from new technology such as ink and bubble jet machines.

Star LC24-200/LC200

Both Star printers we tested feature a sleek new case, colour output and a high level of control from the front panel. Star have always offered good value for money in the features area. My only immediate reservation about the printer was the top lid, which seem poorly hinged.

Installation is reasonably simple. The ribbon is easy to insert, there's a roller unit which sits above the platen to install - it locked into position smoothly. The power cable is moulded into the rear of the unit and the centronics port is sensibly located on the right hand side, out of the the paper path's way. Another well thought out item is the placement of the power switch on the front.

Both models look sharp and are ergonomically designed. There are five panel control buttons using small micro-switches. A handy guide to the functions of each button is provided in the form of an overlay card which may be flipped to view all the potential functions.

Paper loading is a snack. The paper-feed button not only loads the paper, but places the printer on-line once the paper is in position. From the front panel you can also micro-feed the paper (very small line-feeds) making it virtually unnecessary to touch the platen knob on the side.

Paper handling is good, with push/pull tractor feed which may be loaded from the rear or through the bottom.

Like the previous models, Star have also included a paper-park facility to save you having to unload tractor fed paper in order to use single sheet friction fed material.

EDS mode on both models provides access to low-level printer settings, replacing the need for dip-switches which are tricky to get to and difficult to interpret.

The LC24-200, the 24 pin version, has one draft font, a high speed draft font and five letter quality fonts (Times Roman, Sanserif, Courier, Prestige and Script). All fonts may be italicised, condensed, bold, double sized and quadruple sized.

The nine pin LC-200 has one draft font, one high-speed draft font and four NLQ fonts (Courier, Sanserif, Orator and Script). Once again, all fonts may be italicised, condensed, bold, double and quadrupled sized.

Of course, with a good desktop publishing package, all this is rather pointless when outline font technology offers more control and better quality output (*Professional Page, PageStream,*

POPULAR MODULE EXCHANGE SERVICE

PARCOM Pty Ltd

Whites Hill Shopping Village
Samuel St
Camp Hill, Qld 4152
(07) 395 2211

GAINRUN Pty Ltd

7/27 Justin Street
Smithfield
NSW 2164
(02) 757 1055

Send your PCB, PSU, Drive or Mouse for next day replacement.

Reconditioned Modules available for most models e.g.

C64, 64C, 1541II PCB	\$99.00
A500 PCB	\$129.00
AMIGA DRIVE	\$200.00
MOUSE	\$50.00
A500 PSU	\$75.00

ALL ITEMS MUST BE COMPLETE AND IN SERVICEABLE CONDITION

THREE MONTHS WARRANTY ON ALL MODULES

PLEASE CALL FOR FURTHER DETAILS

CHRISTMAS SALE

Hardware

A500 Base	\$699
A500 Starter Pack	\$799
A2000 with 40 meg HDD	\$1995
A500 512K RAM with clock	\$89
GVP 40meg HDD	\$Call
ICD 4meg A500 Internal Ram	\$Call
Amiga DOS V2.0 (order now)	\$99

Productivity

3D Professional	\$295
CanDo V1.02	\$149
Personal Finance Manager	\$69.95
EasyLedgers (Accounting)	\$395

Video/Animation

Broadcast Titler	\$450
Golden Image Hand Scanner	\$449
Imagine	\$449
DPaint IV	\$199

New Releases

Monkey Island	\$59.95
Kings Quest V	\$79.95
Space Quest IV	\$79.95
Railroad Tycoon	\$89.95
Cruise for a Corpse	\$69.95
Hoyles Games 2	\$69.95
Terminator 2	\$69.95

Printers

Star LC10 Colour	\$399
Star LC24200 Colour	\$699
Star Laser 4	\$2495
Star Laser 4 Postscript	\$3295

Avtek Modem Specials

Avtek Mega 1234	\$349
Avtek MegaPlus	\$399
Avtek MegaPlus V32	\$899
9600 Baud Modem	

IF A PRODUCT YOU REQUIRE IS NOT LISTED PLEASE DO NOT HESITATE TO CALL US AS WE WILL BE ONLY TOO PLEASED TO ASSIST YOU

COMING SOON:

OBITUS
SECRET WEAPONS OF THE LUFTWAFFE
F117A-NIGHTHAWK
F19 STEALTH FIGHTER II
SIM EARTH
CAPTIVE MISSION

Shop 4 Computers

Cnr Burelli & Atchinson Sts, Wollongong, 2500
Phone (042) 26 2688 Fax (042) 27 3527

LQ-series and IBM Proprinter X24. Both emulations offer addition Citizen exclusive features too.

On the 140 you can choose from LQ Roman, San Serif, Courier, Prestige and Draft fonts. The 200GX offers two draft fonts, Sans Serif, Roman and Courier.

Final Results

Of the four printers tested, the GSX-140 was the most impressive. Overall, both Star printers performed well. Both models only offer a single macro, with only a small number of stored settings. The LC24 appeared to have some problems with colour smearing. Although I tried a number of adjustments, I couldn't solve this problem.

The Star printers are certainly in vogue in so far as design lines. They are heavier units than the Citizen models. The documentation is good, but tends to concentrate on many of the low level aspects of the printer's operation rather than discussing how to obtain compatibility with software. For Amiga owners, this is all much of a muchness. All you need to know is how to use the front panel, and which printer driver works the best!

The Citizens are more advanced units, with easier to use front panels. The GSX-140 offers superior operation and colour output than any of the other units. Both printers performed very well in the grueling output test and the documentation was also more impressive than the Star. For the money the 9-pin Citizen GX200 at \$499 is excellent value and produces exceptional colour results.

In the 24-pin department I would also recommend the Citizen GSX-140 at \$699. It is easier to use, and once again produced more consistent results. In terms of speed and resolution both the 9 and 24 pin models of each brand are comparable.

All the printers offer an incredible range of features and are typical of the immense improvement in printer technology we have seen in recent years.

Thank you to Pantek and Star for the loan of the printers. Next month we'll be pitting the 24-pin models against the new Canon Bubble Jet to see which wins for desktop publishing!

Specifications in Brief

	DPI		CPS		
	Max	Test	Draft	NLQ	
9-Pin Star LC-200	240	120	150	37.5	\$
Citizen 200GX	240	120	213	40	\$499
24-Pin Star LC24-200	360	180	167	55.5	\$749
Citizen GSX-140	360	180	160	53	\$699*

Text would appear improved if output at the highest resolution, but this mode is not suitable for graphics containing colour or greys.

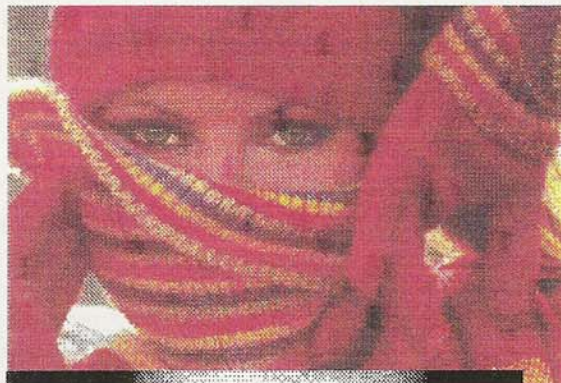

AaQqRrGgZz0123456789 Citizen GSX 140



AaQqRrGgZz0123456789 Citizen 200GX



Panasonic KX-P1124

User Report

After managing for over a year with a trusty Seikosha SP-1600A1 9 pin dot matrix printer, Alan Stuart decided it was time to upgrade.

I tend to play around a lot with desktop publishing, so I wanted a printer that would give me good results. That night I had dreams of owning a Postscript laser printer, so next morning it was off to the bank, where I found my account contained about \$4500 less than what the cost of a postscript laser printer. Oh well, back to plan 'B'.

Plan 'B' was for a 24 pin dot matrix printer. I wanted to spend as little as possible, and not more than \$1000. I had previously seen an Epson LQ-500 at about \$650, but was not very impressed with its features. I then phoned my favourite computer store, Computer Corner (Metro Maddington, WA, 09 459 0650), and Trevor told me about the new Panasonic range. Within two days, Trevor had sent me the brochures and prices.

After studying the material, the KX-P1124 at \$799 looked as if it would fit the bill. When I phoned again to place an order, Trevor told me that Panasonic had a promotion on and the KX-P1124 was reduced to \$599! No more thinking, the printer was here within a week.

Features

The Panasonic KX-P1124 is a 24 pin impact dot matrix printer, and can emulate an Epson LQ-2500 or IBM Proprinter X24. Construction of the printer is very solid with plenty of steel and cast aluminium. Power lead and computer input are at rear, but clear of the paper path, so no catching on the paper. Power switch is on the right side of the printer, towards the front.

The available fonts are draft, and 5 NLQ fonts (Courier, Prestige, Bold PS, Script, and Sans Serif). Print pitches can be 10, 12, 15, 17, and 20 characters per inch, or Proportional Spacing for NLQ fonts. Lines per inch can be set to 3, 4, 6, 7.5, 8, or 12. Text printing is excellent in the NLQ fonts, even at 20 cpi.

Print speed is fairly healthy in draft (24x9 dot matrix) at 160 characters per second (10 cpi), or 192 cps (12 cpi). NLQ mode (24x30 dot matrix) is 53 cps (10 cpi), or 63 cps (12 cpi). The printer has a buffer of 6K (Kilobyte), and an additional 32K buffer is available as an option.

Graphics

Graphic printing is fantastic. The printer is capable of printing to a resolution of 360x360 dots per inch, or 129600 dots per square inch. This is a higher resolution than a lot of laser printers can produce. The Epson Q printer driver on Workbench v1.3 only allows a maximum resolution of 180x360 dpi, or 64800 dots per square inch. When using *PageStream* v2.0, I use the Epson LQ-2550 driver and this gives me the highest resolution possible.

Paper handling is exceptional. Paper can be fed from the front, back, or bottom. A unique tractor feed can be rotated in two different positions to act as either a pull or push tractor for continuous paper. In single sheet mode, paper as wide as 11.7 inch can be fed in. This means that A4 paper can be fed in sideways.

All print options are available through the EZ Set Operator Panel on the front of the machine. This panel consists of a number of membrane-type switches, with indicator LEDs (Light Emitting Diodes). Using the switches, you can set Font, Pitch, Form Length, Lines per Inch, Quiet Mode, Margins, Line Feed, Form Feed, Forward and Reverse Micro Line Feed, Memo Load, Perforation Cut, and read or write one of the three Macro settings!

The first few choices are self explanatory. Quiet Mode reduces the noise output of the printer by reducing the print speed. Most of the expensive printers have this feature. Micro Line Feed will advance or retract the paper 1/180th of an inch each press so that you can get the paper lined up just where you need it. The last three features are some of the best to have.

Memo Load is used to park and reload tractor feed (continuous) paper without removing it from the push tractor mechanism, or for loading single sheets. For example, press the memo load and the tractor feed paper is parked. Open the front slot, move the feed select lever to friction, insert the single sheet in the front slot, press memo load again, and the sheet is fed in to begin printing. When finished, select push tractor on

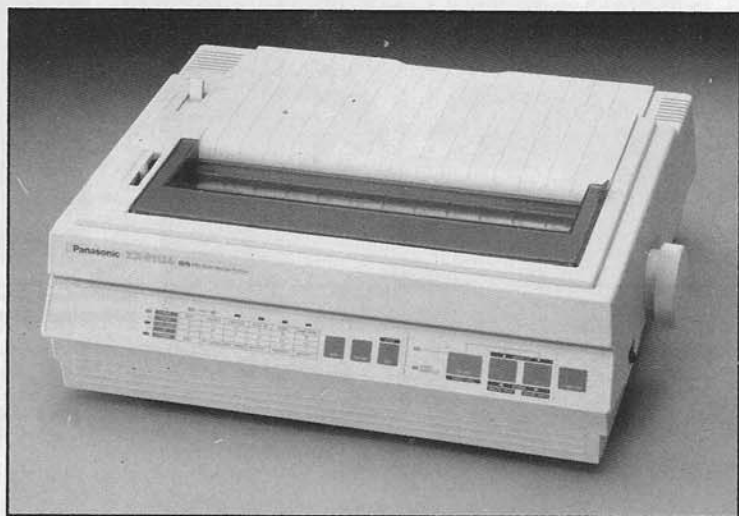

the feed select lever and push memo load to reload the continuous paper.

Perforation Cut is another well thought out feature. Pressing this switch will advance the paper about three centimetres so that the perforation is aligned with the perspex cover. At this position, the paper can then be torn off at the correct place (the perforations). Pressing the switch again will rewind the paper to the correct position to recommence printing.

The last feature of note is the three Macro Settings. When you have a printer with so many features, it is a real pain in the proverbial if you wish to change between a couple of common used settings. For example, for general memos at work you may wish to use the script font, at 12 cpi, and spaced at four lines per inch. For reports, your favourite settings may be Sans Serif font, 10 cpi, left margin at 15, right margin at 75, and 6 LPI spacing. Well, you can imagine the time involved at changing all this.

The KX-P1124 allows you to save your three favourite settings in three separate macros. By reading in a macro, at the push of a couple of panel switches, all the settings associated with that macro are sent to the printer, and presto! ready to go.

Another unique feature associated with the printer is the ribbon. The ribbon is similar to a Star NX-1000 that clips around the print head. The special feature of the ribbon is the small hole on the rear. When the print quality starts to fade (ink being used up), press a pen into the hole in the back of the ribbon, and a second ink reservoir is brought into service. After a few lines, the ribbon is fully re-inked and the life is doubled! Saves a trip to your local re-inker.

Documentation

One final item that can make or break the best of printers is the manual. If you can't use the features because the manual

is not clear, then the feature might as well not be on the printer. The manual is well set out, with plenty of illustrations and examples to get even the most timid beginner up and running. The text is clear and printed on good quality matt paper. Finally, there are no hard to understand sentences due to bad interpretation from one language to English.

Conclusion

All in all, the Panasonic KX-P1124 is a sturdy printer, designed to take more than average use, with plenty of easy to use features, and excellent paper handling. Print quality is sensational. The Seikosha SP-1600AI had what I thought was an impressive output from *PageStream 2.0*. The Panasonic's output is substantially better, and my desktop publishing has taken on a new feel.

I can safely say that the only reason I will upgrade from this printer is if I decide to go laser.

PCM COMPUTERS - FOR ALL YOUR AMIGA NEEDS

ICD A500 INTERNAL HARD DRIVES!!!
40 Mb \$620 80 Mb \$740 125 Mb \$870

Autobooting. Games autoboot ON / OFF switch. Boot from ANY floppy.

Upgrade your A500 Power Supply to 200 W fan cooled for \$130 (exchange)

POWERCOPY PROFESSIONAL V2.02	- THE POWER TO COPY ALL	\$30
POWERDEVICE	- HARDWARE TO UNLEASH POWERCOPY'S FULL POWER	\$60
	BOTH TOGETHER	\$80

A500 2.0Mb RAM exp. - supports 2 Mb ChipRAM - 2Mb fitted	\$320	THE FULL GVP RANGE
A500 4.0Mb RAM exp. - 2Mb Chip/2Mb Fast autoconfig - 4Mb fitted	\$520	
A500 GVP HD+8 52Mb Quantum Hard Disk + 8 Mb RAM board (0 Mb)	\$935	AT THE BEST PRICES
A2000 GVP HC+8 52 Mb Quantum Hard Disk + 8Mb RAM board (0Mb)	\$770	CALL to win
Amiga Hardware Virus Detector	\$35	
Amiga MIDI Interface - IN/THRU/OUT	\$50	Microbotics 68030 Accel.
All Amiga and IBM repairs		CALL to win
AMIGA PUBLIC DOMAIN SOFTWARE - on 3.5" disk	each \$2.80	

Amiga Computers, Monitors, Printers, Hard drives, Accelerators, Memory expansions, Repairs, Modifications, Disk drives, Diskettes, Full GVP range - CALL NOW FOR THE BEST DEAL

PCM COMPUTERS - FOR ALL YOUR AMIGA NEEDS

DANDENONG NORTH	Phone (03) 701 0343	PO Box 70 Noble Park VIC 3174 FAX (03) 701 0007
MALVERN	Ph/FAX (03) 822 5873	1/1421 High St Malvern VIC 3144 9am - 7pm
OTHER PCM AGENTS:		Prices subject to alteration without notice.
J & S Computers	PO Box 198 Mentone VIC 3194	Phone (03) 580 6963
Northwest Electronics	5/11 McDougall Rd. Sunbury VIC 3429	Phone (03) 744 4440

INTERLINK

THE AMIGA
MAIL ORDER
LEADERS

We're
Number
1

Bringing you the **BEST** for your AMIGA, at the **BEST** price!

ARCADE

AMNIOS	48.90	LOTUS ESPIRIT TURBO II	58.90
ARMOUR-GEDDON	49.90	NEBULUS II	52.90
BARBARIAN II	58.90	OUT RUN EUROPA	52.90
DARKMAN	52.90	PP HAMMER	47.90
ELF	49.90	RAINBOW COLLECT.	42.90
FINAL FIGHT	52.90	R-TYPE II	52.90
GEM-X	47.90	SILKWORM IV (SWIV)	56.90
GODS	52.90	TERMINATOR 2	52.90
KILLING CLOUD	55.90	THE SIMPSONS	62.90
LAST NINJA 3	52.90	THUNDER JAWS	47.90
LEMMINGS	54.90	TOKI	55.90
LOGICAL	48.90	VIZ (R-RATED)	49.90

ALIEN BREED
\$52.90

MAGIC POCKETS
\$52.90

LEMMINGS DATA
\$42.90

RODLAND
\$62.90

FLIGHT SIMS

BATTLE CHESS II	55.90	KNIGHTS OF THE SKY	77.90
BIG DEAL	77.90	LIFE & DEATH	55.90
BLUE MAX	59.90	MEDIEVAL WARRIORS	55.90
BRIDGE V6.0	49.90	MIG 29 SUPER FULCRUM	69.90
CARDINAL OF KREMLIN	52.90	MONOPOLY	48.90
CENTURION	52.90	MOONBASE	55.90
CHARGE LIGHT BRIG.	67.90	PERFECT GENERAL	75.90
COSMOTRUSTION	46.90	PRO FLIGHT	79.90
DEUTOROS	58.90	RAILROAD TYCOON	58.90
ESCAPE FROM COLDITZ	65.90	RED BARON	68.90
F15 STRIKE EAGLE II	65.90	RISE OF THE DRAGON	72.90
F19 STEALTH FIGHTER	65.90	SARAKON	48.90
FALCON COLLECTION	74.90	SILENT SERVICE II	69.90
FLIGHT OF INTRUDER	72.90	STAR FLIGHT II	62.90
FLAG	67.90	THEIR FINEST HOUR	59.90
GALACTIC EMPIRE	62.90	THEIR FINEST MISSION	34.90
GERM CRAZY	52.90	TOWER FRA	54.90
HARPOON	59.90	WORLDS AT WAR	52.90

STAR FLIGHT II
\$62.90

MEGA-LO-MANIA
\$62.90

THUNDERHAWK
\$55.90

UTOPIA
\$58.90

MIDWINTER II
\$65.90

RAILROAD TYCOON
\$58.90

RED BARON
\$68.90

HUNTER
\$58.90

AmigaLINK Disk Magazine

SPECIAL 2-DISK CHRISTMAS EDITION (#5)
ONLY \$5.00

SPORTS

4D SPORTS BOXING	58.90	MANCHESTER U. EUROPE	58.90
4D SPORTS DRIVING	58.90	MASTER 3D GOLF	72.90
FORMULA 1 GRAND PRIX	72.90	NASCAR CHALLENGE	62.90
GRAHAM GOOCH CRICKET	58.90	PGA TOUR GOLF	52.90
GP TENNIS MANAGER	52.90	PRO TENNIS 2	57.90
KICK OFF II	39.90	R.B.I. 2 BASEBALL	58.90
K-OFF FINAL WHISTLE	29.90	RUGBY - WORLD CUP	58.90
K-OFF RETURN EUROPE	29.90	STREET ROD II	52.90
K-OFF WINNING TACTICS	25.90	T. LA RUSSA BASEBALL	62.90

JIMMY WHITE SNOOKER
\$58.90

STRIKER MANAGER
\$52.90

WORLD CLASS RUGBY
\$58.90

ADVENTURE

AD & D COLLECTION	87.90	GEISHA (R-RATED)	65.90
ALTERED DESTINY	62.90	HEART OF CHINA	62.90
CADAVRE PAY-OFF	33.90	HERO QUEST DATA DISK	39.50
CAPTIVE	49.90	KING'S QUEST 5	65.90
CHAOS STRIKES BACK	54.90	MAUPITI ISLAND	47.90
CRUISE FOR A CORPSE	58.90	MEGATRAVELLER 1	69.90
DEATH KNIGHTS KRYNN	49.90	OBITUS	67.90
DEMONIAK	58.90	RENEGADE LEGION	52.90
DOUBLE SOUBLE BILL	78.90	ROBIN HOOD	58.90
DRAGON WARS	49.90	SEARCH FOR THE KING	62.90
DUCK TALES	49.90	SECRET MONKEY ISLE	52.90
DUNGEON MASTER	48.90	SECRET SILVER BLADE	49.90
ELVIRA	57.90	SPACE QUEST IV	65.90
EYE OF BEHOLDER	49.90	WIZARDRY VI BANE FORGE	74.90
GATEWAY SAVAGE FRONT	52.90	WONDERLAND	68.90

REALMS
\$62.90

LORD OF RINGS
\$56.90

ULTIMA VI
\$72.90

MEGATRAVELLER 2
\$69.90

BUSINESS

ADVANTAGE	239.00	PHASAR V4.0	88.90
ALL IN ONE	89.90	PROPER GRAMMAR	149.00
CYGNUS ED PRO	119.00	PRO PAGE V2.1	359.00
EXCELLENCE	169.00	PROWRITE V3.2	149.50
HOME ACCOUNTS	83.90	QUICKWRITE	79.90
HOME FRONT	99.50	SUPERBASE 2	99.50
MAXI PLAN V2	159.00	SUPERBASE 4 PRO	399.00
NORGEN II	119.00	SUPERPLAN	89.50
PAGESETTER II	139.00	SYSTEM 3E	149.00
PAGESTREAM V2.1	295.00	WORDWORTH	269.00
PEN PAL	149.00	WORKS PLATINUM	149.00
PERS'L FINANCE MANG.	49.90	YOUR FAMILY TREE V2.0	99.00

EXCELLENCE V2.0
\$169.00

PEN PAL
\$149.00

PAGESTREAM V2.1
\$295.00

SUPERBASE 4
\$379.00

MAXI PLAN V2.0
\$159.00

PRO PAGE V2.1
\$359.00

GRAPHICS

AEGIS GRAPH. ST'R	64.90	INTROCAD PLUS	99.50
ART DEPARTMENT	109.50	MODELLER 3D	99.50
BROADCAST TITLER II	469.00	PELICAN PRESS	119.00
DELUXE PAINT IV	174.90	PRINTMASTER PLUS	47.90
DELUXE PRINT II	89.90	PRO DRAW 2	229.00
DELUXE VIDEO III	89.90	PROMOTION	99.50
DESIGN 3-D	89.50	PROVCTOR	349.00
DESIGN WORKS	119.00	PRO VIDEO PLUS	289.00
DIGI-MATE 3	49.90	SCALA	499.00
DIGI-PAINT 3	109.00	SCENE GENERATOR	57.90
DIGI-VIEW GOLD	229.00	SPECTRACOLOR	97.50
DIGI-WORKS 3D	149.00	TOP FORM II	99.50
DIRECTOR V2.0	147.50	TURBO SILVER	127.50
DRAW 4D	289.00	TV TEXT PROF.	169.00
FLOOR PLAN CONST.	99.50	ULTRA DESIGN	199.00
IMAGINE	389.00	VISTA	72.90

DELUXE PAINT V4.0
\$174.90

DIGI-VIEW GOLD V4
\$229.00

IMAGINE
\$389.00

SPECTRACOLOR
\$97.50

TURBO SILVER
\$127.50

PRINTMASTER PLUS
\$47.90

UTILITIES

3D CONSTRUCTION KIT	99.50	GP TERM	79.00
AMOS (with Club Memb.)	119.50	HISOFT BASIC	139.00
AMOS 3D	78.90	HYPERBOOK	119.00
AMOS COMPILER	59.90	IMAGE FINDER	79.50
AReXX	59.90	NO VIRUS	45.90
ASSEMPRO	119.00	PIXEL SCRIPT	79.90
AZTEC C PROF. V5	299.00	PROJECT D V2.0	69.90
BENCHMARK MODULA-2	229.00	QUARTERBACK	69.90
CAN DO	139.00	QUARTERBACK TOOLS	77.90
CROSS DOS V4.0	47.90	SAS C DEVELOPER V5.1	369.00
DEVPACK 2.0	139.00	SAS C++	249.00
DIRECTORY OPUS II	58.90	SHOWMAKER	399.00
DOS LAB (DOS Tutorial)	39.50	STARSOFT HD BACK	64.90
GFA BASIC	109.00	SYNCR0 EXPRESS III	125.00

AMOS
\$97.50

QUARTERBACK
\$69.90

QUARTERBACK TOOLS
\$77.90

SAS C v5.1
\$369.00

SYNCR0 EXPRESS III
\$125.00

X-COPY PRO
\$99.90

CHRISTMAS SHOPPING

To ensure you get the items you want for those important Christmas presents please place your orders early in December

HAVE A SAFE AND HAPPY FESTIVE SEASON
From all of us at **INTERLINK**

CALL US FOR THE LATEST RELEASES

MediaShow

Multimedia on a Budget

Software allowing you to combine music, sounds, graphics and animation is in plentiful supply. However, MediaShow offers several unique features, as Andrew Farrell explains.

Everyone I talk to has a different definition of multimedia. Most Apple people are sure you need a video or CD disc player in there somewhere. IBMers would be happy just to add sound and music. In the Amiga community, we might not have coined the word, but everyone agrees, this is the best platform for multimedia presentation.

I call the external devices option enhancements. So do Gold Disk. If you want everything, they have a package called *Showmaker*. It can control a disc player, Video Toaster, talk to other applications through AREXX, accept MIDI or SMPTE time code and assorted other impressive options.

However, most people require much less. Something more along the lines of *Deluxe Video*, with a little more elegance. *MediaShow* may be the answer.

It offers the ability to sequence SMUS music, IFF sounds and graphics and ANIM OPT 5 animation. The program also has the ability to add titles to exiting images including animation and there are various wipes available to spruce things up. How well does it work?

Installation

MediaShow includes five disks - three contain the programs, example files and player and a number of ready to use backgrounds. The other two include simple paint and music programs (the

same two Gold Disk have been bandying around for some time) and an interactive product guide to Gold Disk's other products.

The guide is an impressive example of how a Hyperbook application can be put to work. I think more companies should consider providing information on products in a similar format, that's as well as demo versions. The screen shots are a good guide to what the programs look like.

Installation of MediaShow was a painful process. I tried once, the script had trouble finding two files, I cancelled the requestor and although the installation appeared to proceed, at the end there was nothing on my hard disk but a few new fonts.

Second time round I issued an Assign to help the script along. Once again, it now appeared to proceed a little more smoothly. However, at the end it failed again. This is the second time Gold

Disk's install script has been faulty. The Compugraphic fonts they distribute also have problems installing, and as with them I eventually installed *MediaShow* manually.

If you're serious about using a program like this, a hard disk is pretty well essential. You would need at least 1 Megabyte of RAM too, although more would be useful.

Operation

Unlike its big brother, *Showmaker*, *MediaShow* operates on a standard lo-res screen.

The work area or scene window is much the same - each element of your presentation has a track running across the screen on a time line measured in seconds. By opening the edit screen up fully, all seven tracks are revealed. They are Video, Title, Music, Sound L1, Sound L2, Sound R1 and Sound R2 (one sound per Amiga channel).

To place a new event, you simply click on the appropriate track and drag out a bar to the required length. Events can easily be shuffled around or have



their length adjusted using gadgets or requesters.

Once you have selected the length, a new window opens up on the screen window with details of the type of event you have chosen. Apart from title, all the events require you first specify a file compatible with the track you're working on.

Video

A video event may be an animation or still IFF image. A single image is viewed as a one frame animation.

Once loaded, *MediaShow* displays information about the number of frames, resolution and number of bit-planes. You can also alter whether or not animations loop, the frame rate and any special wipes to perform at the start.

Herein lie a few problems. You cannot simply choose an animation and have it play once at the correct frame rate it was created. Instead, you have to tweak the frame rate and event length until the number of times the anim will play shows as one.

This would be fine if this indicator was accurate. I found it to be inconsistent. For a start, the whole formula relies on the Amiga actually playing the animation back at the specified frame rate - a variable which can be difficult to accurately predict. The only way to work the program reliably is to overshoot slightly on every animation.

There are some 35 different wipes, however there were some problems in using them. Some didn't apply the palette until the wipe was complete. Others would only operate at very

AMIGA PUBLIC DOMAIN SOFTWARE

- Free delivery • 1,000's of programs
- All orders despatched next day

INTRODUCTORY PACK

comprising
2 CATALOGUE DISKS
Listing 1,000's of Programs
SAMPLE DISK
10 great games/programs
HINTS AND TIPS DISK
1.5 Megabytes of hints/tips
TUTORIAL DISK
Amiga Tutor/DOS Helper
GAMES DISK
7 fantastic games
UTILITY DISK
5 Incredible Utilities

ONLY \$19.95

FUNNIES PACK

If you're a bit strapped for cash, then why not try our Funnies Pack.

We'll send our 2 Catalogue disks with a FREE game and VIRUS CHECKER.

PLUS
Our very own JOKIN' AROUND Disk, comprising over 350 pages of jokes. Nothing is held back, no topic is immune. Have a giggle, a chuckle, a chortle or even a good old fashioned belly laugh!

ONLY \$5.00

We carry the popular FISH, FAUG, TOPIK, AMOS, TBAG, AMICUS, & AMIGAN disks PLUS
Our own collections of ALPHA & LATENIGHTER disks.
ONLY \$2.50 per disk.
AMOS disks \$3.00 per disk.

We also have a collection of DISK PACKS relating to specific subjects with several disks in each pack.

E.G. EDUCATION, HAM RADIO, MUSIC, GAMBLING, ANIMATION, BUSINESS, PICTURES etc.

BEST OF P.D.

This is a series of disks that we have been steadily compiling for the past two years. There are presently over 650 of these, all self booting with all required files and categories on our Catalogue Disks.

A selection of some of our Best of P.D. disks is shown in the next column.

SELECTION OF BEST OF P.D. \$2.95 ea

- 13 CRIBBAGE
- 17 TIC-TAC-TOE
- 31 WHEEL OF FORTUNE
- 33 BACKGAMMON
- 50 CHESS
- 57 POWERPACKER
- 72 VIDEO POCKER
- 74 MONOPOLY
- 84 BLACKJACK
- 93 WORDSCRAMBLE
- 99 HOUSE INVENTORY
- 100 SPELLING
- 102 MATH
- 112 CONCENTRATION
- 129 BIORHYTHM
- 115 TRIVIA QUIZ
- 144 SKETCHPAD
- 161 POLYDRAW
- 163 MOONBASE
- 180 DIETAD
- 181 HYPERBASE
- 229 PCOPY
- 260 SNAKEIT
- 261 STOCKBROKER
- 270 TEXTPLUS
- 275 SOLAR SYSTEM
- 318 DEFENDER
- 323 GERMAN TUTOR
- 327 CHECKERS
- 331 STUD POKER
- 333 MISSILE COMMAND
- 345 BUDGET
- 362 TYPING TUTOR
- 365 DISKMASTER V3
- 368 LCD CALCULATOR
- 370 CRAYONPAINT
- 371 SCRABBLE
- 375 BODYPARTS
- 385 CHINESE TRIANGLE
- 386 WORD PUZZLE
- 409 JEOPARD
- 416 LANDSCAPE
- 433 BLITZCOPY
- 435 TETRACOPI
- 448 SPECTRUM EMULATOR
- 506 DOMINOS
- 512 CHINESE CHECKERS
- 516 JUMPER (FROGGER)
- 521 ATARI ST EMULATOR

LEEJAN ENTERPRISES
489 Marion Road,
Plympton South, S.A. 5038.
Tel (08) 371 2655

MAIL ORDER
LEEJAN ENTERPRISES
P.O. Box 66,
Happy Valley, SA 5159

TRADING HOURS
Wednesday to Saturday
10.30am - 4.30pm

BBS (08) 322 3392
7.00pm - 7.00am every day.

Cheque * Money Order
BankCard * MasterCard * Visa

PM DEVELOPMENTS

THE AMIGA COMPUTER SPECIALISTS

For ANY Amiga product you require call and check us out first or last

IT'S CHRISTMAS AT PM DEVELOPMENTS!!!

A500	0.5 Mb Ram Expansion with ON/OFF Switch and Clock		\$75
A500	AXRAM 2.0 Mb Internal RAM exp. with 2 Mb - supports 2 Mb ChipRAM - full autoconfig on all Amigas		\$290
A500	40 Mb Internal Hard Drive 17 mS 64K cache + ICD controller - autobooting and fast		\$600
	80Mb \$720	125 Mb \$850	200 Mb \$1380
A500	GVP HD+8	52 Mb Quantum Hard Drive + 8 Mb board (0Mb fitted)	\$920
A500	SUPRA Drive	52Mb Quantum Hard Drive + 8 Mb RAM board (0 Mb fitted)	\$900
A500	MicroBotics 25 MHz 68030 Accelerator \$680	with FPU - maths co-processor	\$880
A2000	8 Mb Autoconfig RAM Board with 2 Mb fitted		\$440
A2000	GVP HC + 8	52 Mb Quantum Hard Card + 8 Mb RAM board (0 Mb fitted)	\$770
A2000	GVP Accelerator 22 MHz 68030/68882/1Mb 32 bit RAM/Serial SCSI interface		\$1350
A2000	FULL GVP RANGE of peripherals all at	A2000 68030 Accelerators	A500 Hard Drives + RAM
A500	ASTOUNDING prices - just CALL	A2000 Hard Card and RAM Boards	A500 Accelerators
External 5.25" floppy Disk Drives	\$200	Internal 3.5" Replacement Disk Drive	\$150
AMIGA Hardware Virus Detector	\$35	AMIGA MIDI Interface - IN/OUT/THRU	\$50
2 Mb SIMMS to suit GVP cards	\$170	All Amiga Mods and Repairs	

PUBLIC DOMAIN SOFTWARE - Heaps to choose from - ring for a catalogue disk from \$2 per 3.5" disk

GIVE US A RING - THE PRICES WILL ONLY GET BETTER!!!

For the BEST Amiga advice, prices and after sales service call PM DEVELOPMENTS. Computers, Hard Drives, Floppy, Accelerators, RAM, Monitors, Modifications, Repairs. Make an appointment to drop in or just phone. Mail Order or Pick up OK.

PM DEVELOPMENTS 1/1421 HIGH ST MALVERN 3144 PH. (03) 822 5873



slow speeds and none offered a transition from the previous event which was always usable. Most of the transitions meant the two images were gradually combined, the new replacing the old.

This is fine if the images have the same palette - however most don't, so the transition means the first picture's palette is destroyed. The result is less than acceptable.

Titles

For all its failing so far, *MediaShow* has some unique features which make it worth considering. One of these is the ability to place titles over existing IFF images or anims on the fly. Standard Amiga fonts are supported and a simple editor allows you to place the text, format it, apply one of seven different effects, choose from several styles and colour.

Some 17 different motions are available, some of which are quite useful, others are so slow or jerky that I doubt anyone would bother with them. Once again, Gold Disk seem to have overlooked some of the basic requirements in this area. Even a simple fade-in effect is not catered for.

Positioning your titles is tricky and getting them to move on and off the screen is no simple task. For a start, there's no way of determining how long the title holds on screen - you simply have one time allotted to the whole process of moving it on, pausing and moving it off again.

Overall, I was disappointed with titling capabilities. Other programs offer much smoother, more useful capabilities. As wonderful as titling your animations may sound, it also has the

annoying side effects of making them run less smoothly.

Music and Sound

These two event types function well. Unfortunately, unlike *ShowMaker*, *MediaShow* does not allow you to time your presentation to the beat of the music. Sound effects can have their volume and rate adjusted, apart from that, they just play. The best part about the sound support is the ability to choose which channel to play back through - with each having its own track. Some fancy stereo effects can be achieved using this capability.

Presentation Time

Here is where *MediaShow* starts to show its true colours. Using a patented system of preloading each presentation element, *MediaShow* is able to effect smooth playback of all tracks without pausing to load new data. This works well so long as you have a moderately fast hard drive and plenty of RAM. Anything less and you will find *MediaShow's* potential is severely limited. The demonstration production in-

cluded looks very impressive - however, this is mainly thanks to a couple of clever animations rather than anything *MediaShow* does.

No doubt, there will be those who find this feature alone - smooth, continuous playback - makes *MediaShow* worth considering. However, there are so many other features which are short-changed that I think you would find *CanDo* or *AmigaVision*, at around \$50 less, better value for money.

In essence, Gold Disk have stripped out so many good features from the heavyweight version of this program that what is left is just not worth the \$199 price tag.

MediaShow stands up well as a quick and dirty presentation package. If you want to get something together in a hurry, this is the package.

However, you would have to know the program's limitations well and work within them. If you have time to learn something more powerful, I would think that *AmigaVision's* resource management could be made to provide continuous play capabilities similar to *MediaShow*. Certainly not as elegant, but then you're getting many other features not available in *MediaShow*.

MediaShow needs tightening up in several areas. It also needs some of the features *ShowMaker* has to make it worthwhile. The manual is a bit skimpy for the money too - 35 pages not including the appendix.

Overall, a lot of potential, some powerful unique features, but too many shortcomings for the money. Gold Disk need to think this one over.

Distributed by Dataflow
(02) 331 6153
RRP \$199.95



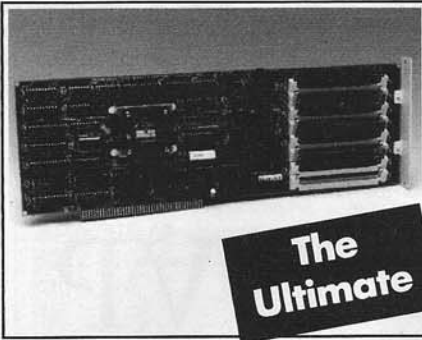

The Ultimate



Teach Yourself



Add on Power

Progressive 040

- Progressive peripherals 68040 board with 8MB 32-Bit RAM Super-cheap at \$3499
- Call for all other configurations

Miracle Piano

What would you expect to pay for Miracle? Ours are only \$599

Supra

- SupraRAMRX 1MB \$299
- SupraRAM 500RX 2MB \$399
- Supradrive 52 \$849
- Supradrive 105 \$1275
- Supramodem 2400 \$249



The Hard Disk Café • Shop 6, Akuna Lane, Mona Vale, 2103
Phone: 02 - 979 5833 • Facsimile: 02 - 979 6629



Deluxe Paint IV only \$175

HARD DISK CAFE



Tutorial Video
With 16 programs \$29.95
or FREE with all Amigas sold here.

XMAS Presents Our Present to you.

All items marked with * are 10% off for XMAS!!
All purchases over \$100 get a box of disks free!
The hard disk cafe XMAS pack consists of: Home, Business software, Games, Typing tutor, Joystick and a top quality mouse & discount coupons for 1992 all for a super low \$99.95

Chef's Specials

Invision Video FX board . . .899.00	Amiga 3000 3950	ROM Kernal Manual 3rd Ed . . . Call
GVP Impact Vision 24 Call	Mouse/Joystick switch 54.00	AmigaDos Manual 3rd Ed . . Call
Australian Graphic Atlas. . .69.95	Sharp JX-100 Scanner . . 1495.00	A2091 + 50Mb HDrive . . .999.00
ProWrite V3.2 (postscript) . . Call	Cannon bubble jet printer. 650.00	ATalk III 69.95
CDTV & Grolliers. 1499.00	ICD A500 Internal HD's Call	CDTV Fish - V1.3 Update. .99.95
CDTV keyboard 225.00	Real 3D 1.4 turbo 675.00	A590 Hard Drive 625.00



Phone: 979 5833 "Call now for a cheeky deal"

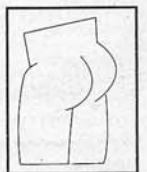

Maybe limited quantities on some items

Hardware Project

Mouse-Joystick Switch

by J. Throssell

Your Amiga has two controller ports; one for a mouse or joystick, and one for a second joystick. However, what happens when you need to swap your mouse for that second joystick for two player games? Or how about a light-gun, trackball or an analogue joystick? You have to fiddle about unplugging one to plug the other in. Invariably, you can't do it by feel, and with an A500, have to slide it forward and hold your head upside down to see what's going on ... Until now.

Here is a do it yourself switch-unit to select between two or three different controller devices. It plugs directly into the back of an A500, but could be used with any Amiga by building an extension cable.

Keeping costs down

By assembling this project yourself, you will easily have change from thirty dollars. To keep costs down, the use of an expensive commercial case has been avoided. (There were none the right size, anyway.) This also means you don't have to spend heaps of time aligning and drilling holes for the DB9 connectors. Believe me, you have better things to do. Additionally, an inexpensive, easy to obtain rotary switch

has been used. A switch to enable/disable all nine possible connections is both bulky and very expensive. Instead, a thoughtful design compromise was made; switching only the four essential connections.

Before you jump in

Building electronics projects is a fun and satisfying pastime. Like computing, it presents you with endless skills to learn, and problems to solve. Like computing, you also have to learn to walk before you can fly. This is a simple project, but requires fairly fine soldering. If you are new to soldering and other electronic construction techniques, you would do better to start on something else first. Try a Dick Smith Fun Way Into Electronics project. Once you can construct a Fun Way Volume 2 project, this one will be easy! You can always buy the switch-unit ready made, if you prefer.

Construction, step by step

1. The female right-angle DB9 connector should be disassembled; removing its front lock-nuts and PC board

Component placement. The right-angle D-9 connector (at the right of the PC board) plugs into your Amiga.



Build a Mouse-Joystick Switch

mounting pins. With these gone, its metal faceplate may come loose - use a dab of glue such as Araldite to hold it in place. Don't get glue on any electrical contacts.

2. While you have the Araldite handy, use a pin or small nail to put a dab on the base of the sixteen rotary-switch legs. This is important - it holds the metal legs to the switch's plastic base, and saves them being dislodged as you fit the switch to the PC board. Don't get the glue too high up the metal legs, or the switch will not sit flush on the PC board.

3. Using the PC board as a template, mark and drill eight mounting holes along the edge of the kraftwood base. Make sure the PC board is the right way around, and the tracks are facing down. Try not to drill all the way through the kraftwood.

4. You must now wait until the glue is dry. It is best to solder the rotary-switch in first, so be patient; don't be tempted to solder in the other components yet.

5. When the glue is dry, use side-cutters to carefully trim the round eyelets off the rotary-switch's sixteen legs. This is so the legs can be fed through the holes in the PC board; don't cut them too short! Try not to twist the legs as you cut them - they are a tad fragile.

6. Mounting the switch requires a little patience. Ensure none of the legs

are bent, and none have burrs which may prevent them fitting through their holes. The legs are numbered; leg-1 is soldered to the only square pad, leg-2 is closest to the right of the PC board (see photo). A pencil mark on the side of the switch and above the square pad-hole will help maintain alignment. Note: you must align the switch correctly - it will not work if you don't. Gently manoeuvre the switch into place, ensuring no legs get bent under or caught. With the switch neatly in place, ensure all legs are through their holes. Ensure the switch shaft still turns, and clicks positively. Now you can solder it in place, being careful not to short any tracks with solder blobs.

7. You can now insert and solder the four DB9 connectors. As in the photo, the female right-angle DB9 goes at the right of the PC board. Again, solder carefully, and ensure the DB9s sit flush and square on the PC board.

8. Using side-cutters, trim any excessively long leads from the rotary-switch, to ensure they will not touch the kraftwood base. You should not have to trim the DB9's.

9. Check your work! Look for dry-joints and shorted tracks. A multimeter or circuit tester will help, but is not essential.

10. Once happy with your soldering, the PC board can be fixed onto the kraftwood base. Firstly, put the female DB9's 4BA replacement lock-bolts in position. Now screw in the two rightmost self-tappers - these will keep the lock-bolts from falling out. The remaining self-tappers can now be installed, using a small plastic spacer between the PC board and the DB9's mounting shoulders. Don't overtighten the self-tappers. The spacers are cosmetic only; leave them out if you wish.

11. Fit the switch knob to the end of its shaft. With the unit rear mounted on an A500, the switch shaft sits just high enough to be reached.

12. Turn off your Amiga, unplug your mouse, and plug in the completed switch-unit. Screw in the two lock-bolts; these will stop the switch-unit working loose. Now plug your mouse and joystick in, and you're ready to test.

Testing and trouble shooting

The most clockwise switch position enables the outermost DB9 connector, the centre position enables the centre DB9. Turn the switch to enable your mouse, then turn on the power. Your Amiga should behave as usual - remember to check both mouse buttons. Turn the switch to a different position. The mouse should stop working.

Re-enable the mouse and fire up your favourite two player game. Now switch to the joystick. Ensure that you can move in all directions, and the fire button works. Hopefully, you are now happy and finished. No? Power down your Amiga, don't despair, and read on. There is little that can go wrong with this project. The worst event - a misplaced rotary-switch, can be avoided by following step 6 carefully. A misplaced rotary-switch is likely to stop everything working, in all switch positions.



A bad solder joint, or splashed solder are the only other likely gremlins. If a mouse button or fire button fails to work, look for a bad solder joint. If the joystick is stuck in a particular direction, suspect splashed solder. If you can't fix it, try a friend or your local user group.

The design

Compatible with devices described in the Amiga Hardware Reference Manual, the switch-unit has been tested with the Amiga mouse, normal joysticks, auto-fire, and analogue joysticks, plus a light-gun.

The switch-unit passes pins 5,7,8 and 9 of a selected connector to the corresponding pins on the Amiga. All other pins are permanently connected. Thus, the power and ground rails are removed from any non selected device. Likewise, the analogue joystick wipers are disconnected, preventing them from possible interference with other devices.

The switch-unit would not be suited to anything other than its intended purpose. Because Amiga controller ports

Quadrant

POWER PACKER PROFESSIONAL
 Increase Storage By Fourty Percent \$35.95
NEWSFLASH DISK MAGAZINE (2Disks)
 A Disk Magazine With A Difference \$16.95

AMIGA SOFTWARE

3-D Construction Kit	\$99
3-D Professional	\$99
3-D Test Animator	\$79
Amiga Vision	\$79
Amos The Creator	\$79
Amos 3D	\$79
Amos Compiler	\$79
Amos Pages	\$79
Bible Reader	\$10
Broadcast Tiltler	\$79
Buddy System MAGINE	\$79
Buddy System Amiga Docs	\$79
Bumper Sticker Maker	\$79
Can Do Intro Pack	\$99
Can Do Pro Pack	\$99
Cross Docs	\$79
Cyprus Ed V2.0	\$119
Deluxe Paint 4	\$79
Diskmaster 1.1	\$79
Distance Sums 3	\$79
Distance Sums 4	\$79
Doc 2 Docs	\$79
Dr T's Music Soft	\$9
Duplex Utilities	\$69
Easyloaders Acc	\$69
Elan Performer	\$79
Elan Performer 2	\$79
Excellence	\$79
Hyperbook	\$79
Image Tools 1	\$79
Image Tools 2	\$79
Lattice C++	\$79
Lattice C	\$79
Logo	\$79
Mac To Dos	\$79
Macro Paint	\$79
Macros	\$79
Music X Junior	\$79
Music X General	\$79
Pagestream V2.1	\$79
Pagestream Font 1-6	\$79
Pagestream Font Pack	\$79
Pelican Press	\$79
Professional Page 2	\$79
Prowrite V2.0	\$79
Quarterback Hd Ut	\$79
Quarterback Tools	\$79
Quick-Write	\$79
Screencolour	\$79
Screenpack Pro 4	\$79
Stata 1.2	\$79
Stata Pro	\$79
Stata 2	\$79
Stata 3	\$79
Stata 4	\$79
Stata 5	\$79
Stata 6	\$79
Stata 7	\$79
Stata 8	\$79
Stata 9	\$79
Stata 10	\$79
Stata 11	\$79
Stata 12	\$79
Stata 13	\$79
Stata 14	\$79
Stata 15	\$79
Stata 16	\$79
Stata 17	\$79
Stata 18	\$79
Stata 19	\$79
Stata 20	\$79
Stata 21	\$79
Stata 22	\$79
Stata 23	\$79
Stata 24	\$79
Stata 25	\$79
Stata 26	\$79
Stata 27	\$79
Stata 28	\$79
Stata 29	\$79
Stata 30	\$79
Stata 31	\$79
Stata 32	\$79
Stata 33	\$79
Stata 34	\$79
Stata 35	\$79
Stata 36	\$79
Stata 37	\$79
Stata 38	\$79
Stata 39	\$79
Stata 40	\$79
Stata 41	\$79
Stata 42	\$79
Stata 43	\$79
Stata 44	\$79
Stata 45	\$79
Stata 46	\$79
Stata 47	\$79
Stata 48	\$79
Stata 49	\$79
Stata 50	\$79
Stata 51	\$79
Stata 52	\$79
Stata 53	\$79
Stata 54	\$79
Stata 55	\$79
Stata 56	\$79
Stata 57	\$79
Stata 58	\$79
Stata 59	\$79
Stata 60	\$79
Stata 61	\$79
Stata 62	\$79
Stata 63	\$79
Stata 64	\$79
Stata 65	\$79
Stata 66	\$79
Stata 67	\$79
Stata 68	\$79
Stata 69	\$79
Stata 70	\$79
Stata 71	\$79
Stata 72	\$79
Stata 73	\$79
Stata 74	\$79
Stata 75	\$79
Stata 76	\$79
Stata 77	\$79
Stata 78	\$79
Stata 79	\$79
Stata 80	\$79
Stata 81	\$79
Stata 82	\$79
Stata 83	\$79
Stata 84	\$79
Stata 85	\$79
Stata 86	\$79
Stata 87	\$79
Stata 88	\$79
Stata 89	\$79
Stata 90	\$79
Stata 91	\$79
Stata 92	\$79
Stata 93	\$79
Stata 94	\$79
Stata 95	\$79
Stata 96	\$79
Stata 97	\$79
Stata 98	\$79
Stata 99	\$79
Stata 100	\$79

Datel Amiga Hardware

Boot Blocker	\$99
CD-ROM	\$99
Internal Midi	\$79
Midi Master	\$79
Midi Adapter	\$79
Replay III 2000	\$79
Replay III 500	\$79
Replay III 800	\$79
Replay III Express 2000	\$79
Replay III Express 500	\$79
Replay III Express 800	\$79
Replay III Express 11	\$79
Replay III Express 12	\$79
Replay III Express 13	\$79
Replay III Express 14	\$79
Replay III Express 15	\$79
Replay III Express 16	\$79
Replay III Express 17	\$79
Replay III Express 18	\$79
Replay III Express 19	\$79
Replay III Express 20	\$79
Replay III Express 21	\$79
Replay III Express 22	\$79
Replay III Express 23	\$79
Replay III Express 24	\$79
Replay III Express 25	\$79
Replay III Express 26	\$79
Replay III Express 27	\$79
Replay III Express 28	\$79
Replay III Express 29	\$79
Replay III Express 30	\$79
Replay III Express 31	\$79
Replay III Express 32	\$79
Replay III Express 33	\$79
Replay III Express 34	\$79
Replay III Express 35	\$79
Replay III Express 36	\$79
Replay III Express 37	\$79
Replay III Express 38	\$79
Replay III Express 39	\$79
Replay III Express 40	\$79
Replay III Express 41	\$79
Replay III Express 42	\$79
Replay III Express 43	\$79
Replay III Express 44	\$79
Replay III Express 45	\$79
Replay III Express 46	\$79
Replay III Express 47	\$79
Replay III Express 48	\$79
Replay III Express 49	\$79
Replay III Express 50	\$79
Replay III Express 51	\$79
Replay III Express 52	\$79
Replay III Express 53	\$79
Replay III Express 54	\$79
Replay III Express 55	\$79
Replay III Express 56	\$79
Replay III Express 57	\$79
Replay III Express 58	\$79
Replay III Express 59	\$79
Replay III Express 60	\$79
Replay III Express 61	\$79
Replay III Express 62	\$79
Replay III Express 63	\$79
Replay III Express 64	\$79
Replay III Express 65	\$79
Replay III Express 66	\$79
Replay III Express 67	\$79
Replay III Express 68	\$79
Replay III Express 69	\$79
Replay III Express 70	\$79
Replay III Express 71	\$79
Replay III Express 72	\$79
Replay III Express 73	\$79
Replay III Express 74	\$79
Replay III Express 75	\$79
Replay III Express 76	\$79
Replay III Express 77	\$79
Replay III Express 78	\$79
Replay III Express 79	\$79
Replay III Express 80	\$79
Replay III Express 81	\$79
Replay III Express 82	\$79
Replay III Express 83	\$79
Replay III Express 84	\$79
Replay III Express 85	\$79
Replay III Express 86	\$79
Replay III Express 87	\$79
Replay III Express 88	\$79
Replay III Express 89	\$79
Replay III Express 90	\$79
Replay III Express 91	\$79
Replay III Express 92	\$79
Replay III Express 93	\$79
Replay III Express 94	\$79
Replay III Express 95	\$79
Replay III Express 96	\$79
Replay III Express 97	\$79
Replay III Express 98	\$79
Replay III Express 99	\$79
Replay III Express 100	\$79

GAMES

&

other

SOFTWARE

OR

CHRISTMAS

IDEAS

Give us a call

NEW EXTENSIVE
PRODUCT CATALOGUE
AMIGA \$3.00
C64/128 \$2.00
INCLUDES POSTAGE

Postage Charges
Australia Wide Courier
3Kgs For \$6
Call for Surface Rates

Never **UNDERSOLD** on

PRICE or SERVICE

PRICES SUBJECT TO CHANGE WITHOUT FURTHER NOTICE

What you need is not listed Give us a call

QUADRANT COMPUTERS

PO Box 380 Morley
26 Rochester Way
Dianella WA 6062

Mobile (018) 918 608
Tel (09) 375-1933
Fax (09) 375-1113

are software reconfigurable, it is possible that some form of controller could be incompatible with this design. None have yet been found.

Going further

Depending on response, I'm contemplating a series of do-it-yourself projects in the months to follow. Surprise surprise, included are several games controller devices. If you like motorcycle simulators, the next project will be a blast ...

All care, no responsibility

With electronic projects, mistakes may cause damage - even to your Amiga. In the unlikely event of damage of any kind, neither the author nor this magazine may be held responsible or liable in any way.

Parts List 1 x PC Board

As per the artwork
 1 x Kraftwood base. 9 x 32 x 83mm.
 Routed to 1mm for component leads
 1 x Rotary-switch. 4 pole 3 position.
 Available from Dick Smith cat. P-7520

1 x Female DB9 connector. Right-angle PC board mounting - available from Dick Smith cat. P-2683

3 x Male DB9 connectors. PC board mounting

8 x Self-tappers.

12 x 2.5mm6 x Spacers. 4mm black plastic tubing cut to 5.5mm

2 x 4BA bolts. 6mm

You will also need

Araldite or similar glue, solder, and a knob for the switch. Choose whichever style of switch knob you prefer.

Special Offer

To make your life easier, the author has arranged a series of kits, available for the next few months. All prices include postage and packing.

1. Pre-drilled PC board, and matching kraftwood base. \$12.00

2. Kit of parts, including the above. You supply the knob, solder and glue. \$27.50

3. Complete unit, assembled and tested. You choose and supply the knob. \$34.90

Simply send a cheque or money order to GTA Systems, and allow 14 days for delivery. The address:

GTA Systems
 Amiga Switch Kit Offer
 GPO Box 2171
 Canberra, ACT 2601

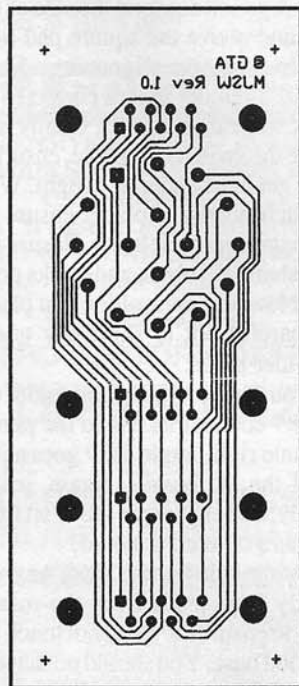

PC Board Artwork - Actual Size

Circuit Diagram

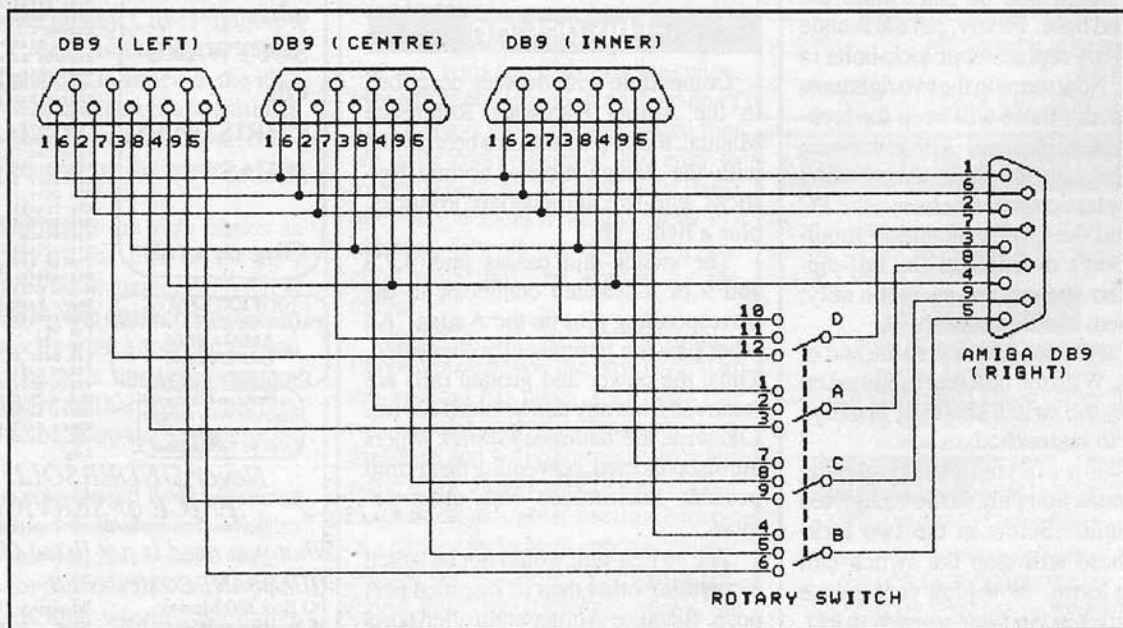



GREAT VALLEY PRODUCTS INC.

GVP SERIES II A2000 HARD CARD EXPANDIBLE TO 8Mb RAM

52Mb SERIES II HARD CARD ORAM	\$ 849
80Mb SERIES II HARD CARD ORAM	\$1019
105Mb SERIES II HARD CARD ORAM	\$1179
170Mb SERIES II HARD CARD ORAM	\$1749

GVP SERIES II A500+ SCSI CONTROLLER, EXPANDIBLE TO 8Mb RAM, CUSTOM MINI SLOT

52Mb SERIES II SCSI CONTROLLER	\$ 979
105Mb SERIES II SCSI CONTROLLER	\$1399

GVP A2000 SCSI CONTROLLER EXPANDIBLE TO 8Mb RAM

A2000 SCSI CONTROLLER ORAM	\$399
A2000 SCSI CONTROLLER 2MB RAM	\$499

NEW!



GREAT VALLEY PRODUCTS INC.

Digital Sound Sampler

8 Bit Stereo Sound

\$ 199.00

Includes Software



Merry Christmas & Happy New Year From the Management & Staff of Computa Magic & M.V.B. Computer Supplies

LAY-BY AVAILABLE

* Mail Orders Welcome!

M
MicroBotics, Inc.

VXL30 High Speed 68030 Acceleration for your Amiga A500 / A2000

- Solderless no modification installation.
- Advanced Technology AUTOConfig design.
- Supports CPU clock speeds of upto 50 Mhz, FPU clock speeds of upto 60 Mhz.
- Optional 2 or 8MB 32-Bit Burst Mode RAM.
- Fully compatible with other expansions including Great Valley Products disk systems.
- Software/Hardware switch to 68000 mode.
- Workbench 2.0 chip socket on memory board.

25Mhz 68030	\$ 749
25Mhz 68030/68882	\$ 999
33Mhz	\$ Call
40Mhz	\$ Call
50Mhz	\$ Call
2MB 32Bit RAM Expansion	CALL

The Ultimate A2000 Expansion



SERIES II ACCELERATOR

- *22 Mhz or 33 Mhz models available
- *Single PCB design (featuring)
 - * 68030 (cpu), 68882 (fpu)
 - * Series II SCSI controller with GVP Faaast Rom
 - * Up to 16Mb of 32-bit-wide RAM (60ns)
 - * Optional mounting bracket for 3.5" SCSI hard disk.
 - * Supports All Workbench revisions and Amiga UNIX
 - * The fastest ZERO wait-state design possible.

22 Mhz, 1Mb RAM

\$ 1,529

33Mhz, 4 Mb RAM

\$2,399

★ COMING SOON ★

DCTV

Commodore AMIGA

CDTV MULTI MEDIA

M.V.B. Computer Supplies PTY LTD

506 Dorset Road, Croydon, Victoria, 3136.
PH: (03) 725 6255 Fax: (03) 725 6766.

Computa Magic PTY LTD

44 Pascoe Vale Rd, Moonee Ponds 3039
PH: (03) 326 0133 Fax: (03) 370 8352

E & OE

Prima!

A Look Inside the Ultimate A500.

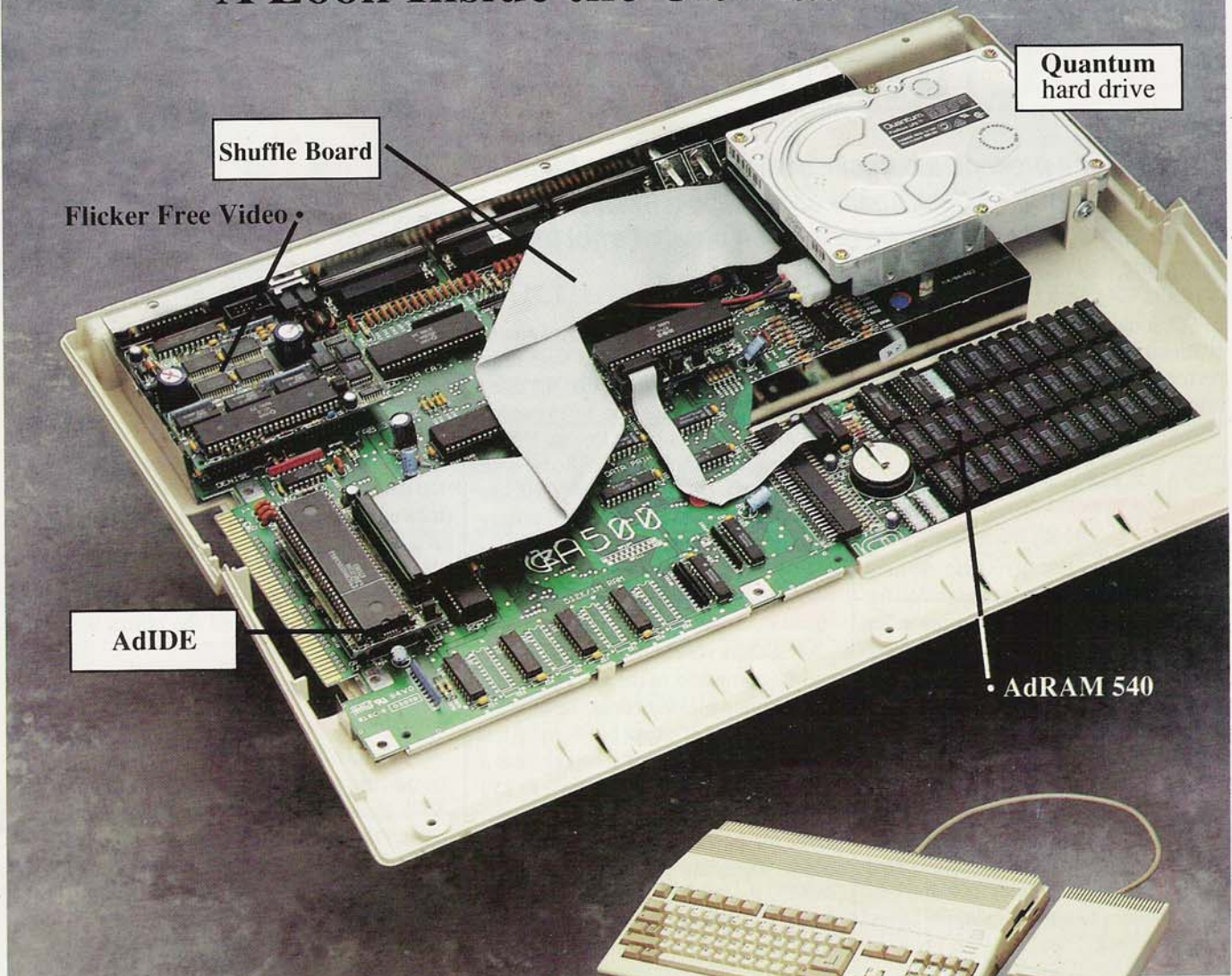

ICD proudly presents **Prima™**, the high performance, low cost hard drive for Amiga® 500 computers. Prima blends a large capacity, low power Quantum™ hard drive with the **AdIDE™** host adapter for an unbeatable combination.

Prima replaces the internal floppy drive but includes **Shuffle Board™** to make your external floppy drive DF0:. **Prima** features auto-booting from FastFileSystem partitions, high speed caching, auto-configuring, and A-MaxII™ support. Formatted capacities of 52 and 105 megabytes are currently available.

Also suits Amiga 1000!
Introductory Pricing:
Prima 52Mb Quantum \$749
Prima 105Mb Quantum \$999
Call for other ICD Products

 **Sigma**com

Tel (02) 545 3383
 (018) 25 7471

Hot Buys for this Christmas

Looking for a present, a bargain, something slick to brighten up your computer's desk space or perhaps a fresh sampling of sizzling software? Here's a run-down on what's hot for this summer.

I'm looking for something with no artificial anything. We're talking 100% performance. Well, it depends on the price of course.

So, let's start with something cheap everyone can afford.

Under \$20

☛ A few disks of public domain software could keep you entertained for hours. Several companies now offer packs of software which are excellent value. Games, utilities, education - it's all available. See the advertisements in this issue.

Under \$50

☛ Replace your Amiga mouse with ROCTECRM300C. Better buttons (real micro switches) a smarter look and better feel - this is a must have for every Amiga owner.

Under \$100

☛ For this sort of money, grab yourself an extra 512K of RAM and start

playing some of the 1 Megabyte games around the traps. Even old favourites like *Interceptor* have better digitised sound samples when run in expanded memory conditions. As low as \$89 or even less - be sure to get a model with battery back calendar. On/off switches should be external ... the internal variety are too hard to get at.

Under \$150

☛ When your mouse becomes old and fat compared to the fast paced life you're trying to lead, it could be time for a brush mouse. It's not a brush, in fact, it looks like a pen - but it works like a mouse. The JP-100P is accurate to 250 DPI and replaces the Amiga mouse. Ideal for painting, structured-drawing or just mouseing, er, brushing around. At \$139 the brushmouse ain't cheap, but then it's got a lot of style and sure leaves your desk a lot less cramped.

Under \$200

☛ What's thin, black and looks great next to a CDTV player or dangling off

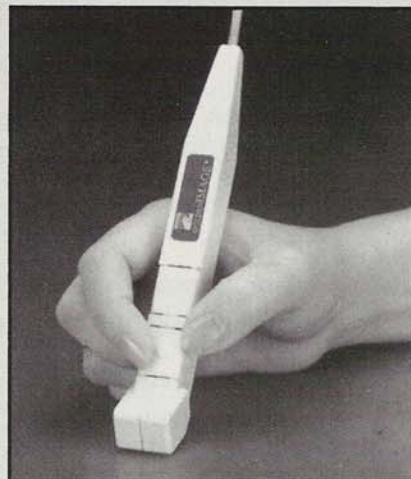

The JP-100P

the side of an Amiga 500? How about the new slim-line matt black Roctec 3.5 inch external floppy drive. Not that the drive is floppy, but that's what you feed this sleek black critter. Complete with pass-thru and on/off switch, the external drive which out-looks all the others is \$199.

Under \$400

☛ A must have for every Amiga 2000 owner, the A2320 De-Interlacer card at \$375 fixes your flicker problems forever. Did I mention you need a \$750 Multisync monitor to go with this baby? Well, you do. Ideal for CAD, Desktop Publishing and 3D Modelling.

Under \$500

☛ For this sort of money you're talking a Citizen 200GX Colour printer, one of the best value for money 9-pin dot

Roctec RM300C

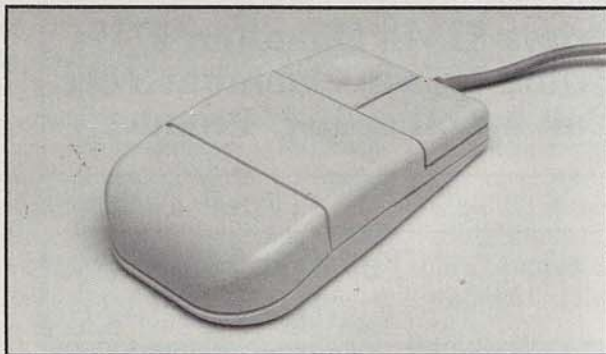

Roctec 3.5" External Floppy Drive

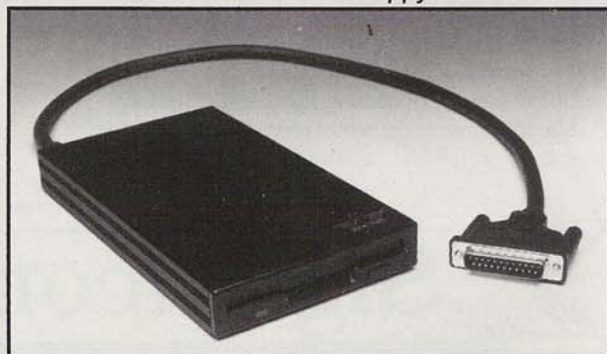

matrix printers around (check out the review in this issue). Along with an easy to use control panel, tractor-feed paper parking and 240 DPI, this printer is ready to handle the majority of Amiga tasks. Expect to pay \$499 from most Amiga retailers.

Under \$1000

☛ The best (and I say only) way to add a hard drive to your Amiga 500 is the GVP A500-HD with room for some eight megabytes of RAM. A fast, no fuss solution which looks at home next to the A500. Complete with a 52 Megabyte hard drive, you might pay \$999 at the right shop.

Under \$1500

☛ CDTV - Well, this is a maybe. At

\$1375 the price is becoming more tempting. However, you may want to wait for the A690, the Amiga 500 add-on CD Drive. Many Amiga games don't work on the player and applications are still only trickling out. (We heard a rumour that if you're at Grace Bros. on a Saturday and meet a Commodore consultant, you could be the fortunate recipient of a free copy of Groliers Encyclopedia, value \$599, as an incentive to help you decide to buy a player. What a bargain!

☛ How about a Sharp JX-100 scanner? Not quite the same as the JX-300 here at ACAR's offices, but good enough for small jobs. Full 18-bit accuracy, fine for scanning prints. Good enough for professional quality black and white half tone scans. Every desktop publisher's dream. Hard Disk Cafe have them for \$1495.

And don't get caught with these...

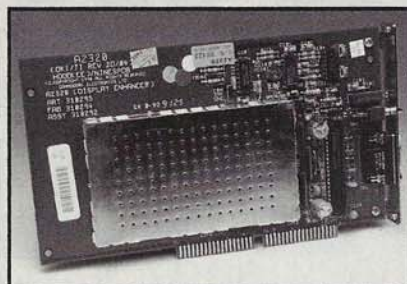

A2320 Display Enhancer

AREXX - Why bother! Workbench 2.0 has AREXX included as part of the \$99 upgrade available soon. Hang around a short while and you can pick it up as part of the whole deal.

Sculpt 4D - No longer supported by the publisher and fast being superseded by packages such as *Imagine* and *Real 3D*. *Sculpt* is fast turning into a white elephant. Best avoided at around \$599.

ATonce-Plus

16 Mhz IBM-AT-Emulator

for the Amiga 500

including 512k ram and optional co-processor

\$499

80286-16 processor + multitasking
704K Base + Extended/Expanded memory
Boot from hard drive and support all Amiga hardware
Copy from DOS to DOS with supplied utility
VGA-EGA-CGA Graphics
Dealers required

A500 2M RAM board \$279

including 2M RAM

105M Quantum hard drive \$795

Fit this 11m/sec drive into your A590 or 2000 and fly

Fonhof Computer Supplies

64 Cross St, Baulkham Hills NSW 2153

Phone (02) 639 7718 Fax (02) 639 5995

Desktop Utilities

PO Box 3053, Manuka, ACT 2603
Phone: Canberra (06) 239 6658 Fax: 239 6619

Art Department Professional

Version 2.0

New features include:

- Additional file formats JPEG, BMP & QRT
JPEG: remarkable image compression
BMP: standard Windows 3.0 image format
QRT: a common 24 bit ray tracing format
- 24 bit output to colour Preferences printers
- 8 bit output to b/w Preferences printers
- Support for new 24 bit display devices

Ask your dealer for ADPro with our
Technical Support Registration

Amiga Bureau Services

Software distribution
Scanning & Laser printing
Colour slide output
File conversions; Training

PURE GENIUS



Genius Digitising Tablet

Add a professional touch to your drawing/CAD work. The Genitizer graphics Tablet utilizes latest technology at the tip of a Stylus. Fits in the serial port of your Amiga 500/1000/2000 and co-exists with your mouse.

Only \$399.00



A Top Quality 400DPI Handy Scanner for the Amiga at a truly Unbeatable Price!

Datel Geniscan

Scanning couldn't be simpler. . . . Unmatched range of edit/capture facilities and keyboard control simply not offered by other Scanners. Geniscan gives you the ability to easily scan images, text and graphics and even offers 200dpi dual scan mode.

Only \$399.00

Comes with FREE Photon Paint

GeniScan™

VIDEO DIGITISER II

Now you can digitise pictures from any video camera or VCR

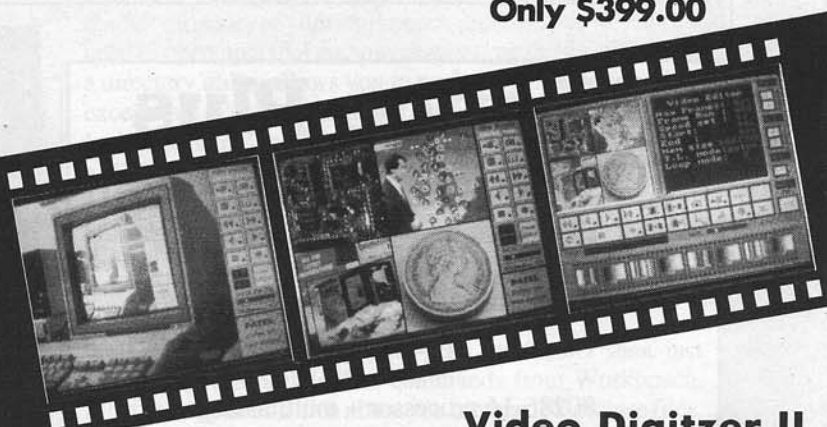

Video Digitizer II

Completely newly designed interface that plugs into the Expansion Port of the Amiga 500 or the internal connector of the Amiga 2000. Frame grab in 1/50 second, record update up to 3 frames per second. Times lapse feature adjustable in one second increments to one hour between each frame. Ideal for capturing flowers opening etc. Please state A500 or A2000 when ordering. RGB Splitter extra

Only \$262.00



Now with full COLOUR option

With the addition of the RGB splitter, to the video digitiser II you can obtain colour images in only 1 second!



Proudly Serving Australia

Macro-soft

Mail Order



Accepted

PHONE (08) 234 5050

G.P.O Box 1121
Adelaide, S.A. 5001

Dealer Enquiries
Welcome

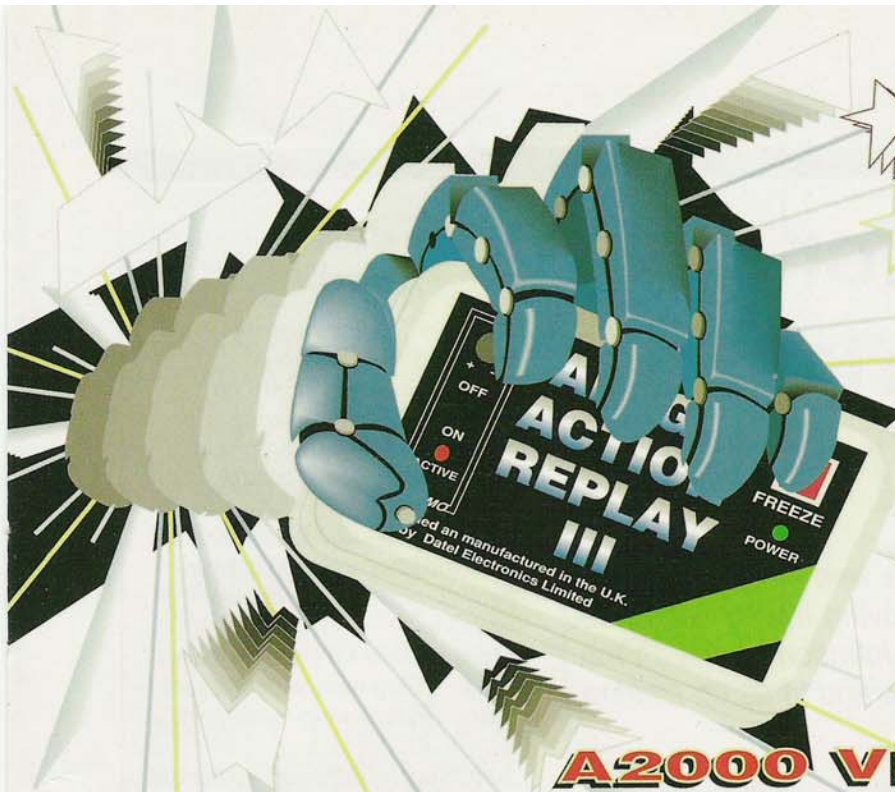

NEW AMIGA ACTION REPLAY MK III STILL ONLY \$199

A2000 VERSION \$229

THE WORLDS MOST POWERFUL FREEZER-UTILITY CARTRIDGE

JUST LOOK AT THE UNMATCHED RANGE OF FEATURES

● **SAVE THE ENTIRE PROGRAM IN MEMORY TO DISK**
Special compacting techniques enable up to 3 programs to fit on one disk. Now saves directly to disk as Amiga Dos - reloads independently of the cartridge - even transfer to hard drive!
Works with up to 2 Megs of Ram - even 1 Meg Chip Mem (Fatter Agnus).

● **SUPER POWERFUL TRAINER MODE**

now with DEEP trainer. Even better than before - allows you to generate more or even infinite lives, fuel, ammo. Perfect as a Trainer Mode to get you past that "impossible" level. Easy to use.

● **IMPROVED SPRITE EDITOR**

The full Sprite Editor allows you to view/modify the whole sprite set including any "attached" sprites. PLUS A RANGE OF IMPROVED FEATURES.

● **VIRUS DETECTION**

Comprehensive virus detection and removal features to protect your software investment. Works with all presently known viruses.

● **BURST NIBBLER**

Now this super disk copier program is built into Action Replay Mk III. Just imagine a superfast, efficient disk copier program at the press of a key - no more waiting.

● **SAVE PICTURES AND MUSIC TO DISK**

Pictures and sound samples can be saved to disk. Files are saved directly in IFF format suitable for use with all the major graphic and music packages. Samples are displayed as screen waveform.

● **PAL or NTSC MODES SELECTABLE**

Useful for removing ugly borders when using NTSC software. (Works only with newer Agnus chips).

● **SLOW MOTION MODE**

Now you can slow down the action to your own pace. Easily adjustable from full speed to 20% speed. Ideal to help you through the tricky parts!

● **MANY MORE INSTANT CLI COMMANDS**

like Rename, Relabel, Copy, etc.

● **RESTART THE PROGRAM**

Simply press a key and the program will continue where you left off.

● **FULL STATUS REPORTING**

At the press of a key now you can view the Machine Status, including Fast Ram, Chip Ram, RamDisk, Drive Status, etc.

● **POWERFUL PICTURE EDITOR**

Now you can manipulate and search for screens throughout memory. Over 50 commands to edit the picture plus unique on screen status "overlay" shows all the information you could ever need to work on screens. No other product comes close to offering such dynamic screen handling of frozen programs!!

● **JOYSTICK HANDLER**

allows the user to select Joystick instead of Keypresses - very useful for many keyboard programs.

● **MUSIC SOUND TRACKER**

With Sound Tracker you can find the complete music in programs, demos, etc. and save them to disk. Saves in format suitable for most track player programs. Works with loads of programs!!

● **AUTOFIRE MANAGER**

From the Action Replay III preference screen you can now set up autofire from 0 to 100%. Just imagine continuous fire power? Joystick 1 and 2 are set separately for that extra advantage!

● **IMPROVED RAM EXPANSION SUPPORT**

Now many more external Ram Expansions will work with all Action Replay III commands.

● **DISKCODER**

With the new "Diskcoder" option you can now 'tag' your disks with a unique code that will prevent the disk from being loaded by anyone else. "Tagged" disks will only reload when you enter the code. Very useful for security.

● **SET MAP**

allows you to Load/Save/Edit a Keypad.

● **PREFERENCES**

Action Replay III now has screen colour preferences with menu setup. Customise your screens to suit your taste. Very simple to use.

● **DISK MONITOR**

Invaluable disk monitor - displays disk information in easy to understand format. Full modify/save options.

● **IMPROVED PRINTER SUPPORT**

including compressed/small character command.

● **DOS COMMANDS**

Now you have a selection of DOS commands available at all times - DIR, FORMAT, COPY, DEVICE, etc.

● **FILE REQUESTOR**

If you enter a command without a filename, then a file requestor is displayed.

● **DISK COPY**

Disk Copy at the press of a button - faster than Dos Copy. No need to load Workbench - available at all times.

● **PLUS IMPROVED DEBUGGER COMMANDS**

including Mem Watch Points and Trace.

● **BOOT SELECTOR**

Either DF0 or DF1 can be selected as the boot drive when working with Amiga Dos disks. Very useful to be able to boot from your external drive.

PLUS A MACHINE CODE FREEZER MONITOR WITH EVEN MORE POWER!!

EVEN MORE FEATURES INCLUDING 80 COLUMN DISPLAY AND 2 WAY SCROLLING:-

- Full M68000 Assembler/Disassembler
- Full screen editor
- Load/Save block
- Write String to memory
- Jump to specific address
- Show Ram as text
- Show frozen picture
- Play resident sample
- Show and edit all CPU registers and flag
- Calculator
- Help command
- Full search feature
- Unique Custom Chip Editor allows you to see and modify all chip registers - even write only registers
- Notepad
- Disk handling - show actual track, Disk Sync. pattern etc.
- Dynamic Breakpoint handling
- Show memory as HEX, ASCII, Assembler, Decimal
- Copper Assemble/Disassemble - now with suffix names

REMEMBER AT ALL TIMES YOU ARE INTERROGATING THE PROGRAM IN IT'S "FROZEN" STATE WITH ALL MEMORY AND REGISTERS INTACT - INVALUABLE FOR THE DE-BUGGER OR JUST THE INQUISITIVE!



Proudly Serving Australia

Macro-soft

PH: (08) 234 5050

FAX: (08) 352 8305

G.P.O. BOX 1121 ADELAIDE .S.A 5001

Amos for Aardvarks Part I

If you're eating AMOS code in the wee small hours, or battling the Atari-like interface and loving it, you need this column. Starting this month, Wayne Johnson brings us the latest on AMOS along with useful tips and hints on making AMOS cook.

Those of you who have abandoned the AmigaBASIC ship and joined the AMOS race will know what a serious and powerful programming platform it is. We now have the power to create that dream game, utility, or database, the list goes on. Everything that was once only possible in assembler, is now available in AMOS. You can manipulate the copper lists, convert and use *Soundtracker*, *GMC* and *Sonix* tunes (full *Protracker 1.1b* and *Med3.1* support on the way), access to screen and window programming, fully manageable Sprites and BOBs, mouse and joystick control, interrupts and more. All using simple BASIC type commands.

What is AMOS anyway?

For those who don't know much about it, AMOS itself is slightly Pascal related with its structured layout with Procedures and so forth. Procedures are like subroutines except that they can be closed into a single line and be called like a command - no more GOSUBs or GOTOs. However, all the original BASIC commands are still there. Assembler programmers are in no way left out. AMOS and assembled code can be married with ease. Simply by loading your code into AMOS and using the CALL command, AMOS will immediately execute that code. AMOS also gives programmers the best understanding of how to get into Assembler, because as you program, you begin to understand how screens work, the rules and limits of BOBs and sprites.

AMOS is comprised of two modes.

Editor Mode is where the grunt work is done. This is a text editor with a few added extras. Along the top 10% of the screen are icons that serve tasks such as, string search, block copying and pasting, loading and saving programs, swapping between programs (multiple programs can be loaded into AMOS), etc.

Pressing Esc takes us to the second mode, Direct Mode. Here, we can look at the current default screen. The default screen is to AMOS programmers what the output window is to AmigaBASIC programmers. Running across the screen is a small text input window where we can enter commands to see the effect of a command's use or fine tune things, eg. where we want to position a BOB or find the right colour for a palette.

Here also, we can issue the command LISTBANK to show us the current list of banks that the current program is using. Banks are blocks of code or data that your AMOS program uses for BOB and sprite definitions, machine code, music code, and others. The different bank types are described below:

Sprites - Images to be used as sprites or BOBs

Icons - Images that can be pasted on the screen like tiles

Music - Tracker songs that can be played under interrupt

Amal - Interrupt animation language. Used for moving screens, BOBs, sprites, VU meters, joystick control, all under interrupt

Samples - Just that. Data that holds your sound samples to be played back through specified sound channels.

Menu - Data for custom menus

Chip - Chip memory workspace

Fast - Fast memory workspace

AMOS is very different to other languages in that it is considered an open language. This means that the 500+ commands that come with AMOS is not where it ends. You can order many EXTENSIONS which add extra commands to your AMOS system, or if you know machine language you can even add your own!

Contrary the popular belief, AMOS will not write programs for you. Nor is it a construction kit. It is a serious and powerful development language. You still have to spend many hours designing and writing your code. Graphics and sound again take time.

Graphics from paint programs such *Deluxe Paint* or *Photon Paint* can be incorporated into your AMOS programs with ease. Therefore, AMOS is not a stand alone design package. It may sometimes need other design packages. I say sometimes - because of the power of the programming system, paint programs can be written entirely in AMOS. AMOS Paint is one example. So, graphics can be designed from within AMOS without the need of a commercial Paint program. However, you can never go past the tools in *Deluxe Paint* for quality design.

Music programs can be used to create soundtracks in your own programs. The currently supported music programs are *Sonix*, *Soundtracker 1.6* to *2.5*, *Noisetracker 1.0* to *2.0*, and *Protracker 1.0* to *1.1b*. If the tunes from these programs are saved as modules, they can be converted with a program sup-

TALK TO YOUR TELEVISION

CDTV AVAILABLE FROM

Myer, Grace Bros, Norman Ross, Harvey Norman, Bing Lee and following dealers

NSW: The Hard Disk Cafe, Shop 4 Computers, Free Home Demo, Casino Computers, Orana Home Business Centre, Leeton Audioelectronics, Chanticleer Video Computer Centre.

Vic: High Technology, Maxwell's, Cranbourne Computers, Webbs Electronics, Jennings Discounts, Computa Magic, Roylane, Frank Day & Associates, St. Albans Home Entertainment

Qld: United Computers, Tropical TV Services, City Computer Centre, Active Computers

SA: Harris Scarfe, Pick'n'pay Hypermarket

Tas: Angus & Robertson, Quadrant Computer Centre, The Floppy Shop

WA: Hedlam Computers, Narrogin Computers, Computer Corner, Regional Computers

Phone Commodore (02) 428 7777 for a dealer near you



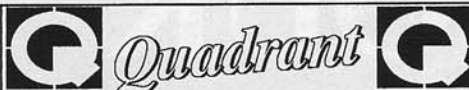

PD FOR THE PEOPLE

END THE PD MEGA RIP-OFF TODAY

NOW ONLY \$2 - \$3.00

INCLUDING NASHUA DISKETTE
AMAZ, AMICUS, AMIGAN,
AMIGA FORMAT, AMIGA NUTS
AMOS, AMIGOZ, BEST OF FISH,
CCCC, COMPASS, CRAZY JOES,
ERIC SCHWARTZ, EAGLEFAUG,
FISH, FILLET O FISH, LARSON,
MACRO, NZAMIGA, PHOENIX,
SCOPE, SMAUG, SNAG, TBAG
TOBIAS RICHTER AGATRON,
17BIT, TCUG, TOPIK

3 DISK CATALOGUE \$4

CATALOGUE LISTS PD IN DETAIL
CATALOGUES ARE POSTAGE FREE

PUBLIC DOMAIN POSTAGE CHARGES
1-10 DISKS \$1.90 11-20 \$3 21-30 \$4.90

AMIGA HARDWARE

\$\$\$ SUPER SPECIALS \$\$\$

AMIGA ACTION REPLAY MK III	\$175
AMIGA 500 INTERNAL D/DRIVE	\$135
AMAS ADV MIDI & SAMPLER	\$195
AT ONCE IBM EMULATOR	\$445
BLITZ COPIER	\$71
BODEGA BAY EXPANSION	\$\$\$CALL
DIGI-VIEW GOLD V4.0	\$245
FRAMEGRABBER PAL	\$1199
GOLDEN IMAGE HAND SCANN	\$398
GOLDEN IMAGE MOUSE	\$55
GOLDEN IMAGE OP MOUSE	\$98
GOLDEN IMAGE TRACKBALL	\$98
GVP PRODUCTS CALL FOR BEST	\$\$\$
KCS POWER PC BOARD	\$520
RADICAL MIDI INTERFACE	\$72
VIDEO BLENDER	\$2250
3.5 EXTERNAL DISK DRIVE	\$135
512K RAM CLOCK & SWITCH	\$69

ADSPED ACCELERATOR	\$393
ADRAM 540 (0-4MB) OK	\$186
ADRAM 560D (2MB)	\$326
ADRAM 2080 (0-8MB) OK	\$214
ADSCI 2000	\$216
ADSCI 2000 (0-8MB) OK	\$323
FLICKER FREE VIDEO	\$555
PRIMA 52MB INTERNAL	\$673
PRIMA 105MB INTERNAL	\$966
SLIMLINE 40MB HARD DISK	\$712
SLIMLINE 45MB HARD DISK	\$764
SLIMLINE 52MB HARD DISK	\$787
SLIMLINE 105MB HARD DISK	\$1079
A500 INTERNAL 20MB HDD	\$732
A500 INTERNAL 40MB HDD	\$867
A500 INTERNAL 60MB HDD	\$1107
A500 INTERNAL 80MB HDD	\$1299

PRICES SUBJECT TO CHANGE WITHOUT FURTHER NOTICE

What you need is not listed Give us a call

QUADRANT COMPUTERS

PO Box 380 Morley Mobile (018) 918 608
26 Rochester Way Tel (09) 375-1933
Dianella WA 6062 Fax (09) 375-1113

plied with AMOS into its own format that can be loaded into the AMOS music bank. By simply issuing the command, MUSIC 1, your AMOS program will continue executing with your music playing happily in the background.

The music system itself is an intelligent one. If you already have a piece of music playing, you can re-issue the Music command again with a different number. This new number represents a new song in the music bank. AMOS will then suspend the current piece of music and start playing the new piece. When it either ends or you stop it your ORIGINAL piece of music resumes EXACTLY from where it was interrupted.

AMOS comes with many programs such as the Sprite Editor, Soundtracker converter, and others including a sample bank definer. All of these programs are written for AMOS, in AMOS!

News

* Amos is now up to Version 1.32. This update is available through any good PD list or from The Australian AMOS Club for club members only.

* An update for the compiler should be here by the time you read this. This update should have all bugs fixed and will compile programs containing AMAL banks.

* In just over a year in existence, AMOS sales have reached 5.5 million dollars worldwide.

* The music extension is being updated to be compatible with all commands in *Protracker 1.1b* and *Med3.1*.

Ten Liners

In this section, I will feature the best 10 liner programs that appear on the scene. If you think you have a ten liner that is hot stuff, drop it in the mail to:

Ten Liners,
Wayne Johnson
24/459 The Boulevarde
Kirrawee 2232.

This month's offering is a program written by myself and Tex. Do not type in the leading brackets and numbers, they are only for reference to what line you are on.

(1)Cls 0 : Draw 5,0 To 5,10 : Draw 0,5 To 10,5 : Get Sprite 1,0,0 To 11,11 : Cls 0 : NA=2 : SPEED=20 : Gr Writing 0 : Load "extras:sprite_600/aliens/alien5.abk",1 : Hide On : Make Mask : Double Buffer : Flash Off : Get Sprite Palette : Cls 0

(2)RES: A\$="A: L RA=XM-128; L RB=YM-55; L X=RA+123; L Y=RB+50; P; J A; " : B\$="B: L R0=Z(300); L R1=Z(180); M R0-X,R1-Y,"+Str\$(SPEED*5)+"; P; J B; "

(3)Sprite 1,0,0,1 : Channel 1 To Sprite 1 : Amal 1,A\$: For A=1 To NA : Bob A,Rnd(300),-20,2 : Set Bob A,0,%11111,%11100010 : Channel A+1 To Bob A : Amal A+1,B\$: Next : Amal On

(4)MAIN: If Mouse Key=1 Then Shoot : S=1 : X=Amreg(0) : Y=Amreg(1) : Ink 6 : Polyline 0,320 To X,Y+5 To 320,320 : Wait Vbl : Ink 0 : Polyline 0,320 To X,Y+5 To 320,320 : SC=SC-3

(5)For B=1 To NA : If Spritebob Col(1,B To B)--1 and S=1 Then Gosub KLL

(6)Next B : S=0 : Inc X : If X=200 Then SPEED=SPEED-2 : X=0 : Inc NA : If NA<=8 Then Gosub PP

(7)If NA>8 Then Amal Off : Ink 11 : Text 120,100,"GAME OVER" : For A=10 To 1 Step -1 : Bell A : Wait Vbl : Next A : Repeat : Until Mouse Click=2 : Cls 0 : SPEED=20 : SC=0 : For X=1 To NA : Bob X,-100,-100,1 : Next X : NA=2 : Goto RES

(8)Goto MAIN

(9)KLL: Boom : Bob B,,,10 : Wait 3 : Bob B,Rnd(320),-10,2 : SC=SC+25 : Ink 8 : Cls 0 : Text 10,180,"SCORE:"+Str\$(SC) : Return

(10)PP: B\$="B: L R0=Z(300); L R1=Z(180); M R0-X,R1-Y,"+Str\$(SPEED*5)+"; P; J B; " : For X=1 To NA : Bob NA,Rnd(320),-20,2 : Channel X+1 To Bob X : Amal X+1,B\$: Amal On X+1 : Next X : Return

Next month we will have more news, ten liners and a help column. Any comments, suggestions, programs, or hassles, are most welcome. □



Computer Spot



Monitor not included

**AMIGA
2000 HD
\$1495⁰⁰**

**AMIGA
2000
\$995⁰⁰**

UNBEATABLE



**AMIGA PC 500
\$799
+ FREE
\$200 software**

Select \$200 worth of any software FREE!!
or receive a repacked Commodore
1802 monitor absolutely
FREE!

**AMIGA 500
\$699
+ FREE
\$200 software**

Select \$200 worth of any software FREE!!
or receive a repacked Commodore
1802 monitor absolutely
FREE!

*** Strictly limited stocks ***

Mail Order: (02) 638 2897 - (008) 252 130

BONDI JUNCTION, 110 Spring Street, Bondi Junction. **(02) 369 4355**
BRISBANE, 225 George Street, Brisbane. **(07) 229 8011**
BURWOOD, 185 Burwood Road, Burwood. **(02) 744 8809**
CHATSWOOD, Shop G9, The Gallery Arc., Endeavor St. **(02) 419 2333**
GOSFORD, 98 Mann Street, Gosford **(043) 237 463**
HURSTVILLE, 185E Forst Road, Hurstville. **(02) 570 7333**

LIVERPOOL, 205 George Street, Liverpool. **(02) 601 7700**
NEWCASTLE, 180 Pacific Highway, Charlestown. **(049) 42 1522**
PARRAMATTA, Shop21A, Greenway Arc. 222 Church. **(02) 891 1170**
PENRITH, Shop 1, Carvan Arc. 389 High St, Penrith. **(047) 32 3377**
SYDNEY, 165 Castlereagh Street, Sydney. **(02) 261 4344**
MAIL ORDER, Unit 3, 38-46 South Street, Rydalmere **(02) 638 2897**

M.A.S.T.

Technical Excellence
Proudly Australian

Flash 2000

- ✓ Up to 8 Mb RAM
- ✓ Fast 8 bit SCSI standard, upgradeable
- ✓ Optional 16 bit SuperCharged SCSI
- ✓ Massive transfer rates!
- ✓ Hard drive mounts on the card
- ✓ Three SCSI connectors (2 int, 1 ext)
- ✓ Supports SCSI CD-ROM drives
- ✓ AutoBoot disable switch
- ✓ Fully Australian designed



ColorBurst

CrystalSound

Crystal Clear Stereo Sampler

- ✓ Crystal locking provides jitter-free sampling
- ✓ Sample rates up to 70k per channel
- ✓ Dual AD converters
- ✓ Ultra low noise power filtering
- ✓ Printer pass-through
- ✓ Separate case with 1.2m cable
- ✓ Dual mic and line inputs with level adjust
- ✓ Perfect Sound compatible
- ✓ Burst mode for very high speed sampling
- ✓ Australian design



The highest quality 8 bit sampler yet
Under \$200 - Available December

Minimegs - 2 Mb Fast RAM-in-a-box

- ✓ Suitable for Amiga 500 and Amiga 1000
- ✓ Compact, ultra low power, Australian design
- ✓ True Fast RAM, contiguous, AutoConfiguring
- ✓ Easy to install - just plug in & go!

**Coming
Soon!**

Flash 500

*The popular A2000 card - for the A500!
8 Mb RAM, high speed SCSI, & 3.5" hard
drive - usable on either machine!*



**Dealer
Enquiries
Always
Welcome!**

SCSI/RAM

Flash 2000

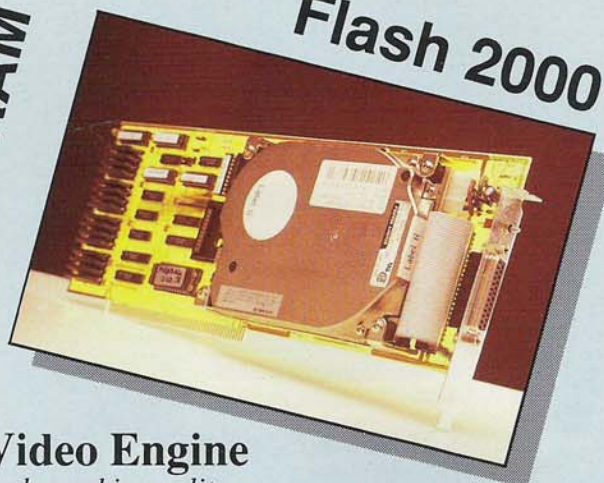

24 bit Video Engine

- professional graphic quality

- ✓ 16 million colours in 768 x 580 HiRes RGB
- ✓ For any Amiga (PAL and NTSC)
- ✓ External genlock & IFF 24 compatible
- ✓ Video graphics chip on board
- ✓ Includes 24 bit paint program
- ✓ Fully Australian designed

Lets you see how good your work really is!

S.A.M.

SMPTE And MIDI Interface

- ✓ 5 port MIDI interface - 1 in, 4 outs
- ✓ Read/write Time Code - forwards and backwards
- ✓ Can read from 25% to 220% of normal speed
- ✓ Supports PAL, NTSC, Film, and Drop Frame
- ✓ Crystal-locked accuracy
- ✓ Microprocessor controlled
- ✓ Rugged, compact, ultra low power design
- ✓ Serial port pass-through
- ✓ Compatible with *all* software supporting MTC
- ✓ Software included
- ✓ Australian designed

R.R.P. \$299

The missing link between audio and video

Enhanced Unidrive - external floppy drive

- ✓ Suitable for any Amiga - even CDTV
- ✓ Compact, ultra low power, Australian design
- ✓ Digital track display, won't click when empty
- ✓ Virus detect and write-protect switches

Computer Discounts

Software

Animagic	\$169	InterChange	\$ 65
ARexx	\$ 65	InterFont	\$130
Art Dept Pro	\$279	Karafonts	\$ 89
AudioMaster III	\$ 119 !	Kara Animfonts	\$ 75
Bars & Pipes	\$199	KCS 3.0 Level II	\$ 369 !
Bars & Pipes Pro	\$469	MapMaster	\$ 85
Blitz Basic	\$ 99 !	Masterpiece Fonts	\$249
Broadcast Titler 2	\$379	PageStream 2.1	\$289
BT2 Font Enhancer	\$189	PageStream Buddy	\$ 69
CanDo 1.5	\$145	Pen Pal	\$149
CDROM FileSys	\$ 72 !	Perfect Sound	\$139
CrossDos	\$ 45	Pixel 3D	\$ 85
DeluxePaint IV	\$179	Pro Page 2.0	\$359
Deluxe Music	\$ 95	Pro Video Post	\$379
Design Works	\$149	Pro Textures	\$ 79
DigiView Gold 4.0	\$239	Quarterback	\$ 75
Director 2.0	\$159	Quarterback Tools	\$ 75
Dr T's Tiger Cub	\$ 99 !	RxTools	\$ 65
DynaCADD	\$1099	Showmaker	\$439
excellence!	\$189	SpectraColor	\$110
Flow!	\$129	SuperBase Personal	\$ 99
Gold Disk Office	\$329	The Art Department	\$110
Imagine	\$379	Trax	\$165
Imagine Buddy	\$ 69	VistaPro	\$149
Imagine Companion	\$ 45	UltraCard	\$ 99
		Sculpt 4D	\$ 599 !
		Wordworth	\$289

C R A Z Y !

Fujitsu Hard Drive Clearance!!

Computer Discounts' Annual Clearance Sale is here again!
Quality hard drives - insane prices. Strictly limited quantities.

Conner	20 Mb	normally \$ 459	now only	\$ 249 !!
Fujitsu	45 Mb	normally \$ 599	now only	\$ 349 !!
Fujitsu	90 Mb	normally \$ 899	now only	\$ 549 !!
Fujitsu	136 Mb	normally \$1199	now only	\$ 749 !!
Fujitsu	182 Mb	normally \$1499	now only	\$ call !!

A2000 Trumpcard controllers for *only* \$99 extra!!

A2000 Hard Drive Controllers

M.A.S.T. Flash 2000 - 8 bit Economy model	\$299
M.A.S.T. Flash 2000 - 16 bit Turbo model	\$399

Save \$50 off an 8 bit Flash, or \$75 off a 16 bit Flash —
just buy a hard drive, too!

Trumpcard SCSI controller special - only \$99 !

Hardware

M.A.S.T. Micromegs - 512k + clock	\$ 59 !
M.A.S.T. Minimegs - 2 Mb Fast RAM	\$299 !
M.A.S.T. Unidrive - external floppy, no-click	\$129 !
M.A.S.T. Enhanced Unidrive - track display, anti-virus ..	\$149 !
ASDG Dual Serial Board for A2000	\$199 !
IVS PrinterFace - extra printer port	\$ 99 !
ICD Flicker Free Video	\$549 !
PP&S DoubleTalk - AppleTalk networking	\$699 !
PP&S 68040 Accelerator for A2000	\$2995 !
PP&S 68040 Accelerator for A3000	\$2795 !
M.A.S.T. ColorBurst - 24 bit colour for all Amigas	\$1199 !
Kawai FunLab (Special Price! One only!)	\$799 !
Miracle Piano Tutoring System	Scall for best price
Prism Professional RGB Colour Splitter	\$499 !
Maestro 2400 baud modem	\$299 !
Dakota SketchMaster - graphics tablet for all Amigas	\$699 !
Low Cost NEC CDROM package	\$699 !
High Performance Toshiba CDROM package	\$1399 !
CrystalSound - Professional 8 bit sampler (New!)	\$199 !
M.A.S.T. SAM - SMPTE/MIDI interface (New!)	\$249 !

Smart Techtm Corner

The place to go for the latest in HiTech gadgets!
This month - the DynaBee - \$29-95

Come in & feel the power of this amazing gyroscopic wrist exerciser. Only the size of a tennis ball, it can improve your grip & co-ordination, and give your whole arm a real workout!

Hard Drives

Quantum 52 Mb	\$ 499	Fujitsu 330 Mb	\$1999
Quantum 105 Mb	\$ 699	Quantum 425 Mb	\$2579
Fujitsu 105 Mb	\$ 699	Fujitsu 425 Mb	\$2249
Quantum 210 Mb	\$1299	Fujitsu 520 Mb	\$2699

All drives shown are 3.5" format - external cases \$199
2 yr Warranty on Quantum, 5 yr on Fujitsu >300 Mb

SyQuest Removable Cartridge Drives

All the advantages of floppies, with the
speed and size of a hard drive.

SyQuest drive 44 Mb	internal \$ 699	external \$ 945
SyQuest drive 88 Mb	internal \$ 999	external \$1245
Cartridges (not included) 44 Mb	\$155	88 Mb \$249

SCSI AND SPECIALTY CABLES - What do you need?

Latest U.S. Amiga magazines by air!

Popular Science and Popular Electronics - order now!

Video Printer Bureau now available

High quality output of your pictures, renderings or Still Video shots
\$5 per picture, \$2 setup charge
Scanning and PostScript output also available

Top Quality Floppy Disks (Japanese media) only \$10 a box

Public Domain Disks — \$4 each.

Tired of buying US software and getting zero support? Checking the post box for updates & newsletters that never arrive?

Well, no longer! Computer Discounts introduces a brand new policy - US Direct!

We think this is a great idea - you send us the software Registration Card, with our US address on it, we pass them on to the US company, and any updates are shipped over here in bulk to be forwarded to you. Your costs are reduced, and you get all the benefits of US home support - without having to live there! Normal update fees still apply. Please call for full details.

Workbench Potpourri

A new regular look by various contributors at assorted useful Workbench and CLI tips, hints and general trivia. This month's column thanks to one Mr. K. Oss.

Memory management

Can't seem to fit enough programs in memory to make it happen? If you think they should have fit, read this and find out why they may not have!

There is a little man in there who looks after memory management and this happy chappy has a system to follow from which he will not deviate.

As an exercise, open a SHELL (or CLI) and type in and enter the command `Listdf0`: This command gives you some vital information on the size and status of files and programs on your disk in the internal drive (df0:). You'll see the directory (Dir) names with their protection status, usually `—rwed`, followed by the date and time they were last changed. There's also the program or file names followed by their size and other relevant information.

Now let's say you have a 512K machine and you multi-task two programs of 180k and 200k respectively. If you could see the menu bar at the top of the Workbench screen it would say you had about 120000 free memory give or take a little. That's $500000 - (180000 + 200000)$. Bear in mind it won't be this much because Workbench will be using some memory as well, plus any icons and/or windows you may have open on Workbench will also be chewing memory.

Now, let's try to run a program which requires 245k of memory. Yes I know! A quick look at the arithmetic above will tell anyone that this will not compute because there's only 120k of memory left. Not to worry, just close down the 180k program that's running and all will be well. We'll have $180000 + 120000 = 300k$ of free memory available and the mini memory manipulators in there will take care of that. If any of you were able to try a rough approximation of the above you will have found

that the m m m's didn't take care of it, did they? Instantly the derogatory thought flashes through the mushy grey matter... "Decrepit demi-droids, what's wrong now? The memory counter says there's enough room in there. Extract your droidal digits and do something." Uh-uh, sorry, you're asking them to byte off more than they can chew.

Why won't they run?

The problem is that they chew memory the way Nudge chews Mr. Kelly's food, in big chunks. When you began allocating your memory the happy chappy used a 180k chunk and a 200k chunk. Unfortunately a chunk is a chunk and when either or both of these lumps are spat back out they remain separate 180k and 280k chunks. If you've multi-tasked a dozen or so smaller (50 to 60k) programs, then you will fragment the RAM and all the king's horses and all the king's men cannot put memory together again. To see what you've done, type and enter avail, you'll see something like...

Type	Available	In-Use	Maximum	Largest
chip	356014	167218	523232	180000
fast	205431	311457	516888	12358
total	561445	478675	1040120	180000

If you don't have a memory expansion you won't have the centre line (the fast memory). Notice though that although you have 561445 memory available in the above example, the biggest chunk is a 180k lump of chip. So in theory, a 182k program will not LOAD unless you reboot.

NB: Sometimes data (a dictionary for instance) which will not fit into RAM will fit when it's placed in a directory! The moral of the story is to try not to fragment your memory too much when multi-tasking.

Using SAY without the CLI!

Try this with a COPY of your workbench disk or a disk with the "say" program and icon on it. Open the utilities window by double clicking on its icon. Select the "say" icon (one click), then hold down the shift key and double click another icon (any one will do). Say, that's pretty good isn't it? The results of course would be far more lucid for those of you who selected a text file icon. Something from a word processing program or notepad perhaps.

Those who have not thoroughly perused their manuals may not know that they can print their files in a similar manner. Simply select the "printfiles" icon and hold down the shift key while selecting the icon of the file one wishes to print.

Other odd copy functions

Also with a copy ... and I stress, a COPY of your Workbench disk, try this. Double click the disk icon to open the window. Now hold down the shift key and select an icon (any one will do). Continue to hold the shift key down, select the disk icon and, while still holding the shift key and left mouse button down, drag the icon down the screen a small amount (1/8 inch or 3mm will do). Presto! I hope you used a copy because although the icon is probably behind the window now, sometimes it is erased from the disk.

You can perform a similar trick with directory icons. Open the "utilities" window and select a few icons using the shift key and left mouse button. Now continue to hold the shift key down and select and move the "utilities" icon. This time the icons from the "utilities" directory may be somewhere in the root directory window or then again they may have been wiped.

Now why would anyone want to perform any of the above exercises? And for that matter what type of person would even set out to discover such trivial tricks? Who knows, you'd have to be able to fathom the unfathomable and un-scrout the inscrutable to divulge that.

I know what you could do. Type in at

the CLI:-

```
makedir df0:useless_information.
```

Now make up a text file of the above and save it to this dir. Here's something else you can add to it.

What's a Lamer

Have you ever wondered what a Lamer was? I used to. Can you even begin to conceive the exquisite agony I suffered, unable to sleep at night just wondering and worrying as to who or what a Lamer was. Why, I might even be one. Well, to save your sleep I can reveal that not only do I now know what one is, but I am one in both senses of the word.

Now I bet some of you smarties, sorry, delete that - some of you more erudite readers didn't know there were two senses of the word?

For your useless_information directory these are they:

1. One who modifies another's program/hack/file/document etc, to suit themselves, then takes all the credit for the results. Otherwise known as plagiarism.

2. And more ancient, it is the name the aborigines of North Queensland called white men when we first appeared on the scene. They spelt it Lamars, but it sounds the same. Seems it meant people from the spirit world.

Faster Fonts

FF (Fast Fonts) is found in the "c" dir and can be used to speed up the rate at which text is placed on the screen.

FF -o (that's the letter O not zero) turns it on and

FF -n Turns it off

If you're tired of the old Topaz font on your CLI or word processor etc. you can use FF to change it. The font you choose to use must be a plain eight by

eight pixel font so fancy ones like Diamond, Opal etc. won't do. There are a few fonts around which can be used though. Siesta and Clean are two that spring to mind. Boing!

Once you have them installed in your fonts directory, just type in FF clean.font or FF siesta.font (try adding this to your startup-sequence) to change to a fresher looking font. Both the above fonts are sans serif fonts, which I find are easier on the eye. You may prefer something else though so just type in ff and the name of your preferred font with the .font extension. If it's not a plain enough font you'll get a message stating "font width mismatch" and the ROM font Topaz will default. That is, nothing will crash. Little Lord Fontleroy (Lee-roy for short) will just replace whatever font was being used with the built in Topaz font and you'll just have to try again with another style.

That's it 'till next month!



"Don't Panic"

AMI-TECH

For the Latest in Amiga Technology
CALL ROB TEL: 02 523 3867

Latest Specials

68040/32meg mem ex: acc bds \$3200
\$1000 trade-in on 68030 bds \$500 on 020!!!

GVP 3 in one acc+mem+scsi controller 25mh \$1500
Syquest removable media HDS 44mb \$750
Syquest removable media HDS 88mb \$1050

ALL GVP PRODUCTS NOW AVAILABLE.. BEST PRICES ASK

ICD SCSI Controllers(the fastest of all) \$265
ICD SCSI 2080 Controllers + 8mram bds/2m \$450
The All New Flickertixer from USA \$580
A500 inboard accelerators (32bit cache) \$395
105 meg quantum \$765
210 meg quantum \$1300

ALL OTHER QUANTUM DRIVES AT SPECIAL PRICES AND WITH A FULL 2 YEAR GUARANTEE "ASK PRICES"

IDE Controllers for 500 & 2000s \$260
With 105 Quantum HD 9ms access time \$925
4 meg Ram expansions for 500 \$250
Cordless Mouses \$110
Cordless Trackballs \$130

ALL ITEMS ARE FULLY GUARANTEED

PRIMA internal hds for the 500 from \$549
upgrade your A590 52 meg scsi \$520
105 meg scsi \$765

030 accelerator boards for 500/2000 \$649
A500 external hds from \$735
ICD scsi controllers \$259
" " with 2 meg ram \$450
8 meg ram cards (with 2 megs) \$410

External 3.5" Disk Drive Slimline \$115

Call NOW! for your specific requirements

Orders can also be placed through CHEESEBURGER BBS - 02 544 1248
Kam-Ad

Great Christmas gift or stocking filler



ACAR

The Australian
Commodore
and Amiga Review

**The
Official
Adventurers
Realm
Hint Book**



Hints and Tips
for loads of
computer games
in many formats

by

Michael Spiteri

This book is for anyone who likes computer adventure games. For the beginner who doesn't know where to start, to the more experienced adventurer who is stuck in a game and needs a bit of help.

Do you want to know how to solve the toughest problems? How to score the most points? How to find the funny bits the programmers put in? Buy this book!

From most newsagents

Or from Gareth Powell Publishing (02) 398 5111
21 Darley Rd, Randwick, NSW 2031

RRP
\$9.00

ICD

- AdSpeed** - 16Mhz 68000 accelerator for any model *Amiga*. Speed up screen refreshes 2x-4x. - **\$399.00**
- Flicker Free Video** - Eliminates flicker on any *Amiga* without using video slot. Needs multisync or VGA monitor - **\$579.00**
- AdSCSI 2080** - SCSI controller with space for 8Meg fast RAM. - **\$399.00**
- AdSCSI 2000** - SCSI cont only - **\$329.00**
- AdRAM 540** - Add up to 4 Megs of memory to your A500. Memory added in 512K increments OK - **\$199.00**

Video Digitiser & Colour Splitter

Digitise straight from a colour camera or paused VCR with no need for filter wheels

Outstanding quality and convenience

Complete with Custom Software

Compatible with A3000, System 2.0 and Digiview software

\$499.00

2Mb Chip RAM for A500

This kit brings the A500 up to A3000 standards with 2Mb of chip RAM.

Installation requires the A500 to be opened up. Kit uses and includes 4 of 1Mb x 4 DRAM (DIP).

Not suitable for beginners

- Kit with Agnus** **\$399.00**
Kit without Agnus **\$320.00**



Phoenix
Microtechnologies Pty Ltd
The
AMIGA
Specialists

Phoenix Board

Replacement Motherboard -*AMIGA 1000*

Now shipping from stock

Complete with - Obese (1Mb) Agnus, 2Megs RAM (1Mb Chip) on motherboard, 68881/2 Socket, Drive Swap Switch, Sockets for 4 K/starts (1.3 ROM supplied) with 2 way switch, SCSI controller on main board, A2000 Expansion Slot & Video Slot, Connector for 8Mb Daughterboard, Battery Backed Clock. - **\$945.00**

- 2Mb chip RAM option** - **\$250.00**
2Mb chip RAM Kit (for those who already have a board) - **\$399.00**

Internal Hard Drives - These are Quantum SCSI Hard Drives that fits inside your original *AMIGA 1000* case. 52Meg - **\$595.00**
These prices include a mounting kit 105Meg - **\$895.00**

- Installation** Phoenix Board - **\$70.00**
Hard Drive from - **\$40.00**

- Accessories** SCSI Extension Cable - **\$30.00**

DynaCADD

Fast 2D & True 3D Design & Drafting software for Electrical, Mechanical, Architectural & Civil applications.

Version 2.0

- Retail Price** - **\$1049.00**
Educational Price - **\$699.00**

4 Disk Demo Version - \$20.00
refundable upon purchase of package

8Meg Boards for A1000's

- OK - unpopulated **\$349.00**
1Meg populated **\$419.00**
2Meg populated **\$499.00**

Kickstart Swap Board **\$50.00**
3 ROM Sockets + Ribbon Cable

Video Breakout Box - Scart **\$75.00**
SVHS and RCA inputs and outputs
Connect equipment with any type of connector

Audio Digitisers - Mono **\$50.00**

Analogue Joystick Adapters **\$30.00**
Use any analogue joystick with the latest flight simulators

Screen Filters **\$25.00**
Reduces Interlace flicker

3.5" Floppy Drives
A500 **\$179.00**
A2000/3000 **\$159.00**
A1000 **\$189.00**
Post and Packaging **\$10.00**

Parallel Port IO Boards **\$160.00**

Phoenix Microtechnologies Pty Ltd, 18 Hampton Road, Keswick, South Australia 5035
Phone (08) 293 8752 Fax (08) 293 8814 Hours - Mon-Fri 8:45 - 6.00 Sat 10:00 - 1:00

**KEEP YOUR AMIGA
100% AMIGA
WITH GENUINE AMIGA
ADD ON'S FROM
COMMODORE. ONLY
GENUINE COMMODORE
ACCESSORIES GUARANTEE
FULL COMPATIBILITY
FULL CONNECTIVITY AND
FULL RELIABILITY 100%
OF THE TIME! FOR
- 100% PEACE OF MIND! -**

Commodore
AMIGA

100% AMIGA!

A500 Accessories

- * A501 RAM expands A500 to 1Mb with battery backed up Clock and Calendar
- * A590 20Mb Hard Disk with room for 2Mb RAM
- * 1011 Slimline Disk Drive, also for A2000/3000
- * Alter Image Genlock and Software for Video
- * Alter Audio Midi and Software for Music
- * MPS 1230 Printer, also for A2000/3000
- * 1084S Monitor with stereo sound, video and S-VHS Input, also suits A2000/3000 (and your VCR!)

A2000/3000 Accessories

- * Multisync Monitor
- * A2301 Internal Genlock
- * Accelerator Cards, 68030 with RAM
- * Pc XT/AT Emulators
- * Display Enhancer Card for A2000 + Multisync
- * SCSI Controller and Hard Disk for A2000
- * Ram Cards expands up to 9Mb

**WE HAVE YOUR NEEDS COVERED WITH
GENUINE COMMODORE ADD ON'S**

See your Commodore
dealer for all you
need and all you
need to know.

Commodore
AMIGA

For Beginners Andy's Attic

After sixteen installments of his popular CLI tutorial, Andrew Leniart is fresh out of CLI tips. So now we've expanded the brief and renamed the column to include hints, tips and general information all types. Over to you, Andrew!

In the last issue (in my last CLI column), I said that we would be looking into other public domain utilities which make things easier for the new Amiga user. This issue I intend to follow through.

IT'S HERE !!

Audio Engineer



Professional quality Amiga sound sampling and editing
Now with:

- ✓ 4 TIMES OVERSAMPLING
- ✓ TIME COMPRESSION/EXPANSION
- ✓ DIGITAL FILTERING
- ✓ PROGRESS METERS
- ✓ REAL TIME ZOOM/TELEPHOTO
- ✓ AUDIO DJ PROGRAM

Plus more..

MORE FEATURES MORE POWER

GSOFT Pty Ltd
PO Box 59
Elizabeth SA 5114
Ph & Fax (08) 254 2261
ACN 007 060 728



Dealer
Enquiries Welcome



You will see this column expand in the future to include not just hints and tips for the CLI, but also to cater for the average Amiga user who uses the Workbench and utilities associated with it.

Topics like viruses will be covered in future issues in an easy to understand fashion, along with most other aspects of the Amiga as well. Write in and let us know what you would like to read about. Remember, this column is written with you in mind!

Directory Utilities - what are they?

How many times have you read an article which recommends that you use a directory utility to perform functions such as multiple deleting of files or similar because they save a lot of key fingering? Now while the statement may or may not be true, for the very beginner to computers the statement may serve to confuse, as it assumes that you know what a directory utility is and how to use it! If you don't, then read on and you may find yourself enlightened.

In simple terms, a Directory Utility ("Dir Util" from here on) is a tool which provides an easier way to use commands normally only available to you from the CLI (Command line interface). For example, if you wanted to see what commands the "C" directory of your workbench disk has, you would first need to open up a CLI and physically type in "dir c". Using a directory utility allows you to perform the same function, except that you use the more familiar mouse technique of 'point and click' to obtain the desired result. So in essence, a Dir Util is a Workbench alternative to the CLI!

Some people believe that Dir Utils are a pain in the proverbial and won't use them because they claim they are too restrictive, others swear by them and will open a CLI only as a last resort, so the only way to find out if they are for you is to try a couple.

These days, most Dir Utils go a lot further than just allowing you to utilize CLI commands from Workbench. Most have options which allow you to view IFF picture files, create slideshows with those files, play sound files and so on and some can even be configured by the user to perform tasks often needed.

So how do you decide which Dir Util is for you? Well, as you become more experienced with the Amiga, you will know what your particular needs are, hence will be able to make a decision based on those needs and from reviews.

A look at SID

For now though, I can personally recommend SID (a shareware product by Tim Martin) as I have found it very simple to use and highly reliable in the sense that there is not much that can go wrong when using it. The latest version of SID available that I know of is V1.06. Version 2.0 of SID was supposed to be released many moons ago, but after registering the product with the author and being told about a year ago that it was to be released in a month's time, I am still waiting. That is another story though, so getting back to the

Computa Magic Pty Ltd

44 Pascoe Vale Road
Moonee Ponds 3039
(03) 326 0133

MVB Computer Supplies

506 Dorset Road
Croydon 3136
(03) 725 6255

Amiga Specialists

Golden Image Products

Hand Scanner with Touchup **\$389.00** Optical Mouse **\$99.00**
Opto Mechanical Mouse **\$49.95**
Option of D Paint II with above for \$20.00

***Amiga 500 and 2000 Special Packages
for Christmas, ring for prices.***

AX Ram 2 Mb ram card for A500

Australian Made

0k \$139.00, 512k \$189.00, 1 Mb \$229.00, 2 Mb \$299.00

A full range of Amiga software is Available at Reasonable prices.
Our Software all comes from Australian Distributors, and has
Full Australian warranty.

The owners and Staff of Computa Magic and MVB
Computer Supplies would like to take this opportunity
to thank their customers and suppliers for their support
in 1991, and to wish them all



***A Merry Christmas
&
A Happy & Prosperous 1992***



topic on hand.

SID may be started by running it from the CLI, or by double clicking its icon from Workbench. When you open up SID from Workbench, you get a screen divided into two halves vertically. This is where your directory listings are going to appear.

Down the bottom are little rectangular buttons (or gadgets as they are often called) with which you get to select the drive that the disk is in which you want to work with. Try this little example ...

Put a disk in DF0: and then click on the Button named DF0 with your left mouse button. You should end up with a directory listing of what is in the top root directory of that disk. Notice that files appear in white, while directories are red or orange depending on how you have your preferences set for Workbench colours. Change directories by double clicking on them and you can work your way around the disk in an easy and no fuss fashion.

But so much for looking around a disk. What else can we use SID for? Nearly everything that you would normally use the CLI to do. This is a great boon to people with only one drive, as the need for the Workbench disk to be inserted each time you try to use a command is no longer required. Nor is there any need to create a RAM disk if you wished to accomplish the same in the CLI.

If for instance you wanted to look through one of the earlier FISH disks which did not support icons, you would first need to set up a "c" directory in ram: as explained in earlier tutorials and use it to view the disks. SID or any Dir Util allows you to do this much more easily, takes lots less time and more times than not, is a lot less memory hungry than a RAM disk set up to give the same amount of flexibility with a single drive.

Running a program is a simple task of selecting the program on SID's window with a click of the left mouse button and then a click on the RUN gadget will usually get it going without much fuss. Reading document files is also a breeze with the "read" option, as is renaming them or moving them around from one directory to another.

Deleting files and / or whole directories no longer means typing in file names one after the other and can be done with a couple of clicks of the mouse button. If you have a disk with a lot of IFF picture files, then you can click on the "Slide" option and then select the files and click on "Show" and the pictures will be displayed in a slide show fashion one after the other.

I could go on for pages about the various uses of a Dir Util, like the ability to archive and unarchive files downloaded from bulletin boards with amazing ease, but I think that you should have a fair idea now as to what you can do with them.

An important thing to note with SID is that it is to a large extent a configurable Dir Util. This means that you can change it around to suit yourself. The way you do this is with a file SID uses called SID.config which you place in your boot disk's "s" directory. This ultimately means that it requires support programs to be able to use some of the functions that are not hard coded into it. Great thing about this though is that all of the support programs you will ever need are either PD or shareware!

Space does not permit a full explanation of how to set up this config file, so spending the time to read the documents that come with this product is essential to be able to take the full benefit of it. The docs are pretty much easy to follow, but if you find you have problems, feel free to write in to me at:

P.O. Box 1335

Hoppers Crossing Vic 3030

and I'll endeavor to try and help you out through these pages.

Other DIR Utils

As I mentioned earlier, choosing a directory utility is very much a matter of personal taste and requirement. There are many different types available in the public domain libraries. Some are Freeware, others like SID are released under the shareware concept and of course you have your choice of commercial efforts as well. Here is a brief rundown on some of the more popular ones:

DISKMASTER - A commercial

product that works in much the same way that SID does. Easy to use and quite attractive and configurable. However, in my humble opinion, the price that is asked for this product does not justify when compared to SID.

DIRECTORY OPUS - Another commercial effort by a local Aussie programmer Nic Wilson, this would have to be one of the best efforts and value for money in the commercial circles. Some of the earlier versions had a few problems, but I recently saw one of the more recent versions and it was quite impressive. See the review by Andrew Farrell on this directory utility and others a few issues back.

DIRWORK - A shareware effort by Chris Haymes, another local Aussie programmer, would have to qualify as one of the easiest Dir Utils to use that I have personally seen. While not as powerful as some of the others mentioned here, it caters for most functions you would need and has the advantage of not having to do a lot of setting up before you use it. Just plug it in and away you go so to speak.

A final word

You can obtain public domain directory utilities from companies such as Megadisc and Prime Artifax. Commercial programs like *Directory Opus* or *DiskMaster* should be available from your local dealer.

Well, so endeth the tale of Directory Utilities. I hope that this has helped some of you understand what these utilities are all about. Contrary to popular belief, they are not only of use to those that are lucky enough to own hard drives. They are also very useful as a floppy drive work horse as well. Remember, the best way to learn more about anything is to begin playing with it. So now it's up to you.

Ending random A500 resets

Hands up all those owners of an Amiga 500 that have had their machine suddenly reset on them for no apparent reason. You can be working away or

AMIGA OPTIONS

Two great add-on packs for your Amiga 500 that
unleash your creative genius

**Your very own
Home Video Studio
with ALTERIMAGE
NOW: \$599.00 RRP**



Titles, special effects . . . Add that professional touch to your home movies. With AlterImage, your camcorder, VCR and Amiga*, you have all that is needed to transform your movies into interesting viewing. Using AlterImage is a snack! - a VHS video tutorial is included with software, genlock and cables. Truly the perfect companion to your video and camcorder.

*Note: 1Mb RAM required.

Available from your favourite Commodore dealer and most major retail outlets throughout Australia.

**Your very own
Home Audio Studio
with ALTERAUDIO
NOW: \$249.00 RRP**



Do you play in a band with MIDI instruments? If so, this pack is the ideal companion and the tool to really bring out your creative music genius. If you don't play in a band this could well be the start! With AlterAudio, your Amiga* takes over your instruments. Compose, sequence and add special effects to music. All you need, software, MIDI adaptor, and audio cassette tutorial are in the box ready to go!

Commodore
AMIGA

Express PD

Amiga Public Domain Service

MSO Box 6000, Townsville, QLD. 4810
Tel (077) 71 4388

The 45 for 25 Games Pack

A great Christmas present containing 45 of the latest PD games for an incredible price of \$25. Best Value.

Sound Tracker Module Disks

These are disks full of the hottest music for the Amiga. Each disk is full and contains six or more modules. For those new to Sound Tracker there is a special pack containing ST module player utilities and 5 Disks of over Forty modules. 6 disks in all for only \$20. Excellent Value !!

There are Module Packs of 10 disks (\$37)
20 disks (\$70) and 50 disks (\$150) available.

Imagine Companion Pack

This is a companion pack to the hot, new 3D Modelling/Animation program - Imagine. This package contains 8 disks full of Objects, Brushmaps, Utilities, Tutorials, Hints & Tips, Q & A's and Rendered Examples. This pack is exclusively available from Express PD for \$50.

Aquarium Disk

The Database used for searching the Fred Fish disk listing. Now on one disk upto 540. Only \$5.

**Fred Fish now up to 570!
Only \$3 Each !!**

Games Pack	\$ 25	<input type="checkbox"/>
ST Player / Modules - 6 Disk Pack	\$ 20	<input type="checkbox"/>
10 Disk Module Pack	\$ 37	<input type="checkbox"/>
20 Disk Module Pack	\$ 70	<input type="checkbox"/>
50 Disk Module Pack	\$150	<input type="checkbox"/>
Imagine / Turbo Silver Companion Pack	\$ 50	<input type="checkbox"/>
Aquarium Disk	\$ 5	<input type="checkbox"/>
Catalogue Disk	SPECIAL OFFER FREE	<input type="checkbox"/>
I enclose Cheque/Money Order for \$ _____		

Or Charge my: Bankcard Visa Mastercard

Card No. _____

Exp Date _____ Signature _____

Name _____

Address _____

Suburb _____ Postcode _____

playing your favourite game when all of a sudden, the machine begins to reboot. No guru, no nothing, just a reset! I would be willing to bet that there are more than two or three hands showing out there. Let's see if we can't try and throw some pointers which might help you track down the problem.

I had this exact same problem for ages. Having the machine looked at by a local computer technician provided no joy as he told me that he could not fault the machine. He told me too he had re-seated the Agnes chip as they do tend to work their way loose occasionally, but it seemed okay and worked fine on his test bench.

Having taken the machine home and plugged it in, I used it for an hour and sure enough, bang, the screen goes white, disk drive starts spinning and my Amiga begins to reload as if I had just pressed Ctrl-Amiga-Amiga. A quick phone call to my local techie resulted in him offering to sell me his test bench which my Amiga worked fine on. So what to do?

Well, it appears that there are two main causes for the Amiga 500 to behave in this way. Here are a couple of tips which may help you sort it out.

NOTE: The following will void the warranty on your machine, so if it is still in warranty, take it back to where you purchased it. Also, it is not recommended that you try this yourself unless you have some technical hardware experience. To avoid possible damage to your Amiga, it is advisable to seek assistance of a qualified computer technician.

Keeping the above in mind, if you are still determined like I was to try these tips yourself, here's a quick run down on what to try.

One of the problems may be in fact that one or more of the chips inside the Amiga can actually work their way loose. The simple remedy to this is to open up the Amiga (making SURE you have the power plug removed from the socket for safety reasons) and then uncover the machine's mother board by carefully removing the metal shield. You will need a special screwdriver to undo the screws on the bottom of the Amiga, but I found a small allen key did the trick for me.

Look around and locate all the main large chips. They should have names on them, like Agnes (who incidentally seems to be the main suspect of this problem). Having located the chips, gently press down on all four corners of them taking note if they actually move when you press on them. Once done, carefully put the Amiga back together and see if the problem recurs. If, as with mine, the problem still persists, then there is a good chance that you have a faulty power supply. Attempting to repair a faulty power supply yourself is definitely NOT recommended. Although I occasionally dabble in a bit of hardware hacking myself, I did not try to fix my own power supply but took it to a qualified electrical technician instead. It's just too risky.

Anyway, what the problem turned out to be on my machine's power supply was that the solder points had dried out. My local techie just disconnected all the wires by melting the old solder and re-soldered them again.

This seems to be quite a common problem with Commodore's older brick power supplies, though I am told it does not occur with the newer ones as often. My machine was just over

Over 20,000 PD Titles

More than 30 Different Libraries Incorporated in the
Biggest and Best Public Domain Collection in Australia

Software Imported & Downloaded Via Modem from all over the world!

Check out a REAL library !!

GAMES, PICTURE DISKS, EDUCATION, MUSIC UTILITIES, DEMOS,
ADULT SOFTWARE, ANIMATIONS, FONTS, CLIPART, GRAPHICS UTILITIES,
VIDEO UTILITIES, TUTORIALS, COPIERS, VIRUS KILLERS and Hundreds more.

If you want it, Call, we've got it!

\$1.00 - \$5.00 Per Disk

(Including Guaranteed Disk)



XMAS PACKS

\$25



Xmas Carols, Xmas Pictures, Xmas Colouring Book on Disk, Plus:

Pack I Games!

Over 20 Hot Games like:

Return to Earth -Elite style
Space trading game
Robocop V's Iraq -'Your move Creep!'
Simpsons - 'I'm Bart Simpson - Who
the Hell are You?'
Wizzy's Quest - Arcade/Adventure Game.
Hate - Hot Shoot-em-up. Excellent
Graphics. and Sound Fx.
LaserZone -Get the enemy in a cross
fire. Earn Extra weapons, speed...

Pack II Graphics!

For the Artist in you.

All you could want to use and
display the graphics of the
Amiga.
Image processing, Animations,
Paint program, Computer Aided
Design, Beautiful digitised
pictures (SciFi, Antartica,
Microscopic).



Pack III Music!

Make this holiday a
Memorable one.

This is a Complete Music
package for the Composer in all
of us. Create your own musical
masterpieces. The pack includes
Med V3.11, probably the best
Music Editor around.

***** Plus *****

Over 500 different instruments!

Why are We the Best??

Who else can offer a choice of over 20 000 titles?
Where else do you get immediate access to the latest releases?

We don't just compile our disks from other libraries,

We down load it, We import it.

As soon as it's released we get it!

A M I L I G H T

The Biggest PD Library in Australia :-

- SAME DAY AIR DISPATCH!
- Only high quality Guaranteed Disks used.
- All disks Guaranteed Virus Free .
- No Membership fee.
- Free Catalogue Updates.
- Credit Card Phone Orders
- 3 disk Catalogue \$4.00 plus \$1.00 p&p



Phone (09) 367 4482

Corner Tate and Angelo Streets
South Perth WA.

Postal: PO Box 233 COMO WA 6152

12 months old when I began to experience the reset problem and since having the power supply fixed, I have not experienced a single random reset. I included this information in the hope that it may help some of you people that may be at wits end trying to figure out why your Amiga is behaving in this strange fashion. Took me ages to find the solution.

Getting started with AmigaBASIC

Not all Amiga owners want to use their machine just for games. Some quite rightly purchase the machine with the intention of maybe learning to program with it. Most begin with a simple language like BASIC. There are some excellent publications on learning AmigaBASIC around and one particularly good one is *AmigaBASIC Inside and Out* published by Abacus. However while the tutorial style of this book will suit many users, it will without doubt, not be everyone's cup of tea. Certainly, the manual supplied with the Amiga for AmigaBASIC leaves a lot to be desired!

For this reason I have decided to review a book which is aimed at the ultimate beginner to Basic programming. I came across this book at a local K-Mart store and at about \$15.00, found it top value for money. Clive Prigmore's *Beginner's Basic* is the name of the publication and it is aimed at the ultimate novice to computers and assumes very little or no knowledge about computing in general by the reader of his book.

Clive begins at the very basics as can be seen by the title of the first chapter in his book, namely: "What is Computing?" The chapter explains to the user exactly what a computer is and how it works, tells the difference between software and hardware and gives examples to back up the explanations of each.

Being a ring bound book, it opens flat on a table which makes it a dream to use in this practical sense. Many topics are covered in a very easy to read style and include tutorials on things

such as REM statements, Print statements, loops etc and all tutorials are accompanied with simple diagrams to help get a point across.

Impressive to me was the way which the author gave assignments to complete at the end of each section, presenting you with a problem where you must design a simple program to solve it. Naturally, solutions to the problems are also supplied along with explanations of how you should have gone about reaching these solutions. The Index which is supplied at the end of the book helps in finding particular topics which you may want to review at any given time.

One drawback of this publication is the fact that it is not written for AmigaBASIC in particular, therefore minor modifications need to be made to listings occasionally to make a program work as the author designed it to. However, due to the nature of the very simple examples and/or explanations given, this rarely causes any problems.

My overall comment on this book is that it is a very good start to learning Basic in general and should help most beginners understand various things which may have been confusing them while trying to follow other similar publications.

There are numerous other tutorials available for BASIC, ask around at your local user group if you live near one as quite often they have members that are whizzes with this language. Megadisc, advertised in each issue of ACAR, have basic tutorials often that are quite comprehensive and easy to follow. There are PD disks with Basic tutorials on them available from PD libraries. It's all out there, you just gotta reach out and grab it by the throat!

Well, that's about it for this month. I hope you enjoyed the new style that this column has taken. CLI users can rest assured that they have not been forgotten and will continue to get a fair share of the attention of this part of our magazine. I thought it was time for a bit of a change and a fresh approach to this section and hopefully, you will agree. Please direct any feedback either to the

magazine or write direct to me at:
P.O. Box 1335
Hoppers Crossing Vic 3030
or if you have a modem...
Andy's Attic BBS!
(03) 749-4897
Open 24 Hrs a day! o

C64 SOFTWARE

EXTENSIVE RANGE OF PUBLIC DOMAIN SOFTWARE FROM UK, USA, AUSTRALIA.
EACH DISK CONTAINS MANY EXCITING PROGRAMS FOR ONLY \$5 PER DISK.

● SPECIAL ●

INTRODUCTORY OFFER
5 DISKS - \$20

+ FREE CATALOGUE
GAMES - GRAPHICS
UTILITIES - TUTORIALS
IMMEDIATE DELIVERY

PLEASE SEND 5 DISK OFFER \$20 CHQ/M.O. ENCLOSED

Please tick your preference(s):

Games Computing
 Art General

PLEASE SEND FREE CATALOGUE

Name: _____

Address: _____

PostCode: _____

Post To: BRUNSWICK PUBLICATIONS
PO BOX 458
BONDI JUNCTION NSW 2022

Memory Expansion

1MB x 1 - 80ns \$6.25 1Mb X 8 - 100Ns \$51
4 x 256 -100ns \$6.20 1Mb X 8 - 80Ns \$59
4 x 256 - 80ns \$6.25 4Mb X 9 - 80Ns \$260.
41256 -100ns \$2.10

Hard Drives

A590 Owners Attention!
Special Upgrade Offer!
105Mb Quantum Hard Drive \$630.
Fit To Your A590 And See It Fly
Other sizes please call

Nashua Diskettes

We Are Price Competitive

Sales tax + 20%. Prices subject to change without notice

QUADRANT COMPUTERS

26 Rochester Way Dianella WA 6062

PO Box 380 Morley WA 6062

Tel (09) 375-1933 Fax (09) 375-1113

Mobile Tel All Hours (018) 918 608



SigmaCom

*Amiga
Products*

GVP

*Top Performance
SCSI Hard Drive Combinations*

Series II Impact 2000 Series II Impact 500

CALL FOR BEST PRICE. WE WILL NOT BE BEATEN!
FREE DELIVERY TO ANYWHERE IN AUSTRALIA!
USER GROUP DISCOUNTS !

**A590 OWNERS ATTENTION!
SPECIAL UPGRADE OFFER!**

52 Mb Quantum \$549

105 Mb Quantum \$749

**A2000 HARD DRIVE BARGAIN!
45Mb SCSI + DATA FLYER \$499**

SUPRA IS HERE!

All have A500 bus pass-through and space for 8 Mb RAM!

SupraDrive 500XP 52 Mb Quantum \$849

SupraDrive 500XP 105 Mb Quantum \$1299

SupraRam 500RX 2Mb exp to 8 Mb \$440

Amiga 500 ECS Motherboard Upgrade \$180

Used equipment bought & sold

Amiga trade-ins welcome !

Tel. (02) 545 3383 or (018) 25 7471

The C64 Column

by Owen James

Working With Subroutines

Anyone who's done much programming on the C64 will undoubtedly have written some re-usable subroutines. You may have created a user interface that you've been particularly proud of, or a menu routine that's adaptable, or a disk management routine that can be used again and again. Re-usable subroutines make programming as easy as slotting the modules together.

This month we'll be taking a look at short, adaptable routines to add to your programming library. Even though they are designed to be sub-routines, I've started their line numbers at 10 to avoid confusion. They each contain a 'function header' similar to what you might see in C source code.

Device On-Line

This is a short routine that can be called from anywhere within your program before attempting to access a device such as the disk drive or printer. If the device is off-line, it will either ask the user to make it on-line, or cancel the request. The sub-routine returns a value of Z=1 if everything is okay, or Z=0 if the user has requested a cancel. ON-LINE CHECK expects variable D to contain the device number to check.

```
10 REM ***** FUNCTION HEADER *****
20 REM FUNCTION NAME: ON-LINE CHECK
30 REM DESCRIPTION: MAKES SURE DEVICE IS AVAILABLE
40 REM MODIFIED VARIABLES: A$, S, Z
50 REM RETURN VARIABLE VALUES: Z=0 IF DEVICE OFF-LINE
60 REM *****
70 POKE 7
```

```
80,D : POKE 144,080 SYS 65457 : S=ST
90 SYS 65454 : S=S OR ST
100 IF S=0 THEN Z=1 : GOTO 160
110 PRINT "[HOME]MAKE DEVICE ON-LINE AND PRESS C. X TO EXIT"
120 GET A$ : IF A$="" THEN 120
130 IF A$="C" THEN 70
140 IF A$="X" THEN Z=0 : GOTO 160
150 GOTO 70
160 RETURN
```

Text Slide

Here's an interesting way to present a line of text. Have your text stored in TE\$ and call this routine. It is set to slide in at the top of the screen, but with slight modification you could also pass it a vertical cursor position to use.

```
10 REM ***** FUNCTION HEADER *****
20 REM FUNCTION NAME: TEXT SLIDE
30 REM DESCRIPTION: SLIDES A LINE OF TEXT ONTO SCREEN
40 REM MODIFIED VARIABLES: I, S, TE$
50 REM RETURN VARIABLE VALUES: NIL
60 REM *****
70 TE$ = "[CSR UP]" + TE$ + " "
80 PRINT CHR$(147)
90 FOR I=20 TO 1 STEP -1 : FOR S=1 TO 35 : NEXT
100 POKE 211, I
110 PRINT TE$
120 NEXT
130 RETURN
```

Disk Error

Nothing will bring a program down faster than a disk error. The following routine is designed to be called after each and every disk operation to check that everything worked okay. If it finds a fault it will return a value of 1 in E. Your main program should then give the option of either trying again or exiting.

```
10 REM ***** FUNCTION HEADER *****
20 REM FUNCTION NAME: DOS ERROR CHECK
30 REM DESCRIPTION: CHECKS FOR ERRORS ON THE DRIVE
40 REM MODIFIED VARIABLES: NU, ME$, E
50 REM RETURN VARIABLE VALUES: E=1 IF ERROR DETECTED
60 REM *****
80 OPEN 15,8,15
90 INPUT#15, NU, ME$
100 IF NU < 1 THEN 130
```

```
110 PRINT "[HOME]DOS ERROR "NU": "ME$"
120 E=1
130 CLOSE 15 : RETURN
```

Centre Message

Another text presentation routine. This time you feed it some text in ME\$ and it will centre it on screen. Just make sure that the correct vertical cursor position is set before calling the routine.

```
10 REM ***** FUNCTION HEADER *****
20 REM FUNCTION NAME: CENTRE MESSAGE
30 REM DESCRIPTION: CENTRES TEXT ON SCREEN
40 REM MODIFIED VARIABLES: TA
50 REM RETURN VARIABLE VALUES: NIL
60 REM *****
70 TA=(40-LEN(ME$))/2
80 PRINT TAB (TA) ME$
90 RETURN
```

Exit

This one isn't exactly a sub-routine, so just GOTO it. EXIT will draw an interesting screen before resetting the C64.

```
10 REM ***** FUNCTION HEADER *****
20 REM FUNCTION NAME: EXIT
30 REM DESCRIPTION: DRAWS A CLOSING SCREEN AND RESETS 64
40 REM MODIFIED VARIABLES: J
50 REM RETURN VARIABLE VALUES: N/A
60 REM *****
70 POKE 53280,6 : POKE 53281,14 : POKE 646,6
80 PRINT CHR$(147)
90 FOR J = 2024 TO 1024 STEP -6
100 POKE J, 224 : NEXT
110 SYS 64738
```

Wait For Disk

This is a great little routine that automatically senses when a disk has been inserted in the specified drive.

No need for a "Insert disk and press a key" message. It will expect variable D to contain the device number of the drive to check.

```
10 REM ***** FUNCTION HEADER *****
20 REM FUNCTION NAME: WAIT FOR DISK
30 REM DESCRIPTION: WAITS FOR THE INSERTION OF A DISK
```

```

40 REM MODIFIED VARIABLES: A$
50 REM RETURN VARIABLE VALUES: NIL
60 REM *****
70 OPEN 15,D,15
80 PRINT#15,"M-R"; CHR$(30); CHR$(0)
90 GET#15,A$
100 IF ASC(A$+CHR$(0)) THEN 80
110 CLOSE 15
120 RETURN

```

Check WP Status

Here's a handy routine which will check if a disk is write-protected. GOSUB it before trying to write to the drive to avoid problems. The routine will expect D to contain the device number of the drive to check.

```

10 REM ***** FUNCTION HEADER *****
20 REM FUNCTION NAME: CHECK WP
30 REM DESCRIPTION: CHECKS THE WP STATUS OF A DISK

```

```

40 REM MODIFIED VARIABLES: W, A$
50 REM RETURN VARIABLE VALUES: W=1 IF DISK PROTECTED
60 REM *****
70 OPEN 15,D,15
80 PRINT#15,"M-R"; CHR$(30); CHR$(0)
90 GET#15,A$
100 CLOSE 15
110 IF ASC(A$+CHR$(1))=1 THEN W=1:GOTO 130
120 W=0
130 RETURN

```

Mail

A. Hay, of Lesmurdie WA, writes: "Dear OJ, I have been a reader of ACAR since Vol 1, 1984. I use CPM and am a FOG member (USA). I work with DBase, Wordstar and SuperCalc. I can convert to/from Superbase/SuperScript files into DBase/Wordstar.

"ACAR gave some coverage of CPM years ago. People do not know how

easy CPM is to use and how for only a few dollars (\$5.00 per disk) you can get heaps of useful programs. How about some more on the C128 and CPM?"

Yes, you're right. People don't know enough about CPM. Unfortunately, I don't own a C128 myself (anyone got a spare they'd like to donate?), so I'm not much help. If people have some useful information for us then I'd be quite happy to include it.

Neil Sanders, of Hurstbridge VIC, writes:

"Dear Owen, First I would like to congratulate you on an excellent column. I must admit it is the main reason we buy ACAR these days. I realize that most of the enthusiasts have switched to the Amiga, and articles may be hard to come by, but surely, more software reviews, or at least a more accurate

ANNOUNCING A NEW FORCE IN AMIGA & C64 COMPUTING

DELUXE PAINT IV
\$179

TASMANIA'S  PROFESSIONALS
Commodore

EXTENSIVE RANGE OF G.V.P. PRODUCTS

Offer you the chance to

WIN A CITIZEN 200GX COLOUR PRINTER VALUED AT \$495 WITH ANY PURCHASE OVER \$500

*Competition Closes Dec 31st & Drawn Jan 4th

CDTV
INTERACTIVE MULTIMEDIA
from Commodore

NORMALLY \$1595
OUR PRICE

\$1495

SPECIAL

Includes Simcity & World Vista Atlas

FREE ONE EXTRA CDTV TITLE OF YOUR CHOICE TO VALUE OF \$80

*Offer valid till Dec 24th 1991

CHECK OUT THESE CHRISTMAS SPECIALS

SUPER CHIP SPECIALS

SUPER DENISE
\$3995

V2.0 KICKSTART ROMS
\$9995

V1.3 KICKSTART ROMS
\$2995

8520 CHIP
\$1295

CALL TODAY ABOUT OUR EXTENSIVE RANGE OF BOOKS, IMPORT & LOCAL MAGAZINES, SOFTWARE, HARDWARE AND ACCESSORIES

PANDAAL 400 DPI AMIGA HAND SCANNER
\$459

IF WE DON'T CARRY IT...

...WE CAN ORDER IT



99 CHARLES ST
MOONAH TAS 7009

PH (002) 730 606
FAX (002) 732 910

PHONE AND MAIL ORDERS VERY WELCOME
ALL MAJOR CREDIT CARDS ACCEPTED.
GIVE TASMANIA A TRY!

Trading Hours
Mon-Thur 9am-6pm
Fri 9am-7pm
Sat 10am-2pm

We are an Authorised Education and CDTV dealer
SCHOOL ENQUIRIES WELCOME

indication as to which games are also available in C64 format would not be too hard.

"Several overseas mags still find enough software to devote themselves entirely to C64 game reviews, with the U.K. mag "ZAP 64/AMIGA" recently dropping Amiga and becoming "ZAP 64". They obviously feel that there will be continuing software support for quite some time yet.

I realize that this has nothing to do with your column, but I thought I would take the opportunity to air my feelings on the subject."

Thanks for your comments. More software reviews would be great, but unfortunately there just isn't much in the way of new software being released. I'm happy to review anything that comes my way.

Glenn Jones, of Buderim QLD, has some useful information for us this month. Over to you, Glenn...

"I read the article in Vol8 No9 on Word Writer 6 and also in The Sunday Mail in the computer section on 18/8/91, and now I am getting it in late November, but where can I buy it? Neither article has mentioned that. In the article in The Sunday Mail it described the C64 as "The Computer That Won't Die".

"Before buying my MPS 1230, I had an MCS810. After nine months of continually taking the printer back because its head kept failing, K-Mart was nice enough to let me return it without any fuss. Also (no I'm not a huge fan of K-mart!) you can buy 50 5.25 inch disks for only \$24.95. Not bad for those shopping on a budget.

"Are there any decent bulletin boards in the Brisbane area? I have been thinking about setting one up myself, but without a hard drive the C64 is pretty limited by its lack of memory. My only alternative is to hook up other computers. I can lay my hands on a few Vics and maybe 2 or more 64s, but without information on how to do it I can't. Could anyone who's done it please write to me?

"Does anyone know of a fighter simulator better than F-14 Tomcat that allows you to play with a friend in a

different plane at the same time, and if there isn't I hope the software companies seriously think of this as an option for a new game.

"For those who are interested in tinkering with their user port and electronics, I have a simple little project below. It is a very simple program which controls a radio that you hook up to the user port.

"One thing to note is NEVER let the wires that you hook up touch each other directly or the inside of your computer. It could be fatal.

"In about a month I will start to learn all about solid state relays and I will keep writing in with different things to do, hopefully things like turning on lights and other such projects.

"Things you will need:

"1 Radio (2 1.5V batteries only),
"2 wires.

"Open your radio and remove the batteries, then connect wire on to the black (negative) terminal (you may just have to attach it to where the battery would normally touch the connection). Wire 1 is then connected to Pin 1 on the user port (see Figure 1). Then connect wire 2 to the red (positive) terminal on the radio to Pin 3 on the user port. Type in the program below and you will be able to turn your radio on and off from the computer. This strains your radio because it feeds it with 5V instead of 3V. A simple resistor (possibly 165 ohms) could relieve this. "At the moment it draws power from the C64. In a few weeks we'll look at using solid state relays to turn things on using their own power."

```
5 REM PIN 1 AND 3
6 POKE 56579,255 : REM
  INITIALIZE USER PORT
7 PRINT"[CLR]" : GOTO 100
9 REM ***TURN ON RADIO ***
10 POKE 56577,1 : RETURN
20 REM *** TURN OFF RADIO
  ***
30 POKE 56577,0 : RETURN
60 REM *** CONTROL
  PROGRAM ***
100 PRINT"*** RADIO CONTROL
  PROGRAM ***"
110 PRINT" WRITTEN BY GLENN
  JONES"
120 PRINT" 1) TO TURN RADIO
```

```
ON"
130 PRINT" 2) TO TURN RADIO
  OFF"
140 GET A$ : IF A$ = "" THEN 140
150 IF A$="1" THEN GOSUB 9
160 IF A$="2" THEN GOSUB 20
170 GOTO 100
```

Figure 1 - USER PORT

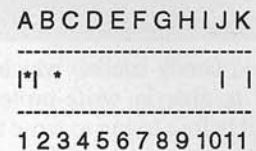

A1....NEGATIVE CONNECTION
C3....POSITIVE CONNECTION

Thanks for all the info, Glenn. Ask your local retailer if he can get *Word Writer 6* in for you. If you have no luck, try contacting the Australian distributors (Dataflow (02) 331 6153).

The Sunday Mail was right in describing the C64 as "The Computer that Won't Die". I seem to remember Phil Campbell making a prediction in the *Sydney Morning Herald* early this year that the C64 wouldn't see the year out. Here we are in December and the C64's still going strong. In fact, C64 sales actually improved by 30 percent. I think the only thing that's died this year is Phil's crystal ball!

I still get the odd letter about the MCS 810s and all of their problems. My second print-head has just died this week, less than twelve months after it was replaced. Will I bother to replace it yet again? I doubt it. With the money I've spend on it over the past 18 months I probably could have bought a printer that actually works how it should. Anyone want to buy a slightly used MCS 820?

That just about wraps up The C64 Column for another month. Keep those letters and disks coming in to me care of: The ACAR,
PO Box 288,
Gladesville 2111.

Merry Christmas to everyone, and may you all awake to find a Turbo Master CPU in your stocking on Christmas Morn. Catch you next year!

Contributors Wanted

Although we have a solid core of regular contributors, we always welcome new authors to our ranks.

We prefer to receive "how-to" type articles, comparisons or "getting the most out of ..." tutorials. If you have an idea you would like to discuss, telephone our editorial office on (02) 879 7455. We can arrange to have an expanded contributor guide posted to you containing all the information you'll need to know.

In brief, we can accept material via modem, in fact, this is the preferred method. You can also send in a disk containing a clean ASCII text file - that is, one without any special formatting. Pictures, screen-grabs or illustrations should be included separately and clearly labelled. The most important thing to include is your daytime phone number.

The sheer volume of letters which pass through our office make it impossible to respond in writing. Normally, we will contact you by telephone if your contribution is accepted. Like most magazines, we cannot promise to return your original materials.

If you're not sure of the style of writing, try reading articles by other regular contributors and adopt a similar approach. This normally involves small doses of humour, plenty of easy to follow explanations and a clear view that most people are only beginners. Our editorial office can be contacted on (02) 879 7455 or Fax (02) 816 4714.

M U

ECHNOLOGY

SCRAM 2000

• HI PERFORMANCE 16 Bit
NCR 53C94 Controller

SCRAM 500 **CD ROM**
Compatible

- AutoConfigure
- 8 Meg Fast RAM
- AutoBoot ROM
- 500KB/S SCSI Port
- 45mm Slimline footprint
- AutoBoot Disable switch

- 1.5 MB/Sec Transfer*
- HardCard Mounting

Rigid Disk Block + Syquest Support

0 Meg	\$299.00	<input type="checkbox"/>	
2 Meg	\$499.00	<input type="checkbox"/>	
4 Meg	\$659.00	<input type="checkbox"/>	
8 Meg	\$999.00	<input type="checkbox"/>	

* 16 Bit SuperSCRAM Option
ADD \$149.00 installed
ADD \$199.00 for kit

ZIP DRAM Memory upgrades for SCRAM 500/2000:
1Meg ZIP DRAM \$80 per 1Meg / 4Meg ZIP DRAM \$90 per 1Meg

Name:

Address

Telephone:

I enclose cheque for \$..... (incl. \$12 delivery).

Charge my Visa Mastercard Bankcard

Card No. Exp. Date

Signature: Date:

Send/Fax to MegaMicro Technology P/L
PO Box 511, Bondi Junction, NSW 2022 Phone/Fax: (02) 363 1246

ACL

A.C.N. 000 292 320

ICD Inc.
&
Golden Image
Products

Customer Service
1162 Hay St, West Perth, WA 6005
Tel (09) 481 0555 FAX (09) 426 1444
01 NOVEMBER 1991

Australian Distributor for
POWER COMPUTING (UK)

SALE!
SALE!

AMIGA

Amiga Anti Click Power Drive	\$181
Dual Floppy Drive	\$293
Golden Image Mouse	\$55
Golden Image Trackball	\$98
Blitz Amiga Copier	\$71
Amiga 500 Internal FDD	\$131
Anti-Click Board	\$47
Midi Interface	\$54
AT Once IBM Emulator	\$445
Golden Image Optical Mouse	\$98
Golden Image HandScanner	\$389
Flicker Free Video	\$555
A500 Internal 20Mb HDD	\$732
A500 Internal 40Mb HDD	\$867
A500 Internal 60Mb HDD	\$1,107
A500 Internal 80Mb HDD	\$1299
ICD Adspeed Amiga	\$393
Prima 52Mb Internal	\$673
Prima 105Mb Internal	\$966
Shuffle Board	\$55
ICD Adspeed	\$393
Slimline 40Mb Hard Disk	\$712
Slimline 45Mb Hard Disk	\$764
Slimline 52Mb Hard Drive	\$787
Slimline 105Mb Hard Drive	\$1,079
AdRam 505 (0-512k)0k	\$51
AdRam 540 (0-4Mb) 0k	\$186
AdRam 560D (2Mb)	\$326
AdRam 2080 (0-8Mb) 0k	\$214
AdSCSI 2000	\$216
AdSCSI 2080 (0-8Mb) 0k	\$323

Orders Only: 008 099 185

PAYMENT TERMS - CHEQUE: Please make cheques payable to ACL and send them to the address above. Please allow 7 days delivery on mail orders. CREDIT CARD: We accept Bankcard & Visa Credit Cards. To place your order please Telephone (09) 481 0555 or 008 09 9185. Where possible subject to stock being available, all items will be delivered overnight at the appropriate freight charges. Above prices do not include Freight and installation & prices are subject to change without notification.

The GEOS Column

by Owen James

New GEOS titles

In the *geoNews* this month are three new GEOS titles from NewSpeak Software.

First up is *geoTheo*, a thesaurus with over 10,000 cross references. *GeoTheo* is a desk accessory, making it accessible from any GEOS application. Cut, paste and search options are provided. *GeoTheo* sells for just \$US14.95.

Graphics Importer is another new GEOS title. This one allows graphics from all kinds of different formats to be converted to *geoPaint* files. I seem to remember a shareware program being available that does the same thing.

Anyway, *Graphics Importer* sells for \$US19.95.

InPrint is a large selection of enhanced printer drivers for GEOS. These new drivers offer variable print densities, double-strike print and even interpolation options (interpolation drivers offer a laser-like appearance to your dot matrix printouts.). Another cheap one at just \$US9.95.

NewSpeak Software can be contacted at Box 708, Draper, UT 84020.

Desktop Publishing

Over the coming months we'll be taking an in-depth look at Desktop Publishing with GEOS. I'll try to cover everything from design and layout, to getting the most from *geoPublish*. First up, a look at what desktop publishing actually is.

Before computers, if you wanted to produce a newsletter, book or manual you were forced to rely on a variety of different people to complete the various stages of production. You might begin with the text of the document. This would then need to go through an editing process, the layout would have to be designed, and some graphic artists might be called in to create some artwork to accompany the document. All text would have to be retyped into a typesetting

machine before the document could go to the printers. All up, this could be a time consuming exercise and quite probably beyond the budgets of most.

Desktop Publishing puts you in control of almost every aspect. Using the computer, you create and edit the documents, produce the graphics, and even design the layout. Getting professional looking output is then just a case of sending your files to a printing bureau.

So how does a desktop published document compare with a traditionally produced document? Very well indeed. Basically, though, the quality of the output depends on the experience and creativeness of the user. Expensive equipment won't compensate for a lack of creativity. I've seen documents produced using nothing more than *geoPublish* on a C64 that look every bit as good as the ones produced using a \$5000 Macintosh, or magazines produced on an Amiga that would well and truly rival any traditionally produced publication. *Professional Amiga User* and *.info* magazines are testimony to this.

Desktop publishing isn't restricted to laying out simple pages of text. Advertisements, flyers and perhaps even graphic composition can all be a part of desktop publishing. Of course your style of layout would have to vary depending on the type of document. An advertisement, for example, would have to really catch the reader's attention and stand out from a page full of text, while a magazine article would have to avoid looking too busy so that it doesn't confuse the reader.

And now some general desktop publishing tips which we will be putting into practice using *geoPublish* over the coming months.

Most computer publishing programs offer an incredible amount of options for laying out text. Curved text, gradient fills, shadow and outlined text, and a vast amount of fonts. There is, how-

ever, a danger in having all of these features available, and that is the temptation to use them all in the one document.

I've seen newsletters that use a large range of fonts doing all kinds of weird and wonderful contortions around multi-coloured graphics. Needless to say the result is a cluttered and illogical page that resembles more of an advertisement for the desktop publishing program than a serious document.

Don't fall into this trap. Aim for unity in your documents. Don't use half a dozen different fonts, but at the same time don't let your documents become too boring. I usually stick to two fonts that are complementary and don't differ too greatly. If I'm using GEOS, these two fonts might be California and Roma. Keep one for the body of the text and the other for headings and sub-headings.

GeoPublish, as with most other layout programs, allows the use of templates. These are general layouts that you use again and again, saving you from repetitive steps. Use them to keep the layout of a multi-page document consistent.

Don't let the design of a serious article become too outrageous or too complicated. Remember that you're aiming for someone to actually read the text, not admire your layout creativity. This may not always be the case if you're creating an advertisement.

Avoid large sections of unbroken text. No matter how interesting your article is I doubt that anyone would even start to read it if it appears too daunting. Break the text up with graphics, sub-headings and quote boxes. And just while we're on the topic of quote boxes, use them to catch the reader's attention. Don't pick irrelevant or useless information to use, like "Disk two contained the file". Choose a general sentence to quote that would appeal to a 'page-flipper'.

Strike a balance between 'white' and 'grey' areas. By white areas, I'm referring to blank page. Make sure there's enough between your columns of text without being too much. Grey area refers to text area. Personally, I try to imagine I'm looking at the page from a distance and can only see grey and

WE CAN BEAT ANY ADVERTISED PRICE! BUT WE SELDOM HAVE TO - OUR PRICES ARE THE LOWEST! (IF YOU SEE A LOWER PRICED ITEM, TELL US, IF YOU DON'T, TELL YOUR FRIENDS.)

LOGICO

S O F T W A R E

Mail Order Form To: Logico, P.O. Box 572, Marrickville NSW, 2204

TELEPHONE: (02) 550 0727

AMIGA		AMIGA		REAL ENTERTAINMENT AT THE RIGHT PRICE		AMIGA		COMMODORE 64/128		
ARCADE		STRATEGY		PRODUCTIVITY AT THE RIGHT PRICE		MUSIC		ENTERTAINMENT		
Armour-Geddon	51.95	Loom	64.95	AD&D: DRAGONSTRIKE	\$29.95	Amiga	Amas	197.95	Reash for the Stars	36.95
Back to the future III	54.95	Battle Chess II	54.95	688 ATTACK SUB	\$29.95	Amiga	Audio Engineer Plus	329.95	Red Storm Rising	46.95
Badlands	62.95	Betrayal	56.95	BUCK ROGERS	\$29.95	Amiga	Audio Master III	119.95	Secret of Silver Blade	34.95
BATTLESTORM	64.95	Big Business	61.95	BUDOKAN	\$29.95	Amiga	Bars & Pipes	219.95	Shadow Warrior	35.95
Carvup	62.95	Blitzkrieg May 1940	52.95	F/A 18 INTERCEPTOR	\$29.95	Amiga	Bars & Pipes Prof.	459.95	Street Rod	36.95
Continium	61.95	Blitzkrieg V6.0	48.95	FLOOD	\$29.95	Amiga	Dr T's Copyist Appr.	139.95	Strider 2	54.95
Cybercon III	48.95	Blitzkrieg V6.0	48.95	MAGIC FLY	\$29.95	Amiga	Dr T's Copyist DTP	399.95	Subtuto	36.95
Darkman	51.95	Blitzkrieg V6.0	48.95	POPULOUS	\$29.95	Amiga	Dr T's Tiger Cub	139.95	Super of road racing	36.95
Defender II	45.95	Blitzkrieg V6.0	48.95	POWERMONGER	\$29.95	Amiga	Master Sound	109.95	Teen. Ninja Turtles	36.95
Elf	48.95	Blitzkrieg V6.0	48.95	SKI OR DIE	\$29.95	Amiga	Master Tracks Prof.	499.95	Total Recall	46.95
Final Fight	51.95	Blitzkrieg V6.0	48.95	THE IMMORTAL	\$29.95	Amiga	Perfect Sound	169.95	Turrican II	46.95
FISTS OF FURY II	52.95	Blitzkrieg V6.0	48.95				Quartet	94.95	Ultima	74.95
Gem-X	46.95	Blitzkrieg V6.0	48.95				Sound Express	119.95	Ultima 6	84.95
Gods	54.95	Blitzkrieg V6.0	48.95							
Golden Axe	52.95	Blitzkrieg V6.0	48.95							
Hill Street Blues	52.95	Blitzkrieg V6.0	48.95							
Ishido	62.95	Blitzkrieg V6.0	48.95							
James Pond	52.95	Blitzkrieg V6.0	48.95							
Jupiter Master Drive	62.95	Blitzkrieg V6.0	48.95							
Killing Cloud	54.95	Blitzkrieg V6.0	48.95							
Last Ninja Remix III	51.95	Blitzkrieg V6.0	48.95							
Lemmings	54.95	Blitzkrieg V6.0	48.95							
Lemmings Data	41.95	Blitzkrieg V6.0	48.95							
LOGICAL	47.95	Blitzkrieg V6.0	48.95							
Lotus Esprit Turbo II	57.95	Blitzkrieg V6.0	48.95							
Magic Pockets	51.95	Blitzkrieg V6.0	48.95							
Midnight Resistance	54.95	Blitzkrieg V6.0	48.95							
Mighty Bombjack	64.95	Blitzkrieg V6.0	48.95							
N.A.R.C	54.95	Blitzkrieg V6.0	48.95							
NARCO POLICE	54.95	Blitzkrieg V6.0	48.95							
Nebulus II	51.95	Blitzkrieg V6.0	48.95							
Never ending story 2	57.95	Blitzkrieg V6.0	48.95							
Nitro	52.95	Blitzkrieg V6.0	48.95							
Operation Combat	52.95	Blitzkrieg V6.0	48.95							
Pang	52.95	Blitzkrieg V6.0	48.95							
PANZA Kick Boxing	48.95	Blitzkrieg V6.0	48.95							
Prince of Persia	52.95	Blitzkrieg V6.0	48.95							
PP Hammer	46.95	Blitzkrieg V6.0	48.95							
Rainbow Collection	41.95	Blitzkrieg V6.0	48.95							
Rick Dangerous 2	54.95	Blitzkrieg V6.0	48.95							
Robo Hood	57.95	Blitzkrieg V6.0	48.95							
Robocop II	62.95	Blitzkrieg V6.0	48.95							
Rodland	61.95	Blitzkrieg V6.0	48.95							
Shadow Beast II	74.95	Blitzkrieg V6.0	48.95							
Silkworm IV (SWIV)	56.95	Blitzkrieg V6.0	48.95							
Space Ace	84.95	Blitzkrieg V6.0	48.95							
Street Rod II	51.95	Blitzkrieg V6.0	48.95							
Strider II	52.95	Blitzkrieg V6.0	48.95							
Switchblade II	56.95	Blitzkrieg V6.0	48.95							
Teen. Ninja Turtles	39.95	Blitzkrieg V6.0	48.95							
Terminator 2	51.95	Blitzkrieg V6.0	48.95							
Thunder Jaws	46.95	Blitzkrieg V6.0	48.95							
Total Recall	64.95	Blitzkrieg V6.0	48.95							
Toki	57.95	Blitzkrieg V6.0	48.95							
Turrican II	59.95	Blitzkrieg V6.0	48.95							
U N Squadron	54.95	Blitzkrieg V6.0	48.95							
Viz (PGR Rated)	56.95	Blitzkrieg V6.0	48.95							
Wrath of the Demon	64.95	Blitzkrieg V6.0	48.95							
Zone Warrior	40.95	Blitzkrieg V6.0	48.95							
ADVENTURE		SPORTS		DESKTOP PUBLISH.		UTILITIES/LANGU'GS		GREMLINS		
B.A.T.	75.95	4D Sports Boxing	57.95	Outline Fonts	259.95	Amix II software only	339.95	Gremlins 2	34.95	
Bard's Tale III	51.95	Amiga Cricket	44.95	Pagesetter II	149.95	Ami Alignm't Kit	64.95	Mighty Bombjack	34.95	
Cadaver the Pay-Off	33.95	Bridge Simulator	64.95	Pro Tennis 2	56.95	Amiga Vision	159.95	Ninja Warrior	34.95	
Captive	51.95	Bridge GT-4 Rally	54.95	R.B.I 2 Baseball	57.95	Amos	96.95	Ultima Trilogy (1,2&3)	74.95	
Chaos Strikes Back	54.95	Striker Manager	51.95	Rugby - World Cup	57.95	Arex	62.95	U N Squadron	36.95	
Codename Iceman	64.95	Striker Manager	51.95	Street Rod II	51.95	Aztec C Prof.	289.95	Winners Italy 1990	36.95	
Corporation	54.95	T. LA Russa Baseball	61.95	Striker Manager	51.95	Benchmark Mod. 2	225.95	PRODUCTIVITY		
Corporation Mission	38.95	Ultimate Golf	51.95	Striker Manager	51.95	Can Do	140.95	Action Replay VI	129.95	
Death Knights Kryn	51.95	Ultimate Ride	64.95	Striker Manager	51.95	Can Do Pro-Pak	47.95	Basic - 8 Plus 128	67.95	
Demoniak	57.95	World Cup Soccer	44.95	Striker Manager	51.95	Cross Dos V4.0	47.95	Basic - 8 Toolkit 128	29.95	
Double Soule Bill	77.95			Striker Manager	51.95	Devpack V2.0	135.95	Basic Compiler	67.95	
Dragon Wars	51.95			Striker Manager	51.95	Director Opus II	47.95	Blitz 64	36.95	
Duck Tales	48.95			Striker Manager	51.95	Disk Labeler	54.95	Blitz 64	36.95	
Dungeon Master	47.95			Striker Manager	51.95	Disk Mechanic	97.95	Cobol 64	56.95	
Elvira	57.95			Striker Manager	51.95	Doctor Ami	54.95	Create a Calander	34.95	
Eye of Beholder	51.95			Striker Manager	51.95	Dunlap Utilities	75.95	Data Manager	36.95	
Famous Five	54.95			Striker Manager	51.95	GFA Basic	105.95	Electronic Cash	86.95	
Gateway Savage Fr.	51.95			Striker Manager	51.95	GFA Basic Compiler	79.95	Expert Cartridge	139.95	
Geisha (R-RATED)	64.95			Striker Manager	51.95	GP Term	77.95	Fast Load Cartridge	46.95	
Hero's Quest	57.95			Striker Manager	51.95	Hi-Soft Basic	119.95	Font Master II 64	76.95	
King's Quest 5	64.95			Striker Manager	51.95	Hi-Soft Extension	59.95	Home Video Prod	62.95	
Leisure Suit Larry I/II	54.95			Striker Manager	51.95	KCS Power Board	669.95	Mini Office II	42.95	
Leisure Suit Larry III	64.95			Striker Manager	51.95	Kings Bounty	36.95	Music Const. Set	29.95	
				Striker Manager	51.95	Klax	36.95	News Maker 128	39.95	
				Striker Manager	51.95	Last Ninja II	124.95	Paperclip III	79.95	
				Striker Manager	51.95	Might & Magic 2	39.95	Paperclip Publisher	49.95	
				Striker Manager	51.95	Monty Python	36.95	Pocket Series ea.	66.95	
				Striker Manager	51.95	Ninja Remix	359.95	Power Cartridge	56.95	
				Striker Manager	51.95	Panzer Battles	36.95	Printmaster Plus	56.95	
				Striker Manager	51.95	Pirates	46.95	Print Power	28.95	
				Striker Manager	51.95	Project Ste'lth Fight	46.95	Print Shop	74.95	
				Striker Manager	51.95			Superbase 64/128	56.95	
				Striker Manager	51.95			Superscript 64/128	56.95	
				Striker Manager	51.95			Swiftcalc	36.95	
				Striker Manager	51.95			Video Basic 64	56.95	
				Striker Manager	51.95			Word Writer 5	66.95	
				Striker Manager	51.95			GEOS		
				Striker Manager	51.95			Geos 64 V2.0	54.95	
				Striker Manager	51.95			Geos 128 V2.0	64.95	
				Striker Manager	51.95			Geocalc 128	45.95	
				Striker Manager	51.95			Geochart 64/128	35.95	
				Striker Manager	51.95			Geofile 64	35.95	
				Striker Manager	51.95			Geofile 128	45.95	
				Striker Manager	51.95			GEOPRINT CABLE	64.95	
				Striker Manager	51.95			Geoprogram'r 64/128	35.95	
				Striker Manager	51.95			Geopublish 64/128	45.95	
				Striker Manager	51.95			Geos Int'nal Fonts	35.95	
				Striker Manager	51.95			EDUCATION		
				Striker Manager	51.95			Alien Addition	36.95	
				Striker Manager	51.95			Animal Kingdom	37.95	
				Striker Manager	51.95			Decimal Dungeon	38.95	
				Striker Manager	51.95			Demolition Division	38.95	
				Striker Manager	51.95			Family Fued	29.95	
				Striker Manager	51.95			Fraction Action	37.95	
				Striker Manager	51.95			Math Blaster	47.95	
				Striker Manager	51.95			Mavis Beacon Typing	46.95	
				Striker Manager	51.95			Minus Mission	36.95	
				Striker Manager	51.95			Number Farm	36.95	
				Striker Manager	51.95			Sim City	47.95	
				Striker Manager	51.95			Speed Reader II	46.95	
				Striker Manager	51.95			Spell It	59.95	
				Striker Manager	51.95			Spelling Wiz	37.95	
				Striker Manager	51.95			Wheel of Fortune	29.95	
				Striker Manager	51.95			Where in Carmen. ea.	57.95	

MAIL ORDER FORM

December

NAME: _____

ADDRESS: _____

PHONE: () _____ DATE SENT: _____

POST CODE: _____

QTY	PRODUCT/PROGRAM NAME	COMPUTER	DISK TYPE	PRICE

METHOD OF PAYMENT: Please cross

BANKCARD MASTERCARD

VISA AMERICAN EXPRESS

CHEQUE MONEY ORDER

POSTAGE \$ 3.00

TOTAL \$ _____

CREDIT CARD USERS ONLY:

Credit Card No: _____ Exp. Date: ____/____/____

Signature: _____

JUST BECAUSE YOU DON'T SEE IT - DOESN'T MEAN WE DON'T HAVE IT !!

white. This way you can check if there is too much of either one or the other.

Over the next two months we'll take a look at putting all of the above into practice using *geoPublish* and other GEOS software.

LETTERS

Font Machine

Peter Hunt, of Doveton VIC, writes: "Dear Owen, I very much enjoy your GEOS column. I was very interested in the Font Machine and your User Software Compilation disk. Will it be available and if so how should I order one?" Yes, the disk is now available. See the C64 column elsewhere in this issue for more information.

Special interest

Ivor Laggan, of Sunnybank Hills QLD, writes: "Hello Owen, As a I28D/GEOS user it is nice to still find a magazine that carries at least some space for 64'ers and GEOS nuts. Keep up the good work for as long as possible!"

"Have you heard of any GEOS special interest groups in Australia? How about GEOS specific public domain software (apart from the small amount carried by Brunswick Publications)? What about a BBS similar to Q-Link in the USA?"

"Couldn't you expand your GEOS column? It always seems too short to me. You must get plenty of questions on GEOS. Keep up the good work of reviewing GEOS utilities. There must be many people that are not aware of just what is available."

I haven't heard of any GEOS special interest groups in Australia. Are there any user groups out there who have a significant interest in GEOS?

There's a fair bit of GEOS public domain floating around, it's just a case of getting your hands on it. I only get a bit now and then sent in to me by readers. I'm hoping to compile what I have soon and release it on a disk. If anyone has any GEOS PD software they'd like to share please let me know!

As for the column's expansion, no

I'm afraid not. Firstly, I just haven't the time, and secondly there just isn't enough to write about. There isn't an abundance of new GEOS software being released, and there's only so many times you can tell people about using PaintDrivers. I'll cover as much as I can for as long as I can. Meanwhile, keep sending in the questions and suggestions.

RAM Expansion

Rod Gasson, of Reynella SA, writes: "Howdy Owen, It is now possible to run a 17xx REU in conjunction with the TurboMaster CPU. There is a patch program available on CMD's BBS for this. Here are some rumors that I've picked up on some of my many BBS calls to the USA:

- A third party company (CMD?) is working on a 1581 clone, with Commodore's blessing.

- An undisclosed engineer is working on building an interface so that any hand scanner can be used on a C64.

- Hints of hooking up a CD-ROM to the C64/I28 by using the SCSI interface connections of the CMD hard drive. There's been talk of a dual 3.5 inch drive for the C64, dubbed the Commodore 1582.

"Some GEOS programs you might be interested in:

"PLUS 21K - Formats and gives access to tracks 46-40, effectively giving 21k more storage capacity from your disks.

"DUALTOP - An alternative desktop that allows 3 drives to be accessed directly provided you have an REU. It also displays two disk directories on screen at once and has a fuel gauge to show available disk space".

Star NX-1000 and GEOS

"Some help for Dennis Connell (ACAR - Sept 91) in regards to his Star NX1000 printer and GEOS:

"To use the printer's inbuilt fonts etc is quite easy. Firstly I suggest that he obtain the EX800-3.3 printer driver. Using the 240dpi option his printouts will be near NLQ anyway, even with GEOS fonts. This is achieved through interpolation, and works very well. To

use the printer's fonts he must hold the printer's style and pitch keys down when he powers up the printer. He should then select whatever pitch/style he wants by pressing the appropriate buttons. When he does the printout he should select DRAFT output. The printer will do the rest. Unfortunately you can't use italics or any other enhancements, but it is ideal for simple letters etc.

"Also, I'd like to add that users with the Xetec (and most other) printer interfaces should always set the interface to transparent mode when using GEOS.

"Finally, I need help. Can anyone tell me what the difference is between a modem RS-232 interface and a printer RS-232 interface? The reason I'm asking is that my new printer has an RS-232 input as well as the Centronics input and a couple of the printer drivers I wish to try require the RS-232 connection. I've plugged my modem interface into the printer, but the printer/program refuses to acknowledge the other's existence. When I have the cable plugged into the modem and select 'PRINT', the rx/tx LEDs on the modem flash indicating that data is being received by the modem so the program is definitely using the same data lines as the modem interface, so why doesn't it work with my printer? Any ideas?"

"PS: Please don't stop writing for ACAR because your articles are about the only thing that keeps me buying the mag. Without your columns there would be nothing for me to read. (I have no interest in Amiga stuff!)"

Thanks for all the info. In regards to your problem, the only thing I can think of is that either your printer or driver software isn't using the correct protocol. RS232 interfacing has always been a bit of a problem with the C64 because it doesn't have a standard RS232 port. Can anyone offer some other advice? (It could also be a cable problem. A modem will work happily with a simply 2-2, 3-3 and Ground connection, whereas printers sometimes require more lines to be connected - Ed.)

That's it from me for this month. Until next time, you can drop me a line care of ACAR, PO Box 288, Gladesville, 2111. Don't forget to include a stamped, self-addressed envelope. □

MEGADISC

... when you're thru playing games

☎ Number for Contributors & ORDERS : 008 22 7418

**New low prices
for MD & PD!**

Megadisc was designed to help you really learn how to use your Amiga. Tutorials, articles, reviews, hints and tips, useful software, and much more are included to help both the beginner and the veteran to use the Amiga more productively. Not too serious and not too lightweight, Megadisc entertains you while you learn. Available as single issues, subscriptions of any three or six issues (for only \$45 or \$79), or as a Trial Pack (including MegaDos, our Amiga Manual-on-Disk and Megadisc 23, and our Catalogue-on-Disk). If you get a Trial Pack, you can subscribe

later for the new lower rate mentioned below. Megadisc subscribers get lower prices on all our products, including the largest collection of quality public domain disks (almost-free software), now \$2.50 each to current subscribers. Every Megadisc has the latest Virus-Killer update, and each Megadisc contains as much material as three of four conventional magazines, plus material available only on disk. Don't accept imitations or PD re-hashes.

• • • • MEGADISC 25 AVAILABLE ! • • • •

The Entire Megadisc Series 1-23

- Order Megadisc 1 ~ 23 and a Catalogue-disk for \$199!
- That's 24 information packed disks with ALL available Amiga info!
- AmigaDos Manual-on-Disk, with all you need to know about CLI, Workbench 1.2, 1.3 and ARP described in layman's terms for \$19.95. Price for current subscribers \$13.95
- Trial Pack - Megadisc 23, Megados, and Catalogue-Disk for \$29.

Subscribe for less!

\$45 for a 3-Issue subscription (2 free PD Incl.) - re-sub for \$40
\$79 for a 6-Issue subscription (4 free PD Incl.) - re-sub for \$69



The BEST AMIGA Public Domain Disks

- Don't miss this terrific, and cheap, resource! Disks cost \$3.50 each ~ \$2.50 for Subscribers. All our Disks are fully described on our FREE Catalogue-Disk. Buy 10 PD disks, get one free ~ ie 11 PD disks for \$25 or \$35! Games 10-Disk-Pack & PD 10-Pack for \$35 each. Our PD collection of 2800 disks contains databases, word-processors, spreadsheets, demos, graphics, tutorials, animations, utilities and more! All disks are virus-free, and many are unavailable anywhere else.
- ALL-NEW CLIP-ART PD 10-PACK V.2 - 10 disks full of terrific Clip Art for \$35!

Send to: MEGADISC, PO Box 759, Crows Nest

Telephone: (02) 959 3692 (all hours) Fax: (02) 959 3525

Contributions to Megadisc of any kind are most welcome ~ please call

We do not charge for Postage and Packaging, and there are no hidden extras in our prices

We also take BankCard, MasterCard and Visa Orders by Phone or Fax.

I enclose a Cheque/Money Order for _____ or please charge my Creditcard:

MasterCard/BankCard/Visa No: _____ Exp: _____

Please send me: • Catalogue-on-Disk AT NO COST: • Trial Pack \$29 • ANY 6 issues of Megadisc for \$79 (please specify) _____ (\$69 for re-subscribers)

• ANY 3 issues of Megadisc for \$45 (please specify) _____ (\$45 for re-subscribers) • Megadisc 1 ~ 23 and Catalogue for \$199 • The 4 free PD disks I want (2 in

the case of a 3-issue sub) are: _____ OR please send your Catalogue-on-Disk now and I will choose the remaining disks later: • 10-Disk Game

Pack for \$35 • PD Clip-Art 10-Pack for \$35 • Megados AmigaDos Manual-on-Disk for \$19.95 • For current subscribers \$13.95 • Other Orders: Please attach.

Signature _____ Occupation _____

Name _____

Address _____

Telephone _____ Date _____

Students & Pensioners: Send proof of your status (photocopied bus pass, etc.) with any order, and get 10% off the cost !

**Make sure
of getting
your copy**

**SUBSCRIBE
NOW!**

The Australian COMMODORE & AMIGA Review

Please enrol me for 6 12
issues subscription to The
Australian Commodore and Amiga
Review, for issues, starting
with the issue.

I enclose a cheque/money order
for \$

Please charge my Bankcard
(NOTE: not Visa or Mastercard etc)

Number

Expiry date:

Name:

Address:

.

Postcode:

Please tick applicable box

First Subscription

Renewal

Rates within Australia:

6 issues \$19.00 (inc postage)

12 issues \$36.00 (inc postage)

Postage extra for overseas - telephone
for costs

Post to:

21 Darley Road,

Randwick NSW 2031

Phone (02) 398 5111

Fax: (02) 398 5322

Prime Artifax



THE AMIGA PUBLIC DOMAIN SPECIALISTS

Animation

Ace #06	WTAJ/Head SA4D	\$5.50
Ace #09	Stamp Collector 1Mb	\$5.50
Ace #14	Frame Grabbed Knight	\$5.50
Ace #16	Clerk Kent - SA4D	\$5.50
Ace #17	Car Circle & Various Kent	\$5.50
Ace #18	Clerk/VectorHard/Prawns	\$5.50
Ace #19	Gums & Kongman - SA4D	\$5.50
Ace #20	Bottle/Walking/Snap	\$5.50
Ace #29	Ripples - SA4D - 1Mb	\$5.50
Badge	Various Contest Winners - 1Mb - (3)	\$12.95
Ball Bouncing Cycle	Classic Dpaint Anim	\$5.50
Bat Dance	Animation & Music	\$5.50
Busy Bee	Sculpt Animation of Bee - 1Mb	\$5.50
Cartoon 1	Batman/Stealthy/S-Cock - 1Mb	\$5.50
Cartoon 3	3 Juggler anims - Schwarz - 1Mb	\$5.50
Crionics	Animation & Music	\$5.50
Dragon's Lair	Animation & Music of game	\$5.50
Enigma Demo	Winning Animation	\$5.50
Epic Demo	Animation & Music of game	\$5.50
Gymnast	Sculpt Anim - 1Mb	\$5.50
Luxo Teenager	Classic Sculpt Anim	\$5.50
North Star	Hacker Demo - Music (2)	\$8.95
RGB Hazards	Director Presentation 1.5Mb	\$5.50
Simpsons Demo	Animation & Music of Show	\$5.50
Space Ace	Animation & Music of Game	\$5.50
Stamp Collector	Sculpt 4D Anim	\$5.50
Trackball Animation	Sculpt 4D - 1Mb	\$5.50
Vaux Killer	Cartoon Style Comedy - 1Mb - (2)	\$8.95
Walking CAT	Inc. Original Juggler	\$5.50
Walker I 1Mb	From Star Wars - Sound	\$5.50
Walker I 2Mb	As above, but longer (2)	\$8.95
Walker II 2Mb	Award Winning!!! (2)	\$8.95
Zues Demo	Rotating Digitised Head	\$5.50

Business

CAD	Computer Aided Design	\$8.95
Database	DataEasy, bBase II, HomeManager & H-Dial	\$8.95
Finance	BankN, Your Money Budget & Checkbook	\$8.95
Spreadsheets	Analytical/Calc	\$8.95
Text Editors	All the best!	\$5.50
Wordprocessing and Utilities		\$8.95
Wordwright Wordprocessor		\$8.95

Communications

Comms I	JRComm/Essential Utils.	\$5.50
Comms II	Vaxterm/ANSI TextPaint/Archedge	
	VT100/Softspan BBS/Intuiface & Hyperdialler	\$5.50
NComm 1.92	Best Comms Package	\$8.95

Demonstration

AMOS 3D	Demo Animation & Music	\$5.50
Cameron Scanner	Image Slideshow	\$5.50
Calligari Demo	Modelling (Limits)	\$5.50
Deluxe Paint IV	Paint (No Save)	\$5.50
Lemmings	3 levels - Top Fun!	\$5.50
SpectraColour	Paint (No Save)	\$5.50
Superbase Pro4.0	Limited Version - 1Mb	\$8.95
Real 3D	Raytracing Program (No Save)	\$5.50

Desktop-Publishing

Clip-Art 1,2 & 3	Hi-res monochrome or all three volumes for only	\$8.95 ^{ea}
		\$22.00
PageStream 2.1 Designer	Fonts - Volumes 1 to 5	\$8.95 ^{ea}
	or all five volumes for only	\$39.95

Education

Chemistry	Molecular Modelling	\$5.50
Education 1	Elements/SpaceLOG	
	Draw/Map/Rubik/Gears	\$5.50
Education 2	Orbit/Enigmas/ZPlot	
	LifeCycles/Planets/Gravity Well	\$5.50

Entertainment

Hot Games 1	Arcade	\$5.50
Hot Games 2	Strategy	\$5.50
Hot Games 3	Arcade	\$5.50
Hot Games 4	Classics	\$5.50
StarTrek	Graphics/Sound - Top Game (2)	\$8.95

Emulation

Atari	Try it out!	\$5.50
C64	(Requires additional hardware)	\$5.50
MS-DOS	Read/Write/Format MS-DOS disks	\$5.50
Transformer & IBEM	Run IBM Programs	\$8.95

IFF Graphics

ArtScape	Slideshow - (2)	\$8.95
CSIRO Satellite Images	Australian	\$5.50
DigiView	Slideshow I Digitised	\$5.50
DigiView	Slideshow II Digitised	\$5.50
Gallery	Hot Ray Traced Slide Show	\$5.50
Newtek Demo 1	Slide Show - (2) - 1Mb	\$8.95
Newtek Demo III	Slide Show - (2) - 1Mb	\$8.95
PC 87 Slideshow	\$5.50	
Vidi Frame Grabs	Slideshow	\$5.50

Music

MED 3.1	Best sequencer/MIDI	\$5.50
Mr SandMan	Digitised - (2)	\$8.95
Music Mania #1	Assort. Songs	\$5.50
Music Mania #2	Assort. Songs	\$5.50
Remix 1	Madonna/Blackbox	\$5.50
SoundTracker	(Inc. Songs & Instruments) - (5)	\$22
Tracks 1-5	Sountracker Modules - Inc. Player	\$5.50
each		

Paint & Rendering & Desktop Video

Graphics 1	Stillstore - for Desktop Video	\$5.50
Graphics 2	TitleGen/sMovie/Abridge	
	SceneGenDemo/ SlideMaster/ ImageLab	\$5.50
Graphics 3	TurboTitle/CyroUtils PicBASE IFF Database	\$5.50
Mandlebrot Set	Six Disk of Programs	\$24.95
Ray-Tracing Theme Disk	DBK-Render	\$5.50

Sound Samples

Movie Samples 1-10	IFF Sound Samples	\$5.95 ^{ea}
Movie Samples 10 Disk Set		\$39.95

Workbench & CLI

Anti-Virus Protection	NEW RELEASE	\$14.95
AmigaDOS Utilities	All You Need! - (2)	\$14.95
ARP 1.3	Smaller, faster CLI commands	
	includes ARP.LIBRARY and easy installation	\$5.50
HACKER 1	All the best utilities for you!	\$5.50
ICON Tools	Design, Edit your own or choose	
	from ready to use included icons	\$5.50
Super Workbench	1MB and 512K versions	
	(Enhanced Boot Disk for floppy based Amigas)	\$8.95

The number in brackets refers number of disks included in the package.

FISH Catalog Disk

Contains FISH up to 410 for floppy disk drive users.
\$5.50

FISH DISKS TO 550

\$5.50 each or \$5.00 each if 4 or more are ordered

FISH Catalog Disk ·HD·

Contains FISH up to 530 for installation onto a harddrive.
\$5.50

How to Order



FREE Order Hotline
(008) 252 879
SYDNEY (02) 879 7455
For orders & **ALL enquires**

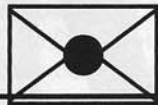

Prime Artifax
P.O Box 288
Gladesville 2111

Prime Artifax

Fish, TBAG, Amigan, Amicus, Alpha, FAUG, Topik

MEGA GAME PACK

Four
Disks
ONLY
\$14.95

Hot Games - 1: Arcade

AirAce: Just like Blue Max. Fantastic shoot-em-up fun for all skill levels. Two players at the same time option.

Humartia: Head to head jet combat, great for stirring up those competitive friends.

Missile Command: The pace is fast and furious - this one is bound to wear out your joystick.

Car Race: Great 4 channel stereo sound effects. Uses the whole PAL screen in overscan mode!

Downhill: Sssshuushh your way down the tight slalom course making sure that you stay in the gates.

Hot Games - 2: Strategy

Blackjack: Ye old favourite

Metro: City planning - SimCity-like game for those who like simulations.

China Challenge: Shanghai under a different name.

Conquest: A two player game in which you are trying to take over the universe - watch out your opponent wants it too.

Klondike: For those who just can't get away from card games.

Hot Games - 3: Arcade

Hate: A Zaxxon like arcade game in full machine code. Diagonal screen scrolling!

MegaBall: The ultimate in breakout games - better than some commercial games around. Great graphics, superb sounds and amazing action.

Hot Games - 4: Classics

Galaxians, Pacman, Spac Invaders and Asteroids: A great collection of clones of the classic arcades games that started it all off. You couldn't do with this one in your collection.

Mega Game Pack
All four for just **\$14.95**



Clip Art 1,2,3

Due to the popularity of our last Clip-Art disk we have searched and found more public domain clip-art for use in desktop publishing and presentation. We now have 3 disks packed with images. Soon we will be releasing more - so watch this space.

*\$8.95 ea. or
\$22.00 for 3 disk set*

PD Starter Kit

Just the thing to get a taste of the PD Domain Library. We have selected a good cross section of utilities and demos that will start your library.

**Over \$50 value
for just \$34.95**

Super Workbench	Normally \$8.95
Anti-Virus Pack	\$14.95
Database	\$8.95
Star Trek from AGATron	\$8.95
Newtek Demo 1	\$8.95

The LOT ONLY \$34.95
(7 Disks full - Free postage)

Cartoon Animations

Cartoon Anims 1 - Eric Schwartz
Batman, Shuttle Cock, Stealthy 1mb

Cartoon Anims 2 - Eric Schwartz
Amy vs. Walker 1mb

Cartoon Anims 3 - Eric Schwartz
Juggette, Juggette 2, Juggler 2 1mb

Cartoon Anims 4 - Eric Schwartz
At the Movies 2mb

Cartoon Anims 5 - Eric Schwartz
The Dating Games 2 disks 3mb **\$7.95**

Cartoon Anims 6 - Eric Schwartz
Pogo 2mb

Cartoon Anims 7 - Eric Schwartz
Anti-Lemmings Demo 2mb

Cartoon Anims 8 - Eric Schwartz
Stealthy Manuever II (1mb), Swiss Army F-16 (1.5mb)

Cartoon Anims 9
Bugs Bunny Show 1mb

Only \$5.50 each

Pagestream Fonts 2.1+

Five disks full of Adobe type 1 postscript fonts for use with Pagestream 2.1 or greater. On average each disks contains ten fonts that will make your documents all the more presentable.

*Only \$8.95 each
or \$39.95 for the five volumes*

Virus Protection Pak

Brand NEW Compilation

Many so-called virus programs are now out-of-date. You're Amiga could be at risk. New virus strains are appearing and many people are unprotected.

This compilation represents the best in virus detection and eradication software in the world. Don't get caught. ACT NOW!

Ideal for hard disk or floppy based systems. Includes full on-disk instructions.

Value at only \$14.95

Super WB

Super Workbench is synonymous with Prime Artifax, it is one of our greatest sellers. Included are a host of utilities that enhance the Workbench environment. Programs like SID, dMouse, DropCloth, ARP, Wlcon, Fullview, PopInfo and more are at your fingertips.

All programs have been installed and are ready for use. We take the hard work out of Public Domain.

1Mb or 512k Versions

\$8.95

How to Pay

1. Credit Card - Visa, Mastercard or Bankcard.
2. Send a cheque or money order.
3. Cash on delivery. Collect from your post office and pay them (extra \$4.50 Australia Post charge.)

ORDER FORM - Post to P.O Box 288, Gladesville

Name

Address

Day Phone

Card No

Exp Date \ Visa B/C M/C

Signature

PRODUCTS

HUGE PUBLIC DOMAIN LIBRARY

CDTV

Feedback

Send your CDTV letters to Phil Campbell, PO Box 23 Maclean NSW 2463. You can ask questions, make comments, or simply sound off about Commodore's new multi-media marvel.

Dear Phil, I understand that a conventional Amiga 3.5 inch disk drive can be fitted to the back of the CDTV. I own a CDTV, but before I commit myself to the purchase of another external drive, I have a few questions:

- * Will standard Amiga programs boot up normally on the CDTV?
- * How will they look and feel?
- * Will the remote control that comes with the CDTV be sufficient to run the software, and if not, when will the CDTV add-ons be available?

Many thanks and congrats on a great column.

*Peter Gleeson
Matrville, NSW*

Ed: January will see the official release of the long awaited peripherals, though an "unofficial" keyboard is already available from Sydney's Hard Disk Cafe - see the news item below.

In the meantime, you can have a fair bit of fun - the joypad acts exactly like a mouse, and lots of software will autoboot from an external drive. Certainly, any disk running a standard workbench boots easily. Some copy protected games won't load though - it's a matter of trial and error.

The remote controller can simulate either a mouse or a joystick. In mouse mode it's a little slow and not as smooth as the genuine mouse, though everything works as expected. The "look and feel" is exactly like an Amiga 500 running through a TV modulator.

News

Japanese CDTV consortium announced

Commodore US have announced the formation of a CDTV consortium with Mitsui for the purpose of promoting and developing CDTV titles and players in Japan. Japan Electronics Publishing has also joined the group, with plans for the release of software for the Japanese domestic market. This is potentially a healthy development for Commodore, and bodes well for the future of the CDTV.

Plug in Keyboard from Hard Disk Cafe

Sydney's Hard Disk Cafe - at the moment the premier dealers if you're interested in CDTV - got tired of waiting for Commodore's official add on CDTV keyboard. So here's what they've done.

With Commodore's semi-official blessing, they've bought a batch of Amiga 2000 keyboards and modified them to plug straight into the back of your CDTV. Simple!

The keyboard costs around \$200, and lets you use your CDTV just like an Amiga. The only thing missing is the infra-red link, which should make the

official unit a bit more flexible. And, of course, the regulation black colour scheme! For more information, phone the Hard Disk Cafe on (02) 979 5833.

Karaoke to your heart's content!

We've always known that the CDTV was really a laser Karaoke machine in disguise! Here's the proof. Singapore's JTS Electronics have released a catalogue of 17 CDTV compatible Karaoke song discs. Each disc features 18 classic song tracks - all you need to do is sing along!

Here's a sample of the selection from disc USA-1 ... Like a Virgin, Wake Me up Before you Go-Go, I Will Survive, Everytime you Go Away, It's too Late, You're So Vain, I Write The Songs, Close to You, Rainy Days and Mondays, I'll Never Fall in Love Again, Rich Girl, Baby I'm-a Want You, I Can't Help Myself, Hot Stuff, Mack the Knife, and Love is a Many Splendoured Thing.

For more information on turning your CDTV into a Karaoke, phone Karen at the Hard Disk Cafe on (02) 979 5833.

Software slowdown on CDTV

The supply of new entertainment and educational software on the CDTV seems to have slowed to a trickle. Maybe this is the calm before the storm - let's hope so. Meanwhile, here at *Commodore and Amiga Review* we're still waiting for lots of the review copies we've been promised by Commodore!

More news next month.

Advertisers Index

ACL	63	Express PD	56	Mindscape	OBC
Allens	1	Floppy Shop	61	MVB	33
Amiga Public Domain Ctr	71	Fonhof	37	Pactronics	4
Ami Light	57	G-Soft	52	PCM Computer Design	21
Ami Tech	47	Hard Disk Cafe	27, 28, 29	PM Developments	25
Brunswick	8, 58	Harris Hi-Tek	34	Parcom	17
BuySoft	34	Interlink	22, 23	Pelham	71
Classified	85	Island By Mail	71	Phoenix	49
Commodore	IFC, 41, 50, 51	Kaotic Concepts	9	Power Peripherals	3, 5, 7, 11
Computer Discounts	44, 45	Lazarus	8	Quadrant	1, 31, 42, 58, 71
Computer Magic	53	LeeJan	25	RapiSoft	13
ComputerMan	2	Logico	65	Rod Irving	71
Computermate	IBC, 15	Macro Soft	38, 39	Shop 4	17
Computer Spot	43	Megadisc	67	Sigmacom	35, 59
Desktop Utilities	37	Mega Micro	63	Star	48
				Unitech	71

United
Graphic Artists
AUSTRALIA

POWER PACKER PROFESSIONAL

INCREASE STORAGE BY FOURTY PERCENT YOU CAN'T PUMP UP A DISK, BUT WITH POWER PACKER YOU CAN COMPRESS ITS CONTENTS INTO LESS THAN TWO THIRDS THE SPACE OTHERWISE REQUIRED FOR STORAGE -- ON FLOPPY OR HARD DRIVE. POWER PACKER USES SOPHISTICATED CRUNCHING ALGORITHMS TO REDUCE THE SIZE OF THE FILES, ALLOWING AN AVERAGE OF 40 PERCENT MORE MATERIAL TO BE STORED.

POWER PACKER RRP PRICE \$35.95

NEWSFLASH DISK MAGAZINE (2Disk)

IF YOU'RE AFTER A DISK MAGAZINE WITH A DIFFERENCE, NEWSFLASH IS FOR YOU. AS WELL AS REGULAR EDITORIALS, THIS 2 DISK MAGAZINE HAS PROGRAMS, UTILITIES, CREATIVE ART, MUSIC DEMOS AND OTHER NOTICES. PLUS MUCH MORE...

NEWSFLASH(2DISK) RRP PRICE \$16.95

Dealer Enquiries Welcome
26 Rochester Way Dianella WA 6062
PO Box 380 Morley WA 6062
Tel (09) 375-1933 Fax (09) 375-1113
Mobile All Hours (018) 918 608

**AUSTRALIA'S
CHEAPEST DISK PRICES!**

"NO BRAND DISKS"

LIFETIME WARRANTY / BOX OF TEN DISKS
ALL DISKS INCLUDE ENVELOPES & WRITE PROTECTS

	1-9	10+	50+	100+	500+
5 1/4"DS/DD	\$4.75	\$4.50	\$4.30	\$4.10	\$3.90
5 1/4"DS/HD	\$8.75	\$8.50	\$8.20	\$8.10	\$7.50
3 1/2"DS/DD	\$8.50	\$7.90	\$7.70	\$7.50	\$6.90
3 1/2"DS/HD	\$16.50	\$15.90	\$15.50	\$14.75	\$13.90

ROD IRVING ELECTRONICS

MELBOURNE: 48 A'Beckett St City. Ph: (03) 663 6151
OAKLEIGH: 240C Huntingdale Rd. Oakleigh. Ph: (03) 562 8939
NORTHCOLE: 425 High St. Northcote Ph: (03) 489 8866
SYDNEY: 74 Parramatta Rd. Stanmore. Ph: (02) 519 3134
MAIL ORDER: 56 Renver Rd. Clayton. Ph: 008 33 5757

MELBOURNE DEALER - BLUESTAR COMPUTERS:
271 Maroondah Hwy, Ringwood. Ph: (03) 870 1800
DEALER ENQUIRIES WELCOME: Ph: (03) 543 2166

FREE PACK & POST OVER \$200

**Want Workbench 2.0 and
total compatability?**

Install a **KICKBOARD** now, switch between Kickstart 1.3 & 2.0

- 1 Suits Amiga 500, 2000 or 2500.
- 1 Holds your 1.3 & 2.0 Kickstart Roms.
- 1 Single switch between 1.3 or 2.0.
- 1 Simple to install DIY instructions.

1 Only \$39.90 +p&h (Kickstart 2.0 not included)

KAO Red Spot DS/DD \$9.95 (Box 10)
KAO Coloured 50 Pak \$49.75(6Colours)
Axiom (ByKAO) DS/DD \$19.95 (Box 10)
Printer Ribbons for: Citizen 120D, 180D, 5200, GSX140, Star NX1000 & MPS1250
All black All \$14.95
KDV (138 Virus Detection) \$24.95
Megadisk available here! \$19.95
TRANSBOARD (Disk switch) \$49.90 +p&p
Independent repairs to Commodore Equipment
Unitech Electronics P.L (Est. 1978)
Phone: (02) 820 3555 Fax (02) 603 8685
Shop 8B Tummul Place St. Andrews
PO Box 137 Minto NSW 2556

Amiga Public Domain Software

Over 3000 Disks to choose from

NO SUBSCRIPTION FEES
NO JOINING FEES
NO POSTAGE CHARGES
DISKS \$3 - \$4 - \$5 EACH

All orders shipped within 24 hours of receipt.
Send \$4.00 for 2 Disk Catalogue
or \$19.95 for Introductory Pack of 8 Disks
which includes 3 Games Disks, 2 Utility Disks and
Master Virus Killer Disk. Plus Disk Catalogue.
Catalogue Disk upgraded free anytime with orders,
Stamped SAE if not ordering.

Christmas Holiday Special

10% Discount on all orders over \$25 from December
1st 1991 to January 31st 1992. Excluding Catalogue
and Introductory Pack.

Amiga Public Domain Centre
P.O. Box 435, St. Agnes SA 5097
Phone (08) 396 2163 Fax (08) 396 2163
We Accept Bankcard, Mastercard and VisaCard

SOFTWARE FROM \$1

Amiga, Commodore 64/128 owners. Why pay \$10, \$5 or even \$3 for great public domain software when you can get the same and better from only \$1 per disk, and that includes the full FISH DISK range!

Just cut out and send this POSTPAID reply to us for a free, no-obligation information kit. You'll be thrilled that you did.

Name _____
City/Town _____
State _____ P/Code _____
Computer Type _____

Send to: POST PAID 49
Island Software Club
P.O. Box 381
Werribee VIC 3030

**MEMORY EXPANSION
PRICES at November 15th**

1MB x 1	- 80ns	DIP	\$6.00
4x256	- 100ns	DIP	\$5.95
	- 80ns	DIP	\$6.00
41256	- 120ns	DIP	\$1.75
	- 100ns	DIP	\$2.00
1MBx4 (44C1000)	80ns	A3000 ZIP	\$31.00
1MBx4 (44C1002)	80ns	col static ZIP	\$36.00
1MBx8	- 100ns	Simms (G.V.P.)	\$50.00
x8	- 80ns	Simms	\$55.00
4Mbx8	- 100ns	Simms (G.V.P.)	\$205.00
	- 80ns	Simms	\$215.00
4Mbx9	- 80ns	Simms	\$225.00

All types of DRAM & memory modules in stock
Please phone for the latest prices. Sales tax 20%.
Overnight delivery, credit cards welcome.
1st floor, 100 Yarrara Rd, Pennant Hills 2120.
PO Box 382, Pennant Hills 2120.

pelham PTY LTD
Tel: (02) 980 6988 Fax: (02) 980 6991

Phil Campbell's MINDSCAPE Entertainment

All the latest news and views from the world of entertainment

Happy Christmas!

Christmas time again, and this month we've got news and reviews of all the latest and greatest games for your Commodore. Fancy a game of World Cup Rugby? You'll find our review in the next few pages.

Or what about Snooker? *Jimmy White's Whirlwind Snooker* rates an ACAR STAR award - it's fast, smooth and lots of fun.

Utopia gives you the chance to build a fully functional model city in space - SIM-CITY with bells on!

You'll like Mike Spiteri's review of *Maupiti Island* too - he's been waiting for this one for months.

So Happy Christmas, read on, and enjoy...

New link with OziSoft

Keen eyed readers might have noticed that we haven't reviewed many games from Ozisoft over the last few months. That's because they haven't been sending any!

Good news. New PR Chief Christina Caddy promises to get things on the

move again, with all the top new Ozisoft products winging their way to us for review. You can look forward to seeing top titles like *Monkey Island* and *A-10 Tank Killer* on these pages soon.

ACAR Game Hints

Version 1.3 of the ACAR Hints and

Tips disk is still available - a nice little stocking stuffer for Christmas.

Simply send a blank disk, a stamped, self addressed envelope (large enough for the disk to fit in) and a cheque for \$5.00 to:

Phil Campbell

PO Box 23

Maclean, NSW 2463

Your Hints Disk will be returned in the next mail.

Electronic Arts Christmas releases

Just as *Home Alone* has been released in your local video store, Electronic Arts are releasing the Amiga game of the same name! Good timing, and if it's anything like the movie it should be a fun title for Christmas.

For Role Playing fans, *Rules of Engagement* from Mindcraft hit the shelves last week, and *Shadow Sorcerer* from SSI is due any day now.

Might and Magic III will unfortunately just miss the Christmas rush. Watch out for some special deals on compilation packs too - *Indy 500* and *PGA Golf* are promised as a budget priced compilation.

Amiga games slow down

Without exception, software distributors report an alarming trend. The demand for Amiga games is dropping, while PC compatible market is going through the roof. Why? Well, one rea-

Mindscape Competition

Ho, ho, ho! Mindscape are in a jolly little mood for Christmas, and they're giving away some goodies!

This month it's five copies of *Jimmy White's Whirlwind Snooker* looking for a good home. You're crazy if you don't enter, because as you'll see if you read the review in this issue, it's a top notch game. Just answer the following questions on the back of an envelope, and send it to:

Phil Campbell, PO Box 23 Maclean NSW 2463 before the end of the month, and who knows? You might be potting black in '92.

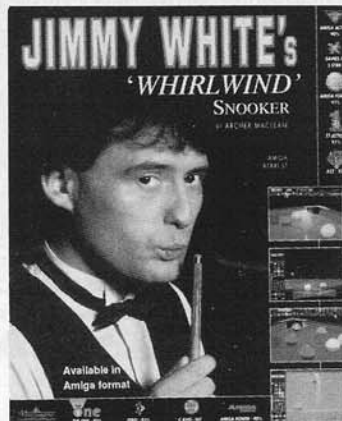

1. What's Jimmy White's current World Snooker Ranking?
2. How old was Jimmy when he won the English Amateur Championship?
3. What are two words that rhyme with SNOOKER?
4. What colour is snooker chalk?
5. How many balls are used in a standard game of snooker?

Easy, eh? Get those entries in as soon as you can, and please, please, please, don't send other stuff like letter and high scores in your competition entry envelopes - sure, it may save you a stamp. But it probably won't ever get opened!

son is that PC clones are getting faster and cheaper.

PC games are getting better and better too, with titles like *Wing Commander II* outclassing anything yet available in the Amiga marketplace.

Add the fact that Amiga fans are masters of the art of piracy, and you can understand why distributors are getting a little apathetic when it comes to supporting our favourite machine. What can you do about it? Simple. Instead of copying games from your friends, go out and buy something!

AMIGA Hints & Tips

Don't forget to send your Amiga hints and tips to Phil Campbell, PO Box 23, Maclean, NSW 2463. If you send your tips on disk with a stamped, self addressed envelope, we'll send it back with a copy of our magnificent ACAR Hints Disk absolutely free! Now it's on with the hints...

DRAGON'S LAIR 2

Michael Summers of Albion Park sent the following tips for this graphical masterpiece. "Simply type GET MORDROC DIRK (including the spaces) before starting the game to make things a little easier," says Michael. In fact, I think this code lets you run right through the game - a neat way to admire the graphics.

ATOMIX

Michael also says pressing the HELP key and typing TIME will freeze the clock in Atomix.

LEMMINGS

Here's one I wish I'd known while I was still addicted to Lemmings! Type FQUIGGLY on the title screen will make your lovable Lemmings suicide proof.

INTERNATIONAL KARATE +

If you're not the Bruce Lee type, try pressing the space bar when you're knocked down. This should make your fighter invincible.

Mindscape Stormball winners

Here are the talented winners of the Mindscape *Stormball* word game. Again, there was a terrific response.

First prize, a copy of *Stormball*, goes to Chris Tan, of West Ryde NSW. Chris found 305 words - some of them were pretty strange, but the judge decided they were all legitimate.

Second prize goes to Damian Steward, of North Hobart, Tas who travelled the entire Websters and Chambers dictionaries to come up with his total of 280 words.

Regular entrant - and previous winner - M.N. Quan, of Mt Pritchards NSW used The Official Scrabble Players Dictionary to scrape up 273 words for third place.

Deb Bowden, of Tanunda, SA, found 272, and Andrew Cooper of Picnic Point NSW found 262.

Congratulations to you all, and thanks to Mindscape for the prizes.

PRINCE OF PERSIA

Peter Chun of Westmead has an answer to poor Doug G. who was stuck in *Prince of Persia* in the October issue.

"I know how to beat Fatso," says Peter. "I find it easier to do all the fighting with the keyboard (use the cursor and shift for fire). When Fatso comes close to you strike at him and he will block the blow then in a fluid motion strike at you. When he strikes at you push up to parry his blow and instantly attack him. Just keep hitting shift and up in alternate goes and you should see a nice sword fight, eventually he gets hit, so you just wait until he comes close again and repeat the above."

The mysterious Dolly of S.A., also wrote with advice on the fat guy.

However, Dolly has got some more pressing problems of her own two screens later.

There's a ledge with a pressure stone on it to open the gate on the other side. To get to the other side you need to take a running jump, and you end up hanging by your fingernails.

Meanwhile, your shadow from level 4 steps on another pressure pad and closes the gate!

"Please help," cries Dolly in distress!

Finally, Dolly says that if you press shift-L you'll automatically jump to the next level. This works from level 1 to 4 only.

SUPERCARS

Andrew Gormly writes from Walkerville, SA, with what he promises are "some hot new tips." In *Supercars 2*, enter the name of player as "Wonderland" and player 2 as "The Seer" - both players will have full armour, the best engine and 99 of each piece of obliterative equipment including front and rear missiles!

In the original *Supercars*, put your name down as RICH and the game will give you \$200,000 to spend. ODIE will take you automatically to the 2nd level.

SPHERICAL

Serena Sandrin sent the following tips for Edmond Tatti, who was having problems with the dragon on level 19 of *Spherical*. To get past him, says Serena, you have to come to the room with full energy, collect the appropriate keys, fall on the dragon and then run off very quickly to the left, drop down, then collect the final key to get out of the room. Serena also added some passwords to get to higher levels: YARMAK, STORMBLADE, SKY FIRE, and MIRGHAL.

Now for the bad news. Serena is stuck on level 79! "I can't see what to do," says Serena. "There are no keys, no balls - nothing but a few steps and the dragon > Help!!!"

Let's hope someone can come to her aid!

Immortality

C64 Hints and Tips

Twas the month before Xmas when all through the house not a creature was stirring, not even a mouse (or a joystick for that matter). Slarti's Amiga was bung and the Ed wanted him hung, as the deadline had been and gone. But Parcom fixed the ailing Miggy, the damage superficial, and now twas the time for the Immortality Xmas Special!

That's right folks, it's that time of the year when the festive season goes into full swing, wallets are rapidly emptied, and ACAR columnists write silly intros. Well, you lot in readerland are obviously full of Xmas spirit(s) as Immortality has been completely ignored this month. Yep, we've reached an all-time record low of ZERO tips sent in! Due to this absence of all things pokey, in this month's SPECIAL we'll be taking an A-Z nostalgia trip back over the past year's pokes!

Here we gooooo.

KEY:

L - Infinite Lives
T - Disable Timer
N - Unlimited Energy

BATMAN

POKE 4806,173 - N
POKE 4866,173 - L
POKE 5060,173 - T

BATTLE VALLEY

POKE 16371,0 - L
SYS 25952

BLASTEROIDS

POKE 11571,173 - L

CABAL

POKE 9905,189 - L
SYS 2097

CAULDRON II

POKE 36152,255 - L
SYS 32777

CITADEL

POKE 12848,0 - L

COMMANDO

POKE 14631,0 - L
SYS 2128

CREATURES

POKE 754,173 - L
POKE 46888,173 - N

DARKSIDE

POKE 26272,173
POKE 29005,173 - T
SYS 39096

DROPZONE

POKE 3060,173 - L
SYS 2064

FIRST STRIKE

POKE 38316,173 - L
SYS 2051

GALAXI-BIRDS

POKE 1505,173 - L

GHOSTS 'N' GOBLINS

POKE 2175,255 - L
POKE 3901,0 - T
SYS 2128

GHOULS 'N' GHOSTS

POKE 11615,255 - L
POKE 13860,165 - T

GOLDEN AXE

POKE 13150,173 - N

GRYZOR

POKE 29187,189 - L

HAWKEYE

POKE 6105,173 - L
SYS 23558

INDIANA JONES & THE LAST CRUSADE

POKE 32552,173 - L

MENACE

POKE 8980,234
POKE 8981,234 - N
SYS 2080

MIDNIGHT RESISTANCE

POKE 10169,173 - L

MOTOR MANIA

POKE 8646,255 - L

SYS 8000

NINJA WARRIORS

POKE 2727,173 - T
POKE 15905,0 - N

NIPPER II

POKE 51114,173 - L

OPERATION WOLF

POKE 36007,165 - T
SYS 16960

PARALLAX

POKE 5796,96 - L

RED HEAT

POKE 3108,165 - L
POKE 3358,165 - N

RETROGRADE

POKE 50374,173 - N

RICK DANGEROUS

POKE 27931,173 - L
SYS 2057

RYGAR

POKE 9551,165 - L
POKE 4050,77
POKE 4055,77 - T
SYS 2325

SEUCK

POKE 19214,0 - L
SYS 16992

TIGER ROAD

POKE 5749,164 - L
SYS 14848

TIME MACHINE

POKE 31615,173 - L

TUSKER

POKE 35016,173 - L

XENON

POKE 26356,173 - L
SYS 20048

Ah, those were the days, eh? And if you readers don't wanna be reading nostalgia every month, get some hints 'n' tips to me NOW at: Slartibartfast, 4 O'Connor Drive, Bray Park, NSW 2484.

Entertainment Letters

ENTERTAINMENT MAILBOX
PO BOX 23,
MACLEAN NSW 2463

Flights of Fancy

Dear Phil, I read Mick Thompson's praise of *FA/18 Interceptor* in the October Entertainment Mailbox.

I agree. In fact, one evening a couple of months ago I was sitting in my favourite eatery reading one of the good British Amiga mags when I came across Electronic Arts address in England. So I wrote them a rambling letter in my illegible hand on the back of a menu telling them how great *FA/18* was, what was wrong with all the other air combat games and begging for a sequel with more missions.

I received the enclosed reply within a fortnight, telling me that Bob Dinnerman had moved on, but advising me of the imminent release of a new Amiga flight sim, *Birds of Prey*, with a choice of forty different aircraft and twelve mission types. Top marks to Electronic Arts for giving such prompt attention to a coffee stained epistle from the other side of the world! I'll certainly be watching out for the reviews of their new offering.

Peter Howard
Slade Point, Qld

Ed: Thanks for passing on the copy of EA's letter, Peter. *Birds of Prey* sounds impressive, but will it have the old "Bob Dinnerman magic"? What Electronic Arts didn't mention was that Bob has been hard at work at another company producing JETFIGHTER II for the world of PC compatibles - on a fast 386 with VGA graphics it's absolutely superb, with all the old magic of

FA/18 and a heap of exciting missions. In the mean time, EA's local office reports that *Birds of Prey* will be released in mid January.

Heaps of Hints

Dear Phil, I have four lever-arch files full of photocopied hints from the UK magazines. They're only filed alphabetically and I haven't listed or DB'd them etc but if you need something that you think you've seen then give me a call. I only get *Amiga Format*, *Amazing* and *Info* these days but there's all the *Amiga Computing*, *AUI* and a couple of others up to about a year ago, so if it's a golden oldie type hint I may have it!

Andy Dunn
9 Parkview Ave
Salisbury Downs, SA 5108

Ed: Thanks for the offer, Andy. I've taken the liberty of including your full address so interested readers can contact you direct. By the way, if anyone does write to Andy, make sure you include a stamped, self-addressed envelope.

Proud 64 Owner

Dear Phil, I'm a C64 owner and proud of it! I was wondering if there is a way of copying cassette games? If there is could you please tell me? Also, is there a way of getting into the listing of a game? Are there any cheats for *Wonder Boy*, *SDI*, *Star Wars* and *Turtles*? Before I go Phil could you please print this letter?

Philip Stevens
Melbourne, VIC

Ed: Yes, there is a way to copy games. No, I won't tell you. That would encourage you to make pirate copies. Yes, you can get into the machine code listing of a game with a suitable machine language monitor cartridge. But if you're expecting a simple BASIC-style listing, forget it!

There are cheats for the games you mentioned - maybe someone will send some in. And finally, yes, I will print your letter. But I'm blown if I know why.

Shorthand Ninja Fan

Dear Phil, Would like to know how to get past the fan in *Last Ninja 2* as I keep getting blown away. Also a poke or cheat for *Elite* game. Best mag in Aussie land, keep up the good work. Thanks.

Ainsley Travers
Parap, NT

Ed: Your letter looks like was written in hurry. Lots of words left out. Okay. Will ask readers for help in *Last Ninja 2* and *Elite*. Glad you like mag. Over and out.

Eye Problems

Dear Phil, Just recently I brought the new game *Eye of the Beholder* and have been doing extremely well in it until I got to the 7th level. In this level I've bribed the Drow but the problem is that I can't open the spider doors, can you please give me some help with this. If you can't help could you please pass it on to the Dungeon or Hints and Tips and Wonderful Bits in your great mag?

M. Gravatt,
Wyerba, QLD

Ed: Okay readers, can anyone help with a solution to this spidery problem? Let us know as soon as you can.

Happy New Reader

Dear Phil, I have read ACAR for only two issues (Sept and Oct '91). It may may not be as colourful as the European magazines and it may not review as many games but the reason I changed was the price. It is the cheapest computer magazine on the shelves! Maybe it is because of all the adds you have in the mag but I like reading them. Plus, I can enter the competitions and hope to win something, as the European mags are always three months late. The articles in your mag aren't just about games but about putting the Amiga to better use, things that bring out the REAL power of the Amiga.

To Philip Mayer who wishes to re-

main loyal to the humble C64, why are you seeing red because the C64 has a younger sister (brother) who is better than it? You must face the fact that the Amiga and CDTV are the future for Commodore. It is like a car - new, more powerful models are developed and you upgrade with them. If you want to stay

true to your origins then you will buy another Commodore. Eventually there will be no more software developed for the C64 and you will make the leap to Amigaland simply because an 8 bit computer is not enough. Companies are always out to make profits and the Amiga and CDTV are going to do that for

Commodore until the next new thing that will make money.

Peter Chun, Westmead, NSW

Ed: Glad you like the mag, Peter. And I agree totally with your analysis. Even so, we'll keep covering the C-64 as well as we can.

Hall of Fame

Send your authentic high scores to
Phil Campbell, PO Box 23
Maclean NSW 2463.

Please mark clearly whether your scores
are for C-64 or Amiga.

And remember
NO CHEAT MODES ALLOWED!

AMIGA

ACTION FIGHTER 132,530 Robbie Baker
ALERT 359,700 Robbie Baker
ARKANOID 1,052,610 Steven Walter
AMAZED 130,500 Chris Turnadge
BAAL 134,250 Davo
BATTLE COMMAND 334,200 Peter Cain
BATTLE SQUADRON 99,999,999 (c) Amos Burbidge
BEYOND ICE PAL 67,626 (c) Chris Turnadge
BIO CHALLENGE 29,000 Aaron Sanderson
BLOCKOUT 85,261 Stephen Lark
BOMB JACK 236,430 Steven Walter
BUBBLE + 276,850 (c) Chris Toyne
BUBBLE BOBBLE 2,124,640 Katrina Renzenbrink
BUGGY BOY 113,260 Powerhouse Nick
CAR-VUP 484,122 Happy Hacker
CHASE HQ 5,504,010 Angelo Augustis
CONT. CIRCUS 4,815,990 Dolly
CRAZY CARS 86,547,220(c) Adam Wade
CRAZY CARS CHALL 3,000,000,000 Michael Summers
CRYSTAL HAMMER 43,847 David Thompson
CYBERBALL 475,000 David Marsh
DENARIS 53,900 Peter Evans
DIABLO 1,490 Timothy Johnson
DRAGON NINJA 246,400 Rod Matthews
DOUBLE DRAGON 124,630 James Knight
DOUBLE DRAGON II 187,830(c) Damien Carsburg
EDD THE DUCK 5,820 Andrew Gormly
ELIMINATOR 246,570 Greg Munro
EMERALD MINE Level 23 (d) Timothy Johnson
FLOOD 6,455 Embah Beaton
GEE BEE AIR RALLY 307,466 Kamikaze Andy
GIANA SISTERS 56,567 Matthew Keath
GODS 3,779,072 (c) Natalie Buxton
GOLDEN AXE 44.5 Damien Carsburg
HYBRIS 1,826,075 Embah Beaton
IK+ 189,900 Damien Carsburg
IMPOSSIBLE MISSION 66,360 Diane Unwin
INDIANA JONES L.C. completed Phillip Nicoll
INDIANAPOLIS 500 38.53sec/233.58mph Dolly
INERTIA DRIVE 18,790 Timothy Johnson
KARATE KID II 54,000 Michael Summers
KLAX 4,396,040 Happy Hacker
LEATHERNECK 86,500 Shane Crosland
LIVE AND LET DIE 96,520 Merekee Beaton
MAJOR MOTION 50,658 Owen Webster

MENACE 996,481 Kamikaze Andy
MIDNIGHT RESISTANCE 302,550 Oopsl! Lost your name!
MINDWALKER 306,214 P Schumacher
MOUSETRAP 71,977 Davo Rich
NARC 180,800 Damien Carsburg
NINJA MISSION 35,141 Aaron Sanderson
NITRO 261,000 (c) Damien Carsburg
NUCLEAR WAR (c) Paul Rucci
N. Z. STORY 546,695 Embah Beaton
ONSLAUGHT 16,179 Andrew Gormly
OPERATION THUNDERBOLT 53,000 Andrew Gormly
OUTRUN 26,331,122(c) Benjamin Moen
OFFSHORE WARRIOR 626,345 Jacob Booth
PACMANIA 3,250,140(c) Amos Burbidge
PINBALL MAGIC 332,390 Tracey Chilcott
PINBALL WIZARD 1,029,360 Gordon Stone
PIONEER PLAGUE 35,412 Keir Sooby
PLUTOS 299,000 Davo
POPULOUS 347,990 Michael Summers
PORTS OF CALL \$3,654,944,000
Status 1033 Troy Clarke
POW 612,865 David Thompson
RAINBOW ISLANDS 9,999,999 (c) Timothy Johnson
RAMPAGE 504,175 G. Wilson
RICK DANGEROUS II 25,470 Andrew Gormly
ROBOCOP 375,520 Michael Summers
ROTOX 183,050(c) Faye Doherty
SIDEWINDER 904,350 Sharon Elsley-Eades
SILKWORM (Hell) 4,079,300 (c) Iceman
SILKWORM (Jeep) 622,500 Daniel Everton
SKWEEK 3,375,400 Faye Doherty
SPACE ACE 22,140 Neville Clarke
SPACE HARRIER 210,855,250 Maverick
SPEEDBALL 17,650 Amos Burbidge
STARWARS 5,722,622 C. Mingo wave 33
STRIDER 175,350 Neil Young
SUPER CARS 17 races Maverick
SUPER HANG-ON 25,042,850 David Worthy
SUPER OFF-ROAD \$350,000 Andrew Gormly
SUPER WONDER-BOY 87,190 Jason Stubbings
SWIV (HEL) 1,536,620(c) Michael Gane
SWIV (JEEP) 223,720 Damien Carsburg
SWORD OF SODAN 403,500 Steven Begley
TEEN.M.N.TURTLES 546,600(c) James Leeken
TEST DRIVE 131,076(c) Jordan Noglet
TEST DRIVE 2 659,992 Michael Summers
TETRIS 35,920 Michael Summers
TETRIS Level 232 Stephen Lark
THE RUNNING MAN 123,500 Daniel Rucci
THUNDERBLADE 336,520 Rod Matthews
THUNDERCATS 522,300 Scott Southurst
TOWER OF BABEL 25,934 (c) Stephen Lark
TURBO OUTFUN 100,260,819 Matthew Mantle
TURRICAN 1,735,100 (c) Adrian Jenkin
TURRICAN II 2,585,700 (c) Matthew Diggins
TV-SPORTS BASKETBALL 176-60 David McKinney
TV-SPORTS FOOTBALL 189-0 David McKinney
TWINWORLD 24,640 Carol Love
TYPHOON 54,255 Owen Webster
VIRUS 16,576 Michael Summers
WHIRLIGIG 28,210 Nathan Allen
WINGS 426 kills Jason Main
WONDER BOY 291,350 Maverick
XENON II 1,107,280(c) Mark Porta
ZOOM 67,051 Steve Jones

COMMODORE 64

ALLEY CAT 1,101,150 Simon Mitchell
ALTERED BEAST 251,250(c) Adam Blanch
ARKANOID 822,200 The Joker
BATMAN 473,230 John Nunes
BATMAN-THE MOVIE 1,087,080 Michael Bradley
BANGKOK KNIGHTS 39,600 Josh Smith
BLOCK OUT Level 6, 20,236 M Carter
BOMB JACK 521,820 Adam Wade
BUBBLE BOBBLE 6,963,930 (c) David Gavrilovic
BUGGY BOY(c) 153,000 Adam Wade
CABAL 175,600 The Joker
CHASE HQ 11,366,900(c) Happy Hacker
CHASE HQ II 29,100 (C) Adam Wade
DAVID'S MID MAGIC 669,150 The Joker
DOUBLE DRAGON 35,820 (c) Atul Prasad
DOUBLE DRAGON II 255,190 Nick van Heeswyk
DRAGON BREED 496,870 Happy Hacker
FAST BREAK 136 to 9 Chris Byrne
GHOSTS AND GOBLINS 325,600 Adam Wade
GHOULS AND GHOSTS 558,110 (c) Adam Wade
GIANA SISTERS 287,100(c) Adam Wade
GRYZOR 211,200 Giullian Aslett
H. MARADONA Level M N. van Heeswyk
HAWKEYE 207,650 Adam Wade
IKARI WARRIORS 308,300 Jason Aldridge
INT. KARATE 139,300 Paul Millward
LAST NINJA II 21m30s (c) David Carter
MIDNIGHT RESISTANCE 28,540 (c) Dennis Pike
NEMESIS 1,633,200 Adam Wade
OPERATION WOLF 776,350 Winston Diaz
OUTRUN 16,952,780(c) Adam Wade
PARADROID 32,250 Simon Mitchell
PAPERBOY 103,100(c) John Nunes
PIRATES 109/100 Adam Annen
POWERDRIFT 864,940(c) Adam Wade
QUE-DEX 639 Chris Byrne
R-TYPE 1,890,210 Atul Prasad
RAINBOW ISLANDS 2,233,820 Adam Wade
RAMPAGE 180,000 Adam Wade
RICK DANGEROUS 66,280 Adam Annen
ROBOCOP 237,170(c) Adam Wade
ROLLING THUNDER 417,280 Adam Wade
SALAMANDER 235,300 Paul Millward
SHINOBI 664,372(c) Winston Diaz
SILKWORM (Hell) 965,200 (c) Adam Blanch
SILKWORM (Jeep) 244,500 (c) Adam Blanch
SKATE OR DIE Freestyle 22,095 The Joker
STREET FIGHTER(c) 168,900 Adam Wade
SUPER CYCLE 223,040 Andrew Gormly
TARGET RENEGADE 330,450 C. Byrne (clocked)
TEST DRIVE 36,144(c) John Nunes
TEST DRIVE II 249,543 (c) A Batroc
TETRIS 25,706 (326 lines) A Batroc
THE TRAIN 9,500(c) Adam Annen
THUNDERBLADE 1,734,040 Troy Morrison
THUNDERCATS 269,500 Joseph Wright
T.M.N TURTLES 878 Adam Wade
TRAZ 54,560 Dave and Sue Upton
UNTOUCHABLES 70,230 Simon Watford
WIZBALL 607,420 (c) Simon Mitchell
WONDERBOY 560,320 Happy Hacker

Scores followed by (c) indicate that the
game has been completed.

GAME GUIDE - SPECIAL FEATURE

Shadow of The Beast

The Full Solution

The night is dark and stormy - and a beast is on the prowl! Can you stop him? Yes, if you follow these step by step instructions from GRAHAME WELSH.

You're frustrated and annoyed. After all, *Shadow of the Beast* is a great looking game - parallax scrolling, amazing graphics, great sound effects, and it cost you heaps of money.

But you just can't get past the first level - right?

Well, I'm here to help. Just follow these instructions exactly, and you'll make your way right through the game. You'll still need some skill, but with this guide you'll know exactly where to go and how to get there.

First, go left until you come to a tree. Two red arrows will appear - push up to enter.

Level 1: The Tree Complex

Go right until you come to a ladder leading down, go down it. Go left and down the next ladder. Go right and down the ladder. Go down the ladder just to the left. Go left across the bridge and go down the ladder. Go right, destroy the purple people with swords, then go down the ladder. You'll now find two ladders leading down. Take the left one. Go left until you find a demon holding a ball and breathing fire. Simply punch the ball until destroyed. Congratulations - you now have the power beam.

Go back up the ladder, then go down the right ladder. Go down the brown ladder just in front of you. Go left and down the ladder. Go left then, jump the gap and take the gold key. Go back to the brown ladder, go up, then up the other brown ladder, left and up the ladder, left and down the ladder. Now touch the device in the right hand corner, then go up the ladder and right until you come upon the creature with two

heads. Punch it a few times to kill it.

Still with us? Good. Now keep going right, cross the bridge, and be ready for the green men to attack. Take the ladder leading up. Go left and up the ladder, then left again, avoiding the row of moving eyes. You'll soon come to a gold key. Take it. Go right, down the ladder, right, down the ladder. Go right, up the ladder, kill the snail - sorry, there are no Defender pellets, you'll have to use something else!

Go right and down the ladder. Go left past the blue demons and red dragons, until you come to a ladder going down. Go down it. Go right, down a ladder, right, until you see a ladder going down - go down it.

Go right, down a ladder, left until you find the dead dragon head inside cage - go down the ladder just before it. Go left, down, left, then up the ladder, left, down the ladder, left, up the ladder. Go left until you find a flask surrounded by a barrier - touch it to obtain power punching.

Go right, down the ladder until it stops, right, past the pods with blue lights - ignore the ladder and continue right until the music changes and you meet a dinosaur. Just punch it - your power punch will automatically be used - until it is destroyed.

Go right, through the door, then climb the metal ladder in the well all the way to the top to finish the level. And that's level one completed!

Level 2. The Castle approach.

This level is fairly simple! Just keep going right destroying everything in your path and eventually you will come to the castle, but DON'T GO IN YET!

Keep going right until you come across a torch on the wall - take it by jumping in the air and touching it. Now go back to the door and push up to enter.

Level 3. The Castle.

Go left and up the first ladder you see - just to the left of where you start. Go right, down the ladder. Go right, up the long ladder. Go left, walk off the edge, keep going left, then up the ladder with the monster clinging to the wall. When you reach the top go right, destroying all the chests to gain more strength until you come to a spanner on the ground. Touch it to pick it up. Go left, past the ladder leading down, and continue left past the table. Go down the ladder near the wall. Go right, then down the ladder. Go right, walk off the ledge, left, and off the next ledge. Now go left, cross the bridge with two spiders hanging from the roof, then down the ladder. Go right, and down the ladder. Then go left until you come to a chest. Smash it open to get the laser gun.

Go right until you come to a panel controlling an impassible electric field. Walk up to the panel, pull down on the joystick and press the button. This will activate the use of your spanner, turning off the electric field.

Go up the ladder. Go left, off the ledge, left and up the ladder. Now go right, and down the ladder. Go left, down the ladder, then right until you meet a three headed dragon. Shoot it with the laser a few times and it will die. Go right until you come to the open door and a mask on the floor. Touch it to pick it up. That's level three completed.

Level 4. Shadow Lord's Lair

This one's extremely simple! Just keep flying right until you come to the end of level guardian. Blow the hell out of him.

Level 5. Beast Lord's Encounter

Much too easy! Once again, just keep running right until you come to the Beast Lord himself. To beat him, just keep punching him in the foot and he will eventually die.

Enjoy the ending picture. Congratulations - you've made it.

Utopia

Feel like some pioneering? Phil Campbell takes on the challenge of building a whole new world - Utopia.

"In Xanadu did Kubla Khan a stately pleasure dome decree, where Alph, the sacred river, ran, Through Caverns measureless to man." Yes folks, some genuine culture. The opening lines of Coleridge's Kubla Khan, as he dreams the impossible dream of heaven on earth. Paradise. Utopia. He wrote the poem some time last century, and in the intervening years we haven't really got much closer. Technology, yes. But Utopia? No.

Here's your chance to do better. It's *Utopia*, a great new game that lets you build the perfect world from the ground up. In many ways, *Utopia* out-sims *Sim City* - the aim of both games is similar, and so is the method. But *Utopia* features a classy 3-D view of your simulated world and it's eye-poppingly detailed space age buildings.

You are Commander Pacharelli, Leader of the colonisation of the Omicron-Kappa planets orbiting the Rhebus sun. What the colony will become is entirely in your hands. You control the economy, you control the building program, you control the colony's industry and defence programs. In essence, for the group of four hundred men and women who arrive at Omicron-Kappa with you, you control the quality of life.

Will you succeed in building Utopia? Or a second rate hell-hole in the back blocks of the galaxy? It's up to you.

Your screen displays a small slice of the planet's surface in isometric perspective. There are already three or four buildings, including a large control centre, an oxygen-generating life support plant, living quarters and a hydroponic garden - the bare essentials for life on a hostile planet. The section you can see seems to be hovering in space. Beside it, there's a cluster of four arrows, and a



panel of control icons. The arrows let you scroll around the area allocated for your settlement, and the icons control the game.

Your budget at the start of the game is 500,000 credits, and the first thing you need to do is build. Click on the "building" icon and a selection screen appears - row after row of colourful buildings to choose from, including hospitals, multi-level dormitory blocks, oxygen plants, chemical factories, mines, power stations, flux-pods, laser turrets, and space ports.

Before you start building, there are some practical rules. Flux pods act as energy storage centres, and all buildings must be erected within twelve squares of a pod. Plan where you put them carefully. Naturally, you'll need at least one power station to feed the pods and the surrounding buildings. The Chemical plant extracts fuel from the ground and pumps it to Fuel storage tanks. But before you build your Chemical plant, you'll need to choose the best location. Area maps show location of mineral and fuel deposits, so make sure you consult them first.

You won't really need a Security Office until your population grows bigger. Nor a laser turret or missile base - you're not likely to be attacked by alien forces until your colony is well established. Even so, forewarned is forearmed.

Okay, let's build. I choose a hospital from the selector panel, then point and click on the screen to indicate where it should be built. Everything is mouse controlled, and works smoothly. Rome, however, was not built in a day, and

neither are hospitals on far flung planets. First, a scaffold appears. The building doesn't appear for a number of months, as measured by the on-screen clock - in real time, it's a matter of minutes.

Naturally, hospitals don't work without staff. And that's your next decision. How many colonists will you allocate to work in the hospital? Aim for a workable balance, because labour is in short supply, and you'll need workers for the Chemical plant and other industries. If you play your cards right, your colony will soon have a thriving economy.

Utopia is a great game. All the simplicity and charm of *Sim City*, with prettier graphics. I'm not sure yet whether it has the same depth and long term appeal - time will tell. But at this stage, it's fascinating. Your space colony simply bustles with energy, full of colour and tiny detail.

Soon there will be space cruisers hovering around the skies, tanks trundling around the ground, lights flickering on and off and radar dishes scanning back and forth across the skies - a living, breathing city. Is it Utopia? Not quite - the quality of life rating in my little city is currently running at 78%. But I'm working on it.

RATINGS

Graphics: 86%

Sound: 75%

Gameplay: 92%

Overall: 89%

Distributed by Mindscape

(02) 899 2277

RRP Amiga \$79.95

Jimmy White's Whirlwind Snooker

There's nothing more relaxing than a nice game of snooker. That is, unless you always lose, says Phil Campbell.

A game of snooker at my mate Al's place always has the same result. He wins. I lose. Regular as clockwork. Naturally, I put it down to his mis-spent youth - too much time hanging around seedy pool-halls. Or maybe he practises a lot. Who knows?

So I figure it's time I polished up my game.

Jimmy White's Whirlwind Snooker is the perfect way to do it. It's an Amiga simulation, billed as "the fastest, smoothest snooker game ever created".

Snooker-sims are by no means new. The equations that govern the game are the stuff of high school physics text books, and the graphics are simple - all you need is a bunch of coloured balls. So it's no surprise that the software remnant bins are littered with relics.

Jimmy White's Whirlwind Snooker is different - I promise. Programmer Archer Maclean has produced a simulation that really feels real. A few zany touches - like balls that spring to life and poke out their tongues - add a touch of spice that makes this game stand out from the crowd.

The game opens to a rousing piano rendition of a Scott Joplin rag - perfect music for a pool hall. You can choose to play a friend, or one of three computerised opponents, Tom, Dick and Harry. When you've paid your dues you can challenge the great Jimmy White, currently holding third position in the World Snooker rankings. White is fast, accurate and very popular, a crowd favourite since winning the English Amateur Championship in 1979 at the record age of 16 years.

So let's play ball. It's my break. As in the real world, the gaps between the balls in the frame are minutely different

every time, so the results of the break are unpredictable. I simply close my eyes and hit as hard as I can. Balls spray everywhere, with a satisfying cascade of clickety-clicks. So far, so good.

Cue action is mouse controlled, with a series of icons arranged across the top of the screen.

From here you can set top spin and side spin, select the power of your shot, adjust your aim, change your point of view, and even chalk your cue. Here's a hint - if you forget the chalk, attempts to curve the ball will be embarrassing.

The screen display is dynamic, with fast changing views from every possible angle. It's hard to describe, but for the moment, imagine a camera attached to the end of your cue. With the camera "focused" on the cue ball in the centre of the screen, a click on the mouse button will effectively rotate the view of the

table around the ball. Confusing at first, but after one or two games you will realise it's a fast and intuitive way to move around the table and set up shots.

In the end, the proof of the pudding is in the eating. And the fact is, I make exactly the same mistakes playing *Whirlwind Snooker* as I do in the real life game. The brown ball is sitting right in front of the corner pocket. Unmissable. But I miss. My long shots down the table are even worse. And I never can quite judge the angle for that fine cut into the centre pocket. Just like at Al's place - which means, of course, that *Jimmy White's Whirlwind Snooker* is a very accurate simulation. This is a game that not only sticks to the rules of real world snooker - it follows the laws of physics to the letter. It's fun to play, impossible to master, and takes up very little space in your lounge room. All in all, a top class game.

ACAR STAR RATINGS

Graphics: 92%

Sound: 88%

Gameplay: 94%

Overall: 93%

An almost-perfect simulation.

Distributed by Mindscape

(02) 899 2277

RRP Amiga \$79.95

Not available for C64



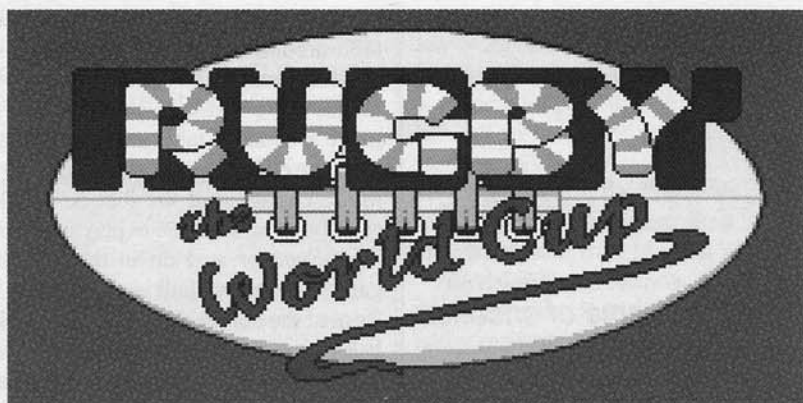

The Rugby World Cup has come and gone. But it's certainly not forgotten. Relive Australia's glorious victory with Phill Campbell.

These days, Australia's moments of sporting glory are few and far between. The Rugby World Cup victory over England was a welcome exception. But let me warn you, playing Rugby can be hazardous to your health. Just ask Nick Farr-Jones about his knee injury in the quarter-final. Or ask me.

My arm is sore, my elbow is stiff, there's a dull ache in my shoulder. And they're all from playing Rugby The World Cup. An Amiga sporting simulation, this game has been at the top of the European game charts for weeks, capitalising on World Cup fever. Now it's here - a whole month after the final, but better late than never.

Let me confess. I'm not really the Rucker type. After all, this is a game for gentlemen - guys with the style and poise of a Nick Farr-Jones or a David Campese. During the World Cup I have had to learn the technicalities of the game from my wife, who was raised in a family of some refinement.

Tackling I understand. And passing seems sensible. But I can't fathom all the excitement about kicking to touch - and the interminable scrums and line-outs leave me cold.

Rugby - The World Cup has got the lot. Even better, it's got a booklet full of good, clear instructions that make the game make sense. Add the fact that you can play against either the computer or a friend in either a single game or the whole World Cup competition and you've got the makings of a well rounded package.

The screen shows a view from above the field. You can only see a small section at a time, with the view scrolling smoothly back and forth with the action. A small "overview" diagram overlaid on the top corner of the screen shows the whole field, with players appearing as colour coded dots.

After the kick off, it's a free for all. Players scramble everywhere, though if you look closely you'll notice one has a small black bar above his head. He's your man. Waggle the joystick and you'll see him move around in response. With a little luck he may even come up with the ball - and from there on in it's a matter of ball skills and good management.

My first few moments were glorious. My player grabbed the ball, and we set off down the field at top speed, evading the English forwards easily. Near the tryline, I pressed my fire button to offload

the ball - it was picked up perfectly by another player, whom I then pushed neatly across the line. Beginner's luck.

My conversion was good too - the screen shows a side-on view, with the player in the foreground and the goal posts in the distance. A cross hair darts back and forth across the screen, and the trick is to press the fire-button in the split second that it spends between the posts. Tricky, but I managed it. That's the good news. But what about the scrums? Let me quote from the manual.

"Once a scrum has been entered, move the joystick left and right as fast as possible to win control of the scrum. The ball is then passed out to the scrum half." Easy? No way. Fortunately, my joystick is substantial - a Star-Cursor, with industrial strength micro-switches. My arms, however, are not. Sure, I won a couple of scrums. But more often than not even my best efforts saw my team pushed aside by the opposition. How much high speed wiggle-waggle do they think I can take?

If you've still got a passion for Rugby after countless late night hours in front of the telly, check it out. As for me, I'm retiring hurt at half-time.

Ratings

Graphics: 76%
Sound: 78%
Gameplay: 73%
Overall: 75%

Distributed by Questor
(02) 662 7944
RRP Amiga \$69.95
C64 \$49.95

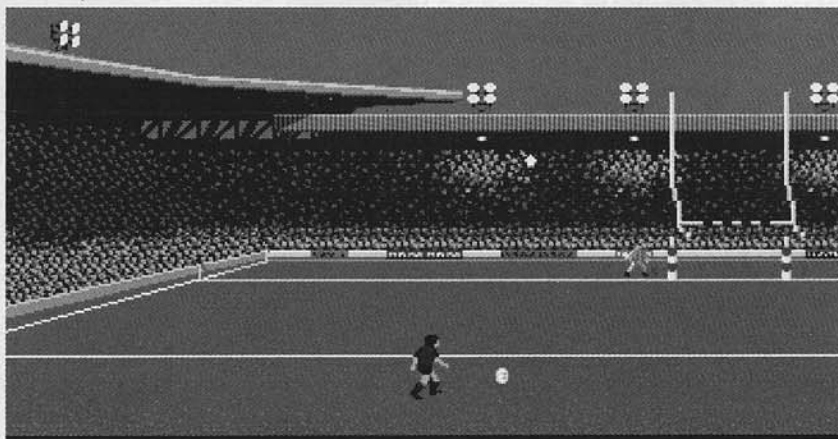

Star Goose

I guess you could call me a Space Veteran. Ten years service, fighting off countless hordes of aliens. Been there, done that. Along the way, though, there have been some particularly memorable campaigns.

Star Goose was one of them. And now the game has been re-released in the Pactronics budget line-up.

In the game you play the part of a space mercenary, scouring the surface of long forgotten planets looking for rare jewels. Your ship is a Star Goose class fighter - an unusual machine, the Star Goose never gets far off the ground. Its bulbous hull hovers just above the surface, the control pod protruding from the front like a gooseneck. Not elegant, perhaps, but easy to manoeuvre, and fast.

This time, we're on the Supply Rings of Nom. No place for a family holiday, this is a synthetic, welded landscape covered with metallic hills, valleys and channels. Rotating gun turrets are everywhere, spitting bullets and armour piercing missiles at an alarming rate. But the huge, coloured jewels you can find here are famed around the universe.

Every so often I find a refueling



depot. The Nommans certainly have style. Not for them the fuel pump at the local Ampol service station - instead, I have to fly through a tunnel collecting huge fuel pods shaped like eyeballs. Eerie. And its the same if I need more ammunition, or if I want to replenish my shields.

Star Goose is a captivating game. Not unique, by any means - it falls neatly into the category of "vertically scrolling shoot-'em-up" - but rich in detail, and brilliant in execution.

Graphics are finely detailed, and they have an unusual "cuteness". The alien ships are just as radical in design as the

Star Goose - one variety looks just like a bloated budgie.

And the eyeballs in the refuelling tunnels? Absolutely the best eyeballs I've ever seen in a computer game. They glisten, they stare, and they give menacing looks, all in such rich 3-D shading that you feel like sitting back a little and catching them as they pop through your screen.

Sound effects are run-of-the-mill. There is only so much you can do with a game like this, and it has all been done. The explosions erupt nicely, the engines roar convincingly, and everything else sounds just as you would expect. Satisfactory, of course, but not as novel as the visual effects.

The game is fun to play, and quite addictive. I liked it the first time round, and I like it as a budget priced re-release.

QUICKSHOT RATINGS

Graphics: 78%

Sound: 71%

Gameplay: 79%

Overall: 77%

Distributed by Pactronics

(02) 748 4700

Budget Series

RRP Amiga \$12.95

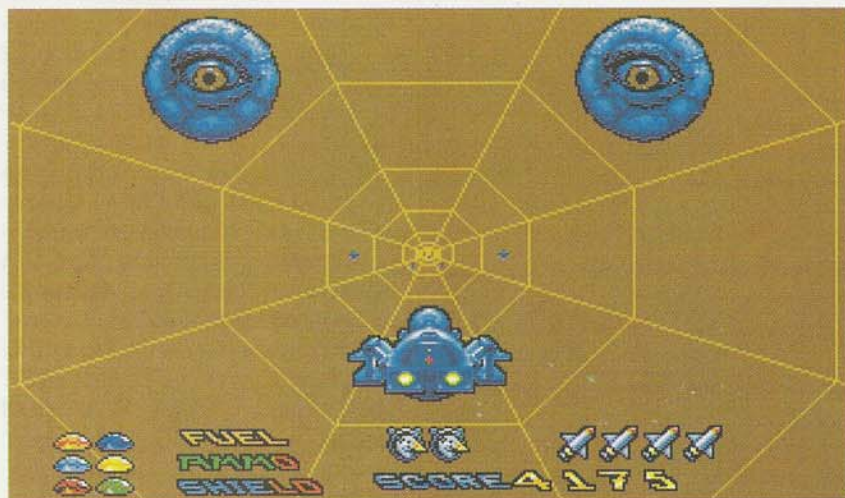

Maupiti Island

Michael Spiteri has been waiting for this one, and it's just as good as he expected.

Jerome Lange returns to solve another engrossing mystery, this time on a tropical island. Some of you may be already familiar with the French private eye's previous case in *Mortville Manor* (Realm's Adventure Game of the Year in 1990), in which he had to quiz the inhabitants of an old mansion about the death of a friend.

In this game, we are not sure if the victim is dead or not (she might die in the course of the game - if you don't hurry up and do something!).

The story so far goes something like this.

The year is 1954, January. Jerome is in Madagascar visiting an old friend when he receives a letter from Max (the *Mortville* butler maybe?) in Japan ("Come and join me!" it says).

So, Jerome borrows his friend's yacht and sets sail with two crew members (Captain Bob and seaman Anton). They get as far as the Indian Ocean, but decide to take refuge on a remote island called Maupiti, as they fear a hurricane is near.

The hurricane passes.

Meanwhile, a fishing boat (containing captain Bruce, seamen Roy and Chris) arrives at Maupiti during the night, and parks itself next to the yacht. The following morning, Madame Maguy (owner of a small hotel on the island) informs Jerome that a young girl named Marie was kidnapped the previous night. So begins the quest - to rescue Marie!

Add Madame Maguy's three employees (Sue, Anita, and Juste the handyman), and we have a nice long list of possible suspects. It doesn't take long to scan the immediate areas (the beaches, garden, pond, and hotel), and after some quick interviews with a few of the characters, all sorts of rumours, stories and predictions fly around!

Sue and Anita are best friends and tell each other everything, or do they? Anita had a fight with husband Bob on the night of the kidnapping - was it over Marie? Is it true that Maguy is a madame in the literal sense, and that Marie maybe was a reluctant employee? What is the significance of the statue in the

pond? Why do certain inhabitants have masks in their rooms?

These are just a few of the many, many questions you will ask when you play this engrossing adventure.

Maupiti Island has all the features that made *Mortville Manor* such a good game. These include great graphics (improved!) and super sound effects to really build up a haunting atmosphere.

On screen animation is also good, especially the attention to detail (such as the fly buzzing around the room, the ceiling fan spinning, mice and rats scurrying across the ground).

The background music changes from place to place, and also changes if you complete a major action.

Character interaction has been greatly enhanced since the days of *Mortville Manor*. The speech synthesis is still there (French accent and all!), and the spoken words appear on the screen if you didn't catch what was said (or you can repeat it). As well as quizzing a character about certain events you have encountered, and other people, you can memorize what was said, and use it to quiz and argue with other characters when contradictions arise.

You can also bribe, bash up or offer objects if all else fails. This gives you almost complete realistic detective interaction.

The game is completely mouse driven, with pull down menus used to move around, manipulate your inventory, execute actions (select an action then point the pointer somewhere on the screen), and interact with characters.

You can also follow characters (but tread carefully, it's egg on your face if you get caught!). A map of the island appears when following characters. Actions available are somewhat limited, but adequate (close, eat, look at,



observe, search, open, push, put, raise, read, sleep, smell, sound, take, turn, wait).

The playability factor is very high. There are many things that can be opened and closed (remember - be discreet!), and hundreds of items to sift through (many red herrings!). All items when handled are displayed in the bottom right corner of the screen.

Also displayed is a clock, and a list of characters present. Your energy also appears, and this will deteriorate without sufficient food or rest. The game can end quite abruptly if you're not careful. You can die in quicksand, you can get locked in your own cabin, and you can get murdered if you get too close to solving the mystery without being discreet!!

This said, there are also many possible endings, and there is a random element in the game to add that extra level of difficulty.

The game however, does have some niggling technical drawbacks. The main one is that it takes a bit too long to load up characters for interviewing, and this tends to slow the game. It doesn't look like the game is installable on a hard drive, either.

Overall the graphics are crisp and colourful, and the sound is melodramatic and convincing. The plot is intriguing and very challenging, with riddles and puzzles everywhere!

Gameplay is also very good. As an adventure, I rate it as one of the best releases this year - but I am biased towards it because I liked *Mortville Manor* so much (and *Maupiti Island* is much better!).

Atmosphere: 95%
Graphics: 87%
Sound: 87%
Playability: 88%
Plot: 95%
Lasting Appeal: 85%
Overall: 89%
Verdict: Compelling stuff!
Recommended!

Distributed by Pactronics
(02) 748 4700
RRP Amiga \$49.95



**So cute it'll make you puke.
That's the delightful promise of Rodland, a saccharine
sweet platform game about a cute little fairy princess
searching for her "Mom" who's been trapped in the castle
of a nasty ol' boogey man.**

The colours are bright, the music is breezy - and the gameplay is absolutely addictive. Aaargh!

Once you start playing you just can't stop, and it's incredibly embarrassing if someone comes into the room. Rodland just isn't macho!

Mind you, there is a bit of violence. Your princess makes good use of her little magic wand, the "Rod of Sheesanomo." As she meanders along the platforms and glides up and down the ladders she meets up with all manner of nasties - a good wallop with the wand, and a left and right thrust on the joystick send even the meanest of them crashing over her head in a judo throw that even Big Arnie would be proud of.

Watch out for the sharks though - they look faintly ridiculous cruising around the platforms, but don't be distracted. Let them get too close and little princess will waft away in a cloud of vapour.

There are bonuses to collect, and flowers to collect through 40 rather awkward levels.

There are time limits, too - if you don't clear a level in time, the nastys switch into "meany mode" making things even more difficult.

The fact is, Rodland is a darn good game. Graphics are delightful, with a nice variety of backgrounds, and plenty of awkward platform patterns. The princess and the nasties are nicely drawn, and everything works together well.

Just make sure you keep a barf-bag handy, though - puking on the keyboard is not recommended.

QUICKSHOT RATINGS

Graphics: 84%
Sound: 81%
Gameplay: 87%
Overall: 86%

Distributed by
Mindscape (02) 899 2277
RRP:
Amiga \$69.95
C64 Disk \$49.95
Cassette \$39.95



MICHAEL SPITERI'S

Adventurer's Realm

by Michael Spiteri

Merry Christmas!

Welcome everyone, to the world of Adventurer's Realm, the only computer column in Australia dedicated to serving the adventurers and role players. If you're stuck in any adventure game, send a stamped self addressed envelope for one of our free hint sheets, or if that doesn't help, send in your problem to:

Adventurers Realm 12 Bridle Place Pakenham Vic 3810.

I'm also interested in your views and rumours concerning adventure games, plus any hints and tips you have available to contribute.

If role playing games are your arena (*Pool of Radiancy*, *Eye of the Beholder*, etc), then role-playing-game freako Kamikaze Andy is available in his Dungeon to answer your queries.

Write to him (but don't ask him for hint sheets) at:

Realm's Dungeon P.O. Box 315 Maddington WA 6109.

Whenever you write to the Realm, and expect a reply, you must enclose a stamped addressed envelope (requests for hint sheets without these will be ignored).

You may pick up to four different hint sheets. Just send a stamped addressed envelope to: Free Hint Sheets 12 Bridle Place Pakenham Vic 3810.

Hint sheets available:

Zak McCracken, Maniac Mansion, Indy, Zork 1, Zork 2, Zork 3, Bards Tale I, Bards Tale II, Bards Tale III, Guild of Thieves, Jinxter, Pawn, Fish, Uninvited, Deja Vu, Hampstead, Hitchhikers Guide, Faery Tale, Borrowed Time, Never Ending Story, Dracula Pt 2, Hobbit, Adventureland, + Clever Contact Complete Listing.

Free Hint Sheets

Official Adventurers Realm Hint Books

The first *Official Adventurers Realm Hint Book* is still available, containing detailed hints and tips for over 40 adventure games. A bargain at only \$9.00 from newsagents across the nation.

Keep your eyes open for the second *Official Adventurers Realm Hint Book*, containing hint and tips for a newer range of adventure and role-playing-games. Available shortly!

Realm's Nostalgia Competition Official Results

What are the Top 5 All Time Classic Adventure Games as voted by readers of the Realm? Well, here they are:

1. *Zork I* (Infocom)
2. *The Pawn* (Magnetic Scrolls)
3. *Hitchhikers Guide to the Galaxy* (Infocom)
4. *The Hobbit* (Melbourne House)
5. *Leather Goddesses of Phobos* (Infocom)

The Winners:

Leanne Hood, Deeragun, QLD (C64 Adventure Game Pack - Scott Adams Adventure 1 - 12)

Shane Robertson, Toukly, NSW (C64 Adventure Infocom Classics *Zork II & Zork III*)

Andrew Gormly, Walkerville, SA (Amiga Arcade/Adventure *Weird Dreams*)

Samantha Hayhoe, Port Augusta, SA (C64 Adventure Game Pack *Wolfman/Frankenstein/Dracula*)

Runners up:

Jenny Lam of Arncliffe in NSW and Nigel Cayzer of Grafton in NSW both win a copy of the first *Official Adventurers Realm Hint Book*.

Realm's Chit Chat

D.M. Stacey of S.A writes... "I am an on/off reader of Adventurer's Realm but take great interest in the general chit chat and game problems. One thing that disappoints me is that you do not have any hint sheets for AD&D games."

MS: *There are quite a few games in the AD&D series, however your request has been taken in, and I'll try and include a few AD&D games in the list. First one to appear will be Pools of Radiance, hopefully available next issue.*

David Lear of Flagstaff Hill, S.A writes.... "I would like to thank you for the Clever Contacts section. I have had occasion to use the services of a few of them and have always received quick helpful advice."

MS: *Another pat on the back to all the unpaid Clever Contacts across the nation who are doing a tremendous job ... keep up the great work!*

A list of Clever Contacts is available from the the Realm.

Simon Parker of Bayswater, Vic, writes.... "I would like to say that I agree wholeheartedly with the review of *Bards Tale III* (by Andy Phang) in the July edition of ACAR. I too waited in anticipation for the day the program would appear on the Amiga, after spending countless enjoyable hours playing *Bards Tale I* and *II*. And I also felt very disappointed when I ran the game. It is slow, clumsy, and doesn't have a very good feel at all. But, having bought the game, I suppose I will just have to finish it anyway. I mean, it is a *Bards Tale* after all. I have just lost a lot of enthusiasm for the game."

MS: *It's unusual in the computer entertainment industry for sequels to be let down (especially on the Amiga!). Still, maybe the next addition to the *Bards Tale* series will fix up some of the many problems of the third edition.*

David Couche of St Agnes writes.... "Just thought I'd let you know that the swapping of old games has got off to a good start. Michael Walsh of Horsham (another of your regular readers) and I have swapped *The Pawn for Lurking Horror*."

MS: *Great news! If you have any old adventure games which are no longer available, and you'd like to swap them for other old adventure games, send your request to the Realm!*

Scott Saunders has the original *Wheels of Fire* compilation pack (Amiga), and he is willing to swap this pack for an original version of *TV Sports Football*. Scott's address is 9 Breakspear Street, Gracemere, QLD 4702.

MS: *Ehh, since this is the only place where you can swap games, we'll let these arcade ones skip through. Phil Campbell...if you are listening, can you include a Swap Games in your entertainment section for those who prefer wasting time playing arcade style games? (PC: No, I'm happy to leave it to you!)*

Aaron Upcroft of 24 Ryan St, Balgownie NSW 2519, writes... "I have a C64 and I desperately want adventure games. I cannot find any shops that supply adventure games, and the ones that do have none for the C64. Could you please put me in touch with shops that you know of that have adventure games for the C64?"

MS: *I'm afraid it's true, C64 adventure games are slowly beginning to disappear. There are a few advertisers in this issue that stock C64 games. Could someone please write to Aaron with some spots to find software?*

Clever Contacts

Three new clever contacts this month:

Felicia Holmes of 23 Parmelia Way, Craigee, WA 6025. Felicia can offer help in: *Champions of Krynn, Death Knights of Krynn, Heroes of the Lance, Zak McKracken, Faery Tale, Kings Quest II, III, Police Quest I, II, Space Quest III, and Quest for Glory I and II.*

PD Guru's Public Domain Software for your Amiga
We sell only high quality programs for \$3 a disk and \$12 a disk pack (5 disks)
For our disk catalogue, which also contains several programs and utilities, send \$2 to:
Justin Rumpff,
26 Ovens St, Wangarata Vic 3677

Paul Andrews of 10 Sovereign Street, Hallett Cover, SA 5158 can offer help in: *Bastow Manor, Island of Spies, Cavern Adventure, Temple Curse, Murder of the Waterfront.*

Peter Georges of 34 Arundal Park Drive, St Clair, NSW 2759 has a collection of hints and tips printed in almost every magazine over the last five years (Amiga, C64, ST).

MS: *I have seen some of Peter's tips....and he has heaps. Peter is also an international clever contact for top UK magazine THE ONE for AMIGA.*

Also, David Stacey of 3 Tigree Drive, Hallett Cove, SA 5158 has maps for *Bards Tale 2, 3, Pool of Radiance*, as well as interesting hints and tips. David also has hints and tips for *The Story of the United Seas*, and is willing to give copies to those who write to him with a stamped addressed envelope.

Stop press: David has just sent me a huge list of all the games he can help in (not just adventures - even Nintendo Gameboy games!).

Always enclose a stamped addressed envelope when writing to a clever contact. (Donations wouldn't go astray either!)

Hot Adventure News

Infocom has come back from the dead! In the September issue, we told adventurers that "you aint seen nothing yet". Well, just when you thought that Infocom were dead and buried, everybody can now get excited over two exciting new releases.

First up is *Leather Goddesses of Phobos 2: The Gas Pump Girls*. This is a graphic adventure (also available on CDTV) featuring animation galore. The game is set in a small '50's American town terrorised by meteorites and an

Anyone out there into MIDI based music on the Amiga?
Swap questions and answers with
Jim Harford,
28 Forest Court,
Yandina, 4561
Ph (074) 46 8362

alien invader. Only the military and a group of attractive gas pump girls can save the day! Written by Steve Meretsky. (Thanks to Stuart George of Springvale, Vic for that info).

The other hot Infocom release which is in the shops now is *Circuits Edge* - an adult murder mystery set in the 23rd century. The game boasts a substantial amount of graphics and character interaction. Both products are released under the Infocom/Activision label.

Stuart George also reports that Mastertronic in the UK have released the first ten Infocom classics at a ridiculous low price.

The Adventures of Willy Beamish is an exciting new game from Sierra featuring super cartoon animation. Ask for a demo now....you'll be amazed!

Distributed by Ozisoft for the Amiga, Amiga CDTV, and IBM.

(Editor's Note: Ozisoft only seem to be aware of the IBM version at this stage, with no news at all of a CDTV version!)

Sierra are about to release what could be the first Green game ever, with the imminent release of *Eco Quest*, an environmental adventure in which the player (12 year old Adam) and his pet dolphin battle the terrors of toxic wastes, oil spills, fish nets and a multitude of other frighteningly dangerous environment hazards. Distributed by Ozisoft.

Also from Ozisoft is *Space Quest IV* available this month for the Amiga. Also released is *Police Quest III*. Meanwhile, watch out for full reviews of

Kings Quest V, *Space Quest IV*, and *Leisure Suit Larry V* in future Realms. (Kamikaze Andy has reports of the new Larry adventure in his Dungeon).

Access Software have released a hot new mystery called *Martian Memorandum*. Advertised as a Multimedia Entertainment Product, and a real interactive mystery. Available in the stores now.

The Terminator and *Terminator II* are also two hot new adventure/arcade releases that should be tried out. Both feature fantastic 3D graphics.

Yes folks, with news of Infocom/Activision alive and well, and hot release of games from Sierra, the adventure market is more alive than it has ever been!

Problems, Problems & more Problems or the Troubled Adventurers Dept.

Letters have been pouring into the Realm the last couple of months, and I apologise for any delays. The demand for the Clever Contact hint sheet has been overwhelming, so please be patient and I try to replenish supplies.

The following adventurers would really love some answers to their many problems. If you can help, please write quickly!

Aaron Upcroft is stuck in *Shadows of Mordor*. Aaron writes....."In my time I have played many adventures, and I find that *The Shadows of Mordor* is the ugliest adventure game ever. I find it totally user-unfriendly!

"I have successfully built the raft in the right place (northern edge of river) and 'poled' the raft across to the southern edge. I find, however, that at one place with flickering points of light (which kills me) I am in exactly the same place as I was before I crossed the river! What do I do??"

MS: Aaron would also like to know

if *Smeagol* is of any use. He also adds that *POLERAFT* is the most ridiculous command he has ever encountered!

Stuart George, helper of many, but also stuck in many, needs help in some old Scott Adams games.

In *Fantastic Four*, he can't get THING out of the pit without drowning him or the human torch.

Then in *Buckaroo Banzai*, he cannot find the Bauxite to make jet fuel, and he doesn't know how to climb the mountain.

Finally, in *Sorcerer of Claymorgue Castle*, he has managed to get the towel from the moat and enter the castle, but what does he do next?

MS: Stuart doesn't believe in playing one game at a time - it's one form of masochistic self-torture!

Raymond Huntley is having trouble in *Eye of the Beholder*. He cannot get the ladder to Level 3 as the passage 3 squares to the north of ladder 1 is blocked. Any help would be greatly appreciated.

Tony Finn of Wagga Wagga in NSW is currently playing *Deja Vu II*. He cannot seem to win enough money at the casino to buy the \$20.00 train ticket to Chicago. He also cannot enter the laundry building (two goons shoot him when he uses the bin to enter!).

Another chap stuck in *Deja Vu II* is

Dale Priem of Jannali in NSW. He has got the secret letter from the vacuum cleaner, and has got into the city morgue, but doesn't know what to do next!

C. Wilson of Oatley in NSW is stuck in *AD&D Hillsfar*. Finding Dalma to give her the sword is this adventurers problem. Any takers?

D.C. Hoggard of Muswellbrook is having a nightmare playing *Personal Nightmare*, and that's not from the scary bits! How does he open the boot of the car in Peter Mason's garage? How does he get out of the Mason's house when Susan comes out in the mornings? How does he stay out of jail? How does he avoid being burnt by the acolytes (?), how does he get upstairs in the burnt out manor? And finally, how can he stay alive long enough to finish this game! A *Personal Nightmare* indeed!

Felicia Holmes is currently stuck in *The Jetsons*. She cannot find enough money to buy transport to go investigating on the planet. Also, in *Legend of the Sword II - The Final Battle*, Felicia cannot get the blue crystal and cannot enter the cave where unseen horrors come out at you.

Finally, Lisa Middleton of St Marys in NSW is stuck half way in *Asylum*. Any help in this very urgent problem would be appreciated!

The Dungeon by Kamikaze Andy

In the hot Australian summer there won't be much sense singing "Winter Wonderland" or "White Christmas", but the annual festive season brings great tidings to Amiga adventurers and role-players. So let the celebrations begin!

Leisure Suit Larry V

Leisure Suit Larry V: Passionate Patti Does A Little Undercover Work is due to be the next Sierra graphic adventure to hit the Amiga shelves, and let me tell you that the graphics totally outshine any previous Sierra products!

This time designer Al Lowe has opted for a more "cartoony" look (and feel!) for Larry, so don't expect any super-realistic close-up shots of gorgeous babes. The humour, while still mostly sexual in nature, is more subtle and "mature", if such a thing is possible. The music and sound effects are also outstanding. Experienced adventurers should be warned, though: *Larry V* is definitely a "beginner's level" product in terms of puzzles.

Sierra seems to have continued its recent trend of emphasizing on the graphics and sound rather than on puzzles or story, so if you're a seasoned adventurer you'll probably find the game quite easy to complete.

Fans of *Rise of the Dragon* (from Sierra affiliate Dynamix) will be pleased to know that another Blade Hunter adventure is due in a couple of months' time. Now that they've got the Amiga program engine all sorted out, games that use the "point and click" interface from both Sierra and Dynamix should appear at a more regular rate.

It's also reported that Sierra managed to get a 256 colour version of *King's Quest V* on the Amiga up and running, but opted to release the (very good, I must admit!) 32 colour version because the 256 colour version was simply too slow. Maybe *King's Quest VI* (and there WILL be another sequel, which is good or bad news depending on your tastes) will use HAM mode?

Mega Traveller

As mentioned last month, the Amiga conversion of *MegaTraveller 2* is making its way to the stores. Publishers Paragon are really cashing in on the RPG license, though, because *MegaTraveller 3* is due out in April! Details of the plot are sketchy at this stage, but fans of this RPG series will be kept up to date in future Dungeons. Paragon releases are distributed by MicroProse, and the long awaited DarkLands RPG (set in the Germanic Middle Ages) looks like being delayed further. The Amiga version will probably appear very late in 1992.

Sequels

It's sequel time, and leading the pack is *Starflight II* from Electronic Arts. The strength of the original *Starflight* lay in its varied gameplay (trading, exploring, combat), and *Starflight II* promises much more. You will travel through time, make contact and trade with more alien cultures, solve puzzles, and take a hyperspace jaunt or five along the way. Graphics have been upgraded from the

original, too. Worth checking out for the gameplay value alone.

Speaking of sequels, it's finally been confirmed that *Bard's Tale IV* will indeed appear sometime next year. It will be interesting to see how your party (elevated to God-like status after *Bard's Tale III*) is handled in the new game, which also promises 32 colour graphics.

For creative fans of the series who always wanted to design their own mazes, look out for the upcoming *Bard's Tale Construction Set* from Interplay. It features all the tricks and traps found in every *Bard's Tale* game, from the "teleporters" to the "spinners" to the "magic mouths". Not only that, Interplay has thrown in all the mazes from the original *Bard's Tale* game with the *Construction Set*!

CD Technology

Origin is one company that's pushing CD technology to the fore, and this may eventually translate over to the CDTV. Currently there are no plans to convert *Wing Commander II* to either Amiga or CDTV format, as the guys from Origin claim that the game is too advanced for the regular 8Mhz Amiga chip. Until Commodore start putting in faster 68030s in regular Amigas, we may never see *Wing Commander II* or *Strike Commander* on the Amiga!!

Hopefully the Ultima series will continue though, and there's yet another derivative on the way. Titled *Ultima: The Underworlds*, it's a 3D Dungeon Master type RPG set in the infamous Stygian Abyss. As the Avatar, you've been banished to this hellhole for a crime you did not commit, and it's your job to explore the Abyss. Fans of the Ultima series might recognize the fact that the Avatar had in fact conquered the Stygian Abyss in Ultima IV!

When will Access Software's *Countdown* hit the stores, you cry? After a few delays, *Countdown* will eventually be released "very soon now". The coding of the game has been entrusted to the UK programming team that also did the previous Amiga versions of *Mean Streets* and *Crime Wave*.

After playing the former, I am confident that *Countdown* will be an adventure to remember. By the way, Access also has plans to bring out the sequel to *Mean Streets* late next year. It's called *Martian Memorandum*, and some of the digitized movements of characters in the game are nothing short of amazing. The Amiga conversion should contain a lot of speech as well. The plot of *Martian Memorandum* will bring back a few

memories from the movie *Total Recall* (ancient Martian civilization, lots of sleazy places to visit on the Red Planet, the role of the Martian Mutants, and so forth).

Oops! Last month I mentioned something about Free Spirit Software's newest Amiga release *The Abyss*, well it's NOT based on the Jim Cameron movie of the same name. Rather, it turned out to be a puzzle game! Free Spirit will be

continuing the adult adventures of Captain Brad Stallion, though, and another "Big Thruster" graphic adventure is due to be released very shortly.

Finally, to all hardy Adventurers and Role-Players out there, a merry merry Christmas and Happy New Year! Next month's *Dungeon* should have some news on the upcoming Consumer Electronic Show in Las Vegas (1992), so stay tuned!

Help, Help & more Help or the Smart Adventurers Dept.

Many thanks to all those adventurers who sent in hint for those very troubled adventures. Your prompt assistance is greatly appreciated.

Game: *Captive*

For: David McKinney
(October Issue)

From: Steve McKinlay, Doncaster,
Vic. and Peter Georges.

Help: David will not find the password for one of his doors because it happens to be stuck behind it!

There seems to be a bug in the game of *Mission Two*, *The Third base* (Phoopel).

A clipboard has been placed in the wrong area so you cannot get to it without opening the wall that it is supposed to open. The clipboard is of the type where lines are highlighted on a grid to open a nearby section of wall. The clipboard number is 15099.

Kill professors and guards, who will in turn drop codes for gates and wall opening.

Game: *Battletech*

For: Ray Huntley (October Issue)

From: Peter Georges and Stuart George.
Help: The cache can be found at map location 54,40 vertical, 41,20 horizontal.

Game: *It Came From The Desert I and II.*

For: Luke Morris (October Issue)

From: Peter Georges

Help: Part I: First collect a piece of an ant on day one from JD's farm.

Return home on day two and find Jackie.

Visit the scene of her crash and pick up some new creature fluid. Don't stay with her otherwise Dusty will get jealous.

Make frequent trips to the police station.

Footprints around the volcanic cones are more evidence. All evidence should be taken to Doc Wells at the lab.

To get rid of the Hellcats, drive at full speed in the middle of the road.

Finally, the queen ant's hideout in M1 near the mines.

Part II: Get the combo of the safe first. These numbers are gained by shooting off antennae from the people that have ant heads. The safe is in the morgue in the basement of the hospital.

When you get it, block the door with the wheel chair.

Once you have revealed the anthead's plot, go to the situation map in the police station. Place army and workmen at key areas such as the airport, town, north volcano and armoury.

On the 8th and 9th day, fly to the ant nest which is due north of the north volcano. Wait until the ants appear then spray them.

Land the plane on the road and walk to the nest.

Once you have found the queen ant, set the explosives and run back.

Game: *Bloodwych*

For: Mark Healy (October Issue)

From: Peter Georges

Help: In the maze, use the compass

spell. If you use it in the wrong places you will be spun around and you will lose your bearings.

Game: *Champions of Krynn*

For: Ray Huntley (October Issue)

From: Stuart George

Help: After you defeat Myrtani you have to defeat a few big red dragons. For this, you will need to give the Dragonlance to the best fighter and use the protection against the dragon breath on him. In the battle have this fighter approach the dragons and all the others run to the outer edges of the combat zone so that no dragons are visible. Casting HASTE on the party will help.

Games: *Runaway and Astroodus Affair*

For: George Glover

From: David Lear

Help: *Runaway*: To get light on the subject, stand up, examine surfaces, feel walls and pull cord.

To know the time, examine furniture, examine bed, table, lamp, base and get watch. Enter TIME.

To escape the bedroom, examine rug and get short key. Examine shelving and get/unlock box, get large key. Examine south door/calendar/numbers. Unlock west door and go west into the store room. Examine chests and examine contents. Return to bedroom and unlock south door.

Astroodus Affair: To get started, examine door and more debris. Go east, east, north, get apple, north. Crawl under beam, examine carpet, move cabinet, enter hole, get card and exit hole. Return to bridge and insert card in slot. Get/examine manual. Go south to control room and press code to restore heating.

PROFESSIONAL EDITION

Expanded Dictionary, Thesaurus with Definitions

and Hyphenation, 1 MEG Required

Faster Screen Display, Unlimited Graphics Per Document

Version 2.0



WORD PROCESSING ACE



excellence! the fastest word processor for your Amiga
is the ace-in-a-hole for your writing needs.

And we've stacked the deck in your favor with 250 available
fonts per document; a Spell-As-You-Type 140,000 + word Dictionary
(with legal, medical, technical, scientific, and geographical supplements);
Grammatical/Style checker; 1.4 million Thesaurus with definitions;
Index and Table of Contents Generator; Headers, Footers and Footnotes.

You'll deal in PostScript output; True WYSIWYG; automatic Hyphenation;
Math; resizable Color Graphics; flexible Mail Merge; Columns and
easy-to-use Macro-Language making complex actions a snap.

With excellence! word processing is all aces.

Committed to excellence since 1978



Micro-Systems Software

Distributed and Supported in Australia
by



product (australia) pty. ltd.

P.O. Box C64, Mt. Kuring-Gai, N.S.W. 2080.

Ph: (02) 457 8388 Fax: (02) 457 8739.



MINDSCAPE INTERNATIONAL

BRINGS YOU...

THE



BEST!

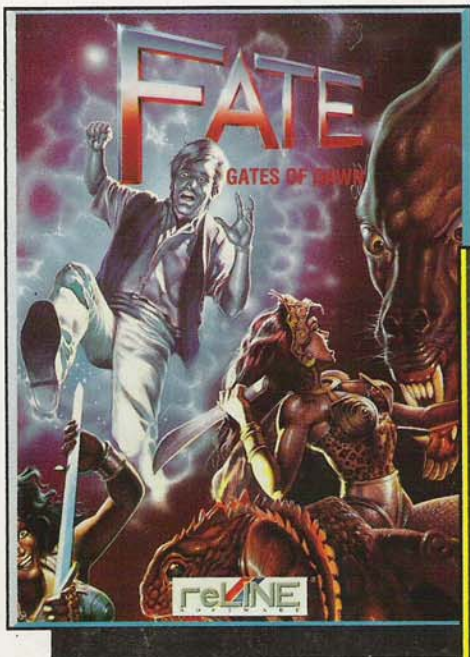

Fate - Gates of Dawn

A sorcerer from a parallel world has cast his spell upon you. Now you find yourself in his world, a delicate composition of fairy tales, fantasy and reality. Through his intrigues you are thrown into dangerous situations again and again. With the help from a small group of brave companions you try to bring light into the mysteries of this world. You will fight against the sorcerer's great struggle for power and in doing so you'll learn the reason of your abduction. After many an adventure you might even be able to return to your own world.

Available Amiga - \$79.95 RRP
IBM - \$79.95 RRP

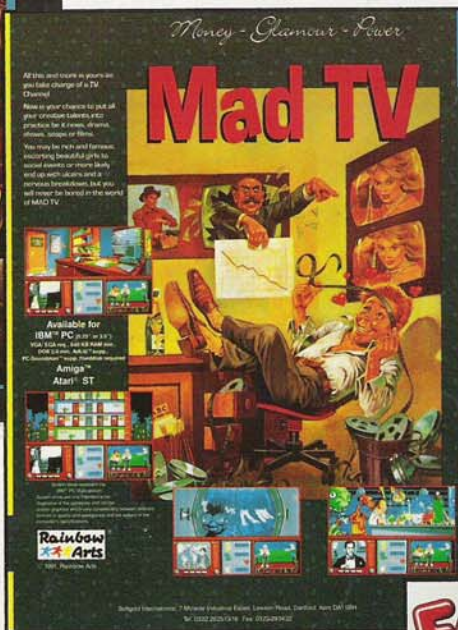

Mad TV

All this and more is yours as you take charge of a T.V. Channel.

Now is your chance to put all your creative talents into practice be it news, drama, shows, soaps or films.

You may be rich and famous, escorting beautiful girls to social events or more likely end up with ulcers and a nervous breakdown, but you will never be bored in the world of MAD TV.

Available Amiga - \$69.95 RRP
IBM PC - \$69.95 RRP

Rolling Ronny

Rolling Ronny skates into town!

Who says being an errand boy is dull? Take Rolling Ronny - he's the coolest dude in town. Help him roller-skate and shoot his way through nine levels of parkland, city streets, office complexes and even the underground sewers to his final destination at the other side of town.

Available Amiga - \$69.95 RRP
IBM PC - \$79.95 RRP
C64 Disk - \$49.95 RRP
C64 Cass - \$39.95 RRP

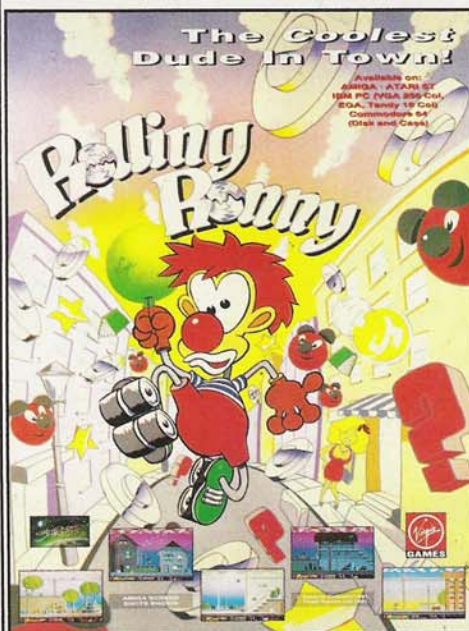

Final Blow

As you step into the spotlight you're faced with your formidable boxing opponent. Limbering up in the other corner and ready to inflict some serious damage could be any one of 10 boxers, each with his own individual strengths and weaknesses. They vary in boxing styles, allowing you to pit your brawn against an offensive or defensive opponent - it's up to you to discover his weak points!

You punch, duck, dive and weave in this one or two player game with the referee waiting to count you out. Players can also choose whether to enter on a single fight or go the whole hog and sign up for a league.

Available Amiga - \$69.95 RRP
C64 Disk - \$49.95 RRP
C64 Cass - \$39.95 RRP

FINAL BLOW

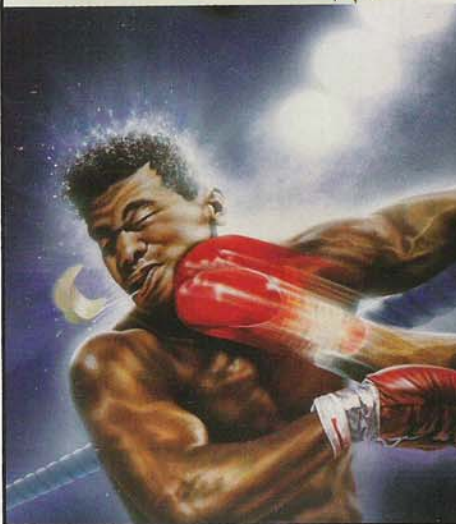

Proudly distributed by
Mindscape International
5-6 Gladstone Rd
Castle Hill NSW 2154
Phone: (02) 899 2277
Fax: (02) 899 2348