

# MICRO™

The Magazine of the APPLE, KIM, PET  
and Other **6502** Systems



**APPLE II  
HIRES**

**Picture Compression**

NO. 18 **NOVEMBER 1979** \$2.00

# Commodore

340K Dual Drive



CBM 2040  
\$1295<sup>00</sup>



2001 - 32N \$1295<sup>00</sup>

80 Column  
Dot Matrix Printer



PRINTERCOM  
2022 \$995<sup>00</sup>  
2023 \$849<sup>00</sup>

2001 - 8N	\$795 <sup>00</sup>
2001 - 16B	\$995 <sup>00</sup>
2001 - 16N	\$995 <sup>00</sup>
2001 - 32B	\$1295 <sup>00</sup>
16/32K DIAGNOSTIC KIT	\$225 <sup>00</sup>
AUDIO AMPLIFIER PET	\$29 <sup>95</sup>

PET to IEEE Cable	\$39 <sup>95</sup>
IEEE to IEEE Cable	\$49 <sup>95</sup>
C2N CASSETTE	\$95 <sup>00</sup>
8K DIAGNOSTIC KIT	\$30 <sup>00</sup>
DISKETTES:	
DYSAN [Business Quality]	5/\$24 <sup>50</sup>
VERBATIM	10/\$31 <sup>95</sup>

N DENOTES GRAPHICS ON LARGE KEYBOARD  
B DENOTES NO GRAPHICS ON LARGE KEYBOARD

## BUSINESS SOFTWARE

### OSBORNE — CMS

General Ledger Disk	\$295 <sup>00</sup>	Inventory Control Disk	\$195 <sup>00</sup>
Accounts Payable Disk	\$195 <sup>00</sup>	[Available 12-1-79]	
Accounts Receivable Disk	\$195 <sup>00</sup>	Mailing List Disk	\$95 <sup>00</sup>
Word Processor 16/32K Disk	\$99 <sup>00</sup>	Payroll Disk	\$295 <sup>00</sup>
		[Available 1-15-80]	
		Word Processor Tape	\$24 <sup>95</sup>

### CBM — MIS

General Ledger Disk	\$120 <sup>00</sup>	Inventory Disk	\$120 <sup>00</sup>
Accounts Receivable Disk	\$120 <sup>00</sup>	Job Cost/Bid Disk	\$120 <sup>00</sup>
Accounts Payable Disk	\$120 <sup>00</sup>	Customer Information	
Payroll Disk	\$120 <sup>00</sup>	[Mailing List] Disk	\$120 <sup>00</sup>

CBM — MIS Complete 7 Module Set \$795<sup>00</sup>

All 16N/16B Upgrade to 32K \$310<sup>00</sup>

Ship computer and check to:

## HOME COMPUTERS

1775 E. Tropicana  
(Liberace Plaza)  
Las Vegas, NV 89109  
702/736 - 6363

FREE Software  
LAS VEGAS series with any PET  
computer purchase or upgrade  
to 32K, valued at \$200<sup>00</sup> or  
more, including other software.

# SUPERKIM

## INDUSTRIAL CONTROL COMPUTER

Here is a powerful microprocessor control system development tool and a complete real-time multitasking microcomputer in one package. There is no need to buy a power supply, motherboard, memory boards and separate I/O boards when your requirements may be satisfied by a **SUPERKIM**. You may only need a couple of wire-wrap sockets and a few LSI chips installed in the big 3" x 10" onboard prototype area to accomplish the required memory expansion and interface with the real world.

Some single chip interface devices available are: UARTS, 16 channel-8 bit analog to digital data acquisition systems, floppy disk controllers and dot matrix printer controllers. Furthermore, you will shortly be able to buy single 5 volt supply pseudo static 8K byte (that's right, you read it right, 8K x 8 bits) memory chips in a single 28 pin package. These chips use the same technology developed for the 64K bit dynamic RAMs now being manufactured by TI, MOTOROLA and others. Just five of these chips and four 2732 EPROMs in the sockets already supplied in the **SUPERKIM** will yield a fully populated **SUPERKIM** with 44K bytes of RAM, 16K bytes of EPROM with serial and parallel I/O ports, and enough room left-over in the prototype area for a LSI floppy disk controller chip. Zilog already has, on the market, a 4K byte version of this memory chip that is pin compatible with the 8K byte version; no need to rewire your sockets when the larger memories become available. Put in 24K now and upgrade later to 44K.

If you started with a KIM-1, SYM-1 or AIM-65 and tried to expand it to the basic capabilities of the **SUPERKIM**, you would need a power supply (\$60), a motherboard (\$120), a prototype board (\$30), a memory board (\$120), and an I/O board (\$120) for a total cost of from \$620 in the case of the KIM-1 to \$825 in the case of the AIM-65. You still would not have real time multitasking capabilities.

Multitasking is a situation where the microcomputer appears to be doing more than one job simultaneously. For example, the

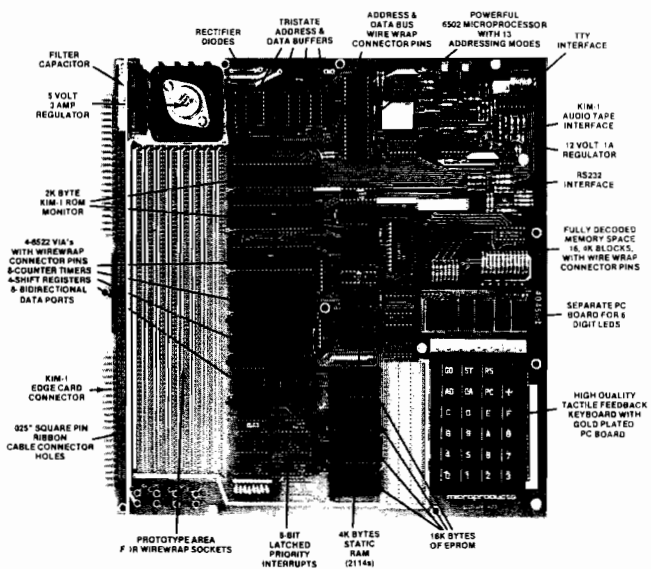

microcomputer could be sending data to a printer, accepting analog data from a 16-channel data acquisition system and presenting data to an operator monitoring a LCD or LED display, all the while keeping track of time.

Multitasking is accomplished on the **SUPERKIM** by use of vectored priority interrupts and a real time clock. This real time clock is implemented using one of the four on-board 6522 programmable tone generators.

The **SUPERKIM**, with its keyboard, display and ROM monitor, can be used as a system analyzer for troubleshooting hardware and software in-the-field or during system development as an in circuit emulator. The monitor can stop the CPU at any point in the program, step through the program, change the contents of the systems' memory and CPU registers, and record the CPU's registers during a selected portion of the program. It offers one of the most powerful combinations of development and diagnostic tools available on the market today.

All of the above is unavailable on any other single board computer at any price.

**\$395<sup>00</sup>**

**microproducts**

2107 ARTESIA BOULEVARD • REDONDO BEACH, CA 90278 • (213) 374-1673



**compas**  
**microsystems**

P.O. Box 687  
224 S.E. 16th Street  
Ames, Iowa 50010

## DAIM

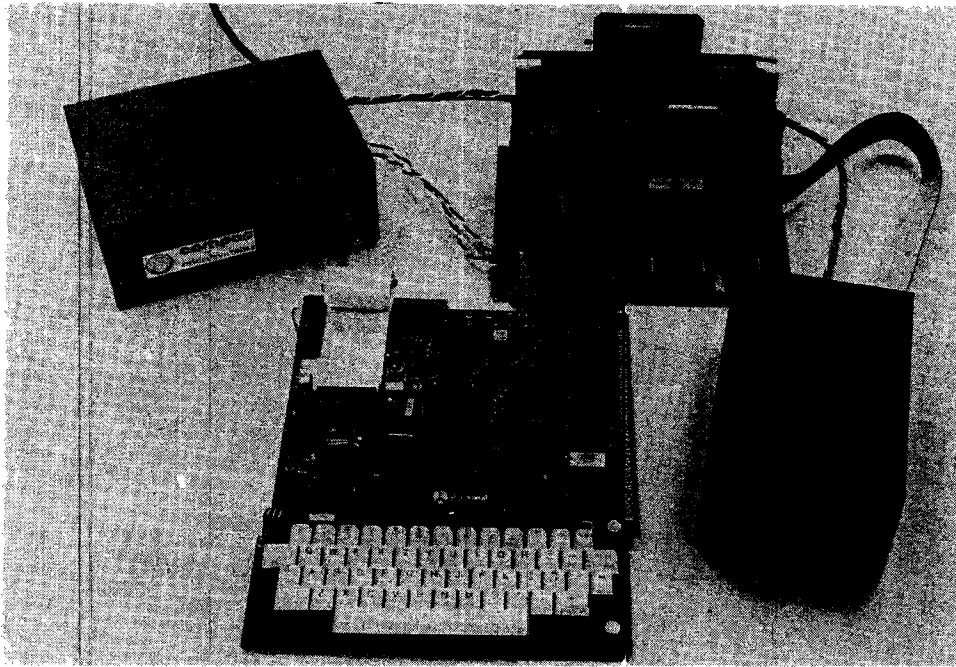

DAIM is a complete disk operating system for the ROCKWELL INTERNATIONAL AIM 65. The DAIM system includes a controller board (with 3.3K operating system in EPROM) which plugs into the ROCKWELL expansion motherboard, packaged power supply capable of driving two 5 1/4 inch floppy drives and one or two disk drives mounted in a unique, smoked plastic enclosure. DAIM is completely compatible in both disk format and operating system functions with the SYSTEM 65. Commands are provided to load/save source and object files, initialize a disk, list a file, list a disk directory, rename files, delete and recover files and compress a disk to recover unused space. Everything is complete — plug it in and you're ready to go! DAIM provides the ideal way to turn your AIM 65 into a complete 6500 development system. Also pictured are CSB 20 (EPROM/RAM) and CSB 10 (EPROM programmer) which may be used in conjunction with the DAIM to provide enhanced functional capability. Base price of \$850 includes controller board with all software in EPROM, power supply and one disk drive. Now you know why we say —

*There is nothing like a*

**DAIM**

Phone 515-232-8187



## Table of Contents

<b>Dual Tape Drive for SYM - 1 BASIC</b> by George Wells	5
<b>Some Useful Memory Locations and Subroutines for OSI BASIC in ROM</b> by S. R. Murphy	9
<b>A Tape Indexing System for the PET</b> by Alan R. Hawthorne	11
<b>Subroutine Parameter Passing</b> by Mark Swanson	14
<b>APPLE II Hires Picture Compression</b> by Bob Bishop	17
<b>Assembly Language Applesoft Renumber</b> by Alan D. Floeter	27
<b>Performing Math Functions in Machine Language</b> by Alfred J. Bruer	30
<b>TSAR: A Time Sharing Administrative Routine for the KIM-1</b> by Philip K. Hooper	35
<b>Interfacing the CI-812 to the KIM</b> by Jim Dennis	43
<b>MICROBES: Ampersort</b>	45
<b>SYM-1 Baudot TTY Interface</b> by Richard A. Leary	49
<b>The MICRO Software Catalog: XIV</b> by Mike Rowe	55
<b>Alarming APPLE</b> by Paul Irwin	59
<b>6502 Bibliography: Part XIV</b> by William R. Dial	61

**November 1979  
Issue Number 18**

## Staff

**Editor/Publisher**  
Robert M. Tripp

**Assistant Editor**  
Mary Ann Curtis

**Business Manager**  
Maggie E. Fisher

**Circulation Manager**  
Carol Ann Stark

**Production Assistant**  
L. Catherine Bland

**Comptroller**  
Donna M. Tripp

## Advertiser's Index

Beta Computer Devices	31	Microproducts	1
Classified Ads	13,20	Optimal Technology, Inc.	28
COMPAS	2	Powersoft, Inc.	25
Computer World	32,33	Programma International	BC
The Computerist, Inc.	26	Progressive Software	16
Computer Shop	8	Rainbow Computing, Inc.	IBC
Connecticut microComputers	46,47,48	RIB - Enterprises	64
Electronic Specialists, Inc.	7	SHYLES Electronic Works	4,14,15
Enclosures Group	34	Softside Software	48
H. Geller Computer Systems	41	Softouch, Inc.	7
Home Computer Center	IFC	Synergistic Software	60
Hudson Digital Electronics	42	Waldon Electronics	63
MICRO	10,48	West Side Electronics	60
MICRO MUSIC Inc.	57		

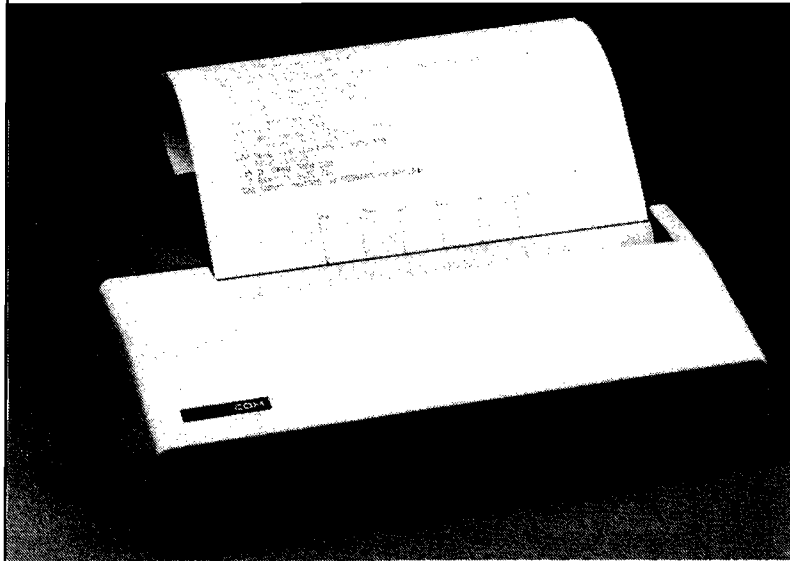
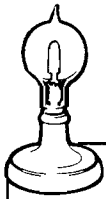

- 80 characters per line
- 8½ inch wide thermal paper
- Full graphics at 60 dots/inch
- Interfaced to PET
- Works with all PET peripherals
- 40 character per second rate
- Microprocessor controlled
- Bidirectional look-ahead printing
- Quiet operation
- No external power supplies
- Only two driven parts
- High reliability
- Clear 5 x 7 characters
- Attractive metal and plastic case

The Skyles PAL-80™ is a high speed thermal printer offering the combination of text printing at 80 characters per line and continuous graphics at 60 dots per inch. In the text mode, upper and lower case data are printed at 40 characters per second. The 5 x 7 characters provide clear readable copy on white paper; no hard to find, hard to read aluminized paper.

In the graphics mode, seven bits of each byte correspond to the seven dots in each of the 480 print positions per line. Since the computer driving the printer has full control over every print position, it can print graphs, bar charts, line drawings, even special and foreign language symbols. Despite its low cost, the Skyles PAL-80 is a

true intelligent printer with full line buffering and bi-directional look-ahead printing.

High reliability is designed in: The thick film thermal print head has a life expectancy of 100,000,000 characters. Two IIC stepping motors provide positive control of the print head and the paper drive.

The Skyles PAL-80 operates directly from a 115V 60 Hz line (230V 50 Hz available). No external power supplies are required.

It comes complete with an interface for the PET: a two and a half foot cable plugs into the IEEE interface at the back of your PET. Works with all PET models and PET or Skyles peripherals.

Please send me \_\_\_\_\_ Skyles PAL-80 printer(s) complete with 2½ foot interface cable to attach to my PET at \$675.00 each\* (Plus \$10.00 shipping and handling). I also will receive a test and graphics demonstration tape at no additional charge and over 150 feet of 8½ inch wide black on white thermal paper \$ \_\_\_\_\_

I would also like to order \_\_\_\_\_ rolls of 8½ inch wide by 85 ft. long thermal paper (black ink) at \$5.00 each \$ \_\_\_\_\_

\_\_\_\_\_ 10 roll cartons at \$45.00 \$ \_\_\_\_\_

VISA, Mastercharge orders call (800) 227-8398  
California orders call (415) 494-1210

\*California residents add 6 to 6½% sales tax where applicable.

## PAL-80 SPECIFICATIONS

### TEXT

**Format** 80 characters per eight inch line  
6 lines per inch nominal  
**Print speed** 40 characters per second  
**Line Feed** 50 milliseconds nominal  
**Character set** 96 Characters, including upper and lower case, numerals, and symbols

### GRAPHICS

**Format** 480 print positions per line  
**Print Speed** 240 print positions per second

### COMMON

**Paper** 8½ inch wide thermal paper, available in 85 foot rolls, black image on white  
**Dimension** 12"W x 10"D x 2¼"H  
**Weight** 8 lbs (3.6 kg)

# Dual Tape Drive for SYM-1 BASIC

---

**If you want to make your SYM - 1 BASIC work with two tape recorders and manage tape cassette files, here is what it takes. A few important observations about the BASIC are presented that could save you grief.**

---

George Wells  
1620 Victoria Place  
La Verne, CA 91750

When I bought my SYM-1, I had no intention of buying BASIC for it. However, after not being able to show off my new computer to my friends and relatives in a way they could understand, I decided to go ahead and get the BASIC ROMS. Then I purchased a book of BASIC games and copied several of them onto tape. The need to have a convenient means of copying tapes to make backup copies became apparent. Also, I discovered that the tape routines do not work after BASIC has been interrupted and reentered with a "GO" command (warm start). After I received the tech note from Synertek describing how to put trig functions in BASIC, I found out how to fix this problem. The tape routines use system RAM to pass information from BASIC and apparently the call to "ACCESS" was omitted during the warm start.

To make the second tape recorder work, I added five components to one of the buffered outputs to make it look like the audio cassette remote control configured for type IV (see figure 3-3, pages 3-7 of SYM reference manual). This is the set up required for one of the recommended recorders, Radio Shack CTR-40. Refer to SYM reference manual figure 4-5A, pages 4-12. Note that pad 1 is located between pads 2 and 6. The following connections were made to buffer PB4:

Install 470 OHM at location R5.

Install 2N2902A transistor emitter to pad 6 base to pad 9 collector to pad 1.

Install 1K resistors between pads 6&9.

Install 1N914 diode anode to pad 1 cathode to pad 6

Install 1N914 diode anode to pad 19 cathode-pad 16.

Install subminiature phono plug tip to pad 6, shield to pad 1.

My first tape recorder (General Electric model M8455A) is connected to the normal remote control configured for type V. The audio out (LO) goes to the MIC input. I discovered a trim pot on the inside of the recorder which, if turned completely counter-clockwise, makes the recording ideal for the SYM computer (terrible for voice though). Also, I found it necessary to align the heads of both tape recorders before I could get reliable operation. The GE recorder is used normally to save files and the Radio Shack recorder is used with special routines to load files. The assembly language program was written at a location just before the trig function routines and includes two sets of execute commands for cold and warm starts to BASIC that are compatible with the trig functions and include a call to "ACCESS" so that the tape routines will work after a warm start.

The hex dump of the tape drive routine plus the trig functions (from Synertek Systems Corp. Tech Note 53) can be used to enter the code into your system. Use the same verify command and compare checksums to check your work. I save this file on tape using an ID of \$31 which can be loaded and saved from BASIC as file "1".

The sample run-stream illustrates how to make it all work. First, a cold start to BASIC was performed with the monitor execute command (E E5A). SYM responds with everything down to line 100 which was entered to exercise the trig functions and provide something to save on tape. After running the single line BASIC program, it was saved on tape with the file name "T". "NEW" erases the program to indicate that the tape will do a real load. The "USR" com-

mand to hex address 8035 takes us out of BASIC and back to the monitor. To get back to BASIC use the execute command (E E95). The response includes everything down to the word "list". Since nothing was listed, this shows that the previous program has been erased. It is loaded back in by transferring the cassette from the "save only" recorder (in my case the GE) and putting it on the "load only" recorder (Radio Shack) and pushing the rewind button. If this is the first time that the load only recorder has been used since the SYM was reset, then the recorder will start rewinding immediately. Otherwise it will wait until the "LOAD T" command is entered. When the tape is rewound, the play button is pressed and the recorder stops automatically when the file is loaded. Listing and running the program show it to be the same as before.

The way I use routines to manage files is through the use of three identical cassette tapes each storing one copy each of all my BASIC programs. I use a fourth tape for temporary storage of a program I am currently working on. When I want to make a copy of all the programs on tape, I put that tape into the LOAD-ONLY or READ-ONLY recorder, and push the PLAY button. Then I put the tape that I want to copy to in the SAVE-ONLY or WRITE-ONLY recorder and push the PLAY-RECORD buttons. I also keep a directory on paper of the program files ID's on tape. Its a simple matter to type a sequence of BASIC commands consisting of a series of LOAD A, SAVE A, LOAD B, SAVE B, LOAD C, SAVE C, etc. If I want to insert a new program from my temp tape, I just swap tapes in the READ-ONLY recorder to get the new program out, and then swap back to continue with the old programs.

```

.E E5A
.J 0
MEMORY SIZE? 3674
WIDTH? 80
OK
POKE202,169:POKE203,14:POKE196,104:POKE197,15

OK
100 PRINT SIN(1),COS(2),TAN(3),ATN(4)
RUN
.841470985 -.416146836 -.142546543 1.32581766

OK
SAVE T
SAVED

OK
NEW

OK
?USR(&"8035",0)

CB6D,3
.E E95
.V 0

OK
?USR(&"8886",0)
0

OK
LIST

OK
LOAD T
LOADED
OK
LIST

100 PRINT SIN(1),COS(2),TAN(3),ATN(4)
OK
RUN
.841470985 -.416146836 -.142546543 1.32581766

OK

```

As a matter of habit I then read the tape I have just written to verify that it is O.K. and use it to copy into my third permanent tape. Then I repeat the process going from the third tape back to the original one. Finally, I read the original tape to verify it. If at any point I detect a bad load, I know that I will always have an available on one of my tapes a copy of the file in good condition, that hasn't been overwritten yet.

Small changes can be made in any program file by copying it onto the temp tape with the changes (I usually make two or three copies on the temp tape) and then rewriting the file on each of the permanent tapes by reading the file immediately before the one I want to change to find where to start, and reloading from the temp tape before actually saving the changed file.

### Three Other Observations

1. Two words have been omitted from the list of reserved words on page 9 of the BASIC manual: "GO" and "GET". "GO" allows you to spell "GOTO" as "GO TO" if you want; not really a good idea since it takes three bytes of storage instead of only one. "GET" must be a leftover since it always generates an FC error.

2. Page C-2 of the manual states that 6 bytes of storage are used for each variable: 2 for the name and 4 for the

value. In fact, 5 are used for the value, bringing the total to 7. This is what gives SYM BASIC its 9+ digit resolution. The disadvantage is that every simple variable (including integer and string variables which only need two and three bytes respectively for their values) uses more bytes than are usually needed. Incidentally, there is a memory saving when using integer or string arrays. However, Microsoft BASIC converts integer values to floating points before using them, which takes longer than using floating points in the first place. Therefore, as a general rule, integer variables should only be used in arrays, and only when it is necessary to conserve memory space.

3. Don't make a mistake when typing a line that prints a hex-formatted number. If you don't follow the format exactly, BASIC hangs up in a loop, printing zeroes. If this occurs, you can recover by doing a reset and going back to BASIC with a warm start. Your program will still be there, but as with any error, the program cannot be continued.

```

MODE EQU $FD
CONFIG EQU $89A5
ZERCK EQU $832E
P2SCR EQU $829C
DDR3B EQU $AC02
DR3B EQU $AC00
LOADT EQU $8C78

AIR $E5A
ASCII <J0> BASIC COLD START COMMAND
BYTE $0D CARRIAGE RETURN
ASCII <3674> MEMORY SIZE
BYTE $0D CARRIAGE RETURN
ASCII <80> LINE WIDTH
BYTE $14,$0D CONTROL T, CARRIAGE RETURN
CHANGE TAPE LOAD VECTOR
ASCII <POKE202,169:POKE203,14:

CHANGE TRIG VECTOR
ASCII <POKE196,104:POKE197,15>

BYTE $0D,$0D CARRIAGE RETURN, END EXECUTE

ASCII <G0> BASIC WARM START COMMAND
BYTE $0D CARRIAGE RETURN
JUMP TO MONITOR ACCESS SUBROUTINE
ASCII <?USR(&"8886",0)>

BYTE $0D,$0D CARRIAGE RETURN, END EXECUTE

STY MODE DO CUSTOM INITIALIZE FOR READ RECORDER
LIA #9
JSR CONFIG
JSR ZERCK
JSR P2SCR
LIA #%00010000
STA DDR3B BIT PB 4 OF VIA 3 SET OUTPUT
STA DR3B TURN ON READ TAPE RECORDER
JSR LOADT+3 LOAD TAPE BUT SKIP INITIALIZE
LIA #%00000000
STA DR3B TURN OFF READ TAPE RECORDER
RTS

0E5A 4A 30
0E5C 0D
0E5D 33 36 37 34
0E61 0D
0E62 38 30
0E64 14 0D

0E66 50 4F 4B 45
0E6A 32 30 32 2C
0E6E 31 36 39 3A
0E72 50 4F 4B 45
0E76 32 30 33 2C
0E7A 31 34 3A

0E7D 50 4F 4B 45
0E81 31 39 36 2C
0E85 31 30 34 3A
0E89 50 4F 4B 45
0E8D 31 39 37 2C
0E91 31 35
0E93 0D 00

0E95 47 30
0E97 0D

0E98 3F 55 53 52
0E9C 28 26 22 38
0EA0 42 38 36 22
0EA4 2C 30 29
0EA7 0D 00

0EA9 84 FD
0EAB A9 09
0EAD 20 A5 89
0EB0 20 2E 83
0EB3 20 9C 82
0EB6 A9 10
0EB9 8D 02 AC
0EBB 8D 00 AC
0EBE 20 78 8C
0EC1 A9 00
0EC3 8D 00 AC
0EC6 60

```



HEX DUMP

```

.V E5A-FFF
0E5A 4A 30 0D 33 36 37 34 0D,68 0F32 36 DD 60 81 49 0F DA A2,71
0E62 38 30 14 0D 50 4F 48 45,20 0F3A 7F 00 00 00 05 84 E6,5F
0E6A 32 30 32 2C 31 36 39 3A,BA 0F42 1A 2D 18 86 28 07 FB F8,89
0E72 50 4F 48 45 32 30 33 2C,AA 0F4A 87 99 68 89 01 87 23 35,5A
0E7A 31 34 3A 50 4F 48 45 31,A9 0F52 DF E1 96 A5 5D E7 28 83,34
0E82 39 36 2C 31 30 34 3A 50,63 0F5A 49 0F DA A2 A1 54 46 8F,D2
0E8A 4F 4B 45 31 39 37 2C 31,40 0F62 13 8F 52 43 89 CD 00 72,91
0E92 35 0D 00 47 30 0D 3F 55,9A 0F6A F0 4A 90 41 00 76 F0 92,54
0E9A 53 52 28 26 22 38 42 38,61 0F72 20 80 D9 A9 00 85 16 A5,B6
0EA2 36 22 2C 30 29 0D 00 84,CF 0F7A C5 48 A9 85 48 A5 C5 48,EB
0EAA FD A9 09 20 A5 89 20 2E,1A 0F82 A9 B5 48 60 A2 9E A0 00,D1
0EB2 83 20 9C 82 A9 10 8D 02,23 0F8A 20 8A D9 A9 A7 A0 00 20,64
0EBA AC 8D 00 AC 20 7B 8C A9,D8 0F92 58 D9 A9 00 85 B6 A5 C5,E3
0EC2 00 8D 00 AC 60 0B 76 B3,A5 0F9A 48 A9 A7 48 A5 16 48 A5,6B
0ECA 83 BD D3 79 1E F4 A6 F5,DE 0FA2 C5 48 A9 E7 48 60 A9 9E,F7
0ED2 7B 83 FC B0 10 7C 0C 1F,3F 0FAA A0 00 4C C5 D8 A9 C5 A4,02
0EDA 67 CA 7C DE 53 CB C1 7D,26 0FB2 C5 20 1D D6 20 C2 D9 A9,3E
0EE2 14 64 70 4C 7D B7 EA 51,C9 0FBA 59 A4 C5 A6 BE 20 1D D8,19
0EEA 7A 7D 63 30 88 7E 7E 92,69 0FC2 20 C2 D9 20 82 DA A9 00,F9
0EF2 44 99 3A 7E 4C CC 91 C7,6E 0FCA 85 BF 20 09 D6 A9 3A A4,C3
0EFA 7F AA AA AA 13 81 00 00,7F 0FD2 C5 20 06 D6 A5 B6 48 10,37
0F02 00 00 A5 B6 48 10 03 20,55 0FDA 0D 20 FF D5 A5 B6 00 09,C0
0F0A 36 DD A5 B1 48 C9 81 90,E0 0FE2 A5 16 49 FF 85 16 20 36,C0
0F12 07 A9 72 A0 D7 20 C5 D8,36 0FEA DD A9 3A A4 C5 20 1D D6,FC
0F1A A9 C7 A4 C5 88 20 C2 DD,56 0FF2 68 10 03 20 36 DD A9 3F,92
0F22 68 C9 81 90 07 A9 35 A4,21 0FFA A4 C5 4C C2 DD 01,E7
0F2A C5 20 06 D6 68 10 03 4C,A9 B0E7
    
```

MICRO™ is published monthly by:

MICRO INK, Inc.  
34 Chelmsford Street  
Chelmsford, Massachusetts  
617/256-5515

Second Class postage paid at:  
Chelmsford, MA 01824

Postmaster: Send address  
changes to:

MICRO  
P.O. Box 6502  
Chelmsford, MA 01824

Publication Number:  
COTR 395770

Subscription in United States:  
\$15.00 per year/12 issues

Entire contents Copyright © 1979  
by: MICRO INK, Inc.

**MICRO**



# SOFTOUCH™

PRESENTS IT'S  
UTILITY PAC II



- CHECKBOOK UPDATE TO DOS  
AN EXEC FILE WRITES OVER YOUR CHECKBOOK PROGRAM TO AUTOMATICALLY UPDATE IT TO DOS
- INDEX FILE UPDATE  
AUTOMATES BISHOP'S INDEX FILE
- FIND CONTROL CHARACTER  
WILL DISPLAY CONTROL CHARACTERS ON ANY CATALOG OR PROGRAM LISTING
- SLOW LIST  
FULL STOP & START CONTROL WITH EXIT. WORKS WITH APPLESOFT OR INTEGER BASIC
- LIST HEADERS  
PUT HEADERS ON YOUR LISTINGS WITH NO LINE NUMBERS OR REM STATEMENTS. AP II
- AUTO WRITE
- AUTO WRITE INSTRUCTIONS  
USE EXEC FILES TO APPEND, ADD SUBROUTINES, OR EDIT PROGRAMS. CONVERT INTEGER TO APPLESOFT. DELETE ILLEGAL LINE NUMBERS ETC. ETC.
- EXEC READER  
READS TEXT FILES FOR ABOVE
- DISC SPACE  
COMPLETELY WRITTEN IN APPLESOFT. WORKS IN 3 SECONDS. GIVES FREE SECTORS AND BYTES

WITH LISTINGS AND DOCUMENTATION, PRICE \$19.95  
\*\*\*\*\* DISC MANAGEMENT SYSTEM \*\*\*\*\*

EIGHT PROGRAMS ON DISK TO PROVIDE THE USER WITH A COMPLETE UNDERSTANDING OF THE DISK DRIVE COMMANDS PLUS A UTILITY PACKAGE TO INDEX & CATALOGIZE ALL PROGRAMS WRITTEN FOR THE APPLE II COMPUTER. THE SYSTEM PROVIDES FULL SEARCH, EDITING AND DATA TRANSFER CAPABILITIES.

A TWENTY-SIX PAGE BOOKLET PROVIDES DETAILED, EDUCATIONAL TECHNIQUES GIVING A THROUGH UNDERSTANDING OF THE DOS COMMANDS.

SYSTEM REQUIREMENTS: DISK II & APPLESOFT TAPE OR ROM  
PRICE \$19.95 ON DISK FOR EITHER OF ABOVE  
(PROCESSED & SHIPPED WITHIN 4 DAYS)

SEND CHECK OR MONEY ORDER TO:



SOFTOUCH  
P.O. BOX 511  
LEOMINSTER, MASS. 01453



**DISK DRIVE WOES? PRINTER INTERACTION?  
MEMORY LOSS? ERRATIC OPERATION?  
DON'T BLAME THE SOFTWARE!**



ISO-1



ISO-2

Power Line Spikes, Surges & Hash could be the culprit! Floppies, printers, memory & processor often interact! Our unique ISOLATORS eliminate equipment interaction AND curb damaging Power Line Spikes, Surges and Hash.

- \*ISOLATOR (ISO-1A) 3 filter isolated 3-prong sockets; integral Surge/Spike Suppression; 1875 W Maximum load, 1 KW load any socket . . . . . \$54.95
- \*ISOLATOR (ISO-2) 2 filter isolated 3-prong socket banks; (6 sockets total); integral Spike/Surge Suppression; 1875 W Max load, 1 KW either bank . . . . . \$54.95
- \*SUPER ISOLATOR (ISO-3), similar to ISO-1A except double filtering & Suppression . . . . \$79.95
- \*ISOLATOR (ISO-4), similar to ISO-1A except unit has 6 individually filtered sockets . . . . \$93.95
- \*ISOLATOR (ISO-5), similar to ISO-2 except unit has 3 socket banks, 9 sockets total . . . \$76.95
- \*CIRCUIT BREAKER, any model (add-CB) Add \$ 6.00
- \*CKT BRKR/SWITCH/PILOT any model (-CBS) . . . . . Add \$11.00

PHONE ORDERS 1-617-655-1532



**Electronic Specialists, Inc.**  
171 South Main Street, Natick, Mass. 01760



Dept.mi

# THE COMPUTER FOR

## EVERYONE ON YOUR XMAS LIST... INCLUDING

# YOU

### IN BLACK & WHITE

**C1P MF: \$995!** First floppy disk based computer for under \$1000! Same great features as the C1P plus more memory and instant program and data retrieval. Can be expanded to 32K static RAM and a second mini-floppy.

It also supports a printer, modem, real time clock, and AC remote interface, as well as OS-65D V3.0 development disk operating system.

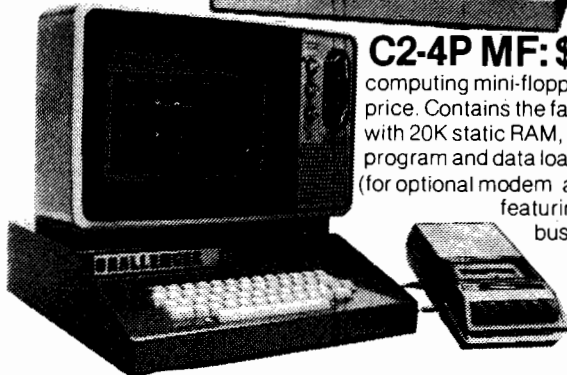
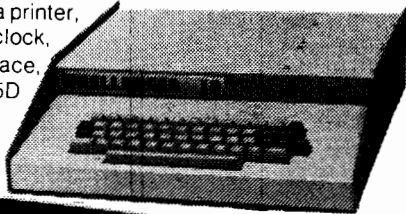

**C2-4P MF: \$1533!** It's a big personal computing mini-floppy system at a special package price. Contains the famous C2-4P microcomputer with 20K static RAM, 5" mini-floppy unit for instant program and data loading, RS-232 circuitry (for optional modem and printer), and diskettes featuring exciting games, personal, business and education applications.

**C2-4P: \$598!** The professional portable that has over 3-times the display capability of 1P's. Features 32 x 64 character display capability, graphics, full computer type keyboard, audio cassette port, and 4 slot BUS (only two used in base machine). It has 8K BASIC, 4K RAM, and can be expanded to 32K RAM, dual mini-floppies and a printer.

### 16 COLORS AND COLOR

The C4P and C8P offer a brilliant array of 16 colors including black available in both alphabetic and graphics. The C4P and C8P have execution speed that is twice as fast as Apple II, or Commodore PET and over THREE times as fast as TRS-80, more display than other personal computers.

## BEAT THE RUSH-ORDER NOW!

\* Apple II, Commodore PET, TRS-80, and Atari 800 are registered trade names of Apple Computer Inc., Commodore Business Machines Ltd., Radio Shack, Atari, respectively.

Name \_\_\_\_\_  
 Address \_\_\_\_\_  
 City \_\_\_\_\_  
 State \_\_\_\_\_ Zip \_\_\_\_\_  
 Phone \_\_\_\_\_

**COMPUTER SHOP**  
 Boston 590 Comm. Ave. (across from B.U.) 247-0700  
 Union N.H. Rte. 168 603-473-2323  
 Cambridge 288 Norfolk St. (near M.I.T.) 661-2670

**C1P: \$349!** A dramatic breakthrough in price and performance. Features OSI's ultra-fast BASIC-in-ROM, full graphics display capability, and large library of software on cassette and disk, including entertainment programs, personal finance, small business, and home applications. It's a complete programable computer system ready to go. Just plug-in a video monitor or TV through an RF converter, and be up and running. 15K total memory including 8K BASIC and 4K RAM — expandable to 8K.

**C2-8P: \$799!** The personal class computer that can be expanded to a full business system. Has all the features of the C2-4P plus an 8 slot BUS (3-time greater expansion ability than the C2-4P). Can be expanded to 48K RAM, dual floppies, hard disk, printer and business software.

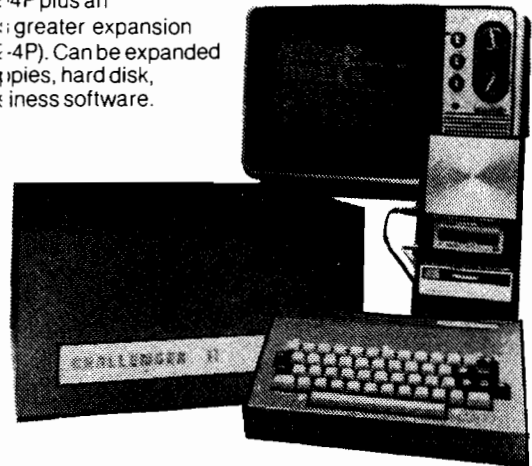

**C2-8P DF: \$2599!** A full business system available at a personal computer price! The system includes the powerful C2-8P microcomputer (32K RAM expandable to 48K), dual 8" floppy unit (stores 8-times as much information as a mini-floppy), and 3 disks of personal, educational and small business applications software. Has all the capabilities of a personal system including graphics plus the ability to perform Accounting, Information Management, and Word Processing tasks for small business.

Send me a \$ enclosed

Payment by: BAC (VISA) \_\_\_\_\_ Master Charge \_\_\_\_\_

Credit Card Account # \_\_\_\_\_

Expires \_\_\_\_\_

TOTAL CHARGED OR ENCLOSED \_\_\_\_\_

All orders shipped insured UPS unless otherwise requested

# Some Useful Memory Locations and Subroutines for OSI BASIC in ROM.

S.R. Murphy  
201 N. W. 48th  
Seattle, WA 98107

---

**If you want to know more about your OSI BASIC, information is presented which details the use of RAM Scratch Pad Memory and shows where some of the most important Support Subroutines reside.**

---

MICRO has published very little on OSI's BASIC in ROM system. One can only guess that fewer OSI owners are inclined to explore their machines and bend their functions to their own uses in contrast, perhaps, to owners of other 6502 systems. This is a pity because, in contrast to what I read about PET, for example, the BASIC ROM's and the EPROM's that support BASIC, keyboard polling, and the MONITOR are all easily accessed by PEEK or through the MONITOR.

This note may stimulate other OSI BASIC in ROM owners to try some software ideas for custom uses. The following listing of BASIC pointer and subroutine locations make it possible to modify programs written for other MICROSOFT 6502 BASIC interpreters for use with OSI.

MICRO, number 6, pages 49-50, gave a "PARTIAL LIST OF PET SCRATCH PAD MEMORY", by Gary A. Creighton. Since

MICROSOFT supplied the BASIC interpreter for both OSI and PET, a principle of parsimony suggests that there should be a strong similarity between the two systems even though OSI uses a more primitive cassette I/O system without the file commands.

Table 1 represents the essence of this similarity in parallel to the PET table. The notation is essentially the same as Mr. Creighton's except for the use of Hex rather than Decimal.

IND (XY) is an address with the low byte in location \$XY and the high byte in location \$XY + 1.

M(XY) is the content of memory location \$XY.

The description also follows the original with the appropriate modifications for OSI operations. The table is not complete, but, to the best of my knowledge it is accurate.

Finally, in MICRO, number 11, page 37, Don Rindsberg presented an impressive BASIC renumbering program. I have not yet converted the program to OSI because a BASIC renumbering capability is not one of my favorite needs. However, for OSI owners who would like to "roll your own" following Mr. Rindsberg, Table 2 is presented as a substitution for his Table 1 on page 38 that lists the BASIC subroutines needed in his program. The subroutines in Table 2 can, of course, be used for other purposes. \$B95E is an excellent Hex to Decimal converter that can be called with a simple machine language program. Similarly, \$A77F can be the basis for Decimal to Hex conversion. \$A8C3 is a general purpose message printing routine that is easily incorporated into any program. Finally, \$A24D makes it relatively simple to modify BASIC programs under computer control.

**Table 1****A Partial List of OSI BASIC  
in ROM Scratch Pad Memory**

(Ref. MICRO, No. 6, Pgs. 49 - 50)

IND(01)	Initially, address of cold start (\$BD11). Replaced by warm start (\$A274).
IND(06)	USR INVAR address.
IND(08)	USR OUTVAR address.
IND(0B)	USR program address.
M(0D)	Number of NULL'S selected.
M(0E)	Terminal character count.
M(0F)	BASIC terminal width.
M(11-12)	Arguments of statements such as PEEK, POKE, GOTO, GOSUB, line numbers, etc.
M(13-5A)	Input buffer.
IND(71)	Scratch pad address for garbage collec- tion, line insertion, etc.
IND(79)	Address of beginning of BASIC code. (\$0301)
IND(7B)	Address of beginning of Variable Table.
IND(7D)	Address of first array entry in Variable Table. If no arrays, end of Variable Table.
IND(7F)	Address of end of Variable Table.
IND(81)	Lowest string address.
IND(83)	Scratch pad string address.
IND(85)	Address, plus one, of highest allocated memory.
M(87-88)	Present BASIC line number.
M(89-8A)	Line number at BREAK.
IND(8B)	Pointer to BASIC code for CONT.
M(8D-8E)	Line number for present DATA statement.
IND(8F)	Address of next DATA statement.
IND(91)	Address of next value after comma in pre- sent DATA statement.
M(93-94)	ASCII code for present variable.
M(BC-D3)	Subroutine: Points through code one byte at a time, RTS with code value in A and carry clear if ASC(0 - 9); otherwise, carry set. Return A = 0 if end of line. Ig- nores spaces.
IND(C3)	Code location pointer for above subroutine.
M(AF-B0)	USR input variable storage.
M(FB)	MONITOR keyboard control flag. ( = 0 for keyboard).
M(100-107)	Storage of conversion of floating point number to ASCII.
M(1FF)	Top of BASIC stack.
M(200-20E)	Temporary storage for CR simulator subroutine (\$BF2D).
M(212)	CTRL C flag. ( = \$01 if CTRL C off).
M(213-216)	Temporary storage, keyboard polling pro- gram (#FD00).

**Table 2****OSI BASIC Routines Needed for  
BASIC Renumbering**

(Ref. MICRO, No. 11, Pg. 38)

\$A24C	Print an error message from the message table. Enter with X containing the location of the message relative to \$A164. Message ter- minator is ASCII having bit 7 on.
\$A24D	BASIC line insertion routine. Enter with line assembled in the line buffer \$0013-\$005A with 00 as line terminator. Also, character count must be in \$005D and the line number(hex) at \$0011/12.
\$A77F	Evaluate an expression whose beginning ad- dress is in \$00C3/C4. Use this subroutine to convert from ASCII to binary, with the result appearing in the floating accumulator: \$00AC/AD/AE/AF.
\$B7E8	Convert fixed number in \$00AD/AE to floating number. Enter with the result appearing in the floating accumulator: \$00AC/AD/AE/AF.
\$B408	Convert binary value, such as line number, in floating accumulator to two-byte fixed number and place in \$0011/12.
\$B96E	Convert floating number at \$00AC/AD/AE/AF to ASCII and place in string starting at \$0101, preceded by a space or minus sign at \$0100 and terminated by 00.
\$A274	BASIC warm start. Prints "OK".
\$A8C3	Prints message. Enter with ADH in Y, ADL in X. Message is ASCII string ending with 00.
\$B95E	Print the decimal integer whose hex value is in registers A and X, for example, a line number.

**BEST of MICRO Volume 2**  
is available now.

All of the important material from MICRO issues 7 through 12 (Oct/Nov 78 to May 79) presented in convenient book form. The book is 8½ by 11 inches, 224 pages, and the material is organized by major computer type: AIM/SYM/KIM, APPLE, PET, and GENERAL material. This is a companion volume to BEST of MICRO Volume 1 which covered issues 1 to 6.

**BEST of MICRO Volume 2** is available at your local computer store for \$8.00, or may be ordered directly from MICRO with delivery anywhere in the world at:

\$9.00 Surface Mail, or,  
\$13.00 Air Mail.

**BEST of MICRO Volume 1** is still available from your local dealer for \$3.00 or by mail from MICRO at:

\$7.00 Surface Mail, or,  
\$10.00 Air Mail.

Send order to:

**MICRO**  
P.O. Box 6502  
Chelmsford, MA 01824

# A Tape Indexing System for the PET

---

**A solution is provided for the PET cassette tape problem. Using inherent capabilities of the PET, a procedure is presented which permits use of the recorder's fast forward and fast rewind facilities to rapidly index and portion of the tape.**

---

Alan R. Hawthorne  
611 Vista Drive  
Clinton, TN 37716

A frustrating problem for PET owners occurs when it becomes necessary to load a program or read a data file that has been written in the middle of a cassette tape. Since Commodore chose not to include a cassette recorder with an index counter, the user is left with the following options:

- 1) Load only one program per tape. (This can make personal computing unnecessarily expensive for the hobbyist with hundreds of programs.)
- 2) Let the PET slowly search through the tape until it finds the correct file name. (This process is much too slow, since it can take up to 30 minutes to search one side of a 60 minute tape.)
- 3) Guess where the program might be on the tape and run the tape to this point using the fast forward speed on the recorder; then let the PET begin to search for the program. (This guessing is no fun. One often runs past the desired program and wastes even more time.)

I decided that there must be a better way to use the PET for reading multiple files. An index finder on the recorder would, in essence, permit me to use option 3 above, but with the guesswork removed in positioning with the fast forward speed. I contemplated implementing a photodetector and an LED as an index counter, but this would require modification of the recorder plus hardware for counting and displaying. A much simpler solution would be to develop a software index counter that would take advantage of existing recorder switch-sensing and motor-control capabilities of the PET. The machine language program, described below, uses an index number corresponding to each program position on the

tape. Also given is the method for determining the correct index number corresponding to each program on the tape.

## Indexing Approach: Theory

A successful tape positioning program can be implemented if the fast forward speed of the recorder is run for the correct length of time and if that correct length of time can be determined for a given program.

The first requirement can be met easily by using the PET's ability to sense if the recorder buttons are pressed and to stop the recorder under program control. The tape of interest is simply loaded into the recorder and rewound; the correct time constant for the desired program is then entered into the PET. The positioning program instructs the user to press "fast forward." The program waits until a recorder button depression is detected, then begins timing until a time corresponding to the index time has elapsed, at which point the recorder motor is stopped. A prompt character is output to the PET screen indicating that the tape is positioned at the beginning of the desired program on tape and that the user should now press the "stop" button. Upon sensing the depression of the recorder stop button, the indexing program places the recorder under manual control for subsequent use in loading the program from tape and then exits to the operating systems monitor. If this machine language positioning program is stored in a safe memory such as the cassette number 2 buffer (M826-M1023) when the PET is powered up, it will always be available for positioning programs and data files with no time lost in loading the program each time it is needed.

The second requirement for implementing an indexing system, that of determining the correct time constant for a given program, is more demanding. Not being able to read the tape header while the recorder is running fast forward, one must find another means of determining the fast forward time required for positioning a tape. A related time that can be obtained easily is the amount of time required to rewind the program tape. The PET can detect when the rewind button is depressed and can count time until the user presses "stop" when the tape is rewound. This time can be directly, although not simply, correlated with the fast forward time required to position to the beginning of the program to be entered. Of course the problem in relating the rewind speed to the fast forward speed occurs because the tape speed (cm/sec past the recorder head) varies even though the drive speed (revolutions/sec) is the same in each direction. (That the drive speed is the same fast forward as rewind is easily proven by measuring the time taken to run through a complete tape in the fast forward mode. This time can be compared with the time taken to rewind the tape. The two times should be approximately equal.)

With the forward and reverse drive speeds the same, the following integral equation can be used to relate the rewind time ( $t_r$ ) and the fast forward time ( $t_f$ ) in terms of the minimum tape radius ( $r_0$ ), the rate of radius change ( $c$ ), and the time ( $t_m$ ) required to rewind the tape from the end to the beginning.

$$\int_0^{t_f} r(r_0 + ct)dt = \int_0^{t_r} r[r_0 + c(t_m - t)]dt$$

This equation can be solved for the fast forward speed:

**Listing 1.**

970	20	D0	D6		JSR	54992
973	A9	10			LDAIM	16
975	2C	10	E8	WAIT1	BIT	59408
978	D0	FB			BNE	WAIT1
980	A0	02	02	NEXT	LDA	514
983	CD	02	02	WAIT2	CMP	514
986	F0	FB			BEQ	WAIT2
988	C6	08			DEC	08
990	D0	F4			BNE	NEXT
992	C6	09			DEC	09
994	10	F0			BPL	NEXT
996	A9	34			LDAIM	52
998	8D	07	02		STA	519
1001	A9	3D			LDAIM	61
1003	8D	13	E8		STA	59411
1006	A9	5F			LDAIM	95
1008	20	D2	FF		JSR	65490
1011	A9	10			LDAIM	16
1013	2C	10	E8	WAIT3	BIT	59408
1016	F0	FB			BEQ	WAIT3
1018	A9	00			LDAIM	00
1020	8D	07	02		STA	519
1023	60				RTS	

$$t_f = (2t_m t_r + k^2 + 2kt_r - t_r^2)^{1/2} - k$$

where

$$k = \frac{t_m t_r - \frac{1}{2}t_r^2 - \frac{1}{2}t_f^2}{t_f - t_r}$$

The value for k can be determined for tapes of various lengths (15 min., 30 min., 60 min., etc.) by running fast forward for a time, measuring the rewind time, and evaluating equation 3. This should be repeated for several different times and an average value obtained for k.

**Program Implementation**

Using the techniques outlined, a tape indexing program can easily be implemented for the PET. Listing 1 gives a machine language program that will run a tape fast forward for a given time and stop the cassette motor. The program is run, after the correct tape has been loaded and rewound, by calling the user function X=USR (TC) where TC, the index time constant, is the number of jiffies required to position the tape correctly. Time is evaluated in jiffies because the PET has a jiffy counter which is convenient to use and the timing resolution provided is quite sufficient.

The program uses several features of the PET's operating system. The subroutine at M54992 converts the argument of the USR function from the floating accumulator to a 16-bit integer with the LSB in M8 and the MSB in M9. Bit 4 of M59408 senses the status of the recorder switches. If any switch of the

recorder is pressed, the content of this bit is 0; otherwise it is 1.

The jiffy counter, which the PET uses as a part of its real-time clock, is located in M514 and is incremented 60 times a second by the operating system. The cassette flag is located in M519. A 52 must be loaded in order to control the recorder motor using the program and then restored to 0 before exiting the program, leaving the recorder under manual control. With the cassette flag set correctly, the recorder can be stopped by the program by loading the value 61 into M59411. Finally, the subroutine at M65490 is used to display a prompt on the video screen informing the user that the tape is positioned and that the "stop" button should be pressed

The positioning program can be called either from a BASIC program or by direct command. Listing 2 is a BASIC program for loading the machine language pro-

gram into memory when the PET is powered up. The program is stored in the upper portion of the number 2 cassette buffer and will remain loaded until the user writes over the memory or the PET is reset. This location leaves available protected memory from M826 to M970 for other machine language programs.

Listing 3 is a BASIC program called TAPE capable of providing several useful functions for a tape indexing system. The program, as currently dimensioned, indexes 10 tapes with up to 10 programs per tape. The functions are available by entering various commands. To position a tape for reading program number k on tape number L, enter R. (The machine language program of Listing 1 is assumed to be loaded.) To update a program name or index time constant in the index, enter a U. The tape number and program number will be requested by the program.

To determine the rewind time and fast forward time for a program number k, enter a T. The tape containing the program to be indexed should be positioned so that it is at the end of the program. If the tape is not at this point it can be positioned by verifying, using the program name (i.e., VERIFY "program name"). This will position the tape correctly, even though a verify error will occur. The time constant measured and displayed using the T command is actually the index time for the program k + 1 and is automatically entered into the index by the T command, so that the U command is not needed.

To look at the index of a given tape, enter I and the tape number. The index will appear on the PET screen with the program number, name, and time constant displayed. To save the index data file, an S command is entered. The index file should be saved if any tape index was updated or added to by using the T command. The data file is placed directly following the BASIC program TAPE on the tape. This is done by verifying TAPE before writing the data file. If the index data file has never been written on tape, the TAPE program should be entered at 10200 (i.e., RUN 10200) instead of 10000 since the first thing the program does is read the data file.

The most important part of the TAPE program is the index time constant

**Listing 2.**

```

00 REM TAPE POSITIONING PROGRAM, X=USR(TC)
10 DATA 32, 208, 214, 169, 16, 44, 16, 232, 208
20 DATA 251, 173, 2, 2, 205, 2, 2, 240, 251
30 DATA 198, 8, 208, 244, 198, 9, 16, 240, 169
40 DATA 52, 141, 7, 2, 169, 61, 141, 19, 232
50 DATA 169, 95, 32, 210, 255, 169, 16, 44, 16
60 DATA 232, 240, 251, 169, 0, 141, 7, 2, 96
70 FOR A=970 TO 1023: READ B : POKE A,B : NEXT
80 POKE 1, 202, : POKE 2,3
90 END

```

determining routine. In order to use the machine language positioning program, all that is needed is the time constant.

If one simply writes the time constant by the program name on his tape label, there is no need for the TAPE program to be used each time a specific program is to be read. Instead, TAPE will most likely be read when index editing or surveying is desired. The pertinent lines for obtaining the index time constant are 14100-14700. The values determined for tm and k in equation 2 were 6000 jiffies and 5000 jiffies respectively, for a 60 minute tape.

Although the constants for a 30 minute tape were somewhat larger than half the 60 minute tape constants, the relatively low degree of accuracy required to position within the 10 second buffer written by the PET prior to each program allows considerable freedom in the selection of the constants. Line 14400 uses the PET BASIC function WAIT to monitor the recorder buttons in measuring the rewind time. The user

### Listing 3.

```
10000 DTM TN$(10,10),TM(10,10)
10050 OPEN1,1,0,"TAPE INDEX"
10070 FORJ=1TO10
10100 FORI=1TO10:INPUT#1,TN$(J,I),T$:TM(J,I)=VAL(T$):NEXT:NEXT
10150 CLOSE1
10200 PRINT"R:READ,U:UPDATE,T:TIME,I:INDEX,S:SAVE"
10250 PRINT"TAPE # & COMMAND":INPUTL,C$
10300 IFC$="R"THEN GOSUB12000:GOTO10200
10400 IFC$="U"THEN GOSUB13000:GOTO10200
10500 IFC$="T"THEN GOSUB14000:GOTO10200
10600 IFC$="I"THEN GOSUB15000:GOTO10200
10700 IFC$="S"THEN GOSUB11000:GOTO10200
10800 PRINT"???:GOTO10200
11000 PRINT"TAPE REWOUND":INPUTY$
11100 VERIFY"TAPE":WAIT59408,16
11200 POKE243,122:POKE244,2:OPEN1,T1,"TAPE INDEX"
11300 FORJ=1TO10
11400 FORI=1TO10:T$=STR$(TM(J,I)):PRINT#1,TN$(J,I),"T$:NEXT
11500 NEXT
11600 CLOSE1:RETURN
12000 PRINT"ENTER PGM # ":INPUTK
12100 PRINT"TAPE ";L;" LOADED & REWOUND":INPUTY$
12200 PRINT"PRESS F-F":X=USR(TM(L,K))
12300 RETURN
13000 PRINT"ENTER PGM # TO UPDATE (0 TO EXIT)":INPUTK
13100 IFK=0THEN RETURN
13200 PRINT"NEW TITLE":INPUTTN$(L,K)
13300 PRINT"NEW TIME":INPUTTM(L,K)
13400 GOTO13000
14000 PRINT"PGM # & TITLE":INPUTK,TN$(L,K)
14100 PRINT"ENTER 1 FOR 30 MIN TAPE, 2 FOR 60 MIN"
14200 INPUTZ:MX=3000*Z:TK=2500*Z
14300 PRINT"PRESS REWIND"
14400 WAIT59408,16,16:T=TI:WAIT59408,16
14500 T=TI-T:PRINT"REWIND TIME = ";T
14600 TM(L,K+1)=INT(SQR(2*MX*T+TK^2+2*TK*T-T^2)-TK)
14700 PRINT"FAST FORWARD TIME = ";TM(L,K+1)
14800 RETURN
15000 PRINT"♥","***TAPE ";L;" INDEX***":PRINT
15100 FORI=1TO10:PRINT"#";I;TN$(L,I);TAB(32);TM(L,I):PRINT:NEXT
15200 RETURN
```

should try to press "stop" as soon as the tape is rewound, since considerable error can be introduced if the rewind time is not measured consistently.

### Final Comments

Perhaps a word of caution is in order. The user should avoid placing programs that may require extensive revisions in the middle portion of a tape, since the revised program might then extend on to the next program on the tape. However, once a program has been developed, the use of multiple files per tape is often quite convenient.

After implementing the tape indexing and positioning programs, I find that I no longer dread the thought of having to read a program from the middle of a cassette. In fact, reading the seventh or eighth program on the tape takes only slightly longer than reading the first program. Hopefully, other PET enthusiasts will find the program useful. In any case, discovering and utilizing some of the "hidden" powers of my PET was half the fun.

## Classified Ads

**PET LANGUAGE MACHINE GUIDE**- comprehensive manual to aid the machine language programmer. More than 30 routines are fully detailed so that the reader can put them to use immediately. Specify old or new ROMS. \$6.95 plus .75 for postage. Visa or Mastercharge accepted. Money back guarantee (10 days).  
Contact:

ABACUS SOFTWARE  
P.O. Box 7211  
Grand Rapids, MI 49510

**NEW BOWLING PROGRAM FOR APPLE**: One to four players compete in a standard bowling game. Challenging game with excellent quality APPLESOFT program. Cassette \$9.95.  
Order from:

C.E. Howerton  
125 Marcella Road  
Hampton, VA 23666

**AIM 65 NEWSLETTER**  
Six bimonthly issues for \$5.00 in U.S. and Can. (\$12.00 elsewhere)  
The Target, c/o Donald Clem  
RR no. 2  
Spencerville, Ohio 45887

Advertising Software for APPLE:  
\$25 buys SCROLLING WONDER, GIANT LETTER, and HI-RES ALPHANUMERICS: on cassette, 16kb. \$25 buys Multi-Message with INTERLEAVED KALEIDOSCOPE, and Multi-Message with INTERLEAVED ABSTRACT ART: on cassette, 32kb. Send check or money order to:  
Connecticut Information Systems  
218 Huntington Rd.  
Bridgeport, CT 06608

**EXTENDED MONITOR** for TIM reads and writes KIM format cassette using comparator and 5 discretes; 7 more commands. 2708 PROM at ECOO for \$28 incl. hardware; + \$7 to relocate. SASA or phone for info:  
Phil Lange  
206 Santa Clara Ave.  
Dayton, Ohio 45405  
(513) 278-0506

**OPTIMIZE APPLESOFT** pgms: shorten variable names; remove remarks and extra colons; concatenate lines; renumber; list variable cross-references. (2) 1.3K programs for (16-48K) Apple II's. Cassette \$15, disc \$20 from:  
Sensible Software  
P.O. Box 2395  
Dearborn, MI. 48123

More Classifieds on page 20.

**MICRO**

### A Warning:

The **MACROTeA™**  
is for Professional  
Programmers — and Very  
Serious Amateurs — Only

Now: a machine language programming powerhouse for the knowledgeable programmer who wants to extend the PET's capabilities to the maximum. The MacroTeA, the Relocating Macro Text Editor:Assembler from Skyles Electric Works.

The Skyles MacroTeA is a super powerful text editor. 26 powerful editing commands. String search and replace capability. Manuscript feature for letters and other text. Text loading and storage on tape or discs. Supports tape drives, discs, CRT, printers and keyboard.

The Skyles MacroTeA is a relocating machine language assembler with true macro capabilities. A single name identifies a whole body of lines. You write in big chunks, examine, modify and assemble the complete program. And, when loading, the MacroTeA goes where you want it to go. Macro and conditional assembly support. Automatic line numbering. Labels up to 10 characters long.

The Skyles MacroTeA is an enhance Monitor. 11 powerful commands to ease you past the rough spots of program debugging.

The Skyles MacroTeA is a warm start button. Over 1700 bytes of protected RAM memory for your object code.

There's no tape loading and no occupying of valuable RAM memory space: The Skyles MacroTeA puts 10K bytes of executable machine language code in ROM (from 9800 to BFFF — directly below the BASIC interpreter). 2K bytes of RAM (9000 to 97FF).

Like all Skyles Products for the PET, it's practically plug in and go. No tools are needed. And, faster than loading an equivalent size assembler/editor from tape, the MacroTeA is installed permanently.

The Skyles MacroTeA: 13 chips on a single PCB. Operates interfaced with the PET's parallel address and data bus or with the Skyles Memory Connector. (When ordering, indicate if the MacroTeA will interface with a Skyles Memory Expansion System. You can save \$20.) Specifications and engineering are up to the proven Skyles quality standards. Fully warranted for 90 days. And, as with all Skyles products, fully and intelligently documented.

VISA, Mastercharge orders call (800) 227-8398 (Except Calif.)  
California orders please call (415) 494-1210.



## Skyles Electric Works

10301 Stonydale Drive, Cupertino, CA 95014, (408) 735-7891

# Subroutine Parameter Passing

Mark Swanson  
177 Hastings Mill Road  
Streamwood, IL 60103

**A technique that makes it easy to pass parameters to subroutines is presented. While this method has been known and used for many years on the big computers, it may be new and useful to many microcomputerists.**

Passing information from a main program to a subroutine is usually done by either pushing it on the stack or storing the information in an area common to both routines. An alternative method involved having the parameters after the subroutine call.

When a jump subroutine is executed the return address is stored on the stack and control is passed to the subroutine. If we put our parameters after the jump subroutine instruction, the return address on the stack will now point to this data. The subroutine can now pull the return address off the stack, fetch the parameters using the return address, increment the return address to skip over the parameters, and use this new address to return to the calling program.

Here is an example of using this method of parameter passing to print a character string. The program MAIN contains a jump subroutine to the subroutine PTRSTR. The address of the beginning of the string follows the JSR

instruction. The end of the string is marked by a zero byte. The routine first references the stack to get the return address and stores this in a temporary zero page location (locations zero and one). Using this address we now can access the string starting address located after the JSR. The string starting address is moved into a temporary zero page location (locations two and three). Using indirect indexed addressing we load a byte of the character string, call a routine which prints a single byte, increments the Y register, and loops until the zero byte is found. After the entire string is printed, we increment the return address by two to skip over the string address parameters. We can now return to the calling program via an indirect jump to the temporary return address locations (locations zero and one).

This method of parameter passing can be very useful when dealing with subroutines that are called frequently or which pass large amounts of data.

```
MAIN PROGRAM      .
                  .
                  JSR  PTRSTR  JUMP TO SUBROUTINE TO PRINT A STRING
                  =      $78    LOW PORTION OF STRING ADDRESS
                  =      $56    HIGH PORTION OF STRING ADDRESS
                  .
                  .
                  .
5678              =      "PRINT THIS MESSAGE"
                  =      $00    HEX ZERO TO MARK END OF STRING
```

### ASSEMBLE LIST

```
0100 ;MOVE TBL 1 TO TBL2
0110      BA $400
0400 -- A/ 0B 0120 LOOP      LDY #00
0402 -- B9 0B 04 0130      LDA TBL1,Y
0405 -- 89 0B 05 0140      STA TBL2,Y
0408 -- C8      0150      INY
0409 D0 F7      0160      BNE LOOP
0170 ;
040B      0180 TBL1      DS 256
050B      0190 TBL2      DS 256
0200 ;
0210      EN
```

LABEL FILE 1 = EXTERNAL

```
START = 0400      LOOP = 0402      TBL1 = 040B
TBL2 = 050B
110000,060B,060B
```



PRINT STRING SUBROUTINE  
MARK SWANSON

SUBROUTINE TO PRINT A STRING OF CHARACTERS

```
023A ZERO * $00E0
023A ONE * $00E1
023A TWO * $00E2
023A THREE * $00E3
023A STACK * $0100
023A PUTCHR * $1234 SOME PRINT CHARACTER SUBROUTINE
```

```
0200 ORG $0200
```

```
0200 D8 PRTSTR CLD CLEAR DECIMAL MODE
0201 BA TSX TRANSFER STACK PTR TO X REG
```

SINCE POINTER ALWAYS POINTS TO NEXT POSITION  
AVAILABLE, INCREMENT BY ONE

```
0202 E8 INX
0203 BD 00 01 LDAX STACK LOAD LOW PORTION OF RETURN ADDRESS
0206 85 E0 STA ZERO SAVE
0208 E8 INX INCR X TO NEXT STACK ENTRY
0209 BD 00 01 LDAX STACK LOAD HIGH PORTION OF RETURN ADDRESS
020C 85 E1 STA ONE SAVE
020E 9A TXS RESET STACK POINTER
020F E6 E0 INCZ ZERO ADDRESS OFF BY 1, SO NOW WE
0211 D0 02 BNE OVER INCREMENT IT
0213 E6 E1 INC ONE HIGH ADDRESS TOO, IF NECESSARY
```

```
0215 A0 00 OVER LDYIM $00 ZERO Y REGISTER
0217 B1 E0 LDAIY ZERO LOAD FIRST PART OF STRING ADDRESS
0219 85 E2 STA TWO SAVE
021B C8 INY BUMP POINTER
021C B1 E0 LDAIY ZERO LOAD SECOND PART OF STRING ADDRESS
021E 85 E3 STA THREE SAVE
```

SUBROUTINE NOW HAS THE STRING ADDRESS  
NOW PRINT STRING UNTIL A HEX 00 IS FOUND

```
0220 A0 00 LDYIM $00 ZERO Y REGISTER
0222 B1 E2 LOOP LDAIY TWO LOAD A CHARACTER OF STRING
0224 F0 06 BEQ FINISH IF EQUAL TO ZERO, FINISHED
0226 20 34 12 JSR PUTCHR SOME SUBROUTINE TO PRINT A CHARACTER
0229 C8 INY INCREMENT POINTER
022A D0 F6 BNE LOOP UNCONDITIONAL
```

```
022C 18 FINISH CLC CLEAR CARRY
022D A5 E0 LDA ZERO INCREMENT RETURN ADDRESS BY
022F 69 02 ADCIM $02 TWO TO SKIP OVER
0231 85 E0 STA ZERO STRING ADDRESS PARAMETERS
0233 90 02 BCC END DONE IF NO CARRY
0235 E6 E1 INC ONE BUMP HIGH ADDRESS IF CARRY
0237 6C E0 E0 END JMI ZERO JUMP INDIRECT TO RESUME MAIN PROGRAM
```

## Is Programming Fun?

Have More Fun,  
Make Fewer Errors,  
Complete Programs Much  
Faster...with the  
**BASIC PROGRAMMER'S  
TOOLKIT™**

Now you can modify, polish, simplify, add new features to your PET programs far more quickly while reducing the potential for error. That all adds up to more fun...and the **BASIC Programmer's Toolkit**.

The magic of the Toolkit: 2KB of ROM firmware on a single chip with a collection of machine language programs available to you from the time you turn on your PET to the time you shut it off. No tapes to load or to interfere with any running programs. And the **Programmer's Toolkit** installs in minutes, without tools.

Here are the 10 commands that can be yours instantly and automatically...*guaranteed* to make your BASIC programming a pleasure:

<b>AUTO</b>	<b>RENUMBER</b>	<b>DELETE</b>
<b>HELP</b>	<b>TRACE</b>	<b>STEP</b>
<b>OFF</b>	<b>APPEND</b>	<b>DUMP</b>
<b>FIND</b>		

Every one a powerful command to insure more effective programming. Like the **HELP** command that shows the line on which the error occurs...and the erroneous portion is indicated in reverse video:

```
HELP
500 J = SQR(A*B/C)
READY
```

...Or the **TRACE** command that lets you see the sequence in which your program is being executed in a window in the upper corner of your CRT:

```
TRACE
READY.
RUN
#100
#110
#150
```

The **Programmer's Toolkit** is a product of Harry Saal and his associates at Palo Alto ICs.

So, if you really want to be into BASIC programming — and you want to have fun while you're doing it, order your **BASIC Programmer's Toolkit** now. We guarantee you'll be delighted with it.

## To Order PROGRAMMER'S TOOLKIT or MacroTeA—

Custom designed to plug into your PET. So, when ordering, please indicate if your Toolkit:

... will be used with the Skyles Memory Expansion System, or	\$80.00*
... will be used with the ExpandaPet, or Expandmem	\$80.00*
... will be used with the PET 2001-8 alone	\$80.00*
<i>(We furnish connectors to the memory expansion bus and to the second cassette interface.)</i>	
... will be used with the PET 2001-16, -32 (chip only)	\$50.00*
... will be used with Skyles MacroTeA	\$50.00*

Your **MacroTeA**. Custom designed for your PET. So specify your PET model when ordering. \$395.00\*

**(Important Savings:** If it's to be used with a Skyles Memory Expansion System, the **MacroTeA** can plug directly into the Skyles connector. **So you save \$20.** The Skyles **MacroTeA** is only \$375.00 when interfaced with the Skyles Memory Expansion System.)

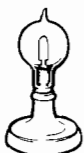

Send your check or money order to Skyles Electric Works. VISA, Mastercharge orders may call (800) 227-8398. (California residents: please phone (415) 494-1210.)

**Ten Day Unconditional Money-Back Guarantee on all products sold by Skyles Electric Works, except chip only.**  
California residents: please add 6-6½% California sales tax.

**Skyles Electric Works** 10301 Stonydale Drive, Cupertino, CA 95014, (408) 735-7891

# PROGRESSIVE SOFTWARE

## Presents Software and Hardware for your APPLE

**SALES FORECAST** provides the best forecast using the four most popular forecasting techniques: linear regression, log trend, power curve trend, and exponential smoothing. Neil D. Lipson's program uses artificial intelligence to determine the best fit and displays all results for manual intervention. **\$9.95**

**CURVE FIT** accepts any number of data points, distributed in any fashion, and fits a curve to the set of points using log curve fit, exponential curve fit, least squares, or a power curve fit. It will compute the best fit or employ a specific type of fit, and display a graph of the result. By Dave Garson. **\$9.95**

**PERPETUAL CALENDAR** may be used with or without a printer. Apart from the usual calendar functions, it computes the number of days between any two dates and displays successive months in response to a single keystroke. Written by Ed Hanley. **\$9.95**

**STARWARS** is Bob Bishop's version of the original and best game of intergalactic combat. You fire on the invader after aligning his fighter in your crosshairs. This is a high resolution game, in full color, that uses the paddles. **\$9.95**

**ROCKET PILOT** is an exciting game that simulates blasting off in a rocket ship. The rocket actually accelerates you up and over a mountain; but if you are not careful, you will run out of sky. Bob Bishop's program changes the contour of the land every time you play the game. **\$9.95**

**SPACE MAZE** puts you in control of a rocket ship that you must steer out of a maze using paddles or a joystick. It is a real challenge, designed by Bob Bishop using high resolution graphics and full color. **\$9.95**

**MISSILE ANTI-MISSILE** displays a target on the screen and a three dimensional map of the United States. A hostile submarine appears and launches a pre-emptive nuclear attack controlled by paddle 1. As soon as the hostile missile is fired, the U.S. launches its anti-missile controlled by paddle 0. Dave Moteles' program offers high resolution and many levels of play. **\$9.95**

**MORSE CODE** helps you learn telegraphy by entering letters, words or sentences, in English, which are plotted on the screen using dots and dashes. Ed Hanley's program also generates sounds to match the screen display, at several transmission speed levels. **\$9.95**

**POLAR COORDINATE PLOT** is a high resolution graphics routine that displays five classic polar plots and also permits the operator to enter his own equation. Dave Moteles' program will plot the equation on a scaled grid and then flash a table of data points required to construct a similar plot on paper. **\$9.95**

**UTILITY PACK 1** combines four versatile programs by Vince Corsetti, for any memory configuration.

### POSTAGE AND HANDLING

Please add \$1.00 for the first item and \$.50 for each additional item.

- Programs accepted for publication
- Highest royalty paid

- **Integer to Applesoft conversion:** Encounter only those syr tax errors unique to Applesoft after using this program to convert any Integer BASIC source.
- **Disk Append:** Merge any two Integer BASIC sources into a single program on disk.
- **Integer BASIC copy:** Replicate an Integer BASIC program from one disk to another, as often as required, with a single keystroke.
- **Applesoft Update:** Modify Applesoft on the disk to eliminate the heading always produced when it is first run.
- **Binary Copy:** Automatically determines the length and starting address of a program while copying its binary file from one disk to another in response to a single keystroke. **\$9.95**

**BLOCKADE** lets two players compete by building walls to obstruct each other. An exciting game written in Integer BASIC by Vince Corsetti. **\$9.95**

**TABLE GENERATOR** forms shape tables with ease from directional vectors and adds additional information such as starting address, length and position of each shape. Murray Summers' Applesoft program will save the shape table anywhere in usable memory. **\$9.95**

**OTHELLO** may be played by one or two players and is similar to chess in strategy. Once a piece has been played, its color may be reversed many times, and there are also sudden reverses of luck. You can win with a single move. Vince Corsetti's program does all the work of keeping board details and flipping pieces. **\$9.95**

**SINGLE DRIVE COPY** is a special utility program, written by Vince Corsetti in Integer BASIC, that will copy a diskette using only one drive. It is supplied on tape and should be loaded onto a diskette. It automatically adjusts for APPLE memory size and should be used with DOS 3.2. **\$19.95**

**SAUCER INVASION** lets you defend the empire by shooting down a flying saucer. You control your position with the paddle while firing your missile at the invader. Written by Bob Bishop. **\$9.95**

### HARDWARE

**LIGHT PEN** with seven supporting routines. The light meter takes intensity readings every fraction of a second from 0 to 588. The light graph generates a display of light intensity on the screen. The light pen connects points that have been drawn on the screen, in low or high resolution, and displays their coordinates. A special utility displays any number of points on the screen, for use in menu selection or games, and selects a point when the light pen touches it. The package includes a light pen calculator and light pen TIC TAC TOE. Neil D. Lipson's programs use artificial intelligence and are not confused by outside light. The hi-res light pen, only, requires 48K and ROM card. **\$34.95**

### TO ORDER

Send check or money order to:

**P.O. Box 273  
Plymouth Meeting, PA 19462**

PA residents add 6% sales tax.

**U.S. and foreign dealer and distributor inquiries invited**

**All programs require 16K memory unless specified**

# APPLE II Hires Picture Compression

---

Every APPLE owner is aware of the wonderful pictures that can be made with the HIRES graphics. A very interesting technique is presented which allows greater efficiency in encoding picture information, and which leads to some additional special effects.

---

Bob Bishop  
213 Jason Way  
Mountain View, CA 94043

Almost every APPLE II owner has, by now, seen examples of how the APPLE II can display digitized photographs in its HIRES graphics mode. These images consist of  $192 \times 280$  arrays of dots all of the same intensity. By clustering these dots into groups (such as in "dithering"), it is even possible to produce pictures having the appearance of shades of gray. Several "slide shows" of these kinds of pictures have been created by both Bill Atkinson and myself and are available through various sources, such as the Apple Software Bank. A typical "slide show" consists of about 11 pictures on a standard 13-sector disk. Why only 11 pictures? Because that's about all that will fit on a 13-sector disk.

Each HIRES picture must reside in one of the two HIRES display areas before it can be seen. The first area,  $\$2000-\$3FFF$ , is called the *primary* display buffer; the second area,  $\$4000-\$5FFF$ , is called the *secondary* display buffer. It is obvious that each of these display areas are 8-K bytes long. Consequently, HIRES pictures are usually stored as 8-K blocks of data, exactly as they appear in a display buffer. But do they have to be stored that way?

If you look closely at a HIRES picture, you can almost always detect small regions that look very similar to other small regions elsewhere in the picture. For example, HIRES displays usually contain regions of pure white or pure black. In the case of dithered pictures, the illusion of gray may be caused by micro-patterns of dots that are similar to other gray patterns somewhere else. Clearly, HIRES pictures tend to contain

a lot of redundancy. If there was some way of removing this redundancy then it would be possible to store HIRES pictures in less than the customary 8-K bytes of memory.

Suppose we were to divide the display into small rectangular clusters, each 7 bits wide, by 7 bits high. Then a picture would consist of 24 rows of these picture elements ("pixels"), with 40 of them per row. (Note the resemblance to the APPLE II's TEXT mode of 24 lines, 40 columns per line!) The total number of pix-

els that would be needed to define a HIRES picture would then be 40 times 24, or 960. However, not all 960 pixels would be unique if there was redundancy in this picture.

To try out these ideas, I used Atkinson's LADY BE GOOD picture (from the Apple Magic Lantern — Slide Show 2) shown in Figure 1, and wrote a program to extract all the different pixels. I found that only 662 of the 960 pixels were unique. This meant that almost one third of the picture was redundant!

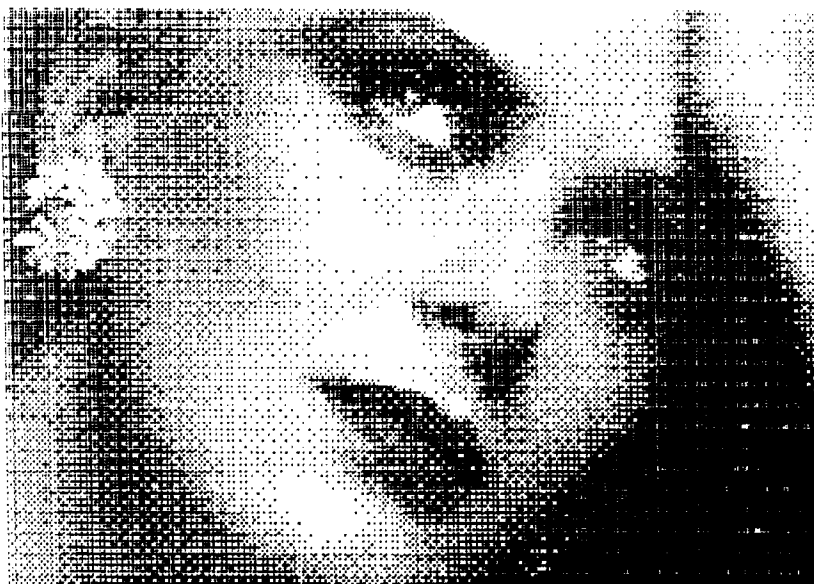

Figure 1: (Max errors/pixel = 0)



Figure 2: (Max errors/pixel = 3)

The next question that came to mind was: of the 622 unique pixels, how 'unique' were they? Was it possible that there might be two or more pixels that were almost the same, except for maybe one or two dots that differed? If so, then it could be possible to regard these as being identical 'for all practical purposes' since the error in the resulting picture would hardly be noticed.

To examine this possibility, I modified my program to extract only those pixels that differed by more than a specified MAX ERRORS/PIXEL. Table 1 shows the results. If we allow, at most, 1 dot to be wrong in any one pixel, then we need only 492 pixels to define the picture, which is only about half of the original 960 pixels! As we allow more and more errors per pixel, the number of pixels required to reconstruct the picture decreases accordingly, until we reach 28 errors/pixel.

At this point we are allowing half of the dots to be wrong. Since total black and total white are always included in every pixel set (to prevent black or white areas from becoming dotted), pictures with MAX ERRORS/PIXEL greater than or equal to 28 can always be composed of no more than two pixels, namely the black and white pixels.

Suppose we now try to reconstruct the original picture from our extracted pixel set. Clearly, the fewer pixels we have available for synthesizing, the poorer the result will be. Figures 2 through 5 show the results of synthesizing LADY BE GOOD with MAX ERRORS/PIXEL of 3, 7, 14, and 28. The number of pixels used in each case was 245, 75, 15, and 2, respectively. Notice that the difference in quality between Figures 1 and 2 is not all that objectionable. The advantage that Figure 2 has is that it can be stored in less than



Figure 3: (Max errors/pixel = 7)

3-K bytes of memory! (245 pixels at 8 bytes/pixel, plus 960 bytes to define which pixels go where.)

Thus it is clearly possible to store an 8-K HIRES picture in considerably less than 8-K bytes, if you are willing to accept a little loss in the image quality. By using this principle, I have produced a "Super Slide Show" containing 33 pictures on a single disk. (Copies may be obtained from Apple's Software Bank.)

SYMBOL	TABLE
BILD	0000
BLUP	0011
LUPE	0017
NEXT	0020
OVER	0031
GOOD	003F
RCON	0080
RLUP	0096
LOOP	00A4
CONT	00B7
INC	00C3
SEND	00D3
NUTO	00F1
RET	00FF
MOVE	1100
MLUP	1107
COMP	1123
CLUP	112E
PREP	1154
INIT	1193
STOR	1200
X40	1220
XAT	0000
YAT	0001
ZAT	0002
XTO	0003
YTO	0004
ZTO	0005
SCOR	0006
XMAX	0007
YMAX	0008
XTMP	0009
YTMP	000A
BEST	000B
AT	000C
TO	000E
ERR	0010
XIN	0011
YIN	0012
PROD	0013
HGR1	0000
HGRH	0000
BITS	1000
BELL	FF3A
END	1261

## The Compression Program

Listings 1 and 2 show the compression routines (and some associated data tables), and require an APPLE II with at least 32-K bytes of memory. The routines consist of two basic parts—the "analysis" portion, and the "synthesis" portion.

The analysis routine (\$0B00) searches the primary HIRES display buffer (\$2000-\$3FFF) and compares each pixel there with the pixels in its own current pixel table (which starts at \$0600) looking for a "match". If it finds a pixel in the table that matches to within the specified MAX ERRORS/PIXEL (location \$10), it calls a match and proceeds to the next pixel in the picture. If it fails to find a match, it adds the pixel to its current pixel table and then proceeds.

The synthesis routine (\$0B80) works in the other direction. It first compares each pixel of the primary buffer with each pixel in the pixel table to find the best match. It then places this pixel in the corresponding location in the secondary HIRES buffer, thus synthesizing the best approximation to the primary picture as it can by using the pixels in its pixel table. (Since the analysis routine doesn't know where its pixel table originated, it is possible to synthesize one picture from another picture's pixels! The result is usually surprisingly good.)

The routines are very easy to use. Simply load the picture to be compressed into \$2000-\$3FFF, set MAX ERRORS/PIXEL into \$10, and then call the routine at \$0B00. When the routine returns, locations \$07 and \$08 contain the number of extracted pixels in the form: NUMBER = 1 + (contents of \$07) + 40 \* (contents of \$08).

To synthesize the picture from the extracted pixels, simply call the routine at \$0B80. When the routine returns, the reconstructed picture will be in the secondary HIRES buffer (\$4000-\$5FFF).

If you have a 48-K APPLE and a disk, you can use the BASIC program shown in Listing 3. This program calls the compression routines (Listings 1 and 2) in a more user-oriented way so that they are even easier to use. The program displays a menu of options that let you:

- L—Load a picture from disk into the primary HIRES buffer
- 1—Display the picture currently in the primary HIRES buffer
- 2—Display the picture currently in the secondary HIRES buffer
- A—Analyze the primary picture (create the pixel table.)
- S—Synthesize the primary picture using the current pixel table.
- D—Issue disk commands.



Figure 4: (Max errors/pixel = 14)

X—Transfer the compressed picture to disk drive number 2.

None of the selections require you to hit RETURN; just hit the corresponding character. When specifying "L", the program will ask you for the name of the file to be loaded. When specifying "A", you will be asked for the minimum error per pixel that you will allow. (This does require a RETURN.). The "D" command will give a colon (:) as the prompt character and will allow you to issue disk commands. It will continue in this mode until you give it a null command (hit RETURN) at which time it will return to the menu. The "X" command saves the compressed picture (960 bytes) and its corresponding pixel table (up to 2K bytes) onto a disk file. (I will leave it up to the interested reader to figure out how to "un-compress" this data.)

### Concluding Remarks

While the methods in this paper work pretty well, they may not represent the optimum way of compressing APPLE II picture data. For example, my choice of 7 x 8 dot pixels was somewhat arbitrary. Is it possible to get better compression ratios by choosing smaller (or larger) pixel sizes?

Another interesting question is: Given a picture that was reconstructed from a given set of N pixels, is it possible to find another set of N pixels that gives a better result?

I hope that these unanswered questions will help motivate someone else into joining the investigation of HIRES picture compressing methods.

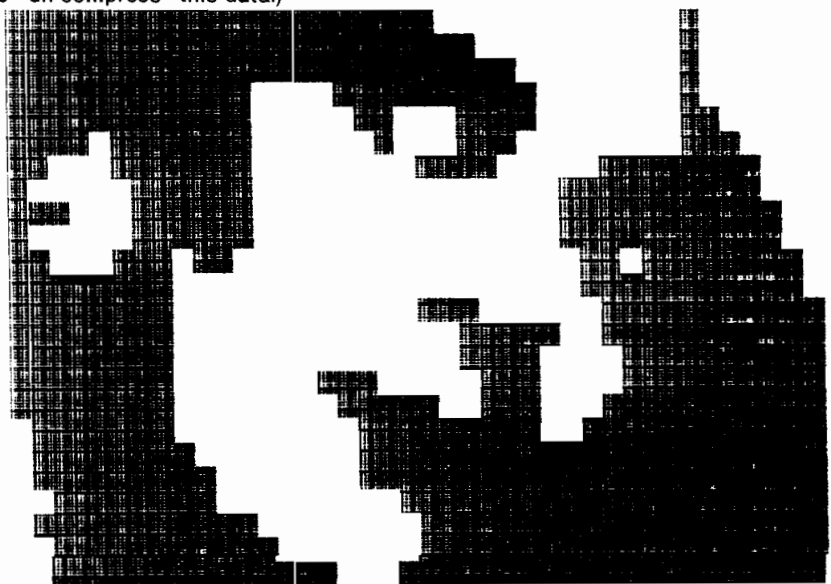
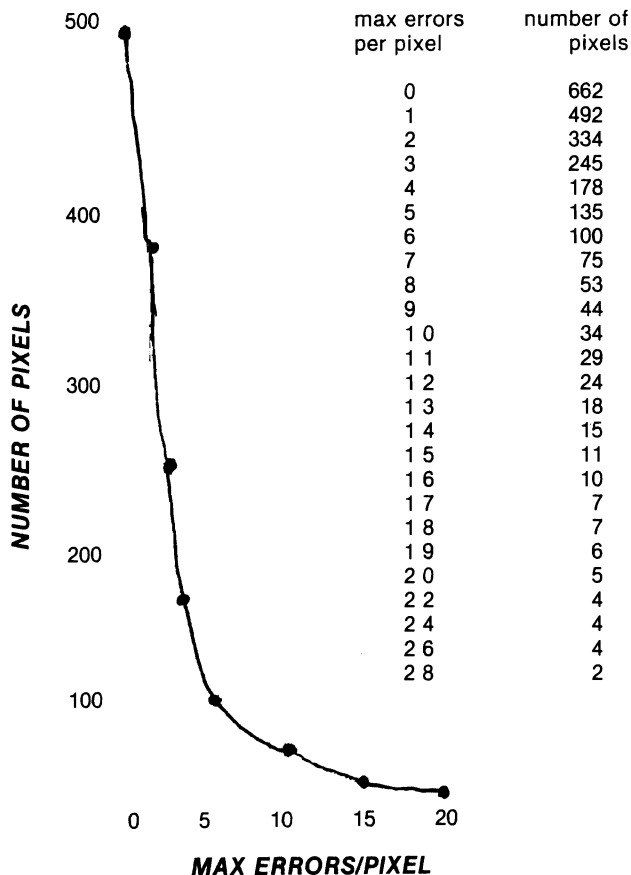

Figure 5: (Max errors/pixel = 28)



## Classified Ads

**SYM-1 OWNERS**—SYM/KIM Appendix to First Book of KIM details changes to KIM games run on BASIC SYM-1. Changes shown line by line, load, modify, and run. Appendix only \$4.25. First Book of KIM \$9., combo both \$12.50 postpaid. Order from:  
 Robert A. Peck  
 P.O. Box 2231  
 Sunnyvale, CA 94087

**DATA ENCRYPTION FOR SUPERBOARD II.** Powerfully secure algorithm, fast and efficient. Video and/or UART I/O. Easy to use software system available on high quality cassette tape. \$21.95 includes detailed instruction manual.  
 D. WOLF, Ph.D.  
 15 Princess Road  
 London, NW1  
 England

: A

Listing 1.

```

0010 : BUILD PIXEL TABLE
0020 :
0030 . OR 0B00
0B00 209311 0040 BILD JSR INIT
0B03 A900 0050 LDA 00
0B05 8500 0060 STA *XAT
0B07 8501 0070 STA *YAT
0B09 A901 0080 LDA 01
0B0B 8502 0090 STA *ZAT
0B0D A903 0100 LDA 03
0B0F 8505 0110 STA *ZTO
0B11 A900 0120 BLUP LDA 00
0B13 8503 0130 STA *XTO
0B15 8504 0140 STA *YTO
0B17 202311 0150 LUPE JSR COMP
0B1A A510 0160 LDA *ERR
0B1C C506 0170 CMP *SCOR
0B1E B01F 0180 BCS GOOD
0B20 A503 0190 LDA *XTO
0B22 C507 0200 CMP *XMAX
0B24 D006 0210 BNE NEXT
0B26 A504 0220 LDA *YTO
0B28 C508 0230 CMP *YMAX
0B2A F005 0240 BEQ OVER
0B2C 20F10E 0250 NEXT JSR NUTO
0B2F D0E6 0260 BNE LUPE
0B31 20F10B 0270 OVER JSR NUTO
0B34 200011 0280 JSR MOVE
0B37 A503 0290 LDA *XTO
0B39 8507 0300 STA *XMAX
0B3B A504 0310 LDA *YTO
0B3D 8500 0320 STA *YMAX
0B3F E600 0330 GOOD INC *XAT
0B41 A500 0340 LDA *XAT
0B43 C920 0350 CMP 20
0B45 D0CA 0360 BNE BLUP
0B47 A900 0370 LDA 00
0B49 8500 0380 STA *XAT
0B4B E601 0390 INC *YAT
0B4D A501 0400 LDA *YAT
0B4F C910 0410 CMP 18
0B51 D0BE 0420 BNE BLUP
0B53 4C3AFF 0430 JMP BELL
0440 :
0450 : RECONSTRUCTION
0460 :
0470 . OR 0B00
0B80 A900 0480 RCON LDA 00
0B82 8D50C0 0490 STA $C050
0B85 8D52C0 0500 STA $C052
0B88 8D55C0 0510 STA $C055
0B8B 8D57C0 0520 STA $C057
0B8E 8503 0530 STA *XTO
0B90 8504 0540 STA *YTO
0B92 A903 0550 LDA 03

```

0B94	8502	0560		STA	*ZAT			1120	:	TO XTO, YTO, ZTO
0B96	A9FF	0570	RLUP	LDA	0FF			1130	:	
0B98	8500	0580		STA	*BEST			1140	:	. OR 1100
0B9A	A900	0590		LDA	00	1100	8A	1150	MOVE	TXA
0B9C	8500	0600		STA	*XAT	1101	48	1160		PHA
0B9E	8501	0610		STA	*YAT	1102	98	1170		TYA
0BA0	A901	0620		LDA	01	1103	48	1180		PHA
0BA2	8505	0630		STA	*ZTO	1104	205411	1190		JSR PREP
0BA4	202311	0640	LOOP	JSR	COMP	1107	A400	1200	MLUP	LDY *XAT
0BA7	A50C	0650		LDA	*SCOR	1109	B10C	1210		LDA (AT ), Y
0BA9	C500	0660		CMP	*BEST	1100	A403	1220		LDY *XTO
0BAE	E00A	0670		BCS	CONT	110D	910E	1230		STA (TO ), Y
0BAD	8500	0680		STA	*BEST	110F	A500	1240		LDA *AT +01
0BAF	A500	0690		LDA	*XAT	1111	6904	1250		ADC 04
0BB1	8509	0700		STA	*XTMP	1113	8500	1260		STA *AT +01
0BB3	A501	0710		LDA	*YAT	1115	A50F	1270		LDA *TO +01
0BB5	850A	0720		STA	*YTMP	1117	6904	1280		ADC 04
0BB7	A500	0730	CONT	LDA	*XAT	1119	850F	1290		STA *TO +01
0BB9	C507	0740		CMP	*YMAX	111B	0A	1300		DEX
0BBB	D006	0750		BNE	INC	111C	D0E9	1310		BNE MLUP
0BBD	A501	0760		LDA	*YAT	111E	68	1320		PLA
0BBF	C500	0770		CMP	*YMAX	111F	A8	1330		TRY
0BC1	F010	0780		BEQ	SEND	1120	68	1340		PLA
0BC3	E000	0790	INC	INC	*XAT	1121	AA	1350		TAX
0BC5	A500	0800		LDA	*XAT	1122	68	1360		RTS
0BC7	C920	0810		CMP	Z0			1370	:	
0BC9	D000	0820		BNE	LOOP			1380	:	COMPARE PIXEL
0BCB	A900	0830		LDA	00			1390	:	AT XAT, YAT, ZAT
0BCD	8500	0840		STA	*XAT			1400	:	TO XTO, YTO, ZTO
0BCF	E601	0850		INC	*YAT			1410	:	
0BD1	D001	0860		BNE	LOOP	1123	8A	1420	COMP	TXA
0BD3	A500	0870	SEND	LDA	*XTMP	1124	48	1430		PHA
0BD5	8500	0880		STA	*XAT	1125	98	1440		TYA
0BD7	A50A	0890		LDA	*YTMP	1126	48	1450		PHA
0BD9	8501	0900		STA	*YAT	1127	205411	1460		JSR PREP
0BD0	A902	0910		LDA	02	112A	A900	1470		LDA 00
0BD0	8505	0920		STA	*ZTO	112C	8506	1480		STA *SCOR
0BDF	200012	0930		JSR	STOR	112E	A400	1490	CLUP	LDY *XAT
0BE2	200011	0940		JSR	MOVE	1130	B10C	1500		LDA (AT ), Y
0BE5	20F100	0950		JSR	NUTO	1132	A403	1510		LDY *XTO
0BE8	A504	0960		LDA	*YTO	1134	510E	1520		EOR (TO ), Y
0BEA	C910	0970		CMP	18	1136	297F	1530		AND 7F
0BEC	D008	0980		BNE	RLUP	1138	A8	1540		TRY
0BEE	4C3AFF	0990		JMP	BELL	1139	B90010	1550		LDA BITS, Y
		1000				113C	6506	1560		ADC *SCOR
0BF1	E603	1010	NUTO	INC	*XTO	113E	8506	1570		STA *SCOR
0BF3	A503	1020		LDA	*XTO	1140	A500	1580		LDA *AT +01
0BF5	C920	1030		CMP	Z0	1142	6904	1590		ADC 04
0BF7	D006	1040		BNE	RET	1144	8500	1600		STA *AT +01
0BF9	A900	1050		LDA	00	1146	A50F	1610		LDA *TO +01
0BFB	8503	1060		STA	*XTO	1148	6904	1620		ADC 04
0BFD	E604	1070		INC	*YTO	114A	850F	1630		STA *TO +01
0BFF	60	1080	RET	RTS		114C	CA	1640		DEX
		1090	:			114D	D0DF	1650		BNE CLUP
		1100	:	MOVE A PIXEL		114F	68	1660		PLA
		1110	:	FROM XAT, YAT, ZAT,		1150	A8	1670		TRY

1151	68	1688	PLA		1186	8587	2240	STA *XMAX
1152	AA	1698	TAX		1188	68	2258	RTS
1153	68	1708	RTS				2268	
		1718	:				2278	. OR 1288
1154	A582	1728	PREP LDA *ZAT		1288	98	2288	STOR TYA
1156	6A	1738	ROR		1281	48	2298	PHA
1157	6A	1748	ROR		1282	A583	2308	LDA *XT0
1158	6A	1758	ROR		1284	8511	2318	STA *XIN
1159	6A	1768	ROR		1286	A584	2328	LDA *YT0
115A	2968	1778	AND 68		1288	8512	2338	STA *YIN
115C	858D	1788	STA *AT +81		128A	282C12	2348	JSR X48
115E	A585	1798	LDA *ZT0		128D	A513	2358	LDA *PROD+88
1160	6A	1808	ROR		128F	858E	2368	STA *T0 +88
1161	6A	1818	ROR		1211	18	2378	CLC
1162	6A	1828	ROR		1212	A514	2388	LDA *PROD+81
1163	6A	1838	ROR		1214	6988	2398	ADC 88
1164	2968	1848	AND 68		1216	858F	2408	STA *T0 +81
1166	858F	1858	STA *T0 +81		1218	A588	2418	LDA *XAT
1168	A581	1868	LDA *YAT		121A	8511	2428	STA *XIN
116A	8A	1878	ASL		121C	A581	2438	LDA *YAT
116B	8A	1888	ASL		121E	8512	2448	STA *YIN
116C	8A	1898	ASL		1220	282C12	2458	JSR X48
116D	AA	1908	TAX		1222	A513	2468	LDA *PROD
116E	8D888C	1918	LDA HGRH, X		1225	A888	2478	LDY 88
1171	858C	1928	STA *AT		1227	918E	2488	STA (T0 ) , Y
1173	8D888D	1938	LDA HGRH, X		1229	68	2498	PLA
1176	291F	1948	AND 1F		122A	A8	2508	TAY
1178	658D	1958	ADC *AT +81		122B	68	2518	RTS
117A	858D	1968	STA *AT +81		122C	A512	2528	X48 LDA *YIN
117C	A584	1978	LDA *YT0		122E	8513	2538	STA *PROD
117E	8A	1988	ASL		1230	A988	2548	LDA 88
117F	8A	1998	ASL		1232	8514	2558	STA *PROD+81
1188	8A	2008	ASL		1234	8613	2568	ASL *PROD
1181	AA	2018	TAX		1236	2614	2578	ROL *PROD+81
1182	8D888C	2028	LDA HGRH, X		1238	8613	2588	ASL *PROD
1185	858E	2038	STA *T0		123A	2614	2598	ROL *PROD+81
1187	8D888D	2048	LDA HGRH, X		123C	8613	2608	ASL *PROD
118A	291F	2058	AND 1F		123E	2614	2618	ROL *PROD+81
118C	658F	2068	ADC *T0 +81		1240	A513	2628	LDA *PROD
118E	858F	2078	STA *T0 +81		1242	8613	2638	ASL *PROD
1190	A288	2088	LDX 88		1244	2614	2648	ROL *PROD+81
1192	68	2098	RTS		1246	8613	2658	ASL *PROD
		2108	:		1248	2614	2668	ROL *PROD+81
1193	28C88C	2118	INIT JSR 88C88		124A	6513	2678	ADC *PROD
1196	A97F	2128	LDA 7F		124C	8513	2688	STA *PROD
1198	8D8168	2138	STA 86881		124E	A514	2698	LDA *PROD+81
119B	8D8164	2148	STA 86481		1250	6988	2708	ADC 88
119E	8D8168	2158	STA 86881		1252	8514	2718	STA *PROD+81
11A1	8D816C	2168	STA 86C81		1254	A513	2728	LDA *PROD
11A4	8D8178	2178	STA 87881		1256	6511	2738	ADC *XIN
11A7	8D8174	2188	STA 87481		1258	8513	2748	STA *PROD
11AA	8D8178	2198	STA 87881		125A	A514	2758	LDA *PROD+81
11AD	8D817C	2208	STA 87C81		125C	6988	2768	ADC 88
11B0	A988	2218	LDA 88		125E	8514	2778	STA *PROD+81
11B2	8588	2228	STA *YMAX		1260	68	2788	RTS
11B4	A981	2238	LDA 81				2798	



```

2800 XAT .DS 0000
2810 YAT .DS 0001
2820 ZAT .DS 0002
2830 XTO .DS 0003
2840 YTO .DS 0004
2850 ZTO .DS 0005
2860 SCOR .DS 0006
2870 XMAX .DS 0007
2880 YMAX .DS 0008
2890 XTMP .DS 0009
2900 YTMP .DS 000A
2910 BEST .DS 000B
2920 AT .DS 000C
2930 TO .DS 000E
2940 ERR .DS 0010
2950 XIN .DL 0011
2960 YIN .DL 0012
2970 PROO .DL 0013
2980 HGRL .DS 0000
2990 HGRH .DS 0000
3000 BITS .DS 1000
3010 BELL .DS FF3A
3020 END .EN

```

Listing 2.

```

0C00- 00 00 00 00 00 00 00 00
0C08- 80 80 80 80 80 80 80 80
0C10- 00 00 00 00 00 00 00 00
0C18- 80 80 80 80 80 80 80 80
0C20- 00 00 00 00 00 00 00 00
0C28- 80 80 80 80 80 80 80 80
0C30- 00 00 00 00 00 00 00 00
0C38- 80 80 80 80 80 80 80 80
0C40- 28 28 28 28 28 28 28 28
0C48- A8 A8 A8 A8 A8 A8 A8 A8
0C50- 28 28 28 28 28 28 28 28
0C58- A8 A8 A8 A8 A8 A8 A8 A8
0C60- 28 28 28 28 28 28 28 28
0C68- A8 A8 A8 A8 A8 A8 A8 A8
0C70- 28 28 28 28 28 28 28 28
0C78- A8 A8 A8 A8 A8 A8 A8 A8
0C80- 50 50 50 50 50 50 50 50
0C88- D0 D0 D0 D0 D0 D0 D0 D0
0C90- 50 50 50 50 50 50 50 50
0C98- D0 D0 D0 D0 D0 D0 D0 D0
0CA0- 50 50 50 50 50 50 50 50
0CA8- D0 D0 D0 D0 D0 D0 D0 D0
0CB0- 50 50 50 50 50 50 50 50
0CB8- D0 D0 D0 D0 D0 D0 D0 D0

0D00- 20 24 28 2C 30 34 38 3C
0D08- 20 24 28 2C 30 34 38 3C
0D10- 21 25 29 2D 31 35 39 3D
0D18- 21 25 29 2D 31 35 39 3D
0D20- 22 26 2A 2E 32 36 3A 3E
0D28- 22 26 2A 2E 32 36 3A 3E
0D30- 23 27 2B 2F 33 37 3B 3F

```

```

0D38- 23 27 2B 2F 33 37 3B 3F
0D40- 20 24 28 2C 30 34 38 3C
0D48- 20 24 28 2C 30 34 38 3C
0D50- 21 25 29 2D 31 35 39 3D
0D58- 21 25 29 2D 31 35 39 3D
0D60- 22 26 2A 2E 32 36 3A 3E
0D68- 22 26 2A 2E 32 36 3A 3E
0D70- 23 27 2B 2F 33 37 3B 3F
0D78- 23 27 2B 2F 33 37 3B 3F
0D80- 20 24 28 2C 30 34 38 3C
0D88- 20 24 28 2C 30 34 38 3C
0D90- 21 25 29 2D 31 35 39 3D
0D98- 21 25 29 2D 31 35 39 3D
0DA0- 22 26 2A 2E 32 36 3A 3E
0DA8- 22 26 2A 2E 32 36 3A 3E
0DB0- 23 27 2B 2F 33 37 3B 3F
0DB8- 23 27 2B 2F 33 37 3B 3F

```

```

1000- 00 01 01 02 01 02 02 03
1008- 01 02 02 03 02 03 03 04
1010- 01 02 02 03 02 03 03 04
1018- 02 03 03 04 03 04 04 05
1020- 01 02 02 03 02 03 03 04
1028- 02 03 03 04 03 04 04 05
1030- 02 03 03 04 03 04 04 05
1038- 03 04 04 05 04 05 05 06
1040- 01 02 02 03 02 03 03 04
1048- 02 03 03 04 03 04 04 05
1050- 02 03 03 04 03 04 04 05
1058- 03 04 04 05 04 05 05 06
1060- 02 03 03 04 03 04 04 05
1068- 03 04 04 05 04 05 05 06
1070- 03 04 04 05 04 05 05 06
1078- 04 05 05 06 05 06 06 07

```

Listing 3.

```

0 REM WRITTEN BY: BOB BISHOP
10 DIM A$(40)
20 ANAL=11*256: SYN=ANAL+120: PRESS=
4096+2*256+8*16
30 FLAG=0: XFLAG=0
100 CALL -936: POKE -16300,0: POKE
-16303,0
110 TAB 17: PRINT "M E N U"
120 TAB 17: PRINT "-----": PRINT

130 PRINT : PRINT " L - LOAD PICTU
RE FROM DISK"
140 PRINT : PRINT " A - ANALYZE PI
CTURE INTO PIXELS"
150 PRINT : PRINT " S - SYNTHESIZE
PICTURE FROM PIXELS"
160 PRINT : PRINT " 1 - DISPLAY OR
IGINAL PICTURE"
170 PRINT : PRINT " 2 - DISPLAY SY
NTHESIZED PICTURE"

```

```

180 PRINT : PRINT " D - ISSUE DISK
    COMMANDS"
190 PRINT : PRINT " X - SAVE COMPRES
    SSED PICTURE TO DISK"
195 VTAB 20: PRINT "SELECTION: "

200 REM READ KEYBOARD
210 CHAR= PEEK (-16384)
220 IF CHAR<128 THEN 210
230 POKE -16384+16,0
300 ID=0
310 IF CHAR= ASC("L") THEN ID=1

320 IF CHAR= ASC("A") THEN ID=2
330 IF CHAR= ASC("S") THEN ID=3
340 IF CHAR= ASC("1") THEN ID=4
350 IF CHAR= ASC("2") THEN ID=5
360 IF CHAR= ASC("D") THEN ID=6
370 IF CHAR= ASC("X") THEN ID=7

400 IF ID=0 THEN 100
500 GOTO 1000*ID
1000 VTAB 20: TAB 12: CALL -958:
    PRINT "LOAD PICTURE"
1005 POKE -16300,0: POKE -16303,
    0
1010 VTAB 22: INPUT "FILE NAME: "
    ,A$
1015 IF A$="" THEN 100
1020 VTAB 22: PRINT "LOAD ";A$:
    ",A$2000.D1."
1050 GOTO 100
2000 VTAB 20: TAB 12: CALL -958:
    PRINT "ANALYZE PICTURE"
2005 POKE -16300,0: POKE -16303,
    0
2010 VTAB 22: INPUT "MAX ERRORS/PIXEL
    : ",MAXERR
2020 POKE 16,MAXERR: CALL ANAL
2025 FLAG=1: XFLAG=0: NUMBER=40* PEEK
    (8)+ PEEK (7)+1
2030 VTAB 22: PRINT "THERE ARE "
    ;NUMBER;" PIXELS WITH MAX ERROR:
    = ";MAXERR
2035 POKE -16384+16,0
2040 IF PEEK (-16384)<128 THEN 2040

2050 GOTO 100
3000 VTAB 20: TAB 12: PRINT "SYNTHESE
    ZE PICTURE"
3005 POKE -16300,0: POKE -16303,
    0: VTAB 22: CALL -958

```

```

3010 FOR K=1 TO 500: NEXT K
3020 IF FLAG THEN 3050
3030 VTAB 22: PRINT "THERE ARE NO PIX
    ELS DEFINED YET!"
3040 GOTO 3060
3050 CALL SYN
3055 XFLAG=1
3060 POKE -16384+16,0
3070 IF PEEK (-16384)<128 THEN 3070

3080 IF PEEK (-16384)= ASC("1") THEN
    210
3085 IF PEEK (-16384)= ASC("2") THEN
    210
3090 GOTO 100
4000 POKE -16304,0: POKE -16303,
    0: POKE -16300,0: POKE -16297
    ,0
4050 GOTO 200
5000 POKE -16304,0: POKE -16303,
    0: POKE -16299,0: POKE -16297
    ,0
5050 GOTO 200
6000 VTAB 20: TAB 12: CALL -958:
    PRINT "DISK COMMAND"
6005 POKE -16300,0: POKE -16303,
    0
6010 VTAB 22: INPUT ":",A$
6015 IF A$="" THEN 100
6020 VTAB 22: TAB 2: PRINT "":A$

6030 PRINT : PRINT : PRINT
6040 GOTO 6010
7000 VTAB 20: TAB 12: CALL -958:
    PRINT "SAVE COMPRESSED PICTURE"

7005 POKE -16300,0: POKE -16303,
    0
7010 IF XFLAG THEN 7025
7015 VTAB 22: PRINT "NO PICTURE HAS B
    EEN SYNTHESIZED YET!"
7020 GOTO 7040
7025 IF NUMBER<=256 THEN 7060
7030 VTAB 22: PRINT "THERE ARE TOO MA
    NY (":NUMBER:") PIXELS"
7040 POKE -16384+16,0
7045 IF PEEK (-16384)<128 THEN 7045

7050 GOTO 100
7060 VTAB 22: INPUT "FILE NAME: "
    ,A$
7065 IF A$="" THEN 100
7070 CALL PRESS
7080 VTAB 22: PRINT "BSAVE ";A$:
    ",A$8000.L": 960+2+8*NUMBER:
    ",D2"
7090 GOTO 100

```

# Software for the Apple II

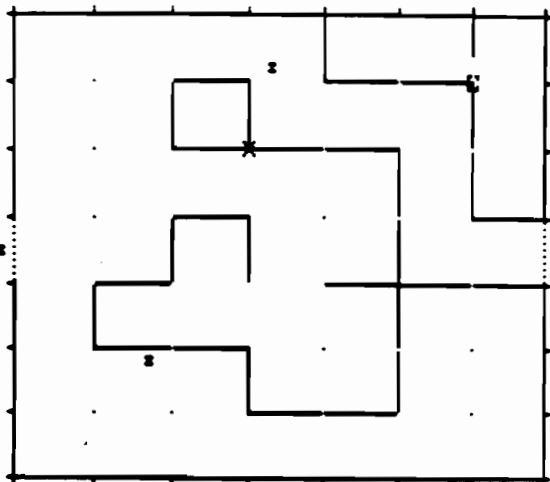

SCORE: 108

**DYNAMAZE**—a dazzling new real-time game. You move in a rectangular game grid, drawing or erasing walls to reflect balls into your goal (or to deflect them from your opponent's goal). Every ball in your goal is worth 100 points, but you lose a point for each unit of elapsed time and another point for each time unit you are moving. Control the speed with a game paddle: play as fast as ice hockey or as slowly and carefully as chess. Back up and replay any time you want to; it's a reversible game. By Don Stone. Integer Basic (plus machine language); 32 K; \$9.95.

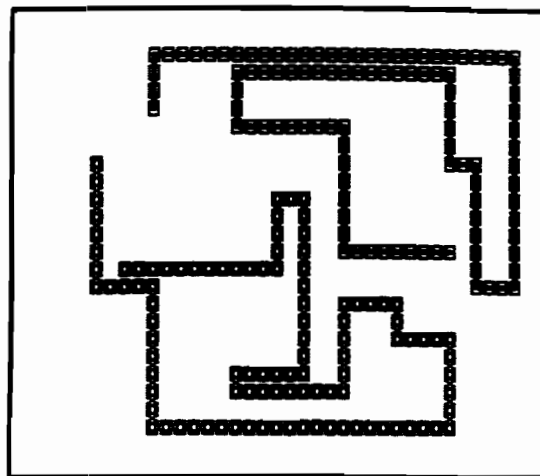

SCORE: 105

**ULTRA BLOCKADE**— the standard against which other versions have to be compared. Enjoy Blockade's superb combination of fast action (don't be the one who crashes) and strategy (the key is accessible open space—maximize yours while minimizing your opponent's). Play against another person or the computer. New high resolution graphics lets you see how you filled in an area—or use reversibility to review a game in slow motion (or at top speed, if that's your style). This is a game that you won't soon get bored with! By Don Stone. Integer Basic (plus machine language); 32 K; \$9.95.

What is a **REVERSIBLE GAME**? You can stop the play at any point, back up and then do an "instant replay", analyzing your strategy. Or back up and resume the game at an earlier point, trying out a different strategy. Reversibility makes learning a challenging new game more fun. And helps you become a skilled player sooner.

**WORLD OF ODYSSEY**—a new adventure game utilizing the full power of Disk II, which enables the player to explore 353 rooms on 6 different levels full of dragons, dwarfs, orcs, goblins, gold and jewels. Applesoft II 48K; \$19.95 includes diskette.

**PERQUACKEY**—an exciting vocabulary game which pits the player against the clock. The object of the game is to form words from a group of 10 letters which the computer chooses at random. The words must be 3 to 10 characters in length with no more than 5 words of any particular length. Each player has only 3 minutes per turn. The larger the words the higher the score. Applesoft II 16K; \$9.95.

**APPLESHIP**—is a naval game in which two players enter their ships in respective oceans. Players take turns trying to blast their opponent's ships out of the water. The first player to destroy their opponent's ships may win the game. A great low-res graphics game. Applesoft II 32K; \$14.95.

Available at your  
local computer store

Call or write for our free  
SOFTWARE CATALOG

Apple II is a registered  
trademark of  
Apple Computer, Inc.

DEALER INQUIRIES INVITED

**POWERSOFT, INC.**

P. O. BOX 157  
PITMAN, NEW JERSEY 08071  
(609) 589-5500

Programs Available on Diskette  
at \$5.00 Additional

- Check or Money Order
- Include \$1.00 for shipping and handling
- C.O.D. (\$1.00 add'l. charge)
- Master Charge and VISA orders accepted
- New Jersey residents add 5% sales tax

# VIDEO PLUS<sup>tm</sup> FOR AIM/SYM/KIM

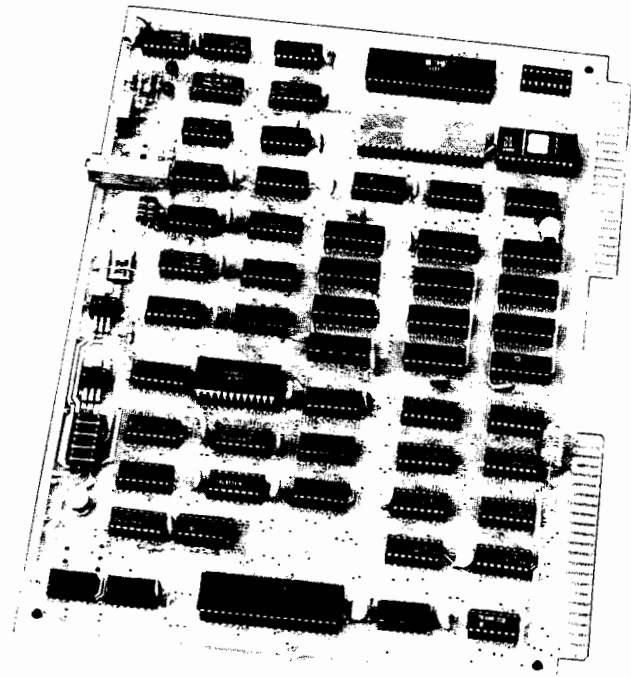

UPPER/lower case ASCII  
128 Additional User Programmable  
Characters: GRAPHICS-  
SYMBOLS-FOREIGN CHARACTERS

Programmable Screen Format up to  
80 CHARACTERS - 24 LINES

KEYBOARD and LIGHT PEN Interfaces  
Up to 4K DISPLAY RAM  
Provision for 2K EPROM  
Provision to add 6502 for  
STAND-ALONE SYSTEM

ASSEMBLED AND TESTED  
WITH 2K DISPLAY RAM

**VIDEO PLUS: \$245<sup>00</sup>**

## IT'S EASY TO ADD VIDEO PLUS<sup>TM</sup> TO YOUR SYSTEM.

VIDEO PLUS is the most powerful expansion board ever offered for 6502 based systems. It has many important video features including:

**Programmable Display Format** - up to 100 characters by 30 lines on a good monitor.

A ROM Character Generator with **UPPER and lower case ASCII** characters.

A **Programmable Character Generator** for up to 128 user defined characters which may be changed under program control. You can define **graphics, music symbols, chess pieces, foreign characters, gray scale** - and change them at will!

May be used with an inexpensive TV set or a quality monitor.

Up to 4K of **Display RAM**, with **Hardware scrolling, programmable cursor**, and more.

In addition to the video features, VIDEO PLUS also has:

A **Keyboard Interface** which will work with any "reasonable" keyboard.

A built-in **Light Pen Interface**.

Provision for a **2K EPROM** or ROM for video control or other software.

All of the memory - 6K RAM and 2K EPROM can be used as system memory whenever it is not in use as display or programmable character generator.

VIDEO PLUS may be used directly as an expansion of an AIM/SYM/KIM system, or has provision for the addition of a 6502 for use as a **Stand-Alone** system or Terminal.

Only requires +5V and has on board voltage regulators. Since it's the same size/shape as the KIM or SYM, it may **easily** be placed under an AIM/SYM/KIM system. It uses the KIM-4 expansion format.

Fully assembled, tested and burned in. Connect directly to your system or via the MOTHER PLUS board.

**NOW AVAILABLE:** AIM software for glass teletype mode. VIDEO PLUS at \$245 includes your choice of video subroutines or the AIM version glass teletype mode. Either tape is available separately for \$10. Specify your choice when ordering.

Prices listed above do not  
include shipping and handling.

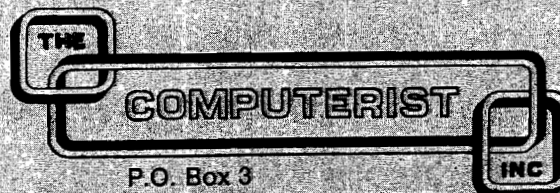

P.O. Box 3  
So. Chelmsford, MA 01824

617/256-3649

# Assembly Language Applesoft Renumber

Alan D. Floeter  
4333 N. 71 Street  
Milwaukee, WI 53216

---

**While there have been a number of programs published for renumbering APPLE BASIC, most have been written in BASIC and have therefore been slow. Here is a version written entirely in assembly language - very fast and very easy to use.**

---

Chuck Carpenter gave a program in the May, 1979 issue of MICRO for renumbering Applesoft programs. Although this is probably adequate for most needs, there were still several drawbacks. Among these are the following:

1. User must make changes in BASIC instructions when the new line number has more digits than the original line number.
2. It is written in BASIC, so therefore, slower than a 6502 assembly language program.
3. The program will take up the same amount of memory, rather than reducing its size when it is possible.
4. User cannot specify only a portion of the program to be renumbered.
5. The program did not work for all types of IF-THEN statements.

Being a software person, I found it difficult to turn down the challenge to answer these deficiencies. The results of my efforts are contained in the following assembly language program.

To load the program, type in the hex numbers in the disassembled listing. This is written for a 32K or larger APPLE system. If you have a smaller system, you can go through the effort of relocating the program by hand. If you do relocate, be aware that the symbol table is stored at 7000 and continues as needed, using two bytes per line number. (A cassette version is available for \$5 for any size system by contacting me. Make sure you state the amount of memory that you have. I will also give you a copy of this program at any other special memory location if you have a need for this.) Record from 6C00 to 6F9C.

To execute the renumberer, load your Applesoft program, Hit reset and load the binary executable renumber pro-

gram. Type: 6C00G. You will now see a flashing cursor. Enter the line number in the Applesoft program where the renumbering will begin. Then enter the next statement number you do not want renumbered. Finally, enter the new line number to start with, followed by the increment between line numbers.

When the program is finished, (normally under 30 seconds,) type: 0G, and your program is renumbered. You can now record it, or continue developing it as normal.

An example of executing the program is as follows:

```
52 (Start at line number 52...)
512 (And stopping before line
512...)
60 (Renumber, start with line 60)
10 (And go in increments of 10)
0G (And carry on!)
```

```

0C00- A9 B0 LDA #SBO
0C02- B0 E3 OF STA >OF E3
0C05- A9 00 LDA #S00
0C07- B5 FC STA >FC
0C09- A9 02 LDA #S02
0C0B- B5 FD STA >FD
0C0D- 20 EB OD JSR $ODEB
0C10- AD F4 OF LDA >OFF4
0C13- B0 E7 OF STA >OFF7
0C16- AD F5 OF LDA >OFF5
0C19- B0 E8 OF STA >OFF8
0C1C- 20 EB OD JSR $ODEB
0C1F- AD F4 OF LDA >OFF4
0C22- B0 E5 OF STA >OFF5
0C25- AD F5 OF LDA >OFF5
0C28- B0 E6 OF STA >OFF6
0C2B- 20 EB OD JSR $ODEB
0C2E- AD F4 OF LDA >OFF4
0C31- B0 FE OF STA >OFFE
0C34- AD F5 OF LDA >OFF5
0C37- B0 FF OF STA >OFFF
0C3A- 20 EB OD JSR $ODEB
0C3D- AD F4 OF LDA >OFF4
0C40- B0 FC OF STA >OFFC
0C43- AD F5 OF LDA >OFF5
0C46- B0 FD OF STA >OFFD
0C49- A9 30 LDA #>30
0C4B- B0 E3 OF STA >OFF E3
0C4E- A9 70 LDA #>70
0C50- B5 FF STA >FF
0C52- A9 00 LDA #>00
0C54- B5 FE STA >FE
0C56- AD FE OF LDA >OFFE
0C59- B0 FO OF STA >OFFO

```

```

0C5C- A9 00 LDA #>00
0C5E- B0 F8 OF STA >OFF8
0C61- B0 F9 OF STA >OFF9
0C64- AD FF OF LDA >OFFF
0C67- B0 F7 OF STA >OFF7
0C6A- A5 07 LDA >07
0C6C- B5 FC STA >FC
0C6E- A5 06 LDA >06
0C70- B5 FD STA >FD
0C72- A0 00 LDY #>00
0C74- B1 FC LDA (>FC), Y
0C76- 48 PHA
0C78- C8 INY
0C7A- B1 FC LDA (>FC), Y
0C7C- 48 PHA
0C7E- F0 00 BEQ $OCDD
0C80- C8 INY
0C82- A2 00 LDX #>00
0C84- B1 FC LDA (>FC), Y
0C86- C0 E7 OF CMP >OFFE7
0C88- C8 INY
0C8A- B1 FC LDA (>FC), Y
0C8C- ED E8 OF SBC >OFFE8
0C8E- 90 47 BCC >OCDD4
0C90- B1 FC LDA (>FC), Y
0C92- C0 E5 OF CMP >OFFE5
0C94- C8 INY
0C96- B1 FC LDA (>FC), Y
0C98- ED E6 OF SBC >OFFE6
0C9A- B0 42 BCS $OCDD
0C9C- 88 DEY
0C9E- B1 FC LDA (>FC), Y
0CA0- B1 FE STA (>FE, X)
0CA2- C8 INY
0CA4- E0 FE INC >FE
0CA6- B1 FC LDA (>FC), Y
0CA8- B1 FE STA (>FE, X)
0CAA- E0 FE INC >FE
0CAC- D0 02 BNE $OCAD
0CAE- E0 FF INC >FF
0CAD- EE F8 OF INC >OFFF8
0CAE- D0 03 BNE $OCB5
0CB0- EE F9 OF INC >OFFF9
0CB2- 88 DEY
0CB4- AD F0 OF LDA >OFFF0
0CB6- 91 FC STA (>FC), Y
0CB8- C8 INY
0CBA- AD F7 OF LDA >OFFF7
0CBC- 91 FC STA (>FC), Y
0CC0- 18 CLC
0CC2- AD F0 OF LDA >OFFF0
0CC4- 0D FC OF ADC >OFFFC
0CC6- B0 F0 OF STA >OFFF0
0CC8- AD F7 OF LDA >OFFF7
0CCA- 0D FD OF ADC >OFFFD
0CCD- B0 F7 OF STA >OFFF7
0CCF- 88 DEY
0CD1- B0 F7 OF STA >OFFF7
0CD3- 88 DEY
0CD5- B5 FD STA >FD
0CD7- 08 PLA
0CD9- B5 FC STA >FC
0CDB- 18 CLC
0CDD- 90 75 BCC >OC72
0CDE- 08 PLA
0CDF- AA PLA
0CE1- A5 07 LDA >07
0CE3- A5 08 LDA >08
0CE5- B5 FD STA >FD
0CE7- A0 00 LDY #>00
0CE9- B1 FC LDA (>FC), Y
0CEB- 38 SEC
0CEC- E5 FC SBC >FC
0CEE- AA IAX
0CEF- CA DEX
0CF0- CA DEX
0CF2- CA DEX
0CF4- A0 04 LDY #>04
0CF6- B1 FC LDA (>FC), Y
0CF8- C9 B0 CMP #>B0
0CFA- F0 25 BEQ >OD20
0CFB- C9 AB CMP #>AB
0CFD- F0 21 BEQ >OD20

```

```

0CFF- C9 C4 CMP #>C4
0D01- F0 1D BEQ >OD20
0D03- C8 INY
0D04- CA DEX
0D05- D0 EE BNE >OCFF5
0D07- 98 TYA
0D08- A0 01 LDY #>01
0D0A- 18 CLC
0D0B- B5 FC ADC >FC
0D0D- B5 FC STA >FC
0D0F- 90 02 BCC >OFF3
0D11- E0 FD INC >FD
0D13- B1 FC LDA (>FC), Y
0D15- D0 D0 BNE >OFF7
0D17- A5 B0 LDA >B0
0D19- B5 0A STA >0A
0D1B- A5 AF LDA >AF
0D1D- B5 09 STA >09
0D1F- 00 RTS
0D20- C8 INY
0D21- CA DEX
0D22- F0 E3 BEQ $ODO7
0D24- 20 F0 OD JSR >OFFF0
0D27- AD EE OF LDA >OFFEE
0D2A- F0 C9 BEQ >OFF5
0D2C- 98 TYA
0D2E- 48 PHA
0D2F- AD FE OF LDA >OFFFE
0D31- B0 F0 OF STA >OFFF0
0D34- AD FF OF LDA >OFFFF
0D37- B0 F7 OF STA >OFFF7
0D3A- A9 00 LDA #>00
0D3C- B0 F2 OF STA >OFFF2
0D3E- B0 F3 OF STA >OFFF3
0D40- A9 70 LDA #>70
0D42- B5 FF STA >FF
0D44- A9 00 LDA #>00
0D46- B5 FE STA >FE
0D48- A0 00 LDY #>00
0D4A- B1 FE LDA (>FE), Y
0D4C- C8 INY
0D4E- C8 INY
0D4F- C0 F4 OF CMP >OFFF4
0D51- D0 07 BNE $OD5B
0D53- B1 FE LDA (>FE), Y
0D55- C0 F5 OF CMP >OFFF5
0D57- F0 47 BEQ >OD5A2
0D59- 88 DEY
0D5B- E0 FE INC >FE
0D5E- E0 FE INC >FE
0D60- D0 02 BNE $OD64
0D62- E0 FF INC >FF
0D64- 18 CLC
0D65- AD F0 OF LDA >OFFF0
0D68- 0D FC OF ADC >OFFFC
0D6B- B0 F0 OF STA >OFFF0
0D6E- AD F7 OF LDA >OFFF7
0D71- 0D FD OF ADC >OFFFD
0D74- B0 F7 OF STA >OFFF7
0D77- EE F2 OF INC >OFFF2
0D7A- D0 03 BNE >OD7F
0D7C- EE F3 OF INC >OFFF3
0D7E- AD F2 OF LDA >OFFF2
0D81- C0 F8 OF CMP >OFFF8
0D83- D0 C5 BNE >OD8C
0D85- 08 PLA
0D87- AD F3 OF LDA >OFFF3
0D8A- C0 F9 OF CMP >OFFF9
0D8D- D0 B0 BNE >OD8C
0D8F- 08 PLA
0D91- A8 LAY
0D93- B1 FC LDA (>FC), Y
0D95- C9 30 CMP #>30
0D97- 90 4A BCC >ODE1
0D99- C9 3A CMP #>3A
0D9B- B0 40 BCS >ODE1
0D9D- C8 INY
0D9F- CA DEX
0DA1- D0 F2 BNE >OD91
0DA3- 4C 07 OD JMP >ODD7
0DA5- 20 32 OF JSR >OFF32
0DA7- 08 PLA
0DA9- A8 LAY
0DAB- A9 00 LDA #>00
0DAC- B0 F1 OF STA >OFFF1
0DAD- AD F0 OF LDA >OFFF0

```

**EPROM PROGRAMMER  
Model EP-2A-79**

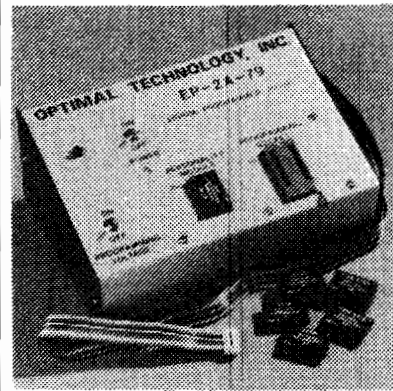

SOFTWARE AVAILABLE FOR F-8, 8080, 6800, 8085, Z-80, 6502, KIM-1, 1802, 2650. EPROM type is selected by a personality module which plugs into the front of the programmer. Power requirements are 115 VAC, 50/60 HZ at 15 watts. It is supplied with a 36 inch ribbon cable for connecting to microcomputer. Requires 1 1/2 I/O ports. Priced at \$155 with one set of software. Personality modules are shown below.

Part No.	Programs	Price
PM-0	TMS 2708	\$15.00
PM-1	2704, 2708	15.00
PM-2	2732	30.00
PM-3	TMS 2716	15.00
PM-4	TMS 2532	30.00
PM-5	TMS 2516, 2716, 2758	15.00

**Optimal Technology, Inc.**  
Blue Wood 127, Earlysville, VA 22936  
Phone (804) 973-5482



# Performing Math Functions in Machine Language

Alfred J. Bruey  
201 S. Grinnell Street  
Jackson, MI 49203

---

**If you are afraid to try doing mathematical functions in assembly language, then this article may help you get started.**

---

Since addition, subtraction and shifting are the only arithmetic functions available in machine language for most small computers, it becomes necessary to find methods to perform other mathematical operations using addition, subtraction, and shifts in combination with other commands available on the programmer's microprocessor.

Multiplication is an example of an operation that is commonly performed in this way. Let's look at a particular example. Suppose we want to multiply 187 by 345. It is obvious that we can clear a register and add 187 a total of 345 times to arrive at the answer, but we soon discover that it is more efficient to perform the same function by combining additions with shifts.

Using the shift command, we would add 3 187s, then shift left, then add 4 187s, the shift left, then add 5 187s to arrive at the final product. Thus, we have replaced 345 additions with 12 additions and 2 shifts. In the same way, repeated subtractions may be combined with shifts to implement a division algorithm.

Division and multiplication algorithms are often described in the programming manuals that come with a computer. A programmer soon needs other mathematical functions and must find a way to perform them with a limited instruction set and limited computer memory. If the

functions become too complicated, one must add memory or go to a higher level language, such as BASIC.

The purpose of this article is to demonstrate the power of the lowly addition and subtraction commands by developing an algorithm for extracting the square root of a number. The algorithm is described and a flow chart is presented along with a 6502 listing for the KIM-1.

The square root algorithm to be presented here is based on the equation:

$$\sum_{k=1}^n (2k-1) = n^2; n \text{ an integer greater than } 0$$

which says, in English, that the sum of the first  $n$  odd integers is equal to the square of  $n$ . For example:

$$1 + 3 + 5 + 7 + 9 = 25 = 5^2$$

That is, the sum of the first 5 odd integers is equal to  $5^2$ , or 25. This equation is easily proven true for all positive integers by mathematical induction.

The method implemented here is to subtract first 1, then 3, then 5, and so on, from the number whose square root is desired. The number of subtractions, less 1, that it takes to reduce the original number to a nonzero negative number is the square root. For example, if  $X = 25$ :

$$\begin{aligned} 25-1 &= 24; 24-3 = 21; 21-5 = 16 \\ 16-7 &= 9; 9-9 = 0; 0-11 = 11 \end{aligned}$$

Since it took 6 subtractions to reduce 25 to a number less than 0, the answer is  $6 - 1 = 5$ . Notice that this method gives only the integer part of the answer, so if  $X$  had been any value from 25 to 35, you would have arrived at the same answer. Remember—when you take the square root of a number, your answer has only about half as many significant digits as the number.

The original value (NUM) is placed in the accumulator. The answer will be in the Y register and also displayed on the KIM's seven segment LEDs (POINTH). Notice that the algorithm as described below will not handle very large numbers. To use this for practical problems, it will have to be extended to multiple precision.

The coding to implement the routine is given below. While the addresses are given for the KIM-1, a few address changes should make it possible to implement this routine on any other 6502 based system. The number you want the square root of goes in location 0001, then set the address to 0000 and GO. The answer will be displayed in POINTH, the left two LEDs of the KIM display. The code given is probably not optimum—I am a relative newcomer to machine language coding. If you come with an improved version of this routine, I'd appreciate receiving a copy of it. The example shown is set to take the square root of \$10.



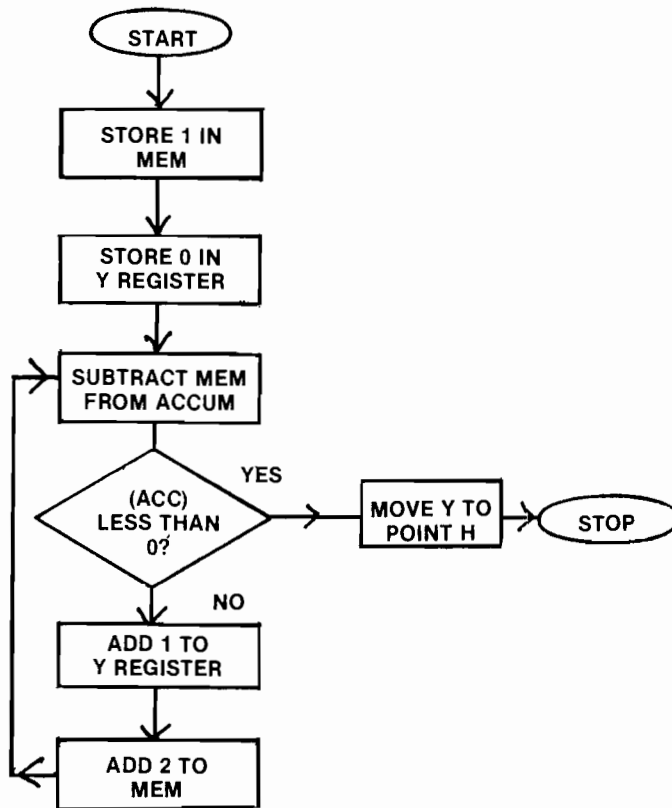

Flowchart

```

0000:
0010: SQUARE ROOT ROUTINE
0020:
0030: ALFRED J. BRUEY
0040:
0050: 0000 GEG 00000
0060:
0070: 0000 MEM * 0001A
0080: 0000 POINTH * 000FB
0090: 0000 START * 01C4F
0100:
0110: 0000 A9 10 BEGIN LDAM $10
0120: 0002 A0 01 LDYH $01
0130: 0004 86 1A STY MEM
0140: 0006 A0 00 LDYH $00
0150:
0160: 0008 38 LOOP SEC
0170: 0009 E5 1A SBC MEM
0180: 000B 30 08 LMT STOP
0190: 000D C8 JFY
0200: 000E E6 1A INC MEM
0210: 0010 E6 1A INC MEM
0220: 0012 4C 08 00 JNF LOOP
0230:
0240: 0015 84 FB STOP STY POINTH
0250: 0017 4C 4F 1C JMP START
0260:
ID=
  
```

## KIM/SYM/AIM-65—32K EXPANDABLE RAM

### DYNAMIC RAM WITH ON BOARD TRANSPARENT REFRESH THAT IS COMPATIBLE WITH KIM/SYM/AIM-65 AND OTHER 6502 BASED MICROCOMPUTERS.

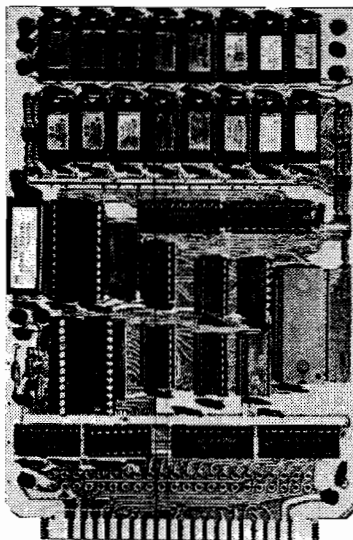

- \* PLUG COMPATIBLE WITH KIM/SYM/AIM-65. MAY BE CONNECTED TO PET USING ADAPTOR CABLE. SS44-E BUS EDGE CONNECTOR.
- \* USES +5V ONLY (SUPPLIED FROM HOST COMPUTER BUS). 4 WATTS MAXIMUM.
- \* BOARD ADDRESSABLE IN 4K BYTE BLOCKS WHICH CAN BE INDEPENDENTLY PLACED ON 4K BYTE BOUNDARIES ANYWHERE IN A 64K BYTE ADDRESS SPACE.
- \* BUS BUFFERED WITH 1 LS TTL LOAD.
- \* 200NSEC 4116 RAMS.
- \* FULL DOCUMENTATION
- \* ASSEMBLED AND TESTED BOARDS ARE GUARANTEED FOR ONE YEAR, AND PURCHASE PRICE IS FULLY REFUNDABLE IF BOARD IS RETURNED UNDAMAGED WITHIN 14 DAYS.

	ASSEMBLED/ TESTED	KIT
WITH 32K RAM .....	\$495.00	\$459.00
WITH 16K RAM .....	\$425.00	\$389.00
WITHOUT RAM CHIPS .....	\$355.00	\$319.00
HARD TO GET PARTS ONLY (NO RAM CHIPS) .....		\$180.00
BARE BOARD AND MANUAL .....		\$85.00

### PET INTERFACE KIT \$49.00

CONNECTS THE ABOVE 32K EXPANDABLE RAM TO A 4K OR 8K PET. CONTAINS EXPANSION INTERFACE CABLE, BOARD STANDOFFS, POWER SUPPLY MODIFICATION KIT AND COMPLETE INSTRUCTIONS.

**16K X 1 DYNAMIC RAM**  
THE MK4116-3 IS A 16,384 BIT HIGH SPEED NMOS DYNAMIC RAM. THEY ARE EQUIVALENT TO THE MOSTEK, TEXAS INSTRUMENTS, OR MOTOROLA 4116-3.  
\* 200 NSEC ACCESS TIME. 375 NSEC CYCLE TIME.  
\* 16 PIN TTL COMPATIBLE.  
\* BURNED IN AND FULLY TESTED.  
\* PARTS REPLACEMENT GUARANTEED FOR ONE YEAR.  
**\$9.50 EACH IN QUANTITIES OF 8**

**MOTOROLA MEMORY ADDRESS MULTIPLEXER—MC 3242A**  
THE MC 3242A IS AN ADDRESS MULTIPLEXER AND REFRESH COUNTER FOR 16 PIN, 16K DYNAMIC RAMS THAT REQUIRE A 128 CYCLE REFRESH.  
\* CONTAINS MEMORY REFRESH COUNTER.  
\* MULTIPLEXES SYSTEM 14 BIT ADDRESS TO THE 7 ADDRESS PINS OF THE RAMS.  
\* COMPATIBLE WITH 3480 MEMORY CONTROLLER.  
\* PART IS GUARANTEED.  
**\$12.50 EACH**

**MOTOROLA DYNAMIC MEMORY CONTROLLER—MC3480L**  
MEMORY CONTROLLER DESIGNED TO SIMPLIFY CONTROL OF 16 PIN 4K OR 16K DYNAMIC RAMS.  
\* GENERATES RAS/CAS AND REFRESH TIMING SIGNALS FOR 16K TO 64K BYTE MEMORIES.  
\* GENERATES MEMORY READ/WRITE TIMING.  
\* DIRECT INTERFACE WITH MOTOROLA OR INTEL 3242A ADDRESS MUX AND REFRESH COUNTER.  
\* PART GUARANTEED.  
**\$13.95 EACH**

**6502, 64K BYTE RAM AND CONTROLLER SET**  
MAKE 64K BYTE MEMORY FOR YOUR 6800 OR 6502. THIS CHIP SET INCLUDES:  
\* 32 MK4116-3 16K X 1, 200 NSEC RAMS.  
\* 1 MC3480 MEMORY CONTROLLER.  
\* 1 MC3242A MEMORY ADDRESS MULTIPLEXER AND COUNTER.  
\* DATA AND APPLICATION SHEETS. PARTS TESTED AND GUARANTEED.  
**\$325.00 PER SET**

BETA COMPUTER DEVICES  
P.O. BOX 3465  
ORANGE, CALIFORNIA 92665  
(714) 633-7260

CAD PAPER ORDERS PLEASE ADD 6% SALES TAX.  
MASTERCARD & VISA ACCEPTED. PLEASE  
ALLOW 14 DAYS FROM CHECKS TO CLEAR BANK.  
PHONE ORDERS WELCOME.

ALL ASSEMBLED BOARDS AND MEM-  
ORY CHIPS CARRY A FULL ONE YEAR  
REPLACEMENT WARRANTY.

EPRGM  
2716-450NSEC..... \$49.00

# Apple<sup>®</sup> computer

Apple II Reference Manual	\$10.00
Apple Soft Manual	10.00
Programmer's Guide (Computer Station)	5.95
Apple II Monitor Peeled	9.95
Software Directory for Apple	
• Business, Finance & Utility	4.95
• Games, Demo, Utility	4.95
Best of Contact '78	2.50
Programming in PASCAL (Grogono)	9.90

<b>INTERFACE CARDS</b>	
Prototyping/Hobby Card	\$ 24.00
Parallel Printer Interface Card	180.00
Communications card & DB25 Connector Cable	225.00
High-Speed Serial Interface Card	195.00
Language System with Pascal (48K RAM & Disk II Required)	495.00
Applesoft II Firmware Card	200.00
16 Input Analog Card	295.00

<b>ACCESSORIES</b>	
Disk II—Drive Only	495.00
Disk II—Drive & Controller (32K Min. RAM Recommended)	595.00
Vinyl Carrying Case	30.00
Tape Recorder	40.00
Programmer's Aid No. 1 Firmware (For Use with Integer BASIC)	50.00
Clock/Calendar Card	199.00
Auto-Start ROM Package (For Apple II Only)	65.00
Digitizer Pad by Talos (kitform)	499.00

High Resolution Light Pen	199.00
Micromodem (D.C. Hayes)	379.00
12" B/W Leebex Monitor	149.00
Cable from Monitor to Apple II	9.95
13" Color TV Compatible with Apple II	290.00
Sup-R-Modulator (RF)	25.00
<b>SOFTWARE FOR APPLE II</b>	
PASCAL from Programma	49.95
FORTH	49.95
LISP—from Apple Software Bk No. 3	N/C
LISA—Interactive disk assembler	34.95
WHATSI?—Excellent conversational data base manager	32K 100.00 48K 125.00
SARGON—Champ of 2nd West Coast Computer Fair	19.95
APPLE PIE—Excellent text editor	24.95
FORTE—Music editor in hires	19.95
FASTGAMMON—Excellent backgammon game with graphics	Tape 20.00 Disk 25.00
APPLE 21—Excellent blackjack game	9.95
BRIDGE CHALLENGER—Computer Bridge	14.95
<b>FINANCIAL MANAGEMENT SYSTEM</b>	
• Accounts Payable	• Ledger Processing
• Accounts Receivable	• Payroll
• Inventory Control	• \$800 Complete
• \$200 Each Package	• \$10 for Manual
<b>PRINTER SPECIALS FOR APPLE AND PET</b>	
TRENDCOM 100 with interface for Apple or PET	450.00
LITE PEN used with TV or monitor screen	34.95
ALF Music Synthesizer Boards	265.00
Supertalker	279.00
Aradex DP-3000 with tractor 8" paper width and interface to Apple	1050.00
Centronics 779-2 for Apple II with parallel interface	1245.00
<b>SOFTWARE (Send For Complete Software Catalog \$1.00)</b>	
Dow Jones Portfolio Evaluator/Stock Quote Reporter Disk	50.00
Microchess 2.0 Chess Disk	25.00
Disk Utility Pack with DOS 3.2	25.00
The Controller (General Business System)	625.00
Apple Post (Mailing List System)	49.95
Bowling Program Diskette	15.00
The Cashier (Retail Store Management)	250.00
Checkbook Cassette	20.00
Applesoft II Language & Demo Cassette	20.00
RAM Test Tape with Manual	7.50
Finance 1-2 Cassette Package	25.00
Datamover/Teleponing Cassette (Com. Card & Modem Req'd)	7.50
Microchess 2.0 Chess Tape	20.00
Bowling Program Tape	15.00
Pascal with Language System (48K RAM & Disk II Required)	495.00

## New for Apple Computer Owners at Low ComputerWorld Prices

8" Disk Drives with housing \$1295.00 for single drive \$1895.00 for dual drive

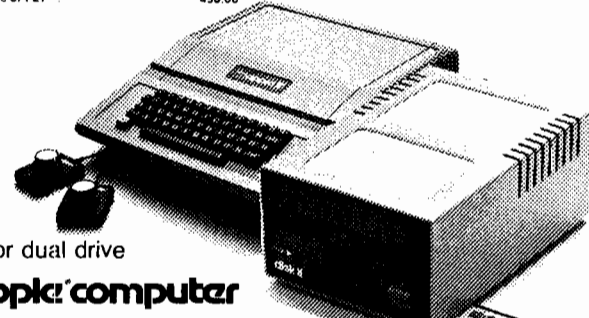

## A PROFESSIONAL BUSINESS SYSTEM



2001-8	\$795	CBM 2023	
2001-16N	\$995	Printer	\$849
2001-32N	\$1295	IEEE to IEEE	
2001-32B	\$1295	Cable	\$49.95
External Cassette	\$95	CBM 2040	\$1295
PET to IEEE Cable	\$39.95	2001-16B	\$995



**Join Now**

Become a member of ComputerWorld's RAYGAMCO Computer Discount Club. By being a RAYGAMCO Member you receive substantial discounts on every item you purchase, including all hardware, software, accessories, even books and paper! You will also receive a monthly newsletter with all the latest available for your particular computer system, and much, much more — exclusive to RAYGAMCO Members only!

### Here's how to join.

Nothing to buy. Simply complete the self-addressed postcard in this magazine with name, address, and your computer system. You'll receive your personalized RAYGAMCO Computer Discount Club Membership Card in the mail with information on how to use your card when ordering for big savings!

**Charter RAYGAMCO Members' Special. Join now and receive 20% OFF of any purchase.\***

\*20% offer expires December 24, 1979. Offer is valid for RAYGAMCO Members only.

apple computer  
Joystick for Apple II Only \$39.95 each.  
ComputerWorld's Complete Library of 600 Apple II programs Only \$60.00

# PET™

Commodore PET Service Kit	\$30.00
Beeper—Tells when tape is loaded	24.95
Petunia—Play music with PET	29.95
Video Buffer—Attach another display	29.95
Combo—Petunia and Video Buffer	49.95

### SOFTWARE FOR PET

Mirrors and Lenses	19.95	Checkers and Baccarat	7.95
The States	14.95	Chess	19.95
Real Estate 1 & 2	59.95	Series and Parallel	
Momentum and Energy	19.95	Circuit Analysis	19.95
Projectile Motion	19.95	Home Accounting	9.95
Mortgage	14.95	BASIC Math	29.95
Dow Jones	7.95	Game Playing with BASIC	
Petunia Player Sftwr	14.95	Vol. I, II, III	9.95 each

# ComputerWorld

A RAYGAM COMPANY

6791 Westminster Ave., Westminster, CA 92683 (714) 891-2587

# WANTED: ATARI®

• • • FIND IT AT COMPUTERWORLD.

## ATARI® 800™ PERSONAL COMPUTER SYSTEM

### PRICE INCLUDES:

Computer Console  
BASIC Language Cartridge  
Education System Master Cartridge  
BASIC Language Programming  
Manual (Wiley)  
800 Operator's Manual with Note Book  
ATARI 410 Program Recorder  
Guide to BASIC Programming Cassette  
8K RAM Module • Power Supply •  
TV Switch Box

**\$999<sup>99</sup>**

## ATARI® 400™ PERSONAL COMPUTER SYSTEM

### PRICE INCLUDES:

Computer Console  
BASIC Language Cartridge  
BASIC Language Programming  
Manual (Wiley)  
400 Operator's Manual with  
Note Book  
Power Supply  
TV Switch Box

**\$549<sup>99</sup>**

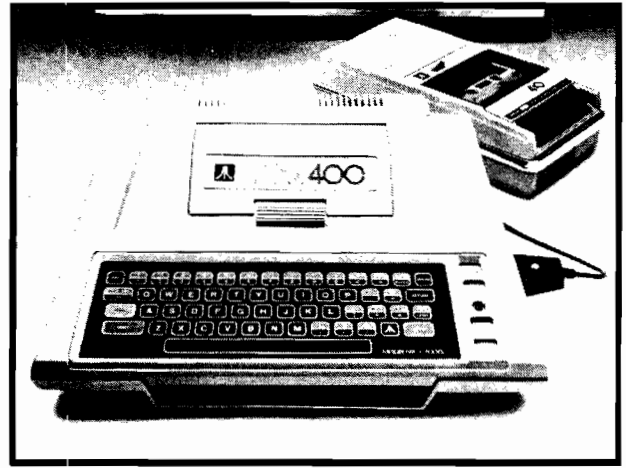

## PERIPHERALS AND ACCESSORIES

### ATARI® 810™ DISC DRIVE\* DISKETTES

**\$749.99**

CX8100 BLANK DISKETTES\*  
CX8101 DISK FILE MANAGER\*  
\$5.00/ea.

### ATARI® 820™ PRINTER\*

**\$599.99**

ACCESSORY CONTROLLERS  
CX2C-01 DRIVING CONTROLLER PAIR  
CX30-04 PADDLE CONTROLLER PAIR  
CX40-04 JOYSTICK CONTROLLER PAIR  
\$19.95/ea.

### ATARI® 410™

### PROGRAM RECORDER \$89.99 ADD-ON MEMORY (800 ONLY)

CX852 8K RAM MEMORY MODULE \$124.99  
CX853 16K RAM MEMORY MODULE \$249.99

## SOFTWARE

### ROM CARTRIDGES

CXL4001 EDUCATION SYSTEM MASTER  
CARTRIDGE \$34.99  
KEY: (j) = uses joystick controller  
(p) = uses paddle controller  
(d) = uses driving controller

### GAMES . . . . . \$49.99/ea.

CXL4004 BASKETBALL (j)  
CXL4005 LIFE (j)  
CXL4006 SUPER BREAKOUT™ (p)  
CX4008 SUPER BUG™\*\* (d)

### APPLICATION . . . . . \$69.99

CXL4002 ATARI BASIC  
CXL4003 ASSEMBLER DEBUG\*\*  
CXL4007 MUSIC COMPOSER  
CXL4009 COMPUTER CHESS\*\* (j)

### EDUCATION SYSTEM CASSETTE PROGRAMS

**\$39.99/ea.**

CX6001 U.S. HISTORY  
CX6002 U.S. GOVERNMENT  
CX6003 SUPERVISORY SKILLS  
CX6004 WORLD HISTORY (WESTERN)  
CX6005 BASIC SOCIOLOGY  
CX6006 COUNSELING PROCEDURES  
CX6007 PRINCIPLES OF ACCOUNTING  
CX6008 PHYSICS

CX6009 GREAT CLASSICS (ENGLISH)  
CX6010 BUSINESS COMMUNICATIONS  
CX6011 BASIC PSYCHOLOGY  
CX6012 EFFECTIVE WRITING  
CX6013 AUTO MECHANICS  
CX6014 PRINCIPLES OF ECONOMICS  
CX6015 SPELLING  
CX6016 BASIC ELECTRICITY  
CX6017 BASIC ALGEBRA

### BASIC GAME AND PROGRAM CASSETTES

CX4101 GUIDE TO BASIC PROGRAMMING\*  
CX4102 BASIC GAME PROGRAMS\*  
\$29.95/ea.

\*October Delivery \*\*November Delivery

—Prices subject to change.—

## We Promise to Deliver!

- We GUARANTEE ship dates on prepaid Computer System orders.\*
- If for reasons beyond our control we miss a ship date, WE WILL REFUND THE SHIPPING AND HANDLING CHARGES TO YOU — PLUS GIVE YOU A 10% DISCOUNT ON YOUR NEXT PURCHASE OF ANY ATARI SOFTWARE!
- For prepaid Computer System orders, you'll receive an Accessory Controller of your choice.

\*All prepaid orders must be for full amount by Cashier's Check only, payable to ComputerWorld. California residents, please add 6% sales tax.

### ORDERING INFORMATION:

**TELEX 182274**

1. Type or print item(s) you wish to order.
2. If you pay by personal check: please allow 2 weeks for personal check to clear.
3. If you pay with bank card: We accept VISA, BankAmericard, MasterCharge. Please include bank card number, card expiration date, and your signature.
4. Add 50¢ for postage and handling of books, manuals, catalogs, and magazines. Add \$10.00 for shipping, handling, and insurance for hardware and systems orders.
5. Send orders to ComputerWorld, 6791 Westminster Ave., Westminister, CA 92683. California residents, please add 6% sales tax.

# ComputerWorld

A RAYGAM COMPANY

6791 Westminister Ave., Westminister, CA 92683 (714) 891-2587

# QUICK CHANGE ARTISTRY

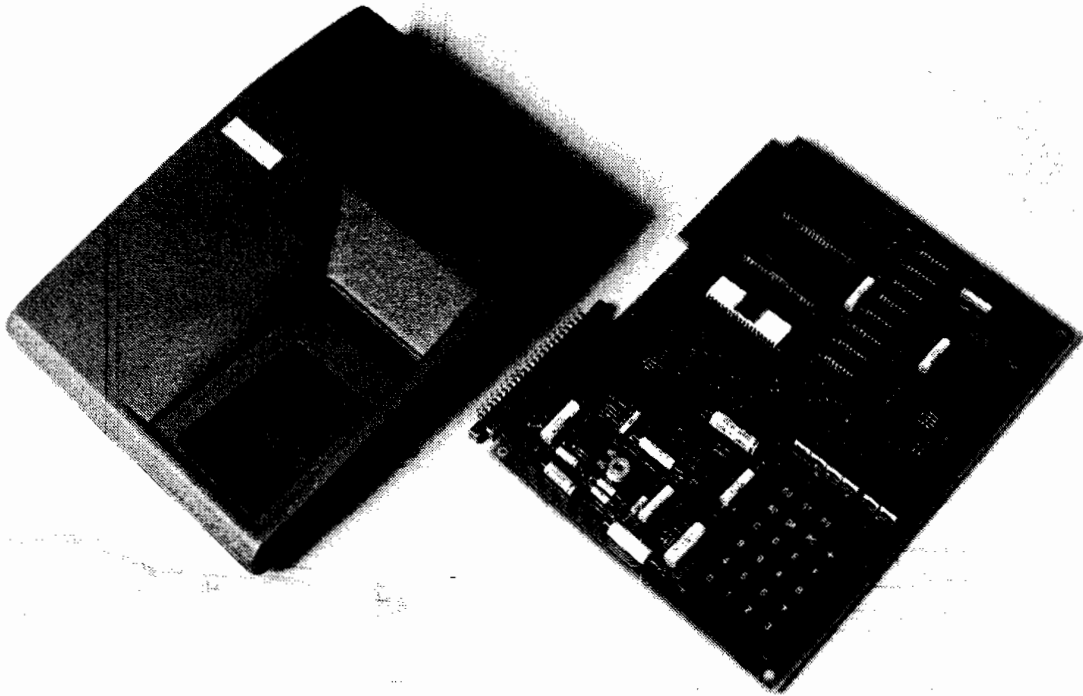

## ENGINEERED SPECIFICALLY FOR THE KIM-1 MICRO COMPUTER

- Protection of Chips and Other Components
- Viewing Angle of Readout Enhanced
- Improved Keyboard Position for Easier Operation

## EASILY ASSEMBLED

- Absolutely No Alteration of KIM-1 Required
- All Fasteners Provided
- Goes Together in Minutes with a Small Screwdriver

## ATTRACTIVE FUNCTIONAL PACKAGE

- Professional Appearance
- Four Color Combinations
- Improves Man/Machine Interface

## MADE OF HIGH IMPACT STRENGTH THERMOFORMED PLASTIC

- Kydex 100\*
- Durable
- Molded-In Color
- Non-Conductive

## AVAILABLE FROM STOCK

- Allow Two to Three Weeks for Processing and Delivery
- No COD's Please
- Dealer Inquiries Invited

TO ORDER: 1. Fill in this Coupon (Print or Type Please)  
2. Attach Check or Money Order and Mail to:

NAME \_\_\_\_\_

STREET \_\_\_\_\_

CITY \_\_\_\_\_

STATE \_\_\_\_\_ ZIP \_\_\_\_\_

Please Ship Prepaid \_\_\_\_\_ SKE 1-1(s)  
@ \$23.50 Each  
California Residents please pay  
\$25.03 (Includes Sales Tax)

**the  
enclosures  
group**

771 bush street, san francisco 94108

Color Desired blue  beige   
black  white

# TSAR: A Time Sharing Administrative Routine for the KIM-1

---

**If you think the KIM-1 is too small to do interesting jobs, then consider this program. TSAR is a super monitor which supports time-sharing, opening the door to a wide variety of new capabilities. The techniques can easily be translated for use on other computers.**

---

Philip K. Hooper  
3 Washington Street  
Northfield, VT 05663

The program presented here takes over supervisory control of the KIM-1, demoting the KIM monitor to the role of "just another program" sharing execution time with a list of user programs. The monitor, with its display and keypad, remains available while user programs are running, permitting true "front panel" operation; examination and even alteration of memory during program execution. There is provision for inserting breakpoints into a program while it is running, as well as a TSAR-compatible breakpoint servicing routine. Although the system as presented is configured for six programs, in addition to the monitor and TSAR itself, it is easily expanded to provide supervision for as many user programs as memory and stack requirements permit.

## Introduction

Not long ago, if anyone had suggested to me that I should write a time-sharing system for my KIM-1, I would have objected on two counts: first, that it would be pointless with such a small, single-user system; second, that it would be far too complicated to design, implement, and operate. I would have been wrong on both counts.

I had been working on a design problem — the problem of providing a perfectly transparent operating environment for my TVT-6 video board. This inexpensive and very versatile board draws its timing signals directly from the address bus of the MPU and can not function normally without the full, undivided attention of KIM, making its use along with another program rather awkward to orchestrate.

When I had finally tamed the microseconds and sync pulses and had my transparent display operational, I loaded my LIFE program and settled back, regarding the result with satisfaction and noting how cooperative it all seemed, with the display driver and LIFE program sharing the time of the MPU. And then it hit me! This was already a

timesharing system. Moreover, leaving out the TVT-6 would let me streamline the system and also extend it to the supervision of many "simultaneous" programs.

Before explaining the operation of the system, let me note resources the system requires as well as some of the features it offers. Its needs are few: an unexpanded KIM-1 provides sufficient memory for overseeing the operation of thirty-some programs; the supervisory routine, TSAR, resides in forty-four bytes of page twenty-three; a special, and optional, breakpoint routine occupies another fifteen bytes on that page; fifteen page zero locations are required for storing system variables under a six-user-program configuration (with two additional bytes needed for each program over six); and page one is distributed as stack space for the various programs.

The only hardware expansion needed is a wire, or possibly a switch, allowing the interval timer to send an interrupt to the MPU. (See Figure 1.) A speaker, connected as in the *Kim User Manual*, can provide dramatic examples of the system's use, but is certainly not essential to its operation.

The most useful aspect of the system is, in my opinion, provision for a full hex front panel. Under the KIM monitor, the keypad and display are used almost exclusively to enter and initiate programs. Though individual programs may use them for special purposes, they generally remain idle during program execution. Under TSAR, however, the monitor is timeshared and becomes a monitor in the full sense of the word, remaining active while other programs are executing. This permits the on-line examination (and even alteration) of any memory location, so that one can, for instance: watch a counter as it approaches zero, alter the value of a byte of data to determine its effect on the program, or even change an instruction opcode, all while the program is running! Essentially it

brings full interaction to KIM-1, letting the user and running programs interact through the services of the monitor.

The cost of this continuous monitoring is time—the user programs run more slowly when timeshared—but there are occasions, as during certain program development stages, where this can be an advantage. By using this system with five dummy programs having large time slices, we produce an interactive slow-stepper. By letting the programs modify each other's time slices (an unnatural activity recommended only for producing unpredictable results) we can create an enormous variety of unusual timing patterns.

## The Timesharing Procedure

The 6502 provides ready access to and manipulation of the stack pointer, and this in turn permits the realization of a fairly simple timesharing procedure. The programs to be run are placed in a queue and are activated and recalled by TSAR as it cycles through the queue. So TSAR can keep adequate track of these programs, each has its own stack area, stack pointer, and time slice determining how long the program will be active when its turn comes. The user selects the stack areas from page one, while the corresponding stack pointers and the time slices are kept in two page zero lists, STAX and TIMES respectively. The index number (position in the queue) of the program currently executing is stored in location INDEX. Figure 2 illustrates this procedure.

Assume that one of these programs, say P2, is running. Under TSAR, the interval timer will also be running, and armed, loaded initially with the time slice for P2 from TIMES+2. At "time out," TSAR will be re-entered at location 1780, via the NMI vector, and after disabling further interrupts TSAR will save registers A, X, and Y on the stack reserved for P2. P and PC have already been saved there, as part of the interrupt response of the 6502. TSAR will then

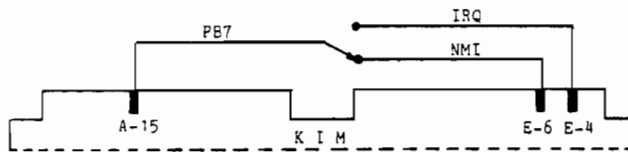

Figure 1: Enabling the timer interrupts. A SPDT switch connecting PB7 to either NMI or IRQ permits the fullest realization of TSAR's capability. The switch setting should not be changed without first setting both interrupt vectors to point to the monitor.

replace the stack pointer value for P2 in STAX+2, the second position of the STAX list. This procedure is illustrated in Figure 3.

Disabling further interrupts at this time has no effect on the minimal configuration but is advisable if there are other devices that could pull IRQ low connected to the system, to inhibit interrupts from them during operation of the supervisory routine.

Program 2 now remains idle until IN-DEX again assumes the value of 2. Before that occurs, TSAR will have looked at six other IN-DEX values; activated

and later recalled those programs currently enabled—those with non-zero time slices; kept the monitor enabled; and maintained STAX as needed. At any rate, when IN-DEX=2 does recur, the time slice for P2 will be brought in from TIMES+2 and examined by TSAR. If this is zero, P2 is disabled and will be passed by. Otherwise, this time slice will be written to the timer, to initiate another time period during which P2 may execute.

Next, the stack pointer specific to P2 will be brought back from STAX+2 and used to access P2's private stack, from which the saved values of the Y, X, and A registers will be pulled. Finally, an RTI

```

*
* TSAR: BY PHILIP K. HOOPER
* MODIFIED 7-19-79 BY MICRO STAFF
*
17BC      COUNT *   $0000
17BC      X      *   $0300

17BC      INDEX *   $00E0
17BC      TIMES *   $00E1
17BC      STAX  *   $00E8
17BC      POINTL *  $00FA

17BC      TIMER *   $170E
17BC      DELAY *   $1ED4
17BC      INCPT *   $1F63
1780      ORG    *   $1780
1780 78    ENTER SEI      PLEASE DO NOT DISTURB
1781 48    PHA      PLACE
1782 8A    TXA      ALL
1783 48    PHA      REGISTERS
1784 98    TYA      ON THE
1785 48    PHA      STACK
1786 BA    TSX      GET CURRENT STACK POINTER FROM MPU
1787 A4 E0  LDY INDEX   NOW, WHICH PROGRAM IS RECALLED?
1789 96 E8  STXZY STAX  STASH STACK POINTER FOR INTERRUPTED PROGRAM
178B A5 E1  LDA TIMES  EXAMINE TIMING CONSTANT OF MONITOR
178D D0 02  BNE INDEC  IF ZERO, MONITOR DISABLED - MUST RESTORE
178F C6 E1  DEC TIMES  RESET MONITOR TIME SLICE
1791 C6 E0  INDEC DEC INDEX DECREMENT INDEX TO NEXT PROGRAM
1793 10 04  BPL TINDX  POSITIVE DENOTES VALID INDEX
1795 A0 06  LDYIM $06  OTHERWISE, RESET INDEX TO POINT TO THE
1797 84 E0  STY INDEX  GREATEST PROGRAM QUEUE INDEX
1799 A6 E0  TINDX LDX INDEX TENTATIVE INDEX OF NEXT PROGRAM
179B B5 E1  LDAX TIMES  FETCH PROGRAM TIME SLICE
179D F0 F2  BEQ INDEC  IF ZERO, PROGRAM DISABLED - PICK ANOTHER
179F 8D 0E 17 STA TIMER  DEPOSIT TIMING INTERVAL IN COUNTER - ENABLE INT
17A2 B5 E8  LDAX STAX  FETCH STACK POINTER FOR REACTIVATED PROGRAM
17A4 AA     TAX      PUT STACK POINTER IN X REGISTER
17A5 9A     TXS     AND DEPOSIT STACK POINTER INTO MPU
17A6 68     PLA     BRING
17A7 A8     TAY     IN
17A8 68     PLA     REGISTERS
17A9 AA     TAX     OFF
17AA 68     PLA     STACK
17AB 40     LEAVE  RTI     RETURN TO THE PROGRAM

```

will draw the status register and program counter from this same stack, and P2 will be off and running again, from the very place at which it was interrupted. If no other program interferes with its storage areas, P2 will function as though it were the only program in the KIM, although a bit more slowly.

In a small system like this, without software-initiated memory protect or disk-based page swapping, any unwanted interaction between programs must be prevented by the programmer. This is managed through carefully planned memory allocation and through the use of stack storage to make any shared routines fully reentrant—using different storage areas (stacks) depending on which program is using the routine. Therefore, whenever the monitor is included as an enabled program, the monitor subroutines which use RAM temporary storage and those which serve the monitor's keypad and display routines should not be called by a user program. The results would be unpredictable and would probably prevent interactive use of the monitor.

This sequence of execution, interruption, dormancy, reactivation is followed by all programs on the queue, including the monitor. Depending on its time slice, each enabled program receives from 64 to 16320 microseconds of execution time, minus TSAR's overhead, when its turn arrives, while those disabled by a null time slice are simply passed over. With six programs enabled in addition to the monitor, TSAR exacts roughly 80 microseconds to process each interrupt, and each disabled program increases this by about 20 microseconds to a maximum of 200 with the monitor alone enabled. The more work the system has to do, the more efficient it becomes! Of the above times, 30 microseconds is taken from the time slice of the program being reactivated, so that a time slice of 01, representing a single sixty-four microsecond portion, will actually provide thirty-four microseconds of execution time for the program, each time around.

A time slice range of from 1024 to 261,120 microseconds can be installed by replacing the value of the byte at 17A0 with "0F", which starts the timer's counter in the divide-by-1024 mode instead of the divide-by-64 mode. Although this reduces the relative time penalty charged by TSAR, it also degrades the response of the monitor somewhat.

Oddly enough, this is an example of one of the peculiar charms of the TSAR system. Some of the aggravations that TSAR introduces—monitor response annoyingly slow at times, startup routine hard to remember, recovery from a crash a major undertaking—all of these provide the peculiar sensation that one is working on some sort of monster system and not just a KIM-1 with 1K of memory and a 50-odd byte timesharing supervisor.

The code for this procedure is presented in the listing. Note that the sections of code for the normal (interrupt to 1C00) entry and normal ("GO" -1DC8) exit for the ROM monitor are closely related to the entry and exit code for TSAR. Both involve storing, and later retrieving, the contents of the PCH, PCL, P, A, Y, X, and SP registers, which together completely specify the internal state of the MPU. However, while the monitor stores these values in fixed, page zero locations, TSAR places them in a user stack reserved for the particular program which has just been recalled.

Using the monitor as the operating system, the user can alter these zero page locations holding register values, making it possible to exit from the monitor to a different program, with a different set of operating parameters, than the program that was running before. TSAR does this automatically, by pulling the register values from a different stack, the one corresponding to the program about to be activated, rather than from the stack for the program which was just recalled.

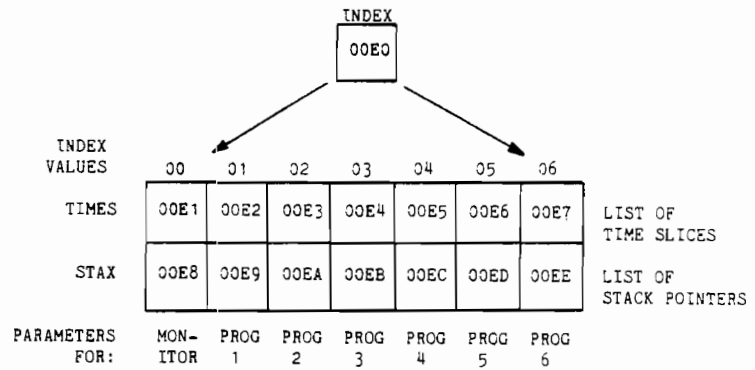

Figure 2: Use of page zero memory, 00E0-00EE

```

*****
* SAMPLE PROGRAMS FOR EXERCISING TSAR *
*****
*
* 1ST SAMPLE PROGRAM MERELY COUNTS, IN HEX, THE NUMBER
* OF TIMES IT IS ACTIVATED, STORING THE COUNT IN $0000,
* WHICH SHOULD BE PRESET MANUALLY TO ZERO
*
02E0          ORG    $02E0
02E0 A9 00    START  LDAIM $00    CLEAR ACCUMULATOR AND USE IT TO
02E2 85 E1    STA    TIMES    ZERO OUT THE MONITOR TIME SLICE
02E4 A5 E1    LOOP  LDA    TIMES    FETCH THE MONITOR TIME SLICE, AND REMAIN IN
02E6 F0 FC    BEQ    LOOP    THIS LOOP AS LONG AS IT IS ZERO
02E8 E6 00    INC    COUNT    RECORD THE CHANGE, WHICH INDICATES
                                COMPLETION OF ANOTHER
02EA 4C E0 02 JMP    START    CYCLE THROUGH THE QUEUE, AND REPEAT
*
* NOTE: USING THE MONITOR TIME SLICE AS A FLAG TO
* INDICATE TO A PROGRAM WHEN IT HAS BEEN RECALLED
* AND THEN REACTIVATED IS A USEFUL TRICK, BUT
* AT A TIME
*
* 2ND SAMPLE PROGRAM ALSO COUNTS CYCLES, BUT IT
* DOES SO IN BCD, KEEPING THE LEAST SIGNIFICANT
* DIGITS IN 05FF, THE NEXT TWO IN 03FE,
* AND SO ON. IT CAN COUNT VERY HIGH.
*
0200          ORG    $0200
0200 F8      START2 SED          DECIMAL SPOKEN HERE
0201 38      STALL SEC          SET CARRY SO ADDER WILL WORK PROPERLY
0202 A2 00   LDXIM $00        SET X REGISTER TO ZERO TO
0204 86 E1   STX    TIMES    ZERO THE MONITOR TIME SLICE
0206 A5 E1   LOOP2 LDA    TIMES    CHECK MONITOR TIME SLICE AND,
0208 F0 FC   BEQ    LOOP2    IF IT IS ZERO, KEEP ON CHECKIN'
020A CA     NEXT  DEX          TO FF, TO INDEX, INITIALLY, 03FF
020B BD 00 03 LDAX X          GET CONTENTS OF 03XX
020E 69 00   ADCIM $00        ADD 1, SINCE THE CARRY IS SET
0210 9D 00 03 STAX X          AND PUT IT BACK WHERE WE FOUND IT
0213 90 EC   BCC   STALL    WITHOUT CARRY, ADDITION IS FINISHED
                                SO WAIT TILL NEXT TIME, OTHERWISE
0215 B0 F3   BCS   NEXT     BACK UP TO NEXT DIGIT & PROPAGATE CARRY
*
* NOTE: THIS PROGRAM MAY BE USED WITH THE PREVIOUS
* PROGRAM BY HAVING ONLY ONE OF THEM MESS WITH
* TIMES AND HAVING THEM SHARE A RAM LOCATION AS
* A FLAG. ONE SETS THE FLAG, WHILE THE OTHER
* RESETS THE FLAG AND LOOPS.
*

```

While the monitor uses a single location, 00F2, for storing its only stack pointer, TSAR maintains a list, STAX, of stack pointers, one for each program on the queue. The six bytes of code from 178B to 1790 were included as an *after-thought*, after several foolish blunders on my part had let the system escape from my control. They merely guarantee the monitor's presence by forcing its time slice to "FF" if it is ever found at "00". Resorting to reset, to restore the monitor, is fun the first few times only. Nonetheless, these six bytes and the fifteen bytes used to service breakpoints may be deleted without otherwise affecting TSAR.

### Bringing Up The System

Managing the TSAR system is quite a bit more complex than running a single program on the KIM, and several steps are required to put it into operation. The following sequence will generate a functioning TSAR system.

1. Verify that PB7 is connected to NMI (Figure 1).
2. Load TSAR into 1780-17BB, from keypad or tape.
3. If loading was from the keypad, verify correctness of code.
4. Set 17FA,B to point to 1780 and set 17FE,F to point to 17AC, providing the proper interrupt vectors for TSAR.
5. Load all locations from 00E0 through 00F1 with "00".
6. Press "RS", guaranteeing the stack pointer (monitor) at FF. If you are planning to use the DELAY subroutine from the ROM,

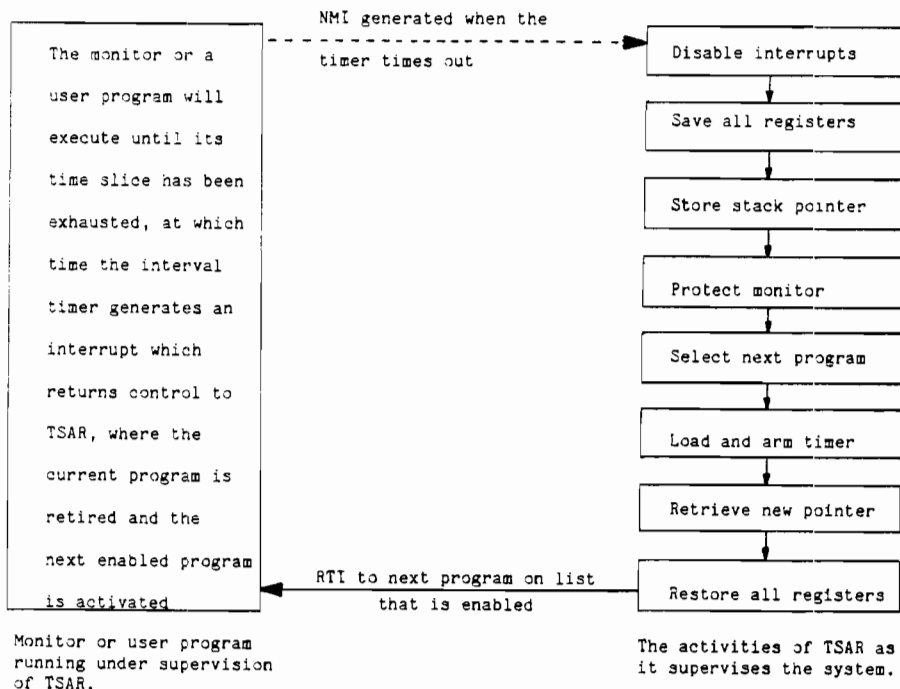

Figure 3: Flow of control in the TSAR system.

**Table 1**  
Register Value Storage by the TSAR and by the KIM Monitor

TSAR		Register	KIM	Monitor
Typical Stack Locations	User Program		Saved	Dedicated KIM Page Zero RAM Locs.
01DA		Y		00F4
01DB		X		00F5
01DC		A		00F3
01DD		P		00F1
01DE		PCL		00EF (00FA)
01DF		PCH		00F0 (00FB)

Interrupt entry to TSAR (at 1780) or the Monitor (at 1C00) will store the MPU registers in the locations indicated above. Leaving TSAR via an RTI will restore these values to the MPU. Leaving the Monitor by using 'GO' restores the MPU from these RAM locations, except that the PCL and PCH are loaded from 00FA and 00FB (the pointer), respectively. To replace the original program counter into the MPU, the contents of 00EF and 00F0 are first transferred to 00FA and 00FB by pressing the 'PC' key, moving the Program Counter into the pointer.

	Initial Y value	Initial X value	Initial A value	Initial flag values	Initial PCL (E0)	Initial PCH (02)
01D9	01DA	01DB	01DC	01DD	01DE	01DF

Figure 4: Initialization of a user program stack. The stack pointer initially points to 01D9, but since it is incremented before any values are pulled, the contents of 01D9 have no effect on the program.

remember that reset puts 17F3 to "FF". Also, if you are intending to use either port A or port B for output, you must reconfigure at this time, since reset configures all port lines as inputs.

- Examine address 00E1, the monitor time slice. It will be "00".
- Press "ST", NOT "GO"! we intentionally interrupt the monitor at this point to raise the activity to the TSAR system level. The value at 00E1 should now become "FF" as the monitor protection routine leaps in. If this does not happen, briefly address location 170C, another way to get an NMI pulse, and return to view 00E1. If it still does not read "FF", reset and check the start-up sequence.
- Now, assuming 00E1 is at "FF", try to key in "00". If the system rejects this, keeping "FF" instead, timesharing is in operation. If "00" is accepted in 00E1, generate another NMI (by examining 170C again) and verify timesharing as above.
- As a final indication that timesharing is in operation, examine 00E8, the stack pointer for the monitor. Since the monitor is being interrupted, and not always at the same place, the value of 00E8 should change, probably flitting quickly from "F5" to "F7" and back. Any sign of flickering here verifies that TSAR is in charge and that timesharing is under way.
- Key in a user program, noting that the monitor behaves as it always has. If you intend to load any user programs from tape, do so before step 8, as the timing changes under TSAR are not compatible with serial I/O. Assume that this first user program starts at location 02E0, as does the first of the sample programs, and that its stack extends downward from 01DF, leaving 32 bytes for the monitor, far more than it will ever need. This is program 1 (the monitor is program 0), so its initial stack pointer will go into STAX+1, 00E9. This stack will be accessed initially by lines 17A6 to 17AB of TSAR. Since TSAR first pulls register values for Y, X, and A, and then (with RTI) pulls three more values for P and PC, we must provide these six values immediately above the stack pointer. The values in the first four of these locations are used for the initial register contents when program 1 starts running.



As they are of no consequence for the sample programs, they may be set to "00" or left as found. However, the final two locations, 01DE and 01DF, hold the program counter for program 1 and must, in this case, be initialized to "E0" and "02" respectively, to provide the starting address, 02E0. Since the stack pointer must initially point to location 01D9, a "D9" is keyed into location 00E9.

12. Recheck the program code, stack values, and stack pointer.
13. Examine location 00E2 (TIMES + 1), the time slice for program 1, and change it to a non-zero value. If your program does anything you can sense, you

should be sensing it now. If it uses a counter, address the counter and watch it move. Return to 00E2 and vary the time slice, noting how the program execution speeds up and slows down. Change 00E1 and note its effect on the execution rate of your program. Enjoy it for a while, and then bring another program into the system. The procedure will be the same as above, from step 11 on, although a different location must be used for the stack, different initializing information must be placed on the stack, and the new stack pointer must be stored in a different position of STAX. Disable the first program; run either, both, or neither of them; play with it!

You are MASTER of your own time-sharing system! The sample programs provided do not represent the full range of TSAR's potential. For one thing, keeping the monitor on-line prevents program-generated information from appearing on the display. With additional devices for output, the variety of interesting programs that can be run under TSAR is increased greatly.

For example, a memory-mapped video output can provide a very dramatic visual demonstration of timesharing. With a speaker connected as shown in the *Kim User Manual*, several programs may each toggle the speaker at rates determined by DELAY, a KIM monitor sub-routine at 1ED4 used for serial teleprinter I/O but also useful whenever a long software delay is required. They may also alter the DELAY parameters,

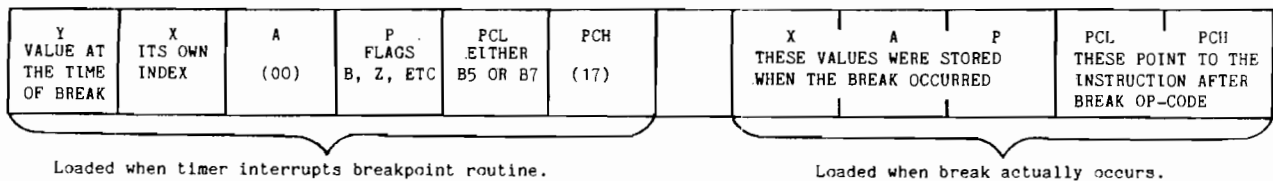

Figure 5: Breakpoint stack contents. After recall, the pointer addresses the location below the Y value.

```

*
* 3RD SAMPLE PROGRAM ADVANCES THE POINTER (00FA,B)
* TO DISPLAY SUCCESSIVE MEMORY LOCATIONS. IT
* INTERFERES SEVERELY WITH THE SIMULTANEOUS USE OF THE
* MONITOR KEYPAD AND DISPLAY.
*
0217 20 D4 1E START3 JSR DELAY (PRESET 17F2 AND 17F3 TO
DETERMINE RATE OF DELAY
021A 20 63 1F JSR INCPT INCREMENT THE POINTER, 00FA,B
021D A5 FA LDA POINTL GET THE LOW BYTE OF THE POINTER
AND USE IT AS THE VALUE
021F 85 E4 STA TIMES +03 VALUE OF THIS PROGRAM, SHOWN AS 3
0221 4C 17 02 JMP START3 AND KEEP GOING
*
* NOTE: THIS PROGRAM BEHAVES UNPREDICTABLY. IT MIGHT
* DISABLE ITSELF, OR IT MIGHT SUSPEND THE ENTIRE SYSTEM
* OR IT MIGHT KNOT.
*
*****
* BREAKPOINT SERVICE ROUTINE *
*****
* (ENTRY FROM IRQ VECTOR)
*
17AC ORG $17AC
17AC 48 BREAK PHA SAVE A
17AD 8A TXA AND X
17AE 48 PHA ON THE STACK
17AF A9 00 LDAIM $00 CLEAR A
17B1 A6 E0 LDX INDEX DETERMINE WHICH PROGRAM CAUSED BREAK
17B3 95 E1 STAX TIMES AND DISABLE IT
17B5 B5 E1 SLEEP LDAX TIMES SLUMBER IN A LOOP UNTIL
17B7 F0 FC BEQ SLEEP RECALLED BY TSAR
17B9 4C A8 17 JMP GOBACK LET TSAR RESTORE X AND A BEFORE RETURN
*
* NOTE: THE RTI CODE AT $178E (IN TSAR) IS EXECUTED
* TWICE AS A PROGRAM IS RE-AWAKENED AFTER A BREAK
*

```

(17F2,3), modify each other's time slices, and toggle the speaker port between input and output, producing a type of mayhem in the speaker that varies from WWII soundtracks, to tuba contests, to bouncing ball bearings, to almost-human-sounding arguments. Using "OF" to provide longer time intervals enhances this cacophony.

With several input devices (joysticks, keypads, even push buttons), TSAR permits the user connected to each device to have apparently sole use of the system, timesharing in the traditional, multi-user sense. With suitable ground rules established, the users could even play a version of "core war" in which each tries to get his (no doubt self-relocating) program to destroy the other programs before getting zapped by one of them. This has a vaguely evolutionary, survival-of-the-fittest undercurrent that keeps it from becoming too abstract.

### Keeping It Up

One problem the TSAR system does present is that, lacking proper safeguards, it is somewhat fragile. A single program, running amok, can bring down all of the others, including TSAR. Fortunately there are some methods for recovering gracefully from crashes, and even for averting many of them.

If the system seems to be misbehaving, it is a good idea to locate and disable the guilty program before it can interfere with other programs, the monitor, or TSAR. It is easy to disable any program simply by setting its time slice to zero. A record detailing what program is where on the queue and where the various stacks and stack pointers are located is very useful here. Once a program has been deactivated, it may be replaced on the queue with a different program, or it may be altered (repaired?) and then returned to service by a simple time slice change.

If disabling the suspect program fails to correct the system, the best procedure is to disable all user programs, and the faster the better. Then re-introduce them individually, testing them one at a time with the monitor. An externally generated IRQ signal is the quickest, cleanest way to disable all user programs, as it invokes the breakpoint service routine which disables the currently active program in an orderly manner. An interesting alternative is to have a special "shutdown" program ready but disabled. In case of trouble, enabling this program sends it into action to disable everything else and, finally, itself, in an orderly manner.

Triggering IRQ several times will null the time slices of all programs (monitor, however, remains, because it is not susceptible to IRQ), leaving each in a suspended state from which it can be returned to service by simply changing its time slice. This is a much less severe insult to the system than a reset produces, and it should be tried first, whenever dysfunction is suspected. Of course, if the system is hung in a loop with the I flag set, IRQ will be ignored and only a reset will affect the system.

If the system is 'hung', probably indicated by a stable, partially-lit display, the only option is a reset. Then, examine INDEX (00E0), to determine which program was running at the time of the reset interrupt. Disable that program and, if it was the whole problem, a "hot start" (set location 00E0 to "00" and then examine location 170C) should rekindle the system, minus the malfunctioner. You can next locate the stack pointer for the disabled program and use it to determine the register contents (roughly) when it was last activated. Compare this with the response of the monitor at reset, which sets both the stack pointer and 00F2 to "FF", obliterating any traces of stack activity.

### Breakpoints

Unique to TSAR, the provision for interrogating the code of a program while it is running can even be extended through the use of breakpoints, which themselves may be inserted into the program while it is running. This feature depends upon the coincidental good fortune that each 6502 branch instruction ends in a zero and can, therefore, be

shifted left to the break code "00" without producing any dangerous intermediate code.

Recall that the timesharing procedure probably prevents entering, through the monitor, more than one hex character per time slice. For example, keying the break code over the code "4C" would first produce the interim code "C0" which would create havoc if executed before the second zero could be keyed in, during the next monitor time period. Changing a branch code, "X0", to a break code presents no such problems. Of course, there is the option of disabling the program, inserting the break, and reenabling it again; but inserting the break into "moving code" is more elegant and much more exciting.

When a break code is encountered, a non-maskable IRQ is generated, vectoring control to the BSR code, presented in the listing. This routine first saves the A and X registers on the stack used by the interrupted program. It then sets the time slice of the interrupted program to zero, and loops on this condition until the current time slice expires and the program is recalled by TSAR. The user can detect the occurrence of a break by watching the location holding its time slice, or he can provide a watchdog program to monitor this value and produce a signal when it detects a zero. TSAR will bypass this program on subsequent cycles through the queue, because of its null time slice, so the idle program, its breakpoints, and its stack may be examined and altered at leisure, until it is ready to be run again.

At that time, merely keying in a non-zero time slice for the program signals to TSAR that it is to be reactivated, when its turn comes. Although reactivation returns it to the loop where it was sleeping before recall, the loop condition (time slice = zero) has been changed, so the program can escape from this loop and reenter its old code at the next instruction after the break.

Since the procedure for bringing a program back from a break is somewhat involved, requiring as it does the unnesting of two different interrupts, a closer look might be worthwhile. First TSAR, at line 179D, discovers that the program is again enabled, so its time slice is loaded into the interval timer. Then the stack pointer for this program is brought in from STAX. It will point to the location just below that where the Y register was stored. Registers Y, X, and A are loaded from this stack, and RTI restores the flag register, in which the Z flag is SET, and returns control at line 17B5 or 17B7 of the breakpoint routine. This is the stalling loop where the program idled from the break interrupt until its former time slice expired and it was recalled by TSAR.

Now, however, its time slice has been adjusted from zero, and when this is discovered the loop is abandoned and con-

trol goes once more to TSAR's exit routine, this time at 17A8. The X and A values from before the break are brought in, and the second pass through RTI restores P and PC, returning control to the user program at the instruction following the branch/break code. This entire procedure is carried out with no effect on the other programs operating under TSAR, except that each runs a bit more slowly when this program returns to service and again requires a slice of the MPU's time.

### Caveat Computer

Because of significant differences between operating under TSAR and operating under the KIM monitor, a few warnings are in order. Although most have been mentioned before, they are collected here for emphasis and elaboration. Programs running simultaneously under TSAR, including the monitor, must not normally share RAM storage or use common subroutines unless they are fully reentrant. This restricts user programs from calling the keypad and display routines if the monitor is enabled, and monitor RAM locations, like the pointer at 00FA,B must be scrupulously avoided. However, it is possible to bring up the TSAR system without an enabled monitor, permitting user programs to use the monitor utility routines. Simply altering the monitor protect code and then disabling the monitor is an inelegant but easy way to manage this. It does, however, fill one place on the queue with a dead monitor.

A better procedure is to set up all the stacks, time slices, and pointers in advance, initiate the execution of a single user program from the monitor (with "GO"), and then use "ST" to leap up to TSAR. Although this approach sacrifices interactive control of the system, that may be prevented by giving up the breakpoint routine and re-directing IRQ to the monitor at 1C00. An external device (switch?) that can deliver an IRQ might now restore the monitor on-line. Note that this procedure differs from a recall by TSAR, in that the registers of the interrupted program are saved in monitor RAM instead of the program stack, meaning that the monitor has, for the time being, replaced one of the user programs on the queue. When the monitor is no longer needed, "PC" followed by "GO" will switch them back again, putting the monitor out of and the user program back into circulation.

A disadvantage of this procedure is that, without additional control hardware, the program which is replaced by the monitor will be selected by chance, and several attempts may be needed to locate a suitable candidate, one you are willing to have idle as long as the monitor is in use. To minimize repeated blind interrupts and restarts of the system, disable all of the programs that you wish to keep running the first time you IRQ the system into the monitor. This greatly increases the chance that, on the

next interrupt, a non-essential program will be replaced by the monitor, and then the disabled programs can be reenabled. I prefer, instead, to retain continuous monitor presence and have my user programs do their I/O through ports rather than through the keypad and display routines.

Because of the changes in timing introduced, serial I/O drivers, such as the cassette and serial teleprinter routines in the ROM, cannot be expected to operate properly under TSAR.

For more than six user programs, references to STAX, TIMES, and INDEX will need to be changed in TSAR, to reflect the re-organization of page zero memory use.

One of the most bizarre malfunctions that can occur under TSAR is to have more than one copy of the monitor concurrently active. Since the code is not reentrant, the multiple copies share RAM locations and interact oddly, producing such symptoms as:

- a. Keystroke double entry. This may be nice for bookkeepers, but it makes it very difficult to address location 0327 when pressing the "3" key inserts two nibbles of "3", while the "+" key advances two cells at a time.
- b. Total or sporadic failure to respond to certain keystroke commands, as one copy of the monitor receives the command;

but, before it can finish executing it, the other copy garbles up the message.

An intriguing challenge, at this point, is to locate and disable the imposter—the marauding mock monitor—before it brings down the system altogether. My record of two successes in five tries is more impressive than it sounds.

The possibility of numerous hierarchy violations exists under TSAR because, in the absence of protectable memory regions (ROM doesn't count here), any executing program is considered the equal of any other. This permits a lowly user program, intentionally or otherwise, to plunder page twenty-three and wound or altogether destroy beloved TSAR. He may even manage to wrest control of the system, gaining thereby a sort of immortality, by preventing the changing of INDEX or by disabling all competition. The opportunities for such exotic malfunctioning are vast, but they are easy to avoid and the interest they contribute far outweighs whatever minor annoyance they might occasionally produce. In fact, they can be a source of very interesting diagnostic opportunities. For instance, imagine trying to reestablish control in a situation where monitor monitors monitor.

**RTI**

As I mentioned earlier, neither the design nor the operation of TSAR is over-

ly complicated. In spite of the enormous increase in capability that TSAR brings to KIM, the system is really quite simple to bring up and to operate. In fact, except for some flickering of the display, the monitor behaves as if it were in charge, rather than operating under the supervision of TSAR. Moreover, I have found that any apparent malfunctioning of TSAR could eventually be traced to carelessness on my part—in running a flawed program or in failing to initialize a pointer-stack combination properly.

I assume that this system is easily adapted for use on other 6502 computers, and I would like to hear from anyone who brings it up on an AIM, SYM, or other 6502 machine, or who finds interesting, useful, or entertaining applications for it. How about a memory mapped display routine providing current information regarding the system status, like: number of currently enabled programs, disabled (i.e. available for use) INDEX values, percentage of running time allotted to each enabled program, maximum stack depth attained by each program (could head off disasters). Of course, this program would be on the queue and would be reporting on itself as well as on the others. With all that vacant ROM space from 1A96 to 1BF9, I wish I knew a way to hide TSAR up there, out of danger from peasant programs and proletarian programmers, but ready to take command of a timesharing system when summoned.

**T.D.Q.  
TAPE DATA QUERY**

PET-8K	SOL-IIA	TRS-80-LEVEL II
* FILE MANAGEMENT SYSTEM		
-Utilizes Dual Audio Cassette Recorders		
* INTERACTIVE QUERY LANGUAGE		
-English-Like Commands		
-Powerful Info Retrieval Capability		
* COMPUTERIZED BUSINESS & PERSONAL RECORDS		
-Customize Your Own File Structures		
-Create & Maintain Data Files		
-No Programming Experience Required		
* IMPLEMENTED IN BASIC		
T.D.Q. CASSETTE WITH MANUAL & REF. CARD \$50.00		
The Following Pre-Defined T.D.Q. File Structures		
Are Available To Solve Your Data Processing Needs:		
INVENTORY CONTROL		\$35.00
ACCOUNTS RECEIVABLE		\$35.00
ACCOUNTS PAYABLE		\$35.00
ORDER PROCESSING		\$35.00
CUSTOMER DIRECTORY		\$25.00
APPOINTMENT SCHEDULING		\$25.00

Each With Cassette And Manual

Send Self-Addressed Stamped Envelope For Complete Software Catalogue.  
Send Check Or Money-Order To:

**H. GELLER COMPUTER SYSTEMS**  
DEPT. M, P.O. BOX 350  
NEW YORK, NY 10040

(New York Residents Add Applicable Sales Tax)

**NOW AVAILABLE**

For SOL-IIA and PET-8K

GENERAL PACK 1	\$11.00
(Checkbook Balancer, Tic Tac Toe, Metric Conversion)	
GENERAL PACK 2	\$19.00
(Space Patrol, Biorhythm, Battlestar, One-Armed Bandit)	
FINANCIAL PACK 1	\$13.00
(Loans, Depreciation, Investments)	
FINANCIAL PACK 2	\$13.00
(Mortgage & Loan Amortization, Future Projections, Risk Analysis)	
STATISTICS PACK 1	\$19.00
(Mean & Deviation, Distribution, Linear Correlation & Regression, Contingency Table Analysis)	
GAME PACK 1	\$20.00
(Basketball, Object Removal, Bowling, Darts, Gopher)	
GAME PACK 2 - (children - educational)	\$13.00
(Arithmetic God, Addition Dice, Travel)	

For the KIM-1

PCROS - A Real-Time Operating System in the \$50.00  
IK KIM RAM  
Includes: Assembly listing; Cassette with user's manual; Schematic for relay control board



BOX 120  
 ALLAMUCHY, N.J. 07820  
 201-362-6574

HUDSON DIGITAL ELECTRONICS INC.

## THE HDE MINI-DISK SYSTEM

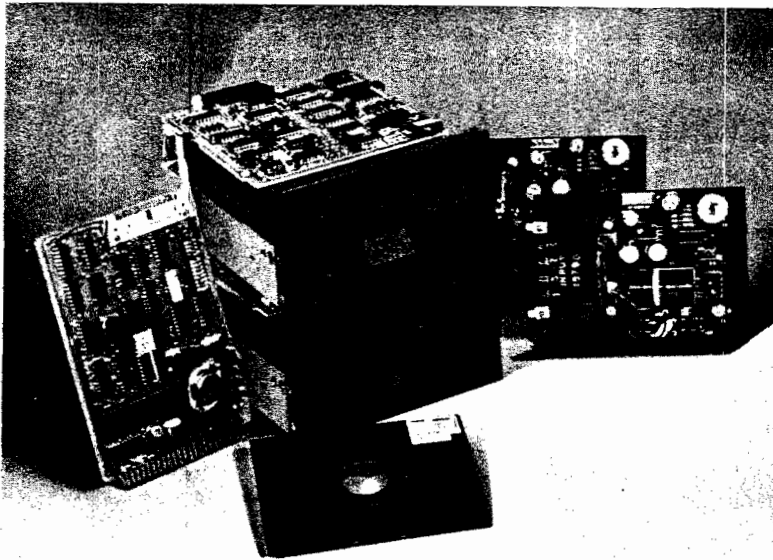

### VERSIONS

KIM  
 TIM  
 AIM 65 - 4th Qtr. '79  
 SYM - 1st Qtr. '80

SINGLE DRIVE \$ 795.00  
 DUAL DRIVE \$1195.00

Complete with all hardware.  
 Interconnecting cables, FODS,  
 text editor and user and instal-  
 lation manuals.

The HDE DM816-MD1 Mini Disk System is the peripheral you have been waiting for. No longer bounded by long and unreliable cassette saves and loads, your computer becomes a sophisticated system for program development or general purpose use. With the HDE Mini-Disk you load and save programs in seconds, not minutes or hours. And, since all transfers to and from the Mini-Disk are verified for accuracy, the data will be there when you need it.

The HDE DM816-MD1 Mini-Disk has been "systems" engineered to provide a complete and integrated capability. Software and hardware have been built as a team using the most reliable components available. The systems software includes the acclaimed and proven HDE File Oriented Disk System and Text Editor, requiring only 8K for the operating software and overlay area. Systems expanding programs available include the

two-pass HDE assembler, the Text Output Processing System and Dynamic Debugging Tool. Hardware includes a Western Digital 1771 based controller in a state-of-the-art 4 1/2 x 6 1/2" card size, Shugart SA 400 drive and the Alpha power supply.

The storage media for the DM816-MD1 is the standard, soft sectored 5 1/4" mini diskette readily available at most computer stores, and HDE has designed the system so that the diskettes rotate only during disk transactions, favorably extending media life. A disk formatter routine included with the system, formats the diskettes, verifies media integrity by a comprehensive R/W test and checks drive RPM. Additional utilities provide ascending or descending alpha numeric sort, disk packing, text output formatting, file renaming, file addressing and other capabilities.

**HDE PRODUCTS. BUILT TO BE USED WITH CONFIDENCE.**

**AVAILABLE DIRECT OR FROM THESE FINE DEALERS:**

JOHNSON COMPUTER PLAINSMAN MICROSYSTEMS  
 Box 523 Box 1712  
 Medina, Ohio 44256 Auburn, Ala. 36830  
 216-725-4560 800-633-8724

ARESCO  
 P.O. Box 43  
 Audubon, Pa. 19407  
 215-631-9052

LONG ISLAND  
 COMPUTER GENERAL STORE  
 103 Atlantic Avenue  
 Lynbrook, N.Y. 11563  
 516-887-1500

LONE STAR ELECTRONICS  
 Box 488  
 Manchaca, Texas 78652  
 612-282-3570

# Interfacing the CI-812 to the KIM

---

**If you want to add I/O capabilities to your KIM, then consider the CI-812 I/O board and its abilities.**

---

Jim Dennis  
2305 Pinecrest  
Nacogdoches, TX 75962

The Percom CI-812 I/O board contains a full-duplex data terminal interface (RS-232) and a cassette interface that can load and dump data at rates up to 2400 baud. The CI-812 comes with 8080 software and is useless to 6502 owners, as is. I have interfaced a CI-812 to a KIMSI 6502 to S-100 motherboard, and I have written software that loads and dumps to the CI-812 from a KIM.

There are several reasons why I wanted to add this board to my I/O library. First, under the right conditions, data transfer can take place very quickly compared to the standard 10 cps of the KIM, and the rates are easily controlled in the software.

Second, if the user is interested in building a terminal to communicate with a big computer or with another small computer via a modem, all that is needed additionally is a modem (\$125 for a Pennywhistle), a TVT-6 (\$35), and a video monitor (\$150), or a converted black and white TV, to turn the KIM into a full-fledged intelligent terminal.

Third, data received from magnetic tape is self-clocked with a signal extracted from the data. Speed variations in the tape drive and baud rate changes are thereby eliminated as sources of error.

The KIMSI generates S-100 bus signals and the decode enable from the signals on the expansion connector of the KIM. S-100 signals of the bus master type used by the CI-812, in addition to the tri-stated address lines and the DO and DI lines, include PWR, PDBIN, SINP, and SOUT. PWR is an active low signal denoting stable data on the DO lines, PDBIN is an active high signal that

enables the DI lines, while SINP and SOUT are active high signals that indicate the addressing of an I/O device.

The CI-812 does not directly interface with the KIMSI because of timing problems associated with SINP, SOUT, and the DO buffer enable. Also, the 2 MHz clock pulse required by the CI-812 is not generated by the KIMSI. The procedure for overcoming these problems is:

1. Jumper the 1 MHz enable from finger 62 of the KIMSI to finger 49 of the KIMSI.
2. Bypass the first divide-by-two stage of the clock by bending up pin 5 IC9 of the CI-812 and jumpering pin 5 IC12 to pin 8 IC3.
3. Create a new signal, which I call SNOUT, that goes high whenever an I/O device is addressed. SNOUT is available at pin 10 IC9 of the KIMSI. Jumper it to finger 96 of the KIMSI.
4. Bypass the OR-INVERT of SINP and SOUT by the CI-812 by jumpering finger 96 of the KIMSI to pin IC20 of the CI-812 and by bending up pin 4 IC2 of the CI-812.
5. Permanently enable the DO buffers by jumpering pin 12 IC14 of the CI-812.

This completes the hardware revision of the KIMSI and the CI-812. The CI-812 outputs bi-phase (Manchester) code consisting of bursts of 2400 Hz square waves for a logic one and 1200 Hz square waves for a logic zero. Impressing unfiltered square waves on magnetic tape and then reading them involves a

double differentiation process that can cause errors at high baud rates. For this reason, computer grade tape and baud rates of not more than 300 are recommended. Three hundred baud is known as the Kansas City standard.

The program shown is a checksum loader-dump routine which I have written for the KIM-PERCOM-KIMSI combination. The KIMSI uses memory mapping to address I/O devices, reserving address range FOXX for I/O devices.

My PERCOM board is addressed at FOEX; X = 1, 2. The program follows the format of the KIM cassette loader and dump, loading block headers and EOT's in Hex and all else in ASCII. No SYN characters are necessary. When a program has been dumped, the monitor takes over at address 0000. If a program has loaded correctly, the address display will light at 0000 also. If an illegal hex character has been encountered, meaning that the tape has been read incorrectly, the display will light at the starting address of the loader.

For example, if two ASCII characters are decoded to a J6, which is supposed to be a hex byte, then the tape has been read incorrectly. If a checksum error occurs, then the display will light with the calculated checksum high or low byte repeated twice in the address display.

The ASCII — hex checksum load and dump routine for the KIM uses the following KIM monitor subroutines: VEB, INTVEB, CHKT, INCVEB and PAKT. The CI-812 is addressed at FOE1 and FOE2 in the program listing. The ASCII — hex dump starts at 0000 and loads at 0070. To change to another location, modify locations denoted by "" to reference the new page.

SUBROUTINE	FUNCTION
OUTCHR	DUMPS ASCII CHR ON TAPE
OUTBYTC	DUMPS IHEX BYTE AS 2 ASCII CHR AND INCREMENTS CHKSUM
OUTBYT	SAME AS ABOVE BUT DOES NOT INC CHKSUM
LDASCII	LOADS 1 ASCII CHR
HEXTOAS	CONVERTS 1/2 HEX BYTE TO ASCII

```

0000 A9 AD      LDAIM AD      INITIALIZE VEB AS DUMP
0002 8D EC 17   STA VEB
0005 20 32 19   JSR INTVEB  INITIALIZE VEB
0008 A9 2A      LDAIM ASCII*' ASCII SYNC
000A 20 56 00*  JSR OUTCHR  OUTPUT BLOCK HEADER
000D AD F9 17   LDA ID
0010 20 03 01* JSR OUTBYT  OUTPUT ID WITHOUT CHKS
0013 AD F5 17   LDA SAL     STARTING ADDRESS LOW
0016 20 00 01* JSR OUTBYTC OUTPUT WITH CHKSUM
0019 AD F6 17   LDA SAH     STARTING ADDRESS HIGH
001C 20 00 01* JSR OUTBYTC
001F AD ED 17   STRT      LDA VEB + 1  GET CURRENT ADD. LOW
0022 CD F7 17   CMP EAL     CMP WITH ENDING ADD. L
0025 AD EE 17   LDA VEB + 2 GET CURRENT ADD. HIGH
0028 ED F8 17   SBC EAH     SBC ENDING ADD. HIGH
002B 90 1A      BCC DUMP2   DO THEY AGREE?
002D A9 2F      LDA ASCII '/' YES, LDA ASCII SLASH
002F 20 56 00*  JSR OUTCHR  OUTPUT EOT
0032 AD E7 17   LDA CHKSUML GET CHKSUM LOW
0035 20 03 01* JSR OUTBYT  OUTPUT
0038 AD E8 17   LDA CHKSUMH GET CHKSUM HIGH
003B 20 03 01* JSR OUTBYT  OUTPUT
003E A9 00      LDA 00
0040 85 FA      STAZ POINTL
0042 85 FB      STAZ POINTH
0044 4C 4F 1C   JMP START   ALL OK, RETURN TO MON
0047 20 EC 17   DUMP2     JSR VEB     PICK UP NEXT BYTE
004A 20 00 01* JSR OUTBYTC OUTPUT
004D 20 EA 19   JSR INCVEB INC CURRENT ADDRESS
0050 4C 1F 00* 4C STRT
0053 EA        NOP
0054 EA        NOP
0055 EA        NOP
0056 48        PHA        SAVE BYTE
0057 A9 03      LDAIM 03    LDA SELECT CODE
0059 8D E0 F0   STA CAS-SEL SELECT CASSETTE MODE
005C AD E1 F0   LDA UARTOUT READ UART TO CLEAR
005F AD E0 F0   CLEAR    LDA STATUS  READ STATUS
0062 29 80      ANDIM 80    MASK STATUS BIT
0064 F0 F9      BEQ CLEAR  LOOP IF STILL TRANSMIT
0066 68        PHA        RESTORE BYTE
0067 8D E1 F0   STA CASOUT OUTPUT TO UART
006A 60        RTS
006B EA        NOP
006C EA        NOP
006D EA        NOP
006E EA        NOP
006F EA        NOP
0070 A9 8D      LDAIM 8D    SET UP VEB AS LOADER
0072 8D EC 17   STA VEB
0075 20 32 19   JSR INTVEB  INITIALIZE VEB AS LOADER
0078 A9 4C      LDAIM 4C
007A 8D EF 17   STA VEB + 3
007D A9 C6 *    LDAIM C6
007F 8D F0 17   STA VEB + 4
0082 A9 00 *    LDAIM 00    LOADER RETURNS FROM VEB
0084 8D F1 17   STA VEB + 5 WITH JMP TO LOC. 00C6
0087 20 32 01* RDY? JSR LDASCII LOOK FOR BLOCK HEADER
008A C9 2A      CMPIM '*'   IS IT A SYNC?

```

```

008C F0 02      BEN GETBYT  YES, PICK UP NEXT 2 CHARAC.
008E D0 F7      BNE RDY?   NO, LOOK AGAIN
0090 20 23 01* GETBYT JSR ASCIIHEX GET NEXT 2 CHAR. AND CONVERT
0093 CD F9 17   CMP ID     IS IT THE RIGHT BLOCK?
0096 F0 02      BEQ GO     YES, GET FIRST CHARACTER
0098 D0 F6      BNE GETBYT NO, KEEP LOOKING FOR ID
009A 29 23 01* GO    JSR ASCIIHEX GET BYTE AND CONVERT TO HEX
009D 20 4C 19   JSR CHKSUM INC CHECKSUM
00A0 8D ED 17   STA VEB + 1 STORE          CHKSUM LOW
00A3 20 23 01* JSR ASCIIHEX
00A6 20 4C 19   JSR CHKSUM
00A9 8D EE 17   STA VEB + 2 STORE CHKSUM HIGH
00AC A2 02      GO2      LDXIM 02    LDX CHAR. COUNTER
00AE 20 32 01* GO1    JSR LDASCII GET ASCII CHAR.
00B1 C9 2F      CMPIM EOT  IS IT EOT?
00B3 F0 17      BEQ CONT  YES, FINISH
00B5 20 00 1A   JSR PACKT NO, PACK ASCII AS HEX
00B8 F0 03      BEQ VALASC BEQ VALID ASCII CHAR.
00BA 4C 4F 1C   JMP START  ERROR EXIT
00BD CA        VALASC  DEX          DEC. CHAR. COUNTER
00BE D0 EE      BNE GO1   GET 2ND CHAR.
00C0 20 4C 19   JSR CHKSUM INC CHKSUM
00C3 4C EC 17   JMP VEB   MOVE SA TO VEB
00C6 20 EA 19   JSR INCVEB INC. CURRENT ADD.
00C9 4C AC 00*  JMP GO2   LOOP BAK FOR MORE CHAR.
00CC 20 23 01* CONT JSR ASCIIHEX CHKSUM
00CF F0 03      BEQ CKOK? IT IT VALID HEX?
00D1 4C 2B 19   JMP ERRREX NO, EXIT
00D4 CD E7 17   CKOK?    CMP CHKSUML YES, COMPARE WITH CALC. CHKS
00D7 F0 03      BEQ OK    CHKSUM LOW AGREES
00D9 4C 2B 19   BADNEWS  JMP ERRREX CHKSUM LOW DOES NOT AGREE
00DC 20 23 01* OK    JSR ASCIIHEX GET CHKSUM HIGH
00DF CD E8 17   CMP CHKSUMH COMPARE WITH CALC. CHKSUMH
00E2 D0 F5      BNE BADNEWS CHKSUM HIGH DOES NOT AGREE
00E4 A9 00      LDAIM 00
00E6 4C 2B 19   JMP NORMEX CHKSUM AGREES
0100 20 4C 19   JSR CHKSUM CALC. CHKSUM
0103 A8        TAY          SAVE BYTE
0104 4A        LSRA
0105 4A        LSRA
0106 4A        LSRA
0107 4A        LSRA          SHIFT OUT LSB
0108 20 13 01 * JSR HEXTOAS CONVERT TO ASCII
0108 98        TYA          RESTORE BYTE
010C 20 13 01 * JSR HEXTOAS OUTPUT MSB AS ASCII
010F 98        TYA          RESTORE BYTE
0110 60        RTS
0111 EA        NOP
0112 EA        NOP
0113 29 0F      ANDIM 0F    MASK MSB
0115 C9 0A      CMPIM 0A
0117 18        CLC
0118 30 02      BPL CONV
011A 69 07      ADCIM 07
011C 69 30      CONV     ADCIM 30    CONVERT TO ASCII
011E 20 56 00* JSR OUTCHR  OUTPUT AS ASCII
0121 60        RTS
0122 EA        NOP
0123 20 32 01* JSR LDASCII READS UART
0126 20 00 1A   JSR PACKT  PACKS 2 ASCII CHAR.
0129 20 32 01* JSR LDASCII AS 1 HEX BYTE
012C 20 00 1A   JSR PACKT
012F 60        RTS
0130 EA        NOP
0131 EA        NOP
0132 A9 01      LDAIM 01    CODE FOR CASSETTE LOAD
0134 8D E0 F0   STA UART  OUTPUT TO UART
0137 AD E1 F0   LOOP    LDA UARTOUT CLEAR UART
013A AD E0 F0   LDA FLAG  READ STATUS
013D 29 40      ANDIM 40    MASK STATUS BIT
013F F0 F9      BEQ LOOP   IF NOT READY, WAIT
0141 AD E1 FC   LDA DATA  LOAD ASCII CHAR.
0144 60        RTS          RETURN

```

# Microbes

Note on Charles Husband's  
Speech Processor for the PET  
MICRO 16:41

Readers interested in obtaining additional information about the Data-Boy Speech Processor should contact Jim Anderson at:

MIMIC Electronics  
Box 921  
Acton, MA 01720

AMPERSORT  
Alan G. Hill  
12092 Deerhorn Drive  
Cincinnati, OH 45240

I apologize to MICRO readers for the errors in the listing of AMPERSORT published in MICRO 14:39. The problem was a result of including the first five pages of an earlier version with the last two pages of a later version to which lines 3940 thru 3946 were added. This caused, as many readers discovered, the object address of some of the preceding code to be incorrect. Attached is a listing of the correct object code. Anyone wishing to receive an improved version on cassette may do so by sending \$5.00 to me at the above address.

Several people have asked if AMPERSORT can be used with Applesoft in RAM rather than ROM. With the following changes it can:

Routine	ROM Addr.	RAM Addr.
FRMNUM	\$DD67	\$156A
GETADR	\$E752	\$1F49
GETBYT	\$E6F8	\$1EEF
SNER	\$DEC9	\$16CC

The Applesoft RAM BASIC program must also include the following statements that must be executed prior to the first '&SRT' command:

POKE 2142,244: POKE 2143,3

The specific changes to AMPERSORT for Applesoft RAM are:

Address	ROM Ver.	RAM Ver.
\$5269	67	6A
\$526A	DD	15
\$526C	52	49
\$526D	E7	1F
\$527A	67	6A
\$527B	DD	15
\$527D	52	49
\$527E	E7	1F
\$52A9	C9	CC
\$52AA	DE	16
\$52B4	F8	EF
\$52B5	E6	1E
\$52C0	F8	EF
\$52C1	E6	1E

\*\$2000.5589

```

5200- 48 20 E6 54 68 A2 00 DD
5208- 2C 55 D0 46 20 B1 00 EB
5210- E0 05 D0 F3 A2 00 F0 03
5218- 20 B1 00 C9 2C F0 0A 9D
5220- 72 55 E8 E0 10 D0 F1 F0
5228- 29 CA BD 72 55 C9 24 F0
5230- 24 C9 25 D0 15 A2 01 A9
5238- 80 1D 72 55 9D 72 55 CA
5240- 10 F5 A9 02 85 EC A9 01
5248- D0 19 A9 05 85 EC A9 02
5250- D0 11 4C A5 52 A9 80 0D
5258- 73 55 8D 73 55 A9 03 85
5260- EC A9 00 85 F1 20 B1 00
5268- 20 67 DD 20 52 E7 A5 50
5270- 85 DE A5 51 85 DF 20 B1
5278- 00 20 67 DD 20 52 E7 A5
5280- 50 85 D4 18 69 01 85 E0
5288- A5 51 85 D5 69 00 85 E1
5290- A5 F1 D0 59 F0 15 A2 00
5298- B0 31 55 09 80 20 ED FD
52A0- EB E0 17 D0 F3 20 09 55
52A8- 4C C9 DE A0 00 8C 89 55
52B0- 20 B1 00 20 F8 E6 CA AC
52B8- 89 55 96 E2 20 B1 00 20
52C0- F8 E6 AC 89 55 96 E7 20
52C8- B1 00 90 D9 C9 44 F0 04
52D0- A9 FF 30 02 A9 00 99 82
52D8- 55 C8 8C 89 55 20 B1 00
52E0- C9 29 F0 04 C9 2C F0 C8
52E8- D0 BB 8C 88 55 20 B1 00
52F0- D0 B3 A0 00 B1 6B CD 72
52F8- 55 D0 08 C8 B1 6B CD 73
5300- 55 F0 2B 18 A0 02 B1 6B
5308- 65 6B 48 C8 B1 6B 65 6C
5310- 85 6C 68 85 6B C5 6D A5
5318- 6C E5 6E B0 03 4C F2 52
5320- A2 02 B0 72 55 9D 3B 55
5328- CA 10 F7 4C 96 52 18 A5
5330- 68 69 07 85 52 A5 6C 69
5338- 00 85 53 A5 DE 85 50 A5
5340- DF 85 51 A5 EC 85 54 A9
5348- 00 85 55 20 63 FB A5 50
5350- 85 D6 A5 51 85 D7 4C 66
5358- 53 18 A5 D6 65 EC 85 D6
5360- A5 D7 69 00 85 D7 A0 01
5368- B1 D6 85 D8 C8 B1 D6 85
5370- D9 18 A5 D6 65 EC 85 DA
5378- A5 D7 69 00 85 D8 18 A5
5380- DE 69 01 85 ED A5 DF 69
5388- 00 85 EE 4C 9B 53 18 A5
5390- DA 65 EC 85 DA A5 DB 69
5398- 00 85 DB A0 01 B1 DA 85
53A0- DC C8 B1 DA 85 DD A5 F1
53A8- F0 03 4C 2F 54 A0 00 B1
53B0- D6 F0 52 85 EF B1 DA F0
53B8- 4C 85 F0 A2 00 B4 E2 BD
    
```

```

53C0- 82 55 30 0C B1 D8 D1 DC
53C8- B0 14 20 C1 54 4C 05 54
53D0- B1 D8 D1 DC 90 2F F0 19
53D8- 20 C1 54 4C 05 54 D0 25
53E0- C8 C4 EF F0 06 C4 F0 F0
53E8- 16 90 0F C4 F0 90 E9 F0
53F0- 0E C8 C4 EF F0 09 C4 F0
53F8- F0 DE 98 D5 E7 D0 C0 E8
5400- EC 88 55 D0 B8 E6 ED D0
5408- 02 E6 EE A5 ED C5 E0 A5
5410- EE E5 E1 90 14 E6 DE D0
5418- 02 E6 DF A5 DE C5 D4 A5
5420- DF E5 D5 90 07 20 09 55
5428- 60 4C 8E 53 4C 59 53 18
5430- 6A B0 03 4C 6D 54 A0 01
5438- B1 D6 D1 DA 88 B1 D6 F1
5440- DA 90 22 B1 D6 51 DA 30
5448- BC C8 B1 DA 48 88 B1 DA
5450- 48 B1 D6 91 DA C8 B1 D6
5458- 91 DA 88 68 91 D6 C8 68
5460- 91 D6 4C 05 54 B1 D6 51
5468- DA 30 DE 10 98 A0 00 B1
5470- D6 D1 DA 90 0B F0 02 B0
5478- D0 C8 C0 05 D0 F1 F0 3E
5480- A0 01 B1 D6 31 DA 11 DA
5488- 30 20 88 B1 DA D0 2F C8
5490- B1 D6 10 16 30 2B A0 01
5498- B1 D6 31 DA 11 D6 30 1E
54A0- 88 B1 D6 D0 05 C8 B1 DA
54A8- 10 14 A0 04 B1 D6 48 88
54B0- 10 FA C8 B1 DA 91 D6 68
54B8- 91 DA C0 04 D0 F4 4C 05
54C0- 54 A0 00 B1 D6 48 C8 A5
54C8- D8 91 DA C8 A5 D9 91 DA
54D0- A5 DD 91 D6 85 D9 88 A5
54D8- DC 91 D6 85 D8 88 B1 DA
54E0- 91 D6 68 91 DA 60 A2 00
54E8- 85 D0 9D 48 55 E8 E0 22
54F0- D0 F6 A5 6B 8D 70 55 A5
54F8- 6C 8D 71 55 A2 00 85 50
5500- 9D 6A 55 E8 E0 06 D0 F6
5508- 60 A2 00 BD 48 55 95 D0
5510- E8 E0 22 D0 F6 AD 70 55
5518- 85 6B AD 71 55 85 6C A2
5520- 00 D0 6A 55 95 50 E8 E0
5528- 06 D0 F6 60 53 52 54 23
5530- 28 8D 56 41 52 49 41 42
5538- 4C 45 20 20 20 20 4E
5540- 4F 54 20 46 4F 55 4E 44
5548- 00 00 00 00 00 00 00 00
5550- 00 00 00 00 00 00 00 00
5558- 00 00 00 00 00 00 00 00
5560- 00 00 00 00 00 00 00 00
5568- 00 00 00 00 00 00 00 00
5570- 00 00 00 00 00 00 00 00
5578- 00 00 00 00 00 00 00 00
5580- 00 00 00 00 00 00 00 00
5588- 00 00
    
```

## Data Acquisition Modules

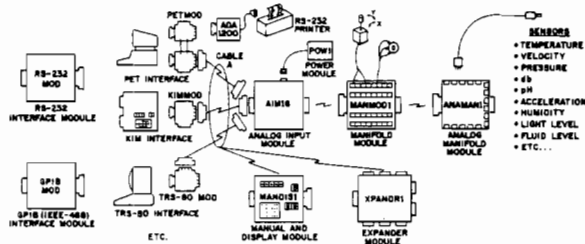

The world we live in is full of variables we want to measure. These include weight, temperature, pressure, humidity, speed and fluid level. These variables are continuous and their values may be represented by a voltage. This voltage is the analog of the physical variable. A device which converts a physical, mechanical or chemical quantity to a voltage is called a sensor.

Computers do not understand voltages: They understand bits. Bits are digital signals. A device which converts voltages to bits is an analog-to-digital converter. Our AIM16 (Analog Input Module) is a 16 input analog-to-digital converter.

The goal of Connecticut microComputer in designing the DAM SYSTEMS is to produce easy to use, low cost data acquisition modules for small computers. As the line grows we will add control modules to the system. These acquisition and control modules will include digital input sensing (e.g. switches), analog input sensing (e.g. temperature, humidity), digital output control (e.g. lamps, motors, alarms), and analog output control (e.g. X-Y plotters, or oscilloscopes).

## Analog Input Module

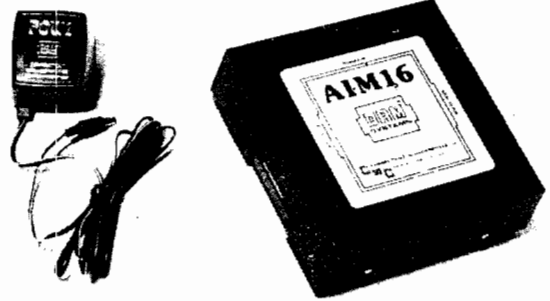

The AIM16 is a 16 channel analog to digital converter designed to work with most microcomputers. The AIM16 is connected to the host computer through the computer's 8 bit input port and 8 bit output port, or through one of the DAM SYSTEMS special interfaces.

The input voltage range is 0 to 5.12 volts. The input voltage is converted to a count between 0 and 255 (00 and FF hex). Resolution is 20 millivolts per count. Accuracy is  $0.5\% \pm 1$  bit. Conversion time is less than 100 microseconds per channel. All 16 channels can be scanned in less than 1.5 milliseconds.

Power requirements are 12 volts DC at 60 ma.

The POW1 is the power module for the AIM16. One POW1 supplies enough power for one AIM16, one MANMOD1, sixteen sensors, one XPANDR1 and one computer interface. The POW1 comes in an American version (POW1a) for 110 VAC and in a European version (POW1e) for 230 VAC.

AIM16... \$179.00  
POW1a... \$ 14.95  
POW1e... \$ 24.95

## Connectors

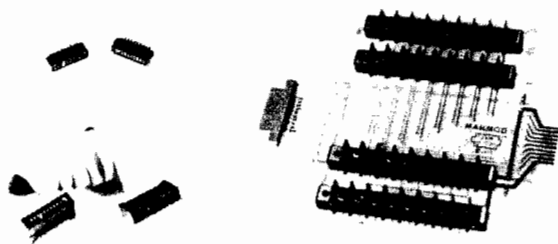

The AIM16 requires connections to its input port (analog inputs) and its output port (computer interface). The ICON (Input CONNector) is a 20 pin, solder eyelet, edge connector for connecting inputs to each of the AIM16's 16 channels. The OCON (Output CONNector) is a 20 pin, solder eyelet edge connector for connecting the computer's input and output ports to the AIM16.

The MANMOD1 (MANifold MODule) replaces the ICON. It has screw terminals and barrier strips for all 16 inputs for connecting pots, joysticks, voltage sources, etc.

CABLE A24 (24 inch interconnect cable has an interface connector on one end and an OCON equivalent on the other. This cable provides connections between the DAM SYSTEMS computer interfaces and the AIM16 or XPANDR1 and between the XPANDR1 and up to eight AIM16s.

ICON... \$ 9.95  
OCON... \$ 9.95  
MANMOD1... \$59.95  
CABLE A24... \$19.95

## XPANDR1



The XPANDR1 allows up to eight AIM16 modules to be connected to a computer at one time. The XPANDR1 is connected to the computer in place of the AIM16. Up to eight AIM16 modules are then connected to each of the eight ports provided using a CABLE A24 for each module. Power for the XPANDR1 is derived from the AIM16 connected to the first port.

XPANDR1... \$59.95

## TEMPSENS



This module provides two temperature probes for use by the AIM16. This module should be used with the MANMOD1 for ease of hookup. The MANMOD1 will support up to 16 probes (eight TEMPSSENS modules). Resolution for each probe is  $1^\circ\text{F}$ .

TEMPSENS2P1 ( $-10^\circ\text{F}$  to  $120^\circ\text{F}$ )... \$49.95





## PET Printer Adapter

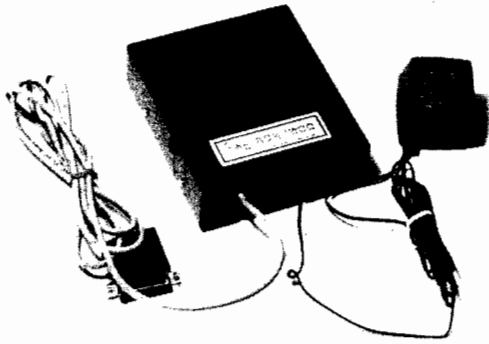

The Cmc ADA 1200 drives an RS-232 printer from the PET IEEE-488 bus. Now, the PET owner can obtain hard copy listings and can type letters, manuscripts, mailing labels, tables of data, pictures, invoices, graphs, checks, needlepoint patterns, etc., using RS-232 standard printer or terminal.

A cassette tape is included with software for plots, formatting tables and screen dumps. The ADA1200 sells for \$169.00 and includes case, power supply and cable.

Order direct or contact your local computer store.

VISA AND M/C ACCEPTED — SEND ACCOUNT NUMBER, EXPIRATION DATE AND SIGN ORDER.  
ADD \$3 PER ORDER FOR SHIPPING & HANDLING — FOREIGN ORDERS ADD 10% FOR AIR POSTAGE

**CONNECTICUT microCOMPUTER, Inc.**  
150 POCONO ROAD  
BROOKFIELD, CONNECTICUT 06804  
TEL: (203) 775-9659 TWX: 710-456-0052

# softside software

305 Riverside Drive New York, N.Y. 10025

## the pet program.



**1 GRAPHICS PAC 2** New Version **Quadruple your PET's graphic resolution.** Why be stuck with the PET's cumbersome 25 x 40 1000 point display. With Graphics Pac you can directly control (set and clear) 4000 points on screen. It's great for *graphing, plotting, and gaming.* Graphics Pac allows you to plot in any combination of two modes: 4 Quadrant graphing with (0,0) center screen, and Standard graphing with (0,0) plotted in the upper left hand corner. Complete documentation shows how you can merge this useful routine with any of your own programs without retyping either one! All this on a high quality Microcassette for only \$9.95.

**2 ASSEMBLER 2001** **A full featured assembler for your PET microcomputer that follows the standard set of 6502 mnemonics.** Now you can take full advantage of the computing abilities of your PET. Store and load via tape, run through the SYS or USR functions. List and edit too with this powerful assembler. No other commercial PET assembler gives you all these features plus the ability to look at the PET's secret Basic ROMs all in one program. This valuable program is offered at \$15.95

**3 BIKE** **An exciting new simulation that puts you in charge of a bicycle manufacturing empire.** Juggle inflation, breakdowns, seasonal sales variations, inventory workers, prices machines, and ad campaigns to keep your enterprise in the black. *Bike is dangerously addictive.* Once you start a game you will not want to stop. To allow you to take short rest breaks. Bike lets you store the data from your game on a tape so you can continue where you left off next time you wish to play. Worth a million in fun. We'll offer BIKE at \$9.95.

**4 PINBALL** **Dynamic usage of the PET's graphics features when combined with the fun of the number 1 arcade game equals an action packed video spectacle for your computer.** Bumpers, chutes, flippers, free balls, gates, a jackpot, and a little luck guarantee a great game for all. \$9.95

Authors: Our royalties are unbeatable

☆☆☆☆☆ **MUSICAL MADNESS** ☆☆☆☆☆

**SPECIAL** add an exciting new dimension to your PET computer with Soundware's soundstational music box and soundsound software from Softside & Soundware **SOUND**

☆ **THE SOUNDWORKS** ☆

The Soundware music box for your PET comes complete with controllable volume, an earphone jack, a demo tape with two programs, an instruction book, and a one year warranty. This sturdy unit is enclosed in an attractive plastic case. Notes tell how to program your own sound effects. All this during our musical madness for just 29.95

☆ **MUSICAL SOFTWARE** ☆

**ACTION PACK:** Breakthru • Target • Caterpillar: non stop graphic action 9.95

**PINBALL:** a video action spectacle with real time flippers, chutes gates, bumpers, tags etc. 9.95

**CLASSICS:** Checkers • Backgammon Board • Piano Player, checkers vs. computer or friend. Piano plays Minute Waltz 9.95

**MUSIC MANIA:** Try to repeat a growing sequence of tones. With graphics. Challenge to the best ear 9.95

**WORD FUN:** Speller: fun ways to practice spelling • Scramble • Flashcards 9.95

- KIM • One magazine publishes more information about 6502 based systems, products and programs than all of the others combined: • APPLE
- SYM • • PET
- AIM • • OSI

**MICRO™**  
P.O. Box 6502  
Chelmsford, MA 01824

Are you tired of searching through computer magazines to find articles that relate to your 6502 system? MICRO magazine is devoted exclusively to 6502 systems. Each month, MICRO publishes application notes, hardware and software tutorials, interfacing information and program descriptions with complete source listings. MICRO is not just fun and games. It is the complete reference source for all 6502 enthusiasts.

You can order twelve issues of MICRO for \$15.00, or for \$18.00 outside the United States. Air mail subscriptions cost \$27.00 in Central America, \$33.00 in Europe and South America, and \$39.00 in all other countries.

MICRO has been published regularly since October, 1977. Articles that appeared in the earlier issues of MICRO may be obtained in two bound anthologies, BEST OF MICRO Volume 1 and the companion collection ALL OF MICRO Volume 2, both available at computer stores or from the magazine.

## PET Word Processor

**8K  
and  
16/32K  
PET  
versions**

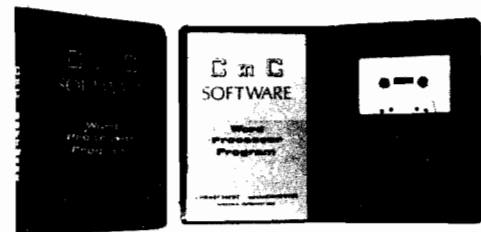

This program permits composing and printing letters, flyers, advertisements, manuscripts, etc., using the COMMODORE PET and a printer.

Printing directives include line length, line spacing, left margin, centering and skip. Edit commands allow you to insert lines, delete lines, move lines and paragraphs, change strings, save files onto and load files from cassette (can be modified for disk), move up, move down, print and type.

Added features for the 16/32K version include string search for editing, keyboard entry during printing for letter salutations, justification, multiple printing and more.

A thirty page instruction manual is included.

The Cmc Word Processor Program for the 8K PET is \$29.50. The 16/32K version is \$39.50.

Order direct or contact your local computer store.

VISA AND M/C ACCEPTED — SEND ACCOUNT NUMBER, EXPIRATION DATE AND SIGN ORDER.  
ADD \$1 PER ORDER FOR SHIPPING & HANDLING — FOREIGN ORDERS ADD 10% FOR AIR POSTAGE

**CONNECTICUT microCOMPUTER, Inc.**  
150 POCONO ROAD  
BROOKFIELD, CONNECTICUT 06804  
TEL: (203) 775-9659 TWX: 710-456-0052

# SYM - 1 Baudot TTY Interface

---

**Do not let the title fool you! This article has a lot more than just TTY stuff. Some of the techniques presented can be applied in many other situations.**

---

Richard A. Leary  
1363 Nathan Hale Drive  
Phoenixville, PA 19460

One major shortcoming of the KIM is the inability to change the I/O routines without duplicating large parts of the monitor. In designing the SYM-1, Synertek nicely handled that shortcoming by vectoring all I/O calls through jumps located in SYSTEM RAM. Since those jumps are alterable by the user, almost any I/O device handler could be written and used with no effect on the rest of the monitor. That fact, coupled with the low cost of the Baudot Teletypes such as the Model 15 led me to develop SYM-1 I/O handlers for a 60 word per minute Model 15. Since the SYM-1 allows additional ROMs to be added to the board I placed these routines in an INTEL 2716 EPROM, along with some other system software. More on that later.

## BAUDOT TTY

First, some background on Baudot Teletypes: A Baudot teletype uses only 5 data bits (unlike the 7 used by the ASCII Teletypes such as the Model 33) and thus it can only generate at most 32 unique code combinations. In order to expand that character set, two of the codes have been assigned special carriage shift functions much as it is done in a conventional typewriter. These two codes are called letters (LTRS) and figures (FIGS) and refer to the "lowercase" and "uppercase" character sets. Unlike a conventional typewriter, if a Baudot teletype is sent a LTRS code it stays in that mode until a FIGS code is sent. As a result of this shift method of operation, each key, except for some special ones, can send two different characters to another Model 15 TTY depending on the last shift sent. The receiver must of course remember what the last shift sent was, and print each succeeding key accordingly. While the Teletype does that remembering mechanically, it is obvious that a computer could easily do it electronically. That principle is the keystone of my software approach.

I mentioned that some keys or codes are assigned unique meanings regardless of whether a LTRS or FIGS code was the last code sent or received. In most Model 15 Teletypes those special keys are:

LTRS, FIGS, CAR RET (RETURN)  
LINE FEED, SPACE, NULL (BLANK)

the net effect is that of the 32 code combinations, 26 have dual meanings. As a result,  $2 \times 26 + 4 = 56$  unique characters can be printed on most Model 15 Teletypes. Note that I did not include LTRS and FIGS in the above total, as they are not really characters.

It should be obvious that with only 56 unique characters possible a 64, 96, or 128 character ASCII set cannot be directly generated or printed by a Baudot Teletype. The approach I used is an *indirect* approach which, much like the LTRS and FIGS codes, uses a sequence of codes to represent a character.

## Hardware

A few points about Baudot Teletypes are appropriate before we begin. First, the electrical characteristics of a Model 15 are a bit different from those of a Model 33 ASCII Teletype. Rather than a 20mA current loop, a Model 15 usually has a 60mA current loop. Even more importantly, the supply voltage specified for that loop supply is usually 150v or more. Making a direct interface to the SYM-1 at those voltage and current levels would be disastrous. The answer to that problem is to use the conventional 20mA interface of the SYM-1, but to couple it to the Model 15 through opto-isolators. The opto-isolators will protect the SYM-1 and allow easy conversion of the signals to the Model 15 voltage in that the SYM-1 signal ground can remain isolated from the Model 15 ground. Since Model 15s are notoriously electronically noisy, the benefit of that isolation is that the probability of noise

problems in the SYM-1 is sharply reduced.

The schematic of the interface I used and the power supply I built are shown in Figures 1 and 2. The only critical components in the interface are the selector magnet driver transistor and the zener diode. The voltage rating of the transistor must be high enough to withstand the open circuit loop supply voltage. The zener across that transistor must be similarly rated, as its function is to damp the magnet induced voltage spikes (positive and negative) and thus protect the driver transistor. The transformer in the power supply is not critical as long as it can supply 60mA continuously. This is a good opportunity to use one of the old "tube-type" power supply transformers that you probably have in your junk box.

The total resistance value of the series dropping resistors in the power supply may have to be altered if the open circuit voltage of your supply is higher than the approximately 190v put out by my supply. Once the supply is built, the variable resistor is adjusted to give a 60mA loop current when in the local mode and when no key is depressed.

Second, not all Model 15s are the same. There is a wide variety in code vs character terms, as well as in speed. At least three different speed Model 15s exist. For example, my machine was at one time a "weather" Teletype and had a special character set for most of the FIGS shift positions. I converted most of those keys and type elements to the "standard" communications set. I did leave in some characters which are not standard, and hence a few characters which I can print will have to be changed for a standard machine. Those characters are:

↑ - on standard  
+ " on standard  
- Null on standard

The software changes required to accommodate the standard code are minor.

Finally, the Baudot machines have a few good and bad overall points which each user must consider before taking the plunge. They are:

- Cheap: \$50 - \$100 or less should get you a good Model 15. Insist on a synchronous motor rather than a governor regulated motor.
- Slow: 60 wpm translates to 45 Baud (6 char/sec) which is a little bit faster than one half the speed of a Model 33. The effective speed is even slower due to the necessity to send LTRS and FIGS shifts on an irregular basis.
- Reliable: The Model 15 is probably 70% steel and 20% cast iron with a smattering of nonferrous materials. It just does not break if kept lubricated. (Remember—the Model 15 was the mainstay of the 24 hour per day news wire services.)
- Heavy: All that iron!
- Smelly: All that lubricant!
- Repairable: If it does break, parts are available and the manuals are complete and explicit. I buy my parts from a company called Typetronics, Box 8873, Fort Lauderdale, FL 33310. Prices are very reasonable and the response is nearly instantaneous.

**NOTES:**

- Resistors 1/4w, 5%
- Open circles with numbers are TTY internal terminals.

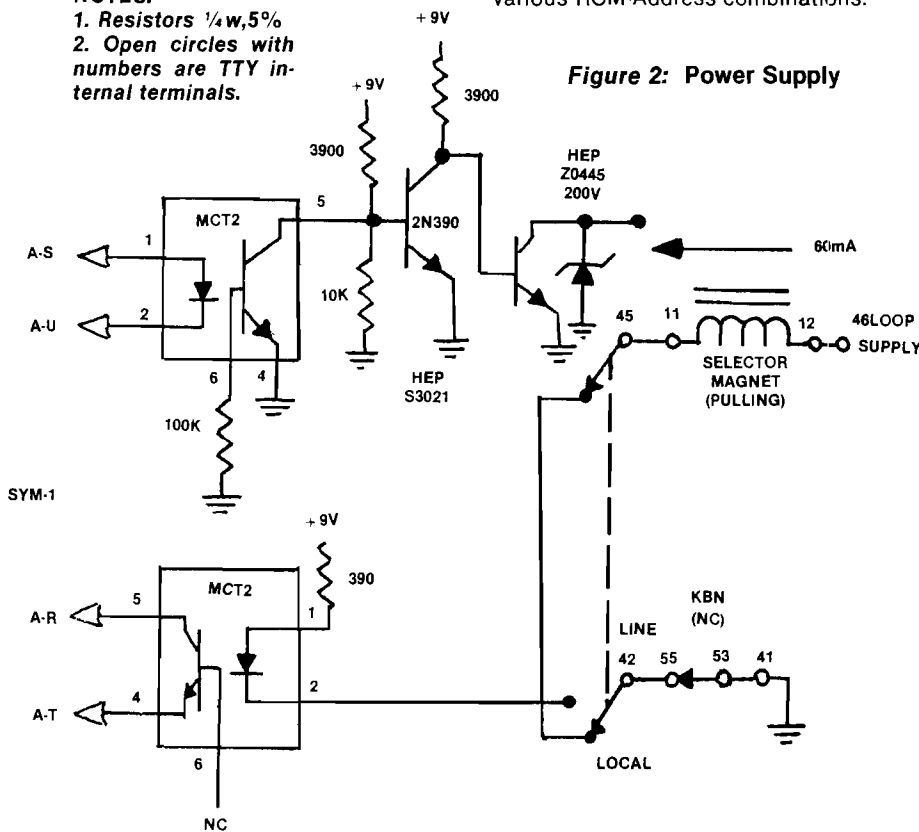

**Figure 1: Interface Logic**

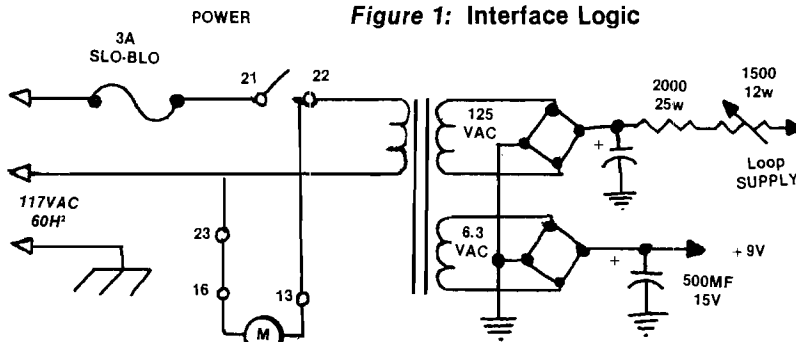

**NOTE:**

- Signal and power ground isolated

**Software**

Given the character set limitations of the Model 15, the first software design requirement I had to address was how to represent the full ASCII character set when printing, and how to generate that set when using the keyboard. Let's look at the output case first.

The first decision was to convert all lower case alphabetic characters (a to z) to upper case. As the software will later show, that is a simple step. Moreover that approach does not create large problems in application, since the need for lower case alphabetic characters is limited unless one is doing word processing. If that is the case I doubt that the Model 15 is the answer in any case.

The second decision was to print those characters not normally printable by a Baudot Teletype as a four character sequence, beginning and ending with a period. For example, an equal sign (\$3D) would be printed as the sequence .EQ.. In addition, of the 32 control codes which the ASCII can represent, I decided to recognize only RETURN, LINEFEED, BELL, and NULL. All others are ignored.

The decision as to how to generate the codes from the keyboard was a bit trickier. The approach selected was to use BELL as an escape character. This simply means that once the character is entered, the following entry or entries are handled in a special way until certain conditions are met. While any key could be used, BELL has the advantage of being seldom used as an input character and thus its use as an escape character is not a big loss. As will be seen later, it is not a loss at all as I can still generate a BELL as an ASCII character.

In the software which I created, the sequence following the escape character is only one or two key strokes in length. In fact it is only two when a LTRS must be entered between the BELL and the operative key. To better understand how this works, consider the following two examples which show both an escape sequence using a key, and the normal mode for that key:

The most difficult part of the hardware interface has already been described. Once the interface hardware is built it is connected to the standard current loop I/O pins on the SYM-1. The only SYM-1 hardware change required is a jumper change if you place the interface software in an EPROM and mount it on the SYM-1 as I did. Any of the empty ROM sockets can be used. Which one you use will depend upon whether you may have already installed the BASIC ROMs, the EDITOR/ASSEMBLER ROM, or some other device. I placed my 2716 in Socket U21 and since I had set the starting address of the software to \$9000, I removed two jumpers and added a new one to enable U21 for \$9000 to \$97FF. Regardless of what you do, the SYM manual gives a complete description of the jumpers and how to set them for various ROM-Address combinations.

USER TYPES

ASCII OUTPUT TO SUPERMON

1	BELL	none
	:	= (\$3D)
	:	: (\$3A)
2	A	A (\$41)
	FIGS	none
	BELL	none
	LTRS	none
	A	SOH (\$01)

As the examples show, the BELL—(char) sequence generates the special character while the character by itself generates that character. The complete table of both input and output character translations is contained in the following table. LTRS and FIGS shifts are obviously required for some of the sequences shown, but have been omitted for brevity. Note that while lower case alphabetic characters cannot now be generated, it would be easy to add a double escape feature in order to do that.

TRANSLATION TABLE

ASCII	INPUT	OUTPUT			
NUL	NUL	NUL	/	/	/
SOH	BELL A		<	<	<
STX	BELL B		)	)	)
ETX	BELL C		*	BELL ↑	.RS.
EOT	BELL D		+	+	+
ENO	BELL E		^	^	^
ACK	BELL F		-	-	-
BEL	BELL G	BELL	.	.	.
BS	BELL H		/	/	/
HT	BELL I		0	0	0
LF	LINEFEED	LINEFEED	1	1	1
VT	BELL K		2	2	2
FF	BELL L		3	3	3
CR	CAR RET	CAR RET	4	4	4
SO	BELL N		5	5	5
SI	BELL O		6	6	6
DLE	BELL P		7	7	7
DC1	BELL Q		8	8	8
DC2	BELL R		9	9	9
DC3	BELL S		:	:	:
DC4	BELL T		;	;	;
NAK	BELL U		<	BELL -	.LT.
SYN	BELL V		=	BELL :	.EQ.
ETB	BELL W		>	BELL +	.GT.
CAN	BELL X		?	?	?
EM	BELL Y		@	BELL &	.AT.
SUB	BELL Z		A to Z	A to Z	A to Z
ESC	BELL BELL		[	BELL <	.LB.
FS	BELL 1		\	BELL ;	.BS.
GS	BELL 2		]	BELL >	.RB.
RS	BELL 3		↑	↑	↑
US	BELL 4		-	BELL SPACE	.UN.
SPACE	SPACE	SPACE	`	BELL \$	.AG.
!	!	!	a to z		A to Z
"	BELL /	.QT.	<	BELL .	.LP.
#	#	#	!	BELL !	.US.
\$	\$	\$	)	BELL ;	.RF.
%	BELL /	.PC.	~	BELL #	.TL.
&	&	&	DEL	BELL NULL	.DL.

Software Implementation

I wish that I could report that the software is very compact and that it uses a great deal of the SUPERMON routines. While the software is not large, at about 1/2K it is not small. On the other hand, the only SUPERMON routines I use are:

- SAVER @ \$8188
- RESXAF @ \$81B8
- RESALL @ \$81C4
- DLYH @ \$8AE9

Also, I use the following RAM and SYSTEM I/O locations:

- CHAR @ \$59 used like SUPERMON does,
- TTYMDE @ \$100 current shift position,
- PBDA @ \$A402 I/O port,
- PBDA + 1 I/O port direction resister,
- SDBYT @ \$A651 timing constant,

As the complete listings indicate, the two top level routines for input and output are ASCIN and ASCOUT respective-

ly. Each of these routines calls other routines to do the actual input with the Teletype. The functions of each routine and its general characteristics are summarized in the following chart.

ROUTINE	FUNCTION	INPUT	OUTPUT	ALTERS	CALLS
ASCIN	set input for full char set using escape sequence	none	ASCII char in A	A,F	SAUER CHRIN RESXAF
ASCOUT	print special sequences or direct char to CHROUT for output	ASCII char in A	none	none	SAUER CHROUT RESALL ALTOUT
CHRIN	set key echo and convert to ASCII	(TTY key)	ASCII char in A	A,F TTYMDE CHAR	SAUER HALF FULL TTYOUT
CHROUT	convert ASCII char to Baudot and handle mode changes	ASCII char in A	none	TTYMDE	SAUER TTYOUT RESALL
TTYOUT	output Baudot char	Baudot char in A	(TTY type)	PBDA PBDA+1 A,F,X Y,TTYMDE	FULL
HALF	delay 11ms	none	none	X	DLYH
FULL	delay 22ms	none	none	X	DLYH

Note that SDBYT must be set to \$2D before using these routines as that parameter is used by DLYH as a timing constant. For teletypes running at higher speeds, either the value of SDBYT or the loop values used in HALF and FULL should be reduced. If your machine is running slightly faster or slower than mine the input or output may not be completely reliable. If that is the case, adjust SDBYT up or down as appropriate, until all functions work error free.

In my system the first routine in software is used to set SDBYT and alter INVEC and OUTVEC to point to the Baudot routines. That is not absolutely necessary, but does make the start-up process somewhat easier. All I have to do is enter G9000 CR on the SYM-1 keyboard and the Baudot I/O package is up and running.

One point of emphasis—as written, this software includes an internal echo for each input. The input sequence is echoed literally. This means that if an escape sequence of BELL / is entered, what is echoed is precisely that and not the .PC. which would be output if the SYM output a %. It would of course be possible to change that approach. A translated echo would be a bit slower since each escape sequence would be echoed as six or seven characters due to the .xx. sequence and the necessary shifts.

### Conclusion

I hope that you find this package useful. If any questions need answering,

please feel free to contact me. And if anyone would like the code translations changed I would be glad to reassemble the software and provide the revised pro-

gram in listing form for the cost of the materials and postage. Good Luck.

```

0000      ;
0000      ;SYM-1 BAUDOT TTY I/O PACKAGE
0000      ;
0000      ;Fixed Parameters
0000      ;
0000      NULL      =#0
0000      FIGMDE   =#0
0000      BELL      =#7
0000      ESC       =#1B
0000      FIGS      =#1B
0000      LTRS      =#1F
0000      SPACE     =#20
0000      LTRMDE   =#20
0000      DELETE   =#7F
0000      ;
0000      ;System RAM Assignments
0000      ;
0000      CHRBUF   =#FB      character buffer
0000      TTYMDE   =#100     TTY shift mode
0000      SDBYT    =#A051    timing constant
0000      INVEC    =#A660    input jump vector
0000      OUTVEC   =#A663    output jump vector
0000      ;
0000      ;SUPERMON Routines
0000      ;
0000      SAUER    =#B180    register save
0000      RESXAF   =#B188    restore except A&P
0000      RESALL   =#B1C4    restore registers
0000      DLYH     =#BAC9    delay
0000      ACCESS   =#B8B0    unprot system RAM
0000      ;
0000      ;I/O Devices
0000      ;
0000      PBDA     =#A402    TTY port
0000      ;
0000      ;I/O VECTOR INITIALIZATION
0000      ;
0000      **$B000
9000      20868B   BEGIN   JSR ACCESS      unprot system RAM
9003      A92D           LDA   #B2D        change timing
9005      8D51A6        STA   SDBYT       in SUPERMON
9008      A985           LDA   #ASCOUT+256 256 extra output
900A      8D54A6        STA   OUTVEC+1    to OUTVEC
900D      A990           LDA   #ASCOUT+256 256 extra input
900F      8D55A6        STA   OUTVEC+2    to OUTVEC
9012      A91D           LDA   #ASCIN+256-156 then input
9014      8D51A6        STA   INVEC+1     vector
9017      A990           LDA   #ASCIN+256   Baudot TTY
9019      8D62A6        STA   INVEC+2     then handle
901C      60            RTS             then return
901D      ;
901E      ;ASCII Input
901F      ; Uses BELL as escape character to
9020      ; generate full ASCII character set
9021      ; except for lower case alpha
9022      ;
9023      208881   ASCIN   JSR SAUER      save registers
9024      20EB90   JSR CHRIN      get char
9025      C907     CMP   #BELL      if not SCUL
9026      D01B     BNE   EXTRIN     then return
9027      20EB90   ESCAPE JSR CHRIN      get second char
9028      C907     CMP   #BELL      if not SCUL
9029      D004     BNE   NOTESC     then jump
902A      A61B     LDA   #ESC       set ESC code
902B      D010     BNE   EXTRIN     and return
902C      C900     CMP   #NULL      if not NULL
902D      D004     BNE   NOTDEL     then jump
902E      A97F     LDA   #DELETE    else set DEL
902F      D008     BNE   EXTRIN     and return
9030      C520     CMP   SPACE      if less than space
9031      B0C     BCC   ESCAPE      then addin
9032      AA       TAX             move char to index
9033      B04590   LDA   ASCII,X     and get translation
9034      4CB861   JMP   RESXAF     restore and return
9035      5F       ASCII  .BYTE $5F,$70,$7E,$60,$48,$42
9036      7C

```

```

9047 00
9048 7E
9049 60
904A 00
904B 40
904C 22
904D 58 .BYTE $5B,$5D,$0,$3E,$7D,$3C,$7B,$25
904E 50
904F 00
9050 3E
9051 7D
9052 3C
9053 7B
9054 25
9055 00 .BYTE 0,$1C,$1D,$1E,$1F,$0,$0
9056 1C
9057 10
9058 1E
9059 1F
905A 00
905B 00
905C 00
905D 00 .BYTE 0,$0,$3D,$5C,$0,$0,$0
905E 00
905F 3D
9060 5C
9061 00
9062 00
9063 00
9064 00
9065 00 .BYTE 0,1,2,3,4,5,6,7
9066 01
9067 02
9068 03
9069 04
906A 05
906B 06
906C 07
906D 08 .BYTE 8,9,$A,$B,$C,$D,$E,$F
906E 09
906F 0A
9070 0B
9071 0C
9072 0D
9073 0E
9074 0F
9075 10 .BYTE $10,$11,$12,$13,$14,$15,$16,$17
9076 11
9077 12
9078 13
9079 14
907A 15
907B 16
907C 17
907D 18 .BYTE $18,$19,$1A,$0,$0,$0,$2A,$0
907E 19
907F 1A
9080 00
9081 00
9082 00
9083 2A
9084 00
9085 ;
9085 ;ASCII Output
9085 ; Output characters normal & not
9085 ; printed by BRUDOT TTY as a 4 byte
9085 ; character sequence of 10,11,12,13
9085 ; i.e. All other characters are
9085 ; forwarded to CHROUT for printing.
9085 ;
9085 208881 ASCOUT JSR SAVER save registers
9088 297F AND #17F mask out esp
908A A230 LDY #LSTSQ-MULTI*250/250 set offset
908C DB6390 TSTCHR CMP MULTIX test char
908F F00A BEQ OUTSTR if match send sea
9091 A003 LDY #3 set up to
9093 0A MUPNTR DEY count down
9094 301A BNE HTFND but if no match jump
9096 88 DEY count down
9097 D0FA BNE MUPNTR until five less
9099 F0F1 BEQ TSTCHR then do test next
909B A002 OUTSTR LDY #2 send 2 char
909D 20E690 JSR PRDOUT send period
909E E8 NXTOUT INC more pointer
90A1 DB6390 LDA MULTIX and set char
90A4 204F91 JSR CHROUT and send it
90A7 88 DEY loop until
90A8 D0F6 BNE NXTOUT all sent
90AA 20E690 JSR PRDOUT send period
90AD 40C481 JMP RESALL then return
90B0 4C5491 HTFND JMP ALTOUT jump for single char
90B3 22 MULTI .BYTE "0BT"

```

```

90B4 51
90B5 54
90B6 25 .BYTE "NPO"
90B7 50
90B8 43
90B9 2A .BYTE "KAS"
90BA 41
90BB 53
90BC 3C .BYTE "KLT"
90BD 4C
90BE 54
90BF 3D .BYTE "EQ"
90C0 45
90C1 51
90C2 3E .BYTE "GT"
90C3 47
90C4 54
90C5 40 .BYTE "EAT"
90C6 41
90C7 54
90C8 5B .BYTE "LBS"
90C9 4C
90CA 42
90CB 5C .BYTE "BS"
90CC 42
90CD 5C
90CE 5D .BYTE "RBS"
90CF 52
90D0 42
90D1 5F .BYTE "LUN"
90D2 55
90D3 4E
90D4 60 .BYTE "AG"
90D5 41
90D6 47
90D7 7B .BYTE "CLR"
90D8 4C
90D9 50
90DA 7C .BYTE "LUS"
90DB 56
90DC 53
90DD 7D .BYTE "RPS"
90DE 52
90DF 50
90E0 7E .BYTE "TL"
90E1 54
90E2 4C LSTSQ .BYTE DELETE
90E3 7F .BYTE "DL"
90E4 44
90E5 4C
90E6 ;
90E6 ;Output Period
90E6 ;
90E6 A92E PRDOUT LDA #. set period
90E8 4C4F91 JMP CHROUT do do it
90EB ;
90EB ;Character Input
90EB ; Gets input from BRUDOT keyboard
90EB ; and converts to ASCII and echos
90EB ; character.
90EB ;
90EB 208881 CHRIN JSR SAVER save registers
90EE A900 AGAIN LDA #NULL clear buffer
90F0 85F9 STA CHRBUF in RAM
90F2 2C02A4 LOOK BIT PEDR test for start
90F5 50FB BVC LOOK if not loop
90F7 200292 JSR HALF else wait half bit
90FA 2C02A4 BIT PEDR and test again
90FD 50F3 BVC LOOK if false start over
90FF A007 LDY #7 set seven bits
9101 200692 NXTIN JSR FULL wait bit time
9104 2C02A4 BIT PEDR test input
9107 18 CLC 0 if no overflow
9108 5001 BVC SAME save if 0
910A 38 SEC else is 1
910B 66F9 SAVE ROR CHRBUF shift into buffer
910D 88 DEY count down
910E D0F1 BNE NXTIN loop if more
9110 A5F9 LDA CHRBUF set char
9112 4A LSR R and finish shift
9113 49FF EOR #1FF complement
9115 291F AND #1F set 5 data bits
9117 48 PHA save char
9118 20E091 JSR TTYOUT then echo
911B 68 PLA restore char
911C C91F CMP #LTRS if not LTRS
911E D008 BNE NOTLTR then jump
9120 A920 LDA #LTPMDC set LTRS mode code
9122 800001 SETMDC STA TTYMDC and set mode
9125 4CEE90 JMP AGAIN then try again
9128 C91B NOTLTR CMP #FIGS if not FIGS
912A D004 BNE NOTFIG then jump

```

```

912C A900      LDA #FIGMDE    set FIGS mode code
912E F0F2      BEQ SETMDE     and set
9130 18        NOTFIG   CLC             clear carry
9131 6D0001    ADC TTYMDE    convert to table
9134 85F9      TRVOTH   STA CHRBUF   and save
9136 A25F      LDX #95     number char - 1
9138 B08091    SEARCH   LDA BAUDOT,X  set table entry
913B 293F      AND #3F     look at mode+data
913D C5F9      CMP CHRBUF   if same as buffer
913F F00A      BEQ FOUND    then found
9141 CA        DEX             else count down
9142 10F4      BPL SEARCH   and loop until all tested
9144 A5F9      LDA CHRBUF   set char
9146 4920      EOR #LTRMDE   complement mode
9148 4C3491    JMP TRVOTH   and try again
914B 8A        FOUND   TXA             move ASCII to A
914C 4C8381    JMP RESXAF   and return
914F          ;
914F          ;Output Single ASCII Character
914F          ; Converts to BAUDOT and handles
914F          ; mode changes as required.
914F          ;
914F 208381    CHAROUT JSR SAUER     save registers
9152 297F      AND #7F     mask out msb
9154 C960      ALTOUT   CMP #60     if upper case
9156 9002      BCC UPRCSE   skip convert
9158 29DF      AND #DF     else make upper
915A AA        UPRCSE   TAX             make char pointer
915B B08091    LDA BAUDOT,X  set BAUDOT
915E C980      CMP #30     if msb=1
9160 B01B      BCS NOPRNT  do not print
9162 C940      CMP #40     if next bit=0
9164 9014      BCC NOMMDE   no mode change
9166 48        PHA             else save char
9167 2920      AND #LTRMDE  look at mode bit
9169 CD0001    CMP TTYMDE   if same
916C F00B      BEQ NOCHNG   then no change
916E 3D0001    STA TTYMDE   else save
9171 4A        LSR A             move to
9172 4A        LSR A             correct
9173 4A        LSR A             position
9174 0918      ORA #FIGS   convert to char
9176 20E091    JSR TTYVOUT  and send
9179 68        NOCHNG  PLA             set char back
917A 20E091    NOMMDE  JSR TTYVOUT  send it
917D 4CC481    NOPRNT  JMP RESALL  and return
9180 60        BAUDOT  .BYTE $60,$FF,$FF,$FF,$FF,$FF,$FF,$FF,$45
9181 FF
9182 FF
9183 FF
9184 FF
9185 FF
9186 FF
9187 45
9188 FF      .BYTE $FF,$FF,2,$FF,$FF,8,$FF,$FF
9189 FF
918A 02
918B FF
918C FF
918D 08
918E FF
918F FF
9190 FF      .BYTE $FF,$FF,$FF,$FF,$FF,$FF,$FF,$FF
9191 FF
9192 FF
9193 FF
9194 FF
9195 FF
9196 FF
9197 FF
9198 FF      .BYTE $FF,$FF,$FF,$FF,$FF,$FF,$FF,$FF
9199 FF
919A FF
919B FF
919C FF
919D FF
919E FF
919F FF
91A0 04      .BYTE 4,$4D,$FF,$54,$49,$FF,$5A,$48
91A1 4D
91A2 FF
91A3 54
91A4 49
91A5 FF
91A6 5A
91A7 4B
91A8 4F      .BYTE $4F,$52,$FF,$51,$4C,$4D,$5C,$5D
91A9 52
91AA FF
91AB 51
91AC 4C
91AD 40
91AE 5C
91AF 5D
91B0 56      .BYTE $56,$57,$53,$41,$4A,$50,$55,$47
91B1 57
91B2 53
91B3 41
91B4 4A
91B5 50
91B6 55
91B7 47
91B8 46      .BYTE $46,$58,$4E,$5E,$FF,$FF,$FF,$59
91B9 58
91BA 4E
91BB 5E
91BC FF
91BD FF
91BE FF
91BF 59
91C0 FF      .BYTE $FF,$63,$79,$6E,$69,$61,$6D,$7A
91C1 63
91C2 79
91C3 6E
91C4 69
91C5 61
91C6 6D
91C7 7A
91C8 74      .BYTE $74,$66,$6B,$6F,$72,$7C,$6C,$78
91C9 66
91CA 6B
91CB 6F
91CC 72
91CD 7C
91CE 6C
91CF 78
91D0 76      .BYTE $76,$77,$6A,$65,$70,$67,$7E,$73
91D1 77
91D2 6A
91D3 65
91D4 70
91D5 67
91D6 7E
91D7 73
91D8 7D      .BYTE $7D,$75,$71,$FF,$FF,$FF,$43,$FF
91D9 75
91DA 71
91DB FF
91DC FF
91DD FF
91DE 43
91DF FF
91E0
91E0      ;
91E0      ;BAUDOT Output
91E0      ;
91E0 A220      TTYVOUT  LDX #320     set font to
91E2 8E03A4    STX PEDA+1   output mode
91E5 291F      AND #1F     look at data bits
91E7 0960      ORA #60     add 2 stop bits
91E9 49FF      EOR #FF     complement
91EB 38      SEC             set start bit
91EC 2A      ROL A             set mode
91ED A008      LDY #8     setup for 8 bits
91EF 4A      LSR A             move lsb to C
91F0 48      PHA             save char
91F1 A900      LDA #0     clear for zero
91F3 9002      BCC OUTONE  if no carry done
91F5 0920      ORA #20     else set bit
91F7 8002A4    STA PEDA+1  send to font
91FA 68      PLA             set char back
91FB 200692    JSR FULL    delay one bit
91FE 88      DEY             then count down
91FF D0EE      BNE NXTBIT  if more then loop
9201 60      RTS             else quit
9202
9202      ;
9202      ;Bit Timing Routines
9202      ;
9202 A20B      HALF   LDX #11     half period delay
9204 D002      BNE TIMLOP  so do it
9206 A216      FULL   LDX #22     full period
9208 20E98A    TIMLOP JSR DLVH    delay lms
920B 48      PHA             fill
920C 68      PLA
920D CA      DEX             count down
920E D0F8      BNE TIMLOP  and loop
9210 60      RTS             until done
9211      .END

```



# The MICRO Software Catalog: XIV

Mike Rowe  
P.O. Box 6502  
Chelmsford, MA 01824

## Software Catalog Note

This regular feature of MICRO is provided both as a service to our readers and as a service to the 6502 industry which is working hard to develop new and better software products for the 6502 based system. There is no charge for listings in this catalog. All that is required is that material for the listing be submitted in the listing format. All info should be included. We reserve the right to edit and/or reject any submission. Some of the submissions are starting to get much too long. We might not edit the description the same way you would, so please, be brief and specific.

Name: **Environment for KIM BASIC**  
System: **KIM running Microsoft BASIC**  
Memory: **1.2K**  
Language: **Machine language**  
Hardware: **any KIM that runs BASIC**

Description: This software package provides the following utility programs for use with KIM BASIC: Renummer, Range Deletion, Append, Character-Oriented Line Editing, Automatic Line Number Prompting, Controlled Listings. The package is configured to interface itself automatically with any version of 9-digit KIM BASIC upon execution. There are no restrictions on length of internal references in lines; you can renumber from 1,2,3, to 63000,63010 and back again. Renumbers typical 200 line program in less than 10 seconds. Range deletions (i.e. Delete 100-950) take approximately 5 seconds per 100 lines deleted. One POKE makes the next LOAD an APPEND and then restores regular LOAD status. All functions have complete error checks before changing your original program and report errors using BASIC's own error messages. Page length can be varied during listing or command mode at any point. Edit mode allows moving lines in the program or changing one section of a line without retyping the complete commented source listing.

Includes: **KIM format tape, source, manual**  
Price: **\$20.00** plus \$1.50 shipping and handling. California residents add 6% sales tax.  
Author: **Sean McKenna**  
Available from: **Sean McKenna**  
64 Fairview Ave.  
Piedmont, CA 94610

Name: **MEM-EXPLORER**  
System: **Commodore PET**  
Memory: **8K or more**  
Language: **Microsoft PET BASIC** with 6502 machine-language subroutine  
Hardware: **PET 2001-8, 2001-16, or 2001-32**

Description: MEM-EXPLORER gives the PET owner a "window" into his computer, to give an understandable view of memory contents—both user (RAM) and Interpreter/OS (ROM). When the program is run, you are asked for a starting location. MEM-EXPLORER then presents information on 20 bytes of memory, starting with the location you specified. In the left column is the address of the byte, while columns to the right hold the decimal value of its contents, the character equivalent (or BASIC token, if appropriate), and two different two-byte values (address, integer). By specifying the area in RAM where the BASIC program is stored, you can actually see the program "listed" vertically in the character column, and tell exactly where every character or token is stored. MEM-EXPLORER includes routines that allow it to be combined with your programs automatically.

Copies: **Many**  
Price: **\$7.95** (quantity discount available)  
Includes: **Cassette in Norelco-style box, description, operating instructions, and zip-lock protective package.**  
Designer: **Roy Busdiecker**  
Available from: **Better computer stores, or directly from Micro Software Systems**  
P.O. Box 1442  
Woodbridge, VA 22193

Name: **Space Shuttle Landing Simulator**  
System: **APPLE II**  
Memory: **48K**  
Language: **Assembly and Applesoft II**  
Hardware: **6HIRES color APPLE and Applesoft II ROM card**

Description: Modeled after the real Shuttle Mission Simulator, this program is a real flight simulator. The HIRES screen shows the "out-the-window" view using animation, projective geometry, and high speed assembly language graphics to display the image of the runway, sky, mountain, clouds, etc. In text below the screen is the flight data plus warnings and messages. Real flight algorithms are tailored to the Shuttle Orbiter's flight characteristics providing realistic stick response using the game paddle. Functional features are: full stall capability, ejection, landing gear, speed brakes, and wheel brakes on roll out. Runway stripes on roll out give a speed indication. The instruction manual is 10 pages, over 3500 words, and provides a brief introduction to guiding flight.

Copies: **Just Released (20 Aug 79).**  
Price: **\$15.00 ppd.** New Mexico residents add 4% sales tax.  
Author: **John Martellaro**  
Available from:  
Harvey's Space Ship Repair  
P.O. Box 3478  
University Park  
Las Cruces, NM 88003

Name: **XMON, an extended monitor for TIM**  
System: **any version of TIM**  
Memory: **minimum 512 bytes**  
Language: **6502 assembly**  
Hardware: **Minimum TIM plus 2708 addressing and comparator with 5 discretes; optional LED and 2 discretes.**

Description: Nine commands from terminal provide: fill memory with constant; move, compare memory blocks; search for string; go execute with breakpoint and single step trace; exit to TIM monitor; load and dump KIM format cassette at 4K/min. All functions externally callable; suitable for calling by TINY USR function. Standard version resides EC00 through EFFF.

Copies: **Just Released**  
Price: **\$28.00** for standard version, Add **\$7.00** for relocation.  
Includes: 2708 PROM, comparator and discretes, instructions, schematics.  
Author: **Phil Lange**  
Available from:  
206 Santa Clara Ave.  
Dayton, Ohio 45405  
(513) 278-0506

Name: **APPLE II Sweet 16 Assembler**  
System: **APPLE II**  
Memory: **16K RAM, Cassette Deck**  
Language: **Machine and Sweet 16**

Description: This system is a co-resident, two pass assembler for Sweet 16, the 16 bit software processor resident in the APPLE II Rom. The assembler has full cursor editing capabilities identical to those of Applesoft, English Language error messages, and line length up to 255 characters for extended program documentation. Commands are included to read and write the text file to tape, display the input format, renumber lines, list text file, return to APPLE monitor, and to assemble. The assembler supports pseudo OPS to determine ASCII strings, define hex strings, label location, and define program origin. The assembler lists addresses, object code, source code and symbol table. Included with the program is full documentation for use of the assembler, plus a full description of all Sweet 16 OP codes and 16 bit registers and short programs illustrating each operation.

Copies: **Just Released**  
Price: **\$15.00**  
Author: **Steve Cochard**  
Available from:  
Scientific Software  
P.O. Box 156  
Stowe, PA 19464

Name: **AMPER-SORT II**  
System: **APPLE**  
Memory: **32K minimum**  
Language: **Assembler**

Description: AMPER-SORT II is an enhanced version of the AMPER-SORT routine published in MICRO, number 14. Two major enhancements improve sort speed and increase its versatility. The Shell-Metzner algorithm reduces sort time and a capability to sort two-dimensional character string arrays enables AMPER-SORT II to be used easily with programs such as FILE CABINET, an Apple Contributed Software Bank program. FILE CABINET with AMPER-SORT II will sort 100 records of 3 10-byte-average fields in 3 seconds compared to 7 minutes using the original BASIC sort code. AMPER-SORT II will sort integer arrays, floating point arrays, and one or two-dimensional string arrays. It also features an easy-to-use BASIC interface to pass array name and sort parameters.

Copies: **Just Released**  
Price: **\$15.95.** (California residents add 6% sales tax)  
Author: **Alan G. Hill**  
Available from:  
PROGRAMMA INTERNATIONAL, Inc.  
3400 Wilshire Blvd.  
Los Angeles, CA 90010

# Bringing Music Home

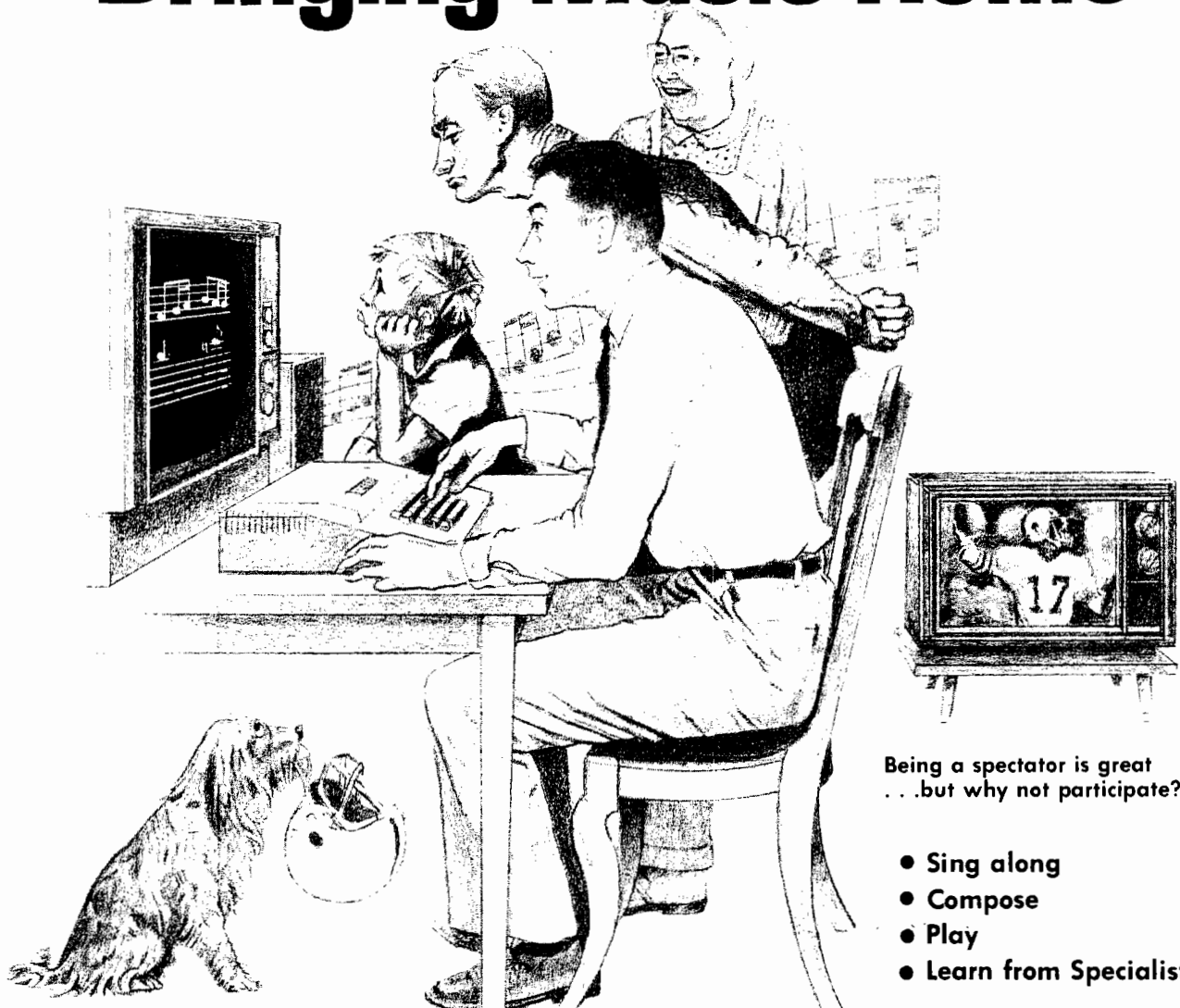

Being a spectator is great  
...but why not participate?

- Sing along
- Compose
- Play
- Learn from Specialists

## LET MICRO MUSIC TURN YOUR APPLE II® INTO A FAMILY MUSIC CENTER!

VISIT THE APPLE DEALER NEAREST YOU AND ASK FOR A DEMONSTRATION OF MMI'S MICRO COMPOSER™

The MICRO COMPOSER LETS YOU—

- Play up to 4 simultaneous voices
- See all 4 voices at the same time you're hearing the music—a must for music editing!
- Enter music notes by a fast, simple and well-tested coding system.
- Program the pitch, rhythm, and timbre of the music. Tempo is varied by the Apple paddle.
- Choose 7 different tone colors for each voice or create your own tone color.
- Compose, edit, display, and play music through an interactive, command-driven language that's easy to learn.
- Save your music on disk or cassette.
- Hear quality music sound at low cost through the MICRO MUSIC™ DAC card. No amplifier needed! Designed for MMI by Hal Chamberlin and Micro Technology Unlimited.
- Select from future MMI music instruction software to accompany the MICRO MUSIC DAC.

Ask your local dealer for information on MMI products, or contact:

The MICRO COMPOSER is an APPLE II® compatible, low-cost music system designed by the folks at MMI. Our music software was designed by leading experts in music education. A simple step-by-step instruction manual leads you through entering, displaying, editing, and playing music with up to four voices—soprano, alto, tenor, and bass. You can change the sound of each voice to reed, brass, string, or organ sounds and you can even color your own music sounds!

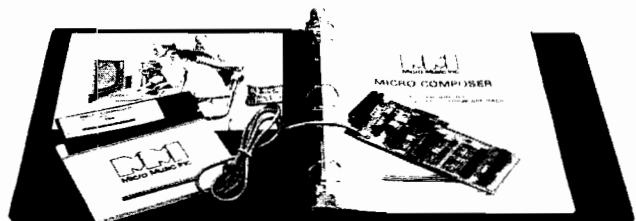

HAVE FUN! THE MICRO COMPOSER comes complete with an instruction manual, software disk or cassette—in either Integer or Applesoft ROM BASIC, and the MICRO MUSIC DAC music card. Just plug the MICRO MUSIC DAC into the APPLE extension slot and connect the audio cable to a speaker.

Suggested retail price \$220.



Micro Music Inc 309 Beaufort, University Plaza, Normal, IL 61761

APPLE II is a trademark of Apple Computer Inc

### MICRO Reviewer

One of the most common requests I receive from our readers is that MICRO provide reviews of hardware and software products. One of the most common types of articles MICRO receives is the product review. Why then, you may reasonably ask, hasn't MICRO printed lots of reviews? The answer is simple. While some other magazines print product reviews as filler material, I feel that a product review is a very special trust and must be handled in special ways. I feel that any review printed in MICRO should be as accurate, unbiased, and complete as possible, and that the qualifications and potential "conflicts of interest" of the author should be known.

#### Unsolicited Reviews

Think for a moment about the unsolicited reviews MICRO receives. Why did the author write the review? Probably for one of two reasons:

- He loved the product, or,
- He hated the product.

In either case the author is biased. An even more serious problem with the unsolicited review is that an author could have a vested interest in a product. He might be a friend of the manufacturer of the product, or could even be the manufacturer himself! Another problem is that the coverage of the possible products is going to be very spotty. Since every author is free to choose what he is going to review, some very good products will be overlooked, and some bad ones, too.

#### A Plan

I have come up with a plan which I feel will permit MICRO to obtain the types of reviews it wants and which the readers require. Phase 1 of the plan entails getting a list of qualified, unbiased reviewers. This panel of reviewers would each fill out the attached form and submit it to MICRO. Authors would then be selected from this group to review products. Since the form provides a means by which the basic qualifications of the authors may be deter-

mined, and since the selection would be made by MICRO, not the individual authors, both the qualification and bias problems should be solved.

#### Reviewer Qualification Form

Why should you become a reviewer for MICRO? I can think of a number of good reasons. First, you will get a chance to try new products, often before they become generally available. Second, you will get a chance to help fellow computerists by providing the detailed information they need to help decide on the merits of various products. Third, you will have your review published under your "byline". Fourth, you will be paid by MICRO for the review. Fifth, you will normally be able to purchase the product you reviewed at a substantial discount.

If you would like to become a reviewer for MICRO, please complete and return the attached form.



### MICRO Reviewer Qualification Form

Name: .....

Address: .....

City: ..... State: ..... Zip: .....

Phone: Days: ..... Evenings: .....

List all 6502 Hardware you own or have 'unlimited' access to: .....

List Programming languages you are qualified in and can use on your equipment: .....

List types of 6502 applications you are interested in: .....

List any special equipment which your system uses/supports: .....

List ALL companies, stores, etc. with which you have any relationship other than as customer, and ANY company, store, etc. whose products you do not feel you should review for any other reason:

Write a brief biography which may be published with your reviews which gives the reader a summary of your interests and qualifications: .....

I declare that the above information is complete and accurate.

Signed: ..... Date: .....

Please complete, using additional pages if necessary, and return to: MICRO, P.O. Box 6502, Chelmsford, MA 01824



# Alarming APPLE

Paul Irwin  
P.O.B. 1264, Station B  
Ottawa, Ontario K1P 5R3  
Canada



---

**Here is a way to program you APPLE to respond to errors with an alarm and keyboard lockout.**

---

Instead of using the CTRL-G beep on your next program, here's an alarm system written to assist in performing error recovery on the APPLE II. When the alarm system is used, your program will react to an error by immediately locking the keyboard, sounding a continuous two-tone alarm, and forcing the operator's attention to an error recovery subroutine. No way will recognizable errors escape your edits once they meet the Alarming APPLE!

To use the alarm system, start with each of your subroutines clearly defined as either *error detecting* or *error correcting*. This means that you will classify most of your "normal" routines as error detecting routines. Arrange to have all of your routines invoked by a mainline. Then the mainline can invoke error correcting routines, as well, and still remain in control. This is illustrated by the program shown here.

In the BASIC listing, the one error detecting routine is called TASK, while the error correcting routine is TRAP. The mainline is free to decide what to do after recovery: whether to continue the same error detecting routine or to take any other action. An intelligent mainline of this sort can avoid most error recovery hassles.

The key to the error recovery procedure is a machine language routine called ALARM. It is invoked from BASIC by executing a CALL 3529 and from machine language by executing a JSR \$DC9. The alarm routine will then generate a two-tone alarm continuously. At the end of each cycle, it examines the keyboard for a CTRL-C. If none was found, it continues sounding the alarm. But when a CTRL-C is typed, the sound will stop and the routine will return. The effect is to produce a continuous sound, ignoring any input, until a CTRL-C is entered.

You may have your own ideas as to how the alarm should sound. The duration of the first tone is in \$DA2 and its period is in \$D9D. The second tone has its duration and pitch stored in \$DBF and \$DBA. The two that I employ are quite noisy, but you can experiment with other parameter pairs. Those periods that are relatively prime — having no common factor — will produce discord. They will be loudest when matching the APPLE's speaker resonance.

When loading the routines, remember to set LOMEM greater than \$DD0, the highest location in the alarm routine, so the two won't overwrite each other. The BASIC routine shown here will run as it

appears, and will invoke the machine language routine. If you are not bothering with the BASIC, simply JSR \$DC9.

After you run the Alarming APPLE and decide to use it for error recovery in your next program, consider these ideas:

Organize the program into error detecting routines, one or more error recovery routines, and an intelligent mainline.

Use an error flag in the recovery routines to inform the mainline.

Use a status flag in the error recovery routines to indicate success or failure of the recovery procedure to the mainline.

Let the mainline make *all* decisions regarding what to do next.

For instance, if you are heavily into structured programming, you might consider a mainline centered on a computed GOSUB with the returns of each routine setting a status number pointing to the next routine. Or you may want to use IFs and GOSUBs together in the mainline as each case is decided. The important thing is to route all control decisions — decisions that answer the question: "What next?" — through the mainline. Including error recovery decisions. In fact, *especially* error recovery decisions.

```

1 REM . BASIC CALL SEQUENCE
2 REM . FOR ALARM PROMPT ROUTINE
3 REM .
4 TASK=3000
10 OFF=0:TASK=200:TRAP=300:ALARM=3529
95 REM
96 REM MAIN LINE SEQUENCE
97 REM
98 REM .
99 REM .
100 ERR=OFF:GOSUB TASK:IF ERR THEN GOSUB
TRAP
101 REM .
102 REM .
110 GOTO 32767
120 REM
121 REM
122 REM
200 INPUT ERR:REM USE FOR TEST
210 REM
211 REM PUT ERROR DETECTING TASK HERE
212 REM REPLACING LINE 200
213 REM
220 RETURN
297 REM
298 REM
299 REM
300 POKE 50,127:PRINT "ERROR":POKE 50,255
:PRINT " TYPE A CTRL/C":CALL ALARM
310 REM
320 REM PUT ERROR RECOVERY ROUTINE HERE
330 REM
340 RETURN

```

Figure 1: Example of a BASIC program invoking the alarm routine in Fig. 2. 3529 is \$DC9.

```

0081- FF ???
0082- FF ???
0083- A0 30 C0 LDA $C030
0086- 88 DEY
0087- D0 05 BNE $008E
0089- CE 82 00 DEC $0082
008C- F0 09 BEQ $0097
008E- CA DEX
008F- D0 F5 BNE $0086
0091- AE 81 00 LDX $0081
0094- 4C 83 00 JMP $0083
0097- 60 RTS
0098- A0 00 LDY #$00
009A- A2 00 LDX #$00
009C- A9 47 LDA #$47
009E- 8D 81 00 STA $0081
00A1- A9 A0 LDA #$A0
00A3- 8D 82 00 STA $0082
00A6- 20 83 00 JSR $0083
00A9- 2C 00 C0 BIT $C000
00AC- 10 07 BPL $00B5
00AE- A0 00 C0 LDA $C000
00B1- 2C 10 C0 BIT $C010
00B4- 60 RTS
00B5- A0 00 LDY #$00
00B7- A2 00 LDX #$00
00B9- A9 50 LDA #$50
00BB- 8D 81 00 STA $0081
00BE- A9 A0 LDA #$A0
00C0- 8D 82 00 STA $0082
00C3- 20 83 00 JSR $0083
00C6- 4C 98 00 JMP $0098
00C9- 20 98 00 JSR $0098
00CC- C9 83 CMP #$83
00CE- D0 F9 BNE $00C9
00D0- 60 RTS

```

Figure 2: Machine language routine to sound two-tone alarm until ctrl/C is typed. All other input is ignored. To demonstrate, type DC9G to the APPLE II monitor.



## ADVENTURE

GAMES OF HIGH ADVENTURE  
FOR THE APPLE II FROM  
**SYNERGISTIC SOFTWARE**

5221 120th Ave. S.E.  
Bellevue, WA 98006

The Adventure games combine the exciting graphics and sound effects capabilities of the APPLE II with the fascinating complexity of a mythical adventure game. Monsters, hazards, obstacles, weapons, magical devices and evil powers confront the player at every turn as you gather treasure and try to reach your goal. Two adventures are now available:

**DUNGEON CAMPAIGN** - Full color graphics  
subterranean adventure. 16K required.  
CASS, \$12.50 DISK \$15.00

**WILDERNESS CAMPAIGN** - HIRES graphics  
surface adventure. 48K required.  
CASS, \$15.00 DISK \$17.50

GET BOTH ON ONE DISK FOR \$30.00

(WA Res. add 5.3% sales tax)

## Put Yourself in Control with the APPLETHROTTLE

That's right! The APPLETHROTTLE will turn your game paddles into a speed controller. By simply pushing a button, you can stop your computer for as long as you want. Release the button, and your computer enters a slow-motion mode with one paddle controlling the speed. And if that isn't enough, look at these additional features:

- Plugs into any slot
- Works with machine language, Integer BASIC, and Applesoft
- Normal - slow - stop
- Use to LIST, TRACE, RUN, etc.
- NO SOFTWARE to load
- Unveil program secrets

APPLETHROTTLE ..... \$89.95

And there's more! No more multiple LIST commands to view small program sections. With the APPLETHROTTLE, you'll be able to list or trace long programs while watching your program flow in slow-motion. So get in control with the APPLETHROTTLE and order yours today!

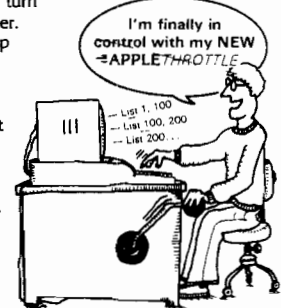

**APPLETIME**, a Real Time Clock for the Apple II. Plugs directly into any slot and keeps time even when computer is off. Features 12/24 Hour, BCD/ASCII data format, and AC/Crystal time base selection. Includes software examples for machine language and BASIC programs. Completely assembled and tested.  
**APT-1** Real Time Clock \$79.95

**PROTOBOARD**, with over 1300 holes on 0.1 centers for designing your own circuits.  
**APB-1** Protoboard .... \$17.95

**VERBATIM 5 1/4" DISKETTES**  
Soft-Sector Box of 10 ... \$34.50  
(plastic file case included)



**west side electronics**

P.O. Box 636, Chatsworth, CA 91311  
We pay all shipping in Continental U.S.A.  
Others add 10%. California residents add 6% tax.



# 6502 Bibliography: Part XIV

William R. Dial  
438 Roslyn Avenue  
Akron, OH 44320

## 491. Rainbow 1, Number 4 (April, 1979)

Minch, David "Review: Electronic Index Card", p1.  
This program by Bob Bishop emulates a card index file but the reviewer doesn't think it offers substantial advantages.

Editor, "Pascal", p2.

The editor discusses the Pascal Language soon to be available to Apple owners.

Simpson, Rick "Introduction to Assembly Language Programming" pgs. 4-19.

A tutorial article on this important subject.

Watson, Allen "HI-RES Color" pg. 10.

The relationship between the color subcarrier frequency and the color dots; also why there are gaps in vertical and near vertical vectors in colors other than white.

Minch, David "Firmware Review — Programmer's Aid ROM" pgs. 11-12.

The reviewer feels the ROM is a mixed blessing, of limited utility. The Operating Manual is very good.

## 492. KB Microcomputing No 30 (June, 1979)

Lindsay, Len "PET Pouri" pgs. 6-12.

Discusses a way to protect software, evaluation of cassette quality, new hardware and software, periodicals with PET information, list protection, Trace program, and disabling the STOP key.

Anon., "Ohio Scientific's Small System Journal" pg.8-11

Discussion of Microcomputer Information Management systems.

Van Dyke, James A. "A Sneaky Interrupt for the 6502" pg. 97.

A novel interrupt using the SO input pin.

## 493. Creative Computing 5 No 5 (May, 1979)

Kelley, Derek "Beyond the Text Editor" pgs. 32-33.

Program that searches for words, etc., on the Apple.

Hunter, Jim "Peripherals Unlimited Text Editor" p.46.

Upper and Lower case word processing with the Dan Paymar lower case adapter for the Apple and this Text Editor.

Yob, Gregory "Personal Electronic Transactions" pgs. 122-127.

I/O on the PET, Notes on PET Graphics, including higher resolution, a list of PET I/O lines.

## 494. Personal Computing 3 (June, 1979)

Zimmermann, Mark "Line Renumbering Renumbered" pg.7.

Modifications to the earlier program published in March, for the Apple.

Zimmermann, Mark " 'G' is for Graphics" pgs. 38-41.

An educational picture book for the kids on the PET.

## 495. Cider Press 2 (May, 1979)

Anon. "Apple Tape Beeps Translated" pg.3.

Why the beeps are on the leader and at the end of programs.

Anon. "May DOM" pg. 2.

The May Disk of the Month has a good mix of programs of different categories; games, utilities, business, etc. Apple.

Hertzfeld, Andy "An Easy Way to Use Text Page 2" pg.3.

Add text to page two graphics using these instructions on the Apple.

Aldrich, Ron "Split Catalog" pg.4.

Split your catalog print-out on the Apple Disk, printing two titles across the page.

Kamins, Scot and Guarriques, Chris "Mini-Word Processor" pg.4.

The Cider Squeezer was specifically designed to aid Apple users to write short articles.

Draper, John T. "Textwriter's Creation" pg.5.

Discussion of how a word processor evolved. Apple.

Espinosa, Chris and Wyman, Paul "CALLS, POKES and PEEKS" pgs. 6-7.

A convenient listing of these important routines for the Apple.

Silverman, Ken "Filling your Memory Cells" pg.7.

An updated listing of the various 16K dynamic RAMs now available together with speed designations, etc. Beware of units of 300 NS or even slower speed.

Nareff, Max J. "Matrix Simulation with the Apple, Part III" pgs. 8-9.

Another installment in this continuing series.

Sullivan, Charles Jr. "Meeting with Sargon" pg.9.

Chess 4 by the author and the well known Sargo II fight it out on the chess board. Apple.

- Anon. "Appiibrary" pgs. 10-11.  
The Apple Core Library now lists 274 programs in 13 different categories, for the Apple II.
- 496. Call — Apple 2 No 4 (Apr./May, 1979)**  
Smith, Ken and Scharen, Rosalie "Analysis of the Great Hello Program", pgs. 4-7.  
Analysis of the tricks in this interesting program.  
Apple.
- Golding, Val J. "Integral Data IP 225 Printer: A Review" pgs. 8-11.  
How to use this printer with the Apple. A Printer Driver routine by Darrell and Ron Aldrich is given.
- Aldrich, Ron "Ron's Page" pgs. 12-17.  
Hi-Res Screen Dump Routine, Split Catalog Routine, etc.
- Suitor, Richard F. "Apple Disk Operating System" pg.17  
A discussion including some insights into the details of the new Apple Disk DOS 3.2.
- Winston, Alan B. "The Multilingual Apple" pgs 18-19.  
Discussion of languages other than Basic for the Apple: PILOT, FORTH, FCL65E, XPLO, Pascal.
- Aldrich, Darrell "Monitor Calls, Cross References and Memory Map" pgs 20-23.  
Important calls and addresses based on the authors research.
- Aldrich, Darrell "The Apple Doctor" pgs 30-31.  
How to save a shape table along with an Applesoft Program.
- Golding, Val J. "Routine to Center Titles" pg.31.  
A simple integer Basic Utility.
- 497. MICRO No 12 (May, 1979)**  
Morganstein, David "Real-Time Games on OSI" pgs 31-33  
How real-time games can be written for Challenger systems which use a serial terminal run from the ACIA.
- 498. Rainbow 1, Issue 5 (May, 1979)**  
Memory Enterprises "Color-Killer Module" pg.6.  
An easy to install module to add the color-killer function to early model Apple IIs.
- Watson, Allen III "Another Review of the Programmer's AID #1" pgs. 7-10.  
A description of the features of this accessory ROM.
- Anon. "An Interview with Phil Roybal of Apple Corp" pgs 11-13.  
Phil Roybal, marketing manager for Apple Corp., reveals that coming soon is an "auto-start" monitor ROM that will power up the Apple directly into Basic, or upon hitting reset, also a stop list feature, easier cursor control, etc.
- 499. Calculator/Computers 3 (Jan./Feb., 1979)**  
Bobek, Frank "Vats Right" pgs 41-45.  
A program to aid physics students studying velocity and acceleration phenomena. For the PET.
- 500. Calculator/Computers 2 (Nov./Dec., 1979)**  
Oglesby, Mac "Sinners" pgs 36-38.  
Three of Satan's Fiends fight against a group of sinners. For the PET.
- 501. Dr. Dobb's Journal 4, Issue 6 (June/July, 1979)**  
Colburn, Don "EXOS-A Software Development Tool Kit for the 6500 Microprocessor Family" pgs. 29-31.  
A tool to efficiently and effectively both generate and modify 6500 assembly language programs.
- Monsour, Fred J. "Kim Renumber" pg. 47.  
A program to renumber KIM-1 Microsoft Basic listings.
- 502. Stems From Apple 2, Issue 5 (May, 1979)**  
Armstrong, Kevin "Numeric Sort Routine" pg.2.  
A sort program written in Applesoft II.
- Reed, Ron "Paddle Speed Control" pg.3.  
Control a slow list or program execution with the Apple paddles.
- Hoggatt, Ken "Ken's Korner" pgs 4-5.  
A series of tutorials for the Apple user including the use of GET A or GET \$A, the use of the mini-assembler, Yes and No statements, etc.
- 503. Recreational Computing 7, Issue 39 (May/June, 1979)**  
Feniger, Bob "A Different Way to Float" pg. 6.  
A different version of an earlier program for the PET.
- Carpenter, Chuck "PILOT for the Apple - An Extended MICRO-PILOT Interpreter" pgs 28-31.  
An interpreter in Applesoft.
- Saal, Harry "SPOT" pgs. 52-55.  
Notes for PET users include information on new models of the PET, a review of Cursor cassette magazine, new books on the PET, and a graphics program listing called CASCADES.
- 504. Creative Computing 5, No 6 (June, 1979)**  
Badgett, J. Tom "Strings and Things: Basic String Manipulations" pgs. 86-90.  
Tutorial on String variables, etc.
- North, Steve "ALF/Apple Music Synthesizer" pgs 102-103  
Review of the new Accessory for the Apple which makes possible high-quality computer music.
- Soft-One "Apple Graphics Programs" pg. 143.  
High Resolution Graphics Utility Set, including character set, lower case, shape vector table assembler, etc.
- 505. MICRO No 13 (June, 1979)**  
Putney, Charles B. "Harmonic Analysis for the Apple" pgs 5-8.  
A program in Applesoft Floating Point BASIC lets the Apple do Fourier Analysis calculations.
- Pytlík, William F. "Case of the Missing Tape Counter" pg.11.  
How to locate your files on the PET Cassette.
- Taylor, William L. "The Basic Morse Keyboard" pgs 13-15.  
A Ham program implemented on an OSI system to make an ASCII keyboard act as a "Morse Keyboard."
- Rinard, Phillip M. "A SYM-phony in Stereo" pgs 17-19  
This music program uses the 6532 and the 6522's of the SYM to generate stereo music.
- Foote, Gary A. "Sorting with the APPLE II- Part I" pgs. 21-26.  
The first installment presents some background material and compares three sorting techniques and gives a program for the SHELL-METZNER sort.
- Cass, James L. "Streamlining the C2-4P" pg.28  
Three modifications for the OSI C2-4P to raise its speed, increase cassette throughput and add reverse videc to the display.



**RUN THIS PROGRAM**  
**10 Enter data in form below**  
**20 Goto mailbox**  
**30 Mail form**  
**40 Receive the Personal**  
**Computer Catalog**  
**50 End**

**Well Done!**

Follow this simple program and you will receive The Personal Computer Catalog. The one reference book to fine quality personal computers, software, supplies and accessories.

This valuable catalog is FREE so mail your order today.

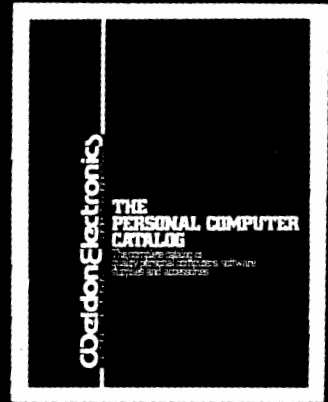

Name \_\_\_\_\_

Address \_\_\_\_\_

City \_\_\_\_\_ State \_\_\_\_\_ Zip \_\_\_\_\_

Do you own a computer? \_\_\_\_\_ What type? \_\_\_\_\_

Do you use your computer for: Business? \_\_\_\_\_

Personal? \_\_\_\_\_ Education? \_\_\_\_\_ Other? \_\_\_\_\_

Mail this form to:

**Weldon Electronics**  
 SERVING THE PERSONAL COMPUTER INDUSTRY

Or phone: (612) 884-1475

Weldon Electronics  
 4150 Hillcrest Road  
 Wayzata, MN 55391

# AIM 65 BY ROCKWELL INTERNATIONAL

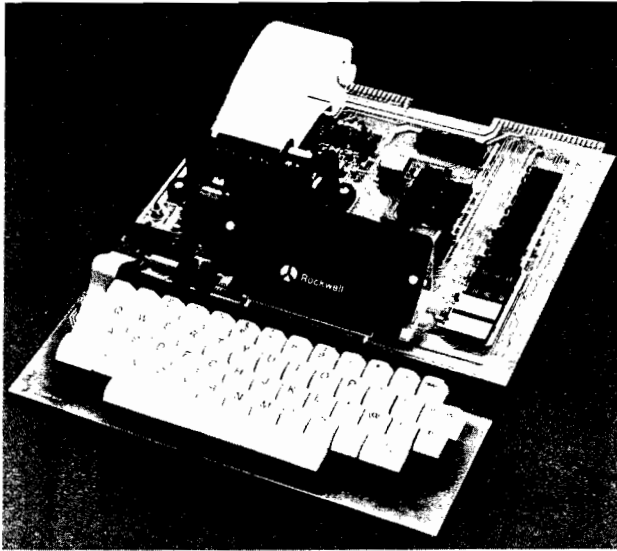

AIM 65 is fully assembled, tested and warranted. With the addition of a low cost, readily available power supply, it's ready to start working for you.

AIM 65 features on-board thermal printer and alphanumeric display, and a terminal-style keyboard. It has an addressing capability up to 65K bytes, and comes with a user-dedicated 1K or 4K RAM. Two installed 4K ROMs hold a powerful Advanced Interface Monitor program, and three spare sockets are included to expand on-board ROM or PROM up to 20K bytes.

An Application Connector provides for attaching a TTY and one or two audio cassette recorders, and gives external access to the user-dedicated general purpose I/O lines.

Also included as standard are a comprehensive AIM 65 User's Manual, a handy pocket reference card, an R6500 Hardware Manual, an R6500 Programming Manual and an AIM 65 schematic.

AIM 65 is packaged on two compact modules. The circuit module is 12 inches wide and 10 inches long, the keyboard module is 12 inches wide and 4 inches long. They are connected by a detachable cable.

## THERMAL PRINTER

Most desired feature on low-cost microcomputer systems . . .

- Wide 20-column printout
- Versatile 5 x 7 dot matrix format
- Complete 64-character ASCII alphanumeric format
- Fast 120 lines per minute
- Quite thermal operation
- Proven reliability

## FULL-SIZE ALPHANUMERIC KEYBOARD

Provides compatibility with system terminals . . .

- Standard 54 key, terminal-style layout
- 26 alphabetic characters
- 10 numeric characters
- 22 special characters
- 9 control functions
- 3 user-defined functions

## TRUE ALPHANUMERIC DISPLAY

Provides legible and lengthy display . . .

- 20 characters wide
- 16-segment characters
- High contrast monolithic characters
- Complete 64-character ASCII alphanumeric format

## PROVEN R6500 MICROCOMPUTER SYSTEM DEVICES

Reliable, high performance NMOS technology . . .

- R6502 Central Processing Unit (CPU), operating at 1 MHz. Has 65K address capability, 13 addressing modes and true index capability. Simple but powerful 56 instructions.
- Read/Write Memory, using R2114 Static RAM devices. Available in 1K byte and 4K byte versions.
- 8K Monitor Program Memory, using R2332 Static ROM devices. Has sockets to accept additional 2332 ROM or 2532 PROM devices, to expand on-board Program memory up to 20K bytes.
- R6532 RAM-Input/Output-Timer (RIOT) combination device. Multipurpose circuit for AIM 65 Monitor functions.
- Two R6522 Versatile Interface Adapter (VIA) devices, which support AIM 65 and user functions. Each VIA has two parallel and one serial 8-bit, bidirectional I/O ports, two 2-bit peripheral handshake control lines and two fully-programmable 16-bit interval timer/event counters.

## BUILT-IN EXPANSION CAPABILITY

- 44-Pin Application Connector for peripheral add-ons
- 44-Pin Expansion Connector has full system bus
- Both connectors are KIM-1 compatible

## TTY AND AUDIO CASSETTE INTERFACES

Standard interface to low-cost peripherals . . .

- 20 ma. current loop TTY interface
- Interface for two audio cassette recorders
- Two audio cassette formats: ASCII KIM-1 compatible and binary, blocked file assembler compatible

## ROM RESIDENT ADVANCED INTERACTIVE MONITOR

Advanced features found only on larger systems . . .

- Monitor-generated prompts
- Single keystroke commands
- Address independent data entry
- Debug aids
- Error messages
- Option and user interface linkage

## ADVANCED INTERACTIVE MONITOR COMMANDS

- Major Function Entry
- Instruction Entry and Disassembly
- Display/Alter Registers and Memory
- Manipulate Breakpoints
- Control Instruction/Trace
- Control Peripheral Devices
- Call User-Defined Functions
- Comprehensive Text Editor

## LOW COST PLUG-IN ROM OPTIONS

- 4K Assembler—symbolic, two-pass \$79.00
- 8K BASIC Interpreter \$99.00

## POWER SUPPLY SPECIFICATIONS

- +5 VDC  $\pm$  5% regulated @ 2.0 amps (max)
- +24 VDC  $\pm$  15% unregulated @ 2.5 amps (peak)  
0.5 amps average

**PRICE: \$369.00 (1K RAM)**

**Plus \$4.00 UPS** (shipped in U.S. must give **street** address), \$10 parcel post to APO's, FPO's, Alaska, Hawaii, Canada, \$25 air mail to all other countries

We manufacture a complete line of high quality expansion boards. Use reader service card to be added to our mailing list, or U.S. residents send \$1.00 (International send \$3.00 U.S.) for airmail delivery of our complete catalog.

 **ENTERPRISES**  
INCORPORATED

2967 W. Fairmount Avenue  
Phoenix AZ 85017  
(602)265-7564



NOW PRESENTING...

# Software for Apple II<sup>®</sup>

for your Entertainment · Business · Education

## Star Attractions:

**FILEMASTER** 2 programs: *FORMAT & RETRIEVAL* comprise a powerful data file manager. Great for everything from phone lists to legal abstracts. Needs 32K. Design your own data structure. Up to 500 characters per record. Up to 15 searchable fields in any combination. **On Disk** . . . . . \$34.95

**SPACE** Multi-faceted simulation of life in interstellar society. You and opponents must make life & death decisions. Keeps track of your progress from one game to next. Needs 48K and Applesoft ROM. **Disk** . . . . . \$29.95

**Pot O'Gold I or our All New Pot O' Gold II** A collection of 49 programs for 16K Apple. Everything from Logic to action games. Only a buck a game. Specify I or II. Price each: **Tape \$49 . . . . Disk \$54**

**ADVENTURE** Fight off pirates and vicious dwarfs. 700 travel options, 140 locations, 64 objects. Needs ROM & 48K. **Disk** . . \$29.95

**16K CASSETTE INVENTORY** Use item number, description, stock amount, reorder amount, restock date, cost & sell price. Holds up to 140 items. **Tape** . . . . . \$35

**32K DISK INVENTORY:** Use stock numbers description, vendor, record of purchase and sales date, amount on hand, cost & sell price, total value. Holds up to 300 items. **Disk** . . . . . \$40  
**With Parts Explosion: Disk** . . . . . \$50

**32K DATA BASE** Cross file for phone lists, bibliographies, recipes. Run up to 9 lines of 40 columns each. Search by item anywhere. **Disk** . . . . . \$20

**24K HI-RES LIFE SIMULATION** Conway's equations on 296x180 screen. A mathematical simulation to demo population growth with birth, death and survival as factors. **Tape** . . . . . \$10

**16K CIRCUIT LOGIC DEVELOPMENT AID** Evaluate circuits of up to 255 gates, including AND, OR, NOR, NAND, XOR, XNOR and INVERTER. **Tape** . . . . . \$10

**16K MORSE CODE TRAINER** Learn Morse Code, and transmit or receive over radio. **Tape** . . . . . \$10

**16K DEVIL'S DUNGEON:** Adventure through dark passages where monsters, demons, poisonous gas, dropoffs threaten . . . all to discover fantastic treasures. Comes with instruction book. **Tape** . . \$10

**16K PACIFICA:** Discover the floating island and rescue the beautiful princess. To win you must recover the enchanted crown, but you face the threat of magic spells and demons. **Tape** . . . . . \$9.95

Don't see what you've been looking for, here? Then write for our **FREE SOFTWARE CATALOG**. We're saving one just for you!

To order software, add \$2 shipping. To transfer tape versions to disk add \$5. California residents add 6% sales tax. Sorry, we can not ship to P. O. Boxes. VISA/MASTERCHARGE Welcomed!



**RAINBOW'S CASINO** 9 gambling games: Roulette, Blackjack, Craps, Horserace, and a few originals that Vegas hasn't heard about. Needs 16K. **Tape** . . . . . \$29.95

**16K SPACE WAR:** You in your space capsule battle against the computer's saucer . . . in hi-res graphics. **Tape** . . . . . \$12

**16K MEMORY VERIFY** Diagnostic routine to check range of memory. Indicates faulty addresses, data in memory cell, and faulty data. **Tape** . . . . . \$5

**16K APPELIDION** Music synthesis composes original Irish jigs. Enter your own music and save on tape or disk. Includes 3 Bach fugues. **Tape** . . . . . \$10

**16K APPELVISION** Demo for Hi-Res graphics and music. **Tape** . . . . . \$10

**32K COMPU-READ** 5 programs to teach you speed reading, in stages. Includes synonym and antonym identification. You control your rate of speed, or keep up with the computer's pace. **Disk** . . . . . \$24.95

**48K PERCEPTION I, II, III** random shapes and sizes must be matched. In III, you control format and display time and get weighted scores. Needs ROM. **Each Disk** . . . . . \$24.95

**32K STORY TELLER** Use your bizarre imagination and input key words for fantastic and funny tales. Never the same story twice. **Tape** . . . . . \$12.95

**32K WAR/RESCUE** Engage in 10 battles with your infantry against the Apple robots. Calculate Apple's strategy and win more battles than the computer. **Tape** . . . . . \$12.95

**24K POLAR PLOT** Plot polar equations in Hi-Res Graphics. **Tape** . . . . . \$10

**32K SHAPE SCALER** Utility to generate and animate Hi-Res graphic shapes. Simple routine provided to inspect position of shapes, and specify precise X/Y coordinates and scale. Needs ROM. **Disk** . . . . . \$13.95

**32K ZINTAR/PROPHET** Great party game. Under control of the mighty Zintar's edict you take a very special trip to the world of Krintar. Heightened visual graphics. Needs ROM. **Disk** . . . . \$16.95

**APPLE MONITOR PEELED** Everything you wanted to know about the Apple Monitor but couldn't figure out. User-written manual in plain English clears your confusion. **Only** . . . . . \$9.95



Garden Plaza Shopping Center, Dept. 11A  
9719 Reseda Blvd., Northridge, Ca 91324  
Telephone: (213) 349-5560

# APPLE II<sup>®</sup> JOYSTICK & EXPANDA-PORT

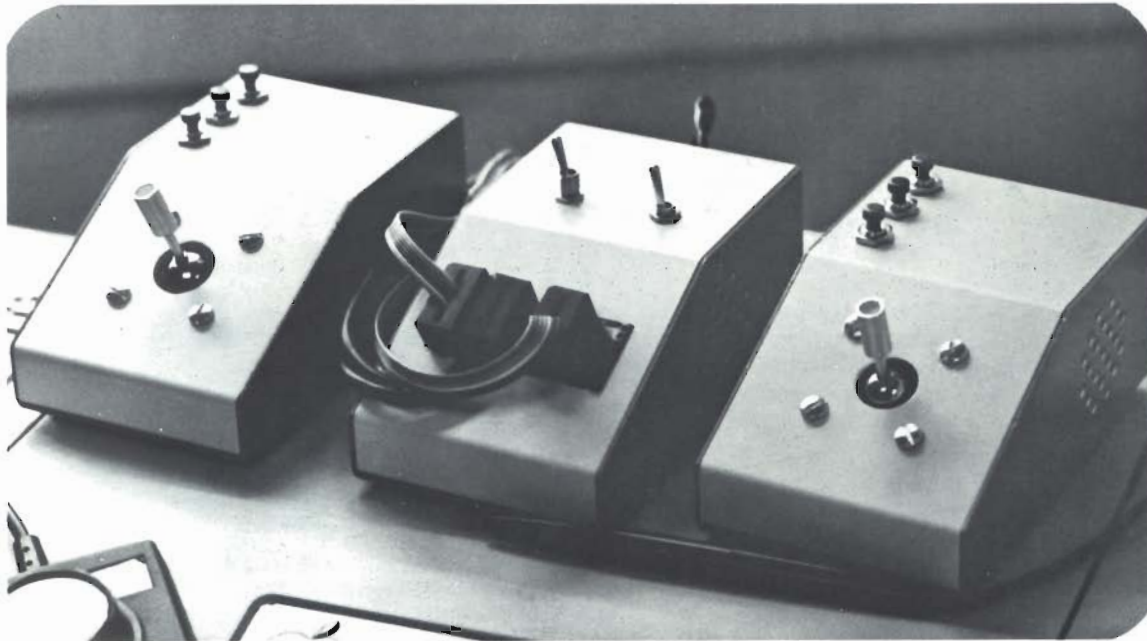

**EVERY APPLE II OWNER SHOULD HAVE ONE!**

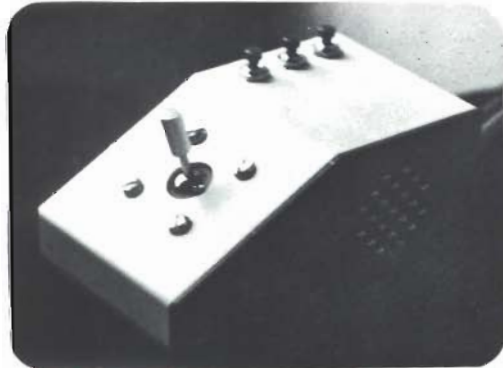

**JOYSTICK \$49.95**

The PROGRAMMA JOYSTICK is an input peripheral that attaches to the APPLE II Computer's game I/O Port. The JOYSTICK is a must for the serious game player, and it offers a degree of linearity not currently available with other joysticks. The ease of maneuverability and the availability of the "functional" switches make the PROGRAMMA JOYSTICK a much needed enhancement to any APPLE II Computer System owner. The PROGRAMMA JOYSTICK comes completely assembled and tested, including a User's Guide.

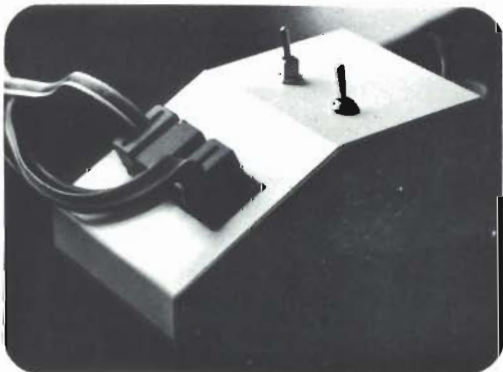

**EXPANDA-PORT \$49.95**

The PROGRAMMA EXPANDA-PORT is a multi-port expander for the game I/O port of any APPLE II Computer System. In addition to allowing expansion for up to six devices, the EXPANDA-PORT contains a built-in speaker that replaces the function of the Apple II's speaker. The switches on the EXPANDA-PORT allow for the selection of the specific device desired and for the switching of that device. No unplugging of any device connected to the EXPANDA-PORT is required. The PROGRAMMA EXPANDA PORT comes completely assembled and tested, including a User's guide.

The PROGRAMMA JOYSTICK and EXPANDA-PORT are available on a limited basis through your local computer dealer. Apple II is a registered trademark of Apple Computers, Inc.

**PROGRAMMA  
INTERNATIONAL, INC.**

3400 Wilshire Blvd.  
Los Angeles, CA 90010 (213) 384-0579 • 384-1116 • 384-1117

PROGRAMMA

Computer  
System  
Products