

# AMIGA<sup>®</sup> Hardware Reference Manual



”

---

AMIGA TECHNICAL REFERENCE SERIES

---

COMMODORE-AMIGA, INC.

---

T H I R D E D I T I O N

---



# AMIGA<sup>®</sup>

## Hardware Reference Manual

*Third Edition*

Commodore-Amiga, Inc.

**AMIGA TECHNICAL REFERENCE SERIES**



Addison-Wesley Publishing Company, Inc.

Reading, Massachusetts Menlo Park, California New York  
Don Mills, Ontario Wokingham, England Amsterdam Bonn  
Sydney Singapore Tokyo Madrid San Juan  
Paris Seoul Milan Mexico City Taipei

**Contributors:**

Joe Augenbraun, Dan Baker, Greg Berlin, Susan Deyl, Ken Farinsky, Mark Green, Larry Greenley, Dave Haynie, Lee Ho, Glenn Keller, Bill Kolb, Dale Luck, Jay Miner, Dave Needle, Bryce Nesbitt, Rob Peck, Nancy Rains, Chris Raymond, Tom Rokicki, Jez San, Carolyn Scheppner, and Bart Whitebook.

**Third edition by:**

Larry Greenley, Mark Green, and Dan Baker

**Cover designer:**

Hannus Design Associates

Copyright © 1991 by Commodore-Electronics, Ltd.

Many of the designations used by manufacturers and sellers to distinguish their products are claimed as trademarks. Where those designations appear in this book and Addison-Wesley was aware of a trademark claim, the designations have been printed in initial caps. Amiga, Amiga 500, Amiga 1000, Amiga 2000, and Amiga 3000 are registered trademarks of Commodore-Amiga, Inc. AmigaDOS, Workbench, and Kickstart are trademarks of Commodore-Amiga, Inc. AUTOCONFIG is a trademark of Commodore Electronics Limited. 68000, 68010, 68020, 68030, 68040, and Motorola are trademarks of Motorola, Inc. Commodore and the Commodore logo are registered trademarks of Commodore Electronics Limited. CAPE and Inovatronics are trademarks of Inovatronics, Inc. Centronics is a registered trademark of Centronics Data Computer Corp. HiSoft and Devpac Amiga are trademarks of HiSoft. IBM is a registered trademark of International Business Machines Corp. Macintosh is a registered trademark of Apple Computer, Inc. UNIX is a registered trademark of AT&T.

All rights reserved. No part of this publication may be reproduced, stored in a retrieval system, or transmitted, in any form or by any means, electronic, mechanical, photocopying, recording, or otherwise, without the prior written permission of the publisher. Printed in the United States of America. Published simultaneously in Canada.

Commodore item number: 327272-05

123456789-AL-9594939291

First printing, August 1991

ISBN 0-201-56776-8

**WARNING:** The information described in this manual may contain errors or bugs, and may not function as described. All information is subject to enhancement or upgrade for any reason including to fix bugs, add features, or change performance. As with all software upgrades, full compatibility, although a goal, cannot be guaranteed, and is in fact unlikely.

**DISCLAIMER:** COMMODORE-AMIGA, INC., ("COMMODORE") MAKES NO WARRANTIES, EITHER EXPRESSED OR IMPLIED, OR REPRESENTATIONS WITH RESPECT TO THE INFORMATION DESCRIBED HEREIN. SUCH INFORMATION IS PROVIDED ON AN "AS IS" BASIS AND IS EXPRESSLY SUBJECT TO CHANGE WITHOUT NOTICE. IN NO EVENT WILL COMMODORE BE LIABLE FOR ANY DIRECT, INDIRECT, INCIDENTAL, OR CONSEQUENTIAL DAMAGES RESULTING FROM ANY CLAIM ARISING OUT OF THE INFORMATION PRESENTED HEREIN, EVEN IF IT HAS BEEN ADVISED OF THE POSSIBILITY OF SUCH DAMAGES. SOME STATES DO NOT ALLOW THE EXCLUSION OR LIMITATION OF IMPLIED WARRANTIES OR LIABILITIES FOR INCIDENTAL OR CONSEQUENTIAL DAMAGES, SO THE ABOVE LIMITATION OR EXCLUSION MAY NOT APPLY.

# CONTENTS

<b>Chapter 1 INTRODUCTION .....</b>	<b>1</b>
Components of the Amiga .....	1
About the Examples .....	9
General Amiga Development Guidelines .....	11
<b>Chapter 2 COPROCESSOR HARDWARE .....</b>	<b>19</b>
About the Copper .....	19
What is a Copper Instruction? .....	20
The MOVE Instruction .....	21
The WAIT Instruction .....	22
Using the Copper Registers .....	25
Putting Together a Copper Instruction List .....	26
Starting and Stopping the Copper .....	30
Advanced Topics .....	31
Summary of Copper Instructions .....	36
<b>Chapter 3 PLAYFIELD HARDWARE .....</b>	<b>39</b>
About Amiga Playfields .....	40
Forming a Basic Playfield .....	44
Forming a Dual-playfield Display .....	67
Bitplanes and Display Windows of All Sizes .....	73
Moving (Scrolling) Playfields .....	80
Advanced Topics .....	86
Summary of Playfield Registers .....	89
Summary of Color Selection Registers .....	92
<b>Chapter 4 SPRITE HARDWARE .....</b>	<b>97</b>
What are Sprites? .....	97
Forming a Sprite .....	98
Displaying a Sprite .....	109
Moving a Sprite .....	113
Creating Additional Sprites .....	114
Reusing Sprite DMA Channels .....	116
Overlapped Sprites .....	118
Attached Sprites .....	120
Manual Mode .....	123
Sprite Hardware Details .....	124
Summary of Sprite Registers .....	127
Summary of Sprite Color Registers .....	130

<b>Chapter 5 AUDIO HARDWARE</b> .....	<b>133</b>
Introducing Sound Generation.....	134
Forming and Playing a Sound.....	137
Producing Complex Sounds.....	147
Producing High-quality Sound.....	152
Using Direct (Non-DMA) Audio Output.....	157
The Equal-tempered Musical Scale.....	158
Decibel Values for Volume Ranges.....	163
The Audio State Machine.....	164
<b>Chapter 6 BLITTER HARDWARE</b> .....	<b>169</b>
What is the Blitter?.....	169
Memory Layout.....	170
DMA Channels.....	170
Function Generator.....	174
Shifts and Masks.....	179
Descending Mode.....	182
Copying Arbitrary Regions.....	183
Area Fill Mode.....	184
Blitter Done Flag.....	186
Interrupt Flag.....	187
Zero Flag.....	187
Pipeline Register.....	188
Line Mode.....	189
Blitter Speed.....	193
Blitter Operations and System DMA.....	194
Blitter Block Diagram.....	198
Blitter Key Points.....	200
<b>Chapter 7 SYSTEM CONTROL HARDWARE</b> .....	<b>207</b>
Video Priorities.....	207
Collision Detection.....	213
Beam Position Detection.....	216
Interrupts.....	217
DMA Control.....	222
Reset and Early Startup Operation.....	223
<b>Chapter 8 INTERFACE HARDWARE</b> .....	<b>227</b>
Controller Port Interface.....	227
Floppy Disk Controller.....	241
The Keyboard.....	251
Serial I/O Interface.....	255
Parallel I/O Interface.....	259
Display Output Connections.....	260
<b>Appendix A REGISTER SUMMARY ALPHABETICAL ORDER</b> .....	<b>263</b>
<b>Appendix B REGISTER SUMMARY ADDRESS ORDER</b> .....	<b>287</b>

<b>Appendix C ENHANCED CHIP SET.....</b>	<b>295</b>
New Features of the Enhanced Chip Set.....	295
ECS Registers .....	298
<b>Appendix D SYSTEM MEMORY MAPS .....</b>	<b>313</b>
<b>Appendix E I/O CONNECTORS AND INTERFACES.....</b>	<b>317</b>
<b>Appendix F 8520 COMPLEX INTERFACE ADAPTERS.....</b>	<b>339</b>
Chip Register Map .....	340
Register Functional Description.....	341
Time of Day Clock.....	344
Serial Shift Register (SDR).....	345
Interrupt Control Register (ICR).....	346
Control Registers.....	348
Port Signal Assignments .....	350
Hardware Connection Details .....	353
<b>Appendix G KEYBOARD INTERFACE .....</b>	<b>357</b>
Keyboard Communications.....	357
Keycodes.....	358
Caps Lock Key.....	359
“Out-of-Sync” Condition .....	359
Power-Up Sequence.....	360
Reset Warning.....	361
Hard Reset.....	361
Matrix Table.....	362
Special Codes.....	364
<b>Appendix H EXTERNAL DISK CONNECTOR INTERFACE.....</b>	<b>367</b>
General.....	367
Summary Table.....	367
Signals When Driving a Disk.....	368
Device I.D. ....	370
<b>Appendix I HARDWARE EXAMPLE INCLUDE FILE.....</b>	<b>373</b>
<b>Appendix J CUSTOM CHIP PIN ALLOCATION LIST.....</b>	<b>379</b>
<b>Appendix K ZORRO EXPANSION BUS.....</b>	<b>383</b>
Zorro II Compatibility .....	387
Zorro III Bus Architecture .....	399
Signal Description.....	409
Timing.....	416
Electrical Specifications.....	424
Mechanical Specifications.....	427
AUTOCONFIG™.....	430
Physical and Logical Signal Names.....	437
Zorro III Implementations.....	439

<b>Glossary.....</b>	<b>441</b>
<b>Index.....</b>	<b>455</b>



# LIST OF FIGURES

Figure 1-1	Block Diagram for the Amiga Computer Family .....	8
Figure 2-1	Interlaced Bitplane in RAM.....	34
Figure 3-1	How the Video Display Picture Is Produced.....	40
Figure 3-2	What Is a Pixel? .....	41
Figure 3-3	How Bitplanes Select a Color .....	43
Figure 3-4	Significance of Bitplane Data in Selecting Colors.....	44
Figure 3-5	Interlacing .....	50
Figure 3-6	Effect of Interlaced Mode on Edges of Objects .....	50
Figure 3-7	Memory Organization for a Basic Bitplane .....	54
Figure 3-8	Combining Bitplanes .....	56
Figure 3-9	Positioning the On-screen Display.....	58
Figure 3-10	Data Fetched for the First Line When Modulo = 0.....	61
Figure 3-11	Data Fetched for the Second Line When Modulo = 0 .....	61
Figure 3-12	A Dual-playfield Display .....	68
Figure 3-13	How Bitplanes Are Assigned to Dual Playfields .....	69
Figure 3-14	Memory Picture Larger than the Display.....	73
Figure 3-15	Data Fetch for the First Line When Modulo = 40.....	74
Figure 3-16	Data Fetch for the Second Line When Modulo = 40 .....	74
Figure 3-17	Data Layout for First Line—Right Half of Big Picture .....	75
Figure 3-18	Data Layout for Second Line—Right Half of Big Picture .....	75
Figure 3-19	Display Window Horizontal Starting Position.....	77
Figure 3-20	Display Window Vertical Starting Position.....	77
Figure 3-21	Display Window Horizontal Stopping Position.....	78
Figure 3-22	Display Window Vertical Stopping Position .....	79
Figure 3-23	Vertical Scrolling .....	81
Figure 3-24	Horizontal Scrolling.....	83
Figure 3-25	Memory Picture Larger Than the Display Window.....	84
Figure 3-26	Data for Line 1 - Horizontal Scrolling .....	84
Figure 3-27	Data for Line 2—Horizontal Scrolling.....	84
Figure 4-1	Defining Sprite On-screen Position.....	98
Figure 4-2	Position of Sprites .....	100
Figure 4-3	Shape of Spaceship .....	101
Figure 4-4	Sprite with Spaceship Shape Defined .....	101
Figure 4-5	Sprite Color Definition.....	102
Figure 4-6	Color Register Assignments.....	103
Figure 4-7	Data Structure Layout .....	106
Figure 4-8	Sprite Priority.....	115
Figure 4-9	Typical Example of Sprite Reuse.....	116
Figure 4-10	Typical Data Structure for Sprite Re-use .....	117
Figure 4-11	Overlapping Sprites (Not Attached).....	119
Figure 4-12	Placing Sprites Next to Each Other.....	120
Figure 4-13	Sprite Control Circuitry .....	125
Figure 5-1	Sine Waveform .....	134
Figure 5-2	Digitized Amplitude Values.....	136
Figure 5-3	Example Sine Wave.....	142

Figure 5-4	Waveform with Multiple Cycles.....	153
Figure 5-5	Frequency Domain Plot of Low-Pass Filter.....	155
Figure 5-6	Noise-free Output (No Aliasing Distortion).....	155
Figure 5-7	Some Aliasing Distortion.....	156
Figure 5-8	Audio State Diagram.....	166
Figure 6-1	How Images are Stored in Memory.....	171
Figure 6-2	BLTxPTR and BLTxMOD calculations.....	173
Figure 6-3	Blitter Minterm Venn Diagram.....	178
Figure 6-4	Extracting a Range of Columns.....	181
Figure 6-5	Use of the FCI Bit - Bit Is a 0.....	185
Figure 6-6	Use of the FCI Bit - Bit Is a 1.....	185
Figure 6-7	Single-Point Vertex Example.....	186
Figure 6-8	Octants for Line Drawing.....	190
Figure 6-9	DMA Time Slot Allocation.....	195
Figure 6-10	Normal 68000 Cycle.....	196
Figure 6-11	Time Slots Used by a Six Bitplane Display.....	197
Figure 6-12	Time Slots Used by a High Resolution Display.....	197
Figure 6-13	Blitter Block Diagram.....	199
Figure 7-1	Inter-Sprite Fixed Priorities.....	208
Figure 7-2	Analogy for Video Priority.....	209
Figure 7-3	Sprite/Playfield Priority.....	212
Figure 7-4	Interrupt Priorities.....	221
Figure 8-1	Controller Plug and Computer Connector.....	228
Figure 8-2	Mouse Quadrature.....	230
Figure 8-3	Joystick to Counter Connections.....	233
Figure 8-4	Typical Paddle Wiring Diagram.....	234
Figure 8-5	Effects of Resistance on Charging Rate.....	235
Figure 8-6	Potentiometer Charging Circuit.....	237
Figure 8-7	Chinon Timing Diagram.....	242
Figure 8-8	Chinon Timing Diagram (cont.).....	243
Figure 8-9	The Amiga 1000 Keyboard, Showing Keycodes in Hexadecimal.....	254
Figure 8-10	The Amiga 500/2000/3000 Keyboard, Showing Keycodes in Hexadecimal.....	254
Figure 8-11	Starting Appearance of SERDAT and Shift Register.....	258
Figure 8-12	Ending Appearance of Shift Register.....	259
Figure E-1	Reading Fire Buttons.....	330
Figure E-2	Pot Counters.....	332
Figure E-3	Light Pen.....	333
Figure K-1	A2000 vs A3000 Bus Termination.....	386
Figure K-3	Expansion Bus Clocks.....	393
Figure K-4	Zorro II Bus Arbitration.....	394
Figure K-5	Basic Zorro III Cycles.....	400
Figure K-6	Multiple Transfer Cycles.....	403
Figure K-7	Zorro III Bus Arbitration.....	405
Figure K-8	Interrupt Vector Cycle.....	407
Figure K-9	Zorro II Within Zorro III.....	408
Figure K-10	Read Cycle Timing.....	417
Figure K-11	Write Cycle Timing.....	419
Figure K-12	Multiple Transfer Cycle Timing.....	421
Figure K-13	Quick Interrupt Cycle Timing.....	423
Figure K-14	Configuration Register Mapping.....	432

# LIST OF TABLES

Table 1-1	Summary of Amiga Memory Configurations .....	5
Table 2-1	Interrupting the 680x0.....	35
Table 2-2	Copper Instruction Summary .....	36
Table 3-1	Colors in a Single Playfield.....	45
Table 3-2	Portion of the Color Table .....	46
Table 3-3	Contents of the Color Registers .....	46
Table 3-4	Sample Color Register Contents .....	47
Table 3-5	Setting the Number of Bitplanes.....	48
Table 3-6	Lines in a Normal Playfield .....	49
Table 3-7	Playfield Memory Requirements, NTSC .....	52
Table 3-8	Playfield Memory Requirements, PAL .....	53
Table 3-9	DIWSTRT and DIWSTOP Summary.....	59
Table 3-10	Playfield 1 Color Registers — Low resolution Mode.....	70
Table 3-11	Playfield 2 Color Registers — Low resolution Mode.....	70
Table 3-12	Playfields 1 and 2 Color Registers — High resolution Mode.....	71
Table 3-13	Maximum Allowable Vertical Screen Video.....	79
Table 3-14	Maximum Allowable Horizontal Screen Video.....	80
Table 3-15	Color Register Contents .....	92
Table 3-16	Some Register Values and Resulting Colors .....	92
Table 3-17	Low resolution Color Selection .....	93
Table 3-18	High resolution Color Selection.....	94
Table 3-19	Color Selection in Hold-and-modify Mode .....	95
Table 4-1	Sprite Data Structure .....	105
Table 4-2	Sprite Color Registers .....	108
Table 4-3	Color Registers for Sprite Pairs .....	115
Table 4-4	Data Words for First Line of Spaceship Sprite .....	121
Table 4-5	Color Registers in Attached Sprites .....	122
Table 4-6	Color Registers for Single Sprites.....	130
Table 4-7	Color Registers for Attached Sprites .....	131
Table 5-1	Sample Audio Data Set for Channel 0 .....	138
Table 5-2	Volume Values.....	140
Table 5-3	DMA and Audio Channel Enable Bits.....	144
Table 5-4	Data Interpretation in Attach Mode .....	150
Table 5-5	Channel Attachment for Modulation .....	151
Table 5-6	Sampling Rate and Frequency Relationship .....	157
Table 5-7	Equal-tempered Octave for a 16 Byte Sample .....	158
Table 5-8	Five Octave Even-tempered Scale .....	160
Table 5-9	Decibel Values and Volume Ranges.....	163
Table 6-1	Table of Common Minterm Values .....	177
Table 6-2	Typical Blitter Cycle Sequence.....	188
Table 6-3	BLTCON1 Code Bits for Octant Line Drawing .....	190
Table 7-1	Bits in BPLCON2 .....	210
Table 7-2	Priority of Playfields Based on Values of Bits PF1P2-PF1P0.....	210
Table 7-3	CLXDAT Bits .....	214
Table 7-4	CLXCON Bits.....	215

Table 7-5	Contents of the Beam Position Counter.....	216
Table 7-6	Contents of DMA Control Register .....	222
Table 8-1	Typical Controller Connections .....	228
Table 8-2	Determining the Direction of the Mouse .....	231
Table 8-3	Interpreting Data from JOY0DAT and JOY1DAT.....	232
Table 8-4	POTGO (\$DFF034) and POTINP (\$DFF016) Registers.....	240
Table 8-5	Disk Subsystem.....	244
Table 8-6	DSKLEN Register (\$DFF024).....	246
Table 8-7	DSKBYTR Register.....	248
Table 8-8	ADKCON and ADKCONR Register.....	249
Table 8-9	SERDATR / ADKCON Registers .....	256
Table K-1	Memory Space Type Codes .....	414

---

# Preface

The Amiga Technical Reference Series is the official guide to programming Commodore's Amiga computers. This revised edition of the *Amiga Hardware Reference Manual* provides detailed information about the Amiga's graphics and audio hardware, and how the Amiga talks to the outside world through peripheral devices. This edition has been updated for version 2.0 of the Amiga operating system and covers the newest Amiga computer systems including the A3000.

This book is intended for the following audiences:

- Assembly language programmers who need a more direct way of interacting with the Amiga than the routines provided in the system software.
- Designers who want to interface new peripherals to the Amiga.
- Anyone who wants to know how the Amiga hardware works.

Here is a brief overview of the contents:

Chapter 1, *Introduction*. An overview of the hardware and survey of the Amiga's graphics and audio features.

Chapter 2, *Coprocessor Hardware*. Using the Copper coprocessor to control the entire graphics and audio system; directing mid-screen modifications in graphics displays and directing register changes during the time between displays.

Chapter 3, *Playfield Hardware*. Creating, displaying and scrolling the playfields, one of the basic display elements of the Amiga; how the Amiga produces multi-color, bit-mapped displays.

Chapter 4, *Sprite Hardware*. Using the eight sprite direct memory access (DMA) channels to make sprite movable objects; creating their data structures, displaying and moving them, reusing the DMA channels.

---

Chapter 5, *Audio Hardware*. Overview of sampled sound; how to produce quality sound, simple and complex sounds, and modulated sounds.

Chapter 6, *Blitter Hardware*. Using the blitter DMA channel to create animation effects and draw lines into playfields.

Chapter 7, *System Control Hardware*. Using the control registers to define depth arrangement of graphics objects, detect collisions between graphics objects, control direct memory access, and control interrupts.

Chapter 8, *Interface Hardware*. How the Amiga talks to the outside world through controller ports, keyboard, audio jacks and video connectors, serial and parallel interfaces; information about the disk controller and RAM expansion slot.

*Appendices*. Alphabetical and address-order listings of all the graphics and audio system registers and the functions of their bits. Also included is a special section on the Amiga's Enhanced Chip Set (ECS), system memory maps, descriptions of internal and external connectors, specifications for the peripheral interface ports, keyboard, and an introduction to the Amiga's Zorro expansion bus with detailed specifications for hardware add-on designers.

We suggest that you use this book according to your level of familiarity with the Amiga system. Here are some suggestions:

- If this is your initial exposure to the Amiga, read chapter 1, which gives a survey of all the hardware features and a brief rundown of graphics and audio effects created by hardware interaction.
- If you are already familiar with the system and want to acquaint yourself with how the various bits in the hardware registers govern the way the system functions, browse through chapters 2 through 8. Examples are included in these chapters.
- For advanced users, the appendices give a concise summary of the entire register set and the uses of the individual bits. Once you are familiar with the effects of changes in the various bits, you may wish to refer more often to the appendices than to the explanatory chapters.

The other manuals in this series are the *Amiga User Interface Style Guide*, an application design specification and reference work for Amiga programmers, the *Amiga ROM Kernel Reference Manual: Includes and Autodocs*, an alphabetically organized reference of ROM function summaries and Amiga system include files, the *Amiga ROM Kernel Reference Manual: Libraries* and the *Amiga ROM Kernel Reference Manual: Devices* with tutorial-style chapters on the use of each Amiga system library and device.

---

# chapter one

# INTRODUCTION

The Amiga family of computers consists of several models, each of which has been designed on the same premise — to provide the user with a low-cost computer that features high-cost performance. The Amiga does this through the use of custom silicon hardware that yields advanced graphics and sound features.

There are four basic models that make up the Amiga computer family: the A500, A1000, A2000, and A3000. Though the models differ in price and features, they have a common hardware nucleus that makes them software compatible with one another. This chapter describes the Amiga's hardware components and gives a brief overview of its graphics and sound features.

## Components of the Amiga

These are the hardware components of the Amiga:

- Motorola MC68000 16/32-bit main processor. The Amiga also supports the 68010, 68020, and 68030 processors as an option. The A1000, A500 and A2000 contain the 68000, while the A3000 utilizes the 68030 processor.
- Custom graphics and audio chips with DMA capability. All Amiga models are equipped with three custom chips named Paula, Agnus, and Denise which provide for superior color graphics, digital audio, and high-performance interrupt and I/O handling. The custom chips can access up to 2MB of memory directly without using the 68000 CPU.
- From 256K to 2 MB of RAM expandable to a total of 8 MB (over a gigabyte on the Amiga 3000).
- 512K of system ROM containing a real time, multitasking operating system with sound, graphics, and animation support routines. (V1.3 and earlier versions of the OS used 256K of system ROM.)

- 
- Built-in 3.5 inch double sided disk drive with expansion floppy disk ports for connecting up to three additional disk drives (either 3.5 inch or 5.25 inch, double sided).
  - SCSI disk port for connecting additional SCSI disk drives (A3000 Only).
  - Fully programmable parallel and RS-232-C serial ports.
  - Two button opto-mechanical mouse and two reconfigurable controller ports (for mice, joysticks, light pens, paddles, or custom controllers).
  - A professional keyboard with numeric keypad, 10 function keys, and cursor keys. A variety of international keyboards are also supported.
  - Ports for analog or digital RGB output (all models), monochrome video (A500 and A2000), composite video (A1000), and VGA-style multiscan video (A3000).
  - Ports for left and right stereo audio from four special purpose audio channels.
  - Expansion options that allow you to add RAM, additional disk drives (floppy or hard), peripherals, or coprocessors.

## THE MC68000 AND THE AMIGA CUSTOM CHIPS

The Motorola MC68000 microprocessor is the CPU used in the A1000, the A500, and the A2000. The 68000 is a 16/32-bit microprocessor; internal registers are 32 bits wide, while the data bus and ALU are 16 bits. The 68000's system clock speed is 7.15909 MHz on NTSC systems (USA) or 7.09379 MHz on PAL systems (Europe). These speeds can vary when using an external system clock, such as from a genlock board.

The 68000 has an address space of 16 megabytes. In the Amiga, the 68000 can address up to 9 megabytes of random access memory (RAM).

In the A3000, the Motorola MC68030 microprocessor is the CPU. This is a full 32-bit microprocessor with a system clock speed of 16 or 25 megahertz. The 68030 has an address space of 4 gigabytes. In the A3000, over a gigabyte of RAM can be addressed.

In addition to the 680x0, all Amiga models contain special purpose hardware known as the *custom chips* that greatly enhance system performance. The term *custom chips* refers to the three integrated circuits which were designed specifically for the Amiga computer. These three custom chips, named Paula, Agnus, and Denise, each contain the logic to handle a specific set of tasks such as video, audio, or I/O.

Because the custom chips have DMA capability, they can access memory without using the 680x0 CPU - this frees the CPU for other types of operations. The division of labor between the custom chips and the 680x0 gives the Amiga its power; on most other systems the CPU has to do everything.



---

The memory shared between the Amiga's CPU and the custom chips is called *Chip memory*. The more Chip memory the Amiga has, the more graphics, audio, and I/O data it can operate on without the CPU being involved. All Amigas can access at least 512K of Chip memory.

The latest version of the custom chips, known as the *Enhanced Chip Set* or *ECS*) can handle up to 2 MB of memory and has other advanced features. For more details about the Enhanced Chip Set, refer to Appendix C.

Although there are different versions of the Amiga's custom chips, all versions have some common features. Among other functions, the custom chips provide the following:

- Bitplane generated, high resolution graphics capable of supporting both PAL and NTSC video standards.

*NTSC systems.* On NTSC systems, the Amiga typically produces a 320 by 200 non-interlaced or 320 by 400 interlaced display in 32 colors. A high resolution mode provides a 640 by 200 non-interlaced or 640 by 400 interlaced display in 16 colors.

*PAL systems.* On PAL systems, the Amiga typically produces a 320 by 256 non-interlaced or 320 by 512 interlaced display in 32 colors. High resolution mode provides a 640 by 256 non-interlaced or 640 by 512 interlaced display in 16 colors.

The design of the Amiga's display system is very flexible and there are many other modes available. Hold-and-modify (HAM) mode allows for the display of up to 4,096 colors on screen simultaneously. Overscan mode allows the creation of higher resolution displays specially suited for video and film applications. Displays of arbitrary size, larger than the visible viewing area can be created. Amigas which contain the Enhanced Chip Set (ECS) support Productivity mode giving displays of 640 by 480, non-interlaced with 4 colors from a palette of 64.

- A custom graphics coprocessor, called *the Copper*, that allows changes to most of the special purpose registers in synchronization with the position of the video beam. This allows such special effects as mid-screen changes to the color palette, splitting the screen into multiple horizontal slices each having different video resolutions and color depths, beam-synchronized interrupt generation for the 680x0, and more. The coprocessor can trigger many times per screen, in the middle of lines, and at the beginning or during the blanking interval. The coprocessor itself can directly affect most of the registers in the other custom chips, freeing the 680x0 for general computing tasks.
- 32 system color registers, each of which contains a 12-bit number as four bits of red, four bits of green, and four bits of blue intensity information. This allows a system color palette of 4,096 different choices of color for each register.
- Eight reusable 16-bit wide sprites with up to 15 color choices per sprite pixel (when sprites are paired). A sprite is an easily movable graphics object whose display is entirely independent of the background (called a playfield); sprites can be displayed over or under this background. A sprite is 16 low resolution pixels wide and an arbitrary number of lines

---

tall. After producing the last line of a sprite on the screen, a sprite DMA channel may be used to produce yet another sprite image elsewhere on screen (with at least one horizontal line between each reuse of a sprite processor). Thus, many small sprites can be produced by simply reusing the sprite processors appropriately.

- Dynamically controllable inter-object priority, with collision detection. This means that the system can dynamically control the video priority between the sprite objects and the bitplane backgrounds (playfields). You can control which object or objects appear over or under the background at any time. Additionally, you can use system hardware to detect collisions between objects and have your program react to such collisions.
- Custom bit blitter used for high speed data movement, adaptable to bitplane animation. The blitter has been designed to efficiently retrieve data from up to three sources, combine the data in one of 256 different possible ways, and optionally store the combined data in a destination area. The bit blitter, in a special mode, draws patterned lines into rectangularly organized memory regions at a speed of about 1 million dots per second; and it can efficiently handle area fill.
- Audio consisting of four digital channels with independently programmable volume and sampling rate. The audio channels retrieve their control and sample data via DMA. Once started, each channel can automatically play a specified waveform without further processor interaction. Two channels are directed into each of the two stereo audio outputs. The audio channels may be linked together to provide amplitude or frequency modulation or both forms of modulation simultaneously.
- DMA controlled floppy disk read and write on a full track basis. This means that the built-in disk can read over 5600 bytes of data in a single disk revolution (11 sectors of 512 bytes each).

## **AMIGA MEMORY SYSTEM**

As mentioned previously, the custom chips have DMA access to RAM which allows them to perform graphics, audio, and I/O chores independently of the CPU. This shared memory that both the custom chips and the CPU can access directly is called *Chip memory*.

The custom chips and the 680x0 CPU share Chip memory on a fully interleaved basis. Since the 680x0 only needs to access the Chip memory bus during each alternate clock cycle in order to run full speed, the rest of the time the Chip memory bus is free for other activities. The custom chips use the memory bus during these free cycles, effectively allowing the CPU to run at full speed most of the time.

There are some occasions though when the custom chips steal memory cycles from the 680x0. In the higher resolution video modes, some or all of the cycles normally used for processor access are needed by the custom chips for video refresh. In that case, the Copper and the blitter in the custom chips steal time from the 680x0 for jobs they can do better than the 680x0. Thus, the system DMA channels are designed with maximum performance in mind.

---

Even when such cycle stealing occurs, it only blocks the 680x0's access to the internal, shared memory. The custom chips cannot steal cycles when the 680x0 is using ROM or external memory, also known as *Fast memory*.

The DMA capabilities of the custom chips vary depending on the version of the chips and the Amiga model. The original custom chip set found in the A1000 could access the first 512K of RAM. Most A1000s have only 512K of RAM so some of the Chip RAM is used up for operating system overhead.

A later version of the custom chips found in early A500s and A2000s replaced the original Agnus chip (8361) with a newer version called *Fat Agnus* (8370/8371). The Fat Agnus chip has DMA access to 512K of Chip memory, just like the original Agnus, but also allows an additional 512K of internal *slow memory* or *pseudo-fast memory* located at (\$00C0 0000). Since the slow memory can be used for operating system overhead, this allows all 512K of Chip memory to be used by the custom chips.

The name *slow memory* comes from the fact that bus contention with the custom chips can still occur even though only the CPU can access the memory. Since slow memory is arbitrated by the same gate that controls Chip memory, the custom chips can block processor access to slow memory in the higher resolution video modes.

The latest version of Agnus and the custom chips found in most A500s and A2000s is known as the *Enhanced Chip Set* or ECS. ECS Fat Agnus (8372A) can access up to one megabyte of Chip memory. It is pin compatible with the original Fat Agnus (8370/8371) found in earlier A500 and A2000 models. In addition, ECS Fat Agnus supports both the NTSC and PAL video standards on a single chip.

In the A3000, the Enhanced Chip Set can access up to two megabytes of Chip memory.

The amount of Chip memory is important since it determines how much graphics, audio, and disk data the custom chips can operate on without the 680x0 CPU. Table 1-1 summarizes the basic memory configurations of the Amiga.

	<b>Chip RAM</b> (base model)	<b>Maximum</b> <b>Chip RAM</b>	<b>Total RAM</b> (base model)	<b>Maximum</b> <b>Total RAM</b>
Amiga 1000	256K	512K	256K	9 MB
Amiga 500	512K	1 MB	1 MB	9 MB
Amiga 2000	512K	1 MB	1 MB	9 MB
Amiga 3000	1 MB	2 MB	2 MB	over 1 GB

Table 1-1: Summary of Amiga Memory Configurations

---

Another primary feature of the Amiga hardware is the ability to dynamically control which part of the Chip memory is used for the background display, audio, and sprites. The Amiga is not limited to a small, specific area of RAM for a frame buffer. Instead, the system allows display bitplanes, sprite processor control lists, coprocessor instruction lists, or audio channel control lists to be located anywhere within Chip memory.

This same region of memory can be accessed by the bit blitter. This means, for example, that the user can store partial images at scattered areas of Chip memory and use these images for animation effects by rapidly replacing on screen material while saving and restoring background images. In fact, the Amiga includes firmware support for display definition and control as well as support for animated objects embedded within playfields.

## **PERIPHERALS**

Floppy disk storage is provided by a built-in, 3.5 inch floppy disk drive. Disks are 80 track, double sided, and formatted as 11 sectors per track, 512 bytes per sector (over 900,000 bytes per disk). The disk controller can read and write 320/360K IBM PC™ (MS-DOS™) formatted 3.5 or 5.25 inch disks, and 640/720K IBM PC (MS-DOS) formatted 3.5 inch disks.

Up to three extra 3.5 inch or 5.25 inch disk drives can be added to the Amiga. The A2000 and A3000 also provide room to mount floppy or hard disks internally. The A3000 has a built-in hard disk drive and an on-board SCSI controller which can handle two internal drives and up to seven external SCSI devices.

The Amiga has a full complement of dedicated I/O connectors. The circuitry for some of these peripherals resides on the Paula custom chip while the Amiga's two 8520 CIA chips handle other I/O chores not specifically assigned to any of the custom chips. These include modem control, disk status sensing, disk motor and stepping control, ROM enable, parallel input/output interface, and keyboard interface.

The Amiga includes a standard RS-232-C serial port for external serial input/output devices such as a modem, MIDI interface, or printer. A programmable, Centronics-compatible parallel port supports parallel printers, audio digitizers, and other peripherals.

The Amiga also includes a two-button, opto-mechanical mouse plus a keyboard with numeric keypad, cursor controls, and 10 function keys in the base system. A variety of international keyboards are supported. Many other input options are available. Other types of controllers can be attached through the two controller ports on the base unit including joysticks, keypads, trackballs, light pens, and graphics tablets.

---

## SYSTEM EXPANDABILITY AND ADAPTABILITY

New peripheral devices may be easily added to all Amiga models. These devices are automatically recognized and used by system software through a well defined, well documented linking procedure called *AUTOCONFIG*<sup>™</sup>. *AUTOCONFIG* is short for automatic configuration and is the process which allows memory or I/O space for an expansion board to be dynamically allocated by the system at boot time. Unlike some other systems, there is no need to set DIP switches to select an address space from a fixed range reserved for expansion devices.

On the A500 and A1000 models, peripheral devices can be added using the Amiga's 86-pin expansion connector. Peripherals that can be added include hard disk controllers and drives, or additional external RAM. Extra floppy disk units may be added from a connector at the rear of the unit.

The A2000 and A3000 models provide the user with the same features as the A500 or A1000, but with the added convenience of simple and extensive expandability through the Amiga's 100-pin Zorro expansion bus.

The A2000 contains 7 internal slots and the A3000 contains 4 internal slots plus a SCSI disk controller that allow many types of expansion devices to be quickly and easily added inside the machine. Available options include RAM boards, coprocessors, hard disk controllers, video cards, and I/O ports.

The A2000 and A3000 also support the special Bridgeboard<sup>™</sup> coprocessor card. This provides a complete IBM PC<sup>™</sup> on a card and allows the Amiga to run MS-DOS<sup>™</sup> compatible software, while simultaneously running native Amiga software. In addition, both machines have expansion slots capable of supporting standard, IBM PC<sup>™</sup> style boards.

## VCR AND DIRECT CAMERA INTERFACE

In addition to the connectors for monochrome composite, and analog or digital RGB monitors, the Amiga can be expanded to include a VCR or camera interface. With a genlock board, the system is capable of synchronizing with an external video source and replacing the system background color with the external image. This allows development of fully integrated video images with computer generated graphics. Laser disk input is accepted in the same manner.

The A2000 and A3000 models also provide a special internal slot designed for video applications. This allows the Amiga to use low-cost video expansion boards such as genlocks and frame-grabbers.

## AMIGA SYSTEM BLOCK DIAGRAM

The diagram below highlights the major hardware components of the Amiga's architecture. Notice that there are two separate buses, one that only the CPU can access (Fast memory) and another one that the custom chips share with the CPU (Chip memory).

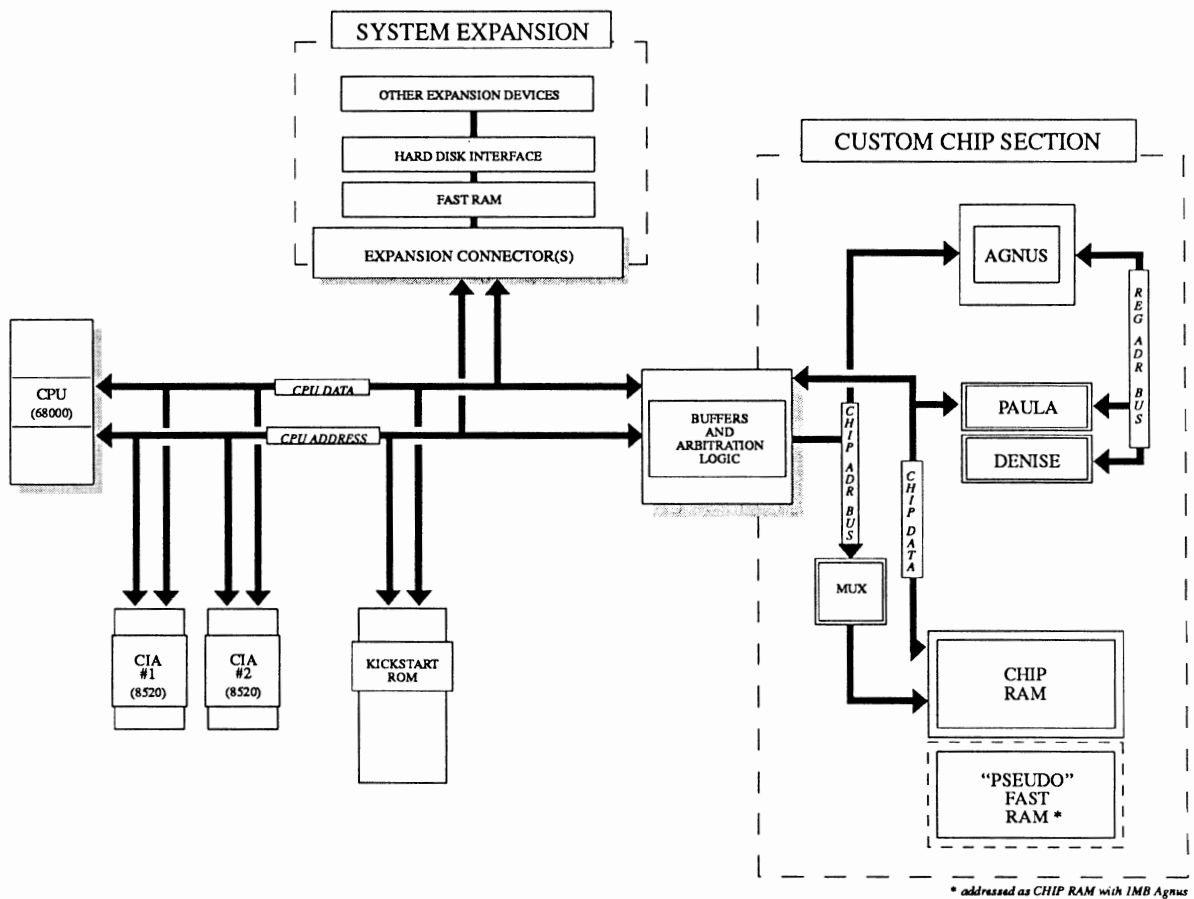

Figure 1-1: Block Diagram for the Amiga Computer Family

---

## About the Examples

The examples in this book all demonstrate direct manipulation of the Amiga hardware. However, as a general rule, it is not permissible to directly access the hardware in the Amiga unless your software either has full control of the system, or has arbitrated via the OS for exclusive access to the particular parts of the hardware you wish to control.

Almost all of the hardware discussed in this manual, most notably the Blitter, Copper, playfield, sprite, CIA, trackdisk, and system control hardware, are in either exclusive or arbitrated use by portions of the Amiga OS in any running Amiga system. Additional hardware, such as the audio, parallel, and serial hardware, may be in use by applications which have allocated their use through the system software.

Before attempting to directly manipulate any part of the hardware in the Amiga's multitasking environment, your application must first be granted exclusive access to that hardware by the operating system library, device, or resource which arbitrates its ownership. The operating system functions for requesting and receiving control of parts of the Amiga hardware are varied and are not within the scope of this manual. Generally such functions, when available, will be found in the library, device, or resource which manages that portion of the Amiga hardware in the multitasking environment. The following list will help you to find the appropriate operating system functions or mechanisms which may exist for arbitrated access to the hardware discussed in this manual.

Hardware component	Amiga system module that controls it
Copper, Playfield, Sprite, Blitter	graphics.library
Audio	audio.device
Trackdisk	trackdisk.device, disk.resource
Serial	serial.device, misc.resource
Parallel	parallel.device, cia.resource, misc.resource
Gameport	input.device, gameport.device, potgo.resource
Keyboard	input.device, keyboard.device
System Control	graphics.library, exec.library (interrupts)

Most of the examples in this book use the *hw\_examples.i* file (see Appendix I) to define the chip register names. *Hw\_examples.i* uses the system include file *hardware/custom.i* to define the chip structures and relative addresses. The values defined in *hardware/custom.i* and *hw\_examples.i* are offsets from the base of the chip register address space. In general, this base value is defined as `_custom` and is resolved during linking with the linker library `amiga.lib`. (`_ciaa` and `_ciab` are also resolved in this way.)

Normally, the base address is loaded into an address register and the offsets given by *hardware/custom.i* and *hw\_examples.i* are then used to access the correct register. (One exception to this rule is the Copper which uses only the offset access the registers.)

For example, in assembler:

```
        INCLUDE "exec/types.i"
        INCLUDE "hardware/custom.i"

        XREF      _custom          ; External reference...

Start:  lea      _custom,a0        ; Use a0 as base register and
        move.w   #$7FFF,intena(a0); use the name intena as an offset
                                           ; to disable all interrupts
```

In C, you would use the structure definitions in hardware/custom.h For example:

```
#include      "exec/types.h"
#include      "hardware/custom.h"

extern struct Custom custom;

/* You may need to define the above external as
** extern struct Custom far custom;
** Check you compiler manual.
*/

main()
{
    custom.intena = 0x7FFF;          /* Disable all interrupts */
}
```

The Amiga hardware include files are generally supplied with your compiler or assembler. Listings of the hardware include files may also be found in the *Amiga ROM Kernel Manual: Includes and Autodocs*. Generally, the include file label names are very similar to the equivalent hardware register list names with the following typical differences.

- Address registers which have low word and high word components are generally listed as two word sized registers in the hardware register list, with each register name containing either a suffix or embedded “L” or “H” for low and high. The include file label for the same register will generally treat the whole register as a longword (32 bit) register, and therefore will not contain the “L” or “H” distinction.
- Related sequential registers which are given individual names with number suffixes in the hardware register list, are generally referenced from a single base register definition in the include files. For example, the color registers in the hardware list (COLOR00, COLOR01, etc.) would be referenced from the “color” label defined in *hardware/custom.i* (color+0, color+2, etc.).
- Examples of how to define the correct register offset can be found in the *hw\_examples.i* file listed in Appendix I.

Except as noted, 68000 assembly language examples have been assembled under the Innovatronics CAPE assembler V2.x, the HiSoft Devpac assembler V1.2, and the Lake Forest Logic ADAPT assembler 1.0. No substantial changes should be required to switch between assemblers.



---

## General Amiga Development Guidelines

The Amiga is available in a variety of models and configurations, and is further diversified by a wealth of add-on expansion peripherals and processor replacements. In addition, even standard Amiga hardware such as the keyboard and floppy disks, are supplied by a number of different manufacturers and may vary subtly in both their timing and in their ability to perform outside of their specified capabilities.

The Amiga operating system is designed to operate the Amiga hardware within spec, adapt to different hardware and RAM configurations, and generally provide upward compatibility with any future hardware upgrades or “add ons” envisioned by the designers. For maximum upward compatibility, it is strongly suggested that programmers deal with the hardware through the commands and functions provided by the Amiga operating system.

If you find it necessary to program the hardware directly, then it is your responsibility to write code which will work properly on various models and configurations. Be sure to properly request and gain control of the hardware you are manipulating, and be especially careful in the following areas:

The environment of the Amiga computer is quite different than that of many other systems. The Amiga is a multitasking platform, which means multiple programs can run on a single machine simultaneously. However, for multitasking to work correctly, care must be taken to ensure that programs do not interfere with one another. It also means that certain guidelines must be followed during programming.

- Remember that memory, peripheral configurations, and ROMs differ between models and between individual systems. Do not make assumptions about memory address ranges, storage device names, or the locations of system structures or code. Never call ROM routines directly. Beware of any example code you find that calls routines at addresses in the \$F0 0000 - \$FF FFFF range. These are ROM routines and they will move with every OS release. The only supported interface to system ROM code is through the library, device, and resource calls.
- Never assume library bases or structures will exist at any particular memory location. The only absolute address in the system is \$0000 0004, which contains a pointer to the exec.library base. Do not modify or depend on the format of private system structures. This includes the poking of copper lists, memory lists, and library bases.
- Never assume that programs can access hardware resources directly. Most hardware is controlled by system software that will not respond well to interference from other programs. Shared hardware requires programs to use the proper sharing protocols. Use the defined interface; it is the best way to ensure that your software will continue to operate on future models of the Amiga.

- 
- Never access shared data structures directly without the proper mutual exclusion (locking). Remember that other tasks may be accessing the same structures.
  - All data for the custom chips must reside in Chip memory (type MEMF\_CHIP). This includes bitplanes, sound samples, trackdisk buffers, and images for sprites, bobs, pointers, and gadgets. The AllocMem() call takes a flag for specifying the type of memory. A program that specifies the wrong type of memory may appear to run correctly because many Amigas have only Chip memory. (On all models of the Amiga, the first 512K of memory is Chip memory and in some later models, Chip memory may occupy the first one or two megabytes).

However, once expansion memory has been added to an Amiga (type MEMF\_FAST), any memory allocations will be made in the expansion memory area by default. Hence, a program can run correctly on an unexpanded Amiga which has only Chip memory while crashing on an Amiga which has expanded memory. A developer with only Chip memory may fail to notice that memory was incorrectly specified.

Most compilers have options to mark specific data structures or object modules so that they will load into Chip RAM. Some older compilers provide the Atom utility for marking object modules. If this method is unacceptable, use the AllocMem() call to dynamically allocate Chip memory, and copy your data there.

When making allocations that do not require Chip memory, do not explicitly ask for Fast memory. Instead ask for memory type MEMF\_PUBLIC or 0L as appropriate. If Fast memory is available, you will get it.

- Never use software delay loops! Under the multitasking operating system, the time spent in a loop can be better used by other tasks. Even ignoring the effect it has on multitasking, timing loops are inaccurate and will wait different amounts of time depending on the specific model of Amiga computer. The timer.device provides precision timing for use under the multitasking system and it works the same on all models of the Amiga. The AmigaDOS Delay() function or the graphics.library/WaitTOF() function provide a simple interface for longer delays. The 8520 I/O chips provide timers for developers who are bypassing the operating system (see the Amiga Hardware Reference Manual for more information).

## **FOR 68010/68020/68030/68040 COMPATIBILITY**

Special care must be taken to be compatible with the entire family of 68000 processors:

- Do not use the upper 8 bits of a pointer for storing unrelated information. The 68020, 68030, and 68040 use all 32 bits for addressing.
- Do not use signed variables or signed math for addresses.

- Do not use software delay loops, and do not make assumptions about the order in which asynchronous tasks will finish.
- The stack frame used for exceptions is different on each member of the 68000 family. The type identification in the frame must be checked! In addition, the interrupt autovectors may reside in a different location on processors with a VBR register.
- Do not use the MOVE SR,<dest> instruction! This 68000 instruction acts differently on other members of the 68000 family. If you want to get a copy of the processor condition codes, use the exec.library/GetCC() function.
- Do not use the CLR instruction on a hardware register which is triggered by Write access. The 68020 CLR instruction does a single Write access. The 68000 CLR instruction does a Read access first, then a Write access. This can cause a hardware register to be triggered twice. Use MOVE.x #0, <address> instead.
- Self-modifying code is strongly discouraged. All 68000 family processors have a pre-fetch feature. This means the CPU loads instructions ahead of the current program counter. Hence, if your code modifies or decrypts itself just ahead of the program counter, the pre-fetched instructions may not match the modified instructions. The more advanced processors prefetch more words. If self-modifying code must be used, flushing the cache is the safest way to prevent troubles.
- The 68020, 68030, and 68040 processors all have instruction caches. These caches store recently used instructions, but do not monitor writes. After modifying or directly loading instructions, the cache must be flushed. See the exec.library/CacheClearU() Autodoc for more details. If your code takes over the machine, flushing the cache will be trickier. You can account for the current processors, and hope the same techniques will work in the future:

```

CACRF_ClearI    EQU        $0008    ;Bit for clear instruction cache
                ;
                ;Supervisor mode only.Use only if you have taken
                ;over the machine. Read and store the ExecBase
                ;processor AttnFlags flags at boot time, call this
                ;code only if the "68020 or better" bit was set.
                ;
ClearICache:    dc.w        $4E7A,$0002    ;MOVEC CACR,D0
                tst.w        d0            ;movec does not affect CC's
                bmi.s        cic_040      ;A 68040 with enabled cache!
                ori.w        #CACRF_ClearI,d0
                dc.w        $4E7B,$0002    ;MOVEC D0,CACR
                bra.s        cic_exit
cic_040:        dc.w        $f4b8         ;CPUSHA (IC)
cic_exit:

```

---

## HARDWARE PROGRAMMING GUIDELINES

If you find it necessary to program the hardware directly, then it is your responsibility to write code that will work correctly on the various models and configurations of the Amiga. Be sure to properly request and gain control of the hardware resources you are manipulating, and be especially careful in the following areas:

- Kickstart 2.0 uses the 8520 Complex Interface Adaptor (CIA) chips differently than 1.3 did. To ensure compatibility, you must always ask for CIA access using the `cia.resource/AddICRVector()` and `RemICRVector()` functions. Do not make assumptions about what the system might be using the CIA chips for. If you write directly to the CIA chip registers, do not expect system services such as the `trackdisk.device` to function. If you are leaving the system up, do not read or write to the CIA Interrupt Control Registers directly; use the `cia.resource/AbleICR()`, and `SetICR()` functions. Even if you are taking over the machine, do not assume the initial contents of any of the CIA registers or the state of any enabled interrupts.
- All custom chip registers are Read-only or Write-only. Do not read Write-only registers, and do not write to Read-only registers.
- Never write data to, or interpret data from the unused bits or addresses in the custom chip space. To be software-compatible with future chip revisions, all undefined bits must be set to zeros on writes, and must be masked out on reads before interpreting the contents of the register.
- Never write past the current end of custom chip space. Custom chips may be extended or enhanced to provide additional registers, or to use bits that are currently undefined in existing registers.
- Never read, write, or use any currently undefined address ranges or registers. The current and future usage of such areas is reserved by Commodore and is subject to change.
- Never assume that a hardware register will be initialized to any particular value. Different versions of the OS may leave registers set to different values. Check the Amiga Hardware Reference Manual to ensure that you are setting up all the registers that affect your code.

---

## ADDITIONAL ASSEMBLER DEVELOPMENT GUIDELINES

If you are writing in assembly language there are some extra rules to keep in mind in addition to those listed above.

- Never use the TAS instruction on the Amiga. System DMA can conflict with this instruction's special indivisible read-modify-write cycle.
- System functions must be called with register A6 containing the library or device base. Libraries and devices assume A6 is valid at the time of any function call. Even if a particular function does not currently require its base register, you must provide it for compatibility with future system software releases.
- Except as noted, system library functions use registers D0, D1, A0, and A1 as scratch registers and you must consider their former contents to be lost after a system library call. The contents of all other registers will be preserved. System functions that provide a result will return the result in D0.
- Never depend on processor condition codes after a system call. The caller must test the returned value before acting on a condition code. This is usually done with a TST or MOVE instruction.
- If you are programming at the hardware level, you must follow hardware interfacing specifications. All hardware is *not* the same. Do not assume that low level hacks for speed or copy protection will work on all drives, or all keyboards, or all systems, or future systems. Test your software on many different systems, with different processors, OS, hardware, and RAM configurations.

---

## Commodore Applications and Technical Support (CATS)

Commodore maintains a technical support group dedicated to helping developers achieve their goals with the Amiga. Currently, technical support programs are available to meet the needs of both smaller, independent software developers and larger corporations. Subscriptions to Commodore's technical support publication, Amiga Mail, is available to anyone with an interest in the latest news, Commodore software and hardware changes, and tips for developers.

To request an application for Commodore's developer support program, or a list of CATS technical publications send a self-addressed, stamped, 9" x 12" envelope to:

CATS-Information  
1200 West Wilson Drive  
West Chester, PA 19380-4231

## Error Reports

In a complex technical manual, errors are often found after publication. When errors in this manual are found, they will be corrected in a subsequent printing. Updates will be published in Amiga Mail, Commodore's technical support publication.

Bug reports can be sent to Commodore electronically or by mail. Submitted reports must be clear, complete, and concise. Reports must include a telephone number and enough information so that the bug can be quickly verified from your report (i.e., please describe the bug and the steps that produced it).

Amiga Software Engineering Group  
ATTN: BUG REPORTS  
Commodore Business Machines  
1200 Wilson Drive  
West Chester, PA 19380-4231  
USA

BIX: amiga.com/bug.reports (Commercial developers)  
amiga.cert/bug.reports (Certified developers)  
amiga.dev/bugs (Others)

USENET: bugs@commodore.COM or uunet!cbmvax!bugs







---

## chapter two

# COPROCESSOR HARDWARE

In this chapter, you will learn how to use the Amiga's graphics coprocessor (or Copper) and its simple instruction set to organize mid-screen register value modifications and pointer register set-up during the vertical blanking interval. The chapter shows how to organize Copper instructions into Copper lists, how to use Copper lists in interlaced mode, and how to use the Copper with the blitter. The Copper is discussed in this chapter in a general fashion. The chapters that deal with playfields, sprites, audio, and the blitter contain more specific suggestions for using the Copper.

### About the Copper

The Copper is a general purpose coprocessor that resides in one of the Amiga's custom chips. It retrieves its instructions via direct memory access (DMA). The Copper can control nearly the entire graphics system, freeing the 680x0 to execute program logic; it can also directly affect the contents of most of the chip control registers. It is a very powerful tool for directing mid-screen modifications in graphics displays and for directing the register changes that must occur during the vertical blanking periods. Among other things, it can control register updates, reposition sprites, change the color palette, update the audio channels, and control the blitter.

One of the features of the Copper is its ability to WAIT for a specific video beam position, then MOVE data into a system register. During the WAIT period, the Copper examines the contents of the video beam position counter directly. This means that while the Copper is waiting for the beam to reach a specific position, it does not use the memory bus at all. Therefore, the bus is freed for use by the other DMA channels or by the 680x0.

When the WAIT condition has been satisfied, the Copper steals memory cycles from either the blitter or the 680x0 to move the specified data into the selected special-purpose register.

---

The Copper is a two-cycle processor that requests the bus only during odd-numbered memory cycles. This prevents collision with audio, disk, refresh, sprites, and most low resolution display DMA access, all of which use only the even-numbered memory cycles. The Copper, therefore, needs priority over only the 680x0 and the blitter (the DMA channel that handles animation, line drawing, and polygon filling).

As with all the other DMA channels in the Amiga system, the Copper can retrieve its instructions only from the chip RAM area of system memory.

## What is a Copper Instruction?

As a coprocessor, the Copper adds its own instruction set to the instructions already provided by the 680x0 CPU. The Copper has only three instructions, but you can do a lot with them:

- WAIT for a specific screen position specified as x and y coordinates.
- MOVE an immediate data value into one of the special-purpose registers.
- SKIP the next instruction if the video beam has already reached a specified screen position.

All Copper instructions consist of two 16-bit words in sequential memory locations. Each time the Copper fetches an instruction, it fetches both words.

The MOVE and SKIP instructions require two memory cycles and two instruction words each. Because only the odd memory cycles are requested by the Copper, four memory cycle times are required per instruction. The WAIT instruction requires three memory cycles and six memory cycle times; it takes one extra memory cycle to wake up.

Although the Copper can directly affect only machine registers, it can also affect memory indirectly by setting up a blitter operation. More information about how to use the Copper in controlling the blitter can be found in the sections called “Control Register” and “Using the Copper with the Blitter.”

The WAIT and MOVE instructions are described below. The SKIP instruction is described in the “Advanced Topics” section.

---

## The MOVE Instruction

The MOVE instruction transfers data from RAM to a register destination. The transferred data is contained in the second word of the MOVE instruction; the first word contains the address of the destination register. This procedure is shown in detail in the section called "Summary of Copper Instructions."

### FIRST MOVE INSTRUCTION WORD (IR1)

- Bit 0            Always set to 0.
- Bits 8 - 1      Register destination address (DA8-1).
- Bits 15 - 9    Not used, but should be set to 0.

### SECOND MOVE INSTRUCTION WORD (IR2)

- Bits 15 - 0    16 bits of data to be transferred (moved) to the register destination.

The Copper can store data into the following registers:

- Any register whose address is \$20 or above.<sup>1</sup>
- Any register whose address is between \$10 and \$20 if the Copper danger bit is a 1. The Copper danger bit is in the Copper's control register, COPCON, which is described in the "Control Register" section.
- The Copper cannot write into any register whose address is lower than \$10.

Appendix B contains all of the machine register addresses.

The following example MOVE instructions set bitplane pointer 1 to \$21000 and bitplane pointer 2 to \$25000.<sup>2</sup>

```
DC.W    $00E0,$0002    ;Move $0002 to register $0E0 (BPL1PTH)
DC.W    $00E2,$1000    ;Move $1000 to register $0E2 (BPL1PTL)
DC.W    $00E4,$0002    ;Move $0002 to register $0E4 (BPL2PTH)
DC.W    $00E6,$5000    ;Move $5000 to register $0E6 (BPL2PTL)
```

---

<sup>1</sup> Hexadecimal numbers are distinguished from decimal numbers by the \$ prefix.

<sup>2</sup> All sample code segments are in assembly language.

---

Normally, the appropriate assembler “.i” files are included so that names, rather than addresses, may be used for referencing hardware registers. It is strongly recommended that you reference all hardware addresses via their defined names in the system include files. This will allow you to more easily adapt your software to take advantage of future hardware or enhancements. For example:

```
INCLUDE "hardware/custom.i"

DC.W    bplpt+$00,$0002 ;Move $0002 into register $0E0 (BPL1PTH)
DC.W    bplpt+$02,$1000 ;Move $1000 into register $0E2 (BPL1PTL)
DC.W    bplpt+$04,$0002 ;Move $0002 into register $0E4 (BPL2PTH)
DC.W    bplpt+$06,$5000 ;Move $5000 into register $0E6 (BPL2PTL)
```

For use in the hardware manual examples, we have made a special include file (see Appendix I) that defines all of the hardware register names based off of the “hardware/custom.i” file. This was done to make the examples easier to read from a hardware point of view. Most of the examples in this manual are here to help explain the hardware and are, in most cases, not useful without modification and a good deal of additional code.

## The WAIT Instruction

The WAIT instruction causes the Copper to wait until the video beam counters are equal to (or greater than) the coordinates specified in the instruction. While waiting, the Copper is off the bus and not using memory cycles.

The first instruction word contains the vertical and horizontal coordinates of the beam position. The second word contains enable bits that are used to form a “mask” that tells the system which bits of the beam position to use in making the comparison.

### FIRST WAIT INSTRUCTION WORD (IR1)

- Bit 0            Always set to 1.
- Bits 15 - 8     Vertical beam position (called VP).
- Bits 7 - 1      Horizontal beam position (called HP).

### SECOND WAIT INSTRUCTION WORD (IR2)

- Bit 0            Always set to 0.
- Bit 15           The blitter-finished-disable bit. Normally, this bit is a 1.  
(See the “Advanced Topics” section below.)
- Bits 14 - 8     Vertical position compare enable bits (called VE).
- Bits 7 - 1      Horizontal position compare enable bits (called HE).

---

The following example WAIT instruction waits for scan line 150 (\$96) with the horizontal position masked off.

```
DC.W    $9601,$FF00    ;Wait for line 150,  
                ; ignore horizontal counters.
```

The following example WAIT instruction waits for scan line 255 and horizontal position 254. This event will never occur, so the Copper stops until the next vertical blanking interval begins.

```
DC.W    $FFFF,$FFFE    ;Wait for line 255,  
                ; H = 254 (ends Copper list).
```

To understand why position VP=\$FF HP=\$FE will never occur, you must look at the comparison operation of the Copper and the size restrictions of the position information. Line number 255 is a valid line to wait for, in fact it is the maximum value that will fit into this field. Since 255 is the maximum number, the next line will wrap to zero (line 256 will appear as a zero in the comparison.) The line number will never be greater than \$FF. The horizontal position has a maximum value of \$E2. This means that the largest number that will ever appear in the comparison is \$FFE2. When waiting for \$FFFE, the line \$FF will be reached, but the horizontal position \$FE will never happen. Thus, the position will never reach \$FFFE.

You may be tempted to wait for horizontal position \$FE (since it will never happen), and put a smaller number into the vertical position field. This will not lead to the desired result. The comparison operation is waiting for the beam position to become greater than or equal to the entered position. If the vertical position is not \$FF, then as soon as the line number becomes higher than the entered number, the comparison will evaluate to true and the wait will end.

The following notes on horizontal and vertical beam position apply to both the WAIT instruction and to the SKIP instruction. The SKIP instruction is described below in the "Advanced Topics" section.

## HORIZONTAL BEAM POSITION

The horizontal beam position has a value of \$0 to \$E2. The least significant bit is not used in the comparison, so there are 113 positions available for Copper operations. This corresponds to 4 pixels in low resolution and 8 pixels in high resolution. Horizontal blanking falls in the range of \$0F to \$35. The standard screen (320 pixels wide) has an unused horizontal portion of \$04 to \$47 (during which only the background color is displayed).

All lines are not the same length in NTSC. Every other line is a long line (228 color clocks, 0-\$E3), with the others being 227 color clocks long. In PAL, they are all 227 long. The display sees all these lines as 227 1/2 color clocks long, while the copper sees alternating long and short lines.

---

## VERTICAL BEAM POSITION

The vertical beam position can be resolved to one line, with a maximum value of 255. There are actually 262 NTSC (312 PAL) possible vertical positions. Some minor complications can occur if you want something to happen within these last six or seven scan lines. Because there are only eight bits of resolution for vertical beam position (allowing 256 different positions), one of the simplest ways to handle this is shown below.

Copper Instruction	Explanation
WAIT for position (0,255)	<i>At this point, the vertical counter appears to wrap to 0 because the comparison works on the least significant bits of the vertical count.</i>
WAIT for any horizontal position with vertical position 0 through 5, covering the last 6 lines of the scan before vertical blanking occurs.	<i>Thus the total of <math>256 + 6 = 262</math> lines of video beam travel during which Copper instructions can be executed.</i>

*Note that the vertical is like the horizontal.* There are alternating long and short lines, there are also long and short fields (interlace only). In NTSC, the fields are 262, then 263 lines and in PAL, 312, then 313 lines. This alternation of lines and fields produces the standard NTSC 4 field repeating pattern:

short field ending on short line  
long field ending on long line  
short field ending on long line  
long field ending on short line  
and back to the beginning...

One horizontal count takes one cycle of the system clock (processor is twice this).

NTSC- 3,579,545 Hz

PAL - 3,546,895 Hz

genlocked- basic clock frequency plus or minus about 2%

## THE COMPARISON ENABLE BITS

Bits 14-1 are normally set to all 1s. The use of the comparison enable bits is described later in the "Advanced Topics" section.

---

## Using the Copper Registers

There are several machine registers and strobe addresses dedicated to the Copper:

- Location registers
- Jump address strobes
- Control register

### LOCATION REGISTERS

The Copper has two sets of location registers:

COP1LCH	High 3 bits of first Copper list address.
COP1LCL	Low 16 bits of first Copper list address.
COP2LCH	High 3 bits of second Copper list address.
COP2LCL	Low 16 bits of second Copper list address.

In accessing the hardware directly, you often have to write to a pair of registers that contains the address of some data. The register with the lower address always has a name ending in ‘‘H’’ and contains the most significant data, or high 3 bits of the address. The register with the higher address has a name ending in ‘‘L’’ and contains the least significant data, or low 15 bits of the address. Therefore, you write the 18-bit address by moving one long word to the register whose name ends in ‘‘H.’’ This is because when you write long words with the 680x0, the most significant word goes in the lower addressed word.

In the case of the Copper location registers, you write the address to COP1LCH. In the following text, for simplicity, these addresses are referred to as COP1LC or COP2LC.

The Copper location registers contain the two indirect jump addresses used by the Copper. The Copper fetches its instructions by using its program counter and increments the program counter after each fetch. When a jump address strobe is written, the corresponding location register is loaded into the Copper program counter. This causes the Copper to jump to a new location, from which its next instruction will be fetched. Instruction fetch continues sequentially until the Copper is interrupted by another jump address strobe.

*About Copper restart.* At the start of each vertical blanking interval, COP1LC is automatically used to start the program counter. That is, no matter what the Copper is doing, when the end of vertical blanking occurs, the Copper is automatically forced to restart its operations at the address contained in COP1LC.

---

## JUMP STROBE ADDRESS

When you write to a Copper strobe address, the Copper reloads its program counter from the corresponding location register. The Copper can write its own location registers and strobe addresses to perform programmed jumps. For instance, you might MOVE an indirect address into the COP2LC location register. Then, any MOVE instruction that addresses COPJMP2 strobates this indirect address into the program counter.

There are two jump strobe addresses:

- COPJMP1    Restart Copper from address contained in COP1LC.
- COPJMP2    Restart Copper from address contained in COP2LC.

## CONTROL REGISTER

The Copper can access some special-purpose registers all of the time, some registers only when a special control bit is set to a 1, and some registers not at all. The registers that the Copper can always affect are numbered \$80 through \$FF inclusive. (See Appendix B for a list of registers in address order.) Those it cannot affect at all are numbered \$00 to \$3E inclusive. The Copper control register is within this group (\$00 to \$3E). The rest of the registers, from \$40 to \$7E, are protected by a bit in the Copper control register.

In the Copper control register, called COPCON, only bit 1 is currently in use by the system. This bit, called CDANG (for Copper Danger Bit) protects all registers numbered between \$40 and \$7E inclusive. This range includes the blitter control registers. When CDANG is 0, these registers cannot be written by the Copper. When CDANG is 1, these registers can be written by the Copper. Preventing the Copper from accessing the blitter control registers prevents a runaway Copper (caused by a poorly formed instruction list) from accidentally affecting system memory.

*Warning:* Keep in mind that the CDANG bit is cleared after a reset.

## Putting Together a Copper Instruction List

The Copper instruction list contains all the register resetting done during the vertical blanking interval and the register modifications necessary for making mid-screen alterations. As you are planning what will happen during each display field, you may find it easier to think of each aspect of the display as a separate subsystem, such as playfields, sprites, audio, interrupts, and so on. Then you can build a separate list of things that must be done for each subsystem individually at each video beam position.

When you have created all these intermediate lists of things to be done, you must merge them together into a single instruction list to be executed by the Copper once for each display frame. The alternative is to create this all-inclusive list directly, without the intermediate steps.



---

For example, the bitplane pointers used in playfield displays and the sprite pointers must be rewritten during the vertical blanking interval so the data will be properly retrieved when the screen display starts again. This can be done with a Copper instruction list that does the following:

```
WAIT until first line of the display
MOVE data to bitplane pointer 1
MOVE data to bitplane pointer 2
MOVE data to sprite pointer 1, and so on.
```

As another example, the sprite DMA channels that create movable objects can be reused multiple times during the same display field. You can change the size and shape of the reuses of a sprite; however, every multiple reuse normally uses the same set of colors during a full display frame. You can change sprite colors mid-screen with a Copper instruction list that waits until the last line of the first use of the sprite processor and changes the colors before the first line of the next use of the same sprite processor:

```
WAIT for first line of display
MOVE firstcolor1 to COLOR17
MOVE firstcolor2 to COLOR18
MOVE firstcolor3 to COLOR19
WAIT for last line +1 of sprite's first use
MOVE secondcolor1 to COLOR17
MOVE secondcolor2 to COLOR18
MOVE secondcolor3 to COLOR19, and so on.
```

As you create Copper instruction lists, note that the final list must be in the same order as that in which the video beam creates the display. The video beam traverses the screen from position (0,0) in the upper left hand corner of the screen to the end of the display (226,262) NTSC (or (226,312) PAL) in the lower right hand corner. The first 0 in (0,0) represents the x position. The second 0 represents the y position. For example, an instruction that does something at position (0,100) should come after an instruction that affects the display at position (0,60).

Note that given the form of the WAIT instruction, you can sometimes get away with not sorting the list in strict video beam order. The WAIT instruction causes the Copper to wait until the value in the beam counter is equal to *or greater than* the value in the instruction.

This means, for example, if you have instructions following each other like this:

```
WAIT for position (64,64)
MOVE data

WAIT for position (60,60)
MOVE data
```

---

then the Copper will perform *both* moves, even though the instructions are out of sequence. The “greater than” specification prevents the Copper from locking up if the beam has already passed the specified position. A side effect is that the second MOVE below will be performed:

WAIT for position (60,60)  
MOVE data

WAIT for position (60,60)  
MOVE data

At the time of the second WAIT in this sequence, the beam counters will be greater than the position shown in the instructions. Therefore, the second MOVE will also be performed.

Note also that the above sequence of instructions could just as easily be

WAIT for position (60,60)  
MOVE data  
MOVE data

because multiple MOVEs can follow a single WAIT.

## COMPLETE SAMPLE COPPER LIST

The following example shows a complete Copper list. This list is for two bitplanes—one at \$21000 and one at \$25000. At the top of the screen, the color registers are loaded with the following values:

Register	Color
COLOR00	white
COLOR01	red
COLOR02	green
COLOR03	blue

At line 150 on the screen, the color registers are reloaded:

Register	Color
COLOR00	black
COLOR01	yellow
COLOR02	cyan
COLOR03	magenta

The complete Copper list follows.

```
;
; Notes: 1. Copper lists must be in Chip RAM.
;        2. Bitplane addresses used in the example are arbitrary.
;        3. Destination register addresses in copper move instructions are
;           offsets from the base address of the custom chips.
;        4. As always, hardware manual examples assume that your application
;           has taken full control of the hardware, and is not conflicting
;           with operating system use of the same hardware.
;        5. Many of the examples just pick memory addresses to be used.
;           Normally you would need to allocate the required type of
;           memory from the system with AllocMem()
;        6. As stated earlier, the code examples are mainly to help
;           clarify the way the hardware works.
;        7. The following INCLUDE files are required by all example code
;           in this chapter.
;
;        INCLUDE "exec/types.i"
;        INCLUDE "hardware/custom.i"
;        INCLUDE "hardware/dmabits.i"
;        INCLUDE "hardware/hw_examples.i"

COPPERLIST:
;
; Set up pointers to two bitplanes
;
;        DC.W    BPL1PTH,$0002    ;Move $0002 into register $0E0 (BPL1PTH)
;        DC.W    BPL1PTL,$1000    ;Move $1000 into register $0E2 (BPL1PTL)
;        DC.W    BPL2PTH,$0002    ;Move $0002 into register $0E4 (BPL2PTH)
;        DC.W    BPL2PTL,$5000    ;Move $5000 into register $0E6 (BPL2PTL)
;
; Load color registers
;
;        DC.W    COLOR00,$0FFF    ;Move white into register $180 (COLOR00)
;        DC.W    COLOR01,$0F00    ;Move red into register $182 (COLOR01)
;        DC.W    COLOR02,$00F0    ;Move green into register $184 (COLOR02)
;        DC.W    COLOR03,$000F    ;Move blue into register $186 (COLOR03)
;
; Specify 2 Lores bitplanes
;
;        DC.W    BPLCON0,$2200    ;2 lores planes, coloron
;
; Wait for line 150
;
;        DC.W    $9601,$FF00      ;Wait for line 150, ignore horiz. position
;
; Change color registers mid-display
;
;        DC.W    COLOR00,$0000    ;Move black into register $0180 (COLOR00)
;        DC.W    COLOR01,$0FF0    ;Move yellow into register $0182 (COLOR01)
;        DC.W    COLOR02,$00FF    ;Move cyan into register $0184 (COLOR02)
;        DC.W    COLOR03,$0F0F    ;Move magenta into register $0186 (COLOR03)
;
; End Copper list by waiting for the impossible
;
;        DC.W    $FFFF,$FFFE      ;Wait for line 255, H = 254 (never happens)
```

For more information about color registers, see Chapter 3, "Playfield Hardware."

---

## Starting and Stopping the Copper

### STARTING THE COPPER AFTER RESET

At power-on or reset time, you must initialize one of the Copper location registers (COP1LC or COP2LC) and write to its strobe address before Copper DMA is turned on. This ensures a known start address and known state. Usually, COP1LC is used because this particular register is reused during each vertical blanking time. The following sequence of instructions shows how to initialize a location register. It is assumed that the user has already created the correct Copper instruction list at location “mycoplist.”

```
;
; Install the copper list
;
    LEA    CUSTOM,a1           ; a1 = address of custom chips
    LEA    MYCOPLIST(pc),a0    ; Address of our copper list
    MOVE.L a0,COP1LC(a1)      ; Write whole longword address
    MOVE.W COPJMP1(a1),d0     ; Causes copper to load PC from COP1LC
;
; Then enable copper and raster dma
;
    MOVE.W #(DMAF_SETCLR!DMAF_COPPER!DMAF_RASTER!DMAF_MASTER),DMACON(a1)
;
```

Now, if the contents of COP1LC are not changed, every time vertical blanking occurs the Copper will restart at the same location for each subsequent video screen. This forms a repeatable loop which, if the list is correctly formulated, will cause the displayed screen to be stable.

### STOPPING THE COPPER

No stop instruction is provided for the Copper. To ensure that it will stop and do nothing until the screen display ends and the program counter starts again at the top of the instruction list, the last instruction should be to WAIT for an event that cannot occur. A typical instruction is to WAIT for VP = \$FF and HP = \$FE. An HP of greater than \$E2 is not possible. When the screen display ends and vertical blanking starts, the Copper will automatically be pointed to the top of its instruction list, and this final WAIT instruction never finishes.

You can also stop the Copper by disabling its ability to use DMA for retrieving instructions or placing data. The register called DMACON controls all of the DMA channels. Bit 7, COPEN, enables Copper DMA when set to 1.

For information about controlling the DMA, see Chapter 7, “System Control Hardware.”

---

## Advanced Topics

### THE SKIP INSTRUCTION

The SKIP instruction causes the Copper to skip the next instruction if the video beam counters are equal to or greater than the value given in the instruction.

The contents of the SKIP instruction's words are shown below. They are identical to the WAIT instruction, except that bit 0 of the second instruction word is a 1 to identify this as a SKIP instruction.

#### FIRST SKIP INSTRUCTION WORD (IR1)

- Bit 0            Always set to 1.
- Bits 15 - 8     Vertical position (called VP).
- Bits 7 - 1      Horizontal position (called HP).  
Skip if the beam counter is equal to or greater than these combined bits (bits 15 through 1).

#### SECOND SKIP INSTRUCTION WORD (IR2)

- Bit 0            Always set to 1.
- Bit 15           The blitter-finished-disable bit.  
(See "Using the Copper with the Blitter" below.)
- Bits 14 - 8     Vertical position compare enable bits (called VE).
- Bits 7 - 1      Horizontal position compare enable bits (called HE).

The notes about horizontal and vertical beam position found in the discussion of the WAIT instruction apply also to the SKIP instruction.

The following example SKIP instruction skips the instruction following it if VP (vertical beam position) is greater than or equal to 100 (\$64).

```
DC.W     $6401,$FF01     ;If VP >= 100,  
                         ; skip next instruction (ignore HP)
```

---

## COPPER LOOPS AND BRANCHES AND COMPARISON ENABLE

You can change the value in the location registers at any time and use this value to construct loops in the instruction list. Before the next vertical blanking time, however, the COP1LC registers *must* be repointed to the beginning of the appropriate Copper list. The value in the COP1LC location registers will be restored to the Copper's program counter at the start of the vertical blanking period.

Bits 14-1 of instruction word 2 in the WAIT and SKIP instructions specify which bits of the horizontal and vertical position are to be used for the beam counter comparison. The position in instruction word 1 and the compare enable bits in instruction word 2 are tested against the actual beam counters before any further action is taken. A position bit in instruction word 1 is used in comparing the positions with the actual beam counters *if and only if* the corresponding enable bit in instruction word 2 is set to 1. If the corresponding enable bit is 0, the comparison is always true. For instance, if you care only about the value in the last four bits of the vertical position, you set only the last four compare enable bits, bits (11-8) in instruction word 2.

Not all of the bits in the beam counter may be masked. If you look at the description of the IR2 (second instruction word) you will notice that bit 15 is the blitter-finished-disable bit. This bit is not part of the beam counter comparison mask, it has its own meaning in the Copper WAIT instruction. Thus, you can not mask the most significant bit in WAIT or SKIP instructions. In most situations this limitation does not come into play, however, the following example shows how to deal with it.

### A COPPER LOOP EXAMPLE

This example will instruct the Copper to issue an interrupt every 16 scan lines. It might seem that the way to do this would be to use a mask of \$0F and then compare the result with \$0F. This should compare "true" for \$1F, \$2F, \$3F, etc. Since the test is for greater than or equal to, this would *seem to allow* checking for every 16th scan line. However, the highest order bit cannot be masked, so it will always appear in the comparisons. When the Copper is waiting for \$0F and the vertical position is past 128 (hex \$80), this test will always be true. In this case, the minimum value in the comparison will be \$80, which is always greater than \$0F, and the interrupt will happen on every scan line. Remember, the Copper only checks for greater than or equal to.

In the following example, the Copper lists have been made to loop. The COP1LC and COP2LC values are either set via the CPU or in the Copper list before this section of Copper code. Also, it is assumed that you have correctly installed an interrupt server for the Copper interrupt that will be generated every 16 lines. Note that these are non-interlaced scan lines.

Here's how it works. Both loops are, for the most part, exactly the same. In each, the Copper waits until the vertical position register has \$xF (where x is any hex digit) in it, at which point we issue a Copper interrupt to the Amiga hardware. To make sure that the Copper does not loop back before the vertical position has changed and cause another interrupt on the same scan line, wait for the horizontal position to be \$E2 after each interrupt. Position \$E2 is horizontal position 113 for the Copper and the last real horizontal position available. This will force the Copper to

the next line before the next WAIT. The loop is executed by writing to the COPJMP1 register. This causes the Copper to jump to the address that was initialized in COP1LC.

The masking problem described above makes this code fail after vertical position 127. A separate loop must be executed when vertical position is greater than or equal 127. When the vertical position becomes greater than or equal to 127, the the first loop instruction is skipped, dropping the Copper into the second loop. The second loop is much the same as the first, except that it waits for \$xF with the high bit set (binary 1xxx1111). This is true for both the vertical and the horizontal WAIT instructions. To cause the second loop, write to the COPJMP2 register. The list is put into an infinite wait when VP >= 255 so that it will end before the vertical blank. At the end of the vertical blanking period COP1LC is written to by the operating system, causing the first loop to start up again.

*COP1LC is written at the end of vertical blanking.* The COP1LC register is written at the end of the vertical blanking period by a graphics interrupt handler which is in the vertical blank interrupt server chain. As long as this server is intact, COP1LC will be correctly strobed at the end of each vertical blank.

```

;
; This is the data for the Copper list.
;
; It is assumed that COPPERL1 is loaded into COP1LC and
; that COPPERL2 is loaded into COP2LC by some other code.
;
COPPERL1:
    DC.W    $0F01,$8F00    ; Wait for VP=0xxx1111
    DC.W    INTREQ,$8010   ; Set the copper interrupt bit...

    DC.W    $00E3,$80FE    ; Wait for Horizontal $E2
                                ; This is so the line gets finished before
                                ; we check if we are there (The wait above)

    DC.W    $7F01,$7F01    ; Skip if VP>=127
    DC.W    COPJMP1,$0     ; Force a jump to COP1LC

COPPERL2:
    DC.W    $8F01,$8F00    ; Wait for VP=1xxx1111
    DC.W    INTREQ,$8010   ; Set the copper interrupt bit...

    DC.W    $80E3,$80FE    ; Wait for Horizontal $E2
                                ; This is so the line gets finished before
                                ; we check if we are there (The wait above)

    DC.W    $FF01,$FE01    ; Skip if VP>=255
    DC.W    COPJMP2,$0     ; Force a jump to COP2LC

; Whatever cleanup copper code that might be needed here...
; Since there are 262 lines in NTSC, and we stopped at 255, there is a
; bit of time available

    DC.W    $FFFF,$FFFE    ; End of Copper list
;

```

## USING THE COPPER IN INTERLACED MODE

An interlaced bitplane display has twice the normal number of vertical lines on the screen. Whereas a normal NTSC display has 262 lines, an interlaced NTSC display has 524 lines. PAL has 312 lines normally and 625 in interlaced mode. In interlaced mode, the video beam scans the screen twice from top to bottom, displaying, in the case of NTSC, 262 lines at a time. During the first scan, the odd-numbered lines are displayed. During the second scan, the even-numbered lines are displayed and interlaced with the odd-numbered ones. The scanning circuitry thus treats an interlaced display as two display fields, one containing the even-numbered lines and one containing the odd-numbered lines. Figure 2-1 shows how an interlaced display is stored in memory.

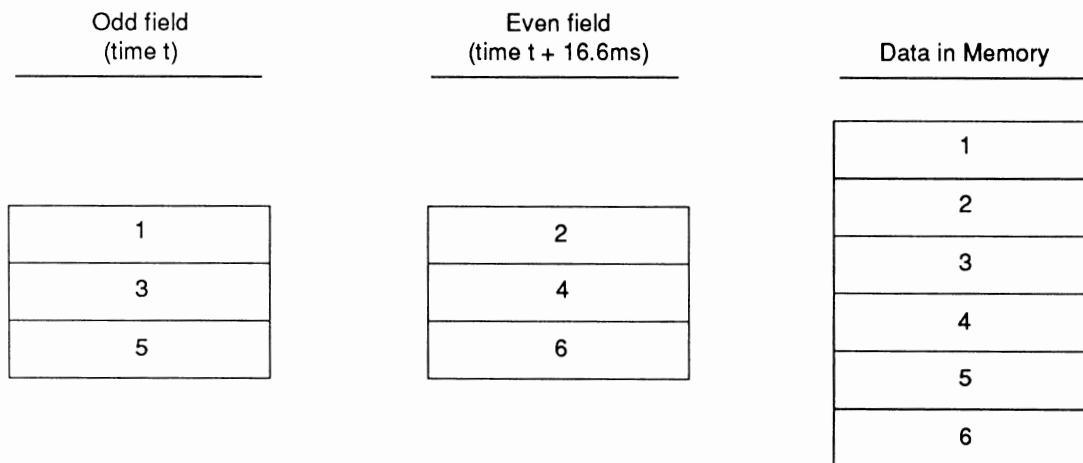

Figure 2-1: Interlaced Bitplane in RAM

The system retrieves data for bitplane displays by using pointers to the starting address of the data in memory. As you can see, the starting address for the even-numbered fields is one line greater than the starting address for the odd-numbered fields. Therefore, the bitplane pointer must contain a different value for alternate fields of the interlaced display.

Simply, the organization of the data in memory matches the apparent organization on the screen (i.e., odd and even lines are interlaced together). This is accomplished by having a separate Copper instruction list for each field to manage displaying the data.



---

To get the Copper to execute the correct list, you set an interrupt to the 680x0 just after the first line of the display. When the interrupt is executed, you change the contents of the COP1LC location register to point to the second list. Then, during the vertical blanking interval, COP1LC will be automatically reset to point to the original list.

For more information about interlaced displays, see Chapter 3, “Playfield Hardware.”

## USING THE COPPER WITH THE BLITTER

If the Copper is used to start up a sequence of blitter operations, it must wait for the blitter-finished interrupt before starting another blitter operation. Changing blitter registers while the blitter is operating causes unpredictable results. For just this purpose, the WAIT instruction includes an additional control bit, called BFD (for blitter finished disable). Normally, this bit is a 1 and only the beam counter comparisons control the WAIT.

When the BFD bit is a 0, the logic of the Copper WAIT instruction is modified. The Copper will WAIT until the beam counter comparison is true *and* the blitter has finished. The blitter has finished when the blitter-finished flag is set. This bit should be unset with caution. It could possibly prevent some screen displays or prevent objects from being displayed correctly.

For more information about using the blitter, see Chapter 6, “Blitter Hardware.”

## THE COPPER AND THE 680x0

On those occasions when the Copper’s instructions do not suffice, you can interrupt the 680x0 and use its instruction set instead. The 680x0 can poll for interrupt flags set in the INTREQ register by various devices. To interrupt the 680x0, use the Copper MOVE instruction to store a 1 into the following bits of INTREQ:

Table 2-1: Interrupting the 680x0

Bit Number	Name	Function
15	SET/CLR	Set/Clear control bit. Determines if bits written with a 1 get set or cleared.
4	COPEN	Coprocessor interrupting 680x0.

See Chapter 7, “System Control Hardware,” for more information about interrupts.

## Summary of Copper Instructions

The table below shows a summary of the bit positions for each of the Copper instructions. See Appendix A for a summary of all registers.

Table 2-2: Copper Instruction Summary

Bit#	Move		Wait		Skip	
	IR1	IR2	IR1	IR2	IR1	IR2
15	X	RD15	VP7	BFD	VP7	BFD
14	X	RD14	VP6	VE6	VP6	VE6
13	X	RD13	VP5	VE5	VP5	VE5
12	X	RD12	VP4	VE4	VP4	VE4
11	X	RD11	VP3	VE3	VP3	VE3
10	X	RD10	VP2	VE2	VP2	VE2
09	X	RD09	VP1	VE1	VP1	VE1
08	DA8	RD08	VP0	VE0	VP0	VE0
07	DA7	RD07	HP8	HE8	HP8	HE8
06	DA6	RD06	HP7	HE7	HP7	HE7
05	DA5	RD05	HP6	HE6	HP6	HE6
04	DA4	RD04	HP5	HE5	HP5	HE5
03	DA3	RD03	HP4	HE4	HP4	HE4
02	DA2	RD02	HP3	HE3	HP3	HE3
01	DA1	RD01	HP2	HE2	HP2	HE2
00	0	RD00	1	0	1	1

X = don't care, but should be a 0 for upward compatibility

IR1 = first instruction word

IR2 = second instruction word

DA = destination address

RD = RAM data to be moved to destination register

VP = vertical beam position bit

HP = horizontal beam position bit

VE = enable comparison (mask bit)

HE = enable comparison (mask bit)

BFD = blitter-finished disable

*ECS Copper.* For information relating to the Copper in the Enhanced Chip Set (ECS), see Appendix C.





---

## chapter three

# PLAYFIELD HARDWARE

The screen display of the Amiga consists of two basic parts—playfields, which are sometimes called backgrounds, and sprites, which are easily movable graphics objects. This chapter describes how to directly access hardware registers to form playfields. The chapter begins with a brief overview of playfield features and covers the following major topics:

- Forming a single “basic” playfield, which is a playfield the same size as the display screen. This section includes concepts that are fundamental to forming any playfield.
- Forming a dual-playfield display in which one playfield is superimposed upon another. This procedure differs from that of forming a basic playfield in some details.
- Forming playfields of various sizes and displaying only part of a larger playfield.
- Moving playfields by scrolling them vertically and horizontally.
- Advanced topics to help you use playfields in special situations.

For information about movable sprite objects, see Chapter 4, “Sprite Hardware.” There are also movable playfield objects, which are subsections of a playfield. To move portions of a playfield, you use a technique called playfield animation, which is described in Chapter 6, “Blitter Hardware.”

For information relating to the playfield hardware in the Enhanced Chip Set (ECS), such as SuperHires Mode, programmable scan rates and synchronization, see Appendix C.

---

## About Amiga Playfields

A playfield forms the basic foundation of an Amiga display and determines its fundamental characteristics. To form a playfield, you program the hardware registers of the custom chips with the basic parameters of the type of display you want. Forming a playfield involves selecting the number of colors, setting up a color table and bitplanes, and selecting the resolution and display mode.

To understand how Amiga playfields work, it will be helpful to review how the Amiga's video displays are produced.

### HOW THE AMIGA'S VIDEO DISPLAY IS PRODUCED

The Amiga produces its video displays with raster display techniques. The picture you see on the screen is made up of a series of horizontal video lines displayed one after the other. Each horizontal video line is made up of a series of pixels. You create a graphic display by defining one or more bitplanes in memory and filling them with '1's and '0's. The combination of the '1's and '0's will determine the colors in your display.

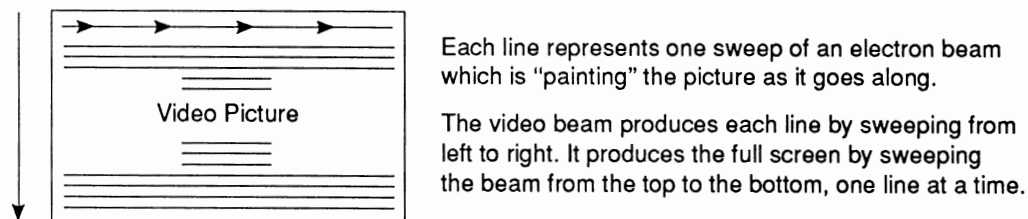

Figure 3-1: How the Video Display Picture Is Produced

The video beam produces about 262 video lines from top to bottom, of which 200 normally are visible on the screen with an NTSC system. With a PAL system, the beam produces 312 lines, of which 256 are normally visible. Each complete set of lines (262/NTSC or 312/PAL) is called a display field. The field time, i.e. the time required for a complete display field to be produced, is approximately 1/60th of a second for an NTSC system and approximately 1/50th of a second for PAL. Between display fields, the video beam traverses the lines that are not visible on the screen and returns to the top of the screen to produce another display field.

The display area is defined as a grid of pixels. A pixel is a single picture element, the smallest addressable part of a screen display. The drawings below show what a pixel is and how pixels form displays.

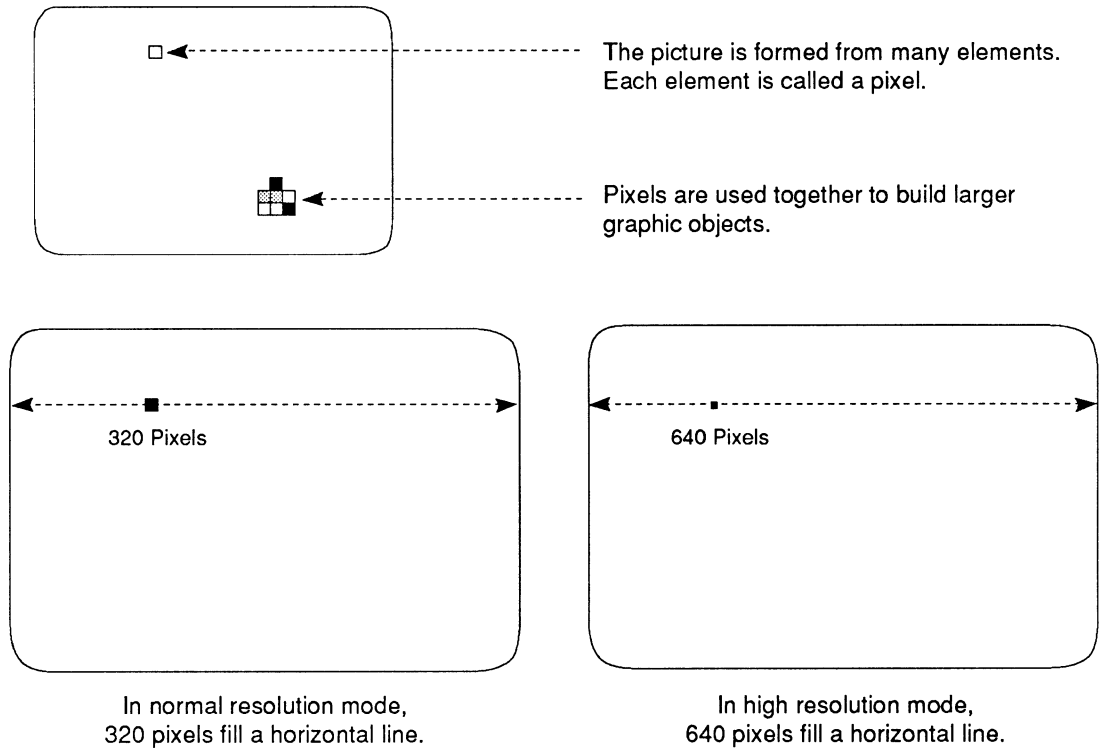

Figure 3-2: What Is a Pixel?

The Amiga offers a choice in both horizontal and vertical resolutions. Horizontal resolution can be adjusted to operate in low resolution or high resolution mode. Vertical resolution can be adjusted to operate in interlaced or non-interlaced mode.

- In low resolution mode, the normal playfield has a width of 320 pixels.
- High resolution mode gives finer horizontal resolution — 640 pixels in the same physical display area.
- In non-interlaced mode, the normal NTSC playfield has a height of 200 video lines. The normal PAL screen has a height of 256 video lines.
- Interlaced mode gives finer vertical resolution — 400 lines in the same physical display area in NTSC and 512 for PAL.

---

These modes can be combined, so you can have, for instance, an interlaced, high resolution display.

Note that the dimensions referred to as “normal” in the previous paragraph are *nominal* dimensions and represent the normal values you should expect to use. Actually, you can display larger playfields; the maximum dimensions are given in the section called “Bitplanes and Playfields of All Sizes.” Also, the dimensions of the playfield in memory are often larger than the playfield displayed on the screen. You choose which part of this larger memory picture to display by specifying a different size for the display window.

A playfield taller than the screen can be scrolled, or moved smoothly, up or down. A playfield wider than the screen can be scrolled horizontally, from left to right or right to left. Scrolling is described in the section called “Moving (Scrolling) Playfields.”

In the Amiga graphics system, you can have up to thirty-two different colors in a single playfield, using normal display methods. You can control the color of each individual pixel in the playfield display by setting the bit or bits that control each pixel. A display formed in this way is called a bitmapped display.

For instance, in a two-color display, the color of each pixel is determined by whether a single bit is on or off. If the bit is 0, the pixel is one user-defined color; if the bit is 1, the pixel is another color. For a four-color display, you build two bitplanes in memory. When the playfield is displayed, the two bitplanes are overlapped, which means that each pixel is now two bits deep. You can combine up to five bitplanes in this way. Displays made up of three, four, or five bitplanes allow a choice of eight, sixteen, or thirty-two colors, respectively.

The color of a pixel is always determined by the binary combination of the bits that define it. When the system combines bitplanes for display, the combination of bits formed for each pixel corresponds to the number of a color register. This method of coloring pixels is called *color indirection*. The Amiga has thirty-two color registers, each containing bits defining a user-selected color (from a total of 4,096 possible colors).

Figure 3-3 shows how the combination of up to five bitplanes forms a code that selects which one of the thirty-two registers to use to display the color of a playfield pixel.



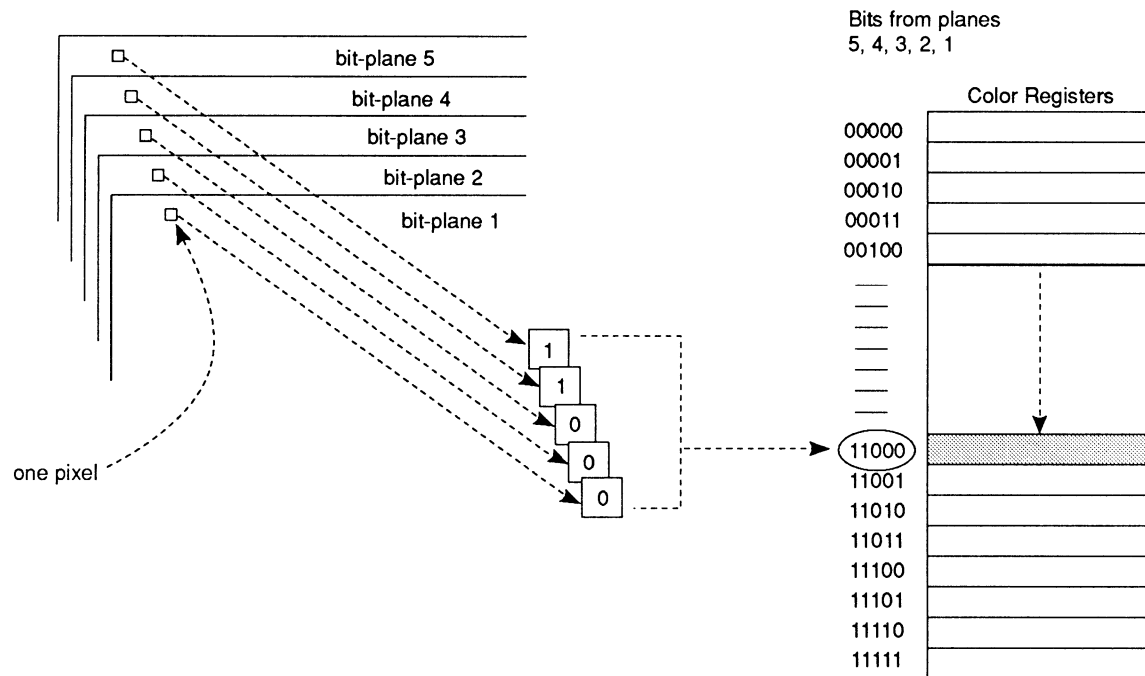

Figure 3-3: How Bitplanes Select a Color

Values in the highest numbered bitplane have the highest significance in the binary number. As shown in Figure 3-4, the value in each pixel in the highest-numbered bitplane forms the leftmost digit of the number. The value in the next highest-numbered bitplane forms the next bit, and so on.

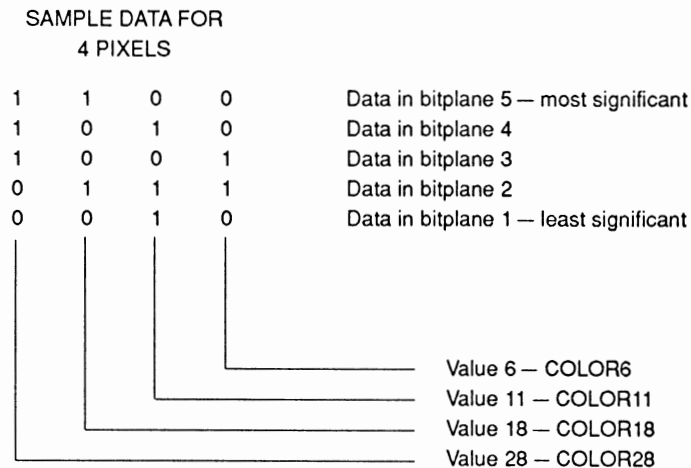

Figure 3-4: Significance of Bitplane Data in Selecting Colors

You also have the choice of defining two separate playfields, each formed from up to three bitplanes. Each of the two playfields uses a separate set of eight different colors. This is called *dual-playfield mode*.

## Forming a Basic Playfield

To get you started, this section describes how to directly access hardware registers to form a single basic playfield that is the same size as the video screen. Here, “same size” means that the playfield is the same size as the actual display window. This will leave a small border between the playfield and the edge of the video screen. The playfield usually does not extend all the way to the edge of the physical display.

To form a playfield, you need to define these characteristics:

- Height and width of the playfield and size of the display window (that is, how much of the playfield actually appears on the screen).
- Color of each pixel in the playfield.
- Horizontal resolution.

- Vertical resolution, or interlacing.
- Data fetch and modulo, which tell the system how much data to put on a horizontal line and how to fetch data from memory to the screen.

In addition, you need to allocate memory to store the playfield, set pointers to tell the system where to find the data in memory, and (optionally) write a Copper routine to handle redisplay of the playfield.

## HEIGHT AND WIDTH OF THE PLAYFIELD

To create a playfield that is the same size as the screen, you can use a width of either 320 pixels or 640 pixels, depending upon the resolution you choose. The height is either 200 or 400 lines for NTSC, 256 or 512 lines for PAL, depending upon whether or not you choose interlaced mode.

## BITPLANES AND COLOR

You define playfield color by:

1. Deciding how many colors you need and how you want to color each pixel.
2. Loading the colors into the color registers.
3. Allocating memory for the number of bitplanes you need and setting a pointer to each bitplane.
4. Writing instructions to place a value in each bit in the bitplanes to give you the correct color.

Table 3-1 shows how many bitplanes to use for the color selection you need.

Number of Colors	Number of Bitplanes
1 - 2	1
3 - 4	2
5 - 8	3
9 - 16	4
17 - 32	5

Table 3-1: Colors in a Single Playfield

---

## The Color Table

The color table contains 32 registers, and you may load a different color into each of the registers. Here is a condensed view of the contents of the color table:

Register Name	Contents	Meaning
COLOR00	12 bits	User-defined color for the background area and borders.
COLOR01	12 bits	User-defined color number 1 (For example, the alternate color selection for a two-color playfield).
COLOR02	12 bits	User-defined color number 2.
.	.	.
.	.	.
.	.	.
COLOR31	12 bits	User-defined color number 31.

Table 3-2: Portion of the Color Table

COLOR00 is always reserved for the background color. The background color shows in any area on the display where there is no other object present and is also displayed outside the defined display window, in the border area.

*Genlocks and the background color.* If you are using the optional genlock board for video input from a camera, VCR, or laser disk, the background color will be replaced by the incoming video display.

Twelve bits of color selection allow you to define, for each of the 32 registers, one of 4,096 possible colors, as shown in Table 3-3.

Bits	
Bits 15 - 12	Unused
Bits 11 - 8	Red
Bits 7 - 4	Green
Bits 3 - 0	Blue

Table 3-3: Contents of the Color Registers

---

Table 3-4 shows some sample color register bit assignments and the resulting colors. At the end of the chapter is a more extensive list.

Contents of the Color Register	Resulting Color
\$FFF	White
\$6FE	Sky blue
\$DB9	Tan
\$000	Black

Table 3-4: Sample Color Register Contents

Some sample instructions for loading the color registers are shown below:

```
LEA    CUSTOM, a0           ; Get base address of custom hardware...
MOVE.W #FFF, COLOR0 (a0)   ; Load white into color register 0
MOVE.W #6FE, COLOR1 (a0)  ; Load sky blue into color register 1
```

*The color registers are write-only.* Only by looking at the screen can you find out the contents of each color register. As a standard practice, then, for these and certain other write-only registers, you may wish to keep a “back-up” RAM copy. As you write to the color register itself, you should update this RAM copy. If you do so, you will always know the value each register contains.

---

## Selecting the Number of Bitplanes

After deciding how many colors you want and how many bitplanes are required to give you those colors, you tell the system how many bitplanes to use.

You select the number of bitplanes by writing the number into the register BPLCON0 (for Bitplane Control Register 0) The relevant bits are bits 14, 13, and 12, named BPU2, BPU1, and BPU0 (for "Bitplanes Used"). Table 3-5 shows the values to write to these bits and how the system assigns bitplane numbers.

Table 3-5: Setting the Number of Bitplanes

Value	Number of Bitplanes	Name(s) of Bitplanes
000	None *	
001	1	PLANE 1
010	2	PLANES 1 and 2
011	3	PLANES 1 - 3
100	4	PLANES 1 - 4
101	5	PLANES 1 - 5
110	6	PLANES 1 - 6 **
111		Value not used.

\* Shows only a background color; no playfield is visible.

\*\* Sixth bitplane is used only in dual-playfield mode and in hold-and-modify mode (described in the section called "Advanced Topics").

*About the BPLCON0 register.* The bits in the BPLCON0 register cannot be set independently. To set any one bit, you must reload them all.

The following example shows how to tell the system to use two low resolution bitplanes.

```
MOVE.W  #2200,BPLCON0+CUSTOM ; Write to it
```

Because register BPLCON0 is used for setting other characteristics of the display and the bits are not independently settable, the example above also sets other parameters (all of these parameters are described later in the chapter).

- Hold-and-modify mode is turned off.

- Single-playfield mode is set.
- Composite video color is enabled. (Not applicable in all models.)
- Genlock audio is disabled.
- Light pen is disabled.
- Interlaced mode is disabled.
- External resynchronization is disabled. (genlock)

## SELECTING HORIZONTAL AND VERTICAL RESOLUTION

Standard home television screens are best suited for low resolution displays. Low resolution mode provides 320 pixels for each horizontal line. High resolution monochrome and RGB monitors can produce displays in high resolution mode, which provides 640 pixels for each horizontal line. If you define an object in low resolution mode and then display it in high resolution mode, the object will be only half as wide.

To set horizontal resolution mode, you write to bit 15, HIRES, in register BPLCON0:

- High resolution mode — write 1 to bit 15.
- Low resolution mode — write 0 to bit 15.

Note that in high resolution mode, you can have up to four bitplanes in the playfield and, therefore, up to 16 colors.

Interlaced mode allows twice as much data to be displayed in the same vertical area as in non-interlaced mode. This is accomplished by doubling the number of lines appearing on the video screen. The following table shows the number of lines required to fill a normal, non-overscan screen.

	NTSC	PAL
Non-interlaced	200	256
Interlaced	400	512

Table 3-6: Lines in a Normal Playfield

In interlaced mode, the scanning circuitry vertically offsets the start of every other field by half a scan line.

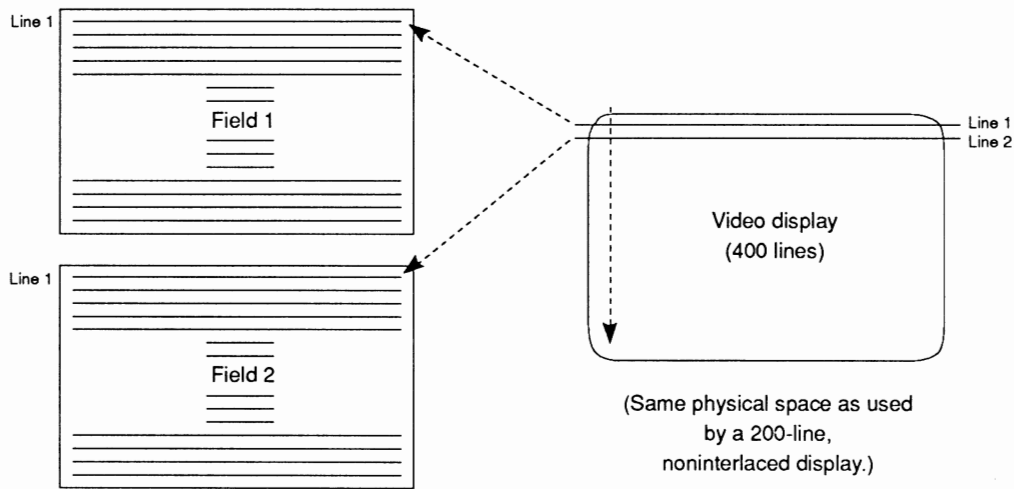

Figure 3-5: Interlacing

Even though interlaced mode requires a modest amount of extra work in setting registers (as you will see later on in this section), it provides fine tuning that is needed for certain graphics effects. Consider the diagonal line in Figure 3-6 as it appears in non-interlaced and interlaced modes. Interlacing eliminates much of the jaggedness or “staircasing” in the edges of the line.

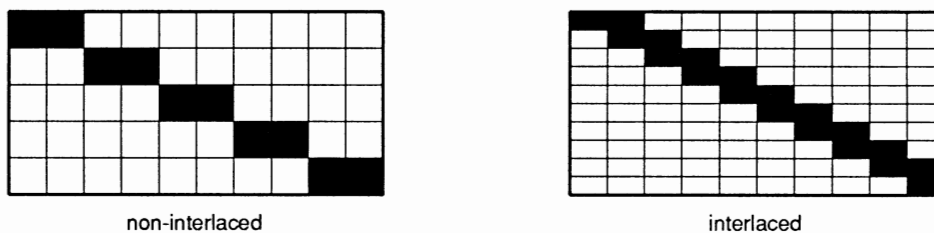

Figure 3-6: Effect of Interlaced Mode on Edges of Objects

When you use the special blitter DMA channel to draw lines or polygons onto an interlaced playfield, the playfield is treated as one display, rather than as odd and even fields. Therefore, you still get the smoother edges provided by interlacing.



---

To set interlaced or non-interlaced mode, you write to bit 2, LACE, in register BPLCON0:

Interlaced mode — write 1 to bit 2.

Non-interlaced mode — write 0 to bit 2.

As explained above in “Setting the Number of Bitplanes,” bits in BPLCON0 are not independently settable.

The following example shows how to specify high resolution and interlaced modes.

```
MOVE.W #A204,BPLCON0+CUSTOM ; Write to it
```

The example above also sets the following parameters that are also controlled through register BPLCON0:

- High resolution mode is enabled.
- Two bitplanes are used.
- Hold-and-modify mode is disabled.
- Single-playfield mode is enabled.
- Composite video color is enabled.
- Genlock audio is disabled.
- Light pen is disabled.
- Interlaced mode is enabled.
- External resynchronization is disabled.

The amount of memory you need to allocate for each bitplane depends upon the resolution modes you have selected, because high resolution or interlaced playfields contain more data and require larger bitplanes.

## ALLOCATING MEMORY FOR BITPLANES

After you set the number of bitplanes and specify resolution modes, you are ready to allocate memory. A bitplane consists of an end-to-end sequence of words at consecutive memory locations. When operating under the Amiga operating system, use a system call such as AllocMem() to remove a block of memory from the free list and make it available to the program.

A specialized allocation function named AllocRaster() in the graphics.library is recommended for all bitplane allocations. AllocRaster() will pad the allocation to properly align scan lines for the hardware.

If the machine has been taken over, simply reserve an area of memory for the bitplanes. Next, set the bitplane pointer registers (BPLxPTH/BPLxPTL) to point to the starting memory address of each bitplane you are using. The starting address is the memory word that contains the bits of the upper left-hand corner of the bitplane.

Tables 3-7 and 3-8 show how much memory is needed for basic playfield modes under NTSC and PAL, respectively. You may need to balance your color and resolution requirements against the amount of available memory you have.

Table 1-7: Playfield Memory Requirements, NTSC

Picture Size	Modes	Number of Bytes per Bitplane
320 X 200	Low resolution, non-interlaced	8,000
320 X 400	Low resolution, interlaced	16,000
640 X 200	High resolution, non-interlaced	16,000
640 X 400	High resolution, interlaced	32,000

Keep in mind that the number of bytes you allocate for a bitplane must be even.

Table 3-8: Playfield Memory Requirements, PAL

Picture Size	Modes	Number of Bytes per Bitplane
320 X 256	Low resolution, non-interlaced	8,192
320 X 512	Low resolution, interlaced	16,384
640 X 256	High resolution, non-interlaced	16,384
640 X 512	High resolution, interlaced	32,768

### ***NTSC Example of Bitplane Size***

For example, using a normal, NTSC, low resolution, non-interlaced display with 320 pixels across each display line and a total of 200 display lines, each line of the bitplane requires 40 bytes (320 bits divided by 8 bits per byte = 40). Multiply the 200 lines times 40 bytes per line to get 8,000 bytes per bitplane as given above.

A low resolution, non-interlaced playfield made up of two bitplanes requires 16,000 bytes of memory area. The memory for each bitplane must be continuous, so you need to have two 8,000-byte blocks of available memory. Figure 3-7 shows an 8,000-byte memory area organized as 200 lines of 40 bytes each, providing 1 bit for each pixel position in the display plane.

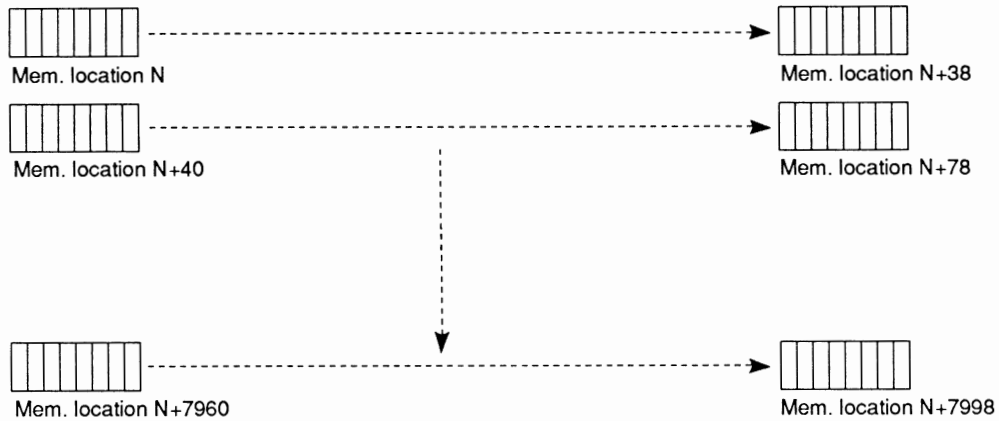

Figure 3-7: Memory Organization for a Basic Bitplane

Access to bitplanes in memory is provided by two address registers, BPLxPTH and BPLxPTL, for each bitplane (12 registers in all). The “x” position in the name holds the bitplane number; for example BPL1PTH and BPL1PTL hold the starting address of PLANE 1. Pairs of registers with names ending in PTH and PTL contain 19-bit addresses. 68000 programmers may treat these as one 32-bit address and write to them as one long word. You write to the high order word, which is the register whose name ends in “PTH.”

The example below shows how to set the bitplane pointers. Assuming two bitplanes, one at \$21000 and the other at \$25000, the processor sets BPL1PT to \$21000 and BPL2PT to \$25000. Note that this is usually the Copper’s task.

```

;
; Since the bitplane pointer registers are mapped as full 680x0 long-word
; data, we can store the addresses with a 32-bit move...
;
    LEA    CUSTOM,a0           ; Get base address of custom hardware...
    MOVE.L $21000,BPL1PTH(a0) ; Write bitplane 1 pointer
    MOVE.L $25000,BPL2PTH(a0) ; Write bitplane 2 pointer

```

Note that the memory requirements given here are for the playfield only. You may need to allocate additional memory for other parts of the display — sprites, audio, animation — and for your application programs. Memory allocation for other parts of the display is discussed in the chapters describing those topics.

---

## CODING THE BITPLANES FOR CORRECT COLORING

After you have specified the number of bitplanes and set the bitplane pointers, you can actually write the color register codes into the bitplanes.

### *A One- or Two-Color Playfield*

For a one-color playfield, all you need do is write ‘0’s in all the bits of the single bitplane as shown in the example below. This code fills a low resolution bitplane with the background color (COLOR00) by writing all ‘0’s into its memory area. The bitplane starts at \$21000 and is 8,000 bytes long.

```
        LEA    $21000,a0        ; Point at bitplane
        MOVE.W #2000,d0        ; Write 2000 longwords = 8000 bytes
LOOP:   MOVE.L #0,(a0)+        ; Write out a zero
        DBRA  d0,LOOP          ; Decrement counter and loop until done...
```

For a two-color playfield, you define a bitplane that has ‘0’s where you want the background color and ‘1’s where you want the color in register 1. The following example code is identical to the last example, except the bitplane is filled with \$FF00FF00 instead of all 0’s. This will produce two colors.

```
        LEA    $21000,a0        ; Point at bitplane
        MOVE.W #2000,d0        ; Write 2000 longwords = 8000 bytes
LOOP:   MOVE.L #$FF00FF00,(a0)+ ; Write out $FF00FF00
        DBRA  d0,LOOP          ; Decrement counter and loop until done...
```

### A Playfield of Three or More Colors

For three or more colors, you need more than one bitplane. The task here is to define each bitplane in such a way that when they are combined for display, each pixel contains the correct combination of bits. This is a little more complicated than a playfield of one bitplane. The following examples show a four-color playfield, but the basic idea and procedures are the same for playfields containing up to 32 colors.

Figure 3-8 shows two bitplanes forming a four-color playfield:

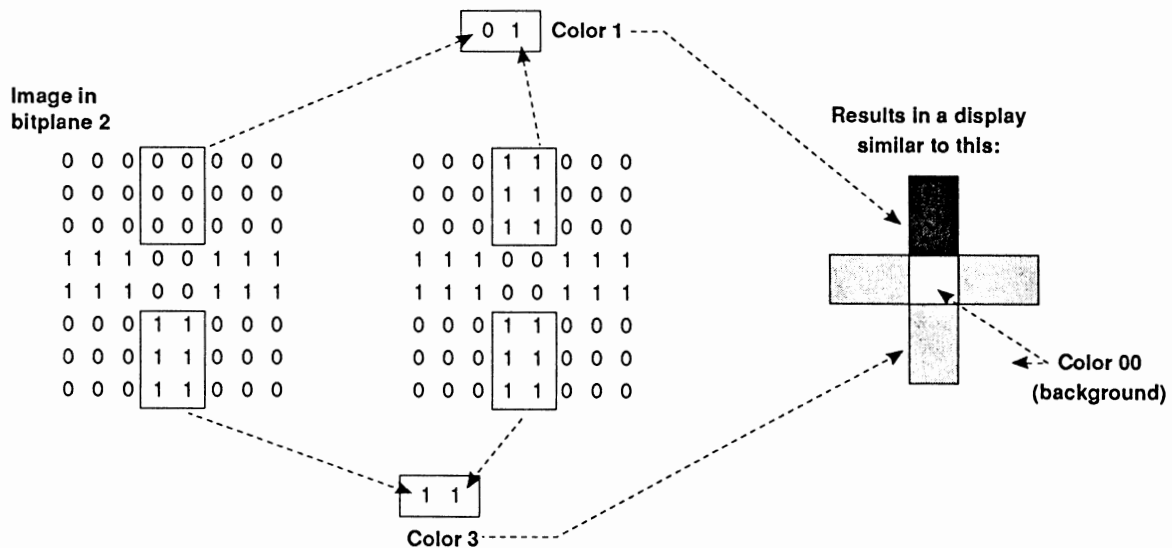

Figure 3-8: Combining Bitplanes

You place the correct "1"s and "0"s in both bitplanes to give each pixel in the picture above the correct color.

In a single playfield you can combine up to five bitplanes in this way. Using five bitplanes allows a choice of 32 different colors for any single pixel. The playfield color selection charts at the end of this chapter summarize the bit combinations for playfields made from four and five bitplanes.

---

## DEFINING THE SIZE OF THE DISPLAY WINDOW

After you have completely defined the playfield, you need to define the size of the display window, which is the actual size of the on-screen display. Adjustment of display window size affects the entire display area, including the border and the sprites, not just the playfield. You cannot display objects outside of the defined display window. Also, the size of the border around the playfield depends on the size of the display window.

The basic playfield described in this section is the same size as the screen display area and also the same size as the display window. This is not always the case; often the display window is smaller than the actual "big picture" of the playfield as defined in memory (the raster).

A display window that is smaller than the playfield allows you to display some segment of a large playfield or scroll the playfield through the window. You can also define display windows larger than the basic playfield. These larger playfields and different-sized display windows are described in the section below called "Bitplanes and Display Windows of All Sizes."

You define the size of the display window by specifying the vertical and horizontal positions at which the window starts and stops and writing these positions to the display window registers. The resolution of vertical start and stop is one scan line. The resolution of horizontal start and stop is one low resolution pixel. Each position on the screen defines the horizontal and vertical position of some pixel, and this position is specified by the x and y coordinates of the pixel. This document shows the x and y coordinates in this form: (x,y).

Although the coordinates begin at (0,0) in the upper left-hand corner of the screen, the first horizontal position normally used is \$81 and the first vertical position is \$2C. The horizontal and vertical starting positions are the same both for NTSC and for PAL.

The hardware allows you to specify a starting position before (\$81,\$2C), but part of the display may not be visible. The difference between the absolute starting position of (0,0) and the normal starting position of (\$81,\$2C) is the result of the way many video display monitors are designed.

To overcome the distortion that can occur at the extreme edges of the screen, the scanning beam sweeps over a larger area than the front face of the screen can display. A starting position of (\$81,\$2C) centers a normal size display, leaving a border of eight low resolution pixels around the display window. Figure 3-9 shows the relationship between the normal display window, the visible screen area, and the area actually covered by the scanning beam.

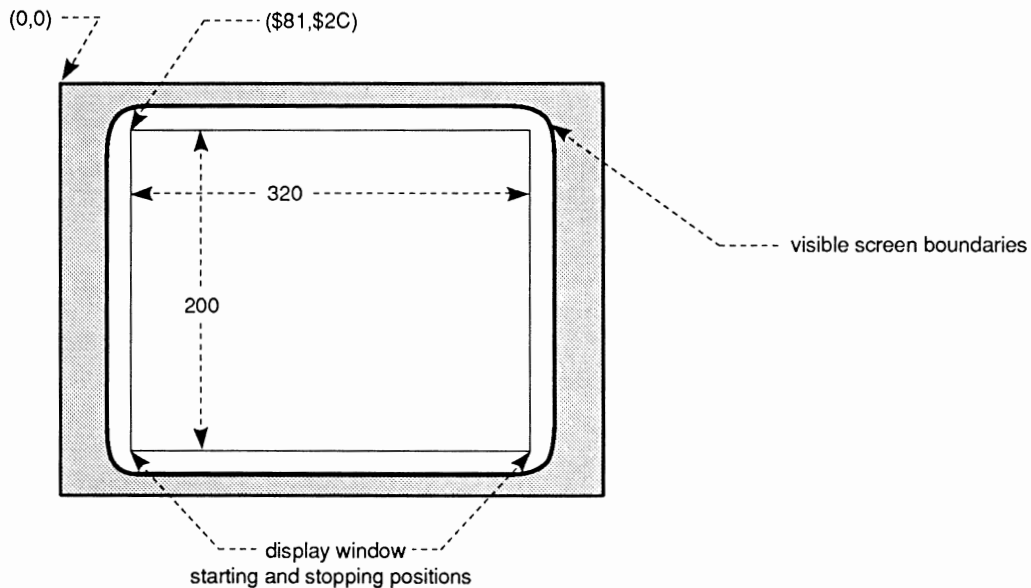

Figure 3-9: Positioning the On-screen Display

### ***Setting the Display Window Starting Position***

A horizontal starting position of approximately \$81 and a vertical starting position of approximately \$2C centers the display on most standard television screens. If you select high resolution mode (640 pixels horizontally) or interlaced mode (400 lines NTSC, 512 PAL) the starting position does not change. The starting position is always interpreted in low resolution, non-interlaced mode. In other words, you select a starting position that represents the correct coordinates in low resolution, non-interlaced mode.

The register DIWSTRT (for “Display Window Start”) controls the display window starting position. This register contains both the horizontal and vertical components of the display window starting positions, known respectively as HSTART and VSTART. The following example sets DIWSTRT for a basic playfield. You write \$2C for VSTART and \$81 for HSTART.

```
LEA    CUSTOM,a0           ; Get base address of custom hardware...
MOVE.W # $2C81,DIWSTRT(a0) ; Display window start register...
```



## Setting the Display Window Stopping Position

You also need to set the display window stopping position, which is the lower right-hand corner of the display window. If you select high resolution or interlaced mode, the stopping position does not change. Like the starting position, it is interpreted in low resolution, non-interlaced mode.

The register DIWSTOP (for Display Window Stop) controls the display window stopping position. This register contains both the horizontal and vertical components of the display window stopping positions, known respectively as HSTOP and VSTOP. The instructions below show how to set HSTOP and VSTOP for the basic playfield, assuming a starting position of (\$81,\$2C). Note that the HSTOP value you write is the actual value minus 256 (\$100). The HSTOP position is restricted to the right-hand side of the screen. The normal HSTOP value is (\$1C1) but is written as (\$C1). HSTOP is the same both for NTSC and for PAL.

The VSTOP position is restricted to the lower half of the screen. This is accomplished in the hardware by forcing the MSB of the stop position to be the complement of the next MSB. This allows for a VSTOP position greater than 256 (\$100) using only 8 bits. Normally, the VSTOP is set to (\$F4) for NTSC, (\$2C) for PAL.

The normal NTSC DIWSTRT is (\$2C81).  
The normal NTSC DIWSTOP is (\$F4C1).

The normal PAL DIWSTRT is (\$2C81).  
The normal PAL DIWSTOP is (\$2CC1).

The following example sets DIWSTOP for a basic playfield to \$F4 for the vertical position and \$C1 for the horizontal position.

```
LEA    CUSTOM,a0          ; Get base address of custom hardware...
MOVE.W #F4C1,DIWSTOP(a0) ; Display window stop register...
```

Table 3-9: DIWSTRT and DIWSTOP Summary

	Nominal Values		Possible Values	
	NTSC	PAL	MIN	MAX
<b>DIWSTRT:</b>				
VSTART	\$2C	\$2C	\$00	\$FF
HSTART	\$81	\$81	\$00	\$FF
<b>DIWSTOP:</b>				
VSTOP	\$F4	\$2C (= \$12C)	\$80	\$7F (= \$17F)
HSTOP	\$C1	\$C1	\$00 (= \$100)	\$FF (= \$1FF)

The minimum and maximum values for display windows have been extended in the enhanced version of the Amiga's custom chip set (ECS). See "Appendix C, Enhanced Chip Set" for more information about the display window registers.

## TELLING THE SYSTEM HOW TO FETCH AND DISPLAY DATA

After defining the size and position of the display window, you need to give the system the on-screen location for data fetched from memory. To do this, you describe the horizontal positions where each line starts and stops and write these positions to the data-fetch registers. The data-fetch registers have a four-pixel resolution (unlike the display window registers, which have a one-pixel resolution). Each position specified is four pixels from the last one. Pixel 0 is position 0; pixel 4 is position 1, and so on.

The data-fetch start and display window starting positions interact with each other. It is recommended that data-fetch start values be restricted to a programming resolution of 16 pixels (8 clocks in low resolution mode, 4 clocks in high resolution mode). The hardware requires some time after the first data fetch before it can actually display the data. As a result, there is a difference between the value of window start and data-fetch start of 4.5 color clocks.

The normal low resolution DDFSTRT is (\$0038).

The normal high resolution DDFSTRT is (\$003C).

Recall that the hardware resolution of display window start and stop is twice the hardware resolution of data fetch:

$$\frac{\$81}{2} - 8.5 = \$38$$

$$\frac{\$81}{2} - 4.5 = \$3C$$

The relationship between data-fetch start and stop is

$$DDFSTRT = DDFSTOP - (8 * (\text{word count} - 1)) \text{ for low resolution}$$

$$DDFSTRT = DDFSTOP - (4 * (\text{word count} - 2)) \text{ for high resolution}$$

The normal low resolution DDFSTOP is (\$00D0). The normal high resolution DDFSTOP is (\$00D4).

The following example sets data-fetch start to \$0038 and data-fetch stop to \$00D0 for a basic playfield.

```
LEA      CUSTOM, a0          ; Point to base hardware address
MOVE.W  #$0038, DDFSTRT(a0) ; Write to DDFSTRT
MOVE.W  #$00D0, DDFSTOP(a0) ; Write to DDFSTOP
```

You also need to tell the system exactly which bytes in memory belong on each horizontal line of the display. To do this, you specify the modulo value. Modulo refers to the number of bytes in memory between the last word on one horizontal line and the beginning of the first word on the next line. Thus, the modulo enables the system to convert bitplane data stored in linear form (each data byte at a sequentially increasing memory address) into rectangular form (one "line" of

sequential data followed by another line). For the basic playfield, where the playfield in memory is the same size as the display window, the modulo is zero because the memory area contains exactly the same number of bytes as you want to display on the screen. Figures 3-10 and 3-11 show the basic bitplane layout in memory and how to make sure the correct data is retrieved.

The bitplane address pointers (BPLxPTH and BPLxPTL) are used by the system to fetch the data to the screen. These pointers are dynamic; once the data fetch begins, the pointers are continuously incremented to point to the next *word* to be fetched (data is fetched two bytes at a time). When the end-of-line condition is reached (defined by the data-fetch register, DDFSTOP) the modulo is added to the bitplane pointers, adjusting the pointer to the first word to be fetched for the next horizontal line.

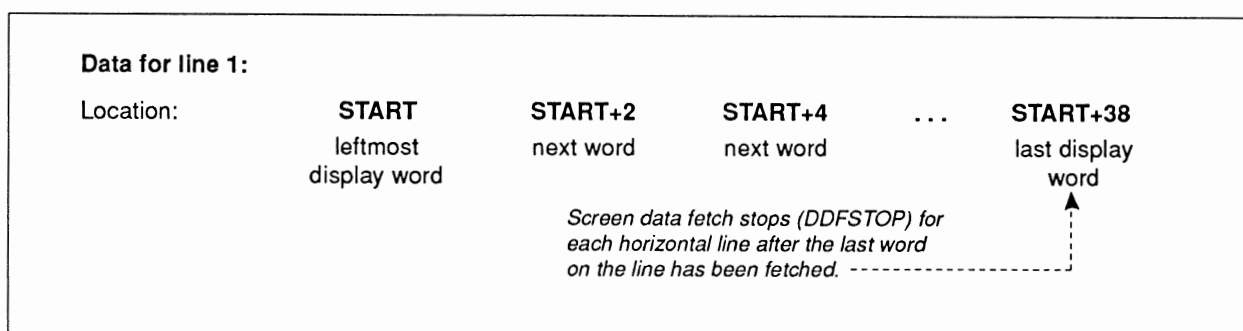

Figure 3-10: Data Fetched for the First Line When Modulo = 0

After the first line is fetched, the bitplane pointers BPLxPTH and BPLxPTL contain the value START+40. The modulo (in this case, 0) is added to the current value of the pointer, so when the pointer begins the data fetch for the next line, it fetches the data you want on that line. The data for the next line begins at memory location START+40.

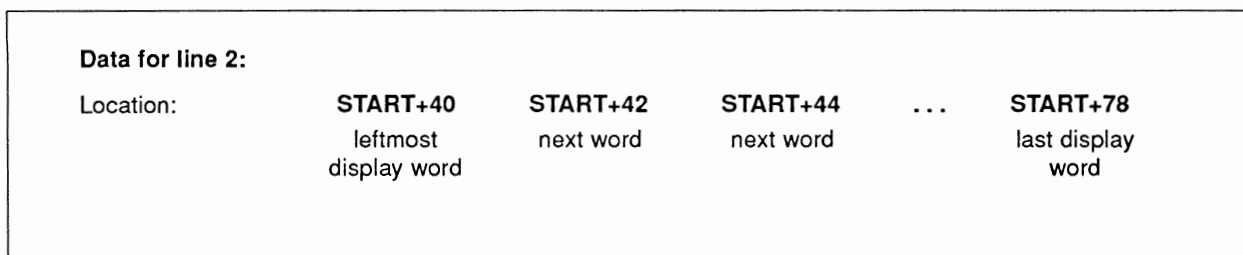

Figure 3-11: Data Fetched for the Second Line When Modulo = 0

Note that the pointers always contain an even number, because data is fetched from the display a *word* at a time.

---

There are two modulo registers—BPL1MOD for the odd-numbered bitplanes and BPL2MOD for the even-numbered bitplanes. This allows for differing modulus for each playfield in dual-playfield mode. For normal applications, both BPL1MOD and BPL2MOD will be the same.

The following example sets the modulo to 0 for a low resolution playfield with one bitplane. The bitplane is odd-numbered.

```
MOVE.W #0,BPL1MOD+CUSTOM ; Set modulo to 0
```

### ***Data Fetch in High resolution Mode***

When you are using high resolution mode to display the basic playfield, you need to fetch 80 bytes for each line, instead of 40.

### ***Modulo in Interlaced Mode***

For interlaced mode, you must redefine the modulo, because interlaced mode uses two separate scanings of the video screen for a single display of the playfield. During the first scanning, the odd-numbered lines are fetched to the screen; and during the second scanning, the even-numbered lines are fetched.

The bitplanes for a full-screen-sized, interlaced display are 400 NTSC (512 PAL), rather than 200 NTSC (256 PAL), lines long. Assuming that the playfield in memory is the normal 320 pixels wide, data for the interlaced picture begins at the following locations (these are all byte addresses):

Line 1	START
Line 2	START+40
Line 3	START+80
Line 4	START+120

and so on. Therefore, you use a modulo of 40 to skip the lines in the other field. For odd fields, the bitplane pointers begin at START. For even fields, the bitplane pointers begin at START+40.

You can use the Copper to handle resetting of the bitplane pointers for interlaced displays.

## **DISPLAYING AND REDISPLAYING THE PLAYFIELD**

You start playfield display by making certain that the bitplane pointers are set and bitplane DMA is turned on. You turn on bitplane DMA by writing a 1 to bit BPLEN in the DMACON (for DMA control) register. See Chapter 7, “System Control Hardware,” for instructions on setting this register.

---

Each time the playfield is redisplayed, you have to reset the bitplane pointers. Resetting is necessary because the pointers have been incremented to point to each successive word in memory and must be repointed to the first word for the next display. You write Copper instructions to handle the redisplay or perform this operation as part of a vertical blanking task.

## ENABLING THE COLOR DISPLAY

The stock A1000 has a color composite output and requires bit 9 set in BPLCON0 to create a color composite display signal. Without the addition of specialized hardware, the A500, A2000 and A3000 cannot generate color composite output.

*NOTE:* The color burst enable does not affect the RGB video signal. RGB video is correctly generated regardless of the output of the composite video signal.

## BASIC PLAYFIELD SUMMARY

The steps for defining a basic playfield are summarized below:

### 1. Define Playfield Characteristics

#### a. Specify color for each pixel:

- Load desired colors in color table registers.
- Define color of each pixel in terms of the binary value that points at the desired color register.
- Build bitplanes and set bitplane registers:
  - Bits 12-14 in BPLCON0 - number of bitplanes (BPU2 - BPU0).
  - BPLxPTH - pointer to bitplane starting position in memory (written as a long word).

#### b. Specify resolution:

- Low resolution:
  - 320 pixels in each horizontal line.
  - Clear bit 15 in register BPLCON0 (HIRES).
- High resolution:
  - 640 pixels in each horizontal line.
  - Set bit 15 in register BPLCON0 (HIRES).

- 
- c. Specify interlaced or non-interlaced mode:
- Interlaced mode:  
400 vertical lines for NTSC, 512 for PAL.  
Set bit 2 in register BPLCON0 (LACE).
  - Non-interlaced mode:  
200 vertical lines for NTSC, 256 for PAL.  
Clear bit 2 in BPLCON0 (LACE).
2. **Allocate Memory.** To calculate data-bytes in the total bitplanes, use the following formula:  
$$\text{Bytes per line} * \text{lines in playfield} * \text{number of bitplanes}$$
3. **Define Size of Display Window.**
- Write start position of display window in DIWSTRT:  
Horizontal position in bits 0 through 7 (low order bits).  
Vertical position in bits 8 through 15 (high order bits).
  - Write stop position of display window in DIWSTOP:  
Horizontal position in bits 0 through 7.  
Vertical position in bits 8 through 15.
4. **Define Data Fetch.** Set registers DDFSTRT and DDFSTOP:
- For DDFSTRT, use the horizontal position as shown in “Setting the Display Window Starting Position.”
  - For DDFSTOP, use the horizontal position as shown in “Setting the Display Window Stopping Position.”
5. **Define Modulo.** Set registers BPL1MOD and BPL2MOD. Set modulo to 0 for non-interlaced, 40 for interlaced.
6. **Write Copper Instructions To Handle Redisplay.**
7. **Enable Color Display.** For the A1000: set bit 9 in BPLCON0 to enable the color display on a composite video monitor. RGB video is not affected. Only the A1000 has color composite video output, other Amiga models cannot enable this feature using standard hardware.

## EXAMPLES OF FORMING BASIC PLAYFIELDS

The following examples show how to set the registers and write the coprocessor lists for two different playfields.

The first example sets up a 320 x 200 playfield with one bitplane, which is located at \$21000. Also, a Copper list is set up at \$20000.

This example relies on the include file "hw\_examples.i", which is found in Appendix I.

```
        LEA        CUSTOM,a0                ; a0 points at custom chips
        MOVE.W    #$1200,BPLCON0(a0)        ; One bitplane, enable composite color
        MOVE.W    #0,BPLCON1(a0)           ; Set horizontal scroll value to 0
        MOVE.W    #0,BPLMOD(a0)            ; Set modulo to 0 for all odd bitplanes
        MOVE.W    #$0038,DDFSTRT(a0)       ; Set data-fetch start to $38
        MOVE.W    #$00D0,DDFSTOP(a0)       ; Set data-fetch stop to $D0
        MOVE.W    #$2C81,DIWSTRT(a0)       ; Set DIWSTRT to $2C81
        MOVE.W    #$F4C1,DIWSTOP(a0)       ; Set DIWSTOP to $F4C1
        MOVE.W    #$0F00,COLOR00(a0)       ; Set background color to red
        MOVE.W    #$0FF0,COLOR01(a0)       ; Set color register 1 to yellow
;
; Fill bitplane with $FF00FF00 to produce stripes
;
        MOVE.L    #$21000,a1                ; Point at beginning of bitplane
        MOVE.L    #$FF00FF00,d0            ; We will write $FF00FF00 long words
        MOVE.W    #2000,d1                  ; 2000 long words = 8000 bytes
;
LOOP:   MOVE.L    d0,(a1)+                  ; Write a long word
        DBRA     d1,LOOP                    ; Decrement counter and loop until done...
;
; Set up Copper list at $20000
;
        MOVE.L    #$20000,a1                ; Point at Copper list destination
        LEA     COPPERL(pc),a2              ; Point a2 at Copper list data
CLOOP: MOVE.L    (a2),(a1)+                  ; Move a word
        CMPI.L  #$FFFFFFFE,(a2)+           ; Check for last longword of Copper list
        BNE     CLOOP                       ; Loop until entire copper list is moved
;
; Point Copper at Copper list
;
        MOVE.L    #$20000,COP1LCH(a0)      ; Write to Copper location register
        MOVE.W    COPJMP1(a0),d0           ; Force copper to $20000
;
; Start DMA
;
        MOVE.W    #(DMAF_SETCLR!DMAF_COPPER!DMAF_RASTER!DMAF_MASTER),DMACON(a0)
        ; Enable bitplane and Copper DMA
        BRA     ....                        ; Go do next task
;
; This is the data for the Copper list.
;
COPPERL:
        DC.W    BPL1PTH,$0002              ; Move $0002 to address $0E0 (BPL1PTH)
        DC.W    BPL1PTL,$1000              ; Move $1000 to address $0E2 (BPL1PTL)
        DC.W    $FFFF,$FFFE               ; End of Copper list
;
```

The second example sets up a high resolution, interlaced display with one bitplane. This example also relies on the include file "hw\_examples.i", which is found in Appendix I.

```

        LEA     CUSTOM,a0           ; Address of custom chips
        MOVE.W  #$9204,BPLCON0(a0) ; Hires, one bitplane, interlaced
        MOVE.W  #0,BPLCON1(a0)    ; Horizontal scroll value = 0
        MOVE.W  #80,BPL1MOD(a0)   ; Modulo = 80 for odd bitplanes
        MOVE.W  #80,BPL2MOD(a0)   ; Ditto for even bitplanes
        MOVE.W  #$003C,DDFSTRT(a0) ; Set data-fetch start for Hires
        MOVE.W  #$00D4,DDFSTOP(a0) ; Set data-fetch stop
        MOVE.W  #$2C81,DIWSTRT(a0) ; Set display window start
        MOVE.W  #$F4C1,DIWSTOP(a0) ; Set display window stop
;
; Set up color registers
;
        MOVE.W  #$000F,COLOR0(a0) ; Background color = blue
        MOVE.W  #$0FFF,COLOR01(a0) ; Foreground color = white
;
; Set up bitplane at $20000
;
        LEA     $20000,a1         ; Point a1 at bitplane
        LEA     CHARLIST(pc),a2   ; a2 points at character data
        MOVE.W  #400,d1          ; Write 400 lines of data
        MOVE.W  #20,d0           ; Write 20 long words per line
L1:
        MOVE.L  (a2),(a1)+        ; Write a long word
        DBRA   d0,L1             ; Decrement counter and loop until full...
;
        MOVE.W  #20,d0           ; Reset long word counter
        ADDQ.L  #4,a2            ; Point at next word in char list
        CMPI.L  #$FFFFFFFF,(a2)  ; End of char list?
        BNE    L2
        LEA     CHARLIST(pc),a2  ; Yes, reset a2 to beginning of list
L2:
        DBRA   d1,L1             ; Decrement line counter and loop until done...
;
; Start DMA
;
        MOVE.W  #(DMAF_SETCLR!DMAF_RASTER!DMAF_MASTER),DMACON(a0)
                                   ; Enable bitplane DMA only, no Copper
;
; Because this example has no Copper list, it sits in a loop waiting
; for the vertical blanking interval. When it comes, you check the LOF
; ( long frame ) bit in VPOSr. If LOF = 0, this is a short frame and the
; bitplane pointers are set to point to $20050. If LOF = 1, then this is
; a long frame and the bitplane pointers are set to point to $20000. This
; keeps the long and short frames in the right relationship to each other.
VLOOP:
        MOVE.W  INTREQr(a0),d0    ; Read interrupt requests
        AND.W   #$0020,d0        ; Mask off all but vertical blank
        BEQ    VLOOP             ; Loop until vertical blank comes
        MOVE.W  #$0020,INTREQ(a0) ; Reset vertical interrupt
        MOVE.W  VPOSr(a0),d0     ; Read LOF bit into d0 bit 15
        BPL    VL1              ; If LOF = 0, jump
        MOVE.L  #$20000,BPL1PTH(a0) ; LOF = 1, point to $20000
        BRA    VLOOP            ; Back to top
VL1:
        MOVE.L  #$20050,BPL1PTH(a0) ; LOF = 0, point to $20050
        BRA    VLOOP            ; Back to top
;
; Character list

```



```
;
CHARLIST:
DC.L    $18FC3DF0, $3C6666D8, $3C66C0CC, $667CC0CC
DC.L    $7E66C0CC, $C36666D8, $C3FC3DF0, $00000000
DC.L    $FFFFFFFF
```

## Forming a Dual-playfield Display

For more flexibility in designing your background display, you can specify two playfields instead of one. In dual-playfield mode, one playfield is displayed directly in front of the other. For example, a computer game display might have some action going on in one playfield in the background, while the other playfield is showing a control panel in the foreground. You can then change either the foreground or the background without having to redesign the entire display. You can also move the two playfields independently.

A dual-playfield display is similar to a single-playfield display, differing only in these aspects:

- Each playfield in a dual display is formed from one, two or three bitplanes.
- The colors in each playfield (up to seven plus transparent) are taken from different sets of color registers.
- You must set a bit to activate dual-playfield mode.

Figure 3-12 shows a dual-playfield display.

In Figure 3-12, one of the colors in each playfield is “transparent” (color 0 in playfield 1 and color 8 in playfield 2). You can use transparency to allow selected features of the background playfield to show through.

In dual-playfield mode, each playfield is formed from up to three bitplanes. Color registers 0 through 7 are assigned to playfield 1, depending upon how many bitplanes you use. Color registers 8 through 15 are assigned to playfield 2.

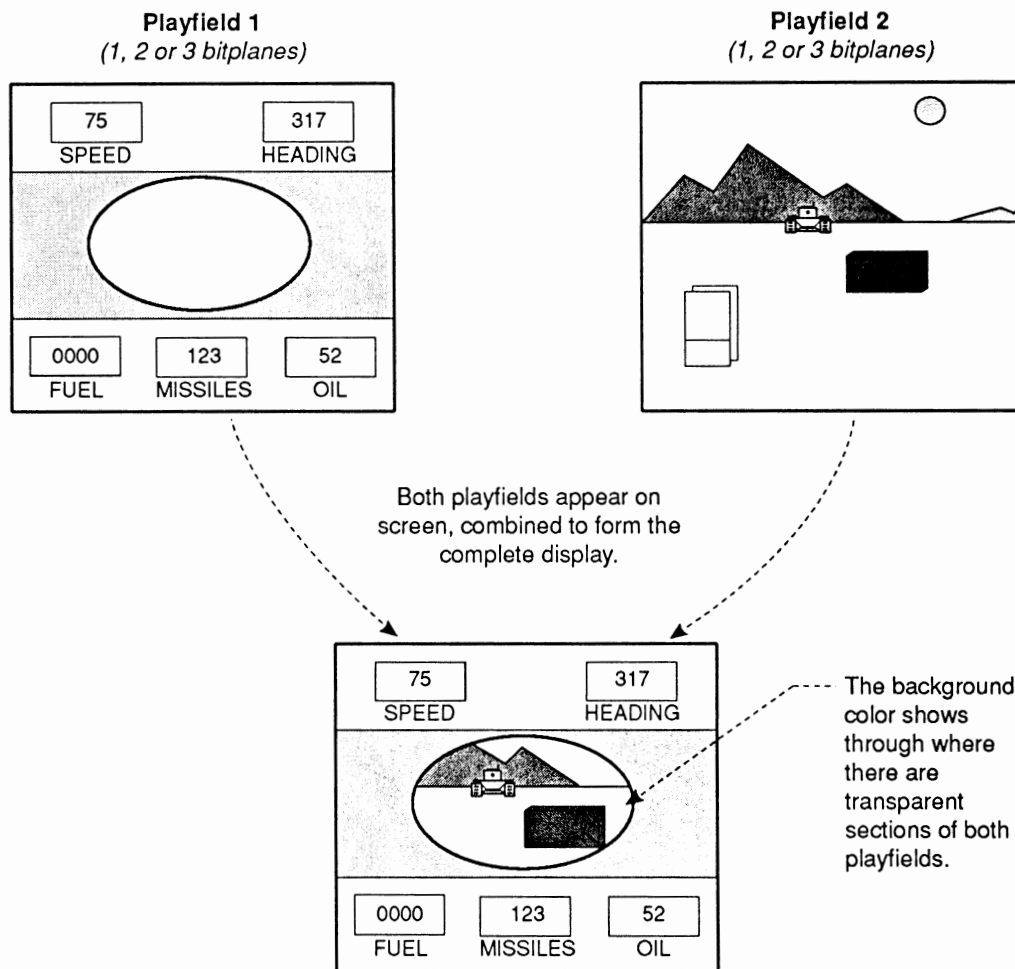



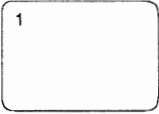
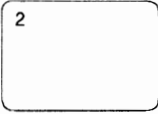

Figure 3-12: A Dual-playfield Display

### BITPLANE ASSIGNMENT IN DUAL-PLAYFIELD MODE

The three odd-numbered bitplanes (1, 3, and 5) are grouped together by the hardware and may be used in playfield 1. Likewise, the three even-numbered bitplanes (2, 4, and 6) are grouped together and may be used in playfield 2. The bitplanes are assigned alternately to each playfield, as shown in Figure 3-13.

*About dual-playfield bitplanes.* In high resolution mode, you can have up to two bitplanes in each playfield — bitplanes 1 and 3 in playfield 1 and bitplanes 2 and 4 in playfield 2.

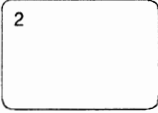
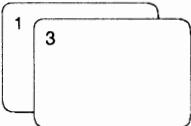
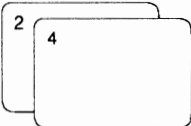
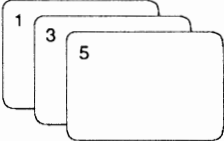
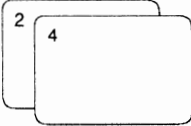
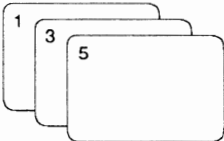
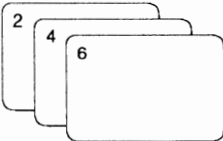

Number of bitplanes "turned on."	Playfield 1 *	Playfield 2 *
0	none	none
1		
2		
3		
4		
5		
6		

\* Note: Either playfield may be placed "in front of" or "behind" the other using the "swap-bit."

Figure 3-13: How Bitplanes Are Assigned to Dual Playfields

---

## COLOR REGISTERS IN DUAL-PLAYFIELD MODE

When you are using dual playfields, the hardware interprets color numbers for playfield 1 from the bit combinations of bitplanes 1, 3, and 5. Bits from PLANE 5 have the highest significance and form the most significant digit of the color register number. Bits from PLANE 0 have the lowest significance. These bit combinations select the first eight color registers from the color palette as shown in Table 3-10.

PLAYFIELD 1	
Bit Combination	Color Selected
000	Transparent mode
001	COLOR1
010	COLOR2
011	COLOR3
100	COLOR4
101	COLOR5
110	COLOR6
111	COLOR7

Table 3-10: Playfield 1 Color Registers — Low resolution Mode

The hardware interprets color numbers for playfield 2 from the bit combinations of bitplanes 2, 4, and 6. Bits from PLANE 6 have the highest significance. Bits from PLANE 2 have the lowest significance. These bit combinations select the color registers from the second eight colors in the color table as shown in Table 3-11.

PLAYFIELD 2	
Bit Combination	Color Selected
000	Transparent mode
001	COLOR9
010	COLOR10
011	COLOR11
100	COLOR12
101	COLOR13
110	COLOR14
111	COLOR15

Table 3-11: Playfield 2 Color Registers — Low resolution Mode

---

Combination 000 selects transparent mode, to show the color of whatever object (the other playfield, a sprite, or the background color) may be “behind” the playfield.

Table 3-12 shows the color registers for high resolution, dual-playfield mode.

<b>PLAYFIELD 1</b>	
<b>Bit Combination</b>	<b>Color Selected</b>
00	Transparent mode
01	COLOR1
10	COLOR2
11	COLOR3

<b>PLAYFIELD 2</b>	
<b>Bit Combination</b>	<b>Color Selected</b>
00	Transparent mode
01	COLOR9
10	COLOR10
11	COLOR11

Table 3-12: Playfields 1 and 2 Color Registers — High resolution Mode

## **DUAL-PLAYFIELD PRIORITY AND CONTROL**

Either playfield 1 or 2 may have priority; that is, either one may be displayed in front of the other. Playfield 1 normally has priority. The bit known as PF2PRI (bit 6) in register BPLCON2 is used to control priority. When PF2PRI = 1, playfield 2 has priority over playfield 1. When PF2PRI = 0, playfield 1 has priority.

You can also control the relative priority of playfields and sprites. Chapter 7, “System Control Hardware,” shows you how to control the priority of these objects.

You can control the two playfields separately as follows:

- They can have different-sized representations in memory, and different portions of each one can be selected for display.
- They can be scrolled separately.

---

*An important warning.* You must take special care when scrolling one playfield and holding the other stationary. When you are scrolling low resolution playfields, you must fetch one word more than the width of the playfield you are trying to scroll (two words more in high resolution mode) in order to provide some data to display when the actual scrolling takes place. Only one data-fetch start register and one data-fetch stop register are available, and these are shared by both playfields. If you want to scroll one playfield and hold the other, you must adjust the data-fetch start and data-fetch stop to handle the playfield being scrolled. Then, you must adjust the modulo and the bitplane pointers of the playfield that is *not* being scrolled to maintain its position on the display. In low resolution mode, you adjust the pointers by -2 and the modulo by -2. In high resolution mode, you adjust the pointers by -4 and the modulo by -4.

## ACTIVATING DUAL-PLAYFIELD MODE

Writing a 1 to bit 10 (called DBLPF) of the bitplane control register BPLCON0 selects dual-playfield mode. Selecting dual-playfield mode changes both the way the hardware groups the bitplanes for color interpretation—all odd-numbered bitplanes are grouped together and all even-numbered bitplanes are grouped together, and the way hardware can move the bitplanes on the screen.

## DUAL PLAYFIELD SUMMARY

The steps for defining dual playfields are almost the same as those for defining the basic playfield. Only in the following steps does the dual-playfield creation process differ from that used for the basic playfield:

- **Loading colors into the registers.** Keep in mind that color registers 0-7 are used by playfield 1 and registers 8 through 15 are used by playfield 2 (if there are three bitplanes in each playfield).
- **Building bitplanes.** Recall that playfield 1 is formed from PLANES 1, 3, and 5 and playfield 2 from PLANES 2, 4, and 6.
- **Setting the modulo registers.** Write the modulo to both BPL1MOD and BPL2MOD as you will be using both odd- and even-numbered bitplanes.

These steps are added:

- **Defining priority.** If you want playfield 2 to have priority, set bit 6 (PF2PRI) in BPLCON2 to 1.
- **Activating dual-playfield mode.** Set bit 10 (DBLPF) in BPLCON0 to 1.

---

## Bitplanes and Display Windows of All Sizes

You have seen how to form single and dual playfields in which the playfield in memory is the same size as the display window. This section shows you how to define and use a playfield whose big picture in memory is larger than the display window, how to define display windows that are larger or smaller than the normal playfield size, and how to move the display window in the big picture.

### WHEN THE BIG PICTURE IS LARGER THAN THE DISPLAY WINDOW

If you design a memory picture larger than the display window, you must choose which part of it to display. Displaying a portion of a larger playfield differs in the following ways from displaying the basic playfields described up to now:

- If the big picture in memory is larger than the display window, you must respecify the modulus. The modulo must be some value other than 0.
- You must allocate more memory for the larger memory picture.

#### *Specifying the Modulo*

For a memory picture wider than the display window, you need to respecify the modulo so that the correct data words are fetched for each line of the display. As an example, assume the display window is the standard 320 pixels wide, so 40 bytes are to be displayed on each line. The big picture in memory, however, is exactly twice as wide as the display window, or 80 bytes wide. Also, assume that you wish to display the left half of the big picture. Figure 3-14 shows the relationship between the big picture and the picture to be displayed.

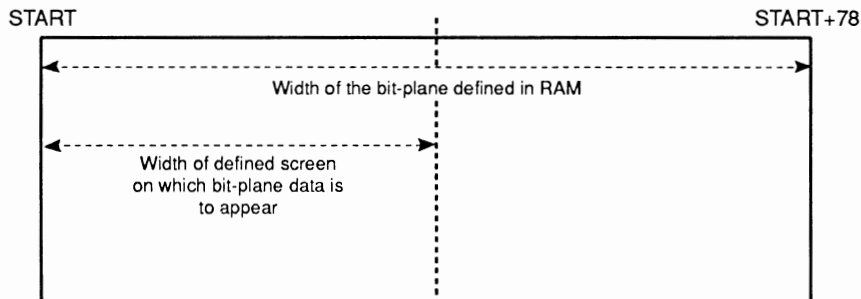

Figure 3-14: Memory Picture Larger than the Display

Because 40 bytes are to be fetched for each line, the data fetch for line 1 is as shown in Figure 3-15.

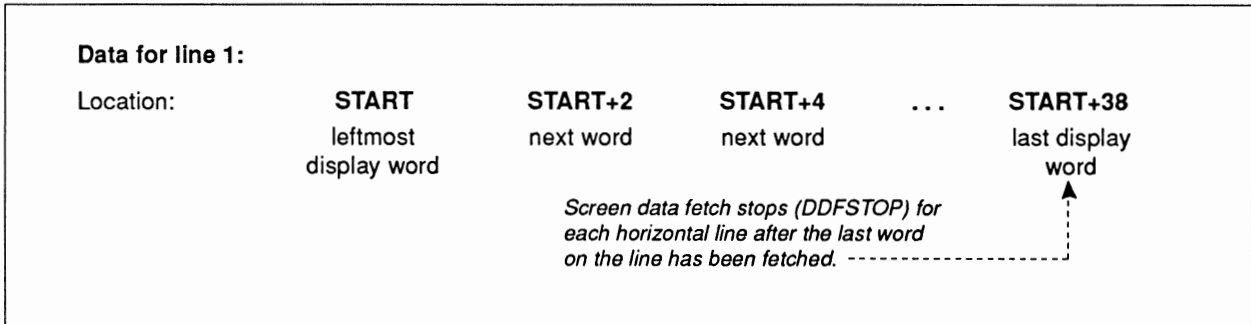

Figure 3-15: Data Fetch for the First Line When Modulo = 40

At this point, BPLxPTH and BPLxPTL contain the value START+40. The modulo, which is 40, is added to the current value of the pointer so that when it begins the data fetch for the next line, it fetches the data that you intend for that line. The data fetch for line 2 is shown in Figure 3-16.

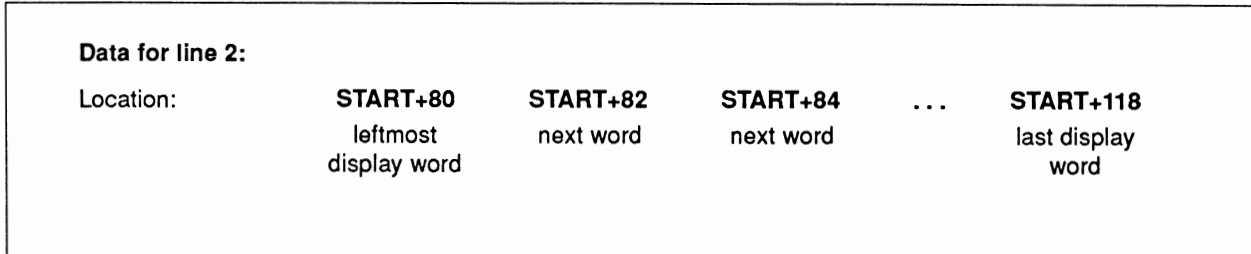

Figure 3-16: Data Fetch for the Second Line When Modulo = 40



---

To display the right half of the big picture, you set up a vertical blanking routine to start the bitplane pointers at location `START+40` rather than `START` with the modulo remaining at 40. The data layout is shown in Figures 3-17 and 3-18.

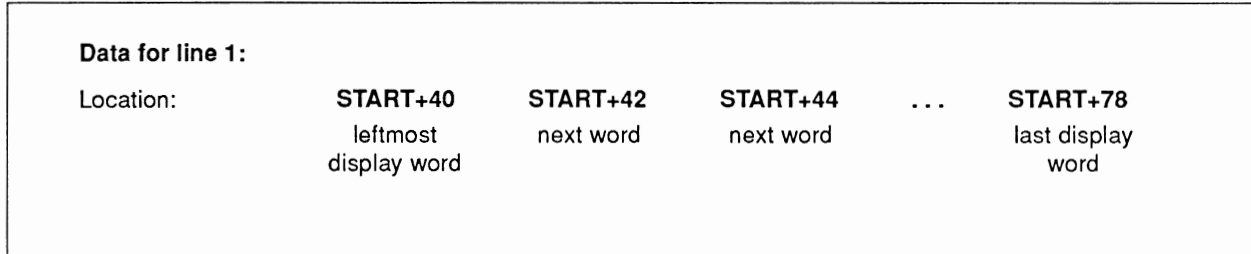

Figure 3-17: Data Layout for First Line—Right Half of Big Picture

Now, the bitplane pointers contain the value `START+80`. The modulo (40) is added to the pointers so that when they begin the data fetch for the second line, the correct data is fetched.

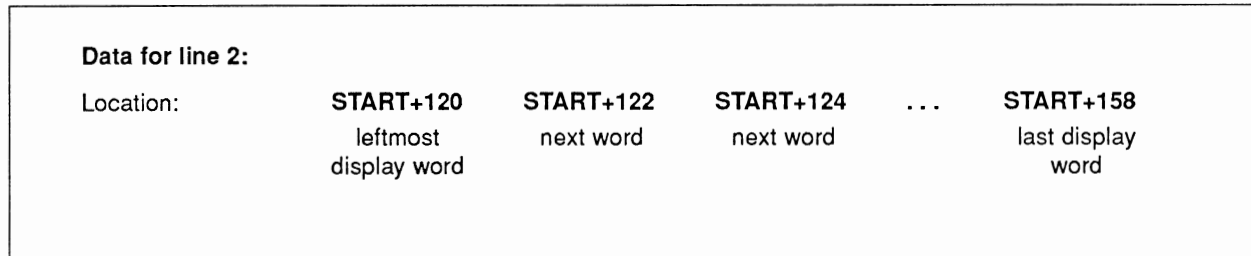

Figure 3-18: Data Layout for Second Line—Right Half of Big Picture

Remember, in high resolution mode, you need to fetch twice as many bytes as in low resolution mode. For a normal-sized display, you fetch 80 bytes for each horizontal line instead of 40.

---

### ***Specifying the Data Fetch***

The data-fetch registers specify the beginning and end positions for data placement on each horizontal line of the display. You specify data fetch in the same way as shown in the section called "Forming a Basic Playfield."

### ***Memory Allocation***

For larger memory pictures, you need to allocate more memory. Here is a formula for calculating memory requirements in general:

$$\text{bytes per line} * \text{lines in playfield} * \text{\# of bitplanes}$$

The number of bytes must be even. Thus, if the wide playfield described in this section is formed from two bitplanes, it requires:

$$80 * 200 * 2 = 32,000 \text{ bytes of memory}$$

Recall that this is the memory requirement for the playfield alone. You need more memory for any sprites, animation, audio, or application programs you are using.

The amount of Chip memory is one of the basic constraints on the size of playfields. For instance, a playfield 2000 by 2000 pixels with five bitplanes would exceed even the two megabytes of Chip memory possible on an Amiga 3000. Another constraint on playfield size is the bit plane modulus which limit the width (but not the height) of a playfield to 262,144 pixels.

As a practical matter, the blitter size registers also limit the size of playfields (unless the 680x0 CPU is used for drawing operations). With the original chip set the largest area the blitter can draw in is 1008 by 1024. With the Enhanced Chip Set (ECS), the largest area the blitter can draw in is increased to 16368 by 16384 pixels. For more information on ECS and blitter limits refer to "Appendix C, Enhanced Chip Set".

### ***Selecting the Display Window Starting Position***

The display window starting position is the horizontal and vertical coordinates of the upper left-hand corner of the display window. One register, DIWSTRT, holds both the horizontal and vertical coordinates, known as HSTART and VSTART. The eight bits allocated to HSTART are assigned to the first 256 positions, counting from the leftmost possible position. Thus, you can start the display window at any pixel position within this range.

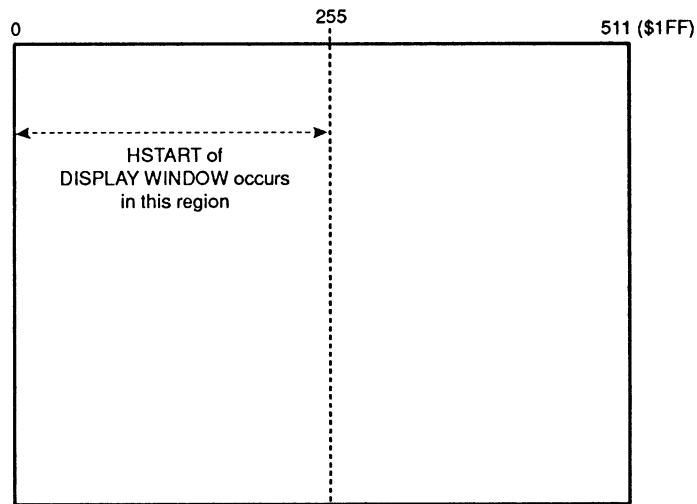

Figure 3-19: Display Window Horizontal Starting Position

The eight bits allocated to VSTART are assigned to the first 256 positions counting down from the top of the display.

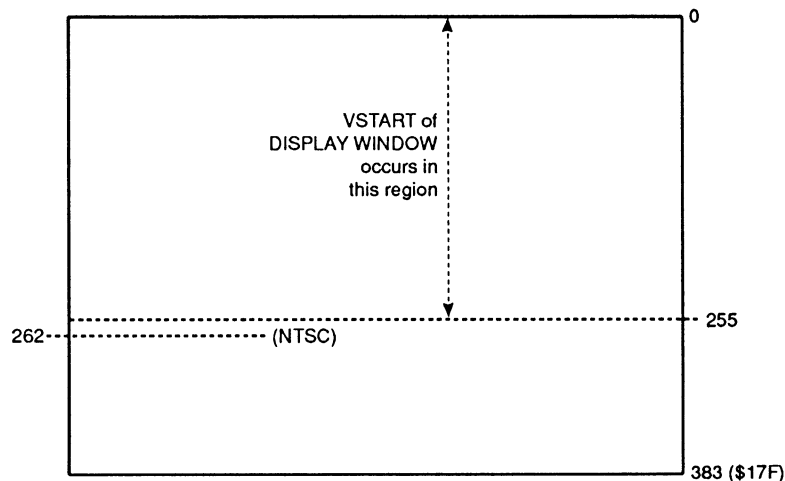

Figure 3-20: Display Window Vertical Starting Position

Recall that you select the values for the starting position as if the display were in low resolution, non-interlaced mode. Keep in mind, though, that for interlaced mode the display window should be an even number of lines in height to allow for equal-sized odd and even fields.

To set the display window starting position, write the value for HSTART into bits 0 through 7 and the value for VSTART into bits 8 through 15 of DIWSTRT.

---

### **Selecting the Stopping Position**

The stopping position for the display window is the horizontal and vertical coordinates of the lower right-hand corner of the display window. One register, DIWSTOP, contains both coordinates, known as HSTOP and VSTOP.

See the notes in the “Forming a Basic Playfield” section for instructions on setting these registers.

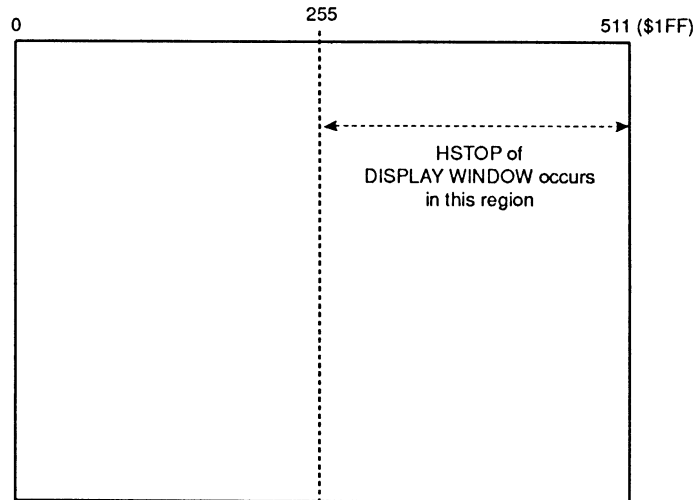

Figure 3-21: Display Window Horizontal Stopping Position

Select a value that represents the correct position in low resolution, non-interlaced mode.

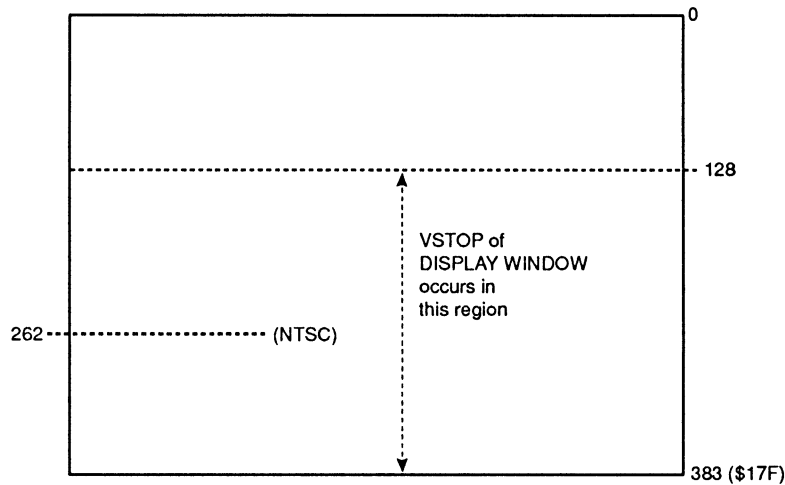

Figure 3-22: Display Window Vertical Stopping Position

To set the display window stopping position, write HSTOP into bits 0 through 7 and VSTOP into bits 8 through 15 of DIWSTOP.

### MAXIMUM DISPLAY WINDOW SIZE

The maximum size of a playfield display is determined by the maximum number of lines and the maximum number of columns. Vertically, the restrictions are simple. No data can be displayed in the vertical blanking area. The following table shows the allowable vertical display area.

	NTSC		PAL	
Vertical Blank Start	0		0	
Vertical Blank Stop	\$15 (21)		\$1D (29)	
	<b>NTSC</b>	<b>NTSC</b>	<b>PAL</b>	<b>PAL</b>
	<b>Normal</b>	<b>Interlaced</b>	<b>Normal</b>	<b>Interlaced</b>
Displayable lines of screen video	241	483 =525-(21*2)	283	567 =625-(29*2)

Table 3-13: Maximum Allowable Vertical Screen Video

Horizontally, the situation is similar. Strictly speaking, the hardware sets a rightmost limit to DDFSTOP of (\$D8) and a leftmost limit to DDFSTRT of (\$18). This gives a maximum of 25 words fetched in low resolution mode. In high resolution mode the maximum here is 49 words, because the rightmost limit remains (\$D8) and only one word is fetched at this limit. However, horizontal blanking actually limits the displayable video to 368 low resolution pixels (23 words). These numbers are the same both for NTSC and for PAL. In addition, it should be noted that using a data-fetch start earlier than (\$38) will disable some sprites.

Table 3-14: Maximum Allowable Horizontal Screen Video

	Lores	Hires
DDFSTRT (standard)	\$0038	\$003C
DDFSTOP (standard)	\$00D0	\$00D4
DDFSTRT (hw limits)	\$0018	\$0018
DDFSTOP (hw limits)	\$00D8	\$00D8
max words fetched	25	49
max display pixels	368 (low res)	

The limits on the display window starting and stopping positions described in this section apply to the Amiga's original custom chip set. In the Enhanced Chip Set (ECS), the limits for playfield display windows have been changed. For more information on ECS and playfield display windows, refer to "Appendix C, Enhanced Chip Set"

## Moving (Scrolling) Playfields

If you want a background display that moves, you can design a playfield larger than the display window and scroll it. If you are using dual playfields, you can scroll them separately.

In vertical scrolling, the playfield appears to move smoothly up or down on the screen. All you need do for vertical scrolling is progressively increase or decrease the starting address for the bitplane pointers by the size of a horizontal line in the playfield. This has the effect of showing a lower or higher part of the picture each field time.

In horizontal scrolling the playfield appears to move from right-to-left or left-to-right on the screen. Horizontal scrolling works differently from vertical scrolling — you must arrange to fetch one more word of data for each display line and delay the display of this data.

For either type of scrolling, resetting of pointers or data-fetch registers can be handled by the Copper during the vertical blanking interval.

## VERTICAL SCROLLING

You can scroll a playfield upward or downward in the window. Each time you display the playfield, the bitplane pointers start at a progressively higher or lower place in the big picture in memory. As the value of the pointer increases, more of the lower part of the picture is shown and the picture appears to scroll upward. As the value of the pointer decreases, more of the upper part is shown and the picture scrolls downward. On an NTSC system, with a display that has 200 vertical lines, each step can be as little as 1/200th of the screen. In interlaced mode each step could be 1/400th of the screen if clever manipulation of the pointers is used, but it is recommended that scrolling be done two lines at a time to maintain the odd/even field relationship. Using a PAL system with 256 lines on the display, the step can be 1/256th of a screen, or 1/512th of a screen in interlace.

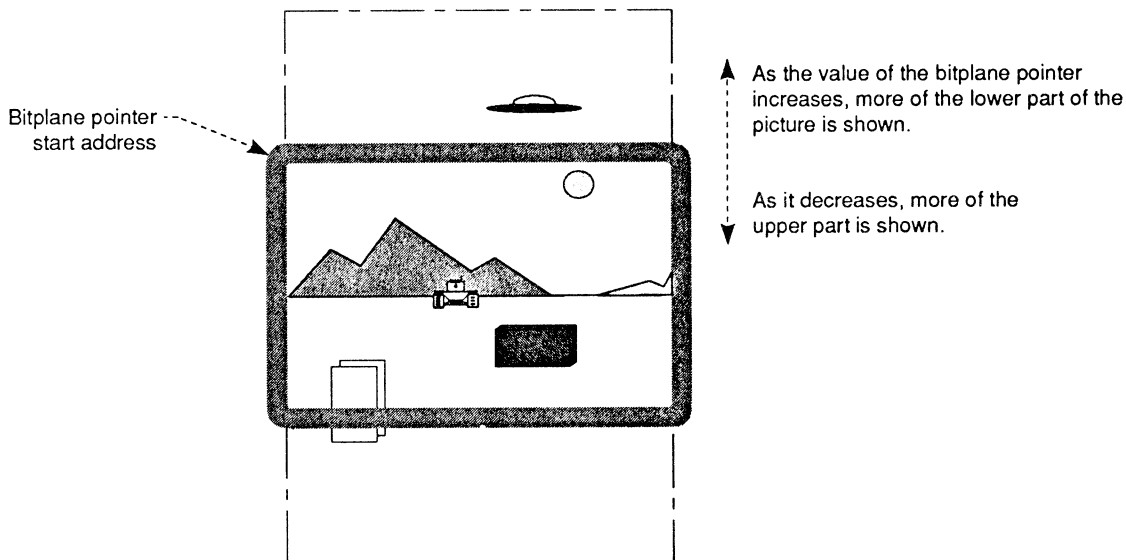

Figure 3-23: Vertical Scrolling

To set up a playfield for vertical scrolling, you need to form bitplanes tall enough to allow for the amount of scrolling you want, write software to calculate the bitplane pointers for the scrolling you want, and allow for the Copper to use the resultant pointers.

Assume you wish to scroll a playfield upward one line at a time. To accomplish this, before each field is displayed, the bitplane pointers have to increase by enough to ensure that the pointers begin one line lower each time. For a normal-sized, low resolution display in which the modulo is 0, the pointers would be incremented by 40 bytes each time.

---

## HORIZONTAL SCROLLING

You can scroll playfields horizontally from left to right or right to left on the screen. You control the speed of scrolling by specifying the amount of delay in pixels. Delay means that an extra word of data is fetched but not immediately displayed. The extra word is placed just to the left of the window's leftmost edge and before normal data fetch. As the display shifts to the right, the bits in this extra word appear on-screen at the left-hand side of the window as bits on the right-hand side disappear off-screen. For each pixel of delay, the on-screen data shifts one pixel to the right each display field. The greater the delay, the greater the speed of scrolling. You can have up to 15 pixels of delay. In high resolution mode, scrolling is in increments of 2 pixels. Figure 3-24 shows how the delay and extra data fetch combine to cause the scrolling effect.

To set up a playfield for horizontal scrolling, you need to

- Define bitplanes wide enough to allow for the scrolling you need.
- Set the data-fetch registers to correctly place each horizontal line, including the extra word, on the screen.
- Set the delay bits.
- Set the modulo so that the bitplane pointers begin at the correct word for each line.
- Write Copper instructions to handle the changes during the vertical blanking interval.

### ***Specifying Data Fetch in Horizontal Scrolling***

The normal data-fetch start for non-scrolled displays is (\$38). If horizontal scrolling is desired, then the data fetch must start one word sooner (DDFSTRT = \$0030). Incidentally, this will disable sprite 7. DDFSTOP remains unchanged. Remember that the settings of the data-fetch registers affect both playfields.

### ***Specifying the Modulo in Horizontal Scrolling***

As always, the modulo is two counts less than the difference between the address of the next word you want to fetch and the address of the last word that was fetched. As an example for horizontal scrolling, let us assume a 40-byte display in an 80-byte "big picture." Because horizontal scrolling requires a data fetch of two extra bytes, the data for each line will be 42 bytes long.



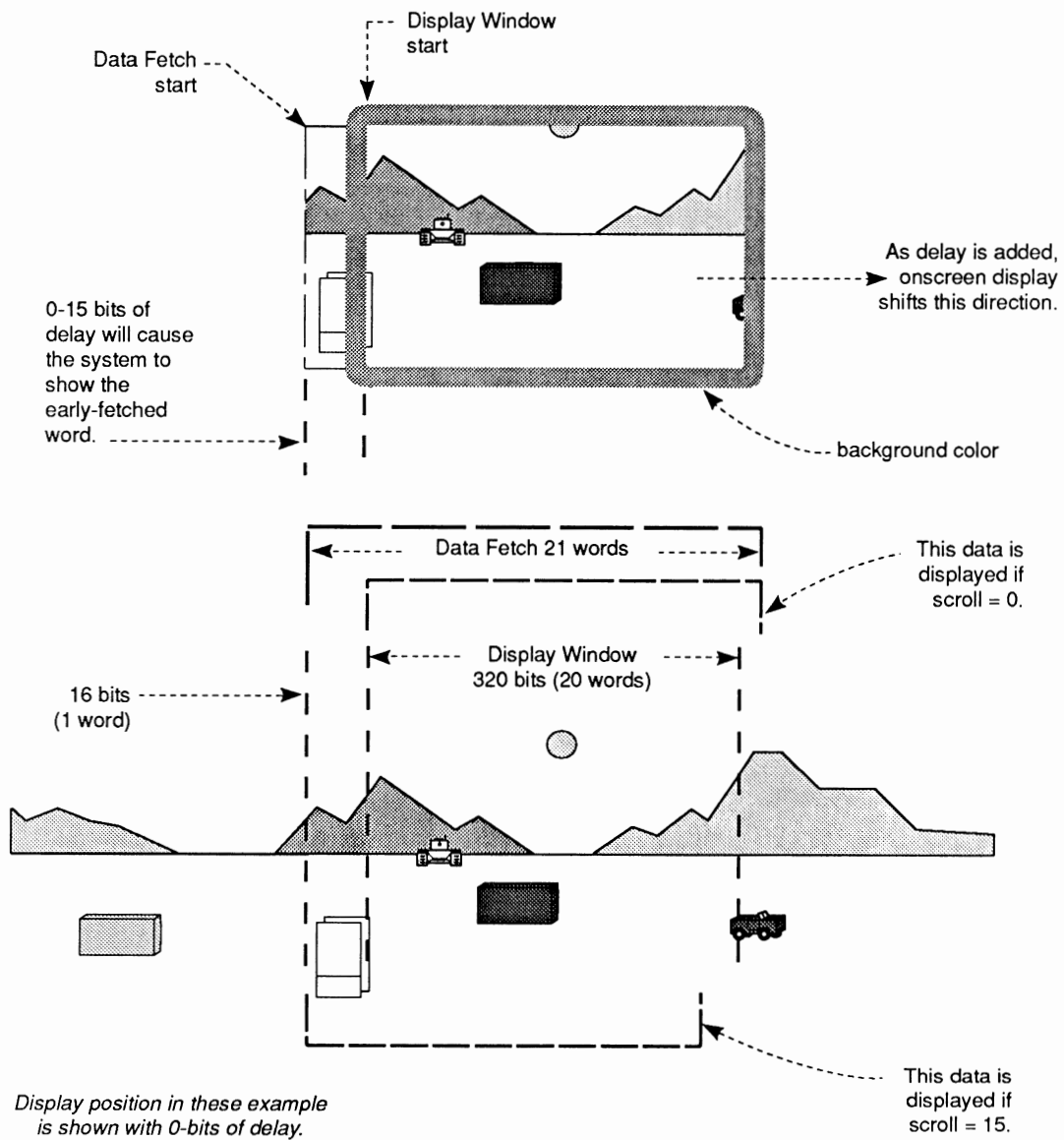

Figure 3-24: Horizontal Scrolling

**NOTE:** Fetching an extra word for scrolling will disable some sprites.

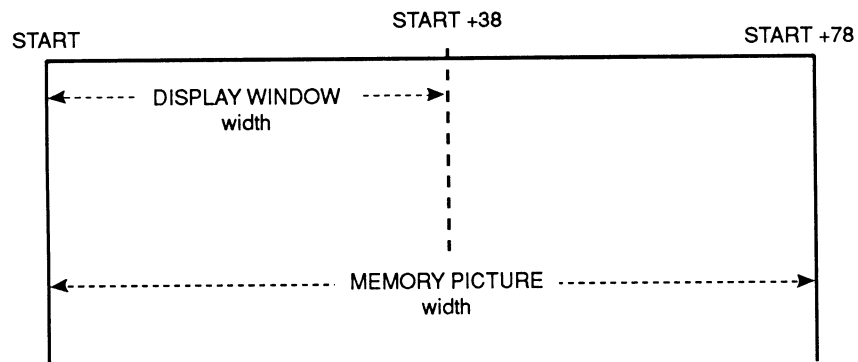

Figure 3-25: Memory Picture Larger Than the Display Window

<b>Data for line 1:</b>					
Location:	<b>START</b>	<b>START+2</b>	<b>START+4</b>	...	<b>START+40</b>
	leftmost display word	next word	next word		last display word

Figure 3-26: Data for Line 1 - Horizontal Scrolling

At this point, the bitplane pointers contain the value  $START+42$ . Adding the modulo of 38 gives the correct starting point for the next line.

<b>Data for line 2:</b>					
Location:	<b>START+80</b>	<b>START+82</b>	<b>START+84</b>	...	<b>START+120</b>
	leftmost display word	next word	next word		last display word

Figure 3-27: Data for Line 2—Horizontal Scrolling

In the  $BPLxMOD$  registers you set the modulo for each bitplane used.

---

### ***Specifying Amount of Delay***

The amount of delay in horizontal scrolling is controlled by bits 7-0 in BPLCON1. You set the delay separately for each playfield; bits 3-0 for playfield 1 (bitplanes 1, 3, and 5) and bits 7-4 for playfield 2 (bitplanes 2, 4, and 6).

*Warning:* Always set all six bits, even if you have only one playfield. Set 3-0 and 7-4 to the same value if you are using only one playfield.

The following example sets the horizontal scroll delay to 7 for both playfields.

```
MOVE.W  #$77,BPLCON1+CUSTOM
```

### **SCROLLING PLAYFIELD SUMMARY**

The steps for defining a scrolled playfield are the same as those for defining the basic playfield, except for the following steps:

- **Defining the data fetch.** Fetch one extra word per horizontal line and start it 16 pixels before the normal (unscrolled) data-fetch start.
- **Defining the modulo.** The modulo is two counts less than when there is no scrolling.

These steps are added:

- **For vertical scrolling, reset the bitplane pointers for the amount of the scrolling increment.** Reset BPLxPTH and BPLxPTL during the vertical blanking interval.
- **For horizontal scrolling, specify the delay.** Set bits 7-0 in BPLCON1 for 0 to 15 bits of delay.

---

## Advanced Topics

This section describes features that are used less often or are optional.

### INTERACTIONS AMONG PLAYFIELDS AND OTHER OBJECTS

Playfields share the display with sprites. Chapter 7, “System Control Hardware,” shows how playfields can be given different video display priorities relative to the sprites and how playfields can collide with (overlap) the sprites or each other.

### HOLD-AND-MODIFY MODE

This is a special mode that allows you to produce up to 4,096 colors on the screen at the same time. Normally, as each value formed by the combination of bitplanes is selected, the data contained in the selected color register is loaded into the color output circuit for the pixel being written on the screen. Therefore, each pixel is colored by the contents of the selected color register.

In hold-and-modify mode, however, the value in the color output circuitry is held, and one of the three components of the color (red, green, or blue) is modified by bits coming from certain preselected bitplanes. After modification, the pixel is written to the screen.

The hold-and-modify mode allows very fine gradients of color or shading to be produced on the screen. For example, you might draw a set of 16 vases, each a different color, using all 16 colors in the color palette. Then, for each vase, you use hold-and-modify to very finely shade or highlight or add a completely different color to each of the vases. Note that a particular hold-and-modify pixel can only change one of the three color values at a time. Thus, the effect has a limited control.

In hold and modify mode, you use all six bitplanes. Planes 5 and 6 are used to modify the way bits from planes 1 - 4 are treated, as follows:

- If the 6-5 bit combination from planes 6 and 5 for any given pixel is 00, normal color selection procedure is followed. Thus, the bit combinations from planes 4 - 1, in that order of significance, are used to choose one of 16 color registers (registers 0 - 15).

If only five bitplanes are used, the data from the sixth plane is automatically supplied with the value as 0.

- If the 6-5 bit combination is 01, the color of the pixel immediately to the left of this pixel is duplicated and then modified. The bit combinations from planes 4 - 1 are used to replace the four “blue” bits in the corresponding color register.

- If the 6-5 bit combination is 10, the color of the pixel immediately to the left of this pixel is duplicated and then modified. The bit combinations from planes 4 - 1 are used to replace the four “red” bits.
- If the 6-5 bit combination is 11, the color of the pixel immediately to the left of this pixel is duplicated and then modified. The bit combinations from planes 4 - 1 are used to replace the four “green” bits.

Using hold-and-modify mode, it is possible to get by with defining only *one* color register, which is COLOR0, the color of the background. You treat the entire screen as a modification of that original color, according to the scheme above.

Bit 11 of register BPLCON0 selects hold-and-modify mode. The following bits in BPLCON0 must be set for hold-and-modify mode to be active:

- Bit HOMOD, bit 11, is 1.
- Bit DBLPF, bit 10, is 0 (single-playfield mode specified).
- Bit HIRES, bit 15, is 0 (low resolution mode specified).
- Bits BPU2, BPU1, and BPU0 - bits 14, 13, and 12, are 101 or 110 (five or six bitplanes active).

The following example code generates a six-bitplane display with hold-and-modify mode turned on. All 32 color registers are loaded with black to prove that the colors are being generated by hold-and-modify. The equates are the usual and are not repeated here.

```
; First, set up the control registers.
;
    LEA    CUSTOM,a0                ; Point a0 at custom chips
    MOVE.W #0,BPLCON0(a0)          ; Six bitplanes, hold-and-modify mode
    MOVE.W #0,BPLCON1(a0)          ; Horizontal scroll = 0
    MOVE.W #0,BPL1MOD(a0)          ; Modulo for odd bitplanes = 0
    MOVE.W #0,BPL2MOD(a0)          ; Ditto for even bitplanes
    MOVE.W #0,DDFSTRT(a0)          ; Set data-fetch start
    MOVE.W #0,DDFSTOP(a0)          ; Set data-fetch stop
    MOVE.W #0,DIWSTRT(a0)          ; Set display window start
    MOVE.W #0,DIWSTOP(a0)          ; Set display window stop
;
; Set all color registers = black to prove that hold-and-modify mode is working.
;
    MOVE.W #0,d0                    ; Initialize counter
    LEA    CUSTOM+COLOR0,a1         ; Point a1 at first color register
CREGLOOP:
    MOVE.W #0,(a1)+                 ; Write black to a color register
    DBRA  d0,CREGLOOP              ; Decrement counter and loop til done...
;
; Fill six bitplanes with an easily recognizable pattern.
;
; NOTE: This is just for example use. Normally these bitplanes would
;       need to be allocated from the system MEMF_CHIP memory pool.
;
```

```

MOVE.W #2000,d0 ; 2000 longwords per bitplane
MOVE.L #21000,a1 ; Point a1 at bitplane 1
MOVE.L #23000,a2 ; Point a2 at bitplane 2
MOVE.L #25000,a3 ; Point a3 at bitplane 3
MOVE.L #27000,a4 ; Point a4 at bitplane 4
MOVE.L #29000,a5 ; Point a5 at bitplane 5
MOVE.L #2B000,a6 ; Point a6 at bitplane 6
FPLLOOP:
MOVE.L #55555555,(a1)+ ; Fill bitplane 1 with 55555555
MOVE.L #33333333,(a2)+ ; Fill bitplane 2 with 33333333
MOVE.L #0F0F0F0F,(a3)+ ; Fill bitplane 3 with 0F0F0F0F
MOVE.L #00FF00FF,(a4)+ ; Fill bitplane 4 with 00FF00FF
MOVE.L #3CF3CF3C,(a5)+ ; Fill bitplane 5 with 3CF3CF3C
MOVE.L #3CF3CF3C,(a6)+ ; Fill bitplane 6 with 3CF3CF3C
DBRA d0,FPLLOOP ; Decrement counter and loop til done...
;
; Set up a Copper list at $20000.
;
; NOTE: As with the bitplanes, the copper list location should be allocated
; from the system MEMF_CHIP memory pool.
;
MOVE.L #20000,a1 ; Point a1 at Copper list destination
LEA COPPERL(pc),a2 ; Point a2 at Copper list image
CLOOP: MOVE.L (a2),(a1)+ ; Move a long word...
CMPI.L #FFFFFFFE,(a2)+ ; Check for end of Copper list
BNE CLOOP ; Loop until entire Copper list moved
;
; Point Copper at Copper list.
;
MOVE.L #20000,COP1LCH(a0) ; Load Copper jump register
MOVE.W COPJMP1(a0),d0 ; Force load into Copper P.C.
;
; Start DMA.
;
MOVE.W #8380,DMACON(a0) ; Enable bitplane and Copper DMA
;
BRA .....next stuff to do.....
;
; Copper list for six bitplanes. Bitplane 1 is at $21000; 2 is at $23000;
; 3 is at $25000; 4 is at $27000; 5 is at $29000; 6 is at $2B000.
;
; NOTE: These bitplane addresses are for example purposes only.
; See note above.
;
COPPERL:
DC.W BPL1PTH,$0002 ; Bitplane 1 pointer = $21000
DC.W BPL1PTL,$1000
DC.W BPL2PTH,$0002 ; Bitplane 2 pointer = $23000
DC.W BPL2PTL,$3000
DC.W BPL3PTH,$0002 ; Bitplane 3 pointer = $25000
DC.W BPL3PTL,$5000
DC.W BPL4PTH,$0002 ; Bitplane 4 pointer = $27000
DC.W BPL4PTL,$7000
DC.W BPL5PTH,$0002 ; Bitplane 5 pointer = $29000
DC.W BPL5PTL,$9000
DC.W BPL6PTH,$0002 ; Bitplane 6 pointer = $2B000
DC.W BPL6PTL,$B000
DC.W $FFFF,$FFFE ; Wait for the impossible, i.e., quit

```

---

## FORMING A DISPLAY WITH SEVERAL DIFFERENT PLAYFIELDS

The graphics library provides the ability to split the screen into several “ViewPorts”, each with its own colors and resolutions. See the *Amiga ROM Kernel Manual: Libraries* for more information.

## USING AN EXTERNAL VIDEO SOURCE

An optional board that provides *genlock* is available for the Amiga. Genlock allows you to bring in your graphics display from an external video source (such as a VCR, camera, or laser disk player). When you use genlock, the background color is replaced by the display from this external video source. For more information, see the instructions furnished with the optional board.

## Summary of Playfield Registers

This section summarizes the registers used in this chapter and the meaning of their bit settings. The color registers are summarized in the next section. See Appendix A for a summary of all registers.

### BPLCON0 - Bitplane Control

(Warning: Bits in this register cannot be independently set.)

Bit 0 - unused

Bit 1 - ERSY (external synchronization enable)

1 = External synchronization enabled (allows genlock synchronization to occur)

0 = External synchronization disabled

Bit 2 - LACE (interlace enable)

1 = interlaced mode enabled

0 = non-interlaced mode enabled

Bit 3 - LPEN (light pen enable)

Bits 4-7 not used (make 0)

Bit 8 - GAUD (genlock audio enable)

1 = Genlock audio enabled

0 = Genlock audio disabled

(This bit also appears on Denise pin ZD during blanking period)

---

Bit 9 - COLOR\_ON (color enable)

- 1 = composite video color-burst enabled
- 0 = composite video color-burst disabled

Bit 10 - DBLPF (double-playfield enable)

- 1 = dual playfields enabled
- 0 = single playfield enabled

Bit 11 - HOMOD (hold-and-modify enable)

- 1 = hold-and-modify enabled
- 0 = hold-and-modify disabled; extra-half brite (EHB) enabled  
if DBLPF=0 and BPUx=6

Bits 14, 13, 12 - BPU2, BPU1, BPU0

Number of bitplanes used.

- 000 = only a background color
- 001 = 1 bitplane, PLANE 1
- 010 = 2 bitplanes, PLANES 1 and 2
- 011 = 3 bitplanes, PLANES 1 - 3
- 100 = 4 bitplanes, PLANES 1 - 4
- 101 = 5 bitplanes, PLANES 1 - 5
- 110 = 6 bitplanes, PLANES 1 - 6
- 111 not used

Bit 15 - HIRES (high resolution enable)

- 1 = high resolution mode
- 0 = low resolution mode

### **BPLCON1 - Bitplane Control**

Bits 3-0 - PF1H(3-0) Playfield 1 delay

Bits 7-4 - PF2H(3-0) Playfield 2 delay

Bits 15-8 not used

### **BPLCON2 - Bitplane Control**

Bit 6 - PF2PRI

- 1 = Playfield 2 has priority
- 0 = Playfield 1 has priority

Bits 0-5 Playfield sprite priority

Bits 7-15 not used



---

**DDFSTRT - Data-fetch Start**

(Beginning position for data fetch)

Bits 15-8 - not used

Bits 7-2 - pixel position H8-H3 (bit H3 only respected in Hires Mode.)

Bits 1-0 - not used

**DDFSTOP - Data-fetch Stop**

(Ending position for data fetch)

Bits 15-8 - not used

Bits 7-2 - pixel position H8-H3 (bit H3 only respected in Hires Mode.)

Bits 1-0 - not used

**BPLxPTH - Bitplane Pointer**

(Bitplane pointer high word, where x is the bitplane number)

**BPLxPTL - Bitplane Pointer**

(Bitplane pointer low word, where x is the bitplane number)

**DIWSTRT - Display Window Start**

(Starting vertical and horizontal coordinates)

Bits 15-8 - VSTART (V7-V0)

Bits 7-0 - HSTART (H7-H0)

**DIWSTOP - Display Window Stop**

(Ending vertical and horizontal coordinates)

Bits 15-8 - VSTOP (V7-V0)

Bits 7-0 - HSTOP (H7-H0)

**BPL1MOD - Bitplane Modulo**

(Odd-numbered bitplanes, playfield 1)

**BPL2MOD - Bitplane Modulo**

(Even-numbered bitplanes, playfield 2)

## Summary of Color Selection Registers

This section contains summaries of the playfield color selection registers including color register contents, example colors, and the differences in color selection in high resolution and low resolution modes. The Amiga has 32 color registers and each one has 4 bits of red, 4 bits of green, and 4 bits of blue information. Table 3-15 shows the bit assignments of each color register. All color registers are write-only.

Color Register Bits	Contents
15 - 12	Unused (set these to 0)
11 - 8	Red data
7 - 4	Green data
3 - 0	Blue data

Table 3-15: Color Register Contents

### SOME SAMPLE COLOR REGISTER CONTENTS

Table 3-16 shows a variety of colors and the hexadecimal values to load into the color registers for these colors.

Value	Color	Value	Color
\$FFF	White	\$1FB	Light aqua
\$D00	Brick red	\$6FE	Sky blue
\$F00	Red	\$6CE	Light blue
\$F80	Red-orange	\$00F	Blue
\$F90	Orange	\$61F	Bright blue
\$FB0	Golden orange	\$06D	Dark blue
\$FD0	Cadmium yellow	\$91F	Purple
\$FF0	Lemon yellow	\$C1F	Violet
\$BF0	Lime green	\$F1F	Magenta
\$8E0	Light green	\$FAC	Pink
\$0F0	Green	\$DB9	Tan
\$2C0	Dark green	\$C80	Brown
\$0B1	Forest green	\$A87	Dark brown
\$0BB	Blue green	\$CCC	Light grey
\$0DB	Aqua	\$999	Medium grey
		\$000	Black

Table 3-16: Some Register Values and Resulting Colors

## COLOR SELECTION IN LOW RESOLUTION MODE

Table 3-17 shows playfield color selection in low resolution mode. If the bit combinations from the playfields are as shown, the color is taken from the color register number indicated.

Single Playfield		Dual Playfields	Color Register Number
Normal Mode (Bitplanes 5,4,3,2,1)	Hold-and-modify Mode (Bitplanes 4,3,2,1)		
		<u>Playfield 1</u> (Bitplanes 5,3,1)	
00000	0000	000	0 *
00001	0001	001	1
00010	0010	010	2
00011	0011	011	3
00100	0100	100	4
00101	0101	101	5
00110	0100	110	6
00111	0111	111	7
		<u>Playfield 2</u> (Bitplanes 6,4,2)	
01000	1000	000 **	8
01001	1001	001	9
01010	1010	010	10
01011	1011	011	11
01100	1100	100	12
01101	1101	101	13
01110	1110	110	14
01111	1111	111	15
10000			16
10001			17
10010			18
10011			19
10100	NOT	NOT	20
10101	USED	USED	21
10110	IN	IN	22
10111	THIS	THIS	23
11000	MODE	MODE	24
11001			25
11010			26
11011			27
11100			28
11101			29
11110			30
11111			31

\* Color register 0 always defines the background color.

\*\* Selects "transparent" mode instead of selecting color register 8.

Table 3-17: Low resolution Color Selection

## COLOR SELECTION IN HIGH RESOLUTION MODE

Table 3-18 shows playfield color selection in high resolution mode. If the bit combinations from the playfields are as shown, the color is taken from the color register number indicated.

Single Playfield (Bitplanes 4,3,2,1)	Dual Playfields	Color Register Number
<b>Playfield 1</b> <u>(Bitplanes 3,1)</u>		
0000	00 *	0 **
0001	01	1
0010	10	2
0011	11	3
0100		4
0101	NOT USED	5
0110	IN THIS MODE	6
0111		7
<b>Playfield 2</b> <u>(Bitplanes 4,2)</u>		
1000	00 *	8
1001	01	9
1010	10	10
1011	11	11
1100		12
1101	NOT USED	13
1110	IN THIS MODE	14
1111		15

\* Selects "transparent" mode.

\*\* Color register 0 always defines the background color.

Table 3-18: High resolution Color Selection

---

## COLOR SELECTION IN HOLD-AND-MODIFY MODE

In hold-and-modify mode, the color register contents are changed as shown in Table 3-19. This mode is in effect only if bit 10 of BPLCON0 = 1.

Bitplane 6	Bitplane 5		Result
0	0	Normal operation	(use color register itself)
0	1	Hold green and red	B = Bitplane 4-1 contents
1	0	Hold green and blue	R = Bitplane 4-1 contents
1	1	Hold blue and red	G = Bitplane 4-1 contents

Table 1-19: Color Selection in Hold-and-modify Mode

## COLOR SELECTION IN EXTRA HALF BRITE (EHB) MODE

The Amiga has a special mode called Extra Half Brite or EHB mode which doubles the maximum number of colors that can be displayed at one time. To use EHB mode, you must set up six bitplanes. Then set BPU=6 (bits 12, 13 and 14) in the BPLCON0 register. Set HAM=0 (bit 11) and DPF=0 (bit 10) in BPLCON0. In this mode, the information in bitplane 6 controls an intensity reduction in the other 5 bitplanes. The color register output selected by the first five bitplanes is shifted to half-intensity by the sixth bitplane. This allows 64 colors to be displayed at one time instead of the usual 32.

*ECS playfield registers.* For information concerning the playfield hardware and the Enhanced Chip Set, see Appendix C.



---

## chapter four

# SPRITE HARDWARE

This chapter discusses sprites which are special graphic objects that are easy to define and easy to animate. The following sprite topics are covered:

- Defining the size, shape, color, and screen position of sprites.
- Displaying and moving sprites.
- Combining sprites for more complex images, additional width, or additional colors.
- Reusing a sprite DMA channel multiple times within a display field to create more than eight sprites on the screen at one time.

## What are Sprites?

Sprites are graphic objects that are created and moved independently of the playfield display and independently of each other. Together with playfields, sprites form the graphics display of the Amiga. You can create more complex animation effects by using the blitter, which is described in the chapter called “Blitter Hardware.” Sprites are produced on-screen by eight special-purpose sprite DMA channels. Basic sprites are 16 pixels wide and any number of lines high. You can choose from three colors for a sprite’s pixels, and a pixel may also be transparent, showing any object behind the sprite. For larger or more complex objects, or for more color choices, you can combine sprites.

Sprite DMA channels can be reused several times within the same display field. Thus, you are not limited to having only eight sprites on the screen at the same time.

## Forming a Sprite

To form a sprite, you must first define it and then create a formal data structure in memory. You define a sprite by specifying its characteristics:

- On-screen width of up to 16 pixels.
- Unlimited height.
- Any shape.
- A combination of three colors, plus transparent.
- Any position on the screen.

### SCREEN POSITION

A sprite's screen position is defined as a set of X,Y coordinates. Position (0,0), where  $X = 0$  and  $Y = 0$ , is the upper left-hand corner of the display. You define a sprite's location by specifying the coordinates of its upper left-hand pixel. Sprite position is always defined as though the display modes were low resolution and non-interlaced. The X,Y coordinate system and definition of a sprite's position are graphically represented in Figure 4-1. Notice that because of display overscan, position (0,0) (that is,  $X = 0$ ,  $Y = 0$ ) is not normally in a viewable region of the screen.

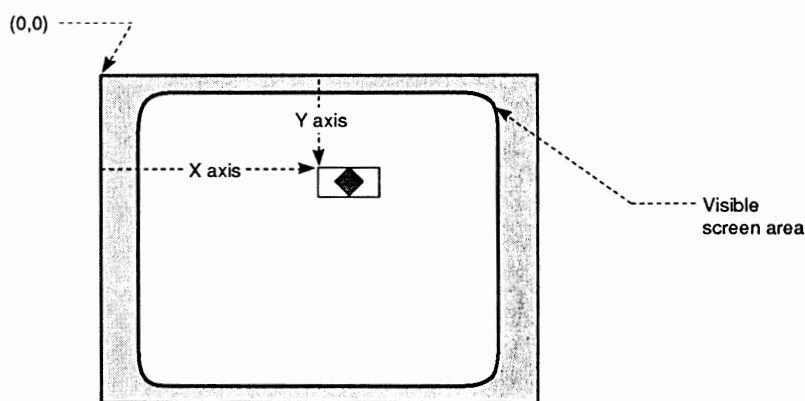

Figure 4-1: Defining Sprite On-screen Position



---

The amount of viewable area is also affected by the size of the playfield display window (defined by the values in DDFSTRT, DDFSTOP, DIWSTRT, DIWSTOP, etc.). See the “Playfield Hardware” chapter for more information about overscan and display windows.

### ***Horizontal Position***

A sprite’s horizontal position (X value) can be at any pixel on the screen from 0 to 447. To be visible, however, an object must be within the boundaries of the playfield display window. In the examples in this chapter, a window with horizontal positions from pixel 64 to pixel 383 is used (that is, each line is 320 pixels long). Larger or smaller windows can be defined as required, but it is recommended that you read the “Playfield Hardware” chapter before attempting to do so. A larger area is actually scanned by the video beam but is not usually visible on the screen.

If you specify an X value for a sprite that takes it outside the display window, then part or all of the sprite may not appear on the screen. This is sometimes desirable; such a sprite is said to be “clipped.”

To make a sprite appear in its correct on-screen horizontal position in the display window, simply add its left offset to the desired X value. In the example given above, this would involve adding 64 to the X value. For example, to make the upper leftmost pixel of a sprite appear at a position 94 pixels from the left edge of the screen, you would perform this calculation:

$$\text{Desired X position} + \text{horizontal-offset of display window} = 94 + 64 = 158$$

Thus, 158 becomes the X value, which will be written into the data structure.

*Counting Pixels.* The X position represents the location of the *very first* (leftmost) pixel in the full 16-bit wide sprite. This is always the case, even if the leftmost pixels are specified as transparent and do not appear on the screen.

If the sprite shown in Figure 4-2 were located at an X value of 158, the actual image would begin on-screen four pixels later at 162. The first four pixels in this sprite are transparent and allow the background to show through.

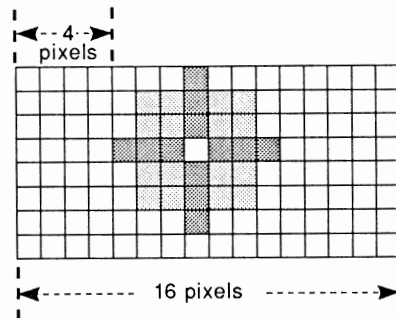

Figure 4-2: Position of Sprites

### **Vertical Position**

You can select any position from line 0 to line 262 for the topmost edge of the sprite. In the examples in this chapter, an NTSC window with vertical positions from line 44 to line 243 is used. This allows the normal display height of 200 lines in non-interlaced mode. If you specify a vertical position (Y value) of less than 44 (i.e., above the top of the display window) the top edge of the sprite may not appear on screen.

To make a sprite appear in its correct on-screen vertical position, add the Y value to the desired position. Using the above numbers, add 44 to the desired Y position. For example, to make the upper leftmost pixel appear 25 lines below the top edge of the screen, perform this calculation:

$$\text{Desired Y position} + \text{vertical-offset of the display window} = 25 + 44 = 69$$

Thus, 69 is the Y value you will write into the data structure.

### **Clipped Sprites**

As noted above, sprites will be partially or totally clipped if they pass across or beyond the boundaries of the display window. The values of 64 (horizontal) and 44 (vertical) are “normal” for a centered display on a standard NTSC video monitor. See Chapter 3, “Playfield Hardware”, for more information on display offsets. Information on PAL displays will be found there. If you choose other values to establish your display window, your sprites will be clipped accordingly.

---

## SIZE OF SPRITES

Sprites are 16 pixels wide and can be almost any height you wish — as short as one line or taller than the screen. You would probably move a very tall sprite vertically to display a portion of it at a time.

Sprite size is based on a pixel that is 1/320th of a screen's width, 1/200th of a NTSC screen's height, or 1/256 of a PAL screen's height. This pixel size corresponds to the low resolution and non-interlaced modes of the normal full-size playfield. Sprites, however, are independent of playfield modes of display, so changing the resolution or interlace mode of the playfield has *no effect* on the size or resolution of a sprite.

## SHAPE OF SPRITES

A sprite can have any shape that will fit within the 16-pixel width. You define a sprite's shape by specifying which pixels actually appear in each of the sprite's locations. For example, Figures 4-3 and 4-4 show a spaceship whose shape is marked by Xs. The first figure shows only the spaceship as you might sketch it out on graph paper. The second figure shows the spaceship within the 16-pixel width. The Os around the spaceship mark the part of the sprite not covered by the spaceship and transparent when displayed.

```
      X X
     X X X X X X
    X X X X X X X X X X
   X X X X X X X X X X
     X X X X X X
      X X
```

Figure 4-3: Shape of Spaceship

```
  O O O O X X O O O O O O O O O O
  O O X X X X X X O O O O O O O O
  X X X X X X X X X X O O O O O O
  X X X X X X X X X X O O O O O O
  O O X X X X X X O O O O O O O O
  O O O O X X O O O O O O O O O O
```

Figure 4-4: Sprite with Spaceship Shape Defined

In this example, the widest part of the shape is ten pixels and the shape is shifted to the left of the sprite. Whenever the shape is narrower than the sprite, you can control which part of the sprite is used to define the shape. This particular shape could also start at any of the pixels from 2-7 instead of pixel 1.

## SPRITE COLOR

When sprites are used individually (that is, not *attached* as described in the “Attached Sprites” section), each pixel can be one of three colors or transparent. Color selection is similar to the method used for playfield colors. Figure 4-5 shows how the color of each pixel in a sprite is determined.

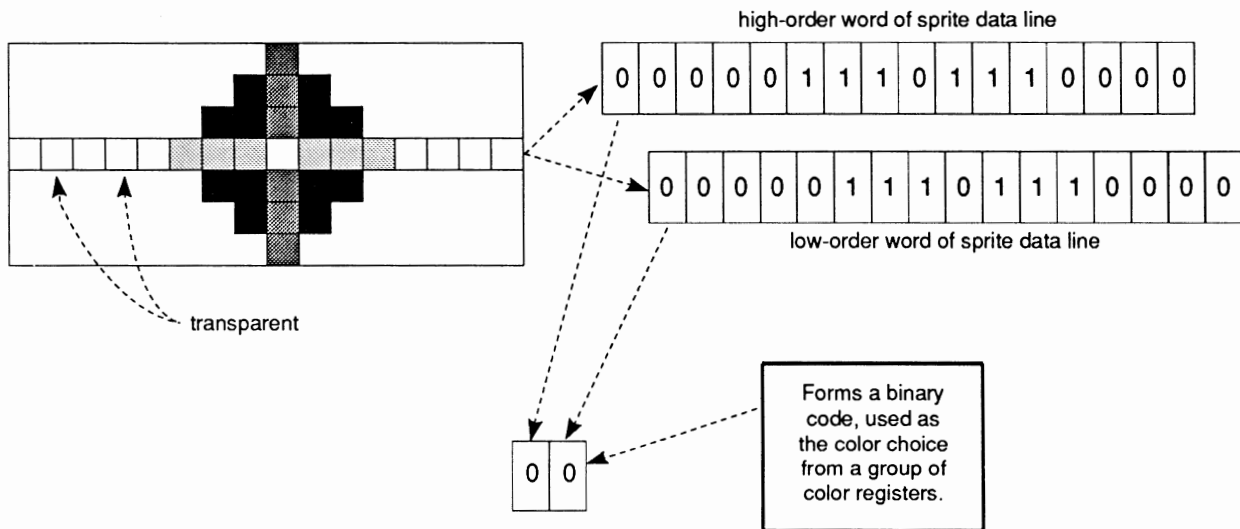

Figure 4-5: Sprite Color Definition

The 0s and 1s in the two data words that define each line of a sprite in the data structure form a binary number. This binary number points to one of the four color registers assigned to that particular sprite DMA channel. The eight sprites use system color registers 16 - 31. For purposes of color selection, the eight sprites are organized into pairs and each pair uses four of the color registers as shown in Figure 4-6.

*About sprite color registers.* The color value of the first register in each group of four registers is ignored by sprites. When the sprite bits select this register, the “transparent” value is used.

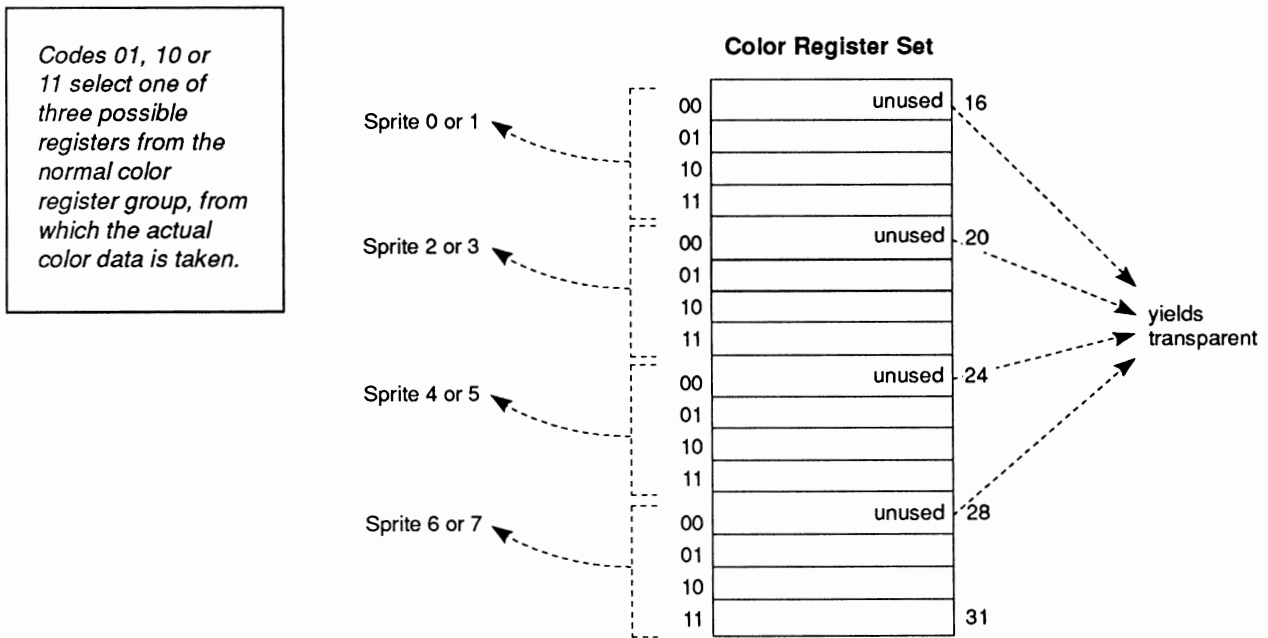

Figure 4-6: Color Register Assignments

If you require certain colors in a sprite, you will want to load the sprite’s color registers with those colors. The “Playfield Hardware” chapter contains instructions on loading color registers.

The binary number 00 is special in this color scheme. A pixel whose value is 00 becomes transparent and shows the color of any other sprite or playfield that has lower video priority. An object with low priority appears “behind” an object with higher priority. Each sprite has a fixed video priority with respect to all the other sprites. You can vary the priority between sprites and playfields. (See Chapter 7, “System Control Hardware,” for more information about sprite priority.)

---

## DESIGNING A SPRITE

For design purposes, it is convenient to lay out the sprite on paper first. You can show the desired colors as numbers from 0 to 3. For example, the spaceship shown above might look like this:

```
0000122332210000
0001223333221000
0012223333222100
0001223333221000
0000122332210000
```

The next step is to convert the numbers 0-3 into binary numbers, which will be used to build the color descriptor words of the sprite data structure. The section below shows how to do this.

## BUILDING THE DATA STRUCTURE

After defining the sprite, you need to build its data structure, which is a series of 16-bit words in a contiguous memory area. Some of the words contain position and control information and some contain color descriptions. To create a sprite's data structure, you need to:

- Write the horizontal and vertical position of the sprite into the first control word.
- Write the vertical stopping position into the second control word.
- Translate the decimal color numbers 0 - 3 in your sprite grid picture into binary color numbers. Use the binary values to build color descriptor (data) words and write these words into the data structure.
- Write the control words that indicate the end of the sprite data structure.

*Warning:* Sprite data, like all other data accessed by the custom chips, must be loaded into Chip RAM. Be sure all of your sprite data structures are word aligned in Chip Memory.

Table 4-1 shows a sprite data structure with the memory location and function of each word:

<b>Memory Location</b>	<b>16-bit Word</b>	<b>Function</b>
N	Sprite control word 1	Vertical and horizontal start position
N+1	Sprite control word 2	Vertical stop position
N+2	Color descriptor low word	Color bits for line 1
N+3	Color descriptor high word	Color bits for line 1
N+4	Color descriptor low word	Color bits for line 2
N+5	Color descriptor high word	Color bits for line 2
	.	
	.	
	.	
	End-of-data words	Two words indicating the next usage of this sprite

Table 4-1: Sprite Data Structure

All memory addresses for sprites are word addresses. You will need enough contiguous memory to provide room for two words for the control information, two words for each horizontal line in the sprite, and two end-of-data words.

Because this data structure must be accessible by the special-purpose chips, you must ensure that this data is located within chip memory.

Figure 4-7 shows how the data structure relates to the sprite.

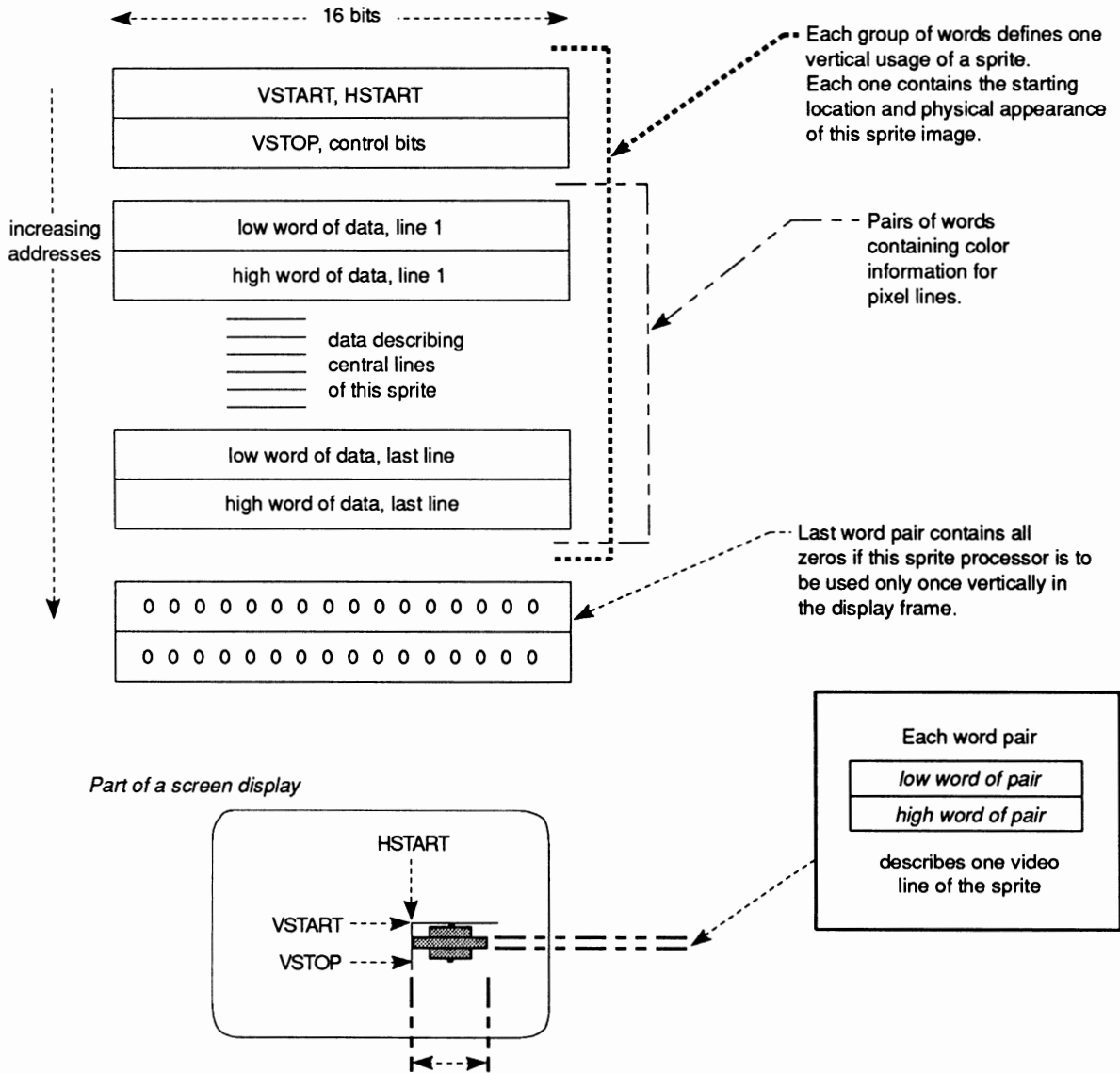

Figure 4-7: Data Structure Layout



---

### **Sprite Control Word 1 : SPRxPOS**

This word contains the vertical (VSTART) and horizontal (HSTART) starting position for the sprite. This is where the topmost line of the sprite will be positioned.

Bits 15-8 contain the low 8 bits of VSTART

Bits 7-0 contain the high 8 bits of HSTART

### **Sprite Control Word 2 : SPRxCTL**

This word contains the vertical stopping position of the sprite on the screen (i.e., the line AFTER the last displayed row of the sprite). It also contains some data having to do with sprite attachment, which is described later on.

#### SPRxCTL

Bits 15-8	The low eight bits of VSTOP
Bit 7	(Used in attachment)
Bits 6-3	Unused (make zero)
Bit 2	The VSTART high bit
Bit 1	The VSTOP high bit
Bit 0	The HSTART low bit

The value (VSTOP - VSTART) defines how many scan lines high the sprite will be when it is displayed.

### **Sprite Color Descriptor Words**

It takes two color descriptor words to describe each horizontal line of a sprite; the high order word and the low order word. To calculate how many color descriptor words you need, multiply the height of the sprite in lines by 2. The bits in the high order color descriptor word contribute the leftmost digit of the binary color selector number for each pixel; the low order word contributes the rightmost digit.

To form the color descriptor words, you first need to form a picture of the sprite, showing the color of each pixel as a number from 0 - 3. Each number represents one of the colors in the sprite's color registers. For example, here is the spaceship sprite again:

```
0000122332210000
0001223333221000
0012223333222100
0001223333221000
0000122332210000
```

---

Next, you translate each of the numbers in this picture into a binary number. The first line in binary is shown below. The binary numbers are represented vertically with the low digit in the top line and the high digit right below it. This is how the two color descriptor words for each sprite line are written in memory.

```
0000100110010000 ← Low Sprite Word
0000011111100000 ← High Sprite Word
```

The first line above becomes the color descriptor low word for line 1 of the sprite. The second line becomes the color descriptor high word. In this fashion, you translate each line in the sprite into binary 0s and 1s. See Figure 4-7.

Each of the binary numbers formed by the combination of the two data words for each line refers to a specific color register in that particular sprite channel's segment of the color table. Sprite channel 0, for example, takes its colors from registers 17 - 19. The binary numbers corresponding to the color registers for sprite DMA channel 0 are shown in Table 4-2.

Binary Number	Color Register Number
00	Transparent
01	17
10	18
11	19

Table 4-2: Sprite Color Registers

Recall that binary 00 always means transparent and never refers to a color except background.

### ***End-of-data Words***

When the vertical position of the beam counter is equal to the VSTOP value in the sprite control words, the next two words fetched from the sprite data structure are written into the sprite control registers instead of being sent to the color registers. These two words are interpreted by the hardware in the same manner as the original words that were first loaded into the control registers. If the VSTART value contained in these words is lower than the current beam position, this sprite will not be reused in this display field. For consistency, the value 0 should be used for both words when ending the usage of a sprite. Sprite reuse is discussed later.

---

The following data structure is for the spaceship sprite. It will be located at V = 65 and H = 128 on the normally visible part of the screen.

```
SPRITE:
DC.W    $6D60,$7200    ;VSTART, HSTART, VSTOP
DC.W    $0990,$07E0    ;First pair of descriptor words
DC.W    $13C8,$0FF0
DC.W    $23C4,$1FF8
DC.W    $13C8,$0FF0
DC.W    $0990,$07E0
DC.W    $0000,$0000    ;End of sprite data
```

## Displaying a Sprite

After building the data structure, you need to tell the system to display it. This section describes the display of sprites in “automatic” mode. In this mode, once the sprite DMA channel begins to retrieve and display the data, the display continues until the VSTOP position is reached. Manual mode is described later on in this chapter.

The following steps are used in displaying the sprite:

1. Decide which of the eight sprite DMA channels to use (making certain that the chosen channel is available).
2. Set the sprite pointers to tell the system where to find the sprite data.
3. Turn on sprite direct memory access if it is not already on.
4. For each subsequent display field, during the vertical blanking interval, rewrite the sprite pointers.

*About sprite DMA.* If sprite DMA is turned off while a sprite is being displayed (that is, after VSTART but before VSTOP), the system will continue to display the line of sprite data that was most recently fetched. This causes a vertical bar to appear on the screen. It is recommended that sprite DMA be turned off only during vertical blanking or during some portion of the display where you are *sure* that no sprite is being displayed.

---

## SELECTING A DMA CHANNEL AND SETTING THE POINTERS

In deciding which DMA channel to use, you should take into consideration the colors assigned to the sprite and the sprite's video priority.

The sprite DMA channel uses two pointers to read in sprite data and control words. During the vertical blanking interval before the first display of the sprite, you need to write the sprite's memory address into these pointers. The pointers for each sprite are called SPRxPTH and SPRxPTL, where "x" is the number of the sprite DMA channel. SPRxPTH contains the high three bits of the memory address of the first word in the sprite and SPRxPTL contains the low sixteen bits. The least significant bit of SPRxPTL is ignored, as sprite data must be word aligned. Thus, only fifteen bits of SPRxPTL are used. As usual, you can write a long word into SPRxPTH.

In the following example the processor initializes the data pointers for sprite 0. Normally, this is done by the Copper. The sprite is at address \$20000.

```
MOVE.L  #$20000,SPR0PTH+CUSTOM ;Write $20000 to sprite 0 pointer...
```

These pointers are dynamic; they are incremented by the sprite DMA channel to point first to the control words, then to the data words, and finally to the end-of-data words. After reading in the sprite control information and storing it in other registers, they proceed to read in the color descriptor words. The color descriptor words are stored in sprite data registers, which are used by the sprite DMA channel to display the data on screen. For more information about how the sprite DMA channels handle the display, see the "Hardware Details" section below.

## RESETTING THE ADDRESS POINTERS

For one single display field, the system will automatically read the data structure and produce the sprite on-screen in the colors that are specified in the sprite's color registers. If you want the sprite to be displayed in subsequent display fields, you must rewrite the contents of the sprite pointers during each vertical blanking interval. This is necessary because during the display field, the pointers are incremented to point to the data which is being fetched as the screen display progresses.

The rewrite becomes part of the vertical blanking routine, which can be handled by instructions in the Copper lists.

## SPRITE DISPLAY EXAMPLE

This example displays the spaceship sprite at location V = 65, H = 128. Remember to include the file "hw\_examples.i", located in Appendix I.

```
; First, we set up a single bitplane.
;
    LEA     CUSTOM,a0                ;Point a0 at custom chips
    MOVE.W  #$1200,BPLCON0(a0)      ;1 bitplane color is on
    MOVE.W  #$0000,BPL1MOD(a0)     ;Modulo = 0
    MOVE.W  #$0000,BPLCON1(a0)     ;Horizontal scroll value = 0
    MOVE.W  #$0024,BPLCON2(a0)     ;Sprites have priority over playfields
    MOVE.W  #$0038,DDFSTRT(a0)     ;Set data-fetch start
    MOVE.W  #$00D0,DDFSTOP(a0)     ;Set data-fetch stop

; Display window definitions.

    MOVE.W  #$2C81,DIWSTRT(a0)     ;Set display window start
                                        ;Vertical start in high byte.
                                        ;Horizontal start * 2 in low byte.
    MOVE.W  #$F4C1,DIWSTOP(a0)    ;Set display window stop
                                        ;Vertical stop in high byte.
                                        ;Horizontal stop * 2 in low byte.

;
; Set up color registers.
;
    MOVE.W  #$0008,COLOR00(a0)     ;Background color = dark blue
    MOVE.W  #$0000,COLOR01(a0)     ;Foreground color = black
    MOVE.W  #$0FF0,COLOR17(a0)     ;Color 17 = yellow
    MOVE.W  #$00FF,COLOR18(a0)     ;Color 18 = cyan
    MOVE.W  #$0F0F,COLOR19(a0)     ;Color 19 = magenta

;
; Move Copper list to $20000.
;
    MOVE.L  #$20000,a1              ;Point A1 at Copper list destination
    LEA     COPPERL(pc),a2          ;Point A2 at Copper list source
CLOOP:
    MOVE.L  (a2),(a1)+              ;Move a long word
    CMP.L   #$FFFFFFFE,(a2)+        ;Check for end of list
    BNE     CLOOP                  ;Loop until entire list is moved

;
; Move sprite to $25000.
;
    MOVE.L  #$25000,a1              ;Point A1 at sprite destination
    LEA     SPRITE(pc),a2           ;Point A2 at sprite source
SPRLOOP:
    MOVE.L  (a2),(a1)+              ;Move a long word
    CMP.L   #$00000000,(a2)+        ;Check for end of sprite
    BNE     SPRLOOP                ;Loop until entire sprite is moved

;
; Now we write a dummy sprite to $30000, since all eight sprites are activated
; at the same time and we're only going to use one. The remaining sprites
; will point to this dummy sprite data.
;
    MOVE.L  #$00000000,$30000      ;Write it

;
; Point Copper at Copper list.
;
    MOVE.L  #$20000,COP1LC(a0)

;
```

```

; Fill bitplane with $FFFFFFF.
;
MOVE.L  #$21000,a1           ;Point A1 at bitplane
MOVE.W  #1999,d0            ;2000-1(for dbf) long words = 8000 bytes
FLOOP
MOVE.L  #$FFFFFFF,(a1)+    ;Move a long word of $FFFFFFF
DBF     d0,FLOOP           ;Decrement, repeat until false.
;
; Start DMA.
;
MOVE.W  d0,COPJMP1(a0)     ;Force load into Copper
                               ; program counter
MOVE.W  #$83A0,DMACON(a0) ;Bitplane, Copper, and sprite DMA
RTS                                           ;..return to rest of program..

;
; This is a Copper list for one bitplane, and 8 sprites.
; The bitplane lives at $21000.
; Sprite 0 lives at $25000; all others live at $30000 (the dummy sprite).
;
COPPERL:
DC.W    BPL1PTH,$0002       ;Bitplane 1 pointer = $21000
DC.W    BPL1PTL,$1000
DC.W    SPROPTH,$0002      ;Sprite 0 pointer = $25000
DC.W    SPROPTL,$5000
DC.W    SPR1PTH,$0003      ;Sprite 1 pointer = $30000
DC.W    SPR1PTL,$0000
DC.W    SPR2PTH,$0003      ;Sprite 2 pointer = $30000
DC.W    SPR2PTL,$0000
DC.W    SPR3PTH,$0003      ;Sprite 3 pointer = $30000
DC.W    SPR3PTL,$0000
DC.W    SPR4PTH,$0003      ;Sprite 4 pointer = $30000
DC.W    SPR4PTL,$0000
DC.W    SPR5PTH,$0003      ;Sprite 5 pointer = $30000
DC.W    SPR5PTL,$0000
DC.W    SPR6PTH,$0003      ;Sprite 6 pointer = $30000
DC.W    SPR6PTL,$0000
DC.W    SPR7PTH,$0003      ;Sprite 7 pointer = $30000
DC.W    SPR7PTL,$0000
DC.W    $FFFF,$FFFE       ;End of Copper list
;
; Sprite data for spaceship sprite. It appears on the screen at V=65 and H=128.
;
SPRITE:
DC.W    $6D60,$7200        ;VSTART, HSTART, VSTOP
DC.W    $0990,$07E0        ;First pair of descriptor words
DC.W    $13C8,$0FF0
DC.W    $23C4,$1FF8
DC.W    $13C8,$0FF0
DC.W    $0990,$07E0
DC.W    $0000,$0000        ;End of sprite data

```

## Moving a Sprite

A sprite generated in automatic mode can be moved by specifying a different position in the data structure. For each display field, the data is reread and the sprite redrawn. Therefore, if you change the position data before the sprite is redrawn, it will appear in a new position and will seem to be moving.

You must take care that you are not moving the sprite (that is, changing control word data) at the same time that the system is using that data to find out where to display the object. If you do so, the system might find the start position for one field and the stop position for the following field as it retrieves data for display. This would cause a “glitch” and would mess up the screen. Therefore, you should change the content of the control words only during a time when the system is not trying to read them. Usually, the vertical blanking period is a safe time, so moving the sprites becomes part of the vertical blanking tasks and is handled by the Copper as shown in the example below.

As sprites move about on the screen, they can collide with each other or with either of the two playfields. You can use the hardware to detect these collisions and exploit this capability for special effects. In addition, you can use collision detection to keep a moving object within specified on-screen boundaries. Collision Detection is described in Chapter 7, “System Control Hardware.”

In this example of moving a sprite, the spaceship is bounced around on the screen, changing direction whenever it reaches an edge.

The sprite position data, containing VSTART and HSTART, lives in memory at \$25000. VSTOP is located at \$25002. You write to these locations to move the sprite. Once during each frame, VSTART is incremented (or decremented) by 1 and HSTART by 2. Then a new VSTOP is calculated, which will be the new VSTART + 6.

```
        MOVE.B #151,d0          ;Initialize horizontal count
        MOVE.B #194,d1          ;Initialize vertical count
        MOVE.B #64,d2           ;Initialize horizontal position
        MOVE.B #44,d3           ;Initialize vertical position
        MOVE.B #1,d4            ;Initialize horizontal increment value
        MOVE.B #1,d5            ;Initialize vertical increment value
;
;Here we wait for the start of the screen updating.
;This ensures a glitch-free display.
;
        LEA    CUSTOM,a0        ;Set custom chip base pointer
VLOOP:
        MOVE.B VHOSR(a0),d6     ;Read Vertical beam position.
;Only insert the following line if you are using a PAL machine.
;        CMP.B  #$20,d6         ;Compare with end of PAL screen.
        BNE.S  VLOOP           ;Loop if not end of screen.
;Alternatively you can use the following code:
;VLOOP:
;        MOVE.W INTREQR(a0),d6   ;Read interrupt request word
;        AND.W  #$0020,d6       ;Mask off all but vertical blank bit
;        BEQ   VLOOP           ;Loop until bit is a 1
```

```

;      MOVE.W  #$0020,INTREQ(a0)      ;Vertical bit is on, so reset it
;
;Please note that this will only work if you have turned OFF the Vertical
;blanking interrupt enable (not recommended for long periods).

      ADD.B   d4,d2      ;Increment horizontal value
      SUBQ.B  #1,d0      ;Decrement horizontal counter
      BNE    L1
      MOVE.B  #151,d0     ;Count exhausted, reset to 151
      EOR.B  #$FE,d4     ;Negate the increment value
L1:    MOVE.B  d2,$25001  ;Write new HSTART value to sprite
      ADD.B  d5,d3      ;Increment vertical value
      SUBQ.B  #1,d1      ;Decrement vertical counter
      BNE    L2
      MOVE.B  #194,d1     ;Count exhausted, reset to 194
      EOR.B  #$FE,d5     ;Negate the increment value
L2:    MOVE.B  d3,$25000  ;Write new VSTART value to sprite
      MOVE.B  d3,d6      ;Must now calculate new VSTOP
      ADD.B  #6,d6       ;VSTOP always VSTART+6 for spaceship
      MOVE.B  d6,$25002  ;Write new VSTOP to sprite
      BRA    VLOOP      ;Loop forever

```

## Creating Additional Sprites

To use additional sprites, you must create a data structure for each one and arrange the display as shown in the previous section, naming the pointers SPR1PTH and SPR1PTL for sprite DMA channel 1, SPR2PTH and SPR2PTL for sprite DMA channel 2, and so on.

*About sprite DMA.* When you enable sprite DMA for one sprite, you enable DMA for all the sprites and place them all in automatic mode. Thus, you do not need to repeat this step when using additional sprite DMA channels.

Once the sprite DMA channels are enabled, all eight sprite pointers *must* be initialized to either a real sprite or a safe null sprite. An uninitialized sprite could cause spurious sprite video to appear.

Remember that some sprites can become unusable when additional DMA cycles are allocated to displaying the screen, for example when an extra wide display or horizontal scrolling is enabled (see Figure 6-9: DMA Time Slot Allocation).

Also, recall that each pair of sprites takes its color from different color registers, as shown in Table 4-3.



---

Table 4-3: Color Registers for Sprite Pairs

Sprite Numbers	Color Registers
0 and 1	17 - 19
2 and 3	21 - 23
4 and 5	25 - 27
6 and 7	29 - 31

*Warning:* Some sprites become unusable when additional DMA cycles are allocated to displaying the screen, e.g. when enabling an extra wide display or horizontal scrolling. (See Figure 6-11: DMA Time Slot Allocation.)

## SPRITE PRIORITY

When you have more than one sprite on the screen, you may need to take into consideration their relative video priority, that is, which sprite appears in front of or behind another. Each sprite has a fixed video priority with respect to all the others. The lowest numbered sprite has the highest priority and appears in front of all other sprites; the highest numbered sprite has the lowest priority. This is illustrated in Figure 4-8.

*More about priorities.* See Chapter 7, “System Control Hardware”, for more information on sprite priorities.

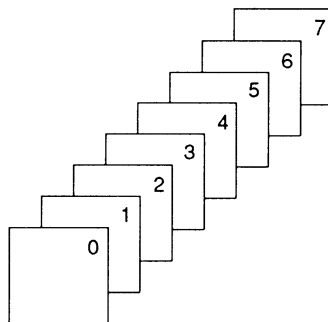

Figure 4-8: Sprite Priority

---

## Reusing Sprite DMA Channels

Each of the eight sprite DMA channels can produce more than one independently controllable image. There may be times when you want more than eight objects, or you may be left with fewer than eight objects because you have attached some of the sprites to produce more colors or larger objects or overlapped some to produce more complex images. You can reuse each sprite DMA channel several times within the same display field, as shown in Figure 4-9.

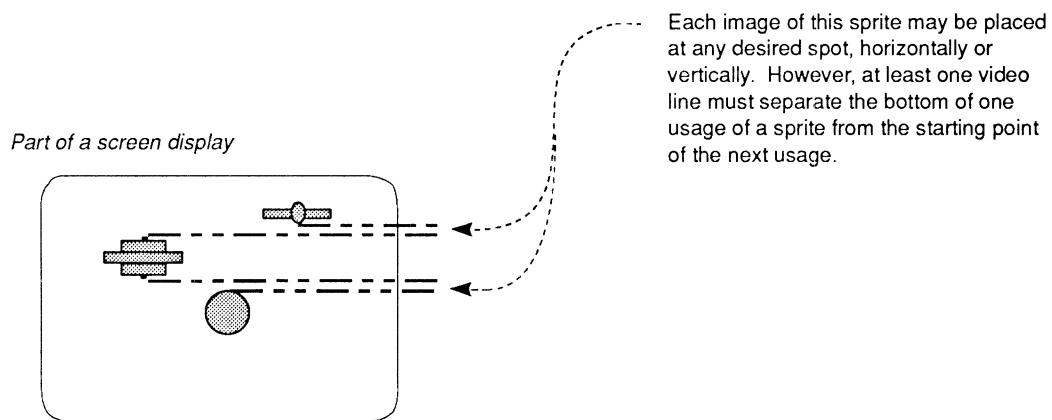

Figure 4-9: Typical Example of Sprite Reuse

In single-sprite usage, two all-zero words are placed at the end of the data structure to stop the DMA channel from retrieving any more data for that particular sprite during that display field. To reuse a DMA channel, you replace this pair of zero words with another complete sprite data structure, which describes the reuse of the DMA channel at a position lower on the screen than the first use. You place the two all-zero words at the end of the data structure that contains the information for all usages of the DMA channel. For example, Figure 4-10 shows the data structure that describes the picture above.

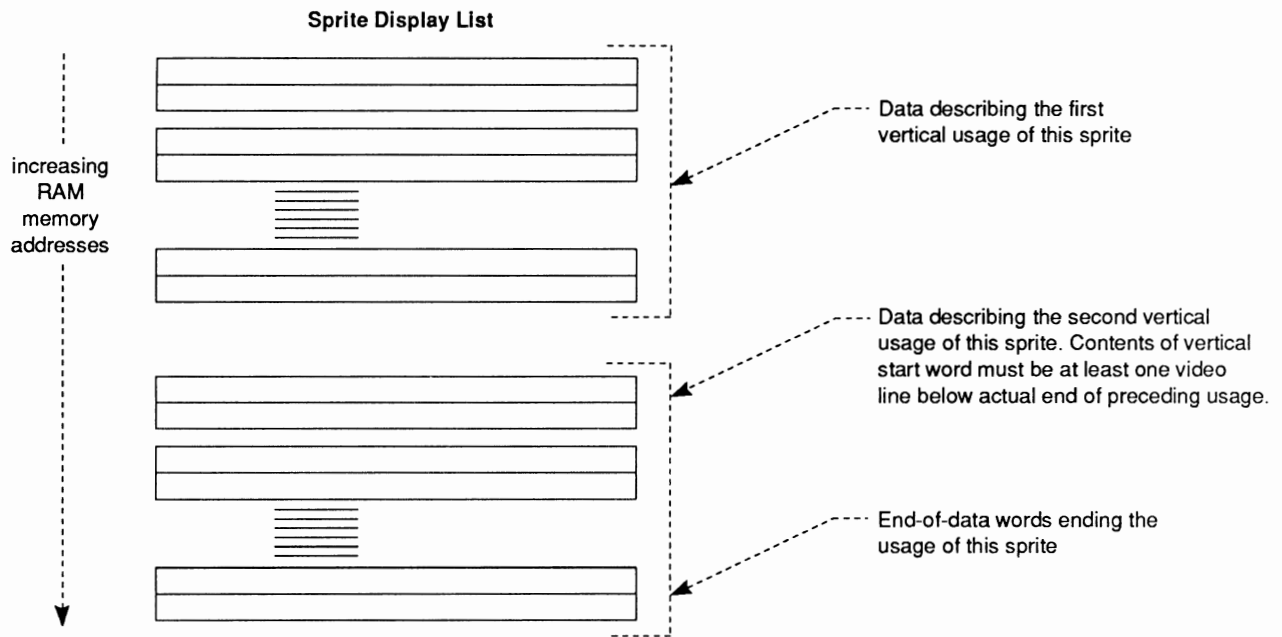

Figure 4-10: Typical Data Structure for Sprite Re-use

The only restrictions on the reuse of sprites during a single display field is that the bottom line of one usage of a sprite must be separated from the top line of the next usage by at least one horizontal scan line. This restriction is necessary because only two DMA cycles per horizontal scan line are allotted to each of the eight channels. The sprite channel needs the time during the blank line to fetch the control word describing the next usage of the sprite.

---

The following example displays the spaceship sprite and then redisplay it as a different object. Only the sprite data list is affected, so only the data list is shown here. However, the sprite looks best with the color registers set as shown in the example.

```
LEA    CUSTOM, a0
MOVE.W #$0F00, COLOR17 (a0)    ;Color 17 = red
MOVE.W #$0FF0, COLOR18 (a0)    ;Color 18 = yellow
MOVE.W #$0FFF, COLOR19 (a0)    ;Color 19 = white
SPRITE:
DC.W   $6D60, $7200
DC.W   $0990, $07E0
DC.W   $13C8, $0FF0
DC.W   $23C4, $1FF8
DC.W   $13C8, $0FF0
DC.W   $0990, $07E0
DC.W   $8080, $8D00    ;VSTART, HSTART, VSTOP for new sprite
DC.W   $1818, $0000
DC.W   $7E7E, $0000
DC.W   $7FFE, $0000
DC.W   $FFFF, $2000
DC.W   $FFFF, $2000
DC.W   $FFFF, $3000
DC.W   $FFFF, $3000
DC.W   $7FFE, $1800
DC.W   $7FFE, $0C00
DC.W   $3FFC, $0000
DC.W   $0FF0, $0000
DC.W   $03C0, $0000
DC.W   $0180, $0000
DC.W   $0000, $0000    ;End of sprite data
```

## Overlapped Sprites

For more complex or larger moving objects, you can overlap sprites. Overlapping simply means that the sprites have the same or relatively close screen positions. A relatively close screen position can result in an object that is wider than 16 pixels.

The built-in sprite video priority ensures that one sprite appears to be behind the other when sprites are overlapped. The priority circuitry gives the lowest-numbered sprite the highest priority and the highest numbered sprite the lowest priority. Therefore, when designing displays with overlapped sprites, make sure the “foreground” sprite has a lower number than the “background” sprite. In Figure 4-11, for example, the cage should be generated by a lower-numbered sprite DMA channel than the monkey.

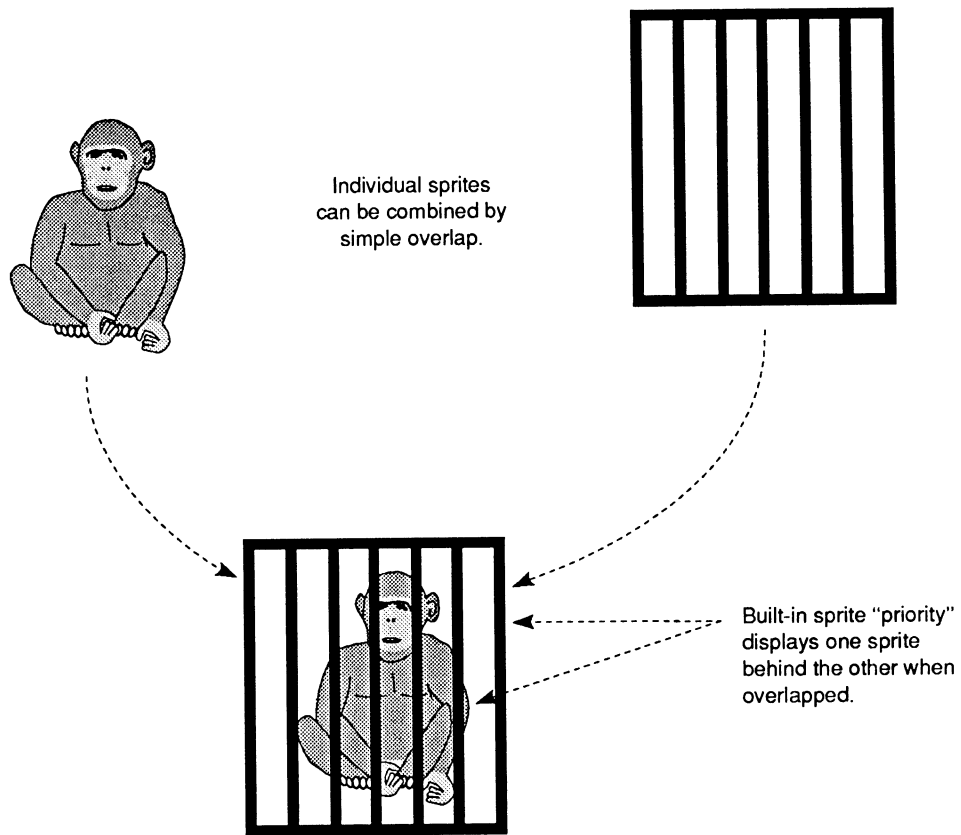

Figure 4-11: Overlapping Sprites (Not Attached)

You can create a wider sprite display by placing two sprites next to each other. For instance, Figure 4-12 shows the spaceship sprite and how it can be made twice as large by using two sprites placed next to each other.

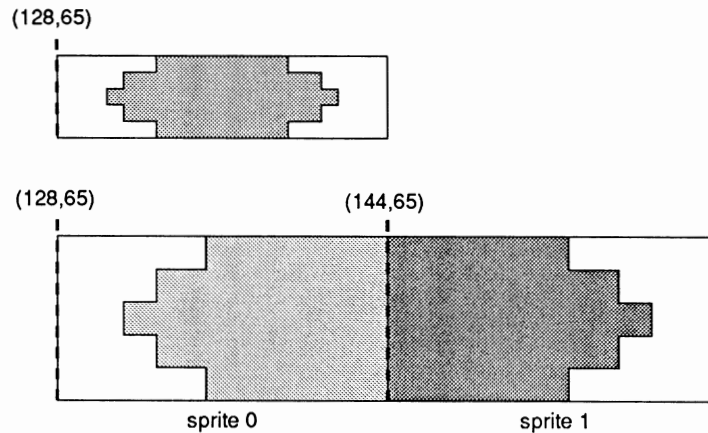

Figure 4-12: Placing Sprites Next to Each Other

## Attached Sprites

You can create sprites that have fifteen possible color choices (plus transparent) instead of three (plus transparent), by “attaching” two sprites. To create attached sprites, you must:

- Use two channels per sprite, creating two sprites of the same size and located at the same position.
- Set a bit called ATTACH in the second sprite control word.

The fifteen colors are selected from the full range of color registers available to sprites — registers 17 through 31. The extra color choices are possible because each pixel contains four bits instead of only two as in the normal, unattached sprite. Each sprite in the attached pair contributes two bits to the binary color selector number. For example, if you are using sprite DMA channels 0 and 1, the high and low order color descriptor words for line 1 in both data structures are combined into line 1 of the attached object.

Sprites can be attached in the following combinations:

- Sprite 1 to sprite 0
- Sprite 3 to sprite 2
- Sprite 5 to sprite 4
- Sprite 7 to sprite 6

Any or all of these attachments can be active during the same display field. As an example, assume that you wish to have more colors in the spaceship sprite and you are using sprite DMA channels 0 and 1. There are five colors plus transparent in this sprite.

```
0000154444510000
0001564444651000
0015676446765100
0001564444651000
0000154444510000
```

The first line in this sprite requires the four data words shown in Table 4-4 to form the correct binary color selector numbers.

Table 4-4: Data Words for First Line of Spaceship Sprite

	Pixel Number															
	15	14	13	12	11	10	9	8	7	6	5	4	3	2	1	0
<b>Line 1</b>	0	0	0	0	0	0	0	0	0	0	0	0	0	0	0	0
<b>Line 2</b>	0	0	0	0	0	1	1	1	1	1	1	0	0	0	0	0
<b>Line 3</b>	0	0	0	0	0	0	0	0	0	0	0	0	0	0	0	0
<b>Line 4</b>	0	0	0	0	1	1	0	0	0	0	1	1	0	0	0	0

The highest numbered sprite (number 1, in this example) contributes the highest order bits (leftmost) in the binary number. The high order data word in each sprite contributes the leftmost digit. Therefore, the lines above are written to the sprite data structures as follows:

- Line 1     Sprite 1 high order word for sprite line 1
- Line 2     Sprite 1 low order word for sprite line 1
- Line 3     Sprite 0 high order word for sprite line 1
- Line 4     Sprite 0 low order word for sprite line 1

See Figure 4-7 for the order these words are stored in memory. Remember that this data is contained in *two* sprite structures.

---

The binary numbers 0 through 15 select registers 17 through 31 as shown in Table 4-5.

Table 4-5: Color Registers in Attached Sprites

Decimal Number	Binary Number	Color Register Number
0	0000	16 *
1	0001	17
2	0010	18
3	0011	19
4	0100	20
5	0101	21
6	0110	22
7	0111	23
8	1000	24
9	1001	25
10	1010	26
11	1011	27
12	1100	28
13	1101	29
14	1110	30
15	1111	31

\* Unused; yields transparent pixel.

Attachment is in effect only when the ATTACH bit, bit 7 in sprite control word 2, is set to 1 in the data structure for the odd-numbered sprite. So, in this example, you set bit 7 in sprite control word 2 in the data structure for sprite 1.

When the sprites are moved, the Copper list must keep them both at exactly the same position relative to each other. If they are not kept together on the screen, their pixels will change color. Each sprite will revert to three colors plus transparent, but the colors may be different than if they were ordinary, unattached sprites. The color selection for the lower numbered sprite will be from color registers 17-19. The color selection for the higher numbered sprite will be from color registers 20, 24, and 28.



The following data structure is for the six-color spaceship made with two attached sprites.

```
SPRITE0:
    DC.W    $6D60,$7200    ;VSTART = 65, HSTART = 128
    DC.W    $0C30,$0000    ;First color descriptor word
    DC.W    $1818,$0420
    DC.W    $342C,$0E70
    DC.W    $1818,$0420
    DC.W    $0C30,$0000
    DC.W    $0000,$0000    ;End of sprite 0
SPRITE1:
    DC.W    $6D60,$7280    ;Same as sprite 0 except attach bit on
    DC.W    $07E0,$0000    ;First descriptor word for sprite 1
    DC.W    $0FF0,$0000
    DC.W    $1FF8,$0000
    DC.W    $0FF0,$0000
    DC.W    $07E0,$0000
    DC.W    $0000,$0000    ;End of sprite 1
```

## Manual Mode

It is almost always best to load sprites using the automatic DMA channels. Sometimes, however, it is useful to load these registers directly from one of the microprocessors. Sprites may be activated “manually” whenever they are not being used by a DMA channel. The same sprite that is showing a DMA-controlled icon near the top of the screen can also be reloaded manually to show a vertical colored bar near the bottom of the screen. Sprites can be activated manually even when the sprite DMA is turned off.

You display sprites manually by writing to the sprite data registers `SPRxDATB` and `SPRxDATA`, in that order. You write to `SPRxDATA` last because that address “arms” the sprite to be output at the next horizontal comparison. The data written will then be displayed on every line, at the horizontal position given in the “H” portion of the position registers `SPRxPOS` and `SPRxCTL`. If the data is unchanged, the result will be a vertical bar. If the data is reloaded for every line, a complex sprite can be produced.

The sprite can be terminated (“disarmed”) by writing to the `SPRxCTL` register. If you write to the `SPRxPOS` register, you can manually move the sprite horizontally at any time, even during normal sprite usage.

---

## Sprite Hardware Details

Sprites are produced by the circuitry shown in Figure 4-13. This figure shows in block form how a pair of data words becomes a set of pixels displayed on the screen.

The circuitry elements for sprite display are explained below.

- Sprite data registers. The registers SPRxDATA and SPRxDATB hold the bit patterns that describe one horizontal line of a sprite for each of the eight sprites. A line is 16 pixels wide, and each line is defined by two words to provide selection of three colors and transparent.
- Parallel-to-serial converters. Each of the 16 bits of the sprite data bit pattern is individually sent to the color select circuitry at the time that the pixel associated with that bit is being displayed on-screen.

Immediately after the data is transferred from the sprite data registers, each parallel-to-serial converter begins shifting the bits out of the converter, most significant (leftmost) bit first. The shift occurs once during each low resolution pixel time and continues until all 16 bits have been transferred to the display circuitry. The shifting and data output does not begin again until the next time this converter is loaded from the data registers.

Because the video image is produced by an electron beam that is being swept from left to right on the screen, the bit image of the data corresponds exactly to the image that actually appears on the screen (most significant data on the left).

- Sprite serial video data. Sprite data goes to the priority circuit to establish the priority between sprites and playfields.
- Sprite position registers. These registers, called SPRxPOS, contain the horizontal position value (X value) and vertical position value (Y value) for each of the eight sprites.
- Sprite control registers. These registers, called SPRxCTL, contain the stopping position for each of the eight sprites and whether or not a sprite is attached.
- Beam counter. The beam counter tells the system the current location of the video beam that is producing the picture.
- Comparator. This device compares the value of the beam counter to the Y value in the position register SPRxPOS. If the beam has reached the position at which the leftmost upper pixel of the sprite is to appear, the comparator issues a load signal to the serial-to-parallel converter and the sprite display begins.

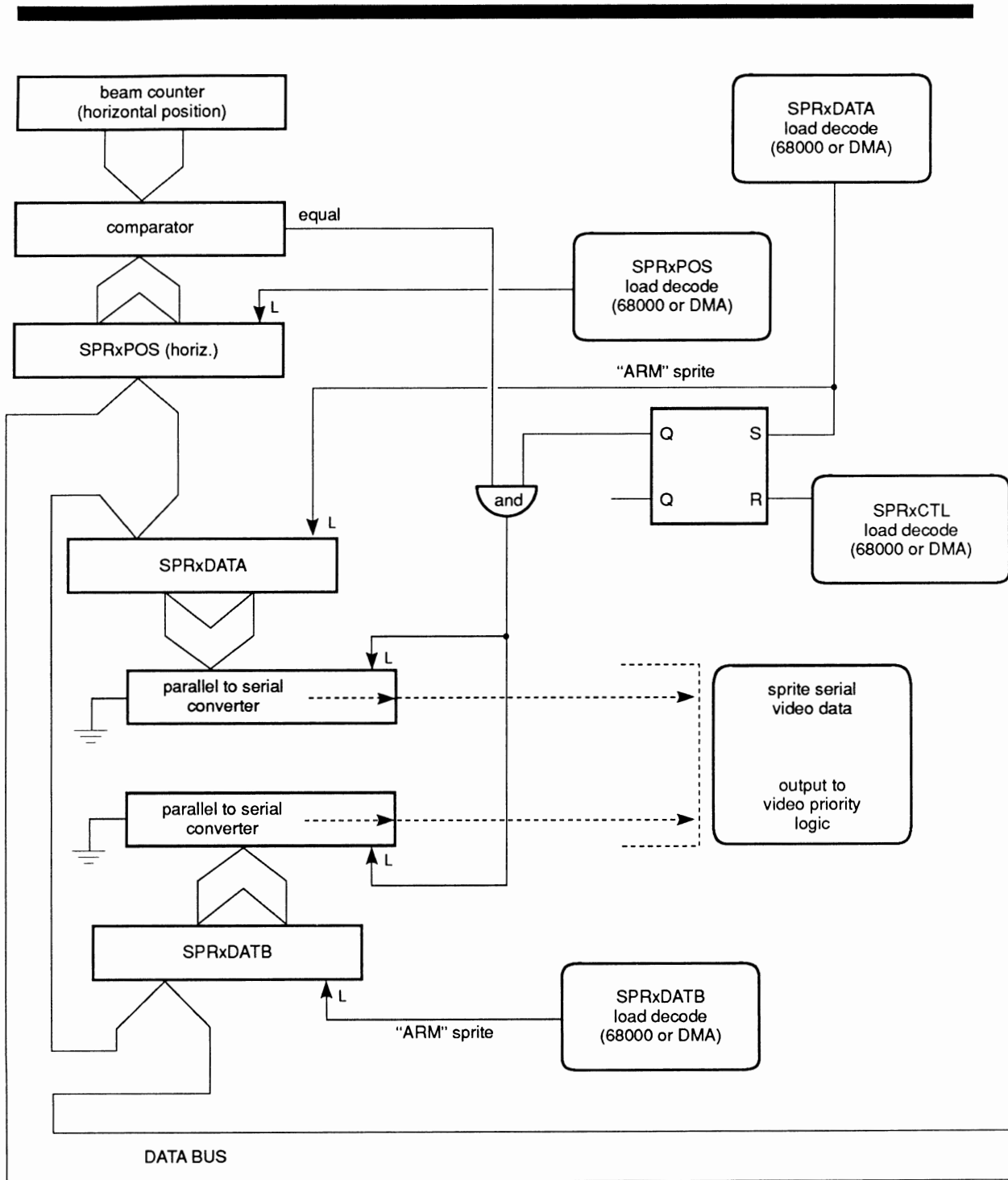

Figure 4-13: Sprite Control Circuitry

---

Figure 4-13 shows the following:

- Writing to the sprite *control* registers *disables* the horizontal comparator circuitry. This prevents the system from sending any output from the data registers to the serial converter or to the screen.
- Writing to the sprite A *data* register *enables* the horizontal comparator. This enables output to the screen when the horizontal position of the video beam equals the horizontal value in the position register.
- If the comparator is enabled, the sprite data will be sent to the display, with the leftmost pixel of the sprite data placed at the position defined in the horizontal part of SPRxPOS.
- As long as the comparator remains enabled, the current contents of the sprite data register will be output at the selected horizontal position on a video line.
- The data in the sprite data registers does not change. It is either rewritten by the user or modified under DMA control.

The components described above produce the automatic DMA display as follows: When the sprites are in DMA mode, the 18-bit sprite pointer register (composed of SPRxPTH and SPRxPTL) is used to read the first two words from the sprite data structure. These words contain the starting and stopping position of the sprite. Next, the pointers write these words into SPRxPOS and SPRxCTL. After this write, the value in the pointers points to the address of the first data word (low word of data for line 1 of the sprite.)

Writing into the SPRxCTL register disabled the sprite. Now the sprite DMA channel will wait until the vertical beam counter value is the same as the data in the VSTART (Y value) part of SPRxPOS. When these values match, the system enables the sprite data access.

The sprite DMA channel examines the contents of VSTOP (from SPRxCTL, which is the location of the line after the last line of the sprite) and VSTART (from SPRxPOS) to see how many lines of sprite data are to be fetched. Two words are fetched per line of sprite height, and these words are written into the sprite data registers. The first word is stored in SPRxDATA and the second word in SPRxDATB.

The fetch and store for each horizontal scan line occurs during a horizontal blanking interval, far to the left of the start of the screen display. This arms the sprite horizontal comparators and allows them to start the output of the sprite data to the screen when the horizontal beam count value matches the value stored in the HSTART (X value) part of SPRxPOS.

If the count of VSTOP - VSTART equals zero, no sprite output occurs. The next data word pair will be fetched, but it will not be stored into the sprite data registers. It will instead become the next pair of data words for SPRxPOS and SPRxCTL.

---

When a sprite is used only once within a single display field, the final pair of data words, which follow the sprite color descriptor words, is loaded automatically as the next contents of the SPRxPOS and SPRxCTL registers. To stop the sprite after that first data set, the pair of words should contain all zeros.

Thus, if you have formed a sprite pattern in memory, this same pattern will be produced as pixels automatically under DMA control one line at a time.

## Summary of Sprite Registers

There are eight complete sets of registers used to describe the sprites. Each set consists of five registers. Only the registers for sprite 0 are described here. All of the others are the same, except for the name of the register, which includes the appropriate number.

### POINTERS

Pointers are registers that are used by the system to point to the *current* data being used. During a screen display, the registers are incremented to point to the data being used as the screen display progresses. Therefore, pointer registers must be freshly written during the start of the vertical blanking period.

#### *SPR0PTH and SPR0PTL*

This pair of registers contains the 32-bit word address of Sprite 0 DMA data.

Pointer register names for the other sprites are:

SPR1PTH	SPR1PTL
SPR2PTH	SPR2PTL
SPR3PTH	SPR3PTL
SPR4PTH	SPR4PTL
SPR5PTH	SPR5PTL
SPR6PTH	SPR6PTL
SPR7PTH	SPR7PTL

### CONTROL REGISTERS

#### *SPR0POS*

This is the sprite 0 position register. The word written into this register controls the position on the screen at which the upper left-hand corner of the sprite is to be placed. The most significant bit of the first data word will be placed in this position on the screen.

---

*Sprite placement resolution.* The sprites have a placement resolution on a full screen of 320 by 200 NTSC (320 by 256 PAL). The sprite resolution is independent of the bitplane resolution.

Bit positions:

- Bits 15-8 specify the vertical start position, bits V7 - V0.
- Bits 7-0 specify the horizontal start position, bits H8 - H1.

*Warning:* This register is normally only written by the sprite DMA channel itself. See the details above regarding the organization of the sprite data. This register is usually updated directly by DMA.

### ***SPROCTL***

This register is normally used only by the sprite DMA channel. It contains control information that is used to control the sprite data-fetch process. Bit positions:

- Bits 15-8 specify vertical stop position for a sprite image, bits V7 - V0.
- Bit 7 is the attach bit. This bit is valid only for odd-numbered sprites. It indicates that sprites 0, 1 (or 2,3 or 4,5 or 6,7) will, for color interpretation, be considered as paired, and as such will be called four bits deep. The odd-numbered (higher number) sprite contains bits with the higher binary significance.

During attach mode, the attached sprites are normally moved horizontally and vertically together under processor control. This allows a greater selection of colors within the boundaries of the sprite itself. The sprites, although attached, remain capable of independent motion, however, and they will assume this larger color set only when their edges overlay one another.

- Bits 6-3 are reserved for future use (make zero).
- Bit 2 is bit V8 of vertical start.
- Bit 1 is bit V8 of vertical stop.
- Bit 0 is bit H0 of horizontal start.

---

Position and control registers for the other sprites work the same way as described above for sprite 0. The register names for the other sprites are:

SPR1POS	SPR1CTL
SPR2POS	SPR2CTL
SPR3POS	SPR3CTL
SPR4POS	SPR4CTL
SPR5POS	SPR5CTL
SPR6POS	SPR6CTL
SPR7POS	SPR7CTL

## DATA REGISTERS

The following registers, although defined in the address space of the main processor, are normally used only by the display processor. They are the holding registers for the data obtained by DMA cycles.

SPR0DATA, SPR0DATB	data registers for Sprite 0
SPR1DATA, SPR1DATB	data registers for Sprite 1
SPR2DATA, SPR2DATB	data registers for Sprite 2
SPR3DATA, SPR3DATB	data registers for Sprite 3
SPR4DATA, SPR4DATB	data registers for Sprite 4
SPR5DATA, SPR5DATB	data registers for Sprite 5
SPR6DATA, SPR6DATB	data registers for Sprite 6
SPR7DATA, SPR7DATB	data registers for Sprite 7

---

## Summary of Sprite Color Registers

Sprite data words are used to select the color of the sprite pixels from the system color register set as indicated in the following tables.

If the bit combinations from single sprites are as shown in Table 4-6, then the colors will be taken from the registers shown.

Table 4-6: Color Registers for Single Sprites

Single Sprites		Color Register
Sprite	Value	
0 or 1	00	Not used *
	01	17
	10	18
	11	19
2 or 3	00	Not used *
	01	21
	10	22
	11	23
4 or 5	00	Not used *
	01	25
	10	26
	11	27
6 or 7	00	Not used *
	01	29
	10	30
	11	31

\* Selects transparent mode.



---

If the bit combinations from attached sprites are as shown in Table 4-7, then the colors will be taken from the registers shown.

Table 4-7: Color Registers for Attached Sprites

Value	Attached Sprites Color Register
0000	Selects transparent mode
0001	17
0010	18
0011	19
0100	20
0101	21
0110	22
0111	23
1000	24
1001	25
1010	26
1011	27
1100	28
1101	29
1110	30
1111	31

## INTERACTIONS AMONG SPRITES AND OTHER OBJECTS

Playfields share the display with sprites. Chapter 7, “System Control Hardware,” shows how playfields can be given different video display priorities relative to the sprites and how playfields can collide with (overlap) the sprites or each other.

*ECS Sprites.* For information relating to sprites in the Enhanced Chip Set (ECS), such as SuperHires sprites and SuperHires sprite positioning, see Appendix C.



---

## chapter five

# AUDIO HARDWARE

This chapter shows you how to directly access the audio hardware to produce sounds. The major topics in this chapter are:

- A brief overview of how a computer produces sound.
- How to produce simple steady and changing sounds and more complex ones.
- How to use the audio channels for special effects, wiring them for stereo sound if desired, or using one channel to modulate another.
- How to produce quality sound within the system limitations.

A section at the end of the chapter gives you values to use for creating musical notes on the equal-tempered musical scale.

This chapter is not a tutorial on computer sound synthesis; a thorough description of creating sound on a computer would require a far longer document. The purpose here is to point the way and show you how to use the Amiga's features. Computer sound production is fun but complex, and it usually requires a great deal of trial and error on the part of the user—you use the instructions to create some sound and play it back, readjust the parameters and play it again, and so on.

The following works are recommended for more information on creating music with computers:

- Wayne A. Bateman, *Introduction to Computer Music* (New York: John Wiley and Sons, 1980).
- Hal Chamberlain, *Musical Applications of Microprocessors* (Rochelle Park, New Jersey: Hayden, 1980).

---

## Introducing Sound Generation

Sound travels through air to your ear drums as a repeated cycle of air pressure variations, or sound waves. Sounds can be represented as graphs that model how the air pressure varies over time. The attributes of a sound, as you hear it, are related to the shape of the graph. If the waveform is regular and repetitive, it will sound like a tone with steady pitch (highness or lowness), such as a single musical note. Each repetition of a waveform is called a cycle of the sound. If the waveform is irregular, the sound will have little or no pitch, like a loud clash or rushing water. How often the waveform repeats (its frequency) has an effect upon its pitch; sounds with higher frequencies are higher in pitch. Humans can hear sounds that have a frequency of between 20 and 20,000 cycles per second. The amplitude of the waveform (highest point on the graph), is related to the perceived loudness of the sound. Finally, the general shape of the waveform determines its tone quality, or timbre. Figure 5-1 shows a particular kind of waveform, called a sine wave, that represents one cycle of a simple tone.

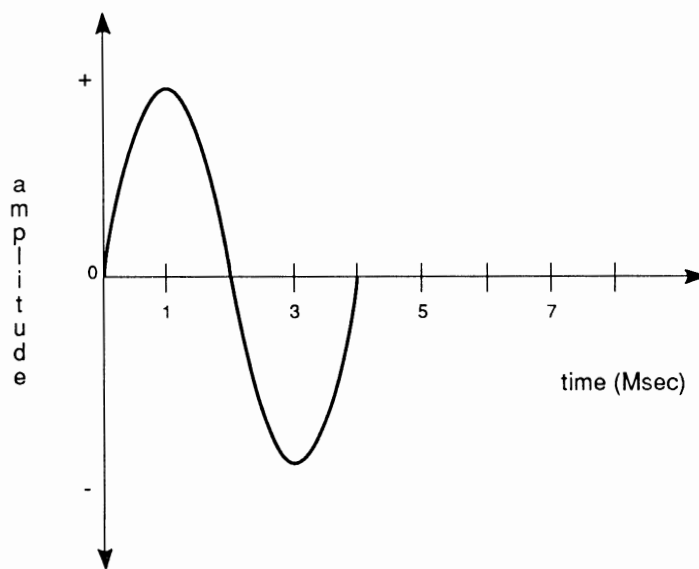

Figure 5-1: Sine Waveform

In electronic sound recording and output devices, the attributes of sounds are represented by the parameters of amplitude and frequency. Frequency is the number of cycles per second, and the most common unit of frequency is the Hertz (Hz), which is 1 cycle per second. Large values, or high frequencies, are measured in kilohertz (KHz) or megahertz (MHz).

Frequency is strongly related to the perceived pitch of a sound. When frequency increases, pitch rises. This relationship is exponential. An increase from 100 Hz to 200 Hz results in a large rise in pitch, but an increase from 1,000 Hz to 1,100 Hz is hardly noticeable. Musical pitch is represented in octaves. A tone that is one octave higher than another has a frequency twice as

---

high as that of the first tone, and its perceived pitch is twice as high.

The second parameter that defines a waveform is its amplitude. In an electronic circuit, amplitude relates to the voltage or current in the circuit. When a signal is going to a speaker, the amplitude is expressed in watts. Perceived sound intensity is measured in decibels (db). Human hearing has a range of about 120 db; 1 db is the faintest audible sound. Roughly every 10 db corresponds to a doubling of sound, and 1 db is the smallest change in amplitude that is noticeable in a moderately loud sound. Volume, which is the amplitude of the sound signal which is output, corresponds logarithmically to decibel level.

The frequency and amplitude parameters of a sine wave are completely independent. When sound is heard, however, there is interaction between loudness and pitch. Lower-frequency sounds decrease in loudness much faster than high-frequency sounds.

The third attribute of a sound, timbre, depends on the presence or absence of overtones, or harmonics. Any complex waveform is actually a mixture of sine waves of different amplitudes, frequencies, and phases (the starting point of the waveform on the time axis). These component sine waves are called harmonics. A square waveform, for example, has an infinite number of harmonics.

In summary, all steady sounds can be described by their frequency, overall amplitude, and relative harmonic amplitudes. The audible equivalents of these parameters are pitch, loudness, and timbre, respectively. Changing sound is a steady sound whose parameters change over time.

In electronic production of sound, an analog device, such as a tape recorder, records sound waveforms and their cycle frequencies as a continuously variable representation of air pressure. The tape recorder then plays back the sound by sending the waveforms to an amplifier where they are changed into analog voltage waveforms. The amplifier sends the voltage waveforms to a loudspeaker, which translates them into air pressure vibrations that the listener perceives as sound.

A computer cannot store analog waveform information. In computer production of sound, a waveform has to be represented as a finite string of numbers. This transformation is made by dividing the time axis of the graph of a single waveform into equal segments, each of which represents a short enough time so the waveform does not change a great deal. Each of the resulting points is called a sample. These samples are stored in memory, and you can play them back at a frequency that you determine. The computer feeds the samples to a digital-to-analog converter (DAC), which changes them into an analog voltage waveform. To produce the sound, the analog waveforms are sent first to an amplifier, then to a loudspeaker.

Figure 5-2 shows an example of a sine wave, a square wave, and a triangle wave, along with a table of samples for each.

*Note:* The illustrations are not to scale and there are fewer dots in the wave forms than there are samples in the table. The amplitude axis values 127 and -128 represent the high and low limits on relative amplitude.

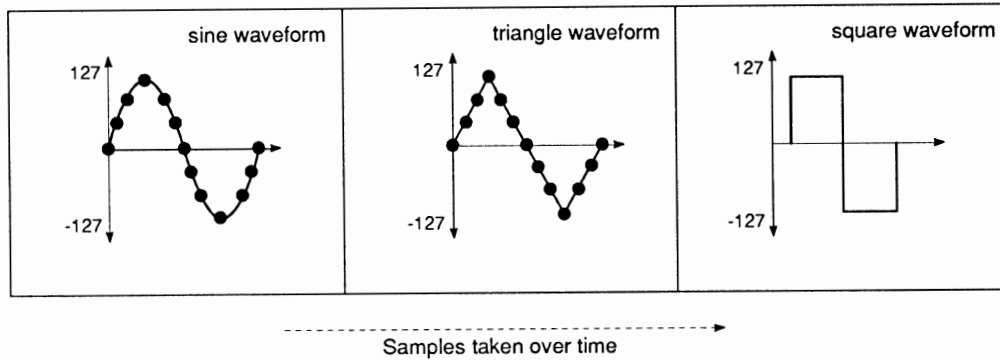

TIME	SINE	SQUARE	TRIANGLE
0	0	100	0
1	39	100	20
2	75	100	40
3	103	100	60
4	121	100	80
5	127	100	100
6	121	100	80
7	103	100	60
8	75	100	40
9	39	100	20
10	0	-100	0
11	-39	-100	-20
12	-75	-100	-40
13	-103	-100	-60
14	-121	-100	-80
15	-127	-100	-100
16	-121	-100	-80
17	-103	-100	-60
18	-75	-100	-40
19	-39	-100	-20

Figure 5-2: Digitized Amplitude Values

## THE AMIGA SOUND HARDWARE

The Amiga has four hardware sound channels. You can independently program each of the channels to produce complex sound effects. You can also attach channels so that one channel modulates the sound of another or combine two channels for stereo effects.

---

Each audio channel includes an eight-bit digital-to-analog converter driven by a direct memory access (DMA) channel. The audio DMA can retrieve two data samples during each horizontal video scan line. For simple, steady tones, the DMA can automatically play a waveform repeatedly; you can also program all kinds of complex sound effects.

There are two methods of basic sound production on the Amiga — automatic (DMA) sound generation and direct (non-DMA) sound generation. When you use automatic sound generation, the system retrieves data automatically by direct memory access.

## Forming and Playing a Sound

This section shows you how to create a simple, steady sound and play it. Many basic concepts that apply to all sound generation on the Amiga are introduced in this section.

To produce a steady tone, follow these basic steps:

1. Decide which channel to use.
2. Define the waveform and create the sample table in memory.
3. Set registers telling the system where to find the data and the length of the data.
4. Select the volume at which the tone is to be played.
5. Select the sampling period, or output rate of the data.
6. Select an audio channel and start up the DMA.

### DECIDING WHICH CHANNEL TO USE

The Amiga has four audio channels. Channels 1 and 2 are connected to the left-side stereo output jack. Channels 0 and 3 are connected to the right-side output jack. Select a channel on the side from which the output is to appear.

### CREATING THE WAVEFORM DATA

The waveform used as an example in this section is a simple sine wave, which produces a pure tone. To conserve memory, you normally define only one full cycle of a waveform in memory. For a steady, unchanging sound, the values at the waveform's beginning and ending points and the trend or slope of the data at the beginning and end should be closely related. This ensures that a continuous repetition of the waveform sounds like a continuous stream of sound.

Sound data is organized as a set of eight-bit data items; each item is a sample from the waveform. Each data word retrieved for the audio channel consists of two samples. Sample values can range from -128 to +127.

As an example, the data set shown below produces a close approximation to a sine wave.

*About the sample data.* The data is stored in byte address order with the first digitized amplitude value at the lowest byte address, the second at the next byte address, and so on. Also, note that the first byte of data must start at a word-address boundary. This is because the audio DMA retrieves one word (16 bits) at a time and uses the sample it reads as two bytes of data.

To use audio channel 0, write the address of "audiodata" into AUD0LC, where the audio data is organized as shown below. For simplicity, "AUDxLC" in the table below stands for the combination of the two actual location registers (AUDxLCH and AUDxLCL). For the audio DMA channels to be able to retrieve the data, the data address to which AUD0LC points must be somewhere in chip RAM.

Table 5-1: Sample Audio Data Set for Channel 0

audiodata --->	AUD0LC *	100	98
	AUD0LC + 2 **	92	83
	AUD0LC + 4	71	56
	AUD0LC + 6	38	20
	AUD0LC + 8	0	-20
	AUD0LC + 10	-38	-56
	AUD0LC + 12	-71	-83
	AUD0LC + 14	-92	-83
	AUD0LC + 16	-100	-98
	AUD0LC + 18	-92	-83
	AUD0LC + 20	-71	-56
	AUD0LC + 22	-38	-20
	AUD0LC + 24	0	20
	AUD0LC + 26	38	56
	AUD0LC + 28	71	83
	AUD0LC + 30	92	98

Notes:

\*Audio data is located on a word-address boundary.

\*\*AUD0LC stands for AUD0LCL and AUD0LCH.



---

## TELLING THE SYSTEM ABOUT THE DATA

In order to retrieve the sound data for the audio channel, the system needs to know where the data is located and how long (in words) the data is.

The location registers AUDxLCH and AUDxLCL contain the high three bits and the low fifteen bits, respectively, of the starting address of the audio data. Since these two register addresses are contiguous, writing a long word into AUDxLCH moves the audio data address into both locations. The ‘x’ in the register names stands for the number of the audio channel where the output will occur. The channels are numbered 0, 1, 2, and 3.

These registers are *location* registers, as distinguished from *pointer* registers. You need to specify the contents of these registers only once; no resetting is necessary when you wish the audio channel to keep on repeating the same waveform. Each time the system retrieves the last audio word from the data area, it uses the contents of these location registers to again find the start of the data. Assuming the first word of data starts at location ‘‘audiodata’’ and you are using channel 0, here is how to set the location registers:

```
WHEREODATA:
    LEA    CUSTOM,a0      ; Base chip address...
    LEA    AUDIODATA,a1
    MOVE.L a1,AUD0LCH(a0) ;Put address (32 bits)
                                ; into location register.
```

The length of the data is the number of samples in your waveform divided by 2, or the number of words in the data set. Using the sample data set above, the length of the data is 16 words. You write this length into the audio data length register for this channel. The length register is called AUDxLEN, where ‘x’ refers to the channel number. You set the length register AUD0LEN to 16 as shown below.

```
SETAUDOLENGTH:
    LEA    CUSTOM,a0      ; Base chip address
    MOVE.W #16,AUD0LEN(a0) ; Store the length...
```

## SELECTING THE VOLUME

The volume you set here is the overall volume of all the sound coming from the audio channel. The relative loudness of sounds, which will concern you when you combine notes, is determined by the amplitude of the wave form. There is a six-bit volume register for each audio channel. To control the volume of sound that will be output through the selected audio channel, you write the desired value into the register AUDxVOL, where ‘x’ is replaced by the channel number. You can specify values from 64 to 0. These volume values correspond to decibel levels. At the end of this chapter is a table showing the decibel value for each of the 65 volume levels.

---

For a typical output at volume 64, with maximum data values of -128 to 127, the voltage output is between +.4 volts and -.4 volts. Some volume levels and the corresponding decibel values are shown in Table 5-2.

Table 5-2: Volume Values

Volume	Decibel Value	
64	0	(maximum volume)
48	-2.5	
32	-6.0	
16	-12.0	(12 db down from the volume at maximum level)

For any volume setting from 64 to 0, you write the value into bits 5-0 of AUDOVOL. For example:

```
SETAUDOVOLUME :  
    LEA     CUSTOM, a0  
    MOVE.W #48, AUDOVOL (a0)
```

The decibels are shown as negative values from a maximum of 0 because this is the way a recording device, such as a tape recorder, shows the recording level. Usually, the recorder has a dial showing 0 as the optimum recording level. Anything less than the optimum value is shown as a minus quantity.

## SELECTING THE DATA OUTPUT RATE

The pitch of the sound produced by the waveform depends upon its frequency. To tell the system what frequency to use, you need to specify the sampling period. The sampling period specifies the number of system clock ticks, or timing intervals, that should elapse between each sample (byte of audio data) fed to the digital-to-analog converter in the audio channel. There is a period register for each audio channel. The value of the period register is used for count-down purposes; each time the register counts down to 0, another sample is retrieved from the waveform data set for output. In units, the period value represents clock ticks per sample. The minimum period value you should use is 124 ticks per sample NTSC (123 PAL) and the maximum is 65535. These limits apply to both PAL and NTSC machines. For high-quality sound, there are other constraints on the sampling period (see the section called "Producing High-quality Sound").

*The period is inversely proportional to the frequency.* A low period value corresponds to a higher frequency sound and a high period value corresponds to a lower frequency sound.

### **Limitations on Selection of Sampling Period**

The sampling period is limited by the number of DMA cycles allocated to an audio channel. Each audio channel is allocated one DMA slot per horizontal scan line of the screen display. An audio channel can retrieve two data samples during each horizontal scan line. The following calculation gives the maximum sampling rate in samples per second.

$$2 \text{ samples/line} * 262.5 \text{ lines/frame} * 59.94 \text{ frames/second} = 31,469 \text{ samples/second}$$

The figure of 31,469 is a theoretical maximum. In order to save buffers, the hardware is designed to handle 28,867 samples/second. The system timing interval is 279.365 nanoseconds, or .279365 microseconds. The maximum sampling rate of 28,867 samples per second is 34.642 microseconds per sample ( $1/28,867 = .000034642$ ). The formula for calculating the sampling period is:

$$\text{Period value} = \frac{\text{sample interval}}{\text{clock interval}} = \frac{\text{clock constant}}{\text{samples per second}}$$

Thus, the minimum period value is derived by dividing 34.642 microseconds per sample by the number of microseconds per interval:

$$\text{Minimum period} = \frac{34.642 \text{ microseconds/sample}}{0.279365 \text{ microseconds/interval}} = 124 \text{ timing intervals/sample}$$

or:

$$\text{Minimum period} = \frac{3,579,545 \text{ ticks/second}}{28,867 \text{ samples/second}} = 124 \text{ ticks/sample}$$

Therefore, a value of at least 124 must be written into the period register to assure that the audio system DMA will be able to retrieve the next data sample. If the period value is below 124, by the time the cycle count has reached 0, the audio DMA will not have had enough time to retrieve the next data sample and the previous sample will be reused.

28,867 samples/second is also the maximum sampling rate for PAL systems. Thus, for PAL systems, a value of at least 123 ticks/sample must be written into the period register.

<b>Clock Values</b>			
	<b>NTSC</b>	<b>PAL</b>	<b>units</b>
<b>Clock Constant</b>	3579545	3546895	ticks per second
<b>Clock Interval</b>	0.279365	0.281937	microseconds per interval

**NOTE:** The Clock Interval is derived from the clock constant, where:

$$\text{clock interval} = \frac{1}{\text{clock constant}}$$

then scale the result to microseconds. In all of these calculations ‘‘ticks’’ and ‘‘timing intervals’’ refer to the same thing.

---

### ***Specifying the Period Value***

After you have selected the desired interval between data samples, you can calculate the value to place in the period register by using the period formula:

$$\text{Period value} = \frac{\text{desired interval}}{\text{clock interval}} = \frac{\text{clock constant}}{\text{samples per second}}$$

As an example, say you wanted to produce a 1 KHz sine wave, using a table of eight data samples (four data words) (see Figure 5-3).

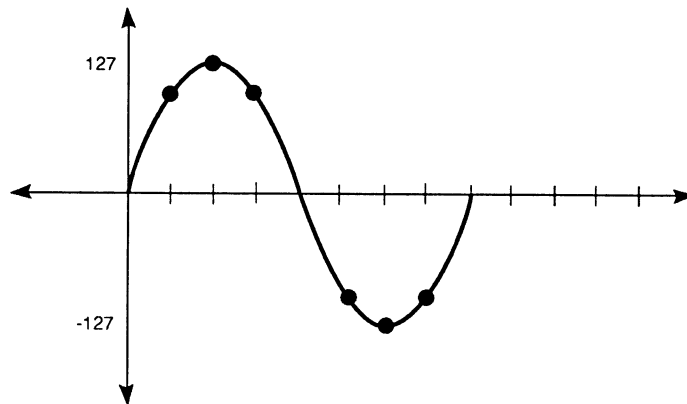

Figure 5-3: Example Sine Wave

Sampled Values:	0
	90
	127
	90
	0
	-90
	-127
	-90

---

To output the series of eight samples at 1 KHz (1,000 cycles per second), each full cycle is output in 1/1000th of a second. Therefore, each individual value must be retrieved in 1/8th of that time. This translates to 1,000 microseconds per waveform or 125 microseconds per sample. To correctly produce this waveform, the period value should be:

$$\text{Period value} = \frac{125 \text{ microseconds/sample}}{0.279365 \text{ microseconds/interval}} = 447 \text{ timing intervals/sample}$$

To set the period register, you must write the period value into the register AUDxPER, where “x” is the number of the channel you are using. For example, the following instruction shows how to write a period value of 447 into the period register for channel 0.

```
SETAUDOPERIOD:  
    LEA    CUSTOM, a0  
    MOVE.W #447, AUDOPER(a0)
```

To produce high-quality sound, avoiding aliasing distortion, you should observe the limitations on period values that are discussed in the section below called “Producing Quality Sound.”

For the relationship between period and musical pitch, see the section at the end of the chapter, which contains a listing of the equal-tempered musical scale.

---

## PLAYING THE WAVEFORM

After you have defined the audio data location, length, volume and period, you can play the waveform by starting the DMA for that audio channel. This starts the output of sound. Once started, the DMA continues until you specifically stop it. Thus, the waveform is played over and over again, producing the steady tone. The system uses the value in the location registers each time it replays the waveform.

For any audio DMA to occur (or any other DMA, for that matter), the DMAEN bit in DMACON must be set. When both DMAEN and AUDxEN are set, the DMA will start for channel x. All these bits and their meanings are shown in table 5-3.

Table 5-3: DMA and Audio Channel Enable Bits

DMACON Register		
Bit	Name	Function
15	SET/CLR	When this bit is written as a 1, it sets any bit in DMACONW for which the corresponding bit position is also a 1, leaving all other bits alone.
9	DMAEN	Only while this bit is a 1 can <i>any</i> direct memory access occur.
3	AUD3EN	Audio channel 3 enable.
2	AUD2EN	Audio channel 2 enable.
1	AUD1EN	Audio channel 1 enable.
0	AUD0EN	Audio channel 0 enable.

For example, if you are using channel 0, then you write a 1 into bit 9 to enable DMA and a 1 into bit 0 to enable the audio channel, as shown below.

```
BEGINCHAN0:  
    LEA    CUSTOM, a0  
    MOVE.W # (DMAF_SETCLR!DMAF_AUD0!DMAF_MASTER), DMACON(a0)
```

---

## STOPPING THE AUDIO DMA

You can stop the channel by writing a 0 into the AUDxEN bit at any time. However, you cannot resume the output at the same point in the waveform by just writing a 1 in the bit again. Enabling an audio channel almost always starts the data output again from the top of the list of data pointed to by the location registers for that channel. If the channel is disabled for a very short time (less than two sampling periods) it may stay on and thus continue from where it left off.

The following example shows how to stop audio DMA for one channel.

```
STOPAUDCHAN0:  
    LEA    CUSTOM, a0  
    MOVE.W # (DMAF_AUD0) , DMACON (a0)
```

## AUDIO SUMMARY

These are the steps necessary to produce a steady tone:

1. Define the waveform.
2. Create the data set containing the pairs of data samples (data words). Normally, a data set contains the definition of one waveform.
3. Set the location registers:  
  
    AUDxLCH (high three bits)  
    AUDxLCL (low fifteen bits)
4. Set the length register, AUDxLEN, to the number of data words to be retrieved before starting at the address currently in AUDxLC.
5. Set the volume register, AUDxVOL.
6. Set the period register, AUDxPER
7. Start the audio DMA by writing a 1 into bit 9, DMAEN, along with a 1 in the SET/CLR bit and a 1 in the position of the AUDxEN bit of the channel or channels you want to start.

---

## AUDIO EXAMPLE

In this example, which gathers together all of the program segments from the preceding sections, a sine wave is played through channel 0. The example assumes exclusive access to the Audio hardware, and will not work directly in a multitasking environment.

```
MAIN:
    LEA    CUSTOM,a0      ; Custom chip base address
    LEA    SINEDATA(pc),a1 ;Address of data to
                                ; audio location register 0

WHEREODATA:
    MOVE.L a1,AUD0LCH(a0) ;The 680x0 writes this as though it were a
                                ; 32-bit register at the low-bits location
                                ; (common to all locations and pointer
                                ; registers in the system).

SETAUDOLENGTH:
    MOVE.W #4,AUDOLEN(a0) ;Set length in words

SETAUDOVOLUME:
    MOVE.W #64,AUD0VOL(a0) ;Use maximum volume

SETAUDOPERIOD:
    MOVE.W #447,AUD0PER(a0)

BEGINCHANO:
    MOVE.W #(DMAF_SETCLR!DMAF_AUD0!DMAF_MASTER),DMACON(a0)

    RTS                ; Return to main code...

    DS.W    0          ;Be sure word-aligned

SINEDATA:
    DC.B    0, 90, 127, 90, 0, -90, -127, -90
    END
```



---

## Producing Complex Sounds

In addition to simple tones, you can create more complex sounds, such as different musical notes joined into a one-voice melody, different notes played at the same time, or modulated sounds.

### JOINING TONES

Tones are joined by writing the location and length registers, starting the audio output, and rewriting the registers in preparation for the next audio waveform that you wish to connect to the first one. This is made easy by the timing of the audio interrupts and the existence of back-up registers. The location and length registers are read by the DMA channel before audio output begins. The DMA channel then stores the values in back-up registers.

Once the original registers have been read by the DMA channel, you can change their values without disturbing the operation you started with the original register contents. Thus, you can write the contents of these registers, start an audio output, and then rewrite the registers in preparation for the next waveform you want to connect to this one.

Interrupts occur immediately after the audio DMA channel has read the location and length registers and stored their values in the back-up registers. Once the interrupt has occurred, you can rewrite the registers with the location and length for the next waveform segment. This combination of back-up registers and interrupt timing lets you keep one step ahead of the audio DMA channel, allowing your sound output to be continuous and smooth.

If you do not rewrite the registers, the current waveform will be repeated. Each time the length counter reaches zero, both the location and length registers are reloaded with the same values to continue the audio output.

---

## **Audio DMA Example**

This example details the system audio DMA action in a step-by-step fashion.

Suppose you wanted to join together a sine and a triangle waveform, end-to-end, for a special audio effect, alternating between them. The following sequence shows the action of your program as well as its interaction with the audio DMA system. The example assumes that the period, volume, and length of the data set remains the same for the sine wave and the triangle wave.

### **Interrupt Program**

If (wave = triangle)

    write AUD0LCL with address of sine wave data.

Else if (wave = sine)

    write AUD0LCL with address of triangle wave data.

### **Main Program**

1. Set up volume, period, and length.
2. Write AUD0LCL with address of sine wave data.
3. Start DMA.
4. Continue with something else.

### **System Response**

As soon as DMA starts,

- a. Copy to “back-up” length register from AUDOLEN.
- b. Copy to “back-up” location register from AUD0LCL (will be used as a pointer showing current data word to fetch).
- c. Create an interrupt for the 680x0 saying that it has completed retrieving working copies of length and location registers.
- d. Start retrieving audio data each allocated DMA time slot.

---

## PLAYING MULTIPLE TONES AT THE SAME TIME

You can play multiple tones either by using several channels independently or by summing the samples in several data sets, playing the summed data sets through a single channel.

Since all four audio channels are independently programmable, each channel has its own data set; thus a different tone or musical note can be played on each channel.

## MODULATING SOUND

To provide more complex audio effects, you can use one audio channel to modulate another. This increases the range and type of effects that can be produced. You can modulate a channel's frequency or amplitude, or do both types of modulation on a channel at the same time.

Amplitude modulation affects the volume of the waveform. It is often used to produce vibrato or tremolo effects. Frequency modulation affects the period of the waveform. Although the basic waveform itself remains the same, the pitch is increased or decreased by frequency modulation.

The system uses one channel to modulate another when you attach two channels. The attach bits in the ADKCON register control how the data from an audio channel is interpreted (see the table below). Normally, each channel produces sound when it is enabled. If the "attach" bit for an audio channel is set, that channel ceases to produce sound and its data is used to modulate the sound of the next higher-numbered channel. When a channel is used as a modulator, the words in its data set are no longer treated as two individual bytes. Instead, they are used as "modulator" words. The data words from the *modulator* channel are written into the corresponding registers of the *modulated* channel each time the period register of the modulator channel times out.

To modulate only the amplitude of the audio output, you must attach a channel as a volume modulator. Define the modulator channel's data set as a series of words, each containing volume information in the following format:

Bits	Function
15 - 7	Not used
6 - 0	Volume information, V6 - V0

To modulate only the frequency, you must attach a channel as a period modulator. Define the modulator channel's data set as a series of words, each containing period information in the following format:

Bits	Function
15 - 0	Period information, P15 - P0

If you want to modulate both period and volume on the same channel, you need to attach the channel as both a period and volume modulator. For instance, if channel 0 is used to modulate both the period and frequency of channel 1, you set two attach bits — bit 0 to modulate the volume and bit 4 to modulate the period. When period and volume are both modulated, words in the modulator channel's data set are defined alternately as volume and period information.

The sample set of data in Table 5-4 shows the differences in interpretation of data when a channel is used directly for audio, when it is attached as volume modulator, when it is attached as a period modulator, and when it is attached as a modulator of both volume and period.

Table 5-4: Data Interpretation in Attach Mode

<b>Data Words</b>	<b>Independent (not Modulating)</b>	<b>Modulating Both Period and Volume</b>	<b>Modulating Period Only</b>	<b>Modulating Volume Only</b>
Word 1	data   data	volume for other channel	period	volume
Word 2	data   data	period for other channel	period	volume
Word 3	data   data	volume for other channel	period	volume
Word 4	data   data	period for other channel	period	volume

The lengths of the data sets of the modulator and the modulated channels are completely independent.

Channels are attached by the system in a predetermined order, as shown in Table 5-5. To attach a channel as a modulator, you set its attach bit to 1. If you set either the volume or period attach bits for a channel, that channel's audio output will be disabled; the channel will be attached to the next higher channel, as shown in Table 5-5. Because an attached channel always modulates the next higher numbered channel, you cannot attach channel 3. Writing a 1 into channel 3's modulate bits only disables its audio output.

Table 5-5: Channel Attachment for Modulation

ADKCON Register		
Bit	Name	Function
7	ATPER3	Use audio channel 3 to modulate nothing (disables audio output of channel 3)
6	ATPER2	Use audio channel 2 to modulate <i>period</i> of channel 3
5	ATPER1	Use audio channel 1 to modulate <i>period</i> of channel 2
4	ATPER0	Use audio channel 0 to modulate <i>period</i> of channel 1
3	ATVOL3	Use audio channel 3 to modulate nothing (disables audio output of channel 3)
2	ATVOL2	Use audio channel 2 to modulate <i>volume</i> of channel 3
1	ATVOL1	Use audio channel 1 to modulate <i>volume</i> of channel 2
0	ATVOL0	Use audio channel 0 to modulate <i>volume</i> of channel 1

---

## Producing High-quality Sound

When trying to create high-quality sound, you need to consider the following factors:

- Waveform transitions.
- Sampling rate.
- Efficiency.
- Noise reduction.
- Avoidance of aliasing distortion.
- Limitations of the low pass filter.

### MAKING WAVEFORM TRANSITIONS

To avoid unpleasant sounds when you change from one waveform to another, you need to make the transitions smooth. You can avoid “clicks” by making sure the waveforms start and end at approximately the same value. You can avoid “pops” by starting a waveform only at a zero-crossing point. You can avoid “thumps” by arranging the average amplitude of each wave to be about the same value. The average amplitude is the sum of the bytes in the waveform divided by the number of bytes in the waveform.

### SAMPLING RATE

If you need high precision in your frequency output, you may find that the frequency you wish to produce is somewhere between two available sampling rates, but not close enough to either rate for your requirements. In those cases, you may have to adjust the length of the audio data table in addition to altering the sampling rate.

For higher frequencies, you may also need to use audio data tables that contain more than one full cycle of the audio waveform to reproduce the desired frequency more accurately, as illustrated in Figure 5-4.

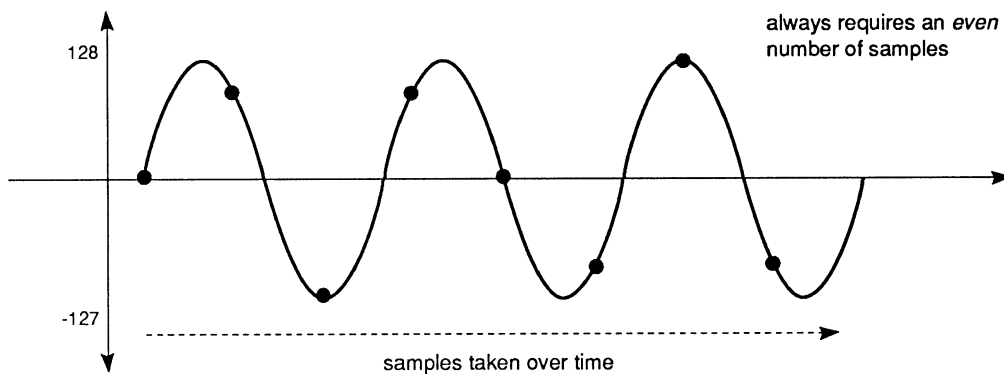

This shows a case in which a high-frequency waveform may need more than one full cycle to accurately reproduce the periodic waveform.

Figure 5-4: Waveform with Multiple Cycles

## EFFICIENCY

A certain amount of overhead is involved in the handling of audio DMA. If you are trying to produce a smooth continuous audio synthesis, you should try to avoid as much of the system control overhead as possible. Basically, the larger the audio buffer you provide to the system, the less often it will need to interrupt to reset the pointers to the top of the next buffer and, coincidentally, the lower the amount of system interaction that will be required. If there is only one waveform buffer, the hardware automatically resets the pointers, so no software overhead is used for resetting them.

The “Joining Tones” section illustrated how you could join “ends” of tones together by responding to interrupts and changing the values of the location registers to splice tones together. If your system is heavily loaded, it is possible that the response to the interrupt might not happen in time to assure a smooth audio transition. Therefore, it is advisable to utilize the longest possible audio table where a smooth output is required. This takes advantage of the audio DMA capability as well as minimizing the number of interrupts to which the 680x0 must respond.

---

## **NOISE REDUCTION**

To reduce noise levels and produce an accurate sound, try to use the full range of -128 to 127 when you represent a waveform. This reduces how much noise (quantization error) will be added to the signal by using more bits of precision. Quantization noise is caused by the introduction of round-off error. If you are trying to reproduce a signal, such as a sine wave, you can represent the amplitude of each sample with only so many digits of accuracy. The difference between the real number and your approximation is round-off error, or noise.

By doubling the amplitude, you create half as much noise because the size of the steps of the wave form stays the same and is therefore a smaller fraction of the amplitude.

In other words, if you try to represent a waveform using, for example, a range of only +3 to -3, the size of the error in the output would be considerably larger than if you use a range of +127 to -128 to represent the same signal. Proportionally, the digital value used to represent the waveform amplitude will have a lower error. As you increase the number of possible sample levels, you decrease the relative size of each step and, therefore, decrease the size of the error.

To produce quiet sounds, continue to define the waveform using the full range, but adjust the volume. This maintains the same level of accuracy (signal-to-noise ratio) for quiet sounds as for loud sounds.

## **ALIASING DISTORTION**

When you use sampling to produce a waveform, a side effect is caused when the sampling rate "beats" or combines with the frequency you wish to produce. This produces two additional frequencies, one at the sampling rate plus the desired frequency and the other at the sampling rate minus the desired frequency. This phenomenon is called aliasing distortion.

Aliasing distortion is eliminated when the sampling rate exceeds the output frequency by at least 7 KHz. This puts the beat frequency outside the range of the low-pass filter, cutting off the undesirable frequencies. Figure 5-5 shows a frequency domain plot of the anti-aliasing low-pass filter used in the system.



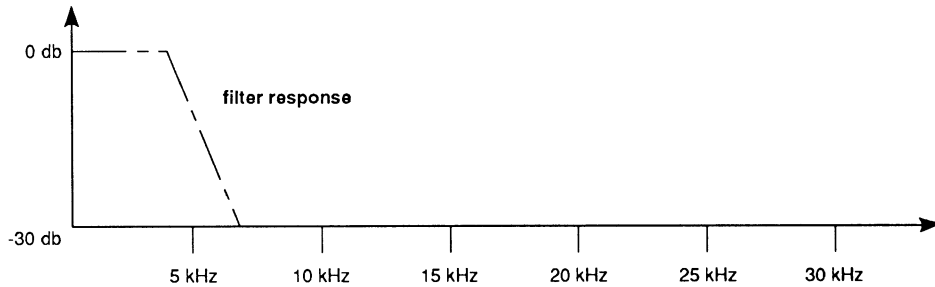

Filter passes all frequencies below about 5 kHz.

Figure 5-5: Frequency Domain Plot of Low-Pass Filter

Figure 5-6 shows that it is permissible to use a 12 KHz sampling rate to produce a 4 KHz waveform. Both of the beat frequencies are outside the range of the filter, as shown in these calculations:

$$12 + 4 = 16 \text{ KHz}$$

$$12 - 4 = 8 \text{ KHz}$$

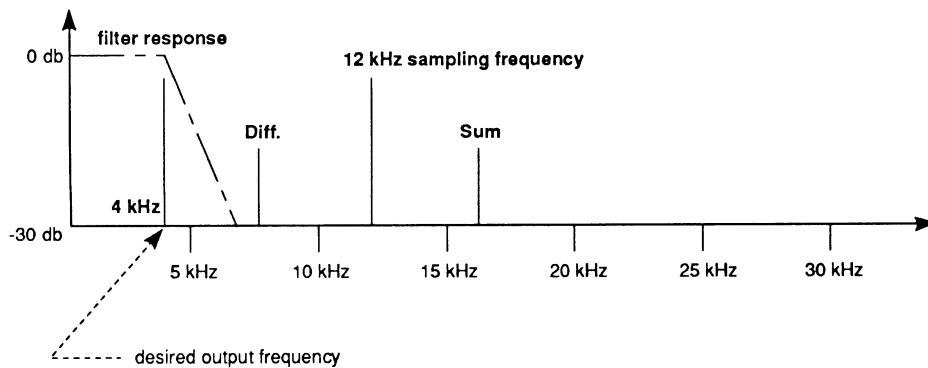

Figure 5-6: Noise-free Output (No Aliasing Distortion)

You can see in Figure 5-7 that it is unacceptable to use a 10 KHz sampling rate to produce a 4 KHz waveform. One of the beat frequencies (10 - 4) is within the range of the filter, allowing some of that undesirable frequency to show up in the audio output.

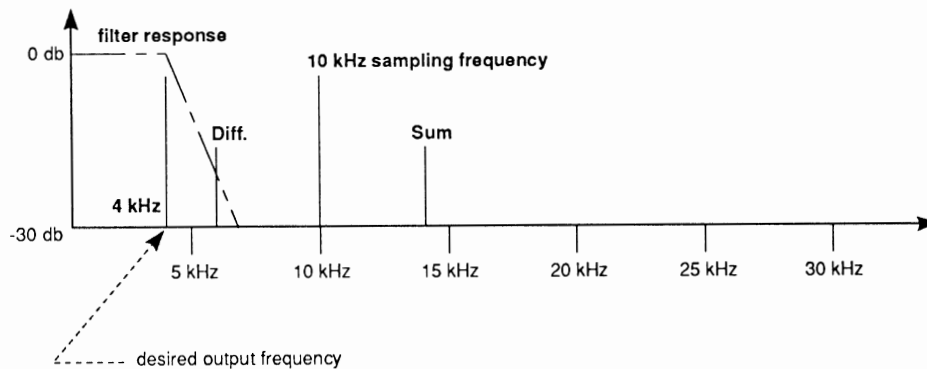

Figure 5-7: Some Aliasing Distortion

All of this gives rise to the following equation, showing that the sampling frequency must exceed the output frequency by at least 7 KHz, so that the beat frequency will be above the cutoff range of the anti-aliasing filter:

$$\text{Minimum sampling rate} = \text{highest frequency component} + 7 \text{ KHz}$$

The frequency component of the equation is stated as “highest frequency component” because you may be producing a complex waveform with multiple frequency elements, rather than a pure sine wave.

## LOW-PASS FILTER

The system includes a low-pass filter that eliminates aliasing distortion as described above. This filter becomes active around 4 KHz and gradually begins to attenuate (cut off) the signal. Generally, you cannot clearly hear frequencies higher than 7 KHz. Therefore, you get the most complete frequency response in the frequency range of 0 - 7 KHz. If you are making frequencies from 0 to 7 KHz, you should select a sampling rate no less than 14 KHz, which corresponds to a sampling period in the range 124 to 256.

---

At a sampling period around 320, you begin to lose the higher frequency values between 0 KHz and 7 KHz, as shown in Table 5-6.

Table 5-6: Sampling Rate and Frequency Relationship

	Sampling Period	Sampling Rate (KHz)	Maximum Output Frequency (KHz)
Maximum sampling rate	124	29	7
Minimum sampling rate for 7 KHz output	256	14	7
Sampling rate too low for 7 KHz output	320	11	4

In A2000's with 2 layer motherboards and later A500 models there is a control bit that allows the audio output to bypass the low pass filter. This control bit is the same output bit of the 8520 CIA that controls the brightness of the red "power" LED (CIA A \$BFE001 - Bit 1: /LED). Bypassing the filter allows for improved sound in some applications, but an external filter with an appropriate cutoff frequency may be required.

## Using Direct (Non-DMA) Audio Output

It is possible to create sound by writing audio data one word at a time to the audio output addresses, instead of setting up a list of audio data in memory. This method of controlling the output is more processor-intensive and is therefore not recommended.

To use direct audio output, do not enable the DMA for the audio channel you wish to use; this changes the timing of the interrupts. The normal interrupt occurs after a data address has been read; in direct audio output, the interrupt occurs after one data word has been output.

Unlike in the DMA-controlled automatic data output, in direct audio output, if you do not write a new set of data to the output addresses before two sampling intervals have elapsed, the audio output will cease changing. The last value remains as an output of the digital-to-analog converter.

The volume and period registers are set as usual.

## The Equal-tempered Musical Scale

Table 5-7 gives a close approximation of the equal-tempered scale over one octave when the sample size is 16 bytes. The "Period" column gives the period count you enter into the period register. The length register AUDxLEN should be set to 8 (16 bytes = 8 words). The sample should represent one cycle of the waveform.

Table 5-7: Equal-tempered Octave for a 16 Byte Sample

NTSC Period	PAL Period	Note	Ideal Frequency	Actual NTSC Frequency	Actual PAL Frequency
254	252	A	880.0	880.8	879.7
240	238	A#	932.3	932.2	931.4
226	224	B	987.8	989.9	989.6
214	212	C	1046.5	1045.4	1045.7
202	200	C#	1108.7	1107.5	1108.4
190	189	D	1174.7	1177.5	1172.9
180	178	D#	1244.5	1242.9	1245.4
170	168	E	1318.5	1316.0	1319.5
160	159	F	1396.9	1398.3	1394.2
151	150	F#	1480.0	1481.6	1477.9
143	141	G	1568.0	1564.5	1572.2
135	133	G#	1661.2	1657.2	1666.8

The table above shows the period values to use with a 16 byte sample to make tones in the second octave above middle C. To generate the tones in the lower octaves, there are two methods you can use, doubling the period value or doubling the sample size.

When you double the period, the time between each sample is doubled so the sample takes twice as long to play. This means the frequency of the tone generated is cut in half which gives you the next lowest octave. Thus, if you play a C with a period value of 214, then playing the same sample with a period value of 428 will play a C in the next lower octave.

Likewise, when you double the sample size, it will take twice as long to play back the whole sample and the frequency of the tone generated will be in the next lowest octave. Thus, if you have an 8 byte sample and a 16 byte sample of the same waveform played at the same speed, the 16 byte sample will be an octave lower.

A sample for an equal-tempered scale typically represents one full cycle of a note. To avoid aliasing distortion with these samples you should use period values in the range 124-256 only. Periods from 124-256 correspond to playback rates in the range 14-28K samples per second which makes the most effective use of the Amiga's 7 KHz cut-off filter to prevent noise. To stay within this range you will need a different sample for each octave.

---

If you cannot use a different sample for each octave, then you will have to adjust the period value over its full range 124-65536. This is easier for the programmer but can produce undesirable high-frequency noise in the resulting tone. Read the section called “Aliasing Distortion” for more about this.

The values in Table 5-7 were generated using the formula shown below. To calculate the tone generated with a given sample size and period use:

$$Frequency = \frac{Clock\ Constant}{Sample\ Bytes * Period} = \frac{3579545}{16 * Period} = 880.8Hz$$

The clock constant in an NTSC system is 3579545 ticks per second. In a PAL system, the clock constant is 3546895 ticks per second. Sample bytes is the number of bytes in one cycle of the waveform sample. (The clock constant is derived from dividing the system clock value by 2. The value will vary when using an external system clock, such as a genlock.)

Using the formula above you can generate the values needed for the even-tempered scale for any arbitrary sample. Table 5-8 gives a close approximation of a five octave even tempered-scale using five samples. The values were derived using the formula above. Notice that in each octave period values are the same but the sample size is halved. The samples listed represent a simple triangular wave form.

Table 5-8: Five Octave Even-tempered Scale

NTSC Period	PAL Period	Note	Ideal Frequency	Actual NTSC Frequency	Actual PAL Frequency
254	252	A	55.00	55.05	54.98
240	238	A#	58.27	58.26	58.21
226	224	B	61.73	61.87	61.85
214	212	C	65.40	65.34	65.35
202	200	C#	69.29	69.22	69.27
190	189	D	73.41	73.59	73.30
180	178	D#	77.78	77.68	77.83
170	168	E	82.40	82.25	82.47
160	159	F	87.30	87.39	87.13
151	150	F#	92.49	92.60	92.36
143	141	G	98.00	97.78	98.26
135	133	G#	103.82	103.57	104.17

Sample size = 256 bytes, AUDxLEN = 128

254	252	A	110.00	110.10	109.96
240	238	A#	116.54	116.52	116.43
226	224	B	123.47	123.74	123.70
214	212	C	130.81	130.68	130.71
202	200	C#	138.59	138.44	138.55
190	189	D	146.83	147.18	146.61
180	178	D#	155.56	155.36	155.67
170	168	E	164.81	164.50	164.94
160	159	F	174.61	174.78	174.27
151	150	F#	184.99	185.20	184.73
143	141	G	196.00	195.56	196.52
135	133	G#	207.65	207.15	208.35

Sample size = 128 bytes, AUDxLEN = 64

254	252	A	220.00	220.20	219.92
240	238	A#	233.08	233.04	232.86
226	224	B	246.94	247.48	247.41
214	212	C	261.63	261.36	261.42
202	200	C#	277.18	276.88	277.10
190	189	D	293.66	294.37	293.23
180	178	D#	311.13	310.72	311.35
170	168	E	329.63	329.00	329.88
160	159	F	349.23	349.56	348.55
151	150	F#	369.99	370.40	369.47
143	141	G	392.00	391.12	393.05
135	133	G#	415.30	414.30	416.70

Sample size = 64 bytes, AUDxLEN = 32

NTSC Period	PAL Period	Note	Ideal Frequency	Actual NTSC Frequency	Actual PAL Frequency
254	252	A	440.0	440.4	439.8
240	238	A#	466.16	466.09	465.72
226	224	B	493.88	494.96	494.82
214	212	C	523.25	522.71	522.83
202	200	C#	554.37	553.77	554.20
190	189	D	587.33	588.74	586.46
180	178	D#	622.25	621.45	622.70
170	168	E	659.26	658.00	659.76
160	159	F	698.46	699.13	697.11
151	150	F#	739.99	740.80	738.94
143	141	G	783.99	782.24	786.10
135	133	G#	830.61	828.60	833.39

Sample size = 32 bytes, AUDxLEN = 16

254	252	A	880.0	880.8	879.7
240	238	A#	932.3	932.2	931.4
226	224	B	987.8	989.9	989.6
214	212	C	1046.5	1045.4	1045.7
202	200	C#	1108.7	1107.5	1108.4
190	189	D	1174.7	1177.5	1172.9
180	178	D#	1244.5	1242.9	1245.4
170	168	E	1318.5	1316.0	1319.5
160	159	F	1396.9	1398.3	1394.2
151	150	F#	1480.0	1481.6	1477.9
143	141	G	1568.0	1564.5	1572.2
135	133	G#	661.2	1657.2	1666.8

Sample size = 16 bytes, AUDxLEN = 8

### 256 Byte Sample

0	2	4	6	8	10	12	14	16	18	20	22	24	26	28	30
32	34	36	38	40	42	44	46	48	50	52	54	56	58	60	62
64	66	68	70	72	74	76	78	80	82	84	86	88	90	92	94
96	98	100	102	104	106	108	110	112	114	116	118	120	122	124	126
128	126	124	122	120	118	116	114	112	110	108	106	104	102	100	98
96	94	92	90	88	86	84	82	80	78	76	74	72	70	68	66
64	62	60	58	56	54	52	50	48	46	44	42	40	38	36	34
32	30	28	26	24	22	20	18	16	14	12	10	8	6	4	2
0	-2	-4	-6	-8	-10	-12	-14	-16	-18	-20	-22	-24	-26	-28	-30
-32	-34	-36	-38	-40	-42	-44	-46	-48	-50	-52	-54	-56	-58	-60	-62
-64	-66	-68	-70	-72	-74	-76	-78	-80	-82	-84	-86	-88	-90	-92	-94
-96	-98	-100	-102	-104	-106	-108	-110	-112	-114	-116	-118	-120	-122	-124	-126
-127	-126	-124	-122	-120	-118	-116	-114	-112	-110	-108	-106	-104	-102	-100	-98
-96	-94	-92	-90	-88	-86	-84	-82	-80	-78	-76	-74	-72	-70	-68	-66
-64	-62	-60	-58	-56	-54	-52	-50	-48	-46	-44	-42	-40	-38	-36	-34
-32	-30	-28	-26	-24	-22	-20	-18	-16	-14	-12	-10	-8	-6	-4	-2

### 128 Byte Sample

0	4	8	12	16	20	24	28	32	36	40	44	48	52	56	60
64	68	72	76	80	84	88	92	96	100	104	108	112	116	120	124
128	124	120	116	112	108	104	100	96	92	88	84	80	76	72	68
64	60	56	52	48	44	40	36	32	28	24	20	16	12	8	4
0	4	8	12	16	20	24	28	32	36	40	44	48	52	56	60
64	68	72	76	80	84	88	92	96	100	104	108	112	116	120	124
-127	-124	-120	-116	-112	-108	-104	-100	-96	-92	-88	-84	-80	-76	-72	-68
-64	-60	-56	-52	-48	-44	-40	-36	-32	-28	-24	-20	-16	-12	-8	-4

### 64 Byte Sample

0	8	16	24	32	40	48	56	64	72	80	88	96	104	112	120
128	120	112	104	96	88	80	72	64	56	48	40	32	24	16	8
0	-8	-16	-24	-32	-40	-48	-56	-64	-72	-80	-88	-96	-104	-112	-120
-127	-120	-112	-104	-96	-88	-80	-72	-64	-56	-48	-40	-32	-24	-16	-8

### 32 Byte Sample

0	16	32	48	64	80	96	112	128	112	96	80	64	48	32	16
0	-16	-32	-48	-64	-80	-96	-112	-127	-112	-96	-80	-64	-48	-32	-16

### 16 Byte Sample

0	32	64	96	128	96	64	32	0	-32	-64	-96	-127	-96	-64	-32
---	----	----	----	-----	----	----	----	---	-----	-----	-----	------	-----	-----	-----



---

## Decibel Values for Volume Ranges

Table 5-9 provides the corresponding decibel values for the volume ranges of the Amiga system.

Table 5-9: Decibel Values and Volume Ranges

Volume	Decibel Value	Volume	Decibel Value
64	0.0	32	-6.0
63	-0.1	31	-6.3
62	-0.3	30	-6.6
61	-0.4	29	-6.9
60	-0.6	28	-7.2
59	-0.7	27	-7.5
58	-0.9	26	-7.8
57	-1.0	25	-8.2
56	-1.2	24	-8.5
55	-1.3	23	-8.9
54	-1.5	22	-9.3
53	-1.6	21	-9.7
52	-1.8	20	-10.1
51	-2.0	19	-10.5
50	-2.1	18	-11.0
49	-2.3	17	-11.5
48	-2.5	16	-12.0
47	-2.7	15	-12.6
46	-2.9	14	-13.2
45	-3.1	13	-13.8
44	-3.3	12	-14.5
43	-3.5	11	-15.3
42	-3.7	10	-16.1
41	-3.9	9	-17.0
40	-4.1	8	-18.1
39	-4.3	7	-19.2
38	-4.5	6	-20.6
37	-4.8	5	-22.1
36	-5.0	4	-24.1
35	-5.2	3	-26.6
34	-5.5	2	-30.1
33	-5.8	1	-36.1
		0	Minus infinity

---

## The Audio State Machine

For an explanation of the various states, refer to Figure 5-8. There is one audio state machine for each channel. The machine has eight states and is clocked at the clock constant rate (3.58 MHz NTSC). Three of the states are basically unused and just transfer back to the idle (000) state. One of the paths out of the idle state is designed for interrupt-driven operation (processor provides the data), and the other path is designed for DMA-driven operation (the “Agnus” special chip provides the data).

In interrupt-driven operation, transfer to the main loop (states 010 and 011) occurs immediately after data is written by the processor. In the 010 state the upper byte is output, and in the 011 state the lower byte is output. Transitions such as 010→011→010 occur whenever the period counter counts down to one. The period counter is reloaded at these transitions. As long as the interrupt is cleared by the processor in time, the machine remains in the main loop. Otherwise, it enters the idle state. Interrupts are generated on every word transition (011→010).

In DMA-driven operation, transition to the 001 state occurs and DMA requests are sent to Agnus as soon as DMA is turned on. Because of pipelining in Agnus, the first data word must be thrown away. State 101 is entered as soon as this word arrives; a request for the next data word has already gone out. When the data arrives, state 010 is entered and the main loop continues until the DMA is turned off. The length counter counts down once with each word that comes in. When it finishes, a DMA restart request goes to Agnus along with the regular DMA request. This tells Agnus to reset the pointer to the beginning of the table of data. Also, the length counter is reloaded and an interrupt request goes out soon after the length counter finishes (counts to one). The request goes out just as the last word of the waveform starts its output.

DMA requests and restart requests are transferred to Agnus once each horizontal line, and the data comes back about 14 clock cycles later (the duration of a clock cycle is 280 ns).

In attach mode, things run a little differently. In attach volume, requests occur as they do in normal operation (on the 011→010 transition). In attach period, a set of requests occurs on the 010→011 transition. When both attach period and attach volume are high, requests occur on both transitions.

If the sampling rate is set much higher than the normal maximum sampling rate (approximately 29 KHz), the two samples in the buffer register will be repeated. If the filter on the Amiga is bypassed and the volume is set to the maximum (\$40), this feature can be used to make modulated carriers up to 1.79 MHz. The modulation is placed in the memory map, with plus values in the even bytes and minus values in the odd bytes.

The symbols used in the state diagram are explained in the following list. Upper-case names indicate external signals; lower-case names indicate local signals.

AUDxON          DMA on “x” indicates channel number (signal from DMACON).

AUDxIP	Audio interrupt pending (input to channel from interrupt circuitry).
AUDxIR	Audio interrupt request (output from channel to interrupt circuitry)
intreq1	Interrupt request that combines with intreq2 to form AUDxIR..
intreq2	Prepare for interrupt request. Request comes out after the next 011→010 transition in normal operation.
AUDxDAT	Audio data load signal. Loads 16 bits of data to audio channel.
AUDxDR	Audio DMA request to Agnus for one word of data.
AUDxDSR	Audio DMA request to Agnus to reset pointer to start of block.
dmasen	Restart request enable.
percntrld	Reload period counter from back-up latch typically written by processor with AUDxPER (can also be written by attach mode).
percount	Count period counter down one latch.
perfin	Period counter finished (value = 1).
lencntrld	Reload length counter from back-up latch.
lencount	Count length counter down one notch.
lenfin	Length counter finished (value = 1).
volcntrld	Reload volume counter from back-up latch.
pbufld1	Load output buffer from holding latch written to by AUDxDAT.
pbufld2	Like pbufld1, but only during 010→011 with attach period.
AUDxAV	Attach volume. Send data to volume latch of next channel instead of to D→A converter.
AUDxAP	Attach period. Send data to period latch of next channel instead of to the D→A converter.
penhi	Enable the high 8 bits of data to go to the D→A converter.
napnav	$\text{/AUDxAV} * \text{/AUDxAP} + \text{AUDxAV}$ —no attach stuff or else attach volume. Condition for normal DMA and interrupt requests.

sq2,1,0

The name of the state flip-flops, MSB to LSB.

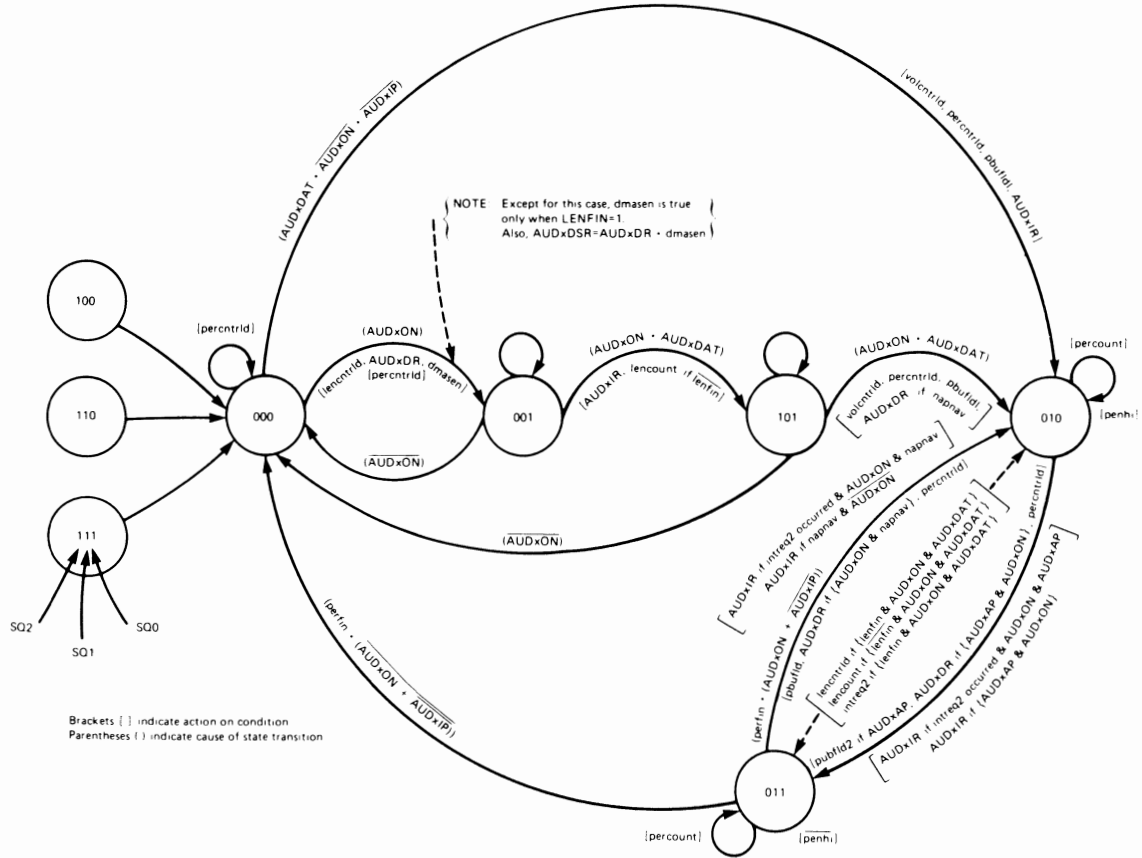

Figure 5-8: Audio State Diagram

*ECS Audio.* For information on the audio hardware in the Enhanced Chip Set, see the ECS register map in Appendix C.





---

## chapter six

# BLITTER HARDWARE

This chapter covers the operation of the Amiga's blitter, the high speed line drawing and block movement component of the system. The discussion is divided into three parts: blitter basics, blitter area fill mode, and blitter line draw mode. Some example blitter operations are listed at the end of the chapter.

For information concerning the blitter hardware in the Enhanced Chip Set, see Appendix C.

### What is the Blitter?

The blitter is one of the two coprocessors in the Amiga. Part of the Agnus chip, it is used to copy rectangular blocks of memory around and to draw lines. When copying memory, it is approximately twice as fast as the 68000, able to move almost four megabytes per second. It can draw lines at almost a million pixels per second.

In block move mode, the blitter can perform any logical operation on up to three source areas, it can shift up to two of the source areas by one to fifteen bits, it can fill outlined shapes, and it can mask the first and last words of each raster row. In line mode, any pattern can be imposed on a line, or the line can be drawn such that only one pixel per horizontal line is set.

The blitter can only access Chip memory — that portion of memory accessible by the display hardware. Attempting to use the blitter to read or write Fast or other non-Chip memory may result in destruction of the contents of Chip memory.

A “blit” is a single operation of the blitter — perhaps the drawing of a line or movement of a block of memory. A blit is performed by initializing the blitter registers with appropriate values and then starting the blitter by writing the BLTSIZE register. As the blitter is an asynchronous coprocessor, the 680x0 CPU continues to run as the blit is executing.

---

## Memory Layout

The blitter is a word blitter, not a bit blitter. All data fetched, modified, and written are in full 16-bit words. Through careful programming, the blitter can do many “bit” type operations.

The blitter is particularly well suited to graphics operations. As an example, a 320 by 200 screen set up to display 16 colors is organized as four bitplanes of 8,000 bytes each. Each bitplane consists of 200 rows of 40 bytes or 20 16-bit words. (From here on, a “word” will mean a 16-bit word.)

## DMA Channels

The blitter has four DMA channels — three source channels, labeled A, B, and C, and one destination channel, called D. Each of these channels has separate address pointer, modulo and data registers and an enable bit. Two have shift registers, and one has a first and last word mask register. All four share a single blit size register.

The address pointer registers are each composed of two words, named BLTxPTH and BLTxPTL. (Here and later, in referring to a register, any “x” in the name should be replaced by the channel label, A, B, C, or D.) The two words of each register are adjacent in the 68000 address space, with the high address word first, so they can both be written with one 32-bit write from the processor. The pointer registers should be written with an address in bytes. Because the blitter works only on words, the least significant bit of the address is ignored. Because only Chip memory is accessible, some of the most significant bits will be ignored as well. On machines with 512 KB of Chip memory, the most significant 13 bits are ignored. On machines with more Chip memory, fewer bits will be ignored. A valid, even, Chip memory address should always be written to these registers.

*Set unused bits to zero.* Be sure to write zeros to all unused bits in the custom chip registers. These bits may be used by later versions of the custom chips. Writing non-zero values to these bits may cause unexpected results on future machines.

Each of the DMA channels can be independently enabled or disabled. The enable bits are bits SRCA, SRCB, SRCC, and DEST in control register zero (BLTCON0).

When disabled, no memory cycles will be executed for that channel and, for a source channel, the constant value stored in the data register of that channel will be used for each blitter cycle. For this purpose, each of the three source channels have preloadable data registers, called BLTxDAT.



---

Images in memory are usually stored in a linear fashion; each word of data on a line is located at an address that is one greater than the word on its left. i.e. Each line is a “plus one” continuation of the previous line.

20	21	22	23	24	25	26
27	28	29	30	31	32	33
34	35	36	37	38	39	40
41	42	43	44	45	46	47
48	49	50	51	52	53	54
55	56	57	58	59	60	61

Figure 6-1: How Images are Stored in Memory

The map in Figure 6-1 represents a single bitplane (one bit of color) of an image at word addresses 20 through 61. Each of these addresses accesses one word (16 pixels) of a single bitplane. If this image required sixteen colors, four bitplanes like this would be required in memory, and four copy (move) operations would be required to completely move the image.

The blitter is very efficient at copying such blocks because it needs to be told only the starting address (20), the destination address, and the size of the block (height = 6, width = 7). It will then automatically move the data, one word at a time, whenever the data bus is available. When the transfer is complete, the blitter will signal the processor with a flag and an interrupt.

**NOTE:** This copy (move) operation operates on memory and may or may not change the memory currently being used for display.

All data copy blits are performed as rectangles of words, with a given width and height. All four DMA channels use a single blit size register, called BLTSIZE, used for both the width and height. The width can take a value of from 1 to 64 words (16 to 1024 bits). The height can run from 1 to 1024 rows. The width is stored in the least significant six bits of the BLTSIZE register. If a value of zero is stored, a width count of 64 words is used. This is the only parameter in the blitter that is given in words. The height is stored in the upper ten bits of the BLTSIZE register, with zero representing a height of 1024 rows. Thus, the largest blit possible with the current Amiga blitter is 1024 by 1024 pixels. However, shifting and masking operations may require an extra word be fetched for each raster scan line, making the maximum practical horizontal width 1008 pixels.

**Blitter counting.** To emphasize the above paragraph: Blit width is in *words* with a zero representing 64 words. Blit height is in *lines* with a zero representing 1024 lines.

---

The blitter also has facilities, called *modulos*, for accessing images smaller than the entire bitplane. Each of the four DMA channels has a 16-bit modulo register called BLT<sub>x</sub>MOD. As each word is fetched (or written) for an enabled channel, the address pointer register is incremented by two (two bytes, or one word). After each row of the blit is completed, the signed 16-bit modulo value for that DMA channel is added to the address pointer. (A row is defined by the width stored in BLTSIZE.)

*About blitter modulos.* The modulo values are in bytes, not words. Since the blitter can only operate on words, the least significant bit is ignored. The value is sign-extended to the full width of the address pointer registers. Negative modulos can be useful in a variety of ways, such as repeating a row by setting the modulo to the negative of the width of the bitplane.

As an example, suppose we want to operate on a section of a full 320 by 200 pixel bitmap that started at row 13, byte 12 (where both are numbered from zero) and the section is 10 bytes wide. We would initialize the pointer register to the address of the bitplane plus 40 bytes per row times 13 rows, plus 12 bytes to get to the correct horizontal position. We would set the width to 5 words (10 bytes). At the end of each row, we would want to skip over 30 bytes to get to the beginning of the next row, so we would use a modulo value of 30. In general, the width (in words) times two plus the modulo value (in bytes) should equal the full width, in bytes, of the bitplane containing the image.

These calculations are illustrated in Figure 6-1 which shows the required values used in the blitter registers BLT<sub>x</sub>MOD and BLT<sub>x</sub>PTR.

*About the blitter and ECS.* The blitter size and pointer registers have increased range under the Enhanced Chip Set (ECS). With the original version of the Amiga's custom chips, blits were limited to 1008 by 1024 pixels. With the ECS version of the custom chips, up to 32K by 32K pixel blits are possible. Refer to Appendix C for more information on ECS and the blitter registers.

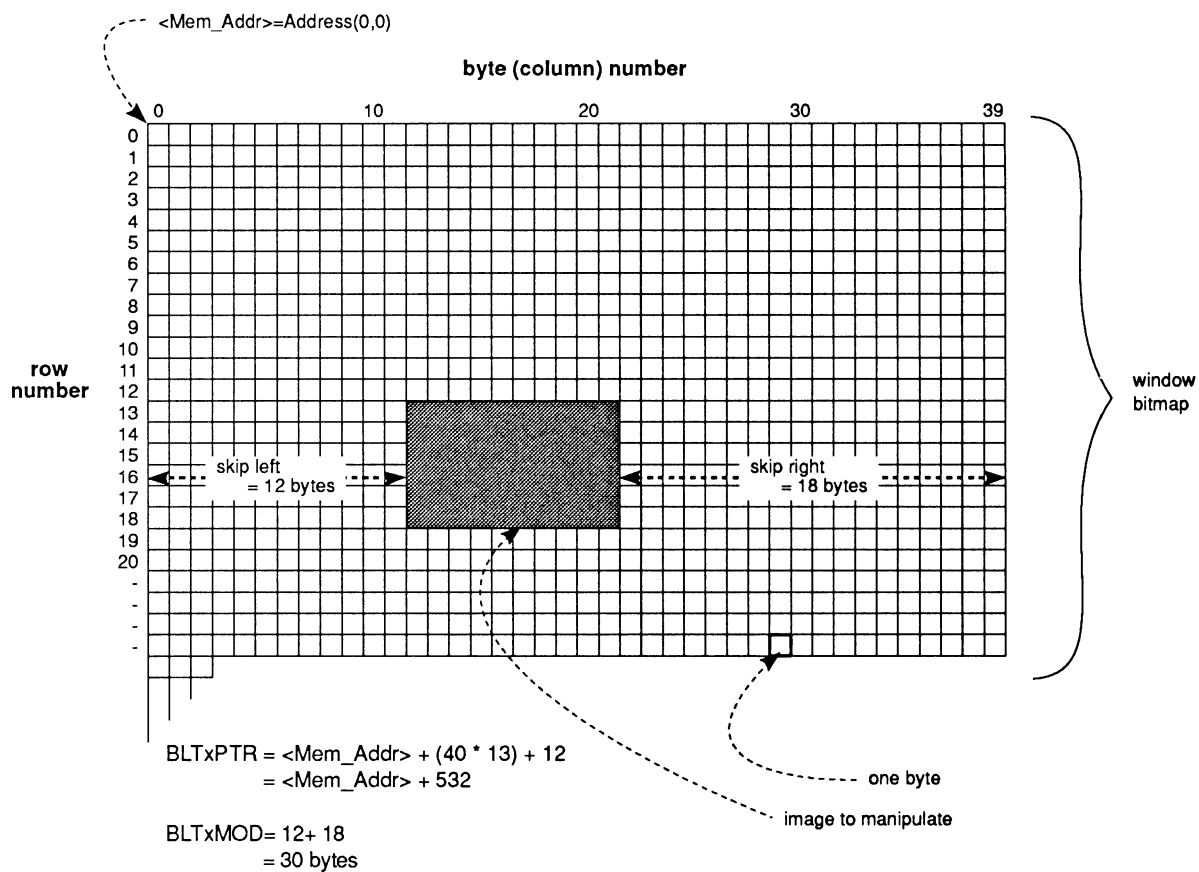

Figure 6-2: BLTxPTR and BLTxMOD calculations

**NOTE:** The blitter can be used to process linear rather than rectangular regions by setting the horizontal or vertical count in BLTSIZE to 1.

Because each DMA channel has its own modulo register, data can be moved among bitplanes of different widths. This is most useful when moving small images into larger screen bitplanes.

---

## Function Generator

The blitter can combine the data from the three source DMA channels in up to 256 different ways to generate the values stored by the destination DMA channel. These sources might be one bitplane from each of three separate graphics images. While each of these sources is a rectangular region composed of many points, the same logic operation will be performed on each point throughout the rectangular region. Thus, for purposes of defining the blitter logic operation it is only necessary to consider what happens for all of the possible combinations of one bit from each of the three sources.

There are eight possible combinations of values of the three bits, for each of which we need to specify the corresponding destination bit as a zero or one. This can be visualized with a standard truth table, as shown below. We have listed the three source channels, and the possible values for a single bit from each one.

A	B	C	D	BLTCON0 position	Minterm
0	0	0	?	0	$\overline{ABC}$
0	0	1	?	1	$\overline{AB}C$
0	1	0	?	2	$\overline{A}BC$
0	1	1	?	3	$\overline{A}BC$
1	0	0	?	4	$A\overline{B}\overline{C}$
1	0	1	?	5	$A\overline{B}C$
1	1	0	?	6	$AB\overline{C}$
1	1	1	?	7	$ABC$

This information is collected in a standard format, the LF control byte in the BLTCON0 register. This byte programs the blitter to perform one of the 256 possible logic operations on three sources for a given blit.

To calculate the LF control byte in BLTCON0, fill in the truth table with desired values for D, and read the function value from the bottom of the table up.

For example, if we wanted to set all bits in the destination where the corresponding A source bit is 1 or the corresponding B source bit is 1, we would fill in the last four entries of the truth table with 1 (because the A bit is set) and the third, fourth, seven, and eight entries with 1 (because the B bit is set), and all others (the first and second) with 0, because neither A nor B is set. Then, we read the truth table from the bottom up, reading 11111100, or \$FC.

For another example, an LF control byte of \$80 (= 1000 0000 binary) turns on bits only for those points of the D destination rectangle where the corresponding bits of A, B, and C sources were all on ( $ABC = 1$ , bit 7 of LF on). All other points in the rectangle, which correspond to other combinations for A, B, and C, will be 0. This is because bits 6 through 0 of the LF control byte, which specify the D output for these situations, are set to 0.

---

## DESIGNING THE LF CONTROL BYTE WITH MINTERMS

One approach to designing the LF control byte uses logic equations. Each of the rows in the truth table corresponds to a ‘minterm’, which is a particular assignment of values to the A, B, and C bits. For instance, the first minterm is usually written  $\overline{A}\overline{B}\overline{C}$ , or ‘not A and not B and not C’. The last is written as  $ABC$ .

*Blitter logic.* Two terms that are adjacent are AND’ed, and two terms that are separated by ‘+’ are OR’ed. AND has a higher precedence, so  $AB + BC$  is equal to  $(AB) + (BC)$ .

Any function can be written as a sum of minterms. If we wanted to calculate the function where  $D$  is one when the A bit is set and the C bit is clear, or when the B bit is set, we can write that as  $A\overline{C}+B$ , or ‘A and not C or B’. Since ‘1 and A’ is ‘A’:

$$D = A\overline{C} + B$$

$$D = A(1)\overline{C} + (1)B(1)$$

Since either A or  $\overline{A}$  is true ( $1 = A + \overline{A}$ ), and similarly for B, and C; we can expand the above equation further:

$$D = A(1)\overline{C} + (1)B(1)$$

$$D = A(B + \overline{B})\overline{C} + (A + \overline{A})B(C + \overline{C})$$

$$D = A\overline{B}\overline{C} + A\overline{B}C + A\overline{B}C + A\overline{B}\overline{C} + \overline{A}B(C + \overline{C})$$

$$D = A\overline{B}\overline{C} + A\overline{B}C + A\overline{B}C + A\overline{B}\overline{C} + \overline{A}BC + \overline{A}B\overline{C}$$

After eliminating duplicates, we end up with the five minterms:

$$\overline{A}\overline{C}+B = \overline{A}\overline{B}\overline{C} + \overline{A}B\overline{C} + A\overline{B}C + \overline{A}BC + \overline{A}B\overline{C}$$

These correspond to BLTCON0 bit positions of 6, 4, 7, 3, and 2, according to our truth table, which we would then set, and clear the rest.

The wide range of logic operations allow some sophisticated graphics techniques. For instance, you can move the image of a car across some pre-existing building images with a few blits. Producing this effect requires pre-drawn images of the car, the buildings (or background), and a car ‘mask’ that contains bits set wherever the car image is not transparent. This mask can be visualized as the shadow of the car from a light source at the same position as the viewer.

---

*About mask bitplanes.* The mask for the car need only be a single bitplane regardless of the depth of the background bitplane. This mask can be used in turn on each of the background bitplanes.

To animate the car, first save the background image where the car will be placed. Next copy the car to its first location with another blit. Your image is now ready for display. To create the next image, restore the old background, save the next portion of the background where the car will be, and redraw the car, using three separate blits. (This technique works best with beam-synchronized blits or double buffering.)

To temporarily save the background, copy a rectangle of the background (from the A channel, for instance) to some backup buffer (using the D channel). In this case, the function we would use is "A", the standard copy function. From Table 6-1, we note that the corresponding LF code has a value of \$F0.

To draw the car, we might use the A DMA channel to fetch the car mask, the B DMA channel to fetch the actual car data, the C DMA channel to fetch the background, and the D DMA channel to write out the new image.

*Warning:* We must fetch the destination background before we write it, as only a portion of a destination word might need to be modified, and there is no way to do a write to only a portion of a word.

When blitting the car to the background we would want to use a function that, whenever the car mask (fetched with DMA channel A) had a bit set, we would pass through the car data from B, and whenever A did not have a bit set, we would pass through the original background from C. The corresponding function, commonly referred to as the cookie-cut function, is AB+AC, which works out to an LF code value of \$CA.

To restore the background and prepare for the next frame, we would copy the information saved in the first step back, with the standard copy function (\$F0).

If you shift the data and the mask to a new location and repeat the above three steps over and over, the car will appear to move across the background (the buildings).

*NOTE:* This may not be the most effective method of animation, depending on the application, but the cookie-cut function will appear often.

Table 6-1 lists some of the most common functions and their values, for easy reference.

Table 6-1: Table of Common Minterm Values

Selected Equation	BLTCON0 LF Code	Selected Equation	BLTCON0 LF Code
$D = A$	\$F0	$D = AB$	\$C0
$D = \bar{A}$	\$0F	$D = A\bar{B}$	\$30
$D = B$	\$CC	$D = \bar{A}B$	\$0C
$D = \bar{B}$	\$33	$D = \overline{AB}$	\$03
$D = C$	\$AA	$D = BC$	\$88
$D = \bar{C}$	\$55	$D = B\bar{C}$	\$44
$D = AC$	\$A0	$D = \bar{B}C$	\$22
$D = A\bar{C}$	\$50	$D = \overline{AC}$	\$11
$D = \bar{A}C$	\$0A	$D = A + \bar{B}$	\$F3
$D = \overline{AC}$	\$05	$D = \bar{A} + \bar{B}$	\$3F
$D = A + B$	\$FC	$D = A + \bar{C}$	\$F5
$D = \bar{A} + B$	\$CF	$D = \bar{A} + \bar{C}$	\$5F
$D = A + C$	\$FA	$D = B + \bar{C}$	\$DD
$D = \bar{A} + C$	\$AF	$D = \bar{B} + \bar{C}$	\$77
$D = B + C$	\$EE	$D = AB + \bar{A}C$	\$CA
$D = \bar{B} + C$	\$BB		

## DESIGNING THE LF CONTROL BYTE WITH VENN DIAGRAMS

Another way to arrive at a particular function is through the use of Venn diagrams:

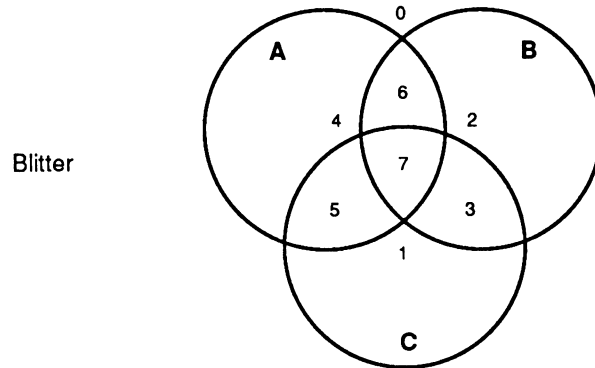

Figure 6-3: Blitter Minterm Venn Diagram

- To select a function  $D=A$  (that is, destination = A source only), select only the minterms that are totally enclosed by the A-circle in the Figure above. This is the set of minterms 7, 6, 5, and 4. When written as a set of 1s for the selected minterms and 0s for those not selected, the value becomes:

Minterm Number	7 6 5 4 3 2 1 0	
Selected Minterms	1 1 1 1 0 0 0 0	
	F 0	equals \$F0

- To select a function that is a combination of two sources, look for the minterms by both of the circles (their intersection). For example, the combination AB (A "and" B) is represented by the area common to both the A and B circles, or minterms 7 and 6.

Minterm Numbers	7 6 5 4 3 2 1 0	
Selected Minterms	1 1 0 0 0 0 0 0	
	C 0	equals \$C0



3. To use a function that is the inverse, or “not”, of one of the sources, such as  $\bar{A}$ , take all of the minterms not enclosed by the circle represented by A on the above Figure. In this case, we have minterms 0, 1, 2, and 3.

Minterm Numbers	7 6 5 4 3 2 1 0	
Selected Minterms	0 0 0 0 1 1 1 1	
	0 F	equals \$0F

4. To combine minterms, or “or” them, “or” the values together. For example, the equation  $AB+BC$  becomes

Minterm Numbers	7 6 5 4 3 2 1 0	
AB	1 1 0 0 0 0 0 0	
BC	1 0 0 0 1 0 0 0	
$AB+BC$	1 1 0 0 1 0 0 0	
	C 8	equals \$C8

## Shifts and Masks

Up to now we have dealt with the blitter only in moving words of memory around and combining them with logic operations. This is sufficient for moving graphic images around, so long as the images stay in the same position relative to the beginning of a word. If our car image has its leftmost pixel on the second pixel from the left, we can easily draw it on the screen in any position where the leftmost pixel also starts two pixels from the beginning of some word. But often we want to draw that car shifted left or right by a few pixels. To this end, both the A and B DMA channels have a barrel shifter that can shift an image between 0 and 15 bits.

This shifting operation is completely free; it requires no more time to execute a blit with shifts than a blit without shifts, as opposed to shifting with the 680x0. The shift is normally towards the right. This shifter allows movement of images on pixel boundaries, even though the pixels are addressed 16 at a time by each word address of the bitplane image.

So if the incoming data is shifted to the right, what is shifted in from the left? For the first word of the blit, zeros are shifted in; for each subsequent word of the same blit, the data shifted out from the previous word is shifted in.

The shift value for the A channel is set with bits 15 through 12 of BLTCON0; the B shift value is set with bits 15 through 12 of BLTCON1. For most operations, the same value will be used for both shifts. For shifts of greater than fifteen bits, load the address register pointer of the destination with a higher address; a shift of 100 bits would require the destination pointer to be advanced 100/16 or 6 words (12 bytes), and a right shift of the remaining 4 bits to be used.

---

As an example, let us say we are doing a blit that is three words wide, two words high, and we are using a shift of 4 bits. For simplicity, let us assume we are doing a straight copy from A to D. The first word that will be written to D is the first word fetched from A, shifted right four bits with zeros shifted in from the left. The second word will be the second word fetched from the A, shifted right, with the least significant (rightmost) four bits of the first word shifted in. Next, we will write the first word of the second row fetched from A, shifted four bits, with the least significant four bits of the last word from the first row shifted in. This would continue until the blit is finished.

On shifted blits, therefore, we only get zeros shifted in for the first word of the first row. On all other rows the blitter will shift in the bits that it shifted out of the previous row. For most graphics applications, this is undesirable. For this reason, the blitter has the ability to mask the first and last word of each row coming through the A DMA channel. Thus, it is possible to extract rectangular data from a source whose right and left edges are between word boundaries. These two registers are called BLTAFWM and BLTALWM, for blitter A channel first and last word masks. When not in use, both should be initialized to all ones (\$FFFF).

*A note about fonts.* Text fonts on the Amiga are stored in a packed bitmap. Individual characters from the font are extracted using the blitter, masking out unwanted bits. The character may then be positioned to any pixel alignment by shifting it the appropriate amount.

These masks are “anded” with the source data, before any shifts are applied. Only when there is a 1 bit in the first-word mask will that bit of source A actually appear in the logic operation. The first word of each row is anded with BLTAFWM, and the last word is “anded” with BLTALWM. If the width of the row is a single word, both masks are applied simultaneously.

The masks are also useful for extracting a certain range of “columns” from some bitplane. Let us say we have, for example, a predrawn rectangle containing text and graphics that is 23 pixels wide. The leftmost edge is the leftmost bit in its bitmap, and the bitmap is two words wide. We wish to render this rectangle starting at pixel position 5 into our 320 by 200 screen bitmap, without disturbing anything that lies outside of the rectangle.

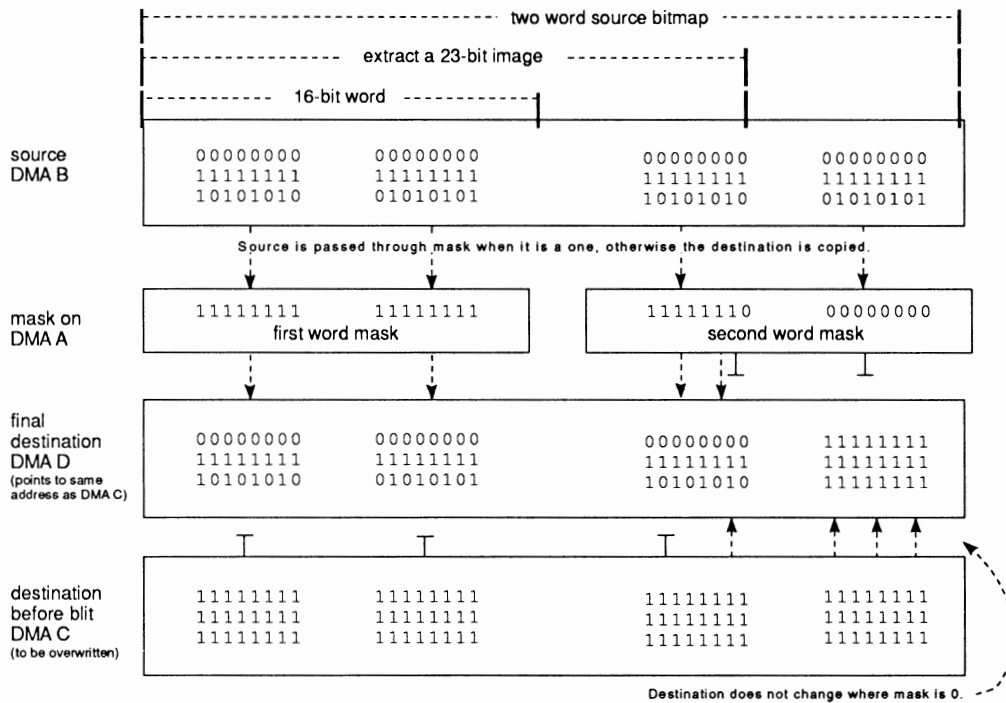

Figure 6-4: Extracting a Range of Columns

To do this, we point the B DMA channel at the bitmap containing the source image, and the D DMA channel at the screen bitmap. We use a shift value of 5. We also point the C DMA channel at the screen bitmap. We use a blit width of 2 words. What we need is a simple copy operation, except we wish to leave the first five bits of the first word, and the last four bits (2 times 16, less 23, less 5) of the last word alone. The A DMA channel comes to the rescue. We preload the A data register with \$FFFF (all ones), and use a first word mask with the most significant five bits set to zero (\$07FF) and a last word mask with the least significant four bits set to zero (\$FFF0). We do not enable the A DMA channel, but only the B, C, and D channels, since we want to use the A channel as a simple row mask. We then wish to pass the B (source) data along wherever the A channel is 1 (for a minterm of AB) and pass along the original destination data (from the C channel) wherever A is 0 (for a minterm of AC), yielding our classic cookie-cut function of  $AB+AC$ , or  $\$CA$ .

*About disabling.* Even though the A channel is disabled, we use it in our logic function and preload the data register. Disabling a channel simply turns off the memory fetches for that channel; all other operations are still performed, only from a constant value stored in the channel's data register.

---

An alternative but more subtle way of accomplishing the same thing is to use an A shift of five, a first word mask of all ones, and a last word mask with the rightmost nine bits set to zero. All other registers remain the same.

*Warning:* Be sure to load the blitter immediate data registers only after setting the shift count in BLTCON0/BLTCON1, as loading the data registers first will lead to unpredictable results. For instance, if the last person left BSHIFT to be ‘‘4’’, and I load BDATA with ‘‘1’’ and then change BSHIFT to ‘‘2’’, the resulting BDATA that is used is ‘‘1<<4’’, not ‘‘1<<2’’. The act of loading one of the data registers ‘‘draws’’ the data through the machine and shifts it.

## Descending Mode

Our standard memory copy blit works fine if the source does not overlap the destination. If we want to move an image one row down (towards increasing addresses), however, we run into a problem — we overwrite the second row before we get a chance to copy it! The blitter has a special mode of operation — descending mode — that solves this problem nicely.

Descending mode is turned on by setting bit one of BLTCON1 (defined as BLITREVERSE). If you use descending mode the address pointers will be decremented by two (bytes) instead of incremented by two for each word fetched. In addition, the modulo values will be subtracted rather than added. Shifts are then towards the left, rather than the right, the first word mask masks the last word in a row (which is still the first word fetched), and the last word mask masks the first word in a row.

Thus, for a standard memory copy, the only difference in blitter setup (assuming no shifting or masking) is to initialize the address pointer registers to point to the last word in a block, rather than the first word. The modulo values, blit size, and all other parameters should be set the same.

*NOTE:* This differs from predecrement versus postincrement in the 680x0, where an address register would be initialized to point to the word after the last, rather than the last word.

Descending mode is also necessary for area filling, which will be covered in a later section.

---

## Copying Arbitrary Regions

One of the most common uses of the blitter is to move arbitrary rectangles of data from one bitplane to another, or to different positions within a bitplane. These rectangles are usually on arbitrary bit coordinates, so shifting and masking are necessary. There are further complications. It may take several readings and some experimentation before everything in this section can be understood.

A source image that spans only two words may, when copied with certain shifts, span three words. Our 23 pixel wide rectangle above, for instance, when shifted 12 bits, will span three words. Alternatively, an image spanning three words may fit in two for certain shifts. Under all such circumstances, the blit size should be set to the larger of the two values, such that both source and destination will fit within the blit size. Proper masking should be applied to mask out unwanted data.

Some general guidelines for copying an arbitrary region are as follows.

1. Use the A DMA channel, disabled, preloaded with all ones and the appropriate mask and shift values, to mask the cookie cut function. Use the B channel to fetch the source data, the C channel to fetch the destination data, and the D channel to write the destination data. Use the cookie-cut function \$CA.
2. If shifting, always use ascending mode if bit shifting to the right, and use descending mode if bit shifting to the left.

*NOTE:* These shifts are the shifts of the bit position of the leftmost edge within a word, rather than absolute shifts, as explained previously.

3. If the source and destination overlap, use ascending mode if the destination has a lower memory address (is higher on the display) and descending mode otherwise.
4. If the source spans more words than the destination, use the same shift value for the A channel as for the source B channel and set the first and last word masks as if they were masking the B source data.
5. If the destination spans more words than the source, use a shift value of zero for the A channel and set the first and last word masks as if they were masking the destination D data.
6. If the source and destination span the same number of words, use the A channel to mask either the source, as in 4, or the destination, as in 5.

---

*Warning:* Conditions 2 and 3 can be contradictory if, for instance, you are trying to move an image one pixel down and to the right. In this case, we would want to use descending mode so our destination does not overwrite our source before we use the source, but we would want to use ascending mode for the right shift. In some situations, it is possible to get around general guideline 2 above with clever masking. But occasionally just masking the first or last word may not be sufficient; it may be necessary to mask more than 16 bits on one or the other end. In such a case, a mask can be built in memory for a single raster row, and the A DMA channel enabled to explicitly fetch this mask. By setting the A modulo value to the negative of the width of the mask, the mask will be repeatedly fetched for each row.

## Area Fill Mode

In addition to copying data, the blitter can simultaneously perform a fill operation during the copy. The fill operation has only one restriction — the area to fill must be defined first by drawing untextured lines with only one bit set per horizontal row. A special line draw mode is available for this operation. Use a standard copy blit (or any other blit, as area fills take place after all shifts, masks and logical combination of sources). Descending mode must be used. Set either the inclusive-fill-enable bit (FILL\_OR, or bit 3) or the exclusive-fill-enable bit (FILL\_XOR, or bit 4) in BLTCON1. The inclusive fill mode fills between lines, leaving the lines intact. The exclusive fill mode fills between lines, leaving the lines bordering the right edge of filled regions but deleting the lines bordering the left edge. Exclusive fill yields filled shapes one pixel narrower than the same pattern filled with inclusive fill.

For instance, the pattern:

```
00100100-00011000
```

filled with inclusive fill, yields:

```
00111100-00011000
```

with exclusive fill, the result would be

```
00011100-00001000
```

(Of course, fills are always done on full 16-bit words.)

There is another bit (FILL\_CARRYIN or bit 3 in BLTCON1) that forces the area “outside” the lines be filled; for the above example, with inclusive fill, the output would be

11100111-11111111

with exclusive fill, the output would be

11100011-11110111

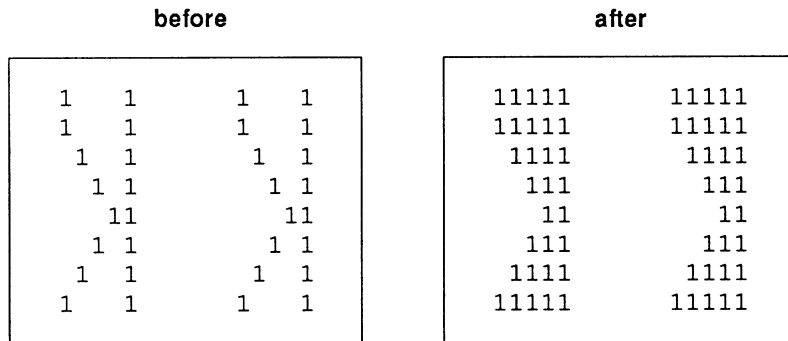

Figure 6-5: Use of the FCI Bit - Bit Is a 0

If the FCI bit is a 1 instead of a 0, the area outside the lines is filled with 1s and the area inside the lines is left with 0s in between.

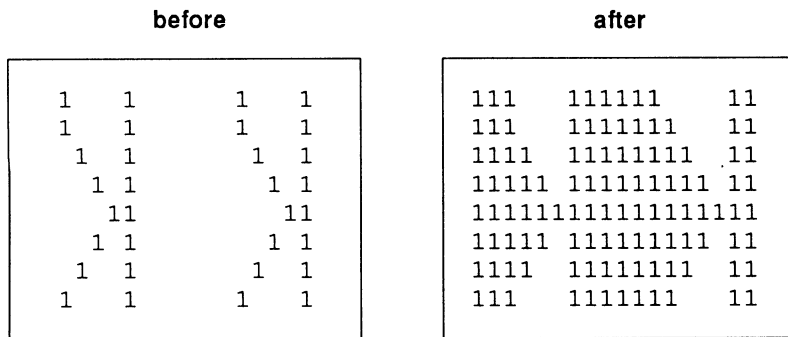

Figure 6-6: Use of the FCI Bit - Bit Is a 1

If you wish to produce very sharp, single-point vertices, exclusive-fill enable must be used. Figure 6-7 shows how a single-point vertex is produced using exclusive-fill enable.

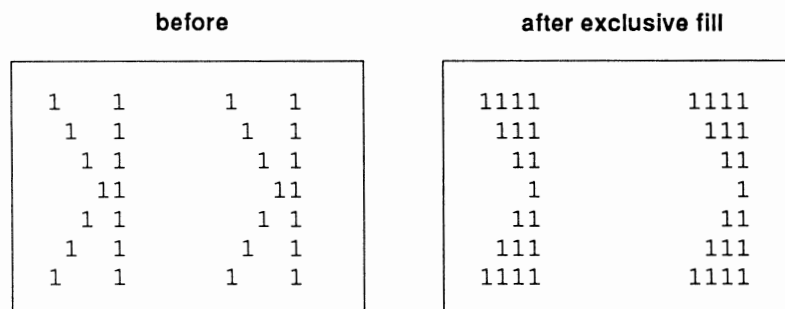

Figure 6-7: Single-Point Vertex Example

The blitter uses the fill carry-in bit as the starting fill state beginning at the rightmost edge of each line. For each “1” bit in the source area, the blitter flips the fill state, either filling or not filling the space with ones. This continues for each line until the left edge of the blit is reached, at which point the filling stops.

## Blitter Done Flag

When the BLTSIZE register is written the blit is started. The processor does not stop while the blitter is working, though; they can both work concurrently, and this provides much of the speed evident in the Amiga. This does require some amount of care when using the blitter.

A blitter done flag, also called the blitter busy flag, is provided as DMAF\_BLTDONE in DMACONR. This flag is set when a blit is in progress.

*About the blitter done flag.* If a blit has just been started but has been locked out of memory access because of, for instance, display fetches, this bit may not yet be set. The processor, on the other hand, may be running completely uninhibited out of Fast memory or its internal cache, so it will continue to have memory cycles.

The solution is to read a chip memory or hardware register address with the processor before testing the bit. This can easily be done with the sequence:

```

btst.b  #DMAB_BLTDONE-8, DMACONR (a1)
btst.b  #DMAB_BLTDONE-8, DMACONR (a1)

```

where a1 has been preloaded with the address of the hardware registers. The first “test” of the blitter done bit may not return the correct result, but the second will.



---

*NOTE:* Starting with the Fat Agnus the blitter busy bit has been "fixed" to be set as soon as you write to BLTSIZE to start the blit, rather than when the blitter gets its first DMA cycle. However, not all machines will use these newer chips, so it is best to rely on the above method of testing.

## MULTITASKING AND THE BLITTER

When a blit is in progress, none of the blitter registers should be written. For details on arbitration of blitter access in the system, please refer to the ROM Kernel Manual. In particular, read the discussion about the OwnBlitter() and DisownBlitter() functions. Even after the blitter has been "owned", a blit may still be finishing up, so the blitter done flag should be checked before using it even the first time. Use of the ROM kernel function WaitBlit() is recommended.

You should also check the blitter done flag before using results of a blit. The blit may not be finished, so the data may not be ready yet. This can lead to difficult to find bugs, because a 68000 may be slow enough for a blit to finish without checking the done flag, while a 68020, perhaps running out of its cache, may be able to get at the data before the blitter has finished writing it.

Let us say that we have a subroutine that displays a text box on top of other imagery temporarily. This subroutine might allocate a chunk of memory to hold the original screen image while we are displaying our text box, then draw the text box. On exit, the subroutine might blit the original imagery back and then free the allocated memory. If the memory is freed before the blitter done flag is checked, some other process might allocate that memory and store new data into it before the blit is finished, trashing the blitter source and, thus, the screen imagery being restored.

## Interrupt Flag

The blitter also has an interrupt flag that is set whenever a blit finishes. This flag, INTF\_BLIT, can generate a 680x0 interrupt if enabled. For more information on interrupts, see Chapter 7 "System Control Hardware."

## Zero Flag

A blitter zero flag is provided that can be tested to determine if the logic operation selected has resulted in zero bits for all destination bits, even if those destination bits are not written due to the D DMA channel being disabled. This feature is often useful for collision detection, by performing a logical "and" on two source images to test for overlap. If the images do not overlap, the zero flag will stay true.

The Zero flag is only valid after the blitter has completed its operation and can be read from bit DMAF\_BLTNZERO of the DMACONR register.

## Pipeline Register

The blitter performs many operations in each cycle — shifting and masking source words, logical combination of sources, and area fill and zero detect on the output. To enable so many things to take place so quickly, the blitter is pipelined. This means that rather than performing all of the above operations in one blitter cycle, the operations are spread over two blitter cycles. (Here “cycle” is used very loosely for simplicity.) To clarify this, the blitter can be imagined as two chips connected in series. Every cycle, a new set of source operations come in, and the first chip performs its operations on the data. It then passes the half-processed data to the second chip to be finished during the next cycle, when the first chip will be busy at work on the next set of data. Each set of data takes two “cycles” to get through the two chips, overlapped so a set of data can be pumped through each cycle.

What all this means is that the first two sets of sources are fetched before the first destination is written. This allows you to shift a bitmap up to one word to the right using ascending mode, for instance, even though normally parts of the destination would be overwritten before they were fetched.

USE Code in BLTCON0	Active Channels	Cycle Sequence
F	A B C D	A0 B0 C0 - A1 B1 C1 D0 A2 B2 C2 D1 D2
E	A B C	A0 B0 C0 A1 B1 C1 A2 B2 C2
D	A B D	A0 B0 - A1 B1 D0 A2 B2 D1 - D2
C	A B	A0 B0 - A1 B1 - A2 B2
B	A C D	A0 C0 - A1 C1 D0 A2 C2 D1 - D2
A	A C	A0 C0 A1 C1 A2 C2
9	A D	A0 - A1 D0 A2 D1 - D2
8	A	A0 - A1 - A2
7	B C D	B0 C0 - - B1 C1 D0 - B2 C2 D1 - D2
6	B C	B0 C0 - B1 C1 - B2 C2
5	B D	B0 - - B1 D0 - B2 D1 - D2
4	B	B0 - - B1 - - B2
3	C D	C0 - - C1 D0 - C2 D1 - D2
2	C	C0 - C1 - C2
1	D	D0 - D1 - D2
0	none	- - - -

Table 6-2: Typical Blitter Cycle Sequence

---

Here are a few caveats to keep in mind about Table 6-2.

- No fill.
- No competing bus activity.
- Three-word blit.
- Typical operation involves fetching all sources twice before the first destination becomes available. This is due to internal pipelining. Care must be taken with overlapping source and destination regions.

*Warning:* This Table is only meant to be an illustration of the typical order of blitter cycles on the bus. Bus cycles are dynamically allocated based on blitter operating mode; competing bus activity from processor, bitplanes, and other DMA channels; and other factors. Commodore Amiga does not guarantee the accuracy of or future adherence to this chart. We reserve the right to make product improvements or design changes in this area without notice.

## Line Mode

In addition to all of the functions described above, the blitter can draw patterned lines. The line draw mode is selected by setting bit 0 (LINEMODE) of BLTCON1, which changes the meaning of some other bits in BLTCON0 and BLTCON1. In line draw mode, the blitter can draw lines up to 1024 pixels long, it can draw them in a variety of modes, with a variety of textures, and can even draw them in a special way for simple area fill.

Many of the blitter registers serve other purposes in line-drawing mode. Consult Appendix A for more detailed descriptions of the use of these registers and control bits in line-drawing mode.

In line mode, the blitter draws a line from one point to another, which can be viewed as a vector. The direction of the vector can lie in any of the following eight octants. (In the following diagram, the standard Amiga convention is used, with  $x$  increasing towards the right and  $y$  increasing down.) The number in parenthesis is the octant numbering; the other number represents the value that should be placed in bits 4 through 2 of BLTCON1.

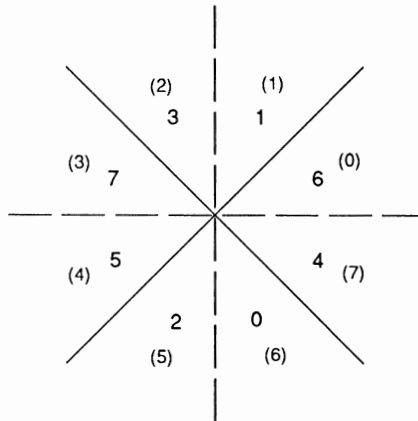

Figure 6-8: Octants for Line Drawing

Line drawing based on octants is a simplification that takes advantage of symmetries between  $x$  and  $-x$ ,  $y$  and  $-y$ . The following Table lists the octant number and corresponding values:

Table 6-3: BLTCON1 Code Bits for Octant Line Drawing

BLTCON1 Code Bits	Octant #
4 3 2	
1 1 0	0
0 0 1	1
0 1 1	2
1 1 1	3
1 0 1	4
0 1 0	5
0 0 0	6
1 0 0	7

We initialize BLTCON1 bits 4 through 2 according to the above Table. Now, we introduce the variables  $dx$  and  $dy$ , and set them to the absolute values of the difference between the  $x$  coordinates and the  $y$  coordinates of the endpoints of the line, respectively.

```
dx = abs(x2 - x1) ;
dy = abs(y2 - y1) ;
```

Now, we rearrange them if necessary so  $dx$  is greater than  $dy$ .

```
if (dx < dy)
{
    temp = dx ;
    dx = dy ;
    dy = temp ;
}
```

Alternately, set  $dx$  and  $dy$  as follows:

```
dx = max(abs(x2 - x1), abs(y2 - y1)) ;
dy = min(abs(x2 - x1), abs(y2 - y1)) ;
```

These calculations have the effect of “normalizing” our line into octant 0; since we have already informed the blitter of the real octant to use, it has no difficulty drawing the line.

We initialize the A pointer register to  $4 * dy - 2 * dx$ . If this value is negative, we set the sign bit (SIGNFLAG in BLTCON1), otherwise we clear it. We set the A modulo register to  $4 * (dy - dx)$  and the B modulo register to  $4 * dy$ .

The A data register should be preloaded with \$8000. Both word masks should be set to \$FFFF. The A shift value should be set to the  $x$  coordinate of the first point ( $x1$ ) modulo 15.

The B data register should be initialized with the line texture pattern, if any, or \$FFFF for a solid line. The B shift value should be set to the bit number at which to start the line texture (zero means the last significant bit.)

The C and D pointer registers should be initialized to the word containing the first pixel of the line; the C and D modulo registers should be set to the width of the bitplane in bytes.

The SRCA, SRCC, and DEST bits of BLTCON0 should be set to one, and the SRCB flag should be set to zero. The OVFLAG should be cleared. If only a single bit per horizontal row is desired, the ONEDOT bit of BLTCON1 should be set; otherwise it should be cleared.

The logic function remains. The C DMA channel represents the original source, the A channel the bit to set in the line, and the B channel the pattern to draw. Thus, to draw a line, the function  $AB+AC$  is the most common. To draw the line using exclusive-or mode, so it can be easily erased by drawing it again, the function  $ABC+AC$  can be used.

We set the blit height to the length of the line, which is  $dx + 1$ . The width must be set to two for all line drawing. (Of course, the BLTSIZE register should not be written until the very end, when all other registers have been filled.)

## REGISTER SUMMARY FOR LINE MODE

Preliminary setup:

The line goes from  $(x1,y1)$  to  $(x2,y2)$ .

```
dx = max(abs(x2 - x1), abs(y2 - y1)) ;  
dy = min(abs(x2 - x1), abs(y2 - y1)) ;
```

Register setup:

```
BLTADAT = $8000  
BLTBDAT = line texture pattern ($FFFF for a solid line)
```

```
BLTAFWM = $FFFF  
BLTALWM = $FFFF
```

```
BLTAMOD = 4 * (dy - dx)  
BLTBMOD = 4 * dy  
BLTCMOD = width of the bitplane in bytes  
BLTDMOD = width of the bitplane in bytes
```

```
BLTAPT = (4 * dy) - (2 * dx)  
BLTBPT = unused  
BLTCPT = word containing the first pixel of the line  
BLTDPT = word containing the first pixel of the line
```

```
BLTCON0 bits 15-12 = x1 modulo 15  
BLTCON0 bits SRCA, SRCC, and SRCD = 1  
BLTCON0 bit SRCB = 0
```

```
  If exclusive-or line mode:  
    then BLTCON0 LF control byte =  $ABC + \bar{A}\bar{C}$   
    else BLTCON0 LF control byte =  $AB + AC$ 
```

```
BLTCON1 bit LINEMODE = 1  
BLTCON1 bit OVFLAG = 0  
BLTCON1 bits 4-2 = octant number from table  
BLTCON1 bits 15-12 = start bit for line texture (0 = last significant bit)
```

```
  If  $((4 * dy) - (2 * dx) < 0)$ :  
    then BLTCON1 bit SIGNFLAG = 1  
    else BLTCON1 bit SIGNFLAG = 0
```

```
  If one pixel/row:  
    then BLTCON1 bit ONEDOT = 1  
    else BLTCON1 bit ONEDOT = 0
```

```
BLTSIZE bits 15-6 = dx + 1  
BLTSIZE bits 5-0 = 2
```

**Warning:** You must set the BLTSIZE register last as it starts the blit.

---

## Blitter Speed

The speed of the blitter depends entirely on which DMA channels are enabled. You might be using a DMA channel as a constant, but unless it is enabled, it does not count against you. The minimum blitter cycle is four ticks; the maximum is eight ticks. Use of the A register is always free. Use of the B register always adds two ticks to the blitter cycle. Use of either C or D is free, but use of both adds another two ticks. Thus, a copy cycle, using A and D, takes four clock ticks per cycle; a copy cycle using B and D takes six ticks per cycle, and a generalized bit copy using B, C, and D takes eight ticks per cycle. When in line mode, each pixel takes eight ticks.

The system clock speed for NTSC Amigas is 7.16 megahertz (PAL Amigas 7.09 megahertz). The clock for the blitter is the system clock. To calculate the total time for the blit in microseconds, excluding setup and DMA contention, you use the equation (for NTSC):

$$t = \frac{n * H * W}{7.16}$$

For PAL:

$$t = \frac{n * H * W}{7.09}$$

where  $t$  is the time in microseconds,  $n$  is the number of clocks per cycle, and  $H$  and  $W$  are the height and width (in words) of the blit, respectively.

For instance, to copy one bitplane of a 320 by 200 screen to another bitplane, we might choose to use the A and D channels. This would require four ticks per blitter cycle, for a total of

$$\frac{4 * 200 * 20}{7.16} = 2235 \text{ microseconds.}$$

These timings do not take into account blitter setup time, which is the time required to calculate and load the blitter registers and start the blit. They also ignore DMA contention.

---

## Blitter Operations and System DMA

The operations of the blitter affect the performance of the rest of the system. The following sections explain how system performance is affected by blitter direct memory access priority, DMA time slot allocation, bus sharing between the 680x0 and the display hardware, the operations of the blitter and Copper, and different playfield display sizes.

The blitter performs its various data-fetch, modify, and store operations through DMA sequences, and it shares memory access with other devices in the system. Each device that accesses memory has a priority level assigned to it, which indicates its importance relative to other devices.

Disk DMA, audio DMA, display DMA, and sprite DMA all have the highest priority level. Display DMA has priority over sprite DMA under certain circumstances. Each of these four devices is allocated a group of time slots during each horizontal scan of the video beam. If a device does not request one of its allocated time slots, the slot is open for other uses. These devices are given first priority because missed DMA cycles can cause lost data, noise in the sound output, or on-screen interruptions.

The Copper has the next priority because it has to perform its operations at the same time during each display frame to remain synchronized with the display beam sweeping across the screen.

The lowest priorities are assigned to the blitter and the 68000, in that order. The blitter is given the higher priority because it performs data copying, modifying, and line drawing operations much faster than the 68000.

During a horizontal scan line (about 63 microseconds), there are 227.5 “color clocks”, or memory access cycles. A memory cycle is approximately 280 ns in duration. The total of 227.5 cycles per horizontal line includes both display time and non-display time. Of this total time, 226 cycles are available to be allocated to the various devices that need memory access.

The time-slot allocation per horizontal line is:

- 4 cycles for memory refresh
- 3 cycles for disk DMA
- 4 cycles for audio DMA (2 bytes per channel)
- 16 cycles for sprite DMA (2 words per channel)
- 80 cycles for bitplane DMA (even- or odd-numbered slots according to the display size used)

Figure 6-9 shows one complete horizontal scan line and how the clock cycles are allocated.



## DMA Time Slot Allocation/Horizontal line

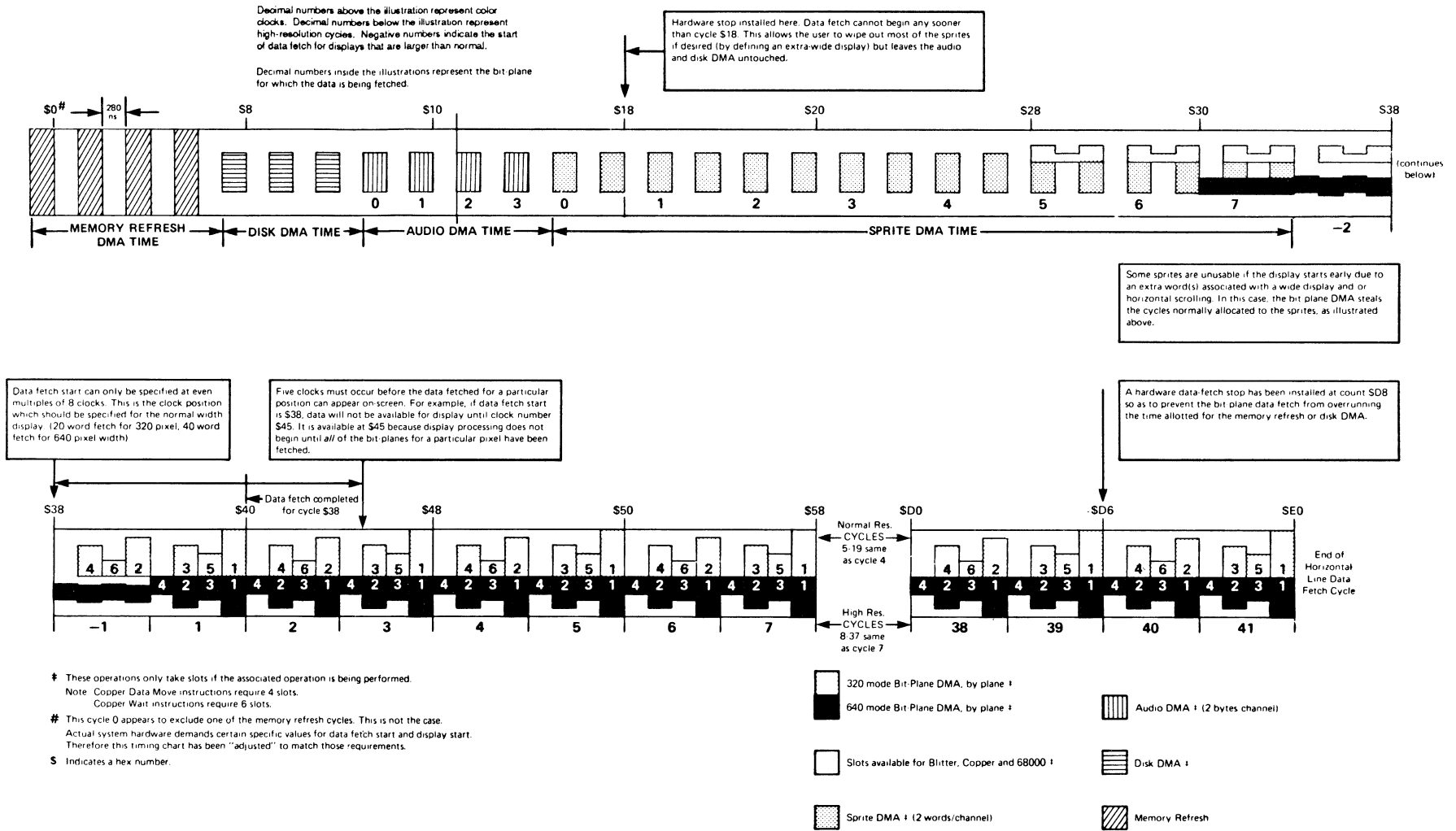

Figure 6-9: DMA Time Slot Allocation

The 68000 uses only the even-numbered memory access cycles. The 68000 spends about half of a complete processor instruction time doing internal operations and the other half accessing memory. Therefore, the allocation of alternate memory cycles to the 68000 makes it appear to the 68000 that it has the memory all of the time, and it will run at full speed.

Some 68000 instructions do not match perfectly with the allocation of even cycles and cause cycles to be missed. If cycles are missed, the 68000 must wait until its next available memory slot before continuing. However, most instructions do not cause cycles to be missed, so the 68000 runs at full speed most of the time if there is no blitter DMA interference.

Figure 6-10 illustrates the normal cycle of the 68000.

*Avoid the TAS instruction.* The 68000 test-and-set instruction (TAS) should never be used in the Amiga; the indivisible read-modify-write cycle that is used only in this instruction will not fit into a DMA memory access slot.

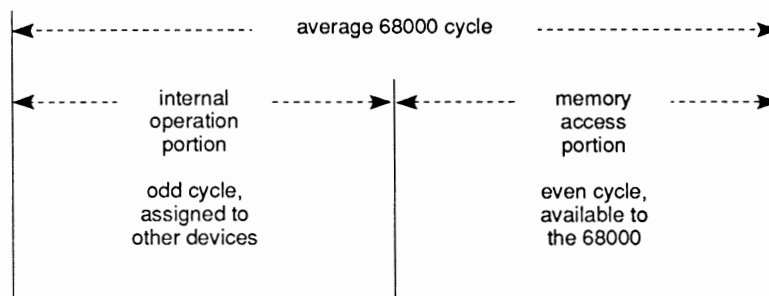

Figure 6-10: Normal 68000 Cycle

If the display contains four or fewer low resolution bitplanes, the 68000 can be granted alternate memory cycles (if it is ready to ask for the cycle and is the highest priority item at the time). However, if there are more than four bitplanes, bitplane DMA will begin to steal cycles from the 68000 during the display.

During the display time for a six bitplane display (low resolution, 320 pixels wide), 160 time slots will be taken by bitplane DMA for each horizontal line. As you can see from Figure 6-11, bitplane DMA steals 50 percent of the open slots that the processor might have used if there were only four bitplanes displayed.

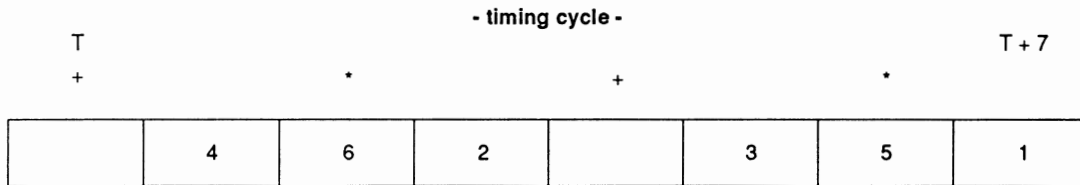

Figure 6-11: Time Slots Used by a Six Bitplane Display

If you specify four high resolution bitplanes (640 pixels wide), bitplane DMA needs all of the available memory time slots during the display time just to fetch the 40 data words for each line of the four bitplanes ( $40 * 4 = 160$  time slots). This effectively locks out the 68000 (as well as the blitter or Copper) from any memory access during the display, except during horizontal and vertical blanking.

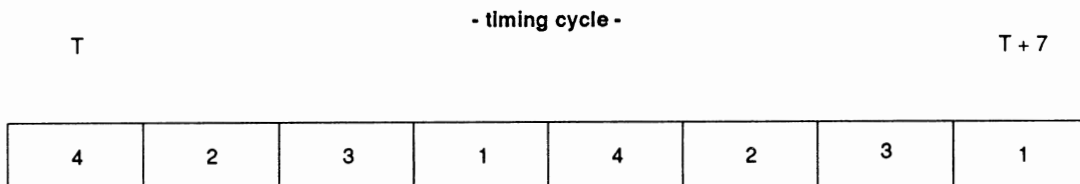

Figure 6-12: Time Slots Used by a High Resolution Display

Each horizontal line in a normal, full-sized display contains 320 pixels in low resolution mode or 640 pixels in high resolution mode. Thus, either 20 or 40 words will be fetched during the horizontal line display time. If you want to scroll a playfield, one extra data word per line must be fetched from the memory.

Display size is adjustable (see Chapter 3, "Playfield Hardware"), and bitplane DMA takes precedence over sprite DMA. As shown in Figure 6-9, larger displays may block out one or more of the highest-numbered sprites, especially with scrolling.

---

As mentioned above, the blitter normally has a higher priority than the processor for DMA cycles. There are certain cases, however, when the blitter and the 68000 can share memory cycles. If given the chance, the blitter would steal every available Chip memory cycle. Display, disk, and audio DMA take precedence over the blitter, so it cannot block them from bus access. Depending on the setting of the blitter DMA mode bit, commonly referred to as the “blitter-nasty” bit, the processor may be blocked from bus access. This bit is called DMAF\_BLITHOG and is in register DMACON.

If DMAF\_BLITHOG is a 1, the blitter will keep the bus for every available Chip memory cycle. This could potentially be every cycle (ROM and Fast memory are not typically Chip memory cycles).

If DMAF\_BLITHOG is a 0, the DMA manager will monitor the 68000 cycle requests. If the 68000 is unsatisfied for three consecutive memory cycles, the blitter will release the bus for one cycle.

## Blitter Block Diagram

- Figure 6-13 shows the basic building blocks for a single bit of a 16-bit wide operation of the blitter. It does not cover the line-drawing hardware.
- The upper left corner shows how the first— and last— word masks are applied to the incoming A-source data. When the blit shrinks to one word wide, both masks are applied.
- The shifter (upper right and center left) drawing illustrates how 16 bits of data is taken from a specified position within a 32-bit register, based on the A shift or B shift values shown in BLTCON0 and BLTCON1.
- The minterm generator (center right) illustrates how the minterm select bits either allow or inhibit the use of a specific minterm.
- The drawing shows how the fill operation works on the data generated by the minterm combinations. Fill operations can be performed simultaneously with other complex logic operations.
- At the bottom, the drawing shows that data generated for the destination can be prevented from being written to a destination by using one of the blitter control bits.
- Not shown on this diagram is the logic for zero detection, which looks at every bit generated for the destination. If there are any 1-bits generated, this logic indicates that the area of the blit contained at least one 1-bit (zero detect is false.)

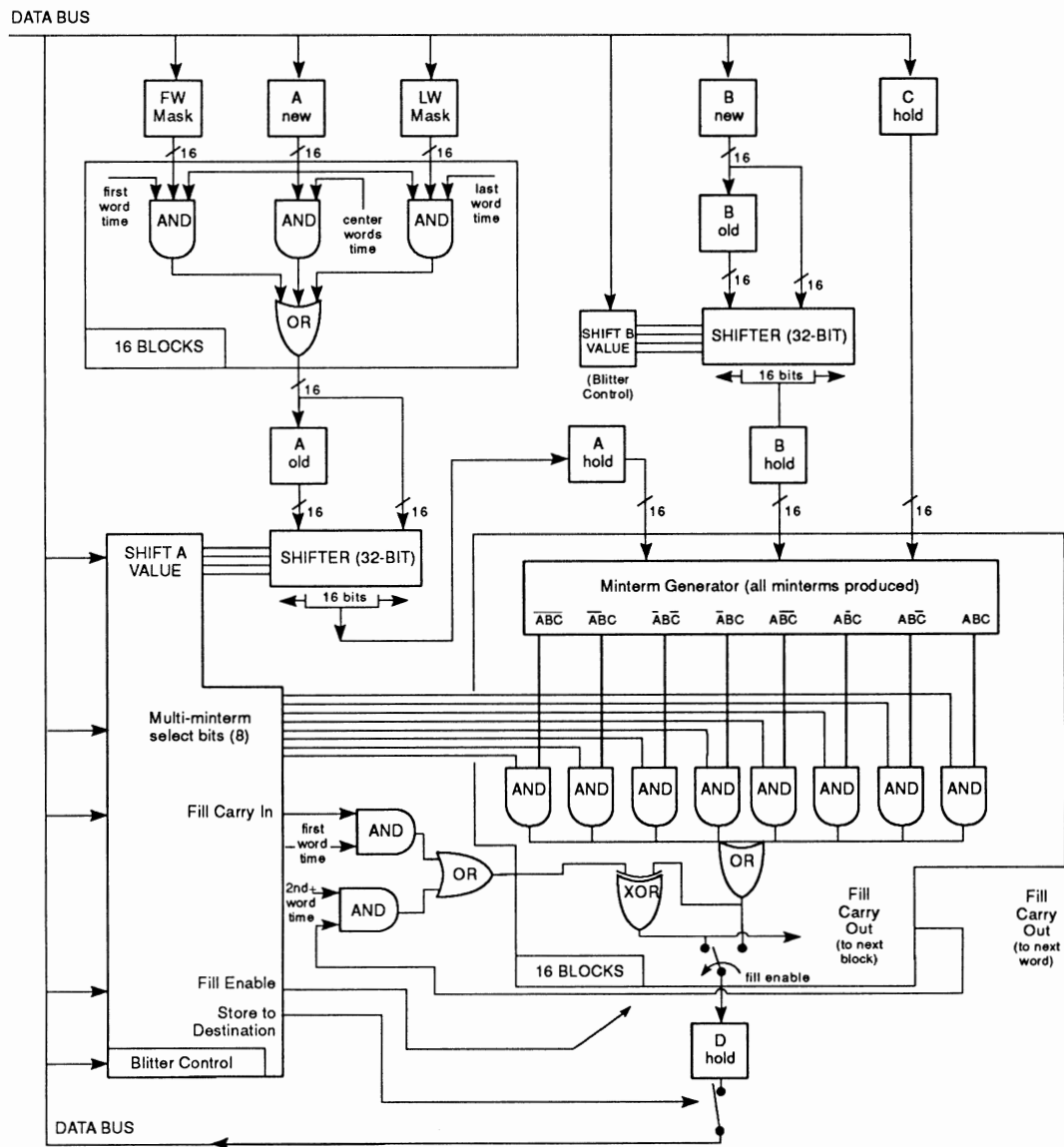

Figure 6-13: Blitter Block Diagram

---

## Blitter Key Points

This is a list of some key points that should be remembered when programming the blitter.

- Write BLTSIZE last; writing this register starts the blit.
- Modulos and pointers are in bytes; width is in words and height is in pixels. The least significant bit of all pointers and modulos is ignored.
- The order of operations in the blitter is masking, shifting, logical combination of sources, area fill, and zero flag setting.
- In ascending mode, the blitter increments the pointers, adds the modulos, and shifts to the right.
- In descending mode, the blitter decrements the pointers, subtracts the modulos, and shifts to the left.
- Area fill only works correctly in descending mode.
- Check BLTDONE before writing blitter registers or using the results of a blit.
- Shifts are done on immediate data as soon as it is loaded.

### EXAMPLE: ClearMem

```
;
; Blitter example---memory clear
;
    include 'exec/types.i'
    include 'hardware/custom.i'
    include 'hardware/dmabits.i'
    include 'hardware/blit.i'
    include 'hardware/hw_examples.i'

    xref    _custom

;
; Wait for previous blit to complete.
;
waitblit:
    btst.b  #DMAB_BLTDONE-8,DMACONR(a1)
waitblit2:
    btst.b  #DMAB_BLTDONE-8,DMACONR(a1)
    bne    waitblit2
    rts

;
; This routine uses a side effect in the blitter. When each
; of the blits is finished, the pointer in the blitter is pointing
; to the next word to be blitted.
;
```

```

; When this routine returns, the last blit is started and might
; not be finished, so be sure to call waitblit above before
; assuming the data is clear.
;
; a0 = pointer to first word to clear
; d0 = number of bytes to clear (must be even)
;
xdef    clearmem
clearmem:
    lea    _custom,a1        ; Get pointer to chip registers
    bsr    waitblit         ; Make sure previous blit is done
    move.l a0,BLTDPT(a1)    ; Set up the D pointer to the region to clear
    clr.w  BLTDMOD(a1)      ; Clear the D modulo (don't skip no bytes)
    asr.l  #1,d0            ; Get number of words from number of bytes
    clr.w  BLTCON1(a1)      ; No special modes
    move.w #DEST,BLTCON0(a1) ; only enable destination
;
; First we deal with the smaller blits
;
    moveq  #$3f,d1          ; Mask out mod 64 words
    and.w  d0,d1
    beq    dorest          ; none? good, do one blit
    sub.l  d1,d0           ; otherwise remove remainder
    or.l   #$40,d1         ; set the height to 1, width to n
    move.w d1,BLTSIZE(a1)  ; trigger the blit
;
; Here we do the rest of the words, as chunks of 128k
;
dorest:
    move.w #$ffc0,d1       ; look at some more upper bits
    and.w  d0,d1           ; extract 10 more bits
    beq    dorest2         ; any to do?
    sub.l  d1,d0           ; pull off the ones we're doing here
    bsr    waitblit        ; wait for prev blit to complete
    move.w d0,BLTSIZE(a1)  ; do another blit
dorest2:
    swap   d0              ; more?
    beq    done            ; nope.
    clr.w  d1              ; do a 1024x64 word blit (128K)
keepon:
    bsr    waitblit        ; finish up this blit
    move.w d1,BLTSIZE(a1)  ; and again, blit
    subq.w #1,d0           ; still more?
    bne    keepon         ; keep on going.
done:
    rts                    ; finished. Blit still in progress.
end

```

## EXAMPLE: SimpleLine

```
;
; This example uses the line draw mode of the blitter
; to draw a line. The line is drawn with no pattern
; and a simple 'or' blit into a single bitplane.
;
; Input: d0=x1 d1=y1 d2=x2 d3=y2 d4=width a0=aptr
;
    include 'exec/types.i'
    include 'hardware/custom.i'
    include 'hardware/blit.i'
    include 'hardware/dmabits.i'

    include 'hardware/hw_examples.i'
;
    xref    _custom
;
    xdef    simpleline
;
; Our entry point.
;
simpleline:
    lea    _custom,a1        ; snarf up the custom address register
    sub.w  d0,d2             ; calculate dx
    bmi   xneg               ; if negative, octant is one of [3,4,5,6]
    sub.w  d1,d3             ; calculate dy '' is one of [1,2,7,8]
    bmi   yneg               ; if negative, octant is one of [7,8]
    cmp.w  d3,d2             ; cmp |dx|,|dy| '' is one of [1,2]
    bmi   ygtx               ; if y>x, octant is 2
    moveq.l #OCTANT1+LINEMODE,d5 ; otherwise octant is 1
    bra   lineagain         ; go to the common section
ygtx:
    exg   d2,d3             ; X must be greater than Y
    moveq.l #OCTANT2+LINEMODE,d5 ; we are in octant 2
    bra   lineagain         ; and common again.
yneg:
    neg.w  d3               ; calculate abs(dy)
    cmp.w  d3,d2             ; cmp |dx|,|dy|, octant is [7,8]
    bmi   ynygtx            ; if y>x, octant is 7
    moveq.l #OCTANT8+LINEMODE,d5 ; otherwise octant is 8
    bra   lineagain
ynygtx:
    exg   d2,d3             ; X must be greater than Y
    moveq.l #OCTANT7+LINEMODE,d5 ; we are in octant 7
    bra   lineagain
xneg:
    neg.w  d2               ; dx was negative! octant is [3,4,5,6]
    sub.w  d1,d3             ; we calculate dy
    bmi   xyneg             ; if negative, octant is one of [5,6]
    cmp.w  d3,d2             ; otherwise it's one of [3,4]
    bmi   xnygtx            ; if y>x, octant is 3
    moveq.l #OCTANT4+LINEMODE,d5 ; otherwise it's 4
    bra   lineagain
xnygtx:
    exg   d2,d3             ; X must be greater than Y
    moveq.l #OCTANT3+LINEMODE,d5 ; we are in octant 3
    bra   lineagain
```



```

xyneg:
    neg.w    d3                ; y was negative, in one of [5,6]
    cmp.w    d3,d2            ; is y>x?
    bmi      xyngtx           ; if so, octant is 6
    moveq.l  #OCTANT5+LINEMODE,d5 ; otherwise, octant is 5
    bra      lineagain

xyngtx:
    exg      d2,d3            ; X must be greater than Y
    moveq.l  #OCTANT6+LINEMODE,d5 ; we are in octant 6

lineagain:
    mulu.w   d4,d1            ; Calculate y1 * width
    ror.l    #4,d0            ; move upper four bits into hi word
    add.w    d0,d0            ; multiply by 2
    add.l    d1,a0            ; ptr += (x1 >> 3)
    add.w    d0,a0            ; ptr += y1 * width
    swap     d0                ; get the four bits of x1
    or.w     #$BFA,d0         ; or with USEA, USEC, USED, F=A+C
    lsl.w    #2,d3            ; Y = 4 * Y
    add.w    d2,d2            ; X = 2 * X
    move.w   d2,d1            ; set up size word
    lsl.w    #5,d1            ; shift five left
    add.w    #$42,d1          ; and add 1 to height, 2 to width
    btst     #DMAB_BLTDONE-8,DMACONR(a1) ; safety check

waitblit:
    btst     #DMAB_BLTDONE-8,DMACONR(a1) ; wait for blitter
    bne      waitblit
    move.w   d3,BLTBMOD(a1)    ; B mod = 4 * Y
    sub.w    d2,d3
    ext.l    d3
    move.l   d3,BLTAPT(a1)     ; A ptr = 4 * Y - 2 * X
    bpl      lineover         ; if negative,
    or.w     #SIGNFLAG,d5     ; set sign bit in con1

lineover:
    move.w   d0,BLTCON0(a1)    ; write control registers
    move.w   d5,BLTCON1(a1)
    move.w   d4,BLTCMOD(a1)    ; C mod = bitplane width
    move.w   d4,BLTDMOD(a1)    ; D mod = bitplane width
    sub.w    d2,d3
    move.w   d3,BLTAMOD(a1)    ; A mod = 4 * Y - 4 * X
    move.w   #$8000,BLTADAT(a1) ; A data = 0x8000
    moveq.l  #-1,d5            ; Set masks to all ones
    move.l   d5,BLTAFWM(a1)    ; we can hit both masks at once
    move.l   a0,BLTCPT(a1)     ; Pointer to first pixel to set
    move.l   a0,BLTDPT(a1)
    move.w   d1,BLTSIZE(a1)    ; Start blit
    rts                                           ; and return, blit still in progress.
end

```

## EXAMPLE: RotateBits

```
;
; Here we rotate bits. This code takes a single raster row of a
; bitplane, and 'rotates' it into an array of 16-bit words, setting
; the specified bit of each word in the array according to the
; corresponding bit in the raster row. We use the line mode in
; conjunction with patterns to do this magic.
;
; Input: d0 contains the number of words in the raster row. d1
; contains the number of the bit to set (0..15). a0 contains a
; pointer to the raster data, and a1 contains a pointer to the
; array we are filling; the array must be at least (d0)*16 words
; (or (d0)*32 bytes) long.
;
;
; include 'exec/types.i'
; include 'hardware/custom.i'
; include 'hardware/blit.i'
; include 'hardware/dmabits.i'
;
; include 'hardware/hw_examples.i'
;
; xref    _custom
;
; xdef    rotatebits
;
; Our entry point.
;
rotatebits:
    lea    _custom,a2        ; We need to access the custom registers
    tst    d0                ; if no words, just return
    beq    gone
    lea    DMACONR(a2),a3    ; get the address of dmaconr
    moveq.l #DMAB_BLTDONE-8,d2 ; get the bit number BLTDONE
    btst   d2,(a3)          ; check to see if we're done
wait1:
    btst   d2,(a3)          ; check again.
    bne    wait1            ; not done? Keep waiting
    moveq.l #-30,d3         ; Line mode:  aptr = 4Y-2X, Y=0; X=15
    move.l  d3,BLTAPT(a2)
    move.w  #-60,BLTAMOD(a2) ; amod = 4Y-4X
    clr.w   BLTBMOD(a2)     ; bmod = 4Y
    move.w  #2,BLTACMOD(a2) ; cmod = width of bitmap (2)
    move.w  #2,BLTDMOD(a2)  ; ditto
    ror.w   #4,d1           ; grab the four bits of the bit number
    and.w   #$f000,d1       ; mask them out
    or.w    #$bca,d1        ; USEA, USEC, USED, F=AB+~AC
    move.w  d1,BLTCON0(a2)  ; stuff it
    move.w  #$f049,BLTCON1(a2) ; BSH=15, SGN, LINE
    move.w  #$8000,BLTADAT(a2) ; Initialize A dat for line
    move.w  #$ffff,BLTAFWM(a2) ; Initialize masks
    move.w  #$ffff,BLTALWM(a2)
    move.l  a1,BLTCPT(a2)   ; Initialize pointer
    move.l  a1,BLTDPT(a2)
    lea    BLTBDAT(a2),a4   ; For quick access, we grab these two
    lea    BLTSIZE(a2),a5   ; addresses
    move.w  #$402,d1        ; Stuff bltsize; width=2, height=16
    move.w  (a0)+,d3        ; Get next word
    bra    inloop          ; Go into the loop
```

```

again:
    move.w  (a0)+,d3      ; Grab another word
    btst   d2,(a3)      ; Check blit done
wait2:
    btst   d2,(a3)      ; Check again
    bne    wait2        ; oops, not ready, loop around
inloop:
    move.w  d3,(a4)      ; stuff new word to make vertical
    move.w  d1,(a5)      ; start the blit
    subq.w  #1,d0        ; is that the last word?
    bne    again        ; keep going if not
gone:
    rts
    end

```

*ECS blitter.* For information relating to the blitter hardware in the Enhanced Chip Set, see Appendix C.



---

## chapter seven

# SYSTEM CONTROL HARDWARE

This chapter covers the control hardware of the Amiga system, including the following topics:

- How playfield priorities may be specified relative to the sprites
- How collisions between objects are sensed
- How system direct memory access (DMA) is controlled
- How interrupts are controlled and sensed
- How reset and early powerup are controlled

## Video Priorities

You can control the priorities of various objects on the screen to give the illusion of three dimensions. The section below shows how playfield priority may be changed relative to sprites.

### FIXED SPRITE PRIORITIES

You cannot change the relative priorities of the sprites. They will always appear on the screen with the lower-numbered sprites appearing in front of (having higher screen priority than) the higher-numbered sprites. This is shown in Figure 7-1. Each box represents the image of the sprite number shown in that box.

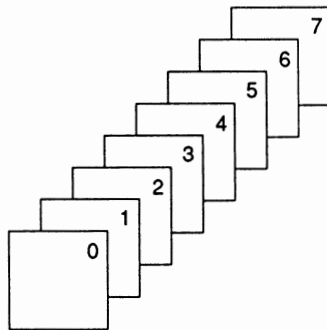

Figure 7-1: Inter-Sprite Fixed Priorities

## HOW SPRITES ARE GROUPED

For playfield priority and collision purposes only, sprites are treated as four groups of two sprites each. The groups of sprites are:

- Sprites 0 and 1
- Sprites 2 and 3
- Sprites 4 and 5
- Sprites 6 and 7

## UNDERSTANDING VIDEO PRIORITIES

The concept of video priorities is easy to understand if you imagine that four fingers of one of your hands represent the four pairs of sprites and two fingers of your other hand represent the two playfields. Just as you cannot change the sequence of the four fingers on the one hand, neither can you change the relative priority of the sprites. However, just as you can intertwine the two fingers of one hand in many different ways relative to the four fingers of the other hand, so can you position the playfields in front of or behind the sprites. This is illustrated in Figure 7-2.

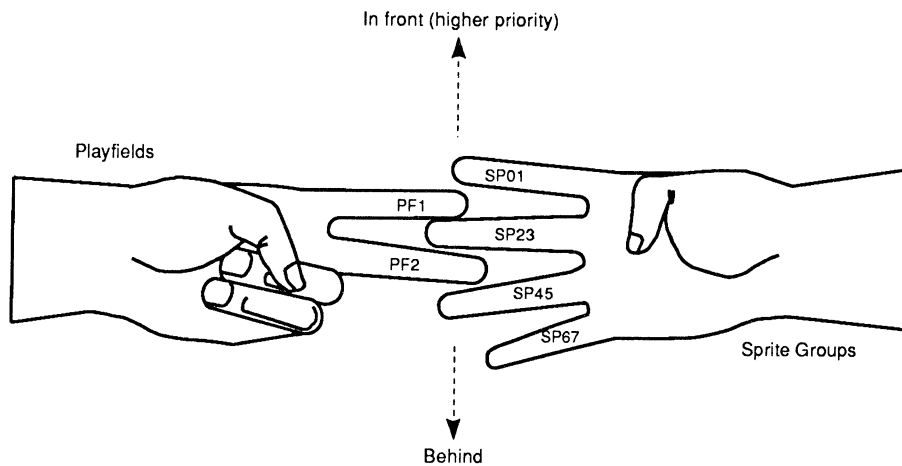

Figure 7-2: Analogy for Video Priority

Five possible positions can be chosen for each of the two “playfield fingers.” For example, you can place playfield 1 on top of sprites 0 and 1 (0), between sprites 0 and 1 and sprites 2 and 3 (1), between sprites 2 and 3 and sprites 4 and 5 (2), between sprites 4 and 5 and sprites 6 and 7 (3), or beneath sprites 6 and 7 (4). You have the same possibilities for playfield 2.

The numbers 0 through 4 shown in parentheses in the preceding paragraph are the actual values you use to select the playfield priority positions. See “Setting the Priority Control Register” below.

You can also control the priority of playfield 2 relative to playfield 1. This gives you additional choices for the way you can design the screen priorities.

## SETTING THE PRIORITY CONTROL REGISTER

This register lets you define how objects will pass in front of each other or hide behind each other. Normally, playfield 1 appears in front of playfield 2. The PF2PRI bit reverses this relationship, making playfield 2 more important. You control the video priorities by using the bits in BPLCON2 (for “bitplane control register number 2”) as shown in Table 7-1.

Table 7-1: Bits in BPLCON2

Bit Number	Name	Function
15-7		Not used (keep at 0)
6	PF2PRI	Playfield 2 priority
5-3	PF2P2 - PF2P0	Playfield 2 placement with respect to the sprites
2-0	PF1P2 - PF1P0	Playfield 1 placement with respect to the sprites

The binary values that you give to bits PF1P2-PF1P0 determine where playfield 1 occurs in the priority chain as shown in Table 7-2. This matches the description given in the previous section.

*Be careful:* PF2P2 - PF2P0, bits 5-3, are the priority bits for normal (non-dual) playfields.

Table 7-2: Priority of Playfields Based on Values of Bits PF1P2-PF1P0

Value	Placement (from most important to least important)				
000	PF1	SP01	SP23	SP45	SP67
001	SP01	PF1	SP23	SP45	SP67
010	SP01	SP23	PF1	SP45	SP67
011	SP01	SP23	SP45	PF1	SP67
100	SP01	SP23	SP45	SP67	PF1

In this table, PF1 stands for playfield 1, and SP01 stands for the group of sprites numbered 0 and 1. SP23 stands for sprites 2 and 3 as a group; SP45 stands for sprites 4 and 5 as a group; and SP67 stands for sprites 6 and 7 as a group.



---

Bits PF2P2-PF2P0 let you position playfield 2 among the sprite priorities in exactly the same way. However, it is the PF2PRI bit that determines which of the two playfields appears in front of the other on the screen. Here is a sample of possible BPLCON2 register contents that would create something a little unusual:

BITS	15-7	PF2PRI	PF2P2-0	PF1P2-0
VALUE	0s	1	010	000

This will result in a sprite/playfield priority placement of:

PF1 SP01 SP23 PF2 SP45 SP67

In other words, where objects pass across each other, playfield 1 is in front of sprite 0 or 1; and sprites 0 through 3 are in front of playfield 2. However, playfield 2 is in front of playfield 1 in any area where they overlap and where playfield 2 is not blocked by sprites 0 through 3.

Figure 7-3 shows one use of sprite/playfield priority. The single sprite object shown on the diagram is sprite 0. The sprite can “fly” across playfield 2, but when it crosses playfield 1 the sprite disappears behind that playfield. The result is an unusual video effect that causes the object to disappear when it crosses an invisible boundary on the screen.

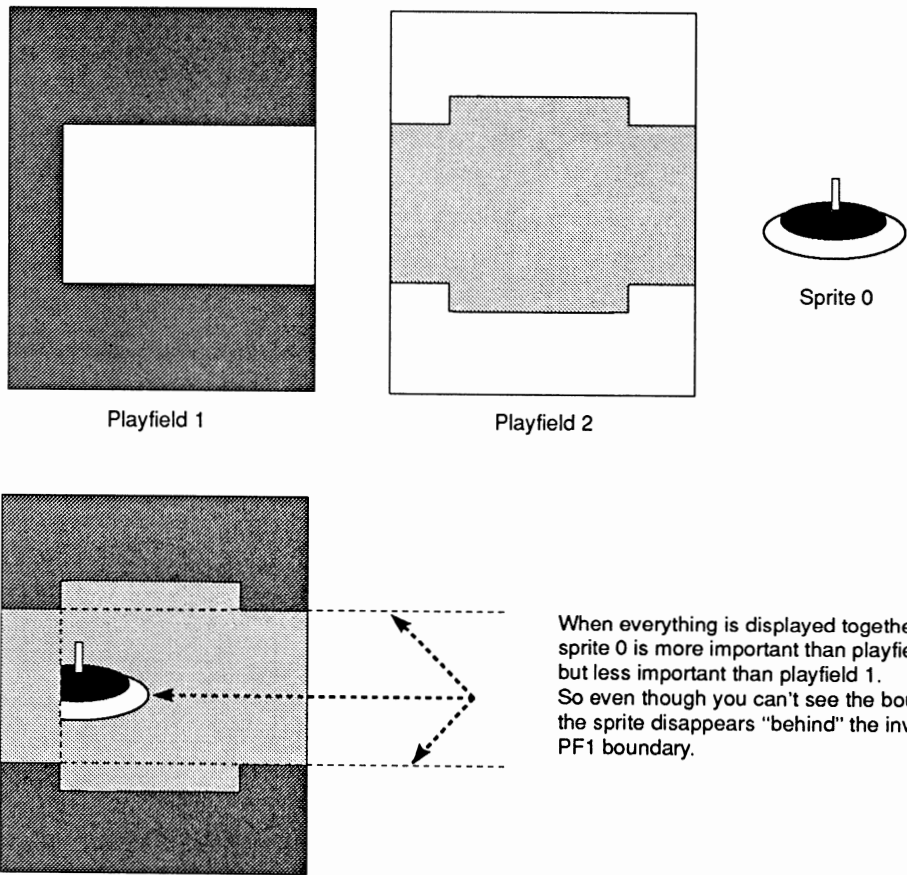

Figure 7-3: Sprite/Playfield Priority

---

## Collision Detection

You can use the hardware to detect collisions between one sprite group and another sprite group, any sprite group and either of the playfields, the two playfields, or any combination of these items.

The first kind of collision is typically used in a game operation to determine if a missile has collided with a moving player. The second kind of collision is typically used to keep a moving object within specified on-screen boundaries. The third kind of collision detection allows you to define sections of playfield as individual objects, which you may move using the blitter. This is called playfield animation. If one playfield is defined as the backdrop or playing area and the other playfield is used to define objects (in addition to the sprites), you can sense collisions between the playfield-objects and the sprites or between the playfield-objects and the other playfield.

### HOW COLLISIONS ARE DETERMINED

The video output is formed when the input data from all of the bitplanes and the sprites is combined into a common data stream for the display. For each of the pixel positions on the screen, the color of the highest priority object is displayed. Collisions are detected when two or more objects attempt to overlap in the same pixel position. This will set a bit in the collision data register.

---

## HOW TO INTERPRET THE COLLISION DATA

The collision data register, CLXDAT, is *read-only*, and its contents are automatically cleared to 0 after it is read. Its bits are as shown in Table 7-3.

Table 7-3: CLXDAT Bits

Bit Number	Collisions Registered
15	not used
14	Sprite 4 (or 5) to sprite 6 (or 7)
13	Sprite 2 (or 3) to sprite 6 (or 7)
12	Sprite 2 (or 3) to sprite 4 (or 5)
11	Sprite 0 (or 1) to sprite 6 (or 7)
10	Sprite 0 (or 1) to sprite 4 (or 5)
9	Sprite 0 (or 1) to sprite 2 (or 3)
8	Even bitplanes to sprite 6 (or 7)
7	Even bitplanes to sprite 4 (or 5)
6	Even bitplanes to sprite 2 (or 3)
5	Even bitplanes to sprite 0 (or 1)
4	Odd bitplanes to sprite 6 (or 7)
3	Odd bitplanes to sprite 4 (or 5)
2	Odd bitplanes to sprite 2 (or 3)
1	Odd bitplanes to sprite 0 (or 1)
0	Even bitplanes to odd bitplanes

*About odd-numbered sprites.* The numbers in parentheses in Table 7-3 refer to collisions that will register only if you want them to show up. The collision control register described below lets you either ignore or include the odd-numbered sprites in the collision detection.

Notice that in this table, collision detection does *not* change when you select either single- or dual-playfield mode. Collision detection depends only on the actual bits present in the odd-numbered or even-numbered bitplanes. The collision control register specifies how to handle the bitplanes during collision detect.

---

## HOW COLLISION DETECTION IS CONTROLLED

The collision control register, CLXCON, contains the bits that define certain characteristics of collision detection. Its bits are shown in Table 7-4.

Table 7-4: CLXCON Bits

Bit Number	Name	Function
15	ENSP7	Enable sprite 7 (OR with sprite 6)
14	ENSP5	Enable sprite 5 (OR with sprite 4)
13	ENSP3	Enable sprite 3 (OR with sprite 2)
12	ENSP1	Enable sprite 1 (OR with sprite 0)
11	ENBP6	Enable bitplane 6 (match required for collision)
10	ENBP5	Enable bitplane 5 (match required for collision)
9	ENBP4	Enable bitplane 4 (match required for collision)
8	ENBP3	Enable bitplane 3 (match required for collision)
7	ENBP2	Enable bitplane 2 (match required for collision)
6	ENBP1	Enable bitplane 1 (match required for collision)
5	MVBP6	Match value for bitplane 6 collision
4	MVBP5	Match value for bitplane 5 collision
3	MVBP4	Match value for bitplane 4 collision
2	MVBP3	Match value for bitplane 3 collision
1	MVBP2	Match value for bitplane 2 collision
0	MVBP1	Match value for bitplane 1 collision

Bits 15-12 let you specify that collisions with a sprite pair are to include the odd-numbered sprite of a pair of sprites. The even-numbered sprites always are included in the collision detection. Bits 11-6 let you specify whether to include or exclude specific bitplanes from the collision detection. Bits 5-0 let you specify the polarity (true-false condition) of bits that will cause a collision. For example, you may wish to register collisions only when the object collides with “something green” or “something blue.” This feature, along with the collision enable bits, allows you to specify the exact bits, and their polarity, for the collision to be registered.

**NOTE:** This register is *write-only*. If all bitplanes are excluded (disabled), then a bitplane collision will *always* be detected.

---

## Beam Position Detection

Sometimes you might want to synchronize the 680x0 processor to the video beam that is creating the screen display. In some cases, you may also wish to update a part of the display memory *after* the system has already accessed the data from the memory for the display area.

The address for accessing the beam counter is provided so that you can determine the value of the video beam counter and perform certain operations based on the beam position. *NOTE:* The Copper is already capable of watching the display position for you and doing certain register-based operations automatically. Refer to “Copper Interrupts” below and Chapter 2, “Coprocessor Hardware,” for further information.

In addition, when you are using a light pen, this same address is used to read the light pen position rather than the beam position. This is described fully in Chapter 8, “Interface Hardware.”

### USING THE BEAM POSITION COUNTER

There are four addresses that access the beam position counter. Their usage is described in Table 7-5.

Table 7-5: Contents of the Beam Position Counter

VPOSR	<i>Read-only</i>	Read the high bit of the vertical position (V8) and the frame-type bit.
Bit 15		LOF (Long-frame bit). Used to initialize interlaced displays.
Bits 14-1		Unused
Bit 0		High bit of the vertical position (V8). Allows PAL line counts (313) to appear in PAL versions of the Amiga.
VHPOSR	<i>Read-only</i>	Read vertical and horizontal position of the counter that is producing the beam on the screen (also reads the light pen).
Bits 15-8		Low bits of the vertical position, bits V7-V0
Bits 7-0		The horizontal position, bits H8-H1. Horizontal resolution is 1/160th of the screen width.
VPOSW	<i>Write only</i>	Bits same as VPOSR above.
VHPOSW	<i>Write only</i>	Bits same as VHPOSR above. Used for counter synchronization with chip test patterns.

As usual, the address pairs VPOSR,VHPOSR and VPOSW,VHPOSW can be read from and written to as long words, with the most significant addresses being VPOSR and VPOSW.

---

## Interrupts

This system supports the full range of 680x0 processor interrupts. The various kinds of interrupts generated by the hardware are brought into the peripherals chip and are translated into six of the seven available interrupts of the 680x0.

### NONMASKABLE INTERRUPT

Interrupt level 7 is the nonmaskable interrupt and is not generated anywhere in the current system. The raw interrupt lines of the 680x0, IPL2 through IPL0, are brought out to the expansion connector and can be used to generate this level 7 interrupt for debugging purposes.

### MASKABLE INTERRUPTS

Interrupt levels 1 through 6 are generated. Control registers within the peripherals chip allow you to mask certain of these sources and prevent them from generating a 680x0 interrupt.

### USER INTERFACE TO THE INTERRUPT SYSTEM

The system software has been designed to correctly handle all system hardware interrupts at levels 1 through 6. A separate set of input lines, designated INT2\* and INT6\*<sup>3</sup> have been routed to the expansion connector for use by external hardware for interrupts. These are known as the external low- and external high-level interrupts.

These interrupt lines are connected to the peripherals chip and create interrupt levels 2 and 6, respectively. It is recommended that you take advantage of the interrupt handlers built into the operating system by using these external interrupt lines rather than generating interrupts directly on the processor interrupt lines.

### INTERRUPT CONTROL REGISTERS

There are two interrupt registers, interrupt enable (mask) and interrupt request (status). Each register has both a read and a write address. The names of the interrupt addresses are:

INTENA

Interrupt0 enable (mask) - *write only*. Sets or clears specific bits of INTENA.

INTENAR

Interrupt enable (mask) read - *read only*. Reads contents of INTENA.

---

<sup>3</sup> A \* indicates an active low signal.

---

## INTREQ

Interrupt request (status) - *write only*. Used by the processor to force a certain kind of interrupt to be processed (software interrupt). Also used to clear interrupt request flags once the interrupt process is completed.

## INTREQR

Interrupt request (status) read - *read only*. Contains the bits that define which items are requesting interrupt service.

The bit positions in the interrupt request register correspond directly to those same positions in the interrupt enable register. The only difference between the read-only and the write-only addresses shown above is that bit 15 has no meaning in the read-only addresses.

## SETTING AND CLEARING BITS

Below are the meanings of the bits in the interrupt control registers and how you use them.

### ***Set and Clear***

The interrupt registers, as well as the DMA control register, use a special way of selecting which of the bits are to be set or cleared. Bit 15 of these registers is called the SET/CLR bit.

When you wish to *set* a bit (make it a 1), you must place a 1 in the position you want to set *and a 1 into position 15*.

When you wish to *clear* a bit (make it a 0), you must place a 1 in the position you wish to clear *and a 0 into position 15*.

Positions 14-0 are bit selectors. You write a 1 to any one or more bits to *select* that bit. At the same time you write a 1 or 0 to bit 15 to either *set* or *clear* the bits you have selected. Positions 14-0 that have 0 value will *not* be affected when you do the write. If you want to set some bits and clear others, you will have to write this register twice (once for setting some bits, once for clearing others).

### ***Master Interrupt Enable***

Bit 14 of the interrupt registers (INTEN) is for interrupt enable. This is the master interrupt enable bit. If this bit is a 0, it disables *all* other interrupts. You may wish to clear this bit to temporarily disable all interrupts to do some critical processing task.

*Warning:* This bit is used for enable/disable only. It creates no interrupt request.



---

## ***External Interrupts***

Bits 13 and 3 of the interrupt registers are reserved for external interrupts.

Bit 13, EXTER, becomes a 1 when the system line called INT6\* becomes a logic 0. Bit 13 generates a level 6 interrupt.

Bit 3, PORTS, becomes a 1 when the system line called INT2\* becomes a logic 0. Bit 3 causes a level 2 interrupt.

## ***Vertical Blanking Interrupt***

Bit 5, VERTB, causes an interrupt at line 0 (start of vertical blank) of the video display frame. The system is often required to perform many different tasks during the vertical blanking interval. Among these tasks are the updating of various pointer registers, rewriting lists of Copper tasks when necessary, and other system-control operations.

The minimum time of vertical blanking is 20 horizontal scan lines for an NTSC system and 25 horizontal scan lines for a PAL system. The range starts at line 0 and ends at line 20 for NTSC or line 25 for PAL. After the minimum vertical blanking range, you can control where the display actually starts by using the DIWSTRT (display window start) register to extend the effective vertical blanking time. See Chapter 3, "Playfield Hardware," for more information on DIWSTRT.

If you find that you still require additional time during vertical blanking, you can use the Copper to create a level 3 interrupt. This Copper interrupt would be timed to occur just after the last line of display on the screen (after the display window stop which you have defined by using the DIWSTOP register).

## ***Copper Interrupt***

Bit 4, COPER, is used by the Copper to issue a level 3 interrupt. The Copper can change the content of *any* of the bits of this register, as it can write any value into most of the machine registers. However, this bit has been reserved for specifically identifying the Copper as the interrupt source.

Generally, you use this bit when you want to sense that the display beam has reached a specific position on the screen, and you wish to change something in memory based on this occurrence.

---

### ***Audio Interrupts***

Bits 10 - 7, AUD3 - 0, are assigned to the audio channels. They are called AUD3, AUD2, AUD1, and AUD0 and are assigned to channels 3, 2, 1, and 0, respectively.

This level 4 interrupt signals “audio block done.” When the audio DMA is operating in automatic mode, this interrupt occurs when the last word in an audio data stream has been accessed. In manual mode, it occurs when the audio data register is ready to accept another word of data.

See Chapter 5, “Audio Hardware,” for more information about interrupt generation and timing.

### ***Blitter Interrupt***

Bit 6, BLIT, signals “blitter finished.” If this bit is a 1, it indicates that the blitter has completed the requested data transfer. The blitter is now ready to accept another task. This bit generates a level 3 interrupt.

### ***Disk Interrupt***

Bits 12 and 1 of the interrupt registers are assigned to disk interrupts.

Bit 12, DSKSYN, indicates that the sync register matches disk data. This bit generates a level 5 interrupt.

Bit 1, DSKBLK, indicates “disk block finished.” It is used to indicate that the specified disk DMA task that you have requested has been completed. This bit generates a level 1 interrupt.

More information about disk data transfer and interrupts may be found in Chapter 8, “Interface Hardware.”

### ***Serial Port Interrupts***

The following serial interrupts are associated with the specified bits of the interrupt registers.

Bit 11, RBF (for receive buffer full), specifies that the input buffer of the UART has data that is ready to read. This bit generates a level 5 interrupt.

Bit 0, TBE (for “transmit buffer empty”), specifies that the output buffer of the UART needs more data and data can now be written into this buffer. This bit generates a level 1 interrupt.

Hardware priority	Exec software priority		
		Description	
1	1	software interrupt	SOFTINT
	2	disk block complete	DSKBLK
	3	transmitter buffer empty	TBE
2	4	external INT2 & CIAA	PORTS
3	5	graphics coprocessor	COPER
	6	vertical blank interval	VERTB
	7	blitter finished	BLIT
4	8	audio channel 2	AUD2
	9	audio channel 0	AUD0
	10	audio channel 3	AUD3
	11	audio channel 1	AUD1
5	12	receiver buffer full	RBF
	13	disk sync pattern found	DSKSYNC
6	14	external INT6 & CIAB	EXTER
	15	special (master enable)	INTEN
7	--	non-maskable interrupt	NMI

Figure 7-4: Interrupt Priorities

---

## DMA Control

Many different direct memory access (DMA) functions occur during system operation. There is a read address as well as a write address to the DMA control register so you can tell which DMA channels are enabled.

The address names for the DMA registers are as follows:

DMACONR - Direct Memory Access Control - *read-only*.

DMACON - Direct Memory Access Control - *write-only*.

The contents of this register are shown in Table 7-6 (bit on if enabled).

Bit Number	Name	Function
15	SET/CLR	The set/reset control bit. See description of bit 15 under "Interrupts" above.
14	BBUSY	Blitter busy status - <i>read-only</i>
13	BZERO	Blitter zero status - <i>read-only</i> . Remains 1 if, during a blitter operation, the blitter output was always zero.
12, 11		Unassigned
10	BLTPRI	Blitter priority. Also known as "blitter-nasty." When this is a 1, the blitter has full (instead of partial) priority over the 680x0.
9	DMAEN	DMA enable. This is a master DMA enable bit. It enables the DMA for all of the channels at bits 8-0.
8	BPLEN	Bitplane DMA enable
7	COPEN	Coprocessor DMA enable
6	BLTEN	Blitter DMA enable
5	SPREN	Sprite DMA enable
4	DSKEN	Disk DMA enable
3-0	AUDxEN	Audio DMA enable for channels 3-0 (x = 3 - 0).

Table 7-6: Contents of DMA Control Register

---

For more information on using the DMA, see the following chapters:

Copper	Chapter 2	“Coprocessor Hardware”
Bitplanes	Chapter 3	“Playfield Hardware”
Sprites	Chapter 4	“Sprite Hardware”
Audio	Chapter 5	“Audio Hardware”
Blitter	Chapter 6	“Blitter Hardware”
Disk	Chapter 8	“Interface Hardware”

## PROCESSOR ACCESS TO CHIP MEMORY

The Amiga chips access Chip memory directly via DMA, rather than utilizing traditional bus arbitration mechanisms. Therefore, processor supplied features for multiprocessor support, such as the 68000 TAS (test and set) instruction, cannot serve their intended purpose and are not supported by the Amiga architecture.

## Reset and Early Startup Operation

When the Amiga is turned on or externally reset, the memory map is in a special state. An additional copy of the system ROM responds starting at memory location \$00000000. The system RAM that would normally be located at this address is not available. On some Amiga models, portions of the RAM still respond. On other models, no RAM responds. Software must assume that memory is not available. The OVL bit in one of the 8520 Chips disables the overlay (See Appendix F for the bit location).

The Amiga System ROM contains an ID code as the first word. The value of the ID code may change in the future. The second word of the ROM contains a JMP instruction (\$4ef9). The next two words are used as the initial program counter by the 680x0 processor.

The 68000 RESET instruction works much like external reset or power on. All memory and AUTOCONFIG™ cards disappear, and the ROM image appears at location \$00000000. The difference is that the CPU continues execution with the next instruction. Since RAM may not be available, special care is needed to write reboot code that will reliably reboot all Amiga models.

Here is a source code listing of the *only* supported reboot code:

```

*   NAME
*       ColdReboot - Official code to reset any Amiga (Version 2)
*
*   SYNOPSIS
*       ColdReboot()
*       void ColdReboot(void);
*
*   FUNCTION
*       Reboot the machine. All external memory and peripherals will be
*       RESET, and the machine will start its power up diagnostics.
*
*       Rebooting an Amiga in software is very tricky. Differing memory
*       configurations and processor cards require careful treatment. This
*       code represents the best available general purpose reset. The
*       MagicResetCode must be used exactly as specified here. The code
*       _must_ be longword aligned. Failure to duplicate the code EXACTLY
*       may result in improper operation under certain system configurations.
*
*   RESULT
*       This function never returns.

                INCLUDE "exec/types.i"
                INCLUDE "exec/libraries.i"

                XDEF      _ColdReboot
                XREF      _LVOSupervisor

ABSEXECSBASE    EQU 4                ;Pointer to the Exec library base
MAGIC_ROMEND    EQU $01000000        ;End of Kickstart ROM
MAGIC_SIZEOFFSET EQU -$14            ;Offset from end of ROM to Kickstart size
V36_EXEC        EQU 36                ;Exec with the ColdReboot() function
TEMP_ColdReboot EQU -726            ;Offset of the V36 ColdReboot function

_ColdReboot:    move.l  ABSEXECSBASE,a6
                cmp.w   #V36_EXEC,LIB_VERSION(a6)
                blt.s   old_exec
                jmp     TEMP_ColdReboot(a6)      ;Let Exec do it...
                ;NOTE: Control flow never returns to here

;---- manually reset the Amiga -----
old_exec:      lea.l   GoAway(pc),a5          ;address of code to execute
                jsr    _LVOSupervisor(a6)    ;trap to code at (a5)...
                ;NOTE: Control flow never returns to here

;----- MagicResetCode -----DO NOT CHANGE-----
GoAway:        CNOP    0,4                ;IMPORTANT! Longword align!
                lea.l  MAGIC_ROMEND,a0      ;(end of ROM)
                sub.l  MAGIC_SIZEOFFSET(a0),a0 ; (end of ROM)-(ROM size)=PC
                move.l 4(a0),a0            ;Get Initial Program Counter
                subq.l #2,a0                ;now points to second RESET
                reset   ;first RESET instruction
                jmp    (a0)                ;CPU Prefetch executes this
                ;NOTE: the RESET and JMP instructions must share a longword!
;-----DO NOT CHANGE-----
                END

```

*ECS system control.* For information on the system control registers in the Enhanced Chip Set (ECS), see Appendix C.







---

## chapter eight

# INTERFACE HARDWARE

This chapter covers the interface hardware through which the Amiga talks to the outside world, including the following features:

- Two multiple purpose mouse/joystick/light pen control ports
- Disk controller (for floppy disk drives & other MFM and GCR devices)
- Keyboard
- Centronics compatible parallel I/O interface (for printers)
- RS232-C compatible serial interface (for external modems or other serial devices)
- Video output connectors (RGB, monochrome, NTSC, RF modulator, video slot)

### Controller Port Interface

Each Amiga has two nine-pin connectors that can be used for input or output with a variety of controllers. Usually, the nine-pin connectors are used with a mouse or joystick but they will also accept input from light pens, paddles, trackballs, and other popular input devices.

Figure 8-1 shows one of the two connectors and the corresponding face-on view of a standard controller plug, while table 8-1 gives the pin assignments for some typical controllers.

Figure 8-1: Controller Plug and Computer Connector

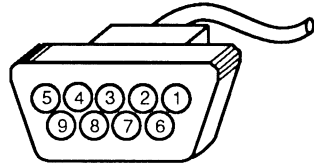

Face view –  
controller plug

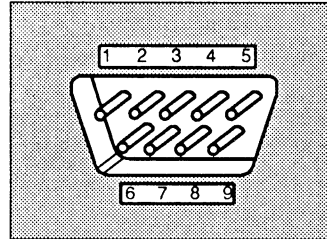

Face view –  
computer connector

Table 8-1: Typical Controller Connections

Pin	Joystick	Mouse, trackball, driving controller	Proportional controller (pair)	X-Y proportional joystick	Light pen
1	forward	V-pulse	---	button 3**	---
2	back	H-pulse	---	---	---
3	left	VQ-pulse	left button	button 1	---
4	right	HQ-pulse	right button	button 2	---
5*	---	middle button**	right POT	POT X	pen pressed to screen
6*	button 1	left button	---	---	beam trigger
7	---	+5V	+5V	+5V	+5V
8	GND	GND	GND	GND	GND
9*	button 2 **	right button	left POT	POT Y	button 2**

\* These pins may also be configured as outputs      \*\* These buttons are optional

---

## REGISTERS USED WITH THE CONTROLLER PORT

The Amiga chip registers that handle the controller port I/O are listed below.

JOY0DAT	(\$DFF00A)	Counter for digital (mouse) input (port 1)
JOY1DAT	(\$DFF00C)	Counter for digital (mouse) input (port 2)
CIAAPRA	(\$BFE001)	Input and output for pin 6 (port 1 and 2 fire buttons)
POT0DAT	(\$DFF012)	Counter for proportional input (port 1)
POT1DAT	(\$DFF014)	Counter for proportional input (port 2)
POTGO	(\$DFF034)	Write proportional pin values and start counters
POTGOR	(\$DFF016)	Read proportional pin values
BPLCON0	(\$DFF100)	Bit 3 enables the light pen latch
VPOSR	(\$DFF004)	Read light pen position (high order bits)
VHPOSR	(\$DFF006)	Read light pen position (low order bits)

## READING MOUSE/TRACKBALL CONTROLLERS

Pulses entering the mouse inputs are converted to separate horizontal and vertical counts. The 8 bit wide horizontal and vertical counter registers can track mouse movement without processor intervention.

The mouse uses quadrature inputs. For each direction, a mechanical wheel inside the mouse will produce two pulse trains, one 90 degrees out of phase with the other (see Figure 8-2 for details). The phase relationship determines direction.

The counters increment when the mouse is moved to the right or “down” (toward you).

The counters decrement when the mouse is moved to the left or “up” (away from you).

## MOUSE QUADRATURE

V	VQ	:	D1	D0
0	0	:	1	0
0	1	:	0	1
1	0	:	1	1
1	1	:	0	0

Case 1: Count Up:

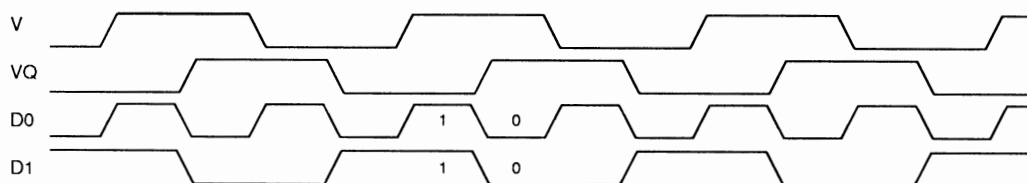

Case 2: Count Down:

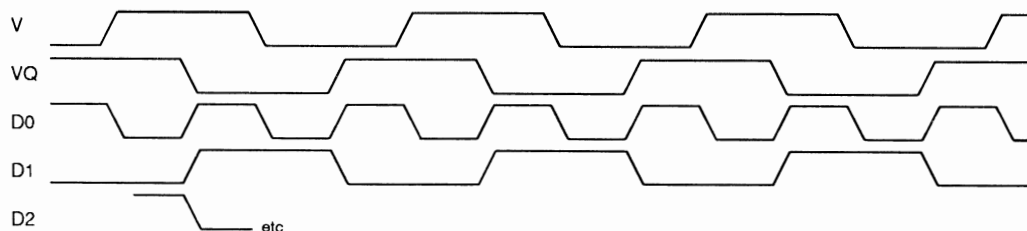

Figure 8-2: Mouse Quadrature

### ***Reading the Counters***

The mouse/trackball counter contents can be accessed by reading register addresses named JOY0DAT and JOY1DAT. These registers contain counts for ports 1 and 2 respectively.

The contents of each of these 16-bit registers are as follows:

- Bits 15-8 Mouse/trackball vertical count
- Bits 7-0 Mouse/trackball horizontal count

---

## Counter Limitations

These counters will “wrap around” in either the positive or negative direction. If you wish to use the mouse to control something that is happening on the screen, you must read the counters at least once each vertical blanking period and save the previous contents of the registers. Then you can subtract from the previous readings to determine direction of movement and speed.

The mouse produces about 200 count pulses per inch of movement in either a horizontal or vertical direction. Vertical blanking happens once each 1/60th of a second. If you read the mouse once each vertical blanking period, you will most likely find a count difference (from the previous count) of less than 127. Only if a user moves the mouse at a speed of more than 38 inches per second will the counter values wrap. Fast-action games may need to read the mouse register twice per frame to prevent counter overrun.

If you subtract the current count from the previous count, the absolute value of the difference will represent the speed. The sign of the difference (positive or negative) lets you determine which direction the mouse is traveling.

The easiest way to calculate mouse velocity is with 8-bit signed arithmetic. The new value of a counter minus the previous value will represent the number of mouse counts since the last check. The example shown in Table 8-2 presents an alternate method. It treats both counts as unsigned values, ranging from 0 to 255. A count of 100 pulses is measured in each case.

Table 8-2: Determining the Direction of the Mouse

Previous Count	Current Count	Direction
200	100	Up (Left)
100	200	Down (Right)
200	45	Down *
45	200	Up **

Notes for Table 8-2:

\* Because  $200 - 45 = 155$ , which is more than 127, the true count must be  $255 - (200 - 45) = 100$ ; the direction is down.

\*\*  $45 - 200 = -155$ . Because the absolute value of  $-155$  exceeds 127, the true count must be  $255 + (-155) = 100$ ; the direction is up.

---

## Mouse Buttons

There are two buttons on the standard Amiga mouse. However, the control circuitry and software support up to three buttons.

- The left button on the Amiga mouse is connected to CIAAPRA (\$BFE001). Port 1 uses bit 6 and port 2 uses bit 7. A logic state of 1 means “switch open.” A logic state of 0 means “switch closed.” (See Appendix F for more information.)
- Button 2 (right button on Amiga mouse) is connected to pin 9 of the controller ports, one of the proportional pins. See “Digital Input/Output on the Controller Port” for details.
- Button 3, when used, is connected to pin 5, the other proportional controller input.

## READING DIGITAL JOYSTICK CONTROLLERS

Digital joysticks contain four directional switches. Each switch can be individually activated by the control stick. When the stick is pressed diagonally, two adjacent switches are activated. The total number of possible directions from a digital joystick is 8. All digital joysticks have at least one fire button.

Digital joystick switches are of the normally open type. When the switches are pressed, the input line is shorted to ground. An open switch reads as “1”, a closed switch as “0”.

Reading the joystick input data logic states is not so simple, however, because the data registers for the joysticks are the same as the counters that are used for the mouse or trackball controllers. The joystick registers are named JOY0DAT and JOY1DAT.

Table 8-3 shows how to interpret the data once you have read it from these registers. The true logic state of the switch data in these registers is “1 = switch closed.”

Data Bit	Interpretation
1	True logic state of “right” switch.
9	True logic state of “left” switch.
1 (XOR) 0	You must calculate the exclusive-or of bits 1 and 0 to obtain the logic state of the “back” switch.
9 (XOR) 8	You must calculate the exclusive-or of bits 9 and 8 to obtain the logic state of the “forward” switch.

Table 8-3: Interpreting Data from JOY0DAT and JOY1DAT

The fire buttons for ports 0 and 1 are connected to bits 6 and 7 of CIAAPRA (\$BFE001). A 0 here indicates the switch is closed.

Some, but not all, joysticks have a second button. We encourage the use of this button *if* the function the button controls is duplicated via the keyboard or another mechanism. This button may be read in the same manner as the right mouse button.

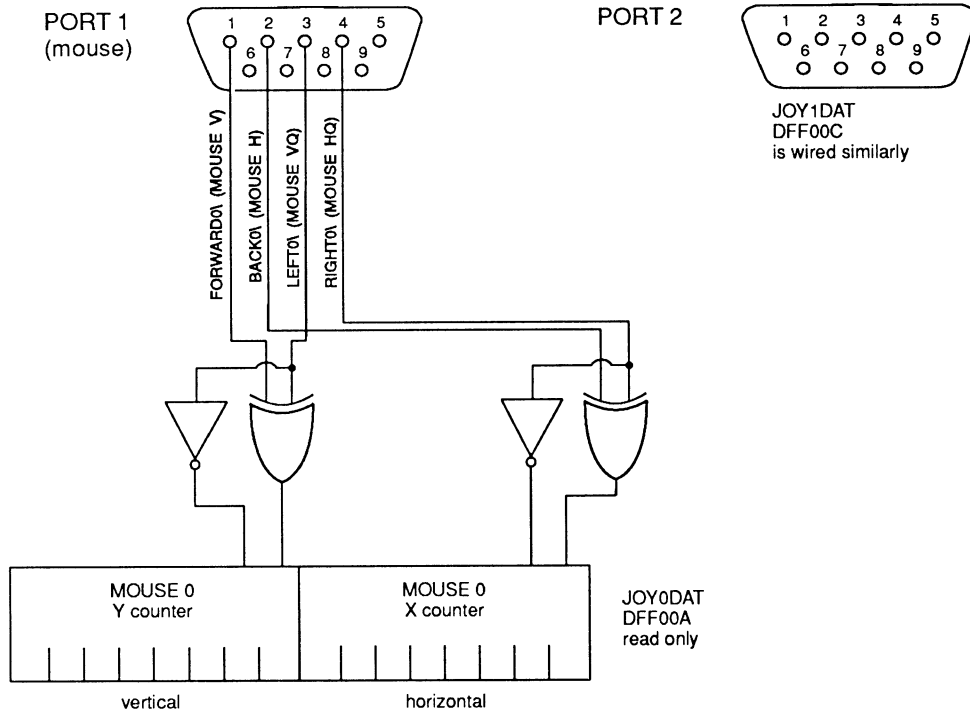

Figure 8-3: Joystick to Counter Connections

## READING PROPORTIONAL CONTROLLERS

Each of the game controller ports can handle two variable-resistance input devices, also known as proportional input devices. This section describes how the positions of the proportional input devices can be determined. There are two common types of proportional controllers: the “paddle” controller pair and the X-Y proportional joystick. A paddle controller pair consists of two individual enclosures, each containing a single resistor and fire-button and each connected to a common controller port input connector. Typical connections are shown in Figure 8-4.

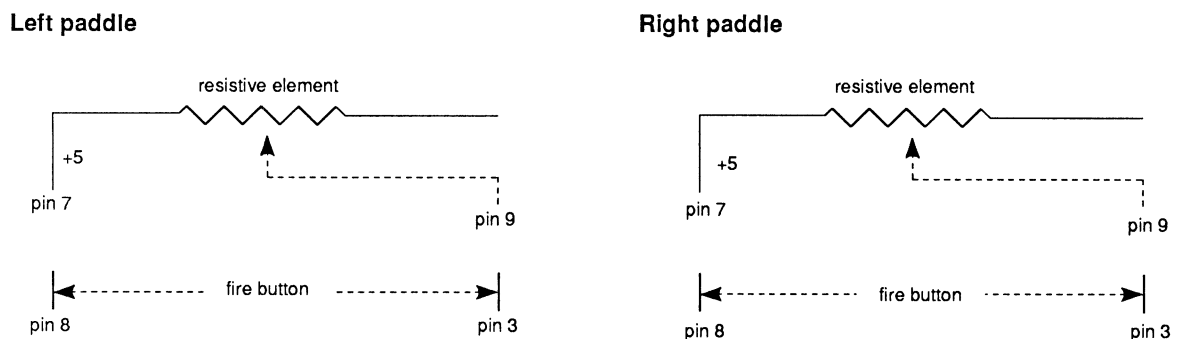

Figure 8-4: Typical Paddle Wiring Diagram

In an X-Y proportional joystick, the resistive elements are connected individually to the X and Y axes of a single controller stick.

### ***Reading Proportional Controller Buttons***

For the paddle controllers, the left and right joystick direction lines serve as the fire buttons for the left and right paddles.

### ***Interpreting Proportional Controller Position***

Interpreting the position of the proportional controller normally requires some preliminary work during the vertical blanking interval.

During vertical blanking, you write a value into an address called POTGO. For a standard X-Y joystick, this value is hex 0001. Writing to this register starts the operation of some special hardware that reads the potentiometer values and sets the values contained in the POT registers (described below) to zero.



The read circuitry stays in a reset state for the first seven or eight horizontal video scan lines. Following the reset interval, the circuit allows a charge to begin building up on a timing capacitor whose charge rate will be controlled by the position of the external controller resistance. For each horizontal scan line thereafter, the circuit compares the charge on the timing capacitor to a preset value. If the charge is below the preset, the POT counter is incremented. If the charge is above the preset, the counter value will be held until the next POTGO is issued.

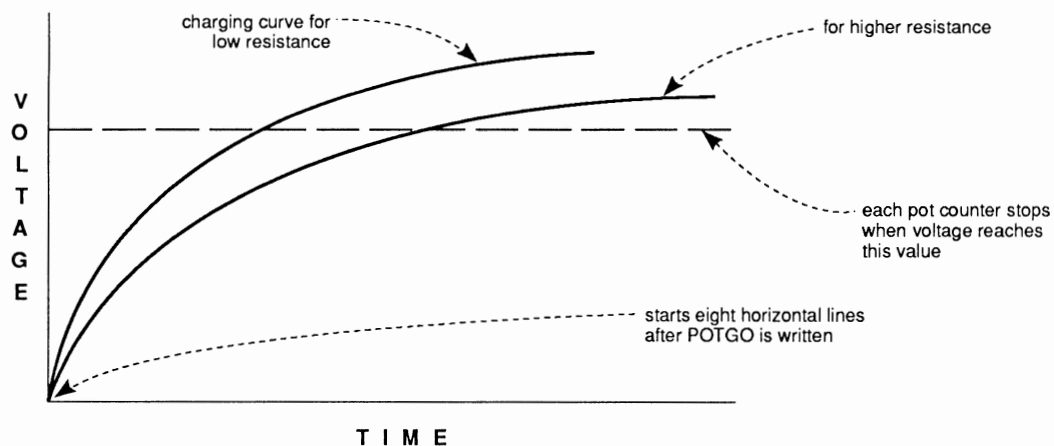

Figure 8-5: Effects of Resistance on Charging Rate

You normally issue POTGO at the beginning of a video screen, then read the values in the POT registers during the next vertical blanking period, just before issuing POTGO again.

Nothing in the system prevents the counters from overflowing (wrapping past a count of 255). However, the system is designed to insure that the counter cannot overflow within the span of a single screen. This allows you to know for certain whether an overflow is indicated by the controller.

---

### ***Proportional Controller Registers***

The following registers are used for the proportional controllers:

POT0DAT - port 1 data (vertical/horizontal)

POT1DAT - port 2 data (vertical/horizontal)

Bit positions:

Bits 15-8 POT0Y value or POT1Y value

Bits 7-0 POT0X value or POT1X value

All counts are reset to zero when POTGO is written with bit zero high. Counts are normally read one frame after the scan circuitry is enabled.

### ***Potentiometer Specifications***

The resistance of the potentiometers should be a linear taper. Based on the design of the integrating analog-to-digital converter used, the maximum resistance should be no more than 528K (470K +/- 10 percent is suggested) for either the X or Y pots. This is based on a charge capacitor of 0.047uf, +/- 10 percent, and a maximum time of 16.6 milliseconds for charge to full value, ie. one video frame time.

All potentiometers exhibit a certain amount of "jitter". For acceptable results on a wide base of configurations, several input readings will need to be averaged.

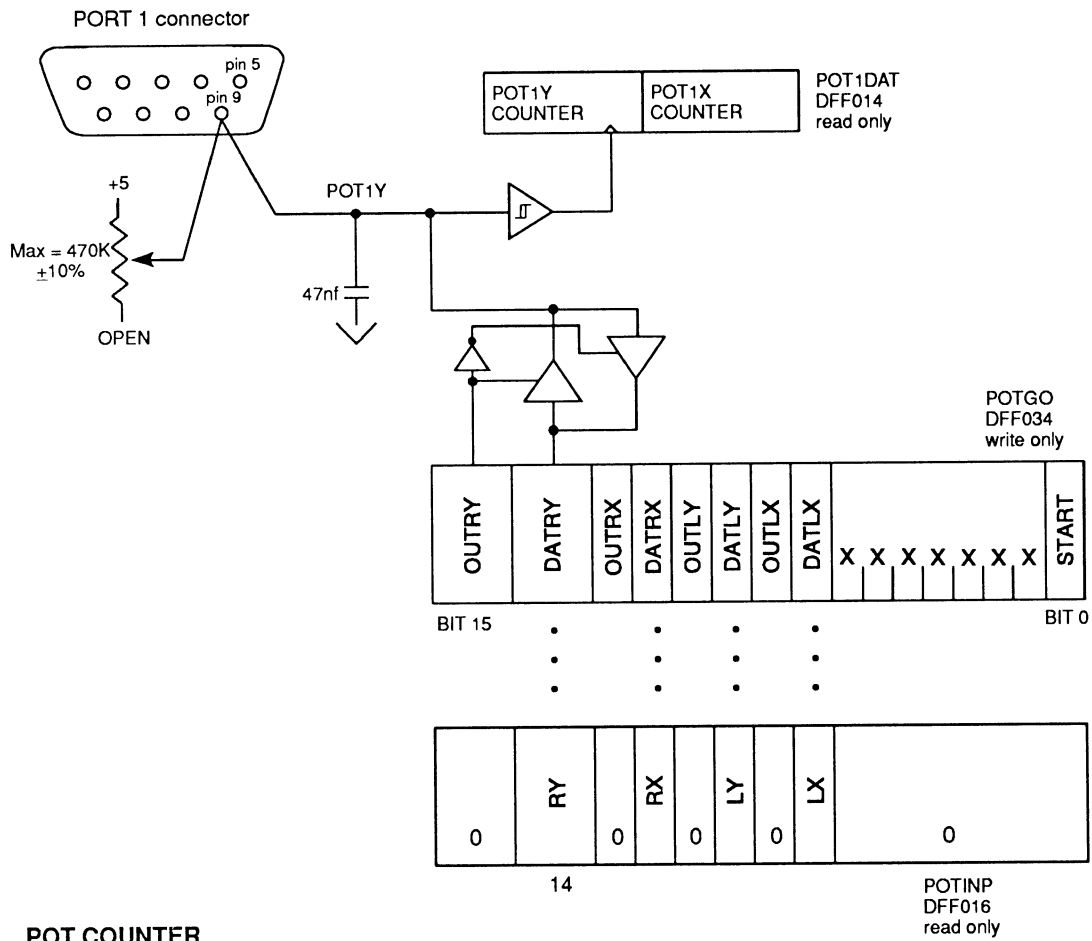

Figure 8-6: Potentiometer Charging Circuit

---

## READING A LIGHT PEN

A light pen can be connected to one of the controller ports. On the A1000, the light pen must be connected to port 1. Changing ports requires a minor internal modification. On the A500, A2000 and A3000 the default is port 2. An internal jumper can select port 1. Regardless of the port used, the light pen design is the same.

The signal called "pen-pressed-to-screen" is typically actuated by a switch in the nose of the light pen. Note that this switch is connected to one of the potentiometer inputs and must be read as same as the right or middle button on a mouse.

The principles of light pen operation are as follows:

1. Just as the system exits vertical blank, the capture circuitry for the light pen is automatically enabled.
2. The video beam starts to create the picture, sweeping from left to right for each horizontal line as it paints the picture from the top of the screen to the bottom.
3. The sensors in the light pen see a pulse of light as the video beam passes by. The pen converts this light pulse into an electrical pulse on the "Beam Trigger" line (pin 6).
4. This trigger signal tells the internal circuitry to capture and save the current contents of the beam register, VPOSR. This allows you to determine where the pen was placed by reading the exact horizontal and vertical value of the counter beam at the instant the beam passed the light pen.

### *Reading the Light Pen Registers*

The light pen register is at the same address as the beam counters. The bits are as follows:

VPOSR:	Bit 15	Long frame/short frame. 0=short frame
	Bits 14-1	Chip ID code. Do not depend on value!
	Bit 0	V8 (most significant bit of vertical position)
VHPOSR:	Bits 15-8	V7-V0 (vertical position)
	Bits 7-0	H8-H1 (horizontal position)

The software can refer to this register set as a long word whose address is VPOSR.

---

The positional resolution of these registers is as follows:

- Vertical      1 scan line in non-interlaced mode  
                 2 scan lines in interlaced mode (However, if you know which interlaced frame is under display, you can determine the correct position)
  
- Horizontal    2 low resolution pixels in either high or low resolution

The quality of the light pen will determine the amount of short-term jitter. For most applications, you should average several readings together.

To enable the light pen input, write a 1 into bit 3 of BPLCON0. Once the light pen input is enabled and the light pen issues a trigger signal, the value in VPOSR is frozen. If no trigger is seen, the counters latch at the end of the display field. It is impossible to read the current beam location while the VPOSR register is latched. This freeze is released at the end of internal vertical blanking (vertical position 20). There is no single bit in the system that indicates a light pen trigger. To determine if a trigger has occurred, use one of these methods:

1. Read (long) VPOSR twice.
2. If both values are not the same, the light pen has not triggered since the last top-of-screen ( $V = 20$ ).
3. If both values are the same, mask off the upper 15 bits of the 32-bit word and compare it with the hex value of \$10500 ( $V=261$ ).
4. If the VPOSR value is greater than \$10500, the light pen has not triggered since the last top-of-screen. If the value is less, the light pen has triggered and the value read is the screen position of the light pen.

A somewhat simplified method of determining the truth of the light pen value involves instructing the system software to read the register *only* during the internal vertical blanking period of  $0 < V < 20$ :

1. Read (long) VPOSR once, during the period of  $0 < V < 20$ .
2. Mask off the upper 15 bits of the 32-bit word and compare it with the hex value of \$10500 ( $V=261$ ).
3. If the VPOSR value is greater than \$10500, the light pen has not triggered since the last top-of-screen. If the value is less, the light pen has triggered and the value read is the screen position of the light pen.

Note that when the light pen latch is enabled, the VPOSR register may be latched at any time, and cannot be relied on as a counter. This behavior may cause problems with software that attempts to derive timing based on VPOSR ticks.

## DIGITAL I/O ON THE CONTROLLER PORT

The Amiga can read and interpret many different and nonstandard controllers. The control lines built into the POTGO register (address \$DFF034) can redefine the functions of some of the controller port pins.

Table 8-4 is the POTGO register bit description. POTGO (\$DFF034) is the write-only address for the pot control register. POTINP (\$DFF016) is the read-only address for the pot control register. The pot-control register controls a four-bit bidirectional I/O port that shares the same four pins as the four pot inputs.

Table 8-4: POTGO (\$DFF034) and POTINP (\$DFF016) Registers

Bit Number	Name	Function
15	OUTRY	Output enable for bit 14 (1=output)
14	DATRY	data for port 2, pin 9
13	OUTRX	Output enable for bit 12
12	DATRX	data for port 2, pin 5
11	OUTLY	Output enable for bit 10
10	DATLY	data for port 1, pin 9 (right mouse button)
09	OUTLX	Output enable for bit 8
08	DATLX	data for port 1, pin 5 (middle mouse button)
07-01	X	chip revision identification number
00	START	Start pots (dump capacitors, start counters)

Instead of using the pot pins as variable-resistive inputs, you can use these pins as a four-bit input/output port. This provides you with two additional pins on each of the two controller ports for general purpose I/O.

If you set the output enable for any pin to a 1, the Amiga disconnects the potentiometer control circuitry from the port, and configures the pin for output. The state of the data bit controls the logic level on the output pin. This register must be written to at the POTGO address, and read from the POTINP address. There are large capacitors on these lines, and it can take up to 300 microseconds for the line to change state.

To use the entire register as an input, sensing the current state of the pot pins, write all 0s to POTGO. Thereafter you can read the current state by using read-only address POTINP. Note that bits set as inputs will be connected to the proportional counters (See the description of the START bit in POTGO).

---

These lines can also be used for button inputs. A button is a normally open switch that shorts to ground. The Amiga must provide a pull-up resistance on the sense pin. To do this, set the proper pin to output, and drive the line high (set both OUT... and DAT... to 1). Reading POTINP will produce a 0 if the button is pressed, a 1 if it is not.

The joystick fire buttons can also be configured as outputs. CIAADDRA (\$BFE201) contains a mask that corresponds one-to-one with the data read register, CIAAPRA (\$BFE001). Setting a 1 in the direction position makes the corresponding bit an output. See Appendix F for more details.

## Floppy Disk Controller

The built-in disk controller in the system can handle up to four MFM-type devices. Typically these are double-sided, double-density, 3.5" (90mm) or 5.25" disk drives. One 3.5" drive is installed in the basic unit.

The controller is extremely flexible. It can DMA an entire track of raw MFM data into memory in a single disk revolution. Special registers allow the CPU to synchronize with specific data, or read input a byte at a time. The controller can read and write virtually any double-density MFM encoded disk, including the Amiga V1.0 format, IBM PC (MS-DOS) 5.25", IBM PC (MS-DOS) 3.5" and most CP/M™ formatted disks. The controller has provisions for reading and writing most disk using the Group Coded Recording (GCR) method, including Apple II™ disks. With motor speed tricks, the controller can read and write Commodore 1541/1571 format diskettes.

### REGISTERS USED BY THE DISK SUBSYSTEM

The disk subsystem uses two ports on the system's 8520 CIA chips, and several registers in the Paula chip:

CIAAPRA	(\$BFE001)	four input bits for disk sensing
CIABPRB	(\$BFD100)	eight output bits for disk selection, control and stepping
ADKCON	(\$DFF09E)	control bits (write only register)
ADKCONR	(\$DFF010)	control bits (read only register)
DSKPTH	(\$DFF020)	DMA pointer (32 bits)
DSKLEN	(\$DFF024)	length of DMA
DSKBYTR	(\$DFF01A)	Disk data byte and status read
DSKSYNC	(\$DFF07E)	Disk sync finder; holds a match word

## DISK SUBSYSTEM TIMING

Figures 8-7 and 8-8 show the timing parameters of the Amiga's floppy disk subsystem with a Chinon drive. Keep in mind that this information can change with floppy drives from other vendors. To ensure compatibility with future versions of the system, you should avoid using this information in applications.

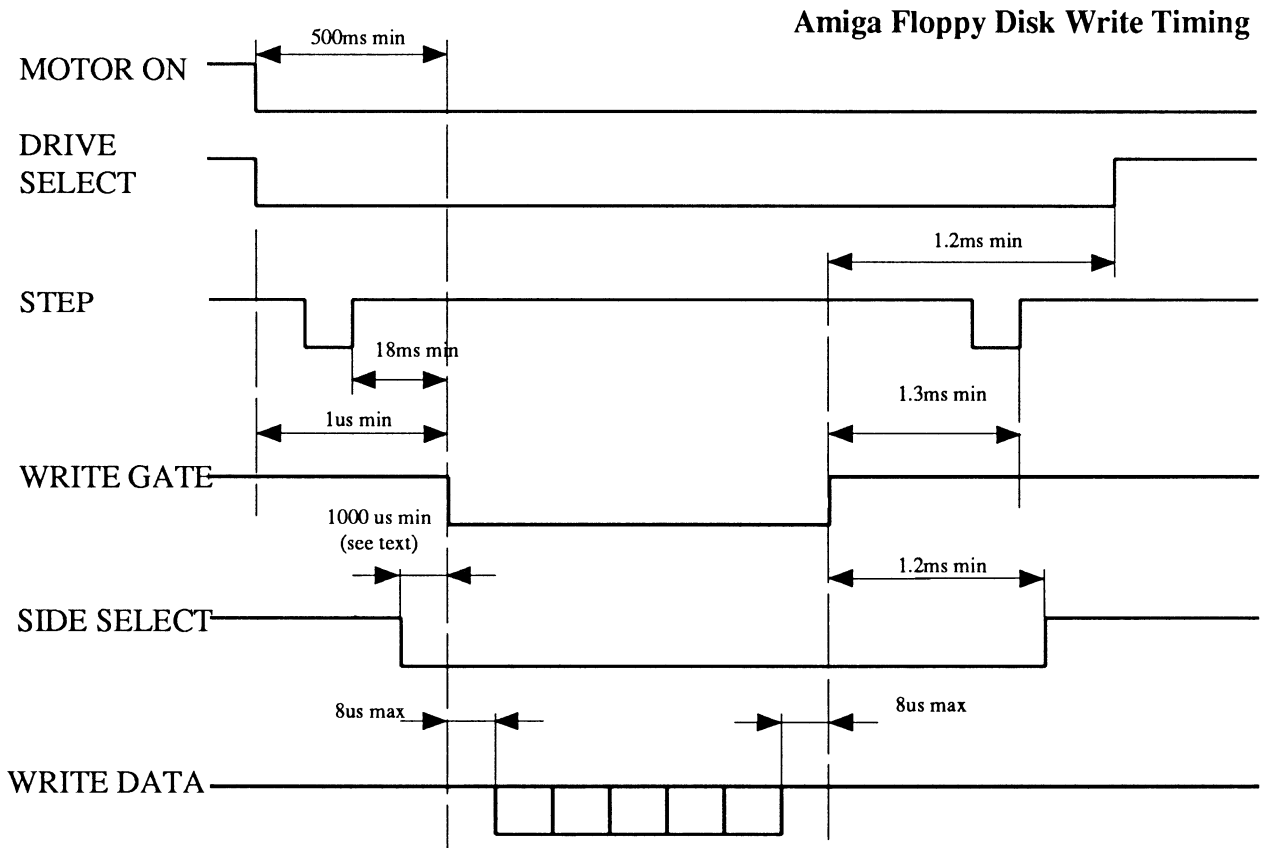
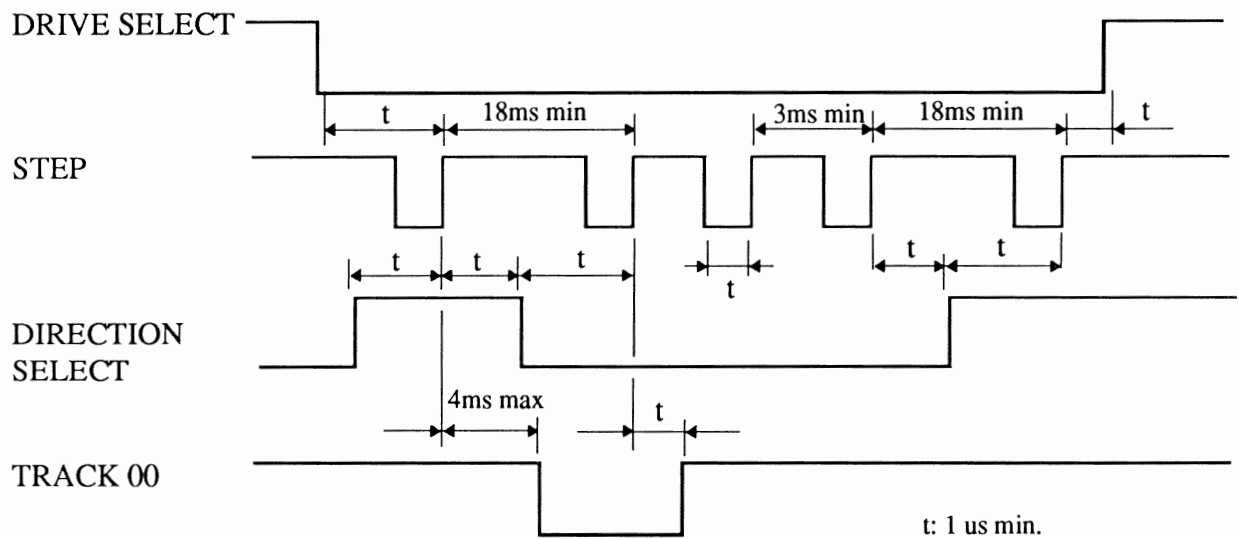

Figure 1-7: Chinon Timing Diagram



### Amiga Floppy Disk Access Timing



### Amiga Floppy Disk Read Timing

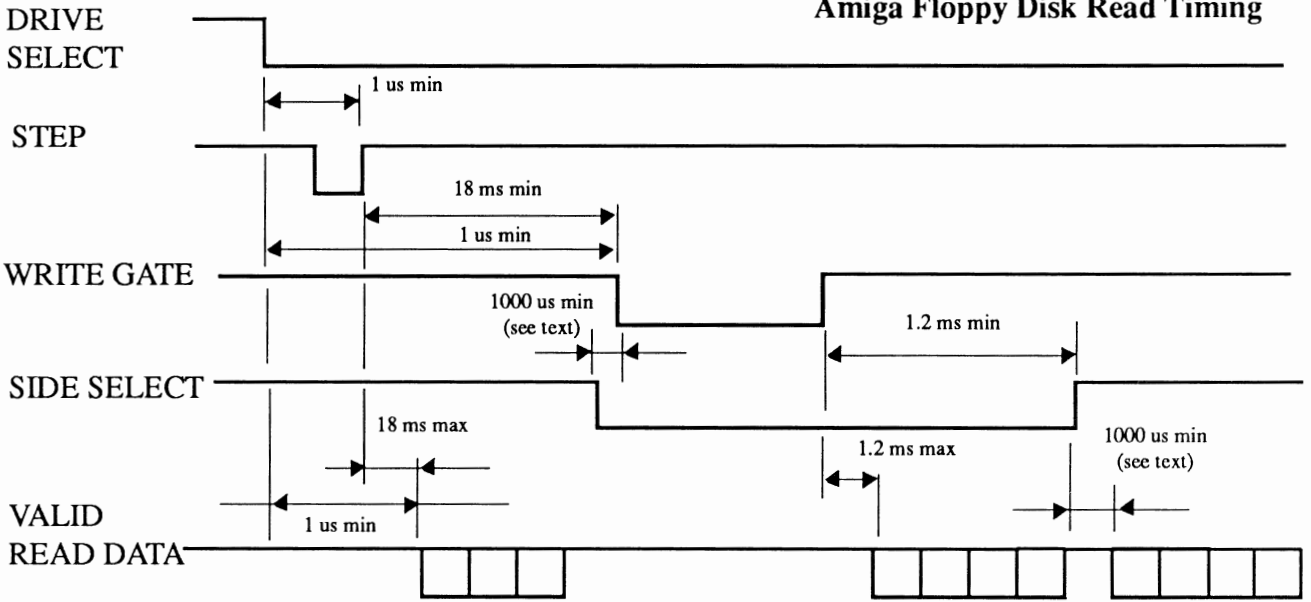

Figure 8-8: Chinon Timing Diagram (cont.)

---

## **CIAAPRA/CIABPRB - Disk selection, control and sensing**

The following table lists how 8520 chip bits used by the disk subsystem. Bits labeled "PA" are input bits in CIAAPRA (\$BFE001). Bits labeled "PB" are output bits located in CIAAPRB (\$BFD100). More information on how the 8520 chips operate can be found in Appendix F.

Table 8-5: Disk Subsystem

<b>Bit</b>	<b>Name</b>	<b>Function</b>
PA5	DSKRDY*	Disk ready (active low). The drive will pull this line low when the motor is known to be rotating at full speed. This signal is only valid when the motor is ON, at other times configuration information may obscure the meaning of this input.
PA4	DSKTRACK0*	Track zero detect. The drive will pull this line low when the disk heads are positioned over track zero. Software must not attempt to step outwards when this signal is active. Some drives will refuse to step, others will attempt the step, possibly causing alignment damage. All new drives must refuse to step outward in this condition.
PA3	DSKPROT*	Disk is write protected (active low).
PA2	DSKCHANGE*	Disk has been removed from the drive. The signal goes low whenever a disk is removed. It remains low until a disk is inserted AND a step pulse is received.
	-----	
PB7	DSKMOTOR*	Disk motor control (active low). This signal is nonstandard on the Amiga system. Each drive will latch the motor signal at the time its select signal turns on. The disk drive motor will stay in this state until the next time select turns on. DSKMOTOR* also controls the activity light on the front of the disk drive.

All software that selects drives must set up the motor signal *before* selecting any drives. The drive will "remember" the state of its motor when it is not selected. All drive motors turn off after system reset.

After turning on the motor, software must further wait for one half second (500ms), or for the DSKRDY\* line to go low.

---

PB6	DSKSEL3*	Select drive 3 (active low).
PB5	DSKSEL2*	Select drive 2 (active low).
PB4	DSKSEL1*	Select drive 1 (active low).
PB3	DSKSEL0*	Select drive 0 (internal drive) (active low).
PB2	DSKSIDE	Specify which disk head to use. Zero indicates the upper head. DSKSIDE must be stable for 100 microseconds before writing. After writing, at least 1.3 milliseconds must pass before switching DSKSIDE.
PB1	DSKDIREC	Specify the direction to seek the heads. Zero implies seek towards the center spindle. Track zero is at the outside of the disk. This line must be set up <i>before</i> the actual step pulse, with a separate write to the register.
PB0	DSKSTEP*	Step the heads of the disk. This signal must always be used as a quick pulse (high, momentarily low, then high).

The drives used for the Amiga are guaranteed to get to the next track within 3 milliseconds. Some drives will support a much faster rate, others will fail. Loops that decrement a counter to provide delay are **not acceptable**. See Appendix F for a better solution.

When reversing directions, a minimum of 18 milliseconds delay is required from the last step pulse. Settle time for Amiga drives is specified at 15 milliseconds.

FLAG	DSKINDEX*	Disk index pulse (\$BFDD00, bit 4). Can be used to create a level 6 interrupt. See Appendix F for details.
------	-----------	--

---

### ***Disk DMA Channel Control***

Data is normally transferred to the disk by direct memory access (DMA). The disk DMA is controlled by four items:

- Pointer to the area into which or from which the data is to be moved
- Length of data to be moved by DMA
- Direction of data transfer (read/write)
- DMA enable

### ***DSKPTH - Pointer to Data***

You specify the 32-bit wide address from which or to which the data is to be transferred. The lowest bit of the address must be zero, and the buffer must be in Chip memory. The value must be written as a single long word to the DSKPTH register (\$DFF020).

### ***DSKLEN - Length, Direction, DMA Enable***

All of the control bits relating to this topic are contained in a write-only register, called DSKLEN:

Table 8-6: DSKLEN Register (\$DFF024)

Bit Number	Name	Usage
15	DMAEN	Secondary disk DMA enable
14	WRITE	Disk write (RAM → disk if 1)
13-0	LENGTH	Number of words to transfer

---

The hardware requires a special sequence in order to start DMA to the disk. This sequence prevents accidental writes to the disk. In short, the DMAEN bit in the DSKLEN register must be turned on twice in order to actually enable the disk DMA hardware. Here is the sequence you should follow:

1. Enable disk DMA in the DMACON register (See Chapter 7 for more information)
2. Set DSKLEN to \$4000, thereby forcing the DMA for the disk to be turned off.
3. Put the value you want into the DSKLEN register.
4. Write this value again into the DSKLEN register. This actually starts the DMA.
5. After the DMA is complete, set the DSKLEN register back to \$4000, to prevent accidental writes to the disk.

As each data word is transferred, the length value is decremented. After each transfer occurs, the value of the pointer is incremented. The pointer points to the the next word of data to written or read. When the length value counts down to 0, the transfer stops.

The recommended method of reading from the disk is to read an entire track into a buffer and then search for the sector(s) that you want. Using the DSKSYNC register (described below) will guarantee word alignment of the data. With this process you need to read from the disk only once for the entire track. In a high speed loader, the step to the next head can occur while the previous track is processed and checksummed. With this method there are no time-critical sections in reading data, other high-priority subsystems (such as graphics or audio) are be allowed to run.

If you have too little memory for track buffering (or for some other reason decide not to read a whole track at once), the disk hardware supports a limited set of sector-searching facilities. There is a register that may be polled to examine the disk input stream.

There is a hardware bug that causes the last three bits of data sent to the disk to be lost. Also, the last word in a disk-read DMA operation may not come in (that is, one less word may be read than you asked for).

---

### ***DSKBYTR - Disk Data Byte and Status Read (read-only)***

This register is the disk-microprocessor data buffer. In read mode, data from the disk is placed into this register one byte at a time. As each byte is received into the register, the DSKBYT bit is set true. DSKBYT is cleared when the DSKBYTR register is read.

DSKBYTR may be used to synchronize the processor to the disk rotation before issuing a read or write under DMA control.

Table 8-7: DSKBYTR Register

<b>Bit Number</b>	<b>Name</b>	<b>Function</b>
15	DSKBYT	When set, indicates that this register contains a valid byte of data (reset by reading this register).
14	DMAON	Indicates when DMA is actually enabled. All the various DMA bits must be true. This means the DMAEN bit in DKSLEN, and the DSKEN & DMAEN bits in DMACON.
13	DISKWRITE	The disk write bit (in DSKLEN) is enabled.
12	WORDEQUAL	Indicates the DISKSYNC register equals the disk input stream. This bit is true only while the input stream matches the sync register (as little as two microseconds).
11-8		Currently unused; don't depend on read value.
7-0	DATA	Disk byte data.

## ***ADKCON and ADKCONR - Audio and Disk Control Register***

ADKCON is the write-only address and ADKCONR is the read-only address for this register. Not all of the bits are dedicated to the disk. Bit 15 of this register allows independent setting or clearing of any bit or bits. If bit 15 is a one on a write, any ones in positions 0-14 will set the corresponding bit. If bit 15 is a zero, any ones will clear the corresponding bit.

Table 8-8: ADKCON and ADKCONR Register

<b>Bit Number</b>	<b>Name</b>	<b>Function</b>
15	SET/CLR	Control bit that allows setting or clearing of individual bits without affecting the rest of the register. If bit 15 is a 1, the specified bits are set. If bit 15 is a 0, the specified bits are cleared.
14 13	PRECOMP1 PRECOMP0	MSB of Precompensation specifier LSB of Precompensation specifier Value of 00 selects none. Value of 01 selects 140 ns. Value of 10 selects 280 ns. Value of 11 selects 560 ns.
12	MFMPREC	Value of 0 selects GCR Precompensation. Value of 1 selects MFM Precompensation.
10	WORDSYNC	Value of 1 enables synchronizing and starting of DMA on disk read of a word. The word on which to synchronize must be written into the DSKSYNC address (\$DFF07E). This capability is highly useful.
9	MSBSYNC	Value of 1 enables sync on most significant bit of the input (usually used for GCR).
8	FAST	Value of 1 selects two microseconds per bit cell (usually MFM). Data must be valid raw MFM. 0 selects four microseconds per bit (usually GCR).
7-0		These bits are used by the audio subsystem for volume and frequency modulation.

---

The raw MFM data that must be presented to the disk controller will be twice as large as the unencoded data. The following table shows the relationship:

**1 → 01**  
**0 → 10 ;if following a 0**  
**0 → 00 ;if following a 1**

With clever manipulation, the blitter can be used to encode and decode the MFM.

In one common form of GCR recording, each data byte always has the most significant bit set to a 1. MSBSYNC, when a 1, tells the disk controller to look for this sync bit on every disk byte. When reading a GCR formatted disk, the software must use a translate table called a nybble-izer to assure that data written to the disk does not have too many consecutive 1's or 0's.

### ***DSKSYNC - Disk Input Synchronizer***

The DSKSYNC register is used to synchronize the input stream. This is highly useful when reading disks. If the WORDSYNC bit is enabled in ADKCON, no data is transferred until a word is found in the input stream that matches the word in the DSKSYNC register. On read, DMA will start with the following word from the disk. During disk read DMA, the controller will resync every time the word match is found. Typically the DSKSYNC will be set to the magic MFM sync mark value, \$4489.

In addition, the DSKSYNC bit in INTREQ is set when the input stream matches the DSKSYNC register. The DSKSYNC bit in INTREQ is independent of the WORDSYNC enable.

## **DISK INTERRUPTS**

The disk controller can issue three kinds of interrupts:

- DSKSYNC (level 5, INTREQ bit 12)—input stream matches the DSKSYNC register.
- DSKBLK (level 1, INTREQ bit 1)—disk DMA has completed.
- INDEX (level 6, 8520 Flag pin)—index sensor triggered.

Interrupts are explained further in the section “Length, Direction, DMA Enable”. See Chapter 7, “System Control Hardware,” for more information about interrupts. See Appendix F for more information on the 8520.



---

## The Keyboard

The keyboard is interfaced to the system via the serial shift register on one of the 8520 CIA chips. The keyboard data line is connected to the SP pin, the keyboard clock is connected to the CNT pin. Appendix G contains a full description of the interface.

### HOW THE KEYBOARD DATA IS RECEIVED

The CNT line is used as a clock for the keyboard. On each transition of this line, one bit of data is clocked in from the keyboard. The keyboard sends this clock when each data bit is stable on the SP line. The clock is an active low pulse. The rising edge of this pulse clocks in the data.

After a data byte has been received from the keyboard, an interrupt from the 8520 is issued to the processor. The keyboard waits for a handshake signal from the system before transmitting any more keystrokes. This handshake is issued by the processor pulsing the SP line low then high. While some keyboards can detect a 1 microsecond handshake pulse, the pulse must be at least 85 microseconds for operation with all models of Amiga keyboards.

If another keystroke is received before the previous one has been accepted by the processor, the keyboard microprocessor holds keys in a 10 keycode type-ahead buffer.

### TYPE OF DATA RECEIVED

The keyboard data is *not* received in the form of ASCII characters. Instead, for maximum versatility, it is received in the form of keycodes. These codes include both the down and up transitions of the keys. This allows your software to use both sets of information to determine exactly what is happening on the keyboard.

Here is a list of the hexadecimal values that are assigned to the keyboard. A downstroke of the key transmits the value shown here. An upstroke of the key transmits this value plus \$80. The picture of the keyboard at the end of this section shows the positions that correspond to the description in the paragraphs below.

Note that raw keycodes provide positional information *only*, the legend which is printed on top of the keys changes from country to country.

---

### **RAW Keycodes → 00-3F hex**

These are key codes assigned to specific positions on the main body of the keyboard. The letters on the tops of these keys are different for each country; not all countries use the QWERTY key layout. These keycodes are best described positionally as shown in Figure 8-9 and Figure 8-10 at the end of the keyboard section. The international keyboards have two more keys that are “cut out” of larger keys on the USA version. These are \$30, cut out from the the left shift, and \$2B, cut out from the return key.

### **RAW Keycodes → 40-5F hex (Codes common to all keyboards)**

40	Space
41	Backspace
42	Tab
43	Numeric Pad “ENTER”
44	Return
45	Escape
46	Delete
4A	Numeric pad minus
4C	Cursor up
4D	Cursor down
4E	Cursor right
4F	Cursor left
50-59	Function keys F1-F10
5A	Numeric pad left parenthesis
5B	Numeric pad right parenthesis
5C	Numeric pad slash “/”
5D	Numeric pad asterisk
5E	Numeric pad plus
5F	Help

### **RAW Keycodes → 60-67 hex (Key codes for qualifier keys)**

60	Left Shift
61	Right Shift
62	Caps Lock
63	Control
64	Left Alt
65	Right Alt
66	Left Amiga (or Commodore key)
67	Right Amiga

---

## **F0-FF hex**

These key codes are used for keyboard to 680x0 communication, and are not associated with a keystroke. They have no key transition flag, and are therefore described completely by 8-bit codes:

- 78    Reset warning. Ctrl-Amiga-Amiga has been pressed. The keyboard will wait a maximum of 10 seconds before resetting the machine.  
(Not available on all keyboard models)
- F9    Last key code bad, next key is same code retransmitted
- FA    Keyboard key buffer overflow
- FC    Keyboard self-test fail. Also, the caps-lock LED will blink to indicate the source of the error. Once for ROM failure, twice for RAM failure and three times if the watchdog timer fails to function.
- FD    Initiate power-up key stream (for keys held or stuck at power on)
- FE    Terminate power-up key stream.

These key codes will usually be filtered out by keyboard drivers.

## **LIMITATIONS OF THE KEYBOARD**

The Amiga keyboard is a matrix of rows and columns with a key switch at each intersection (see Appendix G for a diagram of the matrix). Because of this, the keyboard is subject to a phenomenon called “phantom keystrokes.” While this is generally not a problem for typing, games may require several keys be independently held down at once. By examining the matrix, you can determine which keys may interfere with each other, and which ones are always safe.

Phantom keystrokes occur when certain combinations of keys pressed are pressed simultaneously. For example, hold the “A” and “S” keys down simultaneously. Notice that “A” and “S” are transmitted. While still holding them down, press “Z”. On the original Amiga 1000 keyboard, both the “Z” and a ghost “X” would be generated. Starting with the Amiga 500, the controller was upgraded to notice simple phantom situations like the one above; instead of generating a ghost, the controller will hold off sending any character until the matrix has cleared (releasing “A” or “S” would clear the matrix). Some high-end Amiga keyboards may implement true “N-key rollover,” where any combination of keys can be detected simultaneously.

All of the keyboards are designed so that phantoms will not happen during normal typing, only when unusual key combinations like the one just described are pressed. Normally, the keyboard will appear to have “N-key rollover,” which means that you will run out of fingers before generating a ghost character.

*About the qualifier keys.* Seven keys are not part of the matrix, and will never contribute to generating phantoms. These keys are: Ctrl, the two Shift keys, the two Amiga keys, and the two Alt keys.

ESC 45	F1 50	F2 51	F3 52	F4 53	F5 54	F6 55	F7 56	F8 57	F9 58	F10 59	DEL 46								
~ 00	! 01	@ 02	# 03	\$ 04	% 05	^ 06	& 07	* 08	{ 09	} 0A	= 0B	+ 0C	Back Space 0D	7 3D	8 3E	9 3F			
Tab 42	Q 10	W 11	E 12	R 13	T 14	Y 15	U 16	I 17	O 18	P 19	1A 1A	1B 1B	Help 5F	4 2D	5 2E	6 2F			
CTRL 63	Caps Lock 62	A 20	S 21	D 22	F 23	G 24	H 25	J 26	K 27	L 28	; 29	' 2A	Return 44	↑ 4C	1 1D	2 1E	3 1F		
Shift 60	30	Z 31	X 32	C 33	V 34	B 35	N 36	M 37	< 38	> 39	? 3A	Shift 61	← 4F	→ 4E	0 0F	.3C			
	ALT 64	A 66	40					Alt 67	ALT 64	↓ 4D									
																Enter 43			

Figure 8-9: The Amiga 1000 Keyboard, Showing Keycodes in Hexadecimal

ESC 45	F1 50	F2 51	F3 52	F4 53	F5 54	F6 55	F7 56	F8 57	F9 58	F10 59										
~ 00	! 01	@ 02	# 03	\$ 04	% 05	^ 06	& 07	* 08	{ 09	} 0A	= 0B	+ 0C	Back Space 0D	DEL 46	Help 5F	( 5A	) 5B	/ 5C	· 5D	
Tab 42	Q 10	W 11	E 12	R 13	T 14	Y 15	U 16	I 17	O 18	P 19	1A 1A	1B 1B	Return 44			7 3D	8 3E	9 3F	. 4A	
CTRL 63	Caps Lock 62	A 20	S 21	D 22	F 23	G 24	H 25	J 26	K 27	L 28	; 29	' 2A	2B	↑ 4C		4 2D	5 2E	6 2F	+ 5E	
Shift 60	30	Z 31	X 32	C 33	V 34	B 35	N 36	M 37	< 38	> 39	? 3A	Shift 61	← 4F	↓ 4D	→ 4E	1 1D	2 1E	3 1F	Enter 43	
	ALT 64	A 66	40					Alt 67	ALT 64											
																0 0F	.3C			

Figure 8-10: The Amiga 500/2000/3000 Keyboard, Showing Keycodes in Hexadecimal

---

## Serial I/O Interface

A 25-pin connector on the back panel of the computer serves as the general purpose serial interface. This connector can drive a wide range of different peripherals, including an external modem or a serial printer.

For pin connections, see Appendix E.

### INTRODUCTION TO SERIAL CIRCUITRY

The Paula custom chip contains a Universal Asynchronous Receiver/Transmitter, or UART. This UART is programmable for any rate from 110 to over 1,000,000 bits per second. It can receive or send data with a programmable length of eight or nine bits.

The UART implementation provides a high degree of software control. The UART is capable of detecting overrun errors, which occur when some other system sends in data faster than you remove it from the data-receive register. There are also status bits and interrupts for the conditions of receive buffer full and transmit buffer empty. An additional status bit is provided that indicates "all bits have been shifted out". All of these topics are discussed below.

### SETTING THE BAUD RATE

The rate of transmission (the baud rate) is controlled by the contents of the register named SERPER. Bits 14-0 of SERPER are the baud-rate divider bits.

All timing is done on the basis of a "color clock," which is 279.36ns long on NTSC machines and 281.94ns on PAL machines. If the SERPER divisor is set to the number N, then N+1 color clocks occur between samples of the state of the input pin (for receive) or between transmissions of output bits (for transmit). Thus  $SERPER = (3,579,545/\text{baud}) - 1$ . On a PAL machine,  $SERPER = (3,546,895/\text{baud}) - 1$ . For example, the proper SERPER value for 9600 baud on an NTSC machine is  $(3,579,545/9600) - 1 = 371$ .

With a cable of a reasonable length, the maximum reliable rate is on the order of 150,000-250,000 bits per second. Maximum rates will vary between machines. At these high rate it is not possible to handle the overhead of interrupts. The receiving end will need to be in a tight read loop. Through the use of low speed control information and high-speed bursts, a very inexpensive communication network can be built.

### SETTING THE RECEIVE MODE

The number of bits that are to be received before the system tells you that the receive register is full may be defined either as eight or nine (this allows for 8 bit transmission with parity). In either case, the receive circuitry expects to see one start bit, eight or nine data bits, and at least one stop bit.

Receive mode is set by bit 15 of the write-only SERPER register. Bit 15 is a 1 if you chose nine data bits for the receive-register full signal, and a 0 if you chose eight data bits. The normal state of this bit for most receive applications is a 0.

## CONTENTS OF THE RECEIVE DATA REGISTER

The serial input data-receive register is 16 bits wide. It contains the 8 or 9 bit input data and status bits.

The data is received, one bit at a time, into an internal serial-to-parallel shift register. When the proper number of bit times have elapsed, the contents of this register are transferred to the serial data read register (SERDATR) shown in Table 8-10, and you are signaled that there is data ready for you.

Immediately after the transfer of data takes place, the receive shift register again becomes ready to accept new data. After receiving the receiver-full interrupt, you will have up to one full character-receive time (8 to 10 bit times) to accept the data and clear the interrupt. If the interrupt is not cleared in time, the OVERRUN bit is set.

Table 8-9 shows the definitions of the various bit positions within SERDATR.

Table 8-9: SERDATR / ADKCON Registers

SERDATR			
Bit Number	Name	Function	
15	OVRUN	<b>OVERRUN</b> (Mirror—also appears in the interrupt request register.) Indicates that another byte of data was received before the previous byte was picked up by the processor. To prevent this condition, it is necessary to reset INTF_RBF (bit 11, receive-buffer-full) in INTREQ.	
14	RBF	<b>READ BUFFER FULL</b> (Mirror—also appears in the interrupt request register.) When this bit is 1, there is data ready to be picked up by the processor. After reading the contents of this data register, you must reset the INTF_RBF bit in INTREQ to prevent an overrun.	

13	TBE	<p><b>TRANSMIT BUFFER EMPTY</b>          (Not a mirror—interrupt occurs when the buffer <i>becomes</i> empty.) When bit 14 is a 1, the data in the output data register (SERDAT) has been transferred to the serial output shift register, so SERDAT is ready to accept another output word. This is also true when the buffer <i>is</i> empty.          This bit is normally used for full-duplex operation.</p>
12	TSRE	<p><b>TRANSMIT SHIFT REGISTER EMPTY</b>          When this bit is a 1, the output shift register has completed its task, all data has been transmitted, and the register is now idle. If you stop writing data into the output register (SERDAT), then this bit will become a 1 after both the word currently in the shift register <i>and</i> the word placed into SERDAT have been transmitted.          This bit is normally used for half-duplex operation.</p>
11	RXD	Direct read of RXD pin on Paula chip.
10		Not used at this time.
9	STP	Stop bit if 9 data bits are specified for receive.
8	STP	Stop bit if 8 data bits are specified for receive.
		OR
	DB8	9th data bit if 9 bits are specified for receive.
7-0	DB7-DB0	Low 8 data bits of received data. Data is TRUE (data you read is the same polarity as the data expected).

**ADKCON**

15	SET/CLR	<p>Allows setting or clearing individual bits.          If bit 15 is a 1 specified bits are set.          If bit 15 is a 0 specified bits are cleared.</p>
11	UARTBRK	Force the transmit pin to zero.

## HOW OUTPUT DATA IS TRANSMITTED

You send data out on the transmit lines by writing into the serial data output register (SERDAT). This register is write-only.

Data will be sent out at the same rate as you have established for the read. Immediately after you write the data into this register, the system will begin the transmission at the baud rate you selected.

At the start of the operation, this data is transferred from SERDAT into an internal serial shift register. When the transfer to the serial shift register has been completed, SERDAT can accept new data; the TBE interrupt signals this fact.

Data will be moved out of the shift register, one bit during each time interval, starting with the least significant bit. The shifting continues until all 1 bits have been shifted out. Any number or combination of data and stop bits may be specified this way.

SERDAT is a 16-bit register that allows you to control the format (appearance) of the transmitted data. To form a typical data sequence, such as one start bit, eight data bits, and one stop bit, you write into SERDAT the contents shown in Figures 8-11 and 8-12.

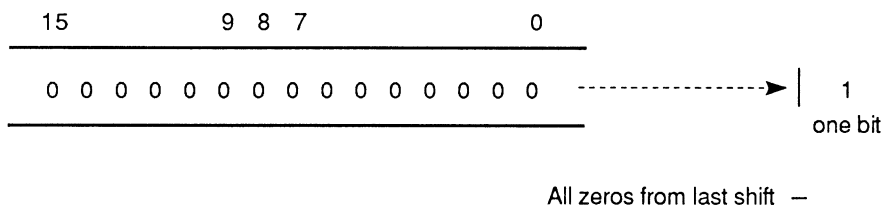

Figure 8-11: Starting Appearance of SERDAT and Shift Register



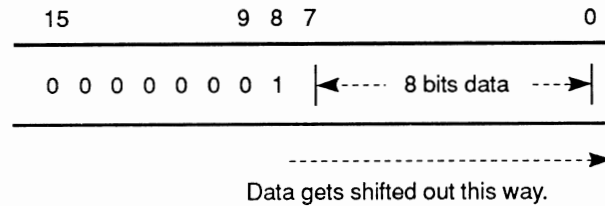

Figure 8-12: Ending Appearance of Shift Register

The register stops shifting and signals “shift register empty” (TSRE) when there is a 1 bit present in the bit-shifted-out position *and* the rest of the contents of the shift register are 0s. When new nonzero contents are loaded into this register, shifting begins again.

### SPECIFYING THE REGISTER CONTENTS

The data to be transmitted is placed in the output register (SERDAT). Above the data bits, 1 bits must be added as stop bits. Normally, either one or two stop bits are sent.

The transmission of the start bit is independent of the contents of this register. One start bit is automatically generated before the first data bit (bit 0) is sent.

*Writing this register starts the data transmission.* If this register is written with all zeros, *no* data transmission is initiated.

## Parallel I/O Interface

The general-purpose bi-directional parallel interface is a 25-pin connector on the back panel of the computer. This connector is generally used for a parallel printer.

For each data byte written to the parallel port register, the hardware automatically generates a pulse on the data ready pin. The acknowledge pulse from the parallel device is hooked up to an interrupt. For pin connections and timing, see Appendix E and F.

---

## Display Output Connections

All Amigas provide a 23-pin connector on the back. This jack contains video outputs and inputs for external genlock devices. Two separate type of RGB video are available on the connector:

- RGB Monitors (“analog RGB”). Provides four outputs; Red (R), Green (G), Blue (B), and Sync (S). They can generate up to 4,096 different colors on-screen simultaneously using the circuitry presently available on the Amiga.
- Digital RGB Monitors. Provides four outputs, distinct from those shown above, named Red (R), Green (G), Blue (B), Half-Intensity (I), and Sync (S). All output levels are logic levels (0 or 1). On some monitors these outputs allow up to 15 possible color combinations, where the values 0000 and 0001 map to the same output value (Half intensity with no color present is the same as full intensity, no color). Some monitors arbitrarily map the 16 combinations to 16 arbitrary colors.

Note that the sync signals from the Amiga are unbuffered. For use with any device that presents a heavy load on the sync outputs, external buffers will be required.

The Amiga 500 and 2000 provide a full-bandwidth monochrome video jack for use with inexpensive monochrome monitors. The Amiga colors are combined into intensities based on the following table:

Red	Green	Blue
30%	60%	10%

The A3000 is not equipped with a monochrome video jack.

The Amiga 1000 provides an RF modulator jack. An adapter is available that allows all Amiga models to use a television set for display. Stereo sound is available on the jack, but will generally be combined into monaural sound for the TV set.

The Amiga 1000 provides a color composite video jack. This is suitable for recording directly with a VCR, but the output is not broadcast quality. For use on a monochrome monitor, the color information often has undesired effects; careful color selection or a modification to the internal circuitry can improve the results. The A500, A2000 and A3000 do not have a color composite video jack. High quality composite adapters for the A500, A1000, A2000 and A3000 plug into the 23 pin RGB port.

The Amiga 2000 and 3000 provide a special “video slot” that contains many more signals than are available elsewhere: all the 23-pin RGB port signals, the unencoded digital video, light pen, power, audio, colorburst, pixel switch, sync, clock signals, etc.





---

# appendix A

## REGISTER SUMMARY

### ALPHABETICAL ORDER

This appendix contains the definitive summary, in alphabetical order, of the Amiga's custom chip register set and the usages of the individual bits.

The addresses shown here are used by the special custom chips (named "Paula", "Agnus", and "Denise") for transferring data among themselves. Also, the Copper uses these addresses for writing to the special chip registers. To write to these registers with the 680x0, calculate the 680x0 address using this formula:

$$680x0 \text{ address} = (\text{chip address}) + \$DFF000$$

For example, for the 680x0 to write to ADKCON (address = \$09E), the address would be \$DFF09E. No other access address is valid. Do not attempt to access any documented or unused registers.

All of the "pointer" type registers are organized as 32 bits on a long word boundary. These registers may be written with one MOVE.L instruction. The lowest bit of all pointers must be written as zero. The custom chips can only access Chip memory; using a non-Chip address will fail (See the AllocMem() documentation or your compiler manual for more information on Chip memory). Disk data, sprite data, bitplane data, audio data, copper lists and anything that will be blitted or accessed by custom chip DMA must be located in chip memory.

When strobing any register which responds to either a read or a write, (for example copjmp2) be sure to use a MOVE.W, not CLR.W. The CLR instruction causes a read and a clear (two accesses) on a 68000, but only a single access on 68020 processors. This will give different results on different processors.

*Warning:* Registers are either *read-only* or *write-only*. In the following descriptions, if a register is marked as a read-only register, only read its contents. Do not attempt to write to a read-only register, as this will cause unpredictable results. If a register is

---

marked as a write-only register, do not attempt to read from it, as this may trash the register and crash the system.

If a bit is described as unused in a write-only register, be sure to keep that bit clear when writing values to that register. Similarly, do not rely on the values of unused bits when reading from a read only register. Further, *do not* write to an address or register that is not documented or defined in this appendix. Setting unused bits in a write-only register, reading unused bits from a read only register and writing to undocumented registers or addresses may cause serious future software incompatibility if those bits or addresses are implemented in the future by Commodore Amiga.

*About the ECS registers.* Registers denoted with an "(E)" in the chip column means that those registers have been changed the Enhanced Chip Set(ECS). The ECS is found in the A3000, and is installable in the A500 and A2000. Certain ECS registers are completely new, others have been extended in their functionality. See the register map in Appendix C for information on which ECS registers are new and which have been modified.

Register	Address	Read/ Write	Agnus/ Denise/ Paula	Function
ADKCON	09E	W	P	Audio, disk, control write
ADKCONR	010	R	P	Audio, disk, control read
		BIT#	USE	
		15	SET/CLR	Set/clear control bit. Determines if bits written with a 1 get set or cleared. Bits written with a zero are always unchanged.
		14-13	PRECOMP 1-0	
			CODE	PRECOMP VALUE
			00	none
			01	140 ns
			10	280 ns
			11	560 ns
		12	MFMPREC	( 1=MFM precomp 0=GCR precomp)
		11	UARTBRK	Forces a UART break (clears TXD) if true.
		10	WORDSYNC	Enables disk read synchronizing on a word equal to DISK SYNC CODE, located in address (3F)*2.
		09	MSBSYNC	Enables disk read synchronizing on the MSB (most significant bit). Appl type GCR.
		08	FAST	Disk data clock rate control 1=fast(2us) 0=slow(4us). (fast for MFM, slow for MFM or GCR)
		07	USE3PN	Use audio channel 3 to modulate nothing.
		06	USE2P3	Use audio channel 2 to modulate period of channel 3.
		05	USE1P2	Use audio channel 1 to modulate period of channel 2.
		04	USE0P1	Use audio channel 0 to modulate period of channel 1.
		03	USE3VN	Use audio channel 3 to modulate nothing.
		02	USE2V3	Use audio channel 2 to modulate volume of channel 3.
		01	USE1V2	Use audio channel 1 to modulate volume of channel 2.
		00	USE0V1	Use audio channel 0 to modulate volume of channel 1.
<p>NOTE: If both period and volume are modulated on the same channel, the period and volume will be alternated. First word xxxxxxxx V6-V0 , Second word P15-P0 (etc)</p>				
AUDxDAT	0AA	W	P	Audio channel x data
<p>This register is the audio channel x (x=0,1,2,3) DMA data buffer. It contains 2 bytes of data that are each 2's complement and are outputted sequentially (with digital-to-analog conversion) to the audio output pins. (LSB = 3 MV) The DMA controller automatically transfers data to this register from RAM. The processor can also write directly to this register. When the DMA data is finished (words outputted=length) and the data in this register has been used, an audio channel interrupt request is set.</p>				

AUDxLCH 0A0 W A(E) Audio channel x location (high 3 bits,5 bits if ECS)  
 AUDxLCL 0A2 W A Audio channel x location (low 15 bits)

This pair of registers contains the 18 bit starting address (location) of audio channel x (x=0,1,2,3) DMA data. This is not a pointer register and therefore needs to be reloaded only if a different memory location is to be outputted.

AUDxLEN 0A4 W P Audio channel x length

This register contains the length (number of words) of audio channel x DMA data.

AUDxPER 0A6 W P(E) Audio channel x Period

This register contains the period (rate) of audio channel x DMA data transfer. The minimum period is 124 color clocks. This means that the smallest number that should be placed in this register is 124 decimal. This corresponds to a maximum sample frequency of 28.86 khz.

AUDxVOL 0A8 W P Audio channel x volume

This register contains the volume setting for audio channel x. Bits 6,5,4,3,2,1,0 specify 65 linear volume levels as shown below.

Bit#	Use
15-07	Not used
06	Forces volume to max (64 ones, no zeros)
05-00	Sets one of 64 levels (000000=no output (111111=63 1s, one 0)

BEAMCON0 1DC W A(E) Beam counter control register (SHRES,PAL)

BLTAFWM 044 W A Blitter first-word mask for source A

BLTALWM 046 W A Blitter last-word mask for source A

The patterns in these two registers are ANDed with the first and last words of each line of data from source A into the blitter. A zero in any bit overrides data from source A. These registers should be set to all 1s for fill mode or for line-drawing mode.



```

BLTCON0  040  W   A       Blitter control register 0
BLTCON1  042  W   A(E)    Blitter control register 1

```

These two control registers are used together to control blitter operations. There are two basic modes, area and line, which are selected by bit 0 of BLTCON1, as shown below.

AREA MODE ("normal")

BIT#	BLTCON0	BLTCON1
15	ASH3	BSH3
14	ASH2	BSH2
13	ASH1	BSH1
12	ASA0	BSM0
11	USEA	X
10	USEB	X
09	USEC	X
08	USED	X
07	LF7	DOFF
06	LF6	X
05	LF5	X
04	LF4	EFE
03	LF3	IFE
02	LF2	FCI
01	LF1	DESC
00	LF0	LINE(=0)

ASH3-0 Shift value of A source  
BSH3-0 Shift value of B source  
USEA Mode control bit to use source A  
USEB Mode control bit to use source B  
USEC Mode control bit to use source C  
USED Mode control bit to use destination D  
LF7-0 Logic function minterm select lines  
EFE Exclusive fill enable  
IFE Inclusive fill enable  
FCI Fill carry input  
DESC Descending (decreasing address) control bit  
LINE Line mode control bit (set to 0)

```

BLTCON0 (cont.) LINE DRAW
BLTCON1 (cont.) LINE DRAW
LINE DRAW LINE MODE (line draw)
LINE DRAW -----
LINE DRAW BIT# BLTCON0 BLTCON1
LINE DRAW -----
LINE DRAW 15 START3 TEXTURE3
LINE DRAW 14 START2 TEXTURE2
LINE DRAW 13 START1 TEXTURE1
LINE DRAW 12 START0 TEXTURE0
LINE DRAW 11 1 0
LINE DRAW 10 0 0
LINE DRAW 09 1 0
LINE DRAW 08 1 0
LINE DRAW 07 LF7 0
LINE DRAW 06 LF6 SIGN
LINE DRAW 05 LF5 0 (Reserved)
LINE DRAW 04 LF4 SUD
LINE DRAW 03 LF3 SUL
LINE DRAW 02 LF2 AUL
LINE DRAW 01 LF1 SING
LINE DRAW 00 LF0 LINE (=1)
LINE DRAW
LINE DRAW START3-0 Starting point of line
LINE DRAW (0 thru 15 hex)
LINE DRAW
LINE DRAW LF7-0 Logic function minterm
LINE DRAW select lines should be preloaded
LINE DRAW with 4A to select the equation
LINE DRAW D=(AC+ABC). Since A contains a
LINE DRAW single bit true (8000), most bits
LINE DRAW will pass the C field unchanged
LINE DRAW (not A and C), but one bit will
LINE DRAW invert the C field and combine it
LINE DRAW with texture (A and B and not C).
LINE DRAW The A bit is automatically moved
LINE DRAW across the word by the hardware.
LINE DRAW
LINE DRAW LINE Line mode control bit (set to 1)
LINE DRAW SIGN Sign flag
LINE DRAW 0 Reserved for new mode
LINE DRAW SING Single bit per horizontal line for
LINE DRAW use with subsequent area fill
LINE DRAW SUD Sometimes up or down (=AUD*)
LINE DRAW SUL Sometimes up or left
LINE DRAW AUL Always up or left
LINE DRAW
LINE DRAW The 3 bits above select the octant
LINE DRAW for line drawing:
LINE DRAW
LINE DRAW OCT SUD SUL AUL
LINE DRAW --- --- --- ---
LINE DRAW 0 1 1 0
LINE DRAW 1 0 0 1
LINE DRAW 2 0 1 1
LINE DRAW 3 1 1 1
LINE DRAW 4 1 0 1
LINE DRAW 5 0 1 0
LINE DRAW 6 0 0 0
LINE DRAW 7 1 0 0
LINE DRAW
LINE DRAW The "B" source is used for
LINE DRAW texturing the drawn lines.

```

BLTCON0L 05A W A(E) Blitter control 0, lower 8 bits (minterms)  
 BLTDDAT --- - - - - Blitter destination data register

This register holds the data resulting from each word of blitter operation until it is sent to a RAM destination. This is a dummy address and cannot be read by the micro. The transfer is automatic during blitter operation.

BLTSIZE 058 W A Blitter start and size (window width, height)

This register contains the width and height of the blitter operation (in line mode, width must = 2, height = line length). Writing to this register will start the blitter, and should be done last, after all pointers and control registers have been initialized.

BIT# 15,14,13,12,11,10,09,08,07,06,05,04,03,02,01,00  
 -----  
 h9 h8 h7 h6 h5 h4 h3 h2 h1 h0, w5 w4 w3 w2 w1 w0

h=height=vertical lines (10 bits=1024 lines max)  
 w=width =horizontal pixels (6 bits=64 words=1024 pixels max)

LINE DRAW BLTSIZE controls the line length and starts  
 LINE DRAW the line draw when written to. The h field  
 LINE DRAW controls the line length (10 bits gives  
 LINE DRAW lines up to 1024 dots long). The w field  
 LINE DRAW must be set to 02 for all line drawing.

BLTSIZV 05C W A(E) Blitter V size (for 15 bit vertical size)  
 BLTSIZH 05E W A(E) Blitter H size and start (for 11 bit H size)

BLTxDAT 074 W A Blitter source x data register

This register holds source x (x=A,B,C) data for use by the blitter. It is normally loaded by the blitter DMA channel; however, it may also be preloaded by the microprocessor.

LINE DRAW BLTADAT is used as an index register  
 LINE DRAW and must be preloaded with 8000.  
 LINE DRAW BLTBDAT is used for texture; it must  
 LINE DRAW be preloaded with FF if no texture  
 LINE DRAW (solid line) is desired.

BLTxMOD 064 W A Blitter modulo x

This register contains the modulo for blitter source (x=A,B,C) or destination (x=D). A modulo is a number that is automatically added to the address at the end of each line, to make the address point to the start of the next line. Each source or destination has its own modulo, allowing each to be a different size, while an identical area of each is used in the blitter operation.

LINE DRAW BLTAMOD and BLTBMOD are used as slope  
LINE DRAW storage registers and must be preloaded  
LINE DRAW with the values (4Y-4X) and (4Y)  
LINE DRAW respectively. Y/X= line slope.  
LINE DRAW BLTCMOD and BLTDMOD must both be  
LINE DRAW preloaded with the width (in bytes)  
LINE DRAW of the image into which the line is  
LINE DRAW being drawn (normally two times the  
LINE DRAW screen width in words).

BLTxPTH 050 W A(E) Blitter pointer to x (high 3 bits, 5 bits if ECS)

BLTxPTL 052 W A Blitter pointer to x (low 15 bits)

This pair of registers contains the 18-bit address of blitter source (x=A,B,C) or destination (x=D) DMA data. This pointer must be preloaded with the starting address of the data to be processed by the blitter. After the blitter is finished, it will contain the last data address (plus increment and modulo).

LINE DRAW BLTAPTL is used as an accumulator  
LINE DRAW register and must be preloaded with  
LINE DRAW the starting value of (2Y-X) where  
LINE DRAW Y/X is the line slope. BLTCPT and  
LINE DRAW BLTDPT (both H and L) must be  
LINE DRAW preloaded with the starting address  
LINE DRAW of the line.

BPL1MOD 108 W A Bitplane modulo (odd planes)

BPL2MOD 10A W A Bitplane modulo (even planes)

These registers contain the modulos for the odd and even bitplanes. A modulo is a number that is automatically added to the address at the end of each line, so that the address then points to the start of the next line. Since they have separate modulos, the odd and even bitplanes may have sizes that are different from each other, as well as different from the display window size.

BPLCON0	100	W	A D(E)	Bitplane control register (misc. control bits)
BPLCON1	102	W	D	Bitplane control register (horizontal scroll control)
BPLCON2	104	W	D(E)	Bitplane control register (video priority control)

These registers control the operation of the bitplanes and various aspects of the display.

BIT#	BPLCON0	BPLCON1	BPLCON2
15	HIRES	X	X
14	BPU2	X	X
13	BPU1	X	X
12	BPU0	X	X
11	HOMOD	X	X
10	DBLPF	X	X
09	COLOR	X	X
08	GAUD	X	X
07	X	PF2H3	X
06	X	PF2H2	PF2PRI
05	X	PF2H1	PF2P2
04	X	PF2H0	PF2P1
03	LPEN	PF1H3	PF2P0
02	LACE	PF1H2	PF1P2
01	ERSY	PF1H1	PF1P1
00	X	PF1H0	PF1P0

HIRES=High-resolution (70 ns pixels)  
 BPU =Bitplane use code 000-110 (NONE through 6 inclusive)  
 HOMOD=Hold-and-modify mode(1 = Hold-and-modify mode)  
 (0 = Extra Half Brite(EHB) mode,only if 6 bitplanes specified)  
 DBLPF=Double playfield (PF1=odd PF2=even bitplanes)  
 COLOR=Composite video COLOR enable  
 GAUD=Genlock audio enable (muxed on BKGND pin during vertical blanking)  
 LPEN =Light pen enable (reset on power up)  
 LACE =Interlace enable (reset on power up)  
 ERSY =External resync (HSYNC, VSYNC pads become inputs) (reset on power up)  
 PF2PRI=Playfield 2 (even planes) has priority over (appears in front of) playfield 1 (odd planes).  
 PF2P=Playfield 2 priority code (with respect to sprites)  
 PF1P=Playfield 1 priority code (with respect to sprites)  
 PF2H=Playfield 2 horizontal scroll code  
 PF1H=Playfield 1 horizontal scroll code

BPLCON3	106	W	D(E)	Bitplane control (enhanced features)
---------	-----	---	------	--------------------------------------

BPLxDAT      110   W      D      Bitplane x data (parallel-to-serial convert)

These registers receive the DMA data fetched from RAM by the bitplane address pointers described above. They may also be written by either microprocessor. They act as a six-word parallel-to-serial buffer for up to six memory bitplanes (x=1-6). The parallel-to-serial conversion is triggered whenever bitplane #1 is written, indicating the completion of all bitplanes for that word (16 pixels). The MSB is output first, and is, therefore, always on the left.

BPLxPTH      OE0   W      A      Bitplane x pointer (high 3 bits)  
 BPLxPTL      OE2   W      A      Bitplane x pointer (low 15 bits)

This pair of registers contains the 18-bit pointer to the address of bitplane x (x=1,2,3,4,5,6) DMA data. This pointer must be reinitialized by the processor or copper to point to the beginning of bitplane data every vertical blank time.

CLXCON      098   W      D      Collision control

This register controls which bitplanes are included (enabled) in collision detection and their required state if included. It also controls the individual inclusion of odd-numbered sprites in the collision detection by logically OR-ing them with their corresponding even-numbered sprite.

BIT#	FUNCTION	DESCRIPTION
15	ENSP7	Enable sprite 7 (ORed with sprite 6)
14	ENSP5	Enable sprite 5 (ORed with sprite 4)
13	ENSP3	Enable sprite 3 (ORed with sprite 2)
12	ENSP1	Enable sprite 1 (ORed with sprite 0)
11	ENBP6	Enable bitplane 6 (match required for collision)
10	ENBP5	Enable bitplane 5 (match required for collision)
09	ENBP4	Enable bitplane 4 (match required for collision)
08	ENBP3	Enable bitplane 3 (match required for collision)
07	ENBP2	Enable bitplane 2 (match required for collision)
06	ENBP1	Enable bitplane 1 (match required for collision)
05	MVBP6	Match value for bitplane 6 collision
04	MVBP5	Match value for bitplane 5 collision
03	MVBP4	Match value for bitplane 4 collision
02	MVBP3	Match value for bitplane 3 collision
01	MVBP2	Match value for bitplane 2 collision
00	MVBP1	Match value for bitplane 1 collision

NOTE: Disabled bitplanes cannot prevent collisions. Therefore if all bitplanes are disabled, collisions will be continuous, regardless of the match values.

CLXDAT 00E R D Collision data register (read and clear)

This address reads (and clears) the collision detection register. The bit assignments are below.

NOTE: Playfield 1 is all odd-numbered enabled bitplanes. Playfield 2 is all even-numbered enabled bitplanes

BIT#	COLLISIONS REGISTERED
15	not used
14	Sprite 4 (or 5) to sprite 6 (or 7)
13	Sprite 2 (or 3) to sprite 6 (or 7)
12	Sprite 2 (or 3) to sprite 4 (or 5)
11	Sprite 0 (or 1) to sprite 6 (or 7)
10	Sprite 0 (or 1) to sprite 4 (or 5)
09	Sprite 0 (or 1) to sprite 2 (or 3)
08	Playfield 2 to sprite 6 (or 7)
07	Playfield 2 to sprite 4 (or 5)
06	Playfield 2 to sprite 2 (or 3)
05	Playfield 2 to sprite 0 (or 1)
04	Playfield 1 to sprite 6 (or 7)
03	Playfield 1 to sprite 4 (or 5)
02	Playfield 1 to sprite 2 (or 3)
01	Playfield 1 to sprite 0 (or 1)
00	Playfield 1 to playfield 2

COLORxx 180 W D Color table xx

There are 32 of these registers (xx=00-31) and they are sometimes collectively called the "color palette." They contain 12-bit codes representing red, green, and blue colors for RGB systems. One of these registers at a time is selected (by the BPLxDAT serialized video code) for presentation at the RGB video output pins. The table below shows the color register bit usage.

BIT#	15,14,13,12,11,10,09,08,07,06,05,04,03,02,01,00
RGB	X X X X R3 R2 R1 R0 G3 G2 G1 G0 B3 B2 B1 B0

B=blue, G=green, R=red,

COP1LCH	080	W	A(E)	Copper first location register (high 3 bits, high 5 bits if ECS)
COP1LCL	082	W	A	Copper first location register (low 15 bits)
COP2LCH	084	W	A(E)	Copper second location register (high 3 bits, high 5 bits if ECS)
COP2LCL	086	W	A	Copper second location register (low 15 bits)

These registers contain the jump addresses described above.

COPCON 02E W A(E) Copper control register

This is a 1-bit register that when set true, allows the Copper to access the blitter hardware. This bit is cleared by power-on reset, so that the Copper cannot access the blitter hardware. See Appendix C for ECS operation.

BIT#	NAME	FUNCTION
01	CDANG	Copper danger mode. Allows Copper access to blitter if true.

COPINS 08C W A Copper instruction fetch identify

This is a dummy address that is generated by the Copper whenever it is loading instructions into its own instruction register. This actually occurs every Copper cycle except for the second (IR2) cycle of the MOVE instruction. The three types of instructions are shown below.

MOVE	Move immediate to destination.
WAIT	Wait until beam counter is equal to, or greater than. (keeps Copper off of bus until beam position has been reached).
SKIP	Skip if beam counter is equal to or greater than (skips following MOVE instruction unless beam position has been reached).



COPINS (cont.)

BIT#	MOVE		WAIT UNTIL		SKIP IF	
	IR1	IR2	IR1	IR2	IR1	IR2
15	X	RD15	VP7	BFD *	VP7	BFD *
14	X	RD14	VP6	VE6	VP6	VE6
13	X	RD13	VP5	VE5	VP5	VE5
12	X	RD12	VP4	VE4	VP4	VE4
11	X	RD11	VP3	VE3	VP3	VE3
10	X	RD10	VP2	VE2	VP2	VE2
09	X	RD09	VP1	VE1	VP1	VE1
08	DA8	RD08	VP0	VE0	VP0	VE0
07	DA7	RD07	HP8	HE8	HP8	HE8
06	DA6	RD06	HP7	HE7	HP7	HE7
05	DA5	RD05	HP6	HE6	HP6	HE6
04	DA4	RD04	HP5	HE5	HP5	HE5
03	DA3	RD03	HP4	HE4	HP4	HE4
02	DA2	RD02	HP3	HE3	HP3	HE3
01	DA1	RD01	HP2	HE2	HP2	HE2
00	0	RD00	1	0	1	1

IR1=First instruction register

IR2=Second instruction register

DA =Destination address for MOVE instruction. Fetched during IR1 time, used during IR2 time on RGA bus.

RD =RAM data moved by MOVE instruction at IR2 time directly from RAM to the address given by the DA field.

VP =Vertical beam position comparison bit.

HP =Horizontal beam position comparison bit.

VE =Enable comparison (mask bit).

HE =Enable comparison (mask bit).

\* NOTE BFD=Blitter finished disable. When this bit is true, the Blitter Finished flag will have no effect on the Copper. When this bit is zero, the Blitter Finished flag must be true (in addition to the rest of the bit comparisons) before the Copper can exit from its wait state or skip over an instruction. Note that the V7 comparison cannot be masked.

The Copper is basically a two-cycle machine that requests the bus only during odd memory cycles (4 memory cycles per instruction). This prevents collisions with display, audio, disk, refresh, and sprites, all of which use only even cycles. It therefore needs (and has) priority over only the blitter and microprocessor.

There are only three types of instructions: MOVE immediate, WAIT until, and SKIP if. All instructions (except for WAIT) require two bus cycles (and two instruction words). Since only the odd bus cycles are requested, four memory cycle times are required per instruction (memory cycles are 280 ns.)

---

COPINS (cont.) There are two indirect jump registers, COP1LC and COP2LC. These are 18-bit pointer registers whose contents are used to modify the program counter for initialization or jumps. They are transferred to the program counter whenever strobe addresses COPJMP1 or COPJMP2 are written. In addition, COP1LC is automatically used at the beginning of each vertical blank time.

It is important that one of the jump registers be initialized and its jump strobe address hit after power-up but before Copper DMA is initialized. This insures a determined startup address and state.

COPJMP1	088	S	A	Copper restart at first location
COPJMP2	08A	S	A	Copper restart at second location

These addresses are strobe addresses. When written to, they cause the Copper to jump indirect using the address contained in the first or second location registers described below. The Copper itself can write to these addresses, causing its own jump indirect.

DDFSTOP 094 W A Display data fetch stop (horiz. position)  
 DDFSTRT 092 W A Display data fetch start (horiz. position)

These registers control the horizontal timing of the beginning and end of the bitplane DMA display data fetch. The vertical bitplane DMA timing is identical to the display windows described above. The bitplane modulus are dependent on the bitplane horizontal size and on this data-fetch window size.

Register bit assignment

-----  
 BIT# 15,14,13,12,11,10,09,08,07,06,05,04,03,02,01,00  
 -----  
 USE X X X X X X X X H8 H7 H6 H5 H4 H3 X X

(Always set X bits to 0 to maintain upward compatibility)

The tables below show the start and stop timing for different register contents.

DDFSTRT (left edge of display data fetch)

PURPOSE	H8,H7,H6,H5,H4
Extra wide (max) *	0 0 1 0 1
Wide	0 0 1 1 0
Normal	0 0 1 1 1
Narrow	0 1 0 0 0

DDFSTOP (right edge of display data fetch)

PURPOSE	H8,H7,H6,H5,H4
Narrow	1 1 0 0 1
Normal	1 1 0 1 0
Wide (max)	1 1 0 1 1

DENISEID 07C R D(E) Chip revision level for Denise (video out chip)  
 DIWHIGH 1E4 W A,D(E) Display window - upper bits for start, stop  
 DIWSTOP 090 W A Display window stop (lower right vertical-horizontal position)  
 DIWSTRT 08E W A Display window start (upper left vertical-horizontal position)

These registers control display window size and position by locating the upper left and lower right corners.

-----  
 BIT# 15,14,13,12,11,10,09,08,07,06,05,04,03,02,01,00  
 -----  
 USE V7 V6 V5 V4 V3 V2 V1 V0 H7 H6 H5 H4 H3 H2 H1 H0

DIWSTRT is vertically restricted to the upper 2/3 of the display (V8=0) and horizontally restricted to the left 3/4 of the display (H8=0).

DIWSTOP is vertically restricted to the lower 1/2 of the display (V8=/=V7) and horizontally restricted to the right 1/4 of the display (H8=1).

DMACON 096 W A D P DMA control write (clear or set)  
 DMACONR 002 R A P DMA control (and blitter status) read

This register controls all of the DMA channels and contains blitter DMA status bits.

BIT#	FUNCTION	DESCRIPTION
15	SET/CLR	Set/clear control bit. Determines if bits written with a 1 get set or cleared. Bits written with a zero are unchanged.
14	BBUSY	Blitter busy status bit (read only)
13	BZERO	Blitter logic zero status bit (read only).
12	X	
11	X	
10	BLTPRI	Blitter DMA priority (over CPU micro) (also called "blitter nasty") (disables /BLS pin, preventing micro from stealing any bus cycles while blitter DMA is running).
09	DMAEN	Enable all DMA below
08	BPLEN	Bitplane DMA enable
07	COPEN	Copper DMA enable
06	BLTEN	Blitter DMA enable
05	SPREN	Sprite DMA enable
04	DSKEN	Disk DMA enable
03	AUD3EN	Audio channel 3 DMA enable
02	AUD2EN	Audio channel 2 DMA enable
01	AUD1EN	Audio channel 1 DMA enable
00	AUDOEN	Audio channel 0 DMA enable

DSKBYTR 01A R P Disk data byte and status read

This register is the disk-microprocessor data buffer. Data from the disk (in read mode) is loaded into this register one byte at a time, and bit 15 (DSKBYT) is set true.

BIT#	FUNCTION	DESCRIPTION
15	DSKBYT	Disk byte ready (reset on read)
14	DMAON	Mirror of bit 15 (DMAEN) in DSKLEN, ANDed with Bit09 (DMAEN) in DMACON
13	DISKWRITE	Mirror of bit 14 (WRITE) in DSKLEN
12	WORDEQUAL	This bit true only while the DSKSYNC register equals the data from disk.
11-08	X	Not used
07-00	DATA	Disk byte data

DSKDAT 026 P Disk DMA data write  
 DSKDATR 008 ER P Disk DMA data read (early read dummy  
 address)

This register is the disk DMA data buffer. It contains two bytes of data that are either sent (written) to or received (read) from the disk. The write mode is enabled by bit 14 of the LENGTH register. The DMA controller automatically transfers data to or from this register and RAM, and when the DMA data is finished (length=0) it causes a disk block interrupt. See interrupts below.

DSKLEN 024 W P Disk length

This register contains the length (number of words) of disk DMA data. It also contains two control bits, a DMA enable bit, and a DMA direction (read/write) bit.

BIT#	FUNCTION	DESCRIPTION
15	DMAEN	Disk DMA enable
14	WRITE	Disk write (RAM to disk) if 1
13-0	LENGTH	Length (# of words) of DMA data.

DSKPTH 020 W A(E) Disk pointer (high 3 bits, high 5 bits if ECS)  
 DSKPTL 022 W A Disk pointer (low 15 bits)

This pair of registers contains the 18-bit address of disk DMA data. These address registers must be initialized by the processor or Copper before disk DMA is enabled.

DSKSYNC 07E W P Disk sync register

holds the match code for disk read synchronization. See ADKCON bit 10.

HBSTOP	1C6	W	A(E)	Horizontal line position for HBLANK stop
HBSTRT	1C4	W	A(E)	Horizontal line position for HBLANK start
HCENTER	1E2	W	A(E)	Horizontal position for Vsync on interlace
HSSTOP	1C2	W	A(E)	Horizontal line position for HSYNC stop
HSSTRT	1DE	W	A(E)	Horizontal sync start (VARHSY)
HTOTAL	1C0	W	A(E)	Highest number count, horiz. line (VARBEAMEN=1)
INTENA	09A	W	P	Interrupt enable bits (clear or set bits)
INTENAR	01C	R	P	Interrupt enable bits (read)

This register contains interrupt enable bits. The bit assignment for both the request and enable registers is given below.

BIT#	FUNCT	LEVEL	DESCRIPTION
15	SET/CLR		Set/clear control bit. Determines if bits written with a 1 get set or cleared. Bits written with a zero are always unchanged.
14	INTEN		Master interrupt (enable only, no request)
13	EXTER	6	External interrupt
12	DSKSYN	5	Disk sync register (DSKSYNC) matches disk data
11	RBF	5	Serial port receive buffer full
10	AUD3	4	Audio channel 3 block finished
09	AUD2	4	Audio channel 2 block finished
08	AUD1	4	Audio channel 1 block finished
07	AUD0	4	Audio channel 0 block finished
06	BLIT	3	Blitter finished
05	VERTB	3	Start of vertical blank
04	COPER	3	Copper
03	PORTS	2	I/O ports and timers
02	SOFT	1	Reserved for software-initiated interrupt
01	DSKBLK	1	Disk block finished
00	TBE	1	Serial port transmit buffer empty

INTREQ	09C	W	P	Interrupt request bits (clear or set)
INTREQR	01E	R	P	Interrupt request bits (read)

This register contains interrupt request bits (or flags). These bits may be polled by the processor; if enabled by the bits listed in the next register, they may cause processor interrupts. Both a set and clear operation are required to load arbitrary data into this register. These status bits are not automatically reset when the interrupt is serviced, and must be reset when desired by writing to this address. The bit assignments are identical to the enable register below.

```

JOY0DAT    00A  R    D    Joystick-mouse 0 data (left vertical,
                                horizontal)
JOY1DAT    00C  R    D    Joystick-mouse 1 data (right vertical,
                                horizontal)

```

These addresses each read a pair of 8-bit mouse counters. 0=left controller pair, 1=right controller pair (four counters total). The bit usage for both left and right addresses is shown below. Each counter is clocked by signals from two controller pins. Bits 1 and 0 of each counter may be read to determine the state of these two clock pins. This allows these pins to double as joystick switch inputs.

Mouse counter usage:  
(pins 1,3=Yclock, pins 2,4=Xclock)

```

BIT# 15,14,13,12,11,10,09,08  07,06,05,04,03,02,01,00
-----
ODAT Y7 Y6 Y5 Y4 Y3 Y2 Y1 Y0  X7 X6 X5 X4 X3 X2 X1 X0
1DAT Y7 Y6 Y5 Y4 Y3 Y2 Y1 Y0  X7 X6 X5 X4 X3 X2 X1 X0

```

The following table shows the mouse/joystick connector pin usage. The pins (and their functions) are sampled (multiplexed) into the DENISE chip during the clock times shown in the table. This table is for reference only and should not be needed by the programmer. (Note that the joystick functions are all "active low" at the connector pins.)

Conn Pin	Joystick Function	Mouse Function	Sampled by DENISE	
			Pin	Name Clock
L1	FORW*	Y	38	M0V at CCK
L3	LEFT*	YQ	38	M0V at CCK*
L2	BACK*	X	9	M0H at CCK
L4	RIGH*	XQ	9	M0H at CCK*
R1	FORW*	Y	39	M1V at CCK
R3	LEFT*	YQ	39	M1V at CCK*
R2	BACK*	X	8	M1H at CCK
R4	RIGH*	XQ	8	M1H at CCK*

After being sampled, these connector pin signals are used in quadrature to clock the mouse counters. The LEFT and RIGHT joystick functions (active high) are directly available on the Y1 and X1 bits of each counter. In order to recreate the FORWARD and BACK joystick functions, however, it is necessary to logically combine (exclusive OR) the lower two bits of each counter. This is illustrated in the following table.

To detect	Read these counter bits
Forward	Y1 xor Y0 (BIT#09 xor BIT#08)
Left	Y1
Back	X1 xor X0 (BIT#01 xor BIT#00)
Right	X1

JOYTEST 036 W D Write to all four joystick-mouse counters at once.

Mouse counter write test data:

```

BIT# 15,14,13,12,11,10,09,08 07,06,05,04,03,02,01,00
-----
ODAT Y7 Y6 Y5 Y4 Y3 Y2 xx xx X7 X6 X5 X4 X3 X2 xx xx
1DAT Y7 Y6 Y5 Y4 Y3 Y2 xx xx X7 X6 X5 X4 X3 X2 xx xx

```

POTODAT 012 R P(E) Pot counter data left pair (vert,horiz.)  
POT1DAT 014 R P(E) Pot counter data right pair (vert,horiz.)

These addresses each read a pair of 8-bit pot counters. (Four counters total.) The bit assignment for both addresses is shown below. The counters are stopped by signals from two controller connectors (left-right) with two pins each.

```

BIT# 15,14,13,12,11,10,09,08 07,06,05,04,03,02,01,00
-----
RIGHT Y7 Y6 Y5 Y4 Y3 Y2 Y1 Y0 X7 X6 X5 X4 X3 X2 X1 X0
LEFT Y7 Y6 Y5 Y4 Y3 Y2 Y1 Y0 X7 X6 X5 X4 X3 X2 X1 X0

```

CONNECTORS				PAULA	
Loc.	Dir.	Sym	Pin	Pin#	Pin Name
RIGHT	Y	RY	9	36	(POT1Y)
RIGHT	X	RX	5	35	(POT1X)
LEFT	Y	LY	9	33	(POT0Y)
LEFT	X	LX	5	32	(POT0X)

POTGO 034 W P Pot port data write and start.

POTGOR 016 R P Pot port data read (formerly called POTINP).

This register controls a 4-bit bi-directional I/O port that shares the same four pins as the four pot counters above.

```

BIT# FUNCT DESCRIPTION
-----
15 OUTRY Output enable for Paula pin 36
14 DATRY I/O data Paula pin 36
13 OUTRX Output enable for Paula pin 35
12 DATRX I/O data Paula pin 35
11 OUTLY Output enable for Paula pin 33
10 DATLY I/O data Paula pin 33
09 OUTLX Output enable for Paula pin 32
08 DATLX I/O data Paula pin 32
07-01 0 Reserved for chip ID code (presently 0)
00 START Start pots (dump capacitors, start counters)

```

REFPTR 028 W A Refresh pointer

This register is used as a dynamic RAM refresh address generator. It is writeable for test purposes only, and should never be written by the microprocessor.



SERDAT 030 W P Serial port data and stop bits write  
(transmit data buffer)

This address writes data to a transmit data buffer. Data from this buffer is moved into a serial shift register for output transmission whenever it is empty. This sets the interrupt request TBE (transmit buffer empty). A stop bit must be provided as part of the data word. The length of the data word is set by the position of the stop bit.

BIT# 15,14,13,12,11,10,09,08,07,06,05,04,03,02,01,00

USE 0 0 0 0 0 0 S D8 D7 D6 D5 D4 D3 D2 D1 D0

Note: S = stop bit = 1, D = data bits.

SERDATR 018 R P Serial port data and status read  
(receive data buffer)

This address reads data from a receive data buffer. Data in this buffer is loaded from a receiving shift register whenever it is full. Several interrupt request bits are also read at this address, along with the data, as shown below.

BIT#	SYM	FUNCTION
15	OVRUN	Serial port receiver overrun. Reset by resetting bit 11 of INTREQ.
14	RBF	Serial port receive buffer full (mirror).
13	TBE	Serial port transmit buffer empty (mirror).
12	TSRE	Serial port transmit shift register empty. Reset by loading into buffer.
11	RXD	RXD pin receives UART serial data for direct bit test by the microprocessor.
10	0	Not used
09	STP	Stop bit
08	STP-DB8	Stop bit if LONG, data bit if not.
07	DB7	Data bit
06	DB6	Data bit
05	DB5	Data bit
04	DB4	Data bit
03	DB3	Data bit
02	DB2	Data bit
01	DB1	Data bit
00	DB0	Data bit

SERPER 032 W P Serial port period and control

This register contains the control bit LONG referred to above, and a 15-bit number defining the serial port baud rate. If this number is N, then the baud rate is 1 bit every  $(N+1) \cdot 2794$  microseconds.

BIT#	SYM	FUNCTION
15	LONG	Defines serial receive as 9-bit word.
14-00	RATE	Defines baud rate= $1/((N+1) \cdot 2794 \text{ microsec.})$

SPRxCTL 142 W A D(E) Sprite x vert stop position and control data  
SPRxPOS 140 W A D Sprite x vert-horiz start position data

These two registers work together as position, size and feature sprite-control registers. They are usually loaded by the sprite DMA channel during horizontal blank; however, they may be loaded by either processor at any time. SPRxPOS register:

BIT#	SYM	FUNCTION
15-08	SV7-SV0	Start vertical value. High bit (SV8) is in SPRxCTL register below.
07-00	SH8-SH1	Start horizontal value. Low bit (SH0) is in SPRxCTL register below.

SPRxCTL register (writing this address disables sprite horizontal comparator circuit):

BIT#	SYM	FUNCTION
15-08	EV7-EV0	End (stop) vertical value low 8 bits
07	ATT	Sprite attach control bit (odd sprites)
06-04	X	Not used
02	SV8	Start vertical value high bit
01	EV8	End (stop) vertical value high bit
00	SH0	Start horizontal value low bit

SPRxDATA 144 W D Sprite x image data register A  
SPRxDATB 146 W D Sprite x image data register B

These registers buffer the sprite image data. They are usually loaded by the sprite DMA channel but may be loaded by either processor at any time. When a horizontal comparison occurs, the buffers are dumped into shift registers and serially outputted to the display, MSB first on the left.

NOTE: Writing to the A buffer enables (arms) the sprite. Writing to the SPRxCTL register disables the sprite. If enabled, data in the A and B buffers will be outputted whenever the beam counter equals the sprite horizontal position value in the SPRxPOS register.

SPRxPOS see SPRxCTL

SPRxPTH	120	W	A	Sprite x pointer (high 3 bits)
SPRxPTL	122	W	A	Sprite x pointer (low 15 bits)

This pair of registers contains the 18-bit address of sprite x (x=0,1,2,3,4,5,6,7) DMA data. These address registers must be initialized by the processor or Copper every vertical blank time.

STREQU	038	S	D	Strobe for horizontal sync with VB and EQU
STRHOR	03C	S	D P	Strobe for horizontal sync
STRLONG	03E	S	D(E)	Strobe for identification of long horizontal line

One of the first three strobe addresses above is placed on the destination address bus during the first refresh time slot. The fourth strobe shown above is used during the second refresh time slot of every other line to identify lines with long counts (228). There are four refresh time slots, and any not used for strobes will leave a null (FF) address on the destination address bus.

STRVBL	03A	S	D	Strobe for horizontal sync with VB (vertical blank)
VBSTOP	1CE	W	A(E)	Vertical line for VBLANK stop
VBSTRT	1CC	W	A(E)	Vertical line for VBLANK start
VHPOSR	006	R	A	Read vertical and horizontal position of beam or lightpen
VHPOSW	02C	W	A	Write vertical and horizontal position of beam or lightpen

BIT# 15,14,13,12,11,10,09,08,07,06,05,04,03,02,01,00  
 -----  
 USE V7 V6 V5 V4 V3 V2 V1 V0,H8 H7 H6 H5 H4 H3 H2 H1

RESOLUTION = 1/160 of screen width (280 ns)

VPOSR	004	R	A(E)	Read vertical most significant bit (and frame flop)
VPOSW	02A	W	A	Write vertical most significant bit (and frame flop)

BIT# 15,14,13,12,11,10,09,08,07,06,05,04,03,02,01,00  
 -----  
 USE LOF-- -- -- -- -- -- -- -- -- -- -- -- -- -- -- V8

LOF=Long frame (auto toggle control bit in BPLCON0)

VSSTOP	1CA	W	A(E)	Vertical line position for VSYNC stop
VSSTRT	1E0	W	A(E)	Vertical sync start (VARVSY)
VTOTAL	1C8	W	A(E)	Highest numbered vertical line (VARBEAMEN=1)



---

# appendix B

## REGISTER SUMMARY

## ADDRESS ORDER

This appendix contains information about the register set in address order.

The following codes and abbreviations are used in this appendix:

- & Register used by DMA channel only.
- % Register used by DMA channel usually, processors sometimes.
- + Address register pair. Must be an even address pointing to chip memory.
- \* Address not writable by the Copper.
- ~ Address not writable by the Copper unless the "copper danger bit", COPCON is set true.

A,D,P

A=Agnus chip, D=Denise chip, P=Paula chip.

W,R

W=write-only; R=read-only,

ER Early read. This is a DMA data transfer to RAM, from either the disk or the blitter. RAM timing requires data to be on the bus earlier than microprocessor read cycles. These transfers are therefore initiated by Agnus timing, rather than a read address on the destination address bus.

S Strobe (write address with no register bits). Writing the register causes the effect.

---

#### PTL,PTH

Chip memory pointer that addresses DMA data. Must be reloaded by a processor before use (vertical blank for bitplane and sprite pointers, and prior to starting the blitter for blitter pointers).

#### LCL,LCH

Chip memory location (starting address) of DMA data. Used to automatically restart pointers, such as the Copper program counter (during vertical blank) and the audio sample counter (whenever the audio length count is finished).

#### MOD

15-bit modulo. A number that is automatically added to the memory address at the end of each line to generate the address for the beginning of the next line. This allows the blitter (or the display window) to operate on (or display) a window of data that is smaller than the actual picture in memory (memory map). Uses 15 bits, plus sign extend.

*About the ECS registers.* Registers denoted with an "(E)" in the chip column means that those registers have been changed in the Enhanced Chip Set (ECS). The ECS is found in the A3000, and is installable in the A500 and A2000. Certain ECS registers are completely new, others have been extended in their functionality. See the register map in Appendix C for information on which ECS registers are new and which have been modified.

NAME	ADD	R/W	CHIP	FUNCTION
BLTDDAT	& *000	ER	A	Blitter destination early read (dummy address)
DMACONR	*002	R	A P	DMA control (and blitter status) read
VPOSR	*004	R	A(E)	Read vert most signif. bit (and frame flop)
VHPOSR	*006	R	A	Read vert and horiz. position of beam
DSKDATR	& *008	ER	P	Disk data early read (dummy address)
JOYODAT	*00A	R	D	Joystick-mouse 0 data (vert,horiz)
JOY1DAT	*00C	R	D	Joystick-mouse 1 data (vert,horiz)
CLXDAT	*00E	R	D	Collision data register (read and clear)
ADKCONR	*010	R	P	Audio, disk control register read
POTODAT	*012	R	P(E)	Pot counter pair 0 data (vert,horiz)
POT1DAT	*014	R	P(E)	Pot counter pair 1 data (vert,horiz)
POTGOR	*016	R	P	Pot port data read (formerly POTINP)
SERDATR	*018	R	P	Serial port data and status read
DSKBYTR	*01A	R	P	Disk data byte and status read
INTENAR	*01C	R	P	Interrupt enable bits read
INTREQR	*01E	R	P	Interrupt request bits read
DSKPTH	+ *020	W	A(E)	Disk pointer (high 3 bits, 5 bits if ECS)
DSKPTL	+ *022	W	A	Disk pointer (low 15 bits)
DSKLEN	*024	W	P	Disk length
DSKDAT	& *026	W	P	Disk DMA data write
REFPTR	& *028	W	A	Refresh pointer
VPOSW	*02A	W	A	Write vert most signif. bit (and frame flop)
VHPOSW	*02C	W	A	Write vert and horiz position of beam
COPCON	*02E	W	A(E)	Coprocessor control register (CDANG)
SERDAT	*030	W	P	Serial port data and stop bits write
SERPER	*032	W	P	Serial port period and control
POTGO	*034	W	P	Pot port data write and start
JOYTEST	*036	W	D	Write to all four joystick-mouse counters at once
STREQU	& *038	S	D	Strobe for horiz sync with VB and EQU
STRVBL	& *03A	S	D	Strobe for horiz sync with VB (vert. blank)
STRHOR	& *03C	S	D P	Strobe for horiz sync
STRLONG	& *03E	S	D(E)	Strobe for identification of long horiz. line.
BLTCON0	~040	W	A	Blitter control register 0
BLTCON1	~042	W	A(E)	Blitter control register 1
BLTAFWM	~044	W	A	Blitter first word mask for source A
BLTALWM	~046	W	A	Blitter last word mask for source A
BLTCPTH	+ ~048	W	A	Blitter pointer to source C (high 3 bits)
BLTCPTL	+ ~04A	W	A	Blitter pointer to source C (low 15 bits)
BLTBPTH	+ ~04C	W	A	Blitter pointer to source B (high 3 bits)
BLTBPTL	+ ~04E	W	A	Blitter pointer to source B (low 15 bits)
BLTAPTH	+ ~050	W	A(E)	Blitter pointer to source A (high 3 bits)
BLTAPTL	+ ~052	W	A	Blitter pointer to source A (low 15 bits)
BLTDPTH	+ ~054	W	A	Blitter pointer to destination D (high 3 bits)
BLTDPTL	+ ~056	W	A	Blitter pointer to destination D (low 15 bits)
BLTSIZE	~058	W	A	Blitter start and size (window width, height)
BLTCON0L	~05A	W	A(E)	Blitter control 0, lower 8 bits (mintersms)
BLTSIZV	~05C	W	A(E)	Blitter V size (for 15 bit vertical size)
BLTSIZH	~05E	W	A(E)	Blitter H size and start (for 11 bit H size)
BLTCMOD	~060	W	A	Blitter modulo for source C
BLTBMOD	~062	W	A	Blitter modulo for source B
BLTAMOD	~064	W	A	Blitter modulo for source A
BLTDMOD	~066	W	A	Blitter modulo for destination D
	~068			
	~06A			
	~06C			
	~06E			
BLTCDAT	% ~070	W	A	Blitter source C data register
BLTBDAT	% ~072	W	A	Blitter source B data register

BLTADAT	%	~074	W	A	Blitter source A data register
		~076			
SPRHDAT		~078	W	A(E)	Ext. logic UHRES sprite pointer and data id
		~07A			
DENISEID		~07C	R	D(E)	Chip revision level for Denise (video out chip)
DSKSYNC		~07E	W	P	Disk sync pattern register for disk read
COP1LCH	+	080	W	A(E)	Coprocessor first location register (high 3 bits, high 5 bits if ECS)
COP1LCL	+	082	W	A	Coprocessor first location register (low 15 bits)
COP2LCH	+	084	W	A(E)	Coprocessor second location register (high 3 bits, high 5 bits if ECS)
COP2LCL	+	086	W	A	Coprocessor second location register (low 15 bits)
COPJMP1		088	S	A	Coprocessor restart at first location
COPJMP2		08A	S	A	Coprocessor restart at second location
COPINS		08C	W	A	Coprocessor instruction fetch identify
DIWSTRT		08E	W	A	Display window start (upper left vert-horiz position)
DIWSTOP		090	W	A	Display window stop (lower right vert.-horiz. position)
DDFSTRT		092	W	A	Display bitplane data fetch start (horiz. position)
DDFSTOP		094	W	A	Display bitplane data fetch stop (horiz. position)
DMACON		096	W	A D P	DMA control write (clear or set)
CLXCON		098	W	D	Collision control
INTENA		09A	W	P	Interrupt enable bits (clear or set bits)
INTREQ		09C	W	P	Interrupt request bits (clear or set bits)
ADKCON		09E	W	P	Audio, disk, UART control
AUD0LCH	+	0A0	W	A(E)	Audio channel 0 location (high 3 bits, 5 if ECS)
AUD0LCL	+	0A2	W	A	Audio channel 0 location (low 15 bits)
AUD0LEN		0A4	W	P	Audio channel 0 length
AUD0PER		0A6	W	P(E)	Audio channel 0 period
AUD0VOL		0A8	W	P	Audio channel 0 volume
AUD0DAT	&	0AA	W	P	Audio channel 0 data
		0AC			
		0AE			
AUD1LCH	+	0B0	W	A	Audio channel 1 location (high 3 bits)
AUD1LCL	+	0B2	W	A	Audio channel 1 location (low 15 bits)
AUD1LEN		0B4	W	P	Audio channel 1 length
AUD1PER		0B6	W	P	Audio channel 1 period
AUD1VOL		0B8	W	P	Audio channel 1 volume
AUD1DAT	&	0BA	W	P	Audio channel 1 data
		0BC			
		0BE			
AUD2LCH	+	0C0	W	A	Audio channel 2 location (high 3 bits)
AUD2LCL	+	0C2	W	A	Audio channel 2 location (low 15 bits)
AUD2LEN		0C4	W	P	Audio channel 2 length
AUD2PER		0C6	W	P	Audio channel 2 period
AUD2VOL		0C8	W	P	Audio channel 2 volume
AUD2DAT	&	0CA	W	P	Audio channel 2 data
		0CC			
		0CE			
AUD3LCH	+	0D0	W	A	Audio channel 3 location (high 3 bits)
AUD3LCL	+	0D2	W	A	Audio channel 3 location (low 15 bits)
AUD3LEN		0D4	W	P	Audio channel 3 length
AUD3PER		0D6	W	P	Audio channel 3 period



AUD3VOL		OD8	W	P	Audio channel 3 volume
AUD3DAT	&	ODA	W	P	Audio channel 3 data
		ODC			
		ODE			
BPL1PTH	+	OE0	W	A	Bitplane 1 pointer (high 3 bits)
BPL1PTL	+	OE2	W	A	Bitplane 1 pointer (low 15 bits)
BPL2PTH	+	OE4	W	A	Bitplane 2 pointer (high 3 bits)
BPL2PTL	+	OE6	W	A	Bitplane 2 pointer (low 15 bits)
BPL3PTH	+	OE8	W	A	Bitplane 3 pointer (high 3 bits)
BPL3PTL	+	OEA	W	A	Bitplane 3 pointer (low 15 bits)
BPL4PTH	+	OEC	W	A	Bitplane 4 pointer (high 3 bits)
BPL4PTL	+	OEE	W	A	Bitplane 4 pointer (low 15 bits)
BPL5PTH	+	OF0	W	A	Bitplane 5 pointer (high 3 bits)
BPL5PTL	+	OF2	W	A	Bitplane 5 pointer (low 15 bits)
BPL6PTH	+	OF4	W	A	Bitplane 6 pointer (high 3 bits)
BPL6PTL	+	OF6	W	A	Bitplane 6 pointer (low 15 bits)
		OF8			
		OFA			
		OFC			
		OFE			
BPLCON0		100	W	A D(E)	Bitplane control register (misc. control bits)
BPLCON1		102	W	D	Bitplane control reg. (scroll value PF1, PF2)
BPLCON2		104	W	D(E)	Bitplane control reg. (priority control)
BPLCON3		106	W	D(E)	Bitplane control (enhanced features)
BPL1MOD		108	W	A	Bitplane modulo (odd planes)
BPL2MOD		10A	W	A	Bitplane modulo (even planes)
		10C			
		10E			
BPL1DAT	&	110	W	D	Bitplane 1 data (parallel-to-serial convert)
BPL2DAT	&	112	W	D	Bitplane 2 data (parallel-to-serial convert)
BPL3DAT	&	114	W	D	Bitplane 3 data (parallel-to-serial convert)
BPL4DAT	&	116	W	D	Bitplane 4 data (parallel-to-serial convert)
BPL5DAT	&	118	W	D	Bitplane 5 data (parallel-to-serial convert)
BPL6DAT	&	11A	W	D	Bitplane 6 data (parallel-to-serial convert)
		11C			
		11E			
SPR0PTH	+	120	W	A	Sprite 0 pointer (high 3 bits)
SPR0PTL	+	122	W	A	Sprite 0 pointer (low 15 bits)
SPR1PTH	+	124	W	A	Sprite 1 pointer (high 3 bits)
SPR1PTL	+	126	W	A	Sprite 1 pointer (low 15 bits)
SPR2PTH	+	128	W	A	Sprite 2 pointer (high 3 bits)
SPR2PTL	+	12A	W	A	Sprite 2 pointer (low 15 bits)
SPR3PTH	+	12C	W	A	Sprite 3 pointer (high 3 bits)
SPR3PTL	+	12E	W	A	Sprite 3 pointer (low 15 bits)
SPR4PTH	+	130	W	A	Sprite 4 pointer (high 3 bits)
SPR4PTL	+	132	W	A	Sprite 4 pointer (low 15 bits)
SPR5PTH	+	134	W	A	Sprite 5 pointer (high 3 bits)
SPR5PTL	+	136	W	A	Sprite 5 pointer (low 15 bits)
SPR6PTH	+	138	W	A	Sprite 6 pointer (high 3 bits)
SPR6PTL	+	13A	W	A	Sprite 6 pointer (low 15 bits)
SPR7PTH	+	13C	W	A	Sprite 7 pointer (high 3 bits)
SPR7PTL	+	13E	W	A	Sprite 7 pointer (low 15 bits)
SPR0POS	%	140	W	A D	Sprite 0 vert-horiz start position data
SPR0CTL	%	142	W	A D(E)	Sprite 0 vert stop position and control data
SPR0DATA	%	144	W	D	Sprite 0 image data register A
SPR0DATB	%	146	W	D	Sprite 0 image data register B
SPR1POS	%	148	W	A D	Sprite 1 vert-horiz start position data

SPR1CTL	%	14A	W	A	D	Sprite 1 vert stop position and control data
SPR1DATA	%	14C	W		D	Sprite 1 image data register A
SPR1DATB	%	14E	W		D	Sprite 1 image data register B
SPR2POS	%	150	W	A	D	Sprite 2 vert-horiz start position data
SPR2CTL	%	152	W	A	D	Sprite 2 vert stop position and control data
SPR2DATA	%	154	W		D	Sprite 2 image data register A
SPR2DATB	%	156	W		D	Sprite 2 image data register B
SPR3POS	%	158	W	A	D	Sprite 3 vert-horiz start position data
SPR3CTL	%	15A	W	A	D	Sprite 3 vert stop position and control data
SPR3DATA	%	15C	W		D	Sprite 3 image data register A
SPR3DATB	%	15E	W		D	Sprite 3 image data register B
SPR4POS	%	160	W	A	D	Sprite 4 vert-horiz start position data
SPR4CTL	%	162	W	A	D	Sprite 4 vert stop position and control data
SPR4DATA	%	164	W		D	Sprite 4 image data register A
SPR4DATB	%	166	W		D	Sprite 4 image data register B
SPR5POS	%	168	W	A	D	Sprite 5 vert-horiz start position data
SPR5CTL	%	16A	W	A	D	Sprite 5 vert stop position and control data
SPR5DATA	%	16C	W		D	Sprite 5 image data register A
SPR5DATB	%	16E	W		D	Sprite 5 image data register B
SPR6POS	%	170	W	A	D	Sprite 6 vert-horiz start position data
SPR6CTL	%	172	W	A	D	Sprite 6 vert stop position and control data
SPR6DATA	%	174	W		D	Sprite 6 image data register A
SPR6DATB	%	176	W		D	Sprite 6 image data register B
SPR7POS	%	178	W	A	D	Sprite 7 vert-horiz start position data
SPR7CTL	%	17A	W	A	D	Sprite 7 vert stop position and control data
SPR7DATA	%	17C	W		D	Sprite 7 image data register A
SPR7DATB	%	17E	W		D	Sprite 7 image data register B
COLOR00		180	W		D	Color table 00
COLOR01		182	W		D	Color table 01
COLOR02		184	W		D	Color table 02
COLOR03		186	W		D	Color table 03
COLOR04		188	W		D	Color table 04
COLOR05		18A	W		D	Color table 05
COLOR06		18C	W		D	Color table 06
COLOR07		18E	W		D	Color table 07
COLOR08		190	W		D	Color table 08
COLOR09		192	W		D	Color table 09
COLOR10		194	W		D	Color table 10
COLOR11		196	W		D	Color table 11
COLOR12		198	W		D	Color table 12
COLOR13		19A	W		D	Color table 13
COLOR14		19C	W		D	Color table 14
COLOR15		19E	W		D	Color table 15
COLOR16		1A0	W		D	Color table 16
COLOR17		1A2	W		D	Color table 17
COLOR18		1A4	W		D	Color table 18
COLOR19		1A6	W		D	Color table 19
COLOR20		1A8	W		D	Color table 20

COLOR21	1AA	W	D	Color table 21
COLOR22	1AC	W	D	Color table 22
COLOR23	1AE	W	D	Color table 23
COLOR24	1B0	W	D	Color table 24
COLOR25	1B2	W	D	Color table 25
COLOR26	1B4	W	D	Color table 26
COLOR27	1B6	W	D	Color table 27
COLOR28	1B8	W	D	Color table 28
COLOR29	1BA	W	D	Color table 29
COLOR30	1BC	W	D	Color table 30
COLOR31	1BE	W	D	Color table 31
HTOTAL	1C0	W	A(E)	Highest number count, horiz line (VARBEAMEN=1)
HSSTOP	1C2	W	A(E)	Horizontal line position for HSYNC stop
HBSTRT	1C4	W	A(E)	Horizontal line position for HBLANK start
HBSTOP	1C6	W	A(E)	Horizontal line position for HBLANK stop
VTOTAL	1C8	W	A(E)	Highest numbered vertical line (VARBEAMEN=1)
VSSTOP	1CA	W	A(E)	Vertical line position for VSYNC stop
VBSTRT	1CC	W	A(E)	Vertical line for VBLANK start
VBSTOP	1CE	W	A(E)	Vertical line for VBLANK stop
	1D0			Reserved
	1D2			Reserved
	1D4			Reserved
	1D6			Reserved
	1D8			Reserved
	1DA			Reserved
BEAMCONO	1DC	W	A(E)	Beam counter control register (SHRES,PAL)
HSSTRT	1DE	W	A(E)	Horizontal sync start (VARHSY)
VSSTRT	1E0	W	A(E)	Vertical sync start (VARVSY)
HCENTER	1E2	W	A(E)	Horizontal position for Vsync on interlace
DIWHIGH	1E4	W	A,D(E)	Display window - upper bits for start, stop
RESERVED	1110X			
RESERVED	1111X			
NO-OP (NULL)	1FE			



---

# appendix C

## **ENHANCED CHIP SET**

This appendix contains information on the Enhanced Chip Set (ECS). The Enhanced Chip Set consists of the Agnus (8372-R3) and Denise (8373-R3) custom Amiga chips. These chip revisions support advanced features in addition to all of the standard features previously available.

The ECS is standard in the A3000. The enhanced Agnus and Denise chips are plug-compatible replacements for the originals in the A500 or A2000. There are no provisions for installing the ECS in the original A1000. The A2000, when jumpered for one megabyte of chip memory, will function normally with the ECS chips installed, under both V1.3 and V2.0 Amiga System software.

The ECS chips are designed to function with either NTSC or PAL Amigas. However, the chips from the US factory are configured for NTSC mode. In order to use them on a PAL system, you may have to reset the motherboard jumpers for proper performance.

### **NEW FEATURES OF THE ENHANCED CHIP SET**

The new features of the Enhanced Chip Set are as follows:

- New Memory Limits
- New Blitter Range
- New Mode Resolutions
- New Monitor Scan Rates
- New Genlock Capabilities
- Built-in A2024 support

The following briefly describes each of the new ECS features.

---

### ***New Memory Limits***

The A3000 has 1 MB of Chip memory, and with proper jumpering of the motherboard, an additional 1 MB can be added. On the A2000, the enhanced Agnus can access up to 1 megabyte of Chip memory with proper jumpering of the motherboard. This provides programs with more blitter-accessible memory for animation and graphics applications.

### ***New Blitter Range***

The enhanced Agnus provides rectangular blits up to 32k by 32k pixels in size.

### ***New Mode Resolutions***

The enhanced Denise chip provides the new SuperHires mode with up to 1280 horizontal pixels per scanline on a standard NTSC or PAL display.

All of the standard display resolutions and depths of the original chip set are supported with the ECS.

### ***New Monitor Scan Rates***

The V2.0 Kickstart and ECS chips support a new high resolution Productivity mode. With the addition of a multi-sync monitor, this mode allows 640 x 480, non-interlaced screens in up to four colors. All programs which open and operate in the Workbench screen will automatically benefit from Productivity text and graphics. In addition, new programs can open their own Productivity screens in a system standard fashion.

### ***New Genlock Capabilities***

The enhanced Denise chip provides the following four new genlock features:

- Chromakey
- BitPlaneKey
- BorderBlank
- BorderNotTransparent

ChromaKey allows any color register to control the video overlay. BitPlaneKey allows any bitplane to enable the video overlay. BorderBlank creates a transparent "frame" surrounding the active area. BorderNotTransparent makes an opaque "frame" surrounding the active area.

---

### ***Built-In A2024 Support***

Version 2.0 Kickstart ROMS have built-in support for the A2024 scan-converter monitor which displays 1008 x 800 pixels (1008 x 1024 in PAL mode) in four monochrome levels, non-interlaced. In conjunction with 1 megabyte of Chip memory, this allows very high resolution Workbench screens, as well as support for "full page" text and CAD applications.

### **ECS HARDWARE AND THE GRAPHICS LIBRARY**

The Enhanced Chip Set consists of compatible revisions to the Agnus and Denise custom chips. The V36 graphics.library software makes it possible for these chips to display images in new resolutions, at new monitor scan rates and with new sprite and genlock abilities.

With the enhanced Agnus, the V36 graphics.library supports the new programmable scan rate registers to provide multi-sync and bi-sync monitor capability. The new SuperHires mode provides 35ns pixel rates and sprite positioning at 70ns rates. Support for big blits (up to 32k x 32k) is provided for all graphics functions if the ECS Agnus is present.

With the enhanced Denise, the V36 graphics.library provides display window start and stop with explicit control over larger ranges than was possible before. There are new color register interpretations as part of the SuperHires mode. Genlock control has been expanded for more flexibility. Borders may be explicitly transparent or opaque, color registers other than zero can control video overlay and a bitplane mask may be used for special-purpose video masking concurrently with the other genlock features.

*Warning:* With these new features come certain new responsibilities when using the graphics.library.

The register map listed below shows the changes and new registers in the Amiga's Enhanced Chip Set.

ADD	REGISTER	V2.0	R/W	CHIP	FUNCTION
004	VPOSR	chg	R	A	Read vertical most sig. bits (and frame flop)
012	POTODAT	chg	R	P	Pot counter data left pair (vertical, horiz)
014	POT1DAT	chg	R	P	Pot counter data right pair (vertical, horiz)
020	DSKPTH	chg	W	A	Disk pointer (high 5 bits, was 3 bits)
02E	COPCON	chg	W	A	Coprocessor control
03E	STRLONG	chg	S	D	Strobe for identification of long horiz line
042	BLTCON1	chg	W	A	Blitter control register 1
050	BLTxPTH	chg	W	A	Blitter pointer to x (high 5 bits, was 3 bits)
05A	BLTCON0L	new	W	A	Blitter control 0, lower 8 bits (minterms)
05C	BLTSIZV	new	W	A	Blitter V size (for 15 bit vertical size)
05E	BLTSIZH	new	W	A	Blitter H size and start (for 11 bit H size)
07C	DENISEID	new	R	D	Chip revision level for Denise (video out chip)
080	COP1LCH	chg	W	A	Coprocessor 1st location (high 5 bits, was 3 bits)
084	COP2LCH	chg	W	A	Coprocessor 2nd location (high 5 bits, was 3 bits)
0A0	AUDxLCH	chg	W	A	Audio channel x location (high 5 bits was 3 bits)
0A6	AUDxPER	chg	W	P	Audio channel x period
100	BPLCON0	chg	W	A,D	Bitplane control (miscellaneous control bits)
104	BPLCON2	chg	W	D	Bitplane control (video priority control)
106	BPLCON3	new	W	D	Bitplane control (enhanced features)
142	SPRxCTL	chg	W	A	Sprite x position and control data
1C0	HTOTAL	new	W	A	Highest number count, horiz line (VARBEAMEN=1)
1C2	HSSTOP	new	W	A	Horizontal line position for HSYNC stop
1C4	HBSTRT	new	W	A	Horizontal line position for HBLANK start
1C6	HBSTOP	new	W	A	Horizontal line position for HBLANK stop
1C8	VTOTAL	new	W	A	Highest numbered vertical line (VARBEAMEN=1)
1CA	VSSTOP	new	W	A	Vertical line position for VSYNC stop
1CC	VBSTRT	new	W	A	Vertical line for VBLANK start
1CE	VBSTOP	new	W	A	Vertical line for VBLANK stop
1DC	BEAMCON0	new	W	A	Beam counter control register (SHRES,UHRES,PAL)
1DE	HSSTRT	new	W	A	Horizontal sync start (VARHSY)
1E0	VSSTRT	new	W	A	Vertical sync start (VARVSY)
1E2	HCENTER	new	W	A	Horizontal position for Vsync on interlace
1E4	DIWHIGH	new	W	A,D	Display window - upper bits for start, stop

A=Agnus chip, D=Denise chip, P=Paula chip, W=Write, R=Read, S=Strobe

The following sections describe the new and modified features provided by the Enhanced Chip Set.



---

## Determining Chip Revisions

The V36 graphics.library field GfxBase->ChipRevBits0 contains bit definitions to tell you whether ECS is currently installed and activated. These bits are derived from the new or changed registers in the ECS chips.

The bit GFXF\_HR\_AGNUS indicates that enhanced HiRes Agnus is installed. This is derived from the Agnus VPOSR register. The VPOSR register is defined as follows:

```
VPOSR - Read vertical most significant bits (and frame flop)

Bit   15 14 13 12 11 10 09 08 07 06 05 04 03 02 01 00
Use  LOF I6 I5 I4 I3 I2 I1 I0 LOL -- -- -- -- v10 v9 v8
```

I0-I6 (bits 8-14) provide the chip identification. At present there are four possible settings. A value of 20 or 30 indicates that the enhanced HighRes Agnus is present.

```
8361 (regular NTSC) or 8370 (fat NTSC) = 10 for NTSC Agnus
8367 (regular PAL)  or 8371 (fat PAL)   = 00 for PAL Agnus
8368 (hr)           or 8372 (fat-hr)    = 20 for PAL, 30 for NTSC
```

Similarly, the graphics.library flag GFXF\_HR\_DENISE is derived from the Denise register DENISEID. This is a new register which can have one of two values. The original Denise (8362) does not have this register, so whatever value is left over on the bus from the last cycle will be there. The enhanced HighRes Denise (8373) will return \$FC in the lower 8 bits. The upper 8 bits are reserved.

## SuperHires Mode

SuperHires mode provides a 35ns pixel display rate - twice the horizontal resolution of Hires mode, and four times the Lores rates. The nominal resolution of a SuperHires viewport is 1280 pixels. The maximum plane depth for a SuperHires viewport is 2 bitplanes which saturates DMA bandwidth as much as FOUR Hires bitplanes. This mode is controlled by the graphics.library by writing to the BPLCON0 register in the LOF copperlist (/SHF if interlaced).

Bit	Use	
15	HIRES	Set it to zero if SHRES enabled
14	BPU2 \	Depth of SuperHires mode (1 or 2)
13	BPU1 }	
12	BPU0 /	
11	HAM	Incompatible w/ SuperHires mode
10	DPF	Compatible with SuperHires mode
09		
08		
07		
06	SHRES	SuperHires 35ns pixel enable bit
05	BPLHWRM	
04	SPRHWRM	
03	LPEN	Compatible with SuperHires mode
02	LACE	Compatible with SuperHires mode
01		
00		

**Warning:** Programmers must *not* rely on interpreting ViewPort->Modes bits directly when determining the mode of a ViewPort.

Beginning with the V36 graphics.library, the ViewPort->Modes field is used for backward compatibility *only*.

Under V1.3 and earlier the ViewPort->Modes field mirrored some of the BPLCON0 bits most notably Hires and Lace. However, other logical defines in this field such as the Viewport->Modes PF2PRI bit conflict with the SHRES bit assignment in the actual hardware.

For this reason, in release 2.0 of the operating system (graphics.library V36 and later), programmers will need to use the new DataBase/ModeID scheme to determine their ViewPort's mode, and to specify a mode when creating, cloning, or copying ViewPorts.

## SuperHires Mode and the Denise Color Registers

SuperHires mode has a coarser granularity of color control than either Hires or Lores modes. This is because the timing of color conversions at these very high pixel rates requires special "tricks". There are only two bits of red, green and blue color resolution per hires pixel.

In order to decode sprite and bitplane color information in SuperHires mode, certain multiplexing occurs in the use of the registers. Instead of 4 bits of red, green, and blue for bitplane registers 0-3 stored as 0x0RGB in four color registers, SuperHires bitplane colors are specially encoded in the sixteen lower color registers:

		R		G		B											
		----		----		----											
Bitplane (Color 0) :		ab--	cd--	ef--													
Bitplane (Color 1) :		gh--	ij--	kl--													
Bitplane (Color 2) :		mn--	op--	qr--													
Bitplane (Color 3) :		st--	uv--	wx--													
BIT		15	14	13	12	11	10	09	08	07	06	05	04	03	02	01	00
C	00	.	.	.	.	a	b	a	b	c	d	c	d	e	f	e	f
O	01	.	.	.	.	g	h	a	b	i	j	c	d	k	l	e	f
L	02	.	.	.	.	m	n	a	b	o	p	c	d	q	r	e	f
O	03	.	.	.	.	s	t	a	b	u	v	c	d	w	x	e	f
R	04	.	.	.	.	a	b	g	h	c	d	i	j	e	f	k	l
	05	.	.	.	.	g	h	g	h	i	j	i	j	k	l	k	l
R	06	.	.	.	.	m	n	g	h	o	p	i	j	q	r	k	l
E	07	.	.	.	.	s	t	g	h	u	v	i	j	w	x	k	l
G	08	.	.	.	.	a	b	m	n	c	d	o	p	e	f	q	r
I	09	.	.	.	.	g	h	m	n	i	j	o	p	k	l	q	r
S	0A	.	.	.	.	m	n	m	n	o	p	o	p	q	r	q	r
T	0B	.	.	.	.	s	t	m	n	u	v	o	p	w	x	q	r
E	0C	.	.	.	.	a	b	s	t	c	d	u	v	e	f	w	x
R	0D	.	.	.	.	g	h	s	t	i	j	u	v	k	l	w	x
	0E	.	.	.	.	m	n	s	t	o	p	u	v	q	r	w	x
	0F	.	.	.	.	s	t	s	t	u	v	u	v	w	x	w	x

SuperHires sprites are encoded in the upper sixteen color registers using a similar scheme:

		R		G		B										
		----		----		----										
Sprite (Color 16) :		AB--	CD--	EF--												
Sprite (Color 17) :		GH--	IJ--	KL--												
Sprite (Color 18) :		MN--	OP--	QR--												
Sprite (Color 19) :		ST--	UV--	WX--												
BIT	15	14	13	12	11	10	09	08	07	06	05	04	03	02	01	00
C	10	.	.	.	A	B	A	B	C	D	C	D	E	F	E	F
O	11	.	.	.	G	H	A	B	I	J	C	D	K	L	E	F
L	12	.	.	.	M	N	A	B	O	P	C	D	Q	R	E	F
O	13	.	.	.	S	T	A	B	U	V	C	D	W	X	E	F
R	14	.	.	.	A	B	G	H	C	D	I	J	E	F	K	L
	15	.	.	.	G	H	G	H	I	J	I	J	K	L	K	L
R	16	.	.	.	M	N	G	H	O	P	I	J	Q	R	K	L
E	17	.	.	.	S	T	G	H	U	V	I	J	W	X	K	L
G	18	.	.	.	A	B	M	N	C	D	O	P	E	F	Q	R
I	19	.	.	.	G	H	M	N	I	J	O	P	K	L	Q	R
S	1A	.	.	.	M	N	M	N	O	P	O	P	Q	R	Q	R
T	1B	.	.	.	S	T	M	N	U	V	O	P	W	X	Q	R
E	1C	.	.	.	A	B	S	T	C	D	U	V	E	F	W	X
R	1D	.	.	.	G	H	S	T	I	J	U	V	K	L	W	X
	1E	.	.	.	M	N	S	T	O	P	U	V	Q	R	W	X
	1F	.	.	.	S	T	S	T	U	V	U	V	W	X	W	X

*About SuperHires color.* SuperHires color encryption is not reflected in the ColorTable. The color encoding is, however, reflected in the ViewPort's copper lists generated by graphics via MakeVPort(), SetRGB4(), etc.

Keep in mind that because of the loss of lower bits of precision in specifying SuperHires colors, pastel colors in a closely graduated color scheme may be visually difficult to distinguish from each other.

## SuperHires 70ns Sprite Positioning

SuperHires mode has a finer granularity of sprite positioning than either Hires or Lores modes. This allows for positioning the sprite every other SuperHires pixel on 70ns boundaries. The ECS registers SPRxPOS and SPRxCTL work together as position, size and sprite feature control registers. They are usually loaded by the sprite DMA channel, during horizontal blank, however they may be loaded by the processor.

The two registers are defined as follows:

```
SPRxPOS W   A D   Sprite x vertical-horiz start position data
      Bit      Use
      ----      ----
      15-08
      07-00  SH8-SH1  Start horizontal value. Low bit (SH0) in SPRxCTL.
```

```
SPRxCTL W   A D   Sprite x position and control data
      Bit      Use
      ----      ----
      15-08
      07
      06
      05
      04      SHSH1   Start horizontal (SHR mode) 70ns increment
      03      SHSH0   Start horizontal (SHR mode) 35ns (unimplemented)
      02
      01
      00      SH0     Start horiz. value Low bit 140 ns increment
```

Note: bits 3 and 4 are in the ECS chips only.

**Warning:** 70ns sprite positions are only available in SuperHires mode. Attempting to use 70ns sprite positioning with Hires mode under the current system may lead to unpredictable results.

## Multi-Sync and Bi-Sync Monitors

The enhanced Agnus now includes registers for setting a standard programmable scan rate. The scan rates supported in the V36 graphics.library include:

```
NTSC (525 lines, 227.5 colorclocks per scan line)
PAL  (625 lines, 227.5 colorclocks per scan line)
VGA  (525 lines, 114.0 colorclocks per scan line)
```

The V36 graphics.library controls the variable number of colorclocks on each horizontal scan line with a combination of registers. Each combination of registers provides a different frequency of scan rate and number of lines per display field:

```
HTOTAL    W    A    Highest number count in horizontal line

          Bit 15 14 13 12 11 10 09 08 07 06 05 04 03 02 10 00
          Use  0  0  0  0  0  0  0  0  0 h8 h7 h6 h5 h4 h3 h2 h1
```

The value in this register represents the number of 280ns increments on the horizontal line.

```
VTOTAL    W    A    Highest numbered vertical line
```

VTOTAL contains the line number at which to reset the vertical position counter. This value represents the number of lines in a field(+1). The exception is if the INTERLACE bit is set (BPLCON0). In this case this value represents the number of lines in the long field (+2) and the number of lines in the short field (+1).

Programmable synchronization is implemented through five new enhanced Agnus registers:

```
VSSTRT    W    A    Vertical line position for VSYNC start
VSSTOP    W    A    Vertical line position for VSYNC stop
HSSTRT    W    A    Horizontal line position for HSYNC start
HSSTOP    W    A    Horizontal line position for HSYNC stop
HCENTER    W    A    Horizontal position for Vsync on interlace
```

A reasonable composite can be generated by setting HCENTER half a horizontal line from HSSTRT, and HBSTOP at (HSSTOP-HSSTRT) before HCENTER, with HBSTRT at (HSSTOP-HSSTRT) before HSSTRT.

Programmable blanking is implemented through four new ECS Agnus registers:

```
HBSTRT    W    A    Horizontal line position for HBLANK start
HBSTOP    W    A    Horizontal line position for HBLANK stop
VBSTRT    W    A    Vertical line position for VBLANK start
VBSTOP    W    A    Vertical line position for VBLANK stop
```

## New BEAMCON0 Register

A new register in the enhanced Agnus, BEAMCON0, provides a programmable signal generator.

BEAMCON0	W	A	Beam counter control register
Bit			Use
---			---
15			
14		HARDDIS	Disable hardwired vertical/horizontal blank
13		LPENDIS	Ignore latched pen value on vertical pos read
12		VARVBEN	Use VBSTRT/STOP disable hard window stop
11		LOLDIS	Disable long line/short line toggle
10		CSCBEN	Composite sync redirection
9		VARVSYEN	Variable vertical sync enable
8		VARHSYEN	Variable horizontal sync enable
7		VARBEAMEN	Variable beam counter comparator enable
6		DUAL	Special ultra resolution mode enable
5		PAL	Programmable pal mode enable
4		VARCSYEN	Variable composite sync
3		BLANKEN	Composite blank redirection
2		CSYTRUE	Polarity control for C sync pin
1		VSYTRUE	Polarity control for V sync pin
0		HSYTRUE	Polarity control for H sync pin

*Warning:* Programmable changes between PAL and NTSC modes are new for V2.0. They rely on hardware sync and blank in the Agnus/Denise chip set to guarantee necessary signals for a correctly displayed picture.

Other modes, such as VGA (31 kHz programmable mode) disable the hard stops on display sync and blank. Do not write to this register.

Incorrectly writing directly to BEAMCON0 has the (remote) possibility of destroying your multisync monitor.

## Display Window Specification

The new graphics.library and the ECS provide a more powerful display window specification. The registers DIWSTRT and DIWSTOP control the display window size and position:

DIWSTRT	W	A	D	Display Window Start (upper left	vert-hor pos)											
DIWSTOP	W	A	D	Display Window Stop (lower right	vert-hor pos)											
Bit	15	14	13	12	11	10	09	08	07	06	05	04	03	02	01	00
Use	V7	V6	V5	V4	V3	V2	V1	V0	H7	H6	H5	H4	H3	H2	H1	H0

The way these two registers work has changed. DIWSTRT used to be vertically restricted to the upper 2/3 of the display (V8=0), and horizontally restricted to the left 3/4 of the display (H8=0). DIWSTOP used to be vertically restricted to the lower 1/2 of the display and horizontally restricted to the right 1/4 of the display (H8=1).

The V36 graphics.library now supports explicit display window start and stop positions within a larger and more useful range of values, via control of the the new DIWHIGH register in the ViewPort copper lists:

DIWHIGH	W	A	D	Display Window upper bits for	start,stop
Bit	Use				
---	---				
15	0				
14	0				
13	H8			Horizontal stop, most significant bit.	
12	0				
11	0				
10	V10 \				
9	V9 }			Vertical stop, most significant 3 bits.	
8	V8 /				
7	0				
6	-				
5	H8			Horizontal start, most significant bit.	
4	0				
3	0				
2	V10 \				
1	V9 }			Vertical stop, most significant 3 bits.	
0	V8 /				

This is an added register for the ECS chips, and allows larger start and stop ranges. If it is not written, the old scheme for DIWSTRT and DIWSTOP described above holds. If this register is written last in a sequence of setting the display window, it sets direct start and stop positions anywhere on the screen.

*A note on ECS compatibility.* With the enhanced Denise chip present, the graphics.library will set up copperlists using the new, explicit display window controls. Programs which consistently call MakeVPort(), MrgCop() and Loadview() when changing the vertical position of their ViewPort (DxOffset) will continue to behave normally.

Programs which failed to call MakeVPort() when moving the ViewPort vertically may not be displayed correctly on a system with ECS.



## Genlock Extensions

The V36 graphics.library supports the new genlock capabilities of the enhanced Denise chip in PAL or NTSC modes. Any color registers may be chosen as controlling video overlay (COLORKEY). A single bitplane may be chosen to control video overlay as well (BITPLANEKEY). The border areas surrounding the active display window may also be set to be opaque or transparent.

BPLCON0	W	A,D	Bitplane control (miscellaneous control bits)
BPLCON1	W	D	Bitplane control (horizontal scroll control)
BPLCON2	W	D	Bitplane control (video priority control)
BPLCON3	W	D	Bitplane control (enhanced features)

Bit	BPLCON0	BPLCON1	BPLCON2	BPLCON3
15				
14			ZDBPSEL2 \	
13			ZDBPSEL1 }	Select bitplane
12			ZDBPSEL0 /	
11			ZDBPEN	Use BITPLANEKEY
10			ZDCTEN	Use COLORKEY
09			KILLEHB	Kill halfbrite
08				
07				
06				
05				BRDRBLNK Border blank
04				BRDNTRAN Border opaque
03				
02				
01				
00	ENBPLCN3			Enable new BLPON3 register.

The ECS genlock features are enabled on a ViewPort by ViewPort basis.

**Warning:** Genlock has been designed to work with NTSC and PAL modes only. Genlock and 31 KHz programmable scan rates are not compatible modes.

## Big Blits

The V36 graphics.library supports the ECS Agnus Blitter enhancements, which provide for contiguous blits of up to 32768 x 32768 pixels at a time. Under the original chip set 1024 x 1024 was the maximum:

```
BLTSIZE  W  A      Old Blitter size and start (window width, height)
```

```
Bit    15 14 13 12 11 10 09 08 07 06 05 04 03 02 01 00
Use    h9 h8 h7 h6 h5 h4 h3 h2 h1 h0 w5 w4 w3 w2 w1 w0
```

```
h = Height (10 bit height = 1024 lines max)
```

```
w = Width (6 bit width = 1024 pixels max)
```

Two new registers have been added which make larger blits possible:

```
BLTSIZV  W  A      ECS Blitter V size
```

```
Bit    15 14 12 12 11 10 09 08 07 06 05 04 03 02 01 00
Use    0 h14 h13 h12 h11 h10 h9 h8 h7 h6 h5 h4 h3 h2 h1 h0
```

```
h = Height (15 bit height = 32768 lines max)
```

```
BLTSIZH  W  A      ECS Blitter Horizontal size & start
```

```
Bit    15 14 13 12 11 10 09 08 07 06 05 04 03 02 01 00
Use    0 0 0 0 0 w10 w9 w8 w7 w6 w5 w4 w3 w2 w1 w0
```

```
w = Width (11 bit width = 32768 pixels max)
```

With these two registers, blits up to 32K by 32K are now possible - much larger than the original chip set could accept. The original commands are retained for compatibility. BLTSIZV should be written first, followed by BLTSIZH, which starts the blitter.

The existence of the enhanced Agnus Blitter is reflected in the state of the GfxBase->ChipRevBits bit definition GFXB\_BIG\_BLITS and is initialized by the graphics.library at powerup. Note that the <hardware/blits.h> constant MAXBYTESPERROW has been redefined to reflect the larger range of legal blitter operations.

*About RastPort Sizes.* If the ECS Blitter is accessible, the graphics.library supports its use for all graphics functions including areafill, gels, line and ellipse drawing functions.

If the ECS Blitter is *not* installed, programmers should limit the absolute size of their RastPorts to values that the old BLTSIZE register can address.

## Other ECS Modifications

The preceding sections cover most of the ECS registers appearing in the ECS register map. This section briefly describes the remaining modifications to the Enhanced Chip Set registers.

The following registers now have two additional bits for addressing larger segments of memory, when the Enhanced Chip Set is present:

DSKPTH	020	W	A	Disk pointer (high 5 bits, was 3 bits)
BLTxPTH	050	W	A	Blitter pointer to x (high 5 bits, was 3 bits)
COP1LCH	080	W	A	Coprocessor 1st location (high 5 bits, was 3 bits)
COP2LCH	084	W	A	Coprocessor 2nd location (high 5 bits, was 3 bits)
AUDxLCH	0A0	W	A	Audio channel x location (high 5 bits was 3 bits)

The Strobe Long Line register (STRLONG) can be disabled if the Disable Long Line (LOLDIS) bit is set in the BEAMCON0 register.

STRLONG	03E	S	D	Strobe for identification of long horiz line
---------	-----	---	---	--

See the Multi-Sync and Bi-Sync Monitors section in this appendix for the bit descriptions in BEAMCON0.

Bit 7 (DOFF) of the BLTCON1 register, when set, disables the output of the Blitter hardware on channel D.

BLTCON1	042	W	A	Blitter control register 1
---------	-----	---	---	----------------------------

This allows inputs to channels A, B and C and certain address modification if necessary, without the Blitter outputting over channel D.

The BLTCON0L register writes the low bits of BLTCON0, thereby expediting the set up of some blits and generally speeding up the software, since the upper bits are often the same.

BLTCON0L	05A	W	A	Blitter control 0, lower 8 bits (minterms)
----------	-----	---	---	--

---

## ***Interpretational Differences***

The following registers have the same functionality as the standard chip set, however, their behavior is interpreted differently.

The POT0 and POT1 registers each read a pair of 8-bit pot counters as before.

```
POT0DAT  012  R  P      Pot counter data left pair (vertical, horiz)
POT1DAT  014  R  P      Pot counter data right pair (vertical, horiz)
```

However, with programmable scan rates, the values read from these registers will differ. Generally, the faster the scan rate, the smaller these values become. Adjustments to the scan rate are reflected in these values. See Appendix A for more detail on standard operation of these registers.

Another register where the interpretation has been extended for the ECS is COPCON.

```
COPCON   02E   W   A      Coprocessor control
```

This 1-bit register, the danger bit (CDANG), when set allows the Coprocessor to write to the Blitter hardware. In the standard chip set, if this is set, the Copper can access the address range from \$DFF03E through \$DFF07E. Now, in the ECS, if this bit is set, the Copper can access all of the Amiga chip registers. If this bit is clear, the Copper can access the address range from \$DFF03E through \$DFF07E, the same range as when the danger bit is set in the standard chip set.

The AUDxPER register is another register value that varies according to the programmable scan rate.

```
AUDxPER  0A6   W   P      Audio channel x period
```

With programmable scan rates, the maximum value read from this register will differ. Generally, the faster the scan rate, the smaller the maximum period becomes. Adjustments to the scan rate are reflected in this maximum value.

For more information on the AUDxPER register, and any other register in the Amiga standard chip set, see Appendices A and B.





---

## appendix D

# SYSTEM MEMORY MAPS

A true software memory map, showing system utilization of the various sections of RAM and free space is not provided, nor possible with the Amiga.

All memory is dynamically allocated by the memory manager at boot time, and the actual locations of system structures may change from release-to-release, machine-to-machine, or boot-to-boot (see the `AllocMem()` function in the `exec.library` for more details).

Likewise, Amiga applications are compiled in such a way that they can be dynamically relocated at run time by the system loader.

To find the location of system structures, application software should use the function interface provided in the operating system. If this is not possible then the address of a data structure should be obtained by searching the lists of system structures maintained by `Exec`. The first step is to fetch the address of the `exec.library` from location 4; this is the only absolute memory location in the system. All other system data structures are indirectly linked to this base address.

Though a detailed system memory map is not possible, this section does present the general layout of memory areas within the current generation of Amiga computers. To ensure maximum compatibility, avoid relying on the address ranges given here. Instead use the system provided interfaces to ask for the system resources you need.

## A1000, A500 and A2000 Memory Map

Address Range	Description
00 0000 - 03 FFFF	256K Chip RAM (A1000 Chip RAM, 1st 256K for A500/A2000)
04 0000 - 07 FFFF	256K bytes of Chip RAM (2nd 256K for A500/A2000)
08 0000 - 0F FFFF	512K Extended chip RAM (to 1 MB for A2000).
10 0000 - 1F FFFF	Reserved. Do not use.
20 0000 - 9F FFFF	Primary 8 MB Auto-config space.
A0 0000 - BE FFFF	Reserved. Do not use.
BF D000 - BF DF00	8520-B (access at even-byte addresses only)
BF E001 - BF EF01	8520-A (access at odd-byte addresses only)
	The underlined digit chooses which of the 16 internal registers of the 8520 is to be accessed. See Appendix F.
C0 0000 - DF EFFF	Reserved. Do not use.
C0 0000 - D7 FFFF	Internal expansion (slow) memory (on some systems).
D8 0000 - DB FFFF	Reserved. Do not use.
DC 0000 - DC FFFF	Real time clock (not accessible on all systems).
DF F000 - DF FFFF	Chip registers. See Appendix A and Appendix B.
+--	
E0 0000 - E7 FFFF	Reserved. Do not use.
E8 0000 - E8 FFFF	Auto-config space. Boards appear here before the system relocates them to their final address.
E9 0000 - EF FFFF	Secondary auto-config space (usually 64K I/O boards).
F0 0000 - FB FFFF	Reserved. Do not use.
FC 0000 - FF FFFF	256K System ROM.



## A3000 Memory Map

Address Range	Description
\$0000 0000 - \$001F FFFF	Amiga Chip Memory
\$0020 0000 - \$009F 0000	Zorro II Memory Expansion Space
\$00A0 0000 - \$00B7 FFFF	Zorro II I/O Expansion Space
\$00B8 0000 - \$00BE FFFF	Reserved
\$00BF 0000 - \$00BF FFFF	CIA Ports & Timers
\$00C0 0000 - \$00C7 FFFF	Expansion Memory
\$00C8 0000 - \$00D7 FFFF	Reserved
\$00D8 0000 - \$00DB FFFF	Reserved
\$00DC 0000 - \$00DD FFFF	Memory Mapped Clock
\$00DD 0000 - \$00DE FFFF	SCSI Control
\$00DE 0000 - \$00DE FFFF	Motherboard Resources
\$00DF 0000 - \$00DF FFFF	Amiga Chip Registers
\$00E0 0000 - \$00E7 FFFF	Reserved
\$00E8 0000 - \$00EF FFFF	Zorro II I/O & Configuration
\$00F0 0000 - \$00F7 FFFF	Diagnostic ROM (Reserved)
\$00F8 0000 - \$00FF FFFF	High ROM (512K)
\$0100 0000 - \$03FF FFFF	Reserved
\$0400 0000 - \$07FF FFFF	Motherboard Fast RAM
\$0800 0000 - \$0FFF FFFF	Coprocessor Slot Expansion
\$1000 0000 - \$7FFF FFFF	Zorro III Expansion
\$8000 0000 - \$FEFF FFFF	Reserved
\$FF00 0000 - \$FF00 FFFF	Zorro III Configuration Unit
\$FF01 0000 - \$FFFF FFFF	Reserved

# Amiga 3000 Memory Map

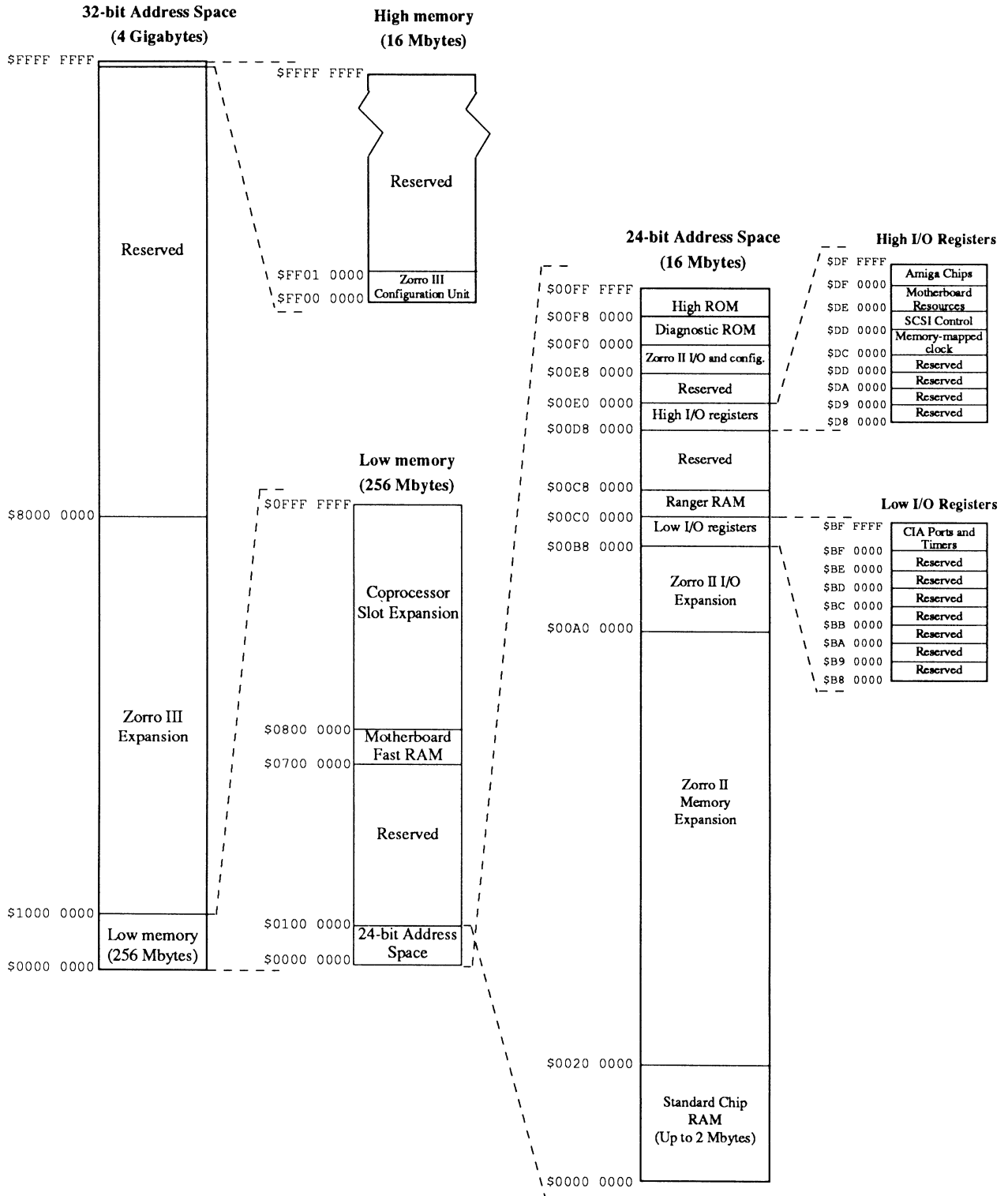

---

# appendix E

## I/O CONNECTORS AND INTERFACES

This appendix consists of four distinct parts, related to the way in which the Amiga talks to the outside world.

The first part specifies the pinouts of the externally accessible connectors and the power available at each connector. It does not, however, provide timing or loading information.

The second part briefly describes the functions of those pins whose purpose may not be evident.

The third part contains a list of the connections for certain internal connectors, notably the disk.

The fourth part specifies how various signals relate to the available ports of the 8520. This information enables the programmer to relate the port addresses to the outside-world items (or internal control signals) that are to be affected.

The third and fourth parts are primarily for the use of the systems programmer and should generally not be utilized by applications programmers.

Systems software normally is configured to handle the setting of particular signals, no matter how the physical connections may change. In other words, if you have a version of the system software that matches the revision level of the machine (normally a true condition), when you ask that a particular bit be set, you don't care which port that bit is connected to. Thus, applications programmers should rely on system documentation rather than going directly to the ports.

**Warning:** In a multitasking operating system, many different tasks may be competing for the use of the system resources. Application programmers should follow the established rules for resource access in order to assure compatibility of their software with the system. Don't just hit the hardware registers directly, ask the system for exclusive control first.

## PART 1 - AMIGA I/O CONNECTOR PINS

This is a list of the I/O connections to the outside world on the Amiga.

RS232 and MIDI Port

PIN	RS232	A1000	A500/ A2000/ A3000	CBM PCs	HAYES	DESCRIPTION
1	GND	GND	GND	GND	GND	FRAME GROUND
2	TXD	TXD	TXD	TXD	TXD	TRANSMIT DATA
3	RXD	RXD	RXD	RXD	RXD	RECEIVE DATA
4	RTS	RTS	RTS	RTS	-	REQUEST TO SEND
5	CTS	CTS	CTS	CTS	CTS	CLEAR TO SEND
6	DSR	DSR	DSR	DSR	DSR	DATA SET READY
7	GND	GND	GND	GND	GND	SYSTEM GROUND
8	CD	CD	CD	DCD	DCD	CARRIER DETECT
9	-	-	+12v	+12v	-	+ 12 VOLT POWER
10	-	-	-12v	-12v	-	- 12 VOLT POWER
11	-	-	AUDO	-	-	AUDIO OUTPUT (A500, A2000, A3000)
12	S.SD	-	-	-	SI	SPEED INDICATE
13	S.CTS	-	-	-	-	-
14	S.TXD	-5Vdc	-	-	-	- 5 VOLT POWER
15	TXC	AUDO	-	-	-	AUDIO OUTPUT (A1000)
16	S.RXD	AUDI	-	-	-	AUDIO INPUT (A1000)
17	RXC	EB	-	-	-	BUFFERED PORT CLOCK 716kHz
18	-	INT2*	AUDI	-	-	INTERRUPT LINE A1000/AUDIO INPUT (A500, 2000, 3000)
19	S.RTS	-	-	-	-	-
20	DTR	DTR	DTR	DTR	DTR	DATA TERMINAL READY
21	SQD	+5	-	-	-	+ 5 VOLT POWER
22	RI	-	RI	RI	RI	RING INDICATOR
23	SS	+12Vdc	-	-	-	+12 VOLT POWER
24	TXC1	C2*	-	-	-	3.58 MHZ CLOCK
25	-	RESB*	-	-	-	BUFFERED SYSTEM RESET

Parallel (Centronics) Port

-----

PIN	A1000	A500/A2000/A3000	Commodore PCs
1	DRDY*	STROBE*	STROBE*
2	Data 0	Data 0	Data 0
3	Data 1	Data 1	Data 1
4	Data 2	Data 2	Data 2
5	Data 3	Data 3	Data 3
6	Data 4	Data 4	Data 4
7	Data 5	Data 5	Data 5
8	Data 6	Data 6	Data 6
9	Data 7	Data 7	Data 7
10	ACK*	ACK*	ACK*
11	BUSY (data)	BUSY	BUSY
12	POUT (clk)	POUT	POUT
13	SEL	SEL	SEL
14	GND	+5v pullup	AUTOFDXT
15	GND	NC	ERROR*
16	GND	RESET*	INIT*
17	GND	GND	SLCT IN*
18-22	GND	GND	GND
23	+ 5	GND	GND
24	NC	GND	GND
25	Reset*	GND	GND

KEYBOARD ...RJ11 (Not Applicable to the A500)

-----

	A1000	A2000/A3000
1	+5 Volts	KCLK
2	CLOCK	KDAT
3	DATA	NC
4	GND	GND
5		+5 Volts

Video ...DB23 MALE

-----

For A500, A1000, A2000 and A3000 unless otherwise stated

1	XCLK*	13	GNDRTN (Return for XCLKEN*)
2	XCLKEN*	14	ZD*
3	RED	15	C1*
4	GREEN	16	GND
5	BLUE	17	GND
6	DI	18	GND
7	DB	19	GND
8	DG	20	GND
9	DR	21	-5 VOLT POWER (A1000, A2000, A3000)
10	CSYNC*		-12 VOLT POWER (A500)
11	HSYNC*	22	+12 VOLT POWER
12	VSYNC*	23	+5 VOLT POWER

Video Display Enhancer - DB 15 Female (A3000 ONLY)

-----  
1 RED VIDEO  
2 GREEN VIDEO  
3 BLUE VIDEO  
4 MONITOR ID BIT 2 (NOT USED)  
5 GROUND  
6 RED RETURN (GROUND)  
7 GREEN RETURN (GROUND)  
8 BLUE RETURN (GROUND)  
9 KEY (NO PIN)  
10 SYNC RETURN (GROUND)  
11 MONITOR ID BIT 0 (NOT USED)  
12 MONITOR ID BIT 1 (NOT USED)  
13 HORIZONTAL SYNC  
14 VERTICAL SYNC  
15 NOT USED

RF Monitor ...8 PIN DIN (J2) (A1000 Only)

-----  
1 N.C.  
2 GND  
3 AUDIO LEFT  
4 COMP VIDEO  
5 GND  
6 N.C.  
7 +12 VOLT POWER  
8 AUDIO RIGHT

EXTERNAL DISK ...DB23 FEMALE

-----  
For A1000, A500, A2000 and A3000 with A2000 and A3000 differences noted.

1	RDY*	13	SIDEB*
2	DKRD*	14	WPRO*
3	GND	15	TK0*
4	GND	16	DKWEB*
5	GND	17	DKWDB*
6	GND	18	STEPB*
7	GND	19	DIRB
8	MTRXD*	20	SEL3B* (A2000/A3000 not used (1))
9	SEL2B* (A2000/A3000 SEL3B* (1))	21	SEL1B* (A2000/A3000 SEL2B* (1))
10	DRESB*	22	INDEX*
11	CHNG*	23	+12
12	+5		

(1) SEL1B\* is not drive 1, but rather the first external drive. Not all select lines may be implemented.

EXTERNAL SCSI DISK DB25 FEMALE (A3000 ONLY)

1	REQ	14	GROUND
2	MSG*	15	C/D
3	I/O	16	GROUND
4	RST*	17	ATN*
5	ACK*	18	GROUND
6	BSY*	19	SEL*
7	GROUND	20	PARITY
8	DATA0	21	DATA1
9	GROUND	22	DATA2
10	DATA3	23	DATA4
11	DATA5	24	GROUND
12	DATA6	25	TERMINATION POWER
13	DATA7		

See the ANSI (American National Standard Institute ) standard SCSI (Small Computer Standard Interface) Specification for more information.

RAMEX ...60 PIN EDGE (.156) (P1) (A1000 only)

1	gnd	A	gnd
2	D15	B	D14
3	+5	C	+5
4	D12	D	D13
5	gnd	E	gnd
6	D11	F	D10
7	+5	H	+5
8	D8	J	D9
9	gnd	K	gnd
10	D7	L	D6
11	+5	M	+5
12	D4	N	D5
13	gnd	P	gnd
14	D3	R	D2
15	+5	S	+5
16	D0	T	D1
17	gnd	U	gnd
18	DRA4	V	DRA3
19	DRA5	W	DRA2
20	DRA6	X	DRA1
21	DRA7	Y	DRA0
22	gnd	Z	gnd
23	RAS*	AA	RRW*
24	gnd	BB	gnd
25	gnd	CC	gnd
26	CASU0*	DD	CASU1*
27	gnd	EE	gnd
28	CASL0*	FF	CASL1*
29	+5	HH	+5
30	+5	JJ	+5

EXPANSION ...86 PIN EDGE (.1) (P2)

See Appendix K for the 100 pin Zorro II and Zorro III bus connector

PIN	A500	A1000	A2000	A2000b	FUNCTION
1	x	x	x	x	ground
2	x	x	x	x	ground
3	x	x	x	x	ground
4	x	x	x	x	ground
5	x	x	x	x	+5VDC
6	x	x	x	x	+5VDC
7	x	x	x	x	No Connect
8	x	x	x	x	-5VDC
9	x	x			No Connect
			x	x	28MHz Clock
10	x	x	x	x	+12VDC
11	x	x	x		No Connect
				x	/COPCFG (Configuration Out)
12	x	x	x	x	CONFIG IN, Grounded
13	x	x	x	x	Ground
14	x	x	x	x	/C3 Clock
15	x	x	x	x	CDAC Clock
16	x	x	x	x	/C1 Clock
17	x	x	x	x	/OVR
18	x	x	x	x	RDY
19	x	x	x	x	/INT2
20		x			/PALOPE
	x		x		No Connect
				x	/BOSS
21	x	x	x	x	A5
22	x	x	x	x	/INT6
23	x	x	x	x	A6
24	x	x	x	x	A4
25	x	x	x	x	ground
26	x	x	x	x	A3
27	x	x	x	x	A2
28	x	x	x	x	A7
29	x	x	x	x	A1
30	x	x	x	x	A8
31	x	x	x	x	FC0
32	x	x	x	x	A9
33	x	x	x	x	FC1
34	x	x	x	x	A10
35	x	x	x	x	FC2
36	x	x	x	x	A11
37	x	x	x	x	Ground
38	x	x	x	x	A12
39	x	x	x	x	A13
40	x	x	x	x	/IPL0
41	x	x	x	x	A14
42	x	x	x	x	/IPL1
43	x	x	x	x	A15
44	x	x	x	x	/IPL2
45	x	x	x	x	A16
46	x	x	x	x	BEER*
47	x	x	x	x	A17
48	x	x	x	x	/VPA
49	x	x	x	x	Ground
50	x	x	x	x	E Clock



EXPANSION ...86 PIN EDGE (.1) (P2) (cont.)

PIN	A500	A1000	A2000	A2000b	FUNCTION
51	x	x	x	x	/VMA
52	x	x	x	x	A18
53	x	x	x	x	RST
54	x	x	x	x	A19
55	x	x	x	x	/HLT
56	x	x	x	x	A20
57	x	x	x	x	A22
58	x	x	x	x	A21
59	x	x	x	x	A23
60	x	x	x		/BR
				x	/CBR
61	x	x	x	x	Ground
62	x	x	x	x	/BGACK
63	x	x	x	x	D15
64	x	x	x		/BG
				x	/CBG
65	x	x	x	x	D14
66	x	x	x	x	/DTACK
67	x	x	x	x	D13
68	x	x	x	x	R/W
69	x	x	x	x	D12
70	x	x	x	x	/LDS
71	x	x	x	x	D11
72	x	x	x	x	/UDS
73	x	x	x	x	Ground
74	x	x	x	x	/AS
75	x	x	x	x	D0
76	x	x	x	x	D10
77	x	x	x	x	D1
78	x	x	x	x	D9
79	x	x	x	x	D2
80	x	x	x	x	D8
81	x	x	x	x	D3
82	x	x	x	x	D7
83	x	x	x	x	D4
84	x	x	x	x	D6
85	x	x	x	x	Ground
86	x	x	x	x	D5

JOY STICKS ...DB9 male

USAGE	JOYSTICK	MOUSE
1	FORWARD*	(MOUSE V)
2	BACK*	(MOUSE H)
3	LEFT*	(MOUSE VQ)
4	RIGHT*	(MOUSE HQ)
5	POT X	(or button 3 ... if used )
6	FIRE*	(or button 1)
7	+5	
8	GND	
9	POT Y	(or button 2 )

## PART 2 - EXPLANATION OF AMIGA I/O CONNECTORS

### *Parallel Connector Interface Specification*

The 25-pin D-type connector with pins (DB25P=male for the A1000, female for A500/A2000 and IBM compatibles) at the rear of the Amiga is nominally used to interface to parallel printers. In this capacity, data flows from the Amiga to the printer. This interface may also be used for input or bidirectional data transfers. The implementation is similar to Centronics, but the pin assignment and drive characteristics vary significantly from that specification (see Pin Assignment). Signal names correspond to those used in the other places in this appendix, when possible.

#### PARALLEL PORT (J8)

NAME	DIR	NOTES
DRDY*	O	Output-data-ready signal to parallel device in output mode, used in conjunction with ACK* (pin 10) for a two-line asynchronous handshake. Functions as input data accepted from Amiga in input mode (similar to ACK* in output mode). See timing diagrams in the following section.
D0	I/O	+
D1	I/O	
D2	I/O	
D3	I/O	D0-D7 comprise an eight-bit bidirectional bus
D4	I/O	for communication with parallel devices,
D5	I/O	nominally, a printer.
D6	I/O	
D7	I/O	+
ACK*	I	Output-data-acknowledge from parallel device in output mode, used in conjunction with DRDY* (pin 1) for a two-line asynchronous handshake. Functions as input-data-ready from parallel device in input mode (similar to DRDY* in output mode). See timing diagrams. The 8520 can be programmed to conditionally generate a level 2 interrupt to the 680x0 whenever the ACK* input goes active.
BUSY	I/O	This is a general purpose I/O pin also connected to a serial data I/O pin (serial clock on pin 12). Note: Nominally used to indicate printer buffer full.
POUT	I/O	This is a general purpose I/O pin to a serial clock I/O pin (serial data on pin 11). Note: Nominally used to indicate printer paper out.
SEL	I/O	This is a general purpose I/O pin. Note: nominally a select output from the parallel device to the Amiga. On the A500/A2000 also shared with RS232 "ring indicator" signal.
RESET*	O	Amiga system reset

PARALLEL CONNECTOR INTERFACE TIMING, OUTPUT CYCLE

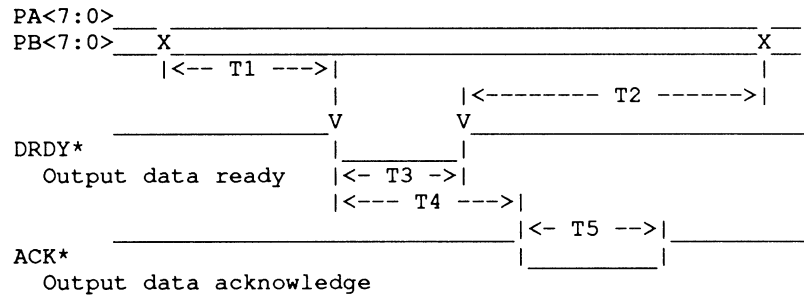

Microseconds			
Min	Typ	Max	
T1: 4.3	-x-	5.3	Output data setup to ready delay.
T2: nsp	-x-	upc	Output data hold time.
T3: nsp	1.4	nsp	Output data ready width.
T4: 0	-x-	upc	Ready to acknowledge delay.
T5: nsp	-x-	upc	Acknowledge width.

nsp = not specified  
upc = under program control

PARALLEL CONNECTOR INTERFACE TIMING, INPUT CYCLE

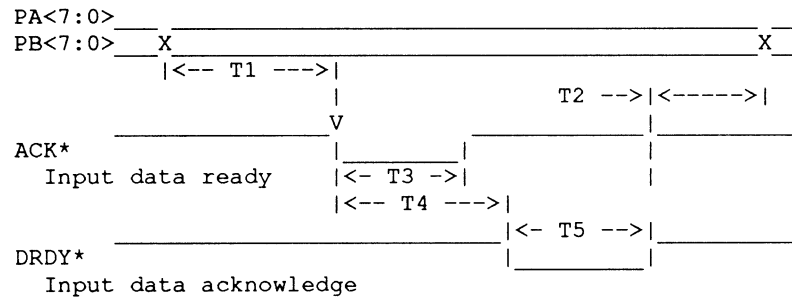

Microseconds			
Min	Typ	Max	
T1: 0	-x-	upc	Input data setup time.
T2: nsp	-x-	upc	Input data hold time.
T3: nsp	-x-	upc	Input data ready width.
T4: upc	-x-	upc	Input data ready to data acknowledge delay.
T5: nsp	1.4	nsp	Input data acknowledge width.

nsp = not specified  
upc = under program control

## Serial Interface Connector Specification

This 25-pin D-type connector with sockets (DB25S=female) is used to interface to RS-232-C standard signals. Signal names correspond to those used in other places in this appendix, when possible.

**WARNING:** Pins on the RS232 connector other than these standard ones described below may be connected to power or other non-RS232 standard signals. When making up RS232 cables, connect only those pins actually used for a particular application. Avoid generic 25-connector "straight- thru" cables.

### SERIAL INTERFACE CONNECTOR PIN ASSIGNMENT (J6)

#### RS-232-C

NAME	DIR	STD	NOTES
FGND		y	Frame ground -- do not tie to signal ground
TXD	O	y	Transmit data
RXD	I	y	Receive data
RTS	O	y	Request to send
CTS	I	y	Clear to send
DSR	I	y	Data set ready
GND		y	Signal ground -- do not tie to frame ground
CD	I	y	Carrier detect
-5V		n*	50 ma maximum *** WARNING -5V ***
AUDO	O	n*	Audio output from left (channels 0, 3) port, intended to send audio to the modem.
AUDI	I	n*	Audio input to right (channels 1, 2) port, intended to receive audio from the modem; this input is mixed with the analog output of the right (channels 1, 2). It is not digitized or used by the computer in any way.
DTR	O	y	Data terminal ready.
RI	I	y	Ring Indicator (A500/A2000 only) shared with printer "select" signal.
RESB*	O	n*	Amiga system reset.

#### NOTES:

n\*: See warning above  
See part 1 of this appendix for pin numbers.

## SERIAL INTERFACE CONNECTOR TIMING

Maximum operating frequency is 19.2 KHz. Refer to EIA standard RS-232-C for operating and installation specifications. A rate of 31.25 KHz will be supported through the use of a MIDI adapter.

Modem control signals (CTS, RTS, DTR, DSR, CD) are completely under software control. The modem control lines have no hardware affect on and are completely asynchronous to TXD and RXD.

## SERIAL INTERFACE CONNECTOR ELECTRICAL CHARACTERISTICS

OUTPUTS	MIN	TYP	MAX		
-----	---	---	---		
V <sub>o</sub> (-):	-13.2	-x-	-2.5	V	Negative output voltage range
V <sub>o</sub> (+):	8.0	-x-	13.2	V	Positive output voltage range
I <sub>o</sub> :	-x-	-x-	10.0	ma	Output current
INPUTS	MIN	TYP	MAX		
-----	---	---	---		
V <sub>i</sub> (+):	3.0	-x-	25.0	V	Positive input voltage range
V <sub>i</sub> (-):	-25.0	-x-	0.5	V	Negative input voltage range
V <sub>hys</sub> :	-x-	1.0	-x-	V	Input hysteresis voltage
I <sub>i</sub> :	0.3	-x-	10.0	ma	Input current

Unconnected inputs are interpreted the same as positive input voltages.

## ***Game Controller Connector Interface Specification***

The two 9-pin D-type connectors with pins (male) are used to interface to four types of devices:

1. Mouse or trackball, 3 buttons max.
2. Digital joystick, 2 buttons max.
3. Proportional (pot or proportional joystick), 2 buttons max.
4. Light pen, including pen-pressed-to-screen button.

The connector pin assignments are discussed in sections organized by similar hardware and/or software operating requirements as shown in the previous list. Signal names follow those used elsewhere in this appendix, when possible.

J11 is the right controller port connector (JOY1DAT, POT1DAT).

J12 is the left controller port connector (JOY0DAT, POT0DAT).

**NOTE:** While most of the hardware discussed below is directly accessible, hardware should be accessed through ROM kernel software. This will keep future hardware changes transparent to the user.

## GAME CONTROLLER INTERFACE TO MOUSE/TRACKBALL QUADRATURE INPUTS

A mouse or trackball is a device that translates planar motion into pulse trains. Quadrature techniques are employed to preserve the direction as well as magnitude of displacement. The registers JOY0DAT and JOY1DAT become counter registers, with y displacement in the high byte and x in the low byte. Movement causes the following action:

Up: y decrements  
Down: y increments  
Right: x increments  
Left: x decrements

To determine displacement, JOYxDAT is read twice with corresponding x and y values subtracted (careful, modulo 128 arithmetic). Note that if either count changes by more than 127, both distance and direction become ambiguous. There is a relationship between the sampling interval and the maximum speed (that is, change in distance) that can be resolved as follows:

$$\text{Velocity} < \text{Distance}(\text{max}) / \text{SampleTime}$$

$$\text{Velocity} < \text{SQRT}(\text{DeltaX}^{**2} + \text{DeltaY}^{**2}) / \text{SampleTime}$$

For an Amiga with a 200 count-per-inch mouse sampling during each vertical blanking interval, the maximum velocity in either the X or Y direction becomes:

$$\text{Velocity} < (128 \text{ Counts} * 1 \text{ inch}/200 \text{ Counts}) / .017 \text{ sec} = 38 \text{ in/sec}$$

which should be sufficient for most users.

NOTE: The Amiga software is designed to do mouse update cycles during vertical blanking. The horizontal and vertical counters are always valid and may be read at any time.

## CONNECTOR PIN USAGE FOR MOUSE/TRACKBALL QUADRATURE INPUTS

PIN	MNEMONIC	DESCRIPTION	HARDWARE REGISTER/NOTES
----	-----	-----	-----
1	V	Vertical pulses	JOY[0/1]DAT<15:8>
2	H	Horizontal pulses	JOY[0/1]DAT<7:0>
3	VQ	Vertical quadrature pulses	JOY[0/1]DAT<15:8>
4	HQ	Horizontal quadrature pulses	JOY[0/1]DAT<7:0>
5	UBUT*	Unused mouse button	See Proportional Inputs.
6	LBUT*	Left mouse button	See Fire Button.
7	+5V	+5V, current limited	
8	Ground		
9	RBUT*	Right mouse button	See Proportional Inputs.

## GAME PORT INTERFACE TO DIGITAL JOYSTICKS

A joystick is a device with four normally opened switches arranged 90 degrees apart. The JOY[0/1]DAT registers become encoded switch input ports as follows:

```
Forward: bit#9 xor bit#8
Left:    bit#9
Back:    bit#1 xor bit#0
Right:   bit#1
```

Data is encoded to facilitate the mouse/trackball operating mode.

NOTE: The right and left direction inputs are also designed to be right and left buttons, respectively, for use with proportional inputs. In this case, the forward and back inputs are not used, while right and left become button inputs rather than joystick inputs.

The JOY[0/1]DAT registers are always valid and may be read at any time.

## CONNECTOR PIN USAGE FOR DIGITAL JOYSTICK INPUTS

PIN	MNEMONIC	DESCRIPTION	HARDWARE REGISTER/NOTES
1	FORWARD*	Forward joystick switch	JOY[0/1]DAT<9 xor 8>
2	BACK*	Back joystick switch	JOY[0/1]DAT(1 xor 0)
3	LEFT*	Left joystick switch	JOY[0/1]DAT<9>
4	RIGHT*	Right joystick switch	JOY[0/1]DAT<1>
5	Unused		
6	FIRE*	Left mouse button	See Fire Button.
7	+5V	125ma max, 200ma surge	Total both ports.
8	Ground		
9	Unused		

## GAME PORT INTERFACE TO FIRE BUTTONS

The fire buttons are normally opened switches routed to the 8520 adapter PRA0 as follows:

```
PRA0 bit 7 = Fire* left controller port
PRA0 bit 6 = Fire* right controller port
```

Before reading this register, the corresponding bits of the data direction register must be cleared to define input mode:

```
DDRA0<7:6> cleared as appropriate
```

NOTE: Do not disturb the settings of other bits in DDRA0 (Use of ROM kernel calls is recommended).

Fire buttons are always valid and may be read at any time.

CONNECTOR PIN USAGE FOR FIRE BUTTON INPUTS

PIN	MNEMONIC	DESCRIPTION
1	-x-	
2	-x-	
3	-x-	
4	-x-	
5	-x-	
6	FIRE*	Left mouse button/fire button
7	-x-	
8	ground	
9	-x-	

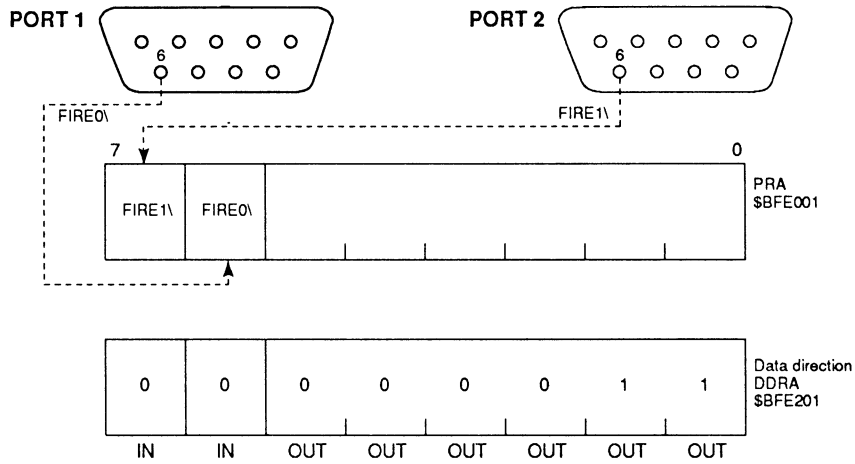

READING FIRE BUTTONS



## GAME PORT INTERFACE TO PROPORTIONAL CONTROLLERS

Resistive (potentiometer) element linear taper proportional controllers are supported up to 528k Ohms max (470k +/- 10% recommended). The JOY[0/1]DAT registers contain digital translation values for y in the high byte and x in the low byte. A higher count value indicates a higher external resistance. The Amiga performs an integrating analog-to-digital conversion as follows:

1. For the first 7 (NTSC) or 8 (PAL) horizontal display lines, the analog input capacitors are discharged and the positions counters reflected in the POT[0/1]DAT registers are held reset.

For the remainder of the display field, the input capacitors are allowed to recharge through the resistive element in the external control device.

2. The gradually increasing voltage is continuously compared to an internal reference level while counter keeps track of the number of lines since the end of the reset interval.

3. When the input voltage finally exceeds the internal threshold for a given input channel, the current counter value is latched into the POT[0/1]DAT register corresponding to that channel.

4. During the vertical blanking interval, the software examines the resulting POT[0/1]DAT register values and interprets the counts in terms of joystick position.

NOTE: The POTY and POTX inputs are designated as "right mouse button" and "unused mouse button" respectively. An opened switch corresponds to high resistance, a closed switch to a low resistance. The buttons are also available in POTGO and POTINP registers. It is recommended that ROM kernel calls be used for future hardware compatibility.

It is important to realize that the proportional controller is more of a "pointing" device than an absolute position input. It is up to the software to provide the calibration, range limiting and averaging functions needed to support the application's control requirements.

The POT[0/1]DAT registers are typically read during video blanking, but MAY be available prior to that.

CONNECTOR PIN USAGE FOR PROPORTIONAL INPUTS

PIN	MNEMONIC	DESCRIPTION	HARDWARE REGISTER/NOTES
1	XBUT	Extra Button	
2	Unused		
3	LBUT*	Left button	See Digital Joystick
4	RBUT*	Right button	See Digital Joystick
5	POTX	X analog in	POT[0/1]DAT<7:0>, POTGO, POTINP
6	Unused		
7	+5V	125ma max, 200 ma surge	
8	Ground		
9	POTY	Y analog in	POT[0,1]DAT<15:8>, POTGO, POTINP

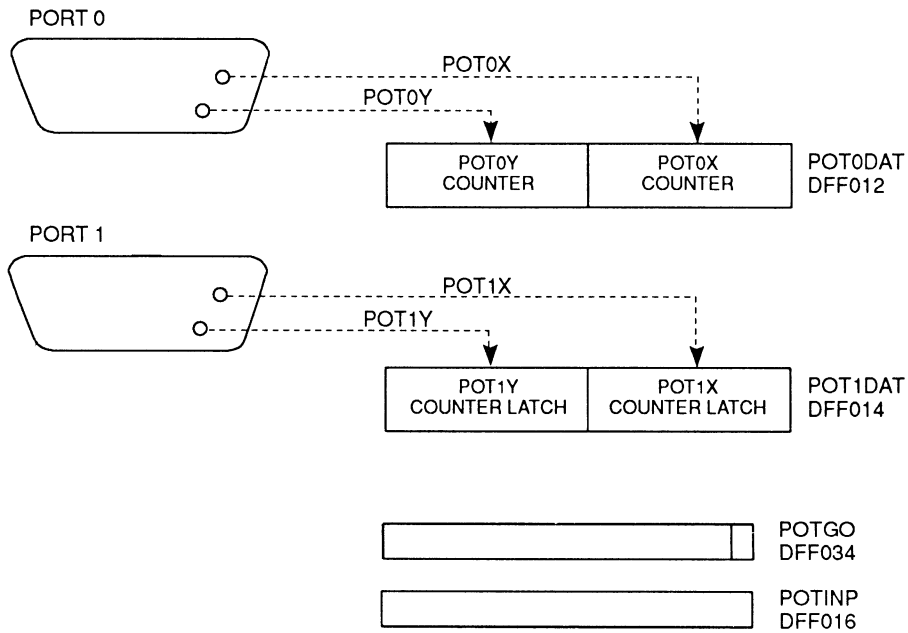

POT COUNTERS

## GAME PORT INTERFACE TO LIGHT PEN

A light pen is an optoelectronic device whose light-sensitive portion is placed in proximity to a CRT. As the electron beam sweeps past the light pen, a trigger pulse is generated which can be enabled to latch the horizontal and vertical beam positions. There is no hardware bit to indicate this trigger, but this can be determined in the two ways as shown in chapter 8, "Interface Hardware."

Light pen position is usually read during blanking, but MAY be available prior to that.

### CONNECTOR PIN USAGE FOR LIGHT PEN INPUTS

PIN	MNEMONIC	DESCRIPTION	HARDWARE REGISTER/NOTES
1	Unused		
2	Unused		
3	Unused		
4	Unused		
5	LPENPR*	Light pen pressed	See Proportional Inputs
6	LPENTG*	Light pen trigger	VPOSR, VHPOSR
7	+5V	125ma max, 200 ma surge	Both ports
8	Ground		
9	Unused		

Note: depending on the maker, the light pen input may be either.

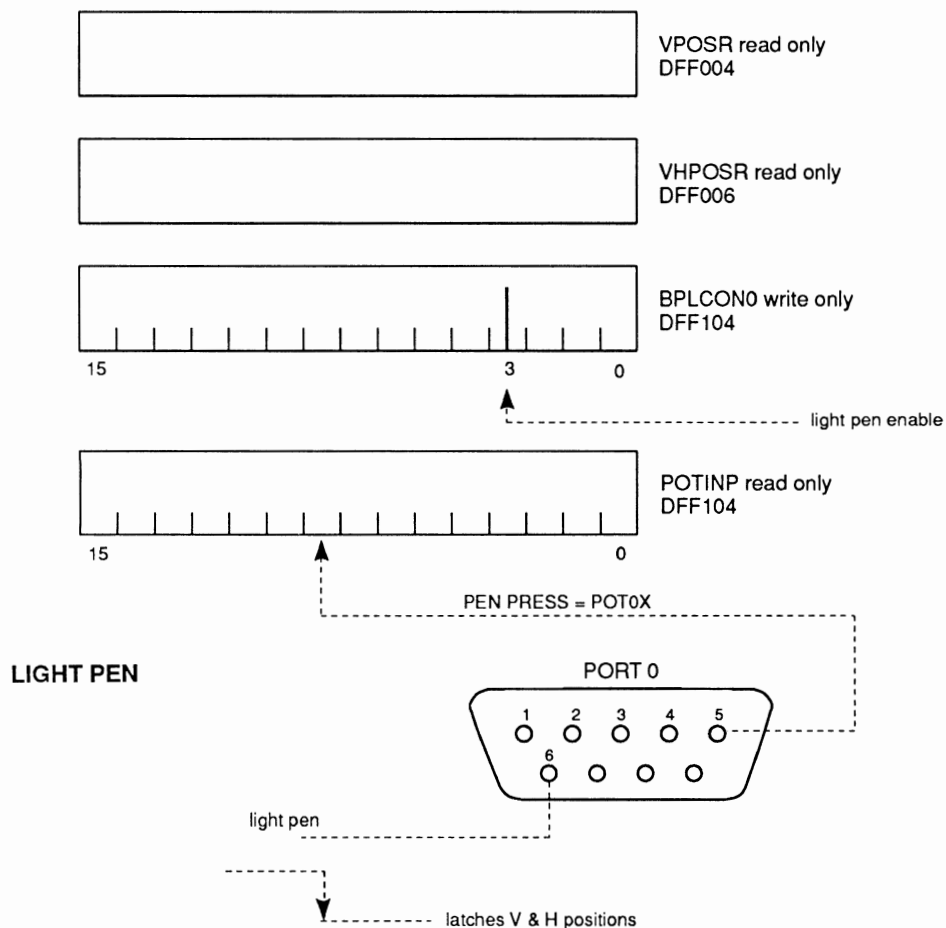

## External Disk Interface Connector Specification

The 23-pin D-type connector with sockets (DB23S) at the rear of the Amiga is nominally used to interface to MFM devices.

### EXTERNAL DISK CONNECTOR PIN ASSIGNMENT (J7)

PIN	NAME	DIR	NOTES
----	-----	----	-----
1	RDY*	I/O	If motor on, indicates disk installed and up to speed. If motor not on, identification mode. See below.
2	DKRD*	I	MFM input data to Amiga.
3	GND		
4	GND		
5	GND		
6	GND		
7	GND		
8	MTRXD*	OC	Motor on data, clocked into drive's motor-on flip-flop by the active transition of SELxB*. Guaranteed setup time is 1.4 usec. Guaranteed hold time is 1.4 usec.
9	SEL2B*	OC	Select drive 2.*
10	DRESB*	OC	Amiga system reset. Drives should reset their motor-on flip-flops and set their write-protect flip-flops.
11	CHNG*	I/O	Note: Nominally used as an open collector input. Drive's change flop is set at power up or when no disk is not installed. Flop is reset when drive is selected and the head stepped, but only if a disk is installed.
12	+5V		270 ma maximum; 410 ma surge When below 3.75V, drives are required to reset their motor-on flops, and set their write-protect flops.
13	SIDEB*	O	Side 1 if active, side 0 if inactive
14	WPRO*	I/O	Asserted by selected, write-protected disk.
15	TK0*	I/O	Asserted by selected drive when read/write head is positioned over track 0.
16	DKWEB*	OC	Write gate (enable) to drive.
17	DKWDB*	OC	MFM output data from Amiga.
18	STEPB*	OC	Selected drive steps one cylinder in the direction indicated by DIRB.
19	DIRB	OC	Direction to step the head. Inactive to step towards center of disk (higher-numbered tracks).
20	SEL3B*	OC	Select drive 3. *
21	SEL1B*	OC	Select drive 1. *
22	INDEX*	I/O	Index is a pulse generated once per disk revolution, between the end and beginning of cylinders. The 8520 can be programmed to conditionally generate a level 6 interrupt to the 680x0 whenever the INDEX* input goes active.
23	+12V		160 ma maximum; 540 ma surge.

\* Note: the drive select lines are shifted as they pass through a string of daisy chained devices. Thus the signal that appears as drive 2 select at the first drive shows up as drive 1 select at the second drive and so on...

#### EXTERNAL DISK CONNECTOR IDENTIFICATION MODE

An identification mode is provided for reading a 32-bit serial identification data stream from an external device. To initialize this mode, the motor must be turned on, then off. See pin 8, MTRXD\* for a discussion of how to turn the motor on and off. The transition from motor on to motor off reinitializes the serial shift register.

After initialization, the SELxB\* signal should be left in the inactive state.

Now enter a loop where SELxB\* is driven active, read serial input data on RDY\* (pin 1), and drive SELxB\* inactive. Repeat this loop a total of 32 times to read in 32 bits of data. The most significant bit is received first.

#### EXTERNAL DISK CONNECTOR DEFINED IDENTIFICATIONS

\$0000 0000 - no drive present.  
\$FFFF FFFF - Amiga standard 3.25 diskette.  
\$5555 5555 - 48 TPI double-density, double-sided.

As with other peripheral ID's, users should contact Commodore-Amiga for ID assignment.

The serial input data is active low and must therefore be inverted to be consistent with the above table.

#### EXTERNAL DISK CONNECTOR LIMITATIONS

1. The total cable length, including daisy chaining, must not exceed 1 meter.
2. A maximum of 3 external devices may reside on this interface, but specific implementations may support fewer external devices.
3. Each device must provide a 1000-Ohm pull-up resistor on those outputs driven by an open-collector device on the Amiga (pins 8-10, 16-21).
4. The system provides power for only the first external device in the daisy chains.

## PART 3 - INTERNAL CONNECTORS

### INTERNAL DISK ...34 PIN RIBBON (J10)

---

1	GND	18	DIRB
2	CHNG*	19	GND
3	GND	20	STEPB*
4	MTR0D*(led)	21	GND
5	GND	22	DKWDB*
6	N.C.	23	GND
7	GND	24	DKWEB*
8	INDEX*	25	GND
9	GND	26	TKO*
10	SELOB*	27	GND
11	GND	28	WPRO*
12	N.C.	29	GND
13	GND	30	DKRD*
14	N.C.	31	GND
15	GND	32	SIDEB*
16	MTR0D*	33	GND
17	GND	34	RDY*

### INTERNAL DISK POWER ...4 PIN STRAIGHT (J13)

---

1	+12 (some drives are +5 only)
2	GND
3	GND
4	+5

### INTERNAL SCSI DISK ...50 PIN CONNECTOR (A3000 MOTHERBOARD)

---

2	DATA 0	26	TERMINATION POWER
4	DATA 1	28	GROUND
6	DATA 2	30	GROUND
8	DATA 3	32	ATN*
10	DATA 4	34	N.C.
12	DATA 5	36	BSY
14	DATA 6	38	ACK*
16	DATA 7	40	RST*
18	PARITY	42	MSG*
20	GROUND	44	SEL*
22	GROUND	46	C/D
24	GROUND	48	REQ*
	50		I/O

(ALL ODD-NUMBERED PINS, EXCEPT PIN 25, ARE CONNECTED TO GROUND. PIN 25 IS OPEN)  
See the ANSI standard SCSI (Small Computer Standard Interface) Specification  
for more information.

## PART 4 - PORT SIGNAL ASSIGNMENTS FOR 8520 CIAS

CIA-A Address BFE<sub>x</sub>01 data bits 7-0 (A12\*) (int2)

-----

PA7..game port 1, pin 6 (fire button\*)  
PA6..game port 0, pin 6 (fire button\*)  
PA5..RDY\* disk ready\*  
PA4..TK0\* disk track 00\*  
PA3..WPRO\* write protect\*  
PA2..CHNG\* disk change\*  
PA1..LED\* led light (0=bright) / audio filter control (A500 & A2000)  
PA0..OVL ROM/RAM overlay bit

SP...KDAT keyboard data  
CNT..KCLK keyboard clock  
PB7..P7 data 7  
PB6..P6 data 6  
PB5..P5 data 5 Centronics parallel interface  
PB4..P4 data 4 data  
PB3..P3 data 3  
PB2..P2 data 2  
PB1..P1 data 1  
PB0..P0 data 0

PC...drdy\* Centronics control  
F....ack\*

CIA-B Address BFD<sub>x</sub>00 data bits 15-8 (A13\*) (int6)

-----

PA7..com line DTR\*, driven output  
PA6..com line RTS\*, driven output  
PA5..com line carrier detect\*  
PA4..com line CTS\*  
PA3..com line DSR\*  
PA2..SEL Centronics control  
PA1..POUT +--- paper out -----+  
PA0..BUSY | +--busy -----+ |  
| | | | |  
SP...BUSY | +- commodore serial bus + |  
CNT..POUT +----commodore serial bus --+

PB7..MTR\* motor  
PB6..SEL3\* select external 3rd drive  
PB5..SEL2\* select external 2nd drive  
PB4..SEL1\* select external 1st drive  
PB3..SELO\* select internal drive  
PB2..SIDE\* side select\*  
PB1..DIR direction  
PB0..STEP\* step\*

PC...not used  
F....INDEX\* disk index pulse\*





# appendix F

## 8520 COMPLEX INTERFACE ADAPTERS

This appendix contains information about the 8520 Complex Interface Adapter (CIA) chips which handle the serial, parallel, keyboard and other Amiga I/O activities. Each Amiga system contains two 8520 Complex Interface Adapter (CIA) chips. Each chip has 16 general purpose input/output pins, plus a serial shift register, three timers, an output pulse pin and an edge detection input. In the Amiga system various tasks are assigned to the chip's capabilities as follows:

### CIAA Address Map

Byte Address	Register Name	7	6	5	4	3	2	1	0
BFE001	pra	/FIR1	/FIR0	/RDY	/TK0	/WPRO	/CHNG	/LED	OVL
BFE101	prb	Parallel port							
BFE201	ddra	Direction for port A (BFE001);1=output (set to 0x03)							
BFE301	ddrb	Direction for port B (BFE101);1=output (can be in or out)							
BFE401	talo	CIAA timer A low byte (.715909 Mhz NTSC; .709379 Mhz PAL)							
BFE501	tahi	CIAA timer A high byte							
BFE601	tblo	CIAA timer B low byte (.715909 Mhz NTSC; .709379 Mhz PAL)							
BFE701	tbhi	CIAA timer B high byte							
BFE801	todlo	50/60 Hz event counter bits 7-0 (VSync or line tick)							
BFE901	todmid	50/60 Hz event counter bits 15-8							
BFEA01	todhi	50/60 Hz event counter bits 23-16							
BFEB01		not used							
BFEC01	sdr	CIAA serial data register (connected to keyboard)							
BFED01	icr	CIAA interrupt control register							
BFEE01	cra	CIAA control register A							
BFEF01	crb	CIAA control register B							

Note: CIAA can generate interrupt INT2.

## CIAB Address Map

Byte Address	Register Name	7	6	5	4	3	2	1	0
BFD000	pra	/DTR	/RTS	/CD	/CTS	/DSR	SEL	POUT	BUSY
BFD100	prb	/MTR	/SEL3	/SEL2	/SEL1	/SEL0	/SIDE	DIR	/STEP
BFD200	ddra	Direction for Port A (BFD000); 1 = output (set to 0xFF)							
BFD300	ddrb	Direction for Port B (BFD100); 1 = output (set to 0xFF)							
BFD400	talo	CIAB timer A low byte (.715909 Mhz NTSC; .709379 Mhz PAL)							
BFD500	tahi	CIAB timer A high byte							
BFD600	tblo	CIAB timer B low byte (.715909 Mhz NTSC; .709379 Mhz PAL)							
BFD700	tbhi	CIAB timer B high byte							
BFD800	todlo	Horizontal sync event counter bits 7-0							
BFD900	todmid	Horizontal sync event counter bits 15-8							
BFDA00	todhi	Horizontal sync event counter bits 23-16							
BFDB00		not used							
BFDC00	sdr	CIAB serial data register (unused)							
BFDD00	icr	CIAB interrupt control register							
BFDE00	cra	CIAB Control register A							
BFDF00	crb	CIAB Control register B							

Note: CIAB can generate INT6.

## Chip Register Map

Each 8520 has 16 registers that you may read or write. Here is the list of registers and the access address of each within the memory space dedicated to the 8520:

RS3	RS2	RS1	RS0	Register # (hex)	NAME	MEANING
0	0	0	0	0	pra	Peripheral data register A
0	0	0	1	1	prb	Peripheral data register B
0	0	1	0	2	ddra	Data direction register A
0	0	1	1	3	ddrb	Direction register B
0	1	0	0	4	talo	Timer A low register
0	1	0	1	5	tahi	Timer A high register
0	1	1	0	6	tblo	Timer B low register
0	1	1	1	7	tbhi	Timer B high register
1	0	0	0	8	todlow	Event LSB
1	0	0	1	9	todmid	Event 8-15
1	0	1	0	A	todhi	Event MSB
1	0	1	1	B		No connect
1	1	0	0	C	sdr	Serial data register
1	1	0	1	D	icr	Interrupt control register
1	1	1	0	E	cra	Control register A
1	1	1	1	F	crb	Control register B

---

## Register Functional Description

### I/O PORTS (PRA, PRB, DDRA, DDRB)

Ports A and B each consist of an 8-bit peripheral data register (PR) and an 8-bit data direction register (DDR). If a bit in the DDR is set to a 1, the corresponding bit position in the PR becomes an output. If a DDR bit is set to a 0, the corresponding PR bit is defined as an input.

When you READ a PR register, you read the actual current state of the I/O pins (PA0-PA7, PB0-PB7, regardless of whether you have set them to be inputs or outputs.

Ports A and B have passive pull-up devices as well as active pull-ups, providing both CMOS and TTL compatibility. Both ports have two TTL load drive capability.

In addition to their normal I/O operations, ports PB6 and PB7 also provide timer output functions.

### HANDSHAKING

Handshaking occurs on data transfers using the PC output pin and the FLAG input pin. PC will go low on the third cycle after a port B access. This signal can be used to indicate “data ready” at port B or “data accepted” from port B. Handshaking on 16-bit data transfers (using both ports A and B) is possible by always reading or writing port A first. FLAG is a negative edge-sensitive input that can be used for receiving the PC output from another 8520 or as a general- purpose interrupt input. Any negative transition on FLAG will set the FLAG interrupt bit.

REG	NAME	D7	D6	D5	D4	D3	D2	D1	D0
0	PRA	PA7	PA6	PA5	PA4	PA3	PA2	PA1	PA0
1	PRB	PB7	PB6	PB5	PB4	PB3	PB2	PB1	PB0
2	DDRA	DPA7	DPA6	DPA5	DPA4	DPA3	DPA2	DPA1	DPA0
3	DDRB	DPB7	DPB6	DPB5	DPB4	DPB3	DPB2	DPB1	DPB0

### INTERVAL TIMERS (TIMER A, TIMER B)

Each interval timer consists of a 16-bit read-only timer counter and a 16-bit write-only timer latch. Data written to the timer is latched into the timer latch, while data read from the timer is the present contents of the timer counter.

The latch is also called a prescaler in that it represents the countdown value which must be counted before the timer reaches an underflow (no more counts) condition. This latch (prescaler) value is a divider of the input clocking frequency. The timers can be used independently or linked for extended operations. Various timer operating modes allow generation of long time delays, variable width pulses, pulse trains, and variable frequency waveforms. Utilizing the CNT input,

---

the timers can count external pulses or measure frequency, pulse width, and delay times of external signals.

Each timer has an associated control register, providing independent control over each of the following functions:

### ***Start/Stop***

A control bit allows the timer to be started or stopped by the microprocessor at any time.

### ***PB on/off***

A control bit allows the timer output to appear on a port B output line (PB6 for timer A and PB7 for timer B). This function overrides the DDRB control bit and forces the appropriate PB line to become an output.

### ***Toggle/pulse***

A control bit selects the output applied to port B while the PB on/off bit is ON. On every timer underflow, the output can either toggle or generate a single positive pulse of one cycle duration. The toggle output is set high whenever the timer is started, and set low by RES.

### ***One-shot/continuous***

A control bit selects either timer mode. In one-shot mode, the timer will count down from the latched value to zero, generate an interrupt, reload the latched value, then stop. In continuous mode, the timer will count down from the latched value to zero, generate an interrupt, reload the latched value, and repeat the procedure continuously.

In one-shot mode, a write to timer-high (register 5 for timer A, register 7 for Timer B) will transfer the timer latch to the counter and initiate counting regardless of the start bit.

### ***Force load***

A strobe bit allows the timer latch to be loaded into the timer counter at any time, whether the timer is running or not.

---

## INPUT MODES

Control bits allow selection of the clock used to decrement the timer. Timer A can count 02 clock pulses or external pulses applied to the CNT pin. Timer B can count 02 pulses, external CNT pulses, timer A underflow pulses, or timer A underflow pulses while the CNT pin is held high.

The timer latch is loaded into the timer on any timer underflow, on a force load, or following a write to the high byte of the pre- scalar while the timer is stopped. If the timer is running, a write to the high byte will load the timer latch but not the counter.

## BIT NAMES on READ-Register

REG	NAME	D7	D6	D5	D4	D3	D2	D1	D0
4	TALO	TAL7	TAL6	TAL5	TAL4	TAL3	TAL2	TAL1	TAL0
5	TAHI	TAH7	TAH6	TAH5	TAH4	TAH3	TAH2	TAH1	TAH0
6	TBLO	TBL7	TBL6	TBL5	TBL4	TBL3	TBL2	TBL1	TBL0
7	TBHI	TBH7	TBH6	TBH5	TBH4	TBH3	TBH2	TBH1	TBH0

## BIT NAMES on WRITE-Register

REG	NAME	D7	D6	D5	D4	D3	D2	D1	D0
4	TALO	PAL7	PAL6	PAL5	PAL4	PAL3	PAL2	PAL1	PAL0
5	TAHI	PAH7	PAH6	PAH5	PAH4	PAH3	PAH2	PAH1	PAH0
6	TBLO	PBL7	PBL6	PBL5	PBL4	PBL3	PBL2	PBL1	PBL0
7	TBHI	PBH7	PBH6	PBH5	PBH4	PBH3	PBH2	PBH1	PBH0

---

## Time of Day Clock

TOD consists of a 24-bit binary counter. Positive edge transitions on this pin cause the binary counter to increment. The TOD pin has a passive pull-up on it.

A programmable alarm is provided for generating an interrupt at a desired time. The alarm registers are located at the same addresses as the corresponding TOD registers. Access to the alarm is governed by a control register bit. The alarm is write-only; any read of a TOD address will read time regardless of the state of the ALARM access bit.

A specific sequence of events must be followed for proper setting and reading of TOD. TOD is automatically stopped whenever a write to the register occurs. The clock will not start again until after a write to the LSB event register. This assures that TOD will always start at the desired time.

Since a carry from one stage to the next can occur at any time with respect to a read operation, a latching function is included to keep all TOD information constant during a read sequence. All TOD registers latch on a read of MSB event and remain latched until after a read of LSB event. The TOD clock continues to count when the output registers are latched. If only one register is to be read, there is no carry problem and the register can be read "on the fly" provided that any read of MSB event is followed by a read of LSB Event to disable the latching.

### BIT NAMES for WRITE TIME/ALARM or READ TIME

REG	NAME								
8	LSB Event	E7	E6	E5	E4	E3	E2	E1	E0
9	Event 8-15	E15	E14	E13	E12	E11	E10	E9	E8
A	MSB Event	E23	E22	E21	E20	E19	E18	E17	E16

WRITE  
CRB7 = 0  
CRB7 = 1 ALARM

---

## Serial Shift Register (SDR)

The serial port is a buffered, 8-bit synchronous shift register. A control bit selects input or output mode. In the Amiga system one shift register is used for the keyboard, and the other is unassigned. Note that the RS-232 compatible serial port is controlled by the Paula chip; see chapter 8 for details.

### INPUT MODE

In input mode, data on the SP pin is shifted into the shift register on the rising edge of the signal applied to the CNT pin. After eight CNT pulses, the data in the shift register is dumped into the serial data register and an interrupt is generated.

### OUTPUT MODE

In the output mode, Timer A is used as the baud rate generator. Data is shifted out on the SP pin at 1/2 the underflow rate of Timer A. The maximum baud rate possible is 02 divided by 4, but the maximum usable baud rate will be determined by line loading and the speed at which the receiver responds to input data.

To begin transmission, you must first set up Timer A in continuous mode, and start the timer. Transmission will start following a write to the serial data register. The clock signal derived from Timer A appears as an output on the CNT pin. The data in the serial data register will be loaded into the shift register, then shifted out to the SP pin when a CNT pulse occurs. Data shifted out becomes valid on the next falling edge of CNT and remains valid until the next falling edge.

After eight CNT pulses, an interrupt is generated to indicate that more data can be sent. If the serial data register was reloaded with new information prior to this interrupt, the new data will automatically be loaded into the shift register and transmission will continue.

If no further data is to be transmitted after the eighth CNT pulse, CNT will return high and SP will remain at the level of the last data bit transmitted.

SDR data is shifted out MSB first. Serial input data should appear in this same format.

---

## BIDIRECTIONAL FEATURE

The bidirectional capability of the shift register and CNT clock allows many 8520s to be connected to a common serial communications bus on which one 8520 acts as a master, sourcing data and shift clock, while all other 8520 chips act as slaves. Both CNT and SP outputs are open drain to allow such a common bus. Protocol for master/slave selection can be transmitted over the serial bus or via dedicated handshake lines.

REG	NAME	D7	D6	D5	D4	D3	D2	D1	D0
C	SDR	S7	S6	S5	S4	S3	S2	S1	S0

## Interrupt Control Register (ICR)

There are five sources of interrupts on the 8520:

- Underflow from Timer A (timer counts down past 0)
- Underflow from Timer B
- TOD alarm
- Serial port full/empty
- Flag

A single register provides masking and interrupt information. The interrupt control register consists of a write-only MASK register and a read-only DATA register. Any interrupt will set the corresponding bit in the DATA register. Any interrupt that is enabled by a 1-bit in that position in the MASK will set the IR bit (MSB) of the DATA register and bring the IRQ pin low. In a multichip system, the IR bit can be polled to detect which chip has generated an interrupt request.

When you read the DATA register, its contents are cleared (set to 0), and the IRQ line returns to a high state. Since it is cleared on a read, you must assure that your interrupt polling or interrupt service code can preserve and respond to all bits which may have been set in the DATA register at the time it was read. With proper preservation and response, it is easily possible to intermix polled and direct interrupt service methods.

You can set or clear one or more bits of the MASK register without affecting the current state of any of the other bits in the register. This is done by setting the appropriate state of the MSBbit, which is called the set/clear bit. In bits 6-0, you yourself form a mask that specifies which of the bits you wish to affect. Then, using bit 7, you specify HOW the bits in corresponding positions in the mask are to be affected.



- If bit 7 is a 1, then any bit 6-0 in your own mask byte which is set to a 1 sets the corresponding bit in the MASK register. Any bit that you have set to a 0 causes the MASK register bit to remain in its current state.
- If bit 7 is a 0, then any bit 6-0 in your own mask byte which is set to a 1 clears the corresponding bit in the MASK register. Again, any 0 bit in your own mask byte causes no change in the contents of the corresponding MASK register bit.

If an interrupt is to occur based on a particular condition, then that corresponding MASK bit must be a 1.

Example: Suppose you want to set the Timer A interrupt bit (enable the Timer A interrupt), but want to be sure that all other interrupts are cleared. Here is the sequence you can use:

```
INCLUDE "hardware/cia.i"
XREF   _ciaa           ; From amiga.lib
lea    _ciaa,a0       ; Defined in amiga.lib
move.b #%01111110,ciaicr(a0)
```

MSB is 0, means clear any bit whose value is 1 in the rest of the byte

```
INCLUDE "hardware/cia.i"
XREF   _ciaa           ; From amiga.lib
lea    _ciaa,a0       ; Defined in amiga.lib
move.b #%10000001,ciaicr(a0)
```

MSB is 1, means set any bit whose value is 1 in the rest of the byte (do not change any values wherein the written value bit is a zero)

## READ INTERRUPT CONTROL REGISTER

REG	NAME	D7	D6	D5	D4	D3	D2	D1	D0
D	ICR	IR	0	0	FLG	SP	ALRM	TB	TA

## WRITE INTERRUPT CONTROL MASK

REG	NAME	D7	D6	D5	D4	D3	D2	D1	D0
D	ICR	S/C	x	x	FLG	SP	ALRM	TB	TA

---

## Control Registers

There are two control registers in the 8520, CRA and CRB. CRA is associated with Timer A and CRB is associated with Timer B. The format of the registers is as follows:

### CONTROL REGISTER A

BIT	NAME	FUNCTION
0	START	1 = start Timer A, 0 = stop Timer A. This bit is automatically reset (= 0) when underflow occurs during one-shot mode.
1	PBON	1 = Timer A output on PB6, 0 = PB6 is normal operation.
2	OUTMODE	1 = toggle, 0 = pulse.
3	RUNMODE	1 = one-shot mode, 0 = continuous mode.
4	LOAD	1 = force load (this is a strobe input, there is no data storage; bit 4 will always read back a zero and writing a 0 has no effect.)
5	INMODE	1 = Timer A counts positive CNT transitions, 0 = Timer A counts 02 pulses.
6	SPMODE	1 = Serial port=output (CNT is the source of the shift clock) 0 = Serial port=input (external shift clock is required)
7	UNUSED	

## BITMAP OF REGISTER CRA

```

REG# NAME  UNUSED  SPMODE  INMODE  LOAD  RUNMODE  OUTMODE  PBON  START
E   CRA   unused  0=input 0=02  1=force 0=cont. 0=pulse 0=PB6OFF 0=stop
      unused 1=output 1=CNT  load  1=one- 1=toggle 1=PB6ON 1=start
                        (strobe)  shot

                        |<----- Timer A Variables ----->|

```

All unused register bits are unaffected by a write and forced to 0 on a read.

### CONTROL REGISTER B:

BIT NAME FUNCTION

```

0   START  1 = start Timer B, 0 = stop Timer B.
          This bit is automatically reset (= 0) when
          underflow occurs during one-shot mode.
1   PBON   1 = Timer B output on PB7, 0 = PB7 is normal
          operation.
2   OUTMODE 1 = toggle, 0 = pulse.
3   RUNMODE 1 = one-shot mode, 0 = continuous mode.
4   LOAD    1 = force load (this is a strobe input, there is no
          data storage; bit 4 will always read back a
          zero and writing a 0 has no effect.)

```

6,5 INMODE Bits CRB6 and CRB5 select one of four possible input modes for Timer B, as follows:

CRB6	CRB5	Mode Selected
0	0	Timer B counts 02 pulses
0	1	Timer B counts positive CNT transitions
1	0	Timer B counts Timer A underflow pulses
1	1	Timer B counts Timer A underflow pulses while CNT pin is held high.

```

7   ALARM  1 = writing to TOD registers sets Alarm
          0 = writing to TOD registers sets TOD clock.
          Reading TOD registers always reads TOD clock,
          regardless of the state of the Alarm bit.

```

---

## BITMAP OF REGISTER CRB

```
REG
#  NAME ALARM      INMODE   LOAD      RUNMODE  OUTMODE  PBON      START
F  CRB  0=TOOD      00=02    1=force   0=cont.  0=pulse  0=PB7OFF 0=stop
      1=Alarm    01=CNT   load     1=one-   1=toggle 1=PB7ON  1=start
              10=Timer A (strobe) shot
              11=CNT+
                Timer A
                |<-----Timer B Variables----->|
```

All unused register bits are unaffected by a write and forced to 0 on a read.

## Port Signal Assignments

This part specifies how various signals relate to the available ports of the 8520. This information enables the programmer to relate the port addresses to the outside-world items (or internal control signals) which are to be affected. This part is primarily for the use of the systems programmer and should generally not be used by applications programmers. Systems software normally is configured to handle the setting of particular signals, no matter how the physical connections may change.

*Warning:* In a multitasking operating system, many different tasks may be competing for the use of the system resources. Applications programmers should follow the established rules for resource access in order to assure compatibility of their software with the system.

CIA-A Address BFEr01 data bits 7-0 (A12\*) (INT2)

PA7..game port 1, pin 6 (fire button\*)  
PA6..game port 0, pin 6 (fire button\*)  
PA5..RDY\* disk ready\*  
PA4..TK0\* disk track 00\*  
PA3..WPRO\* write protect\*  
PA2..CHNG\* disk change\*  
PA1..LED\* led light (0=bright)  
PA0..OVL memory overlay bit  
SP...KDAT keyboard data  
CNT..KCLK  
PB7..P7 data 7  
PB6..P6 data 6  
PB5..P5 data 5 Centronics parallel interface  
PB4..P4 data 4 data  
PB3..P3 data 3  
PB2..P2 data 2  
PB1..P1 data 1  
PB0..P0 data 0  
PC...drdy\* centronics control  
F....ack\*

CIA-B Address BFDr00 data bits 15-8 (A13\*) (INT6)

PA7..com line DTR\*, driven output  
PA6..com line RTS\*, driven output  
PA5..com line carrier detect\*  
PA4..com line CTS\*  
PA3..com line DSR\*  
PA2..SEL centronics control  
PA1..POUT paper out ---+  
PA0..BUSY busy ---+ |  
                  | |  
SP...BUSY commodore -+ |  
CNT..POUT commodore ---+  
  
PB7..MTR\* motor  
PB6..SEL3\* select external 3rd drive  
PB5..SEL2\* select external 2nd drive  
PB4..SEL1\* select external 1st drive  
PB3..SEL0\* select internal drive  
PB2..SIDE\* side select\*  
PB1..DIR direction  
PB0..STEP\* step\* (3.0 milliseconds minimum)  
  
PC...not used  
F....INDEX\* disk index\*

```

; A complete 8520 timing example. This blinks the power light at (exactly)
; 3 millisecond intervals. It takes over the machine, so watch out!
;
; The base Amiga crystal frequencies are:
;     NTSC    28.63636 MHz
;     PAL     28.37516 MHz
;
; The two 16 bit timers on the 8520 chips each count down at 1/10 the CPU
; clock, or 0.715909 MHz. That works out to 1.3968255 microseconds per count.
; Under PAL the countdown is slightly slower, 0.709379 MHz.
;
; To wait 1/100 second would require waiting 10,000 microseconds.
; The timer register would be set to (10,000 / 1.3968255 = 7159).
;
; To wait 3 milliseconds would require waiting 3000 microseconds.
; The register would be set to (3000 / 1.3968255 = 2148).
;
    INCLUDE "hardware/cia.i"
    INCLUDE "hardware/custom.i"
;
    XREF    _ciaa
    XREF    _ciab
    XREF    _custom
;
    lea    _custom,a3          ; Base of custom chips
    lea    _ciaa,a4           ; Get base address if CIA-A
;
    move.w #$7fff,dmacon(a3)  ; Kill all chip interrupts
;
;----Setup, only do once
;----This sets all bits needed for timer A one-shot mode.
    move.b ciacra(a4),d0      ;Set control register A on CIAA
    and.b  #%11000000,d0     ;Don't trash bits we are not
    or.b   #%00001000,d0     ;using...
    move.b d0,ciacra(a4)
    move.b #%01111111,ciaicr(a4) ;Clear all 8520 interrupts
;
;----Set time (low byte THEN high byte)
;----And the low order with $ff
;----Shift the high order by 8
;
    TIME   equ    2148
    move.b #(TIME& $FF),ciatalo(a4)
    move.b #(TIME>>8),ciatahi(a4)
;
;----Wait for the timer to count down
busy_wait:
    btst.b #0,ciaicr(a4)     ;Wait for timer expired flag
    beq.s  busy_wait
    bchg.b #CIAB_LED,ciapra(a4) ;Blink light
    bset.b #0,ciacra(a4)     ;Restart timer
    bra.s  busy_wait

    END

```

---

## Hardware Connection Details

The system hardware selects the CIAs when the upper three address bits are 101. Furthermore, CIAA is selected when A12 is low, A13 high; CIAB is selected when A12 is high, A13 low. CIAA communicates on data bits 7-0, CIAB communicates on data bits 15-8.

Address bits A11, A10, A9, and A8 are used to specify which of the 16 internal registers you want to access. This is indicated by ‘r’ in the address. All other bits are don’t cares. So, CIAA is selected by the following binary address: 101x xxxx xx01 rrrr xxxx xxx0. CIAB address: 101x xxxx xx10 rrrr xxxx xxx1

With future expansion in mind, we have decided on the following addresses: CIAA = BFEr01; CIAB = BFDr00. Software must use byte accesses to these address, and no other.

### INTERFACE SIGNALS

#### *Clock Input*

The 02 clock is a TTL compatible input used for internal device operation and as a timing reference for communicating with the system data bus. On the Amiga, this is connected to the 680x0 ‘E’ clock. The ‘E’ clock runs at 1/10 of the CPU clock. This works out to .715909 Mhz for NTSC or .709379 Mhz for PAL.

#### *CS - chip-select input*

The CS input controls the activity of the 8520. A low level on CS while 02 is high causes the device to respond to signals on the R/W and address (RS) lines. A high on CS prevents these lines from controlling the 8520. The CS line is normally activated (low) at 02 by the appropriate address combination.

#### *R/W - read/write input*

The R/W signal is normally supplied by the microprocessor and controls the direction of data transfers of the 8520. A high on R/W indicates a read (data transfer out of the 8520), while a low indicates a write (data transfer into the 8520).

---

### ***RS3-RS0 - address inputs***

The address inputs select the internal registers as described by the register map.

### ***DB7-DB0 - data bus inputs/outputs***

The eight data bus output pins transfer information between the 8520 and the system data bus. These pins are high impedance inputs unless CS is low and R/W and O2 are high, to read the device. During this read, the data bus output buffers are enabled, driving the data from the selected register onto the system data bus.

### ***IRQ - Interrupt request output***

IRQ is an open drain output normally connected to the processor interrupt input. An external pull-up resistor holds the signal high, allowing multiple IRQ outputs to be connected together. The IRQ output is normally off (high impedance) and is activated low as indicated in the functional description.

### ***RES - reset input***

A low on the RES pin resets all internal registers. The port pins are set as inputs and port registers to zero (although a read of the ports will return all highs because of passive pull-ups). The timer control registers are set to zero and the timer latches to all ones. All other registers are reset to zero.







---

# appendix G

## KEYBOARD INTERFACE

This appendix contains the keyboard interface specification for A1000, A500, A2000 and A3000.

The keyboard plugs into the Amiga computer via a cable with four primary connections. The four wires provide 5-volt power, ground, and signals called KCLK (keyboard clock) and KDAT (keyboard data). KCLK is unidirectional and always driven by the keyboard; KDAT is driven by both the keyboard and the computer. Both signals are open-collector; there are pullup resistors in both the keyboard (inside the keyboard microprocessor) and the computer.

### Keyboard Communications

The keyboard transmits 8-bit data words serially to the main unit. Before the transmission starts, both KCLK and KDAT are high. The keyboard starts the transmission by putting out the first data bit (on KDAT), followed by a pulse on KCLK (low then high); then it puts out the second data bit and pulses KCLK until all eight data bits have been sent. After the end of the last KCLK pulse, the keyboard pulls KDAT high again.

When the computer has received the eighth bit, it must pulse KDAT low for at least 1 (one) microsecond, as a handshake signal to the keyboard. The handshake detection on the keyboard end will typically use a hardware latch. *The keyboard must be able to detect pulses greater than or equal to 1 microsecond. Software MUST pulse the line low for 85 microseconds to ensure compatibility with all keyboard models.*

All codes transmitted to the computer are rotated one bit before transmission. The transmitted order is therefore 6-5-4-3-2-1-0-7. The reason for this is to transmit the up/down flag last, in order to cause a key-up code to be transmitted in case the keyboard is forced to restore lost sync (explained in more detail below).

The KDAT line is active low; that is, a high level (+5V) is interpreted as 0, and a low level (0V) is interpreted as 1.

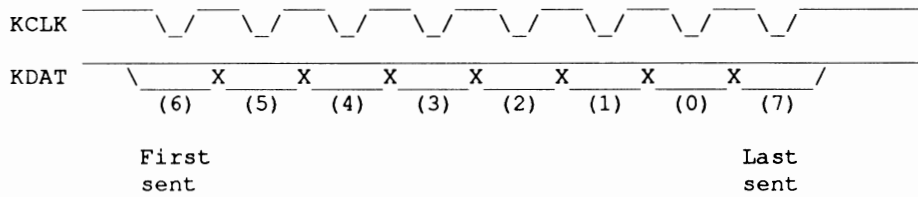

The keyboard processor sets the KDAT line about 20 microseconds before it pulls KCLK low. KCLK stays low for about 20 microseconds, then goes high again. The processor waits another 20 microseconds before changing KDAT.

Therefore, the bit rate during transmission is about 60 microseconds per bit, or 17 kbits/sec.

## Keycodes

Each key has a keycode associated with it (see accompanying table). Keycodes are always 7 bits long. The eighth bit is a “key-up”/“key-down” flag; a 0 (high level) means that the key was pushed down, and a 1 (low level) means the key was released (the Caps Lock key is different -- see below).

For example, here is a diagram of the “B” key being pushed down. The keycode for “B” is \$35 = 00110101; due to the rotation of the byte, the bits transmitted are 01101010.

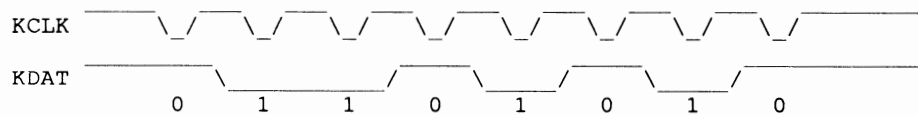

In the next example, the B key is released. The keycode is still \$35, except that bit 7 is set to indicate “key-up,” resulting in a code of \$B5 = 10110101. After rotating, the transmission will be 01101011:

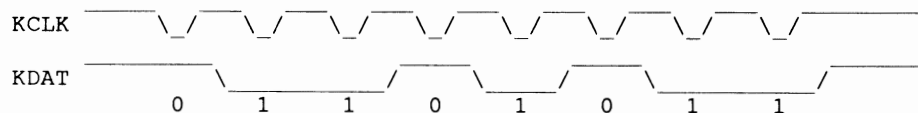

---

## Caps Lock Key

This key is different from all the others in that it generates a keycode only when it is pushed down, never when it is released. However, the up/down bit is still used. When pushing the Caps Lock key turns on the Caps Lock LED, the up/down bit will be 0; when pushing Caps Lock shuts off the LED, the up/down bit will be 1.

## “Out-of-Sync” Condition

Noise or other glitches may cause the keyboard to get out of sync with the computer. This means that the keyboard is finished transmitting a code, but the computer is somewhere in the middle of receiving it.

If this happens, the keyboard will not receive its handshake pulse at the end of its transmission. If the handshake pulse does not arrive within 143 ms of the last clock of the transmission, the keyboard will assume that the computer is still waiting for the rest of the transmission and is therefore out of sync. The keyboard will then attempt to restore sync by going into “resync mode.” In this mode, the keyboard clocks out a 1 and waits for a handshake pulse. If none arrives within 143 ms, it clocks out another 1 and waits again. This process will continue until a handshake pulse arrives.

Once sync is restored, the keyboard will have clocked a garbage character into the computer. That is why the key-up/key-down flag is always transmitted last. Since the keyboard clocks out 1's to restore sync, the garbage character thus transmitted will appear as a key release, which is less dangerous than a key hit.

Whenever the keyboard detects that it has lost sync, it will assume that the computer failed to receive the keycode that it had been trying to transmit. Since the computer is unable to detect lost sync, it is the keyboard's responsibility to inform the computer of the disaster. It does this by transmitting a “lost sync” code (value \$F9 = 11111001) to the computer. Then it retransmits the code that had been garbled.

*About Lost Sync.* The only reason to transmit the “lost sync” code to the computer is to alert the software that something may be screwed up. The “lost sync” code does not help the recovery process, because the garbage key code can't be deleted, and the correct key code could simply be retransmitted without telling the computer that there was an error in the previous one.

---

## Power-Up Sequence

There are two possible ways for the keyboard to be powered up under normal circumstances: <1> the computer can be turned on with the keyboard plugged in, or <2> the keyboard can be plugged into an already “on” computer. The keyboard and computer must handle either case without causing any upset.

The first thing the keyboard does on power-up is to perform a self-test. This involves a ROM checksum test, simple RAM test, and watchdog timer test. Whenever the keyboard is powered up (or restarted -- see below), it must not transmit anything until it has achieved synchronization with the computer. The way it does this is by slowly clocking out 1 bits, as described above, until it receives a handshake pulse.

If the keyboard is plugged in before power-up, the keyboard may continue this process for several minutes as the computer struggles to boot up and get running. The keyboard must continue clocking out 1s for however long is necessary, until it receives its handshake.

If the keyboard is plugged in after power-up, no more than eight clocks will be needed to achieve sync. In this case, however, the computer may be in any state imaginable but must not be adversely affected by the garbage character it will receive. Again, because it receives a key release, the damage should be minimal. The keyboard driver must anticipate this happening and handle it, as should any application that uses raw keycodes.

*Warning:* The keyboard must not transmit a “lost sync” code after re-synchronizing due to a power-up or restart; only after re-synchronizing due to a handshake time-out.

Once the keyboard and computer are in sync, the keyboard must inform the computer of the results of the self-test. If the self-test failed for any reason, a “selftest failed” code (value \$FC = 1111100) is transmitted (the keyboard does not wait for a handshake pulse after sending the “selftest failed” code). After this, the keyboard processor goes into a loop in which it blinks the Caps Lock LED to inform the user of the failure. The blinks are coded as bursts of one, two, three, or four blinks, approximately one burst per second:

One blink	ROM checksum failure.
Two blinks	RAM test failed.
Three blinks	Watchdog timer test failed.
Four blinks	A short exists between two row lines or one of the seven special keys (not implemented).

If the self-test succeeds, then the keyboard will proceed to transmit any keys that are currently down. First, it sends an “initiate power-up key stream” code (value \$FD = 1111101), followed by the key codes of all depressed keys (with keyup/down set to “down” for each key). After all keys are sent (usually there won’t be any at all), a “terminate key stream” code (value \$FE = 1111110) is sent. Finally, the Caps Lock LED is shut off. This marks the end of the start-up sequence, and normal processing commences.

---

The usual sequence of events will therefore be: power-up; synchronize; transmit “initiate power-up key stream” (\$FD); transmit “terminate key stream” (\$FE).

## Reset Warning

*About Reset Warning.* This feature is available on some A1000 and A2000 keyboards. You cannot rely on this feature for all Amigas.

The keyboard has the additional task of resetting the computer on the command of the user. The user initiates Reset Warning by simultaneously pressing the Ctrl key and the two Amiga keys.

The keyboard responds to this input by syncing up any pending transmit operations. The keyboard then sends a “reset warning” to the Amiga. This action alerts the Amiga software to finish up any pending operations (such as disk DMA) and prepare for reset.

A specific sequence of operations ensure that the Amiga is in a state where it can respond to the reset warning. The keyboard sends two actual “reset warning” keycodes. The Amiga must handshake to the first code like any normal keystroke, else the keyboard goes directly to Hard Reset. On the second “reset warning” code the Amiga must drive KDAT low within 250 milliseconds, else the keyboard goes directly to Hard Reset. If all the tests are passed, the Amiga has 10 full seconds to do emergency processing. When the Amiga pulls KDAT high again, the keyboard finally asserts hard reset.

If the Amiga fails to pull KDAT high within 10 seconds, Hard Reset is asserted anyway.

## Hard Reset

*About Hard Reset.* Hard Reset happens after Reset Warning. Valid for all keyboards except the Amiga 500.

The keyboard Hard Resets the Amiga by pulling KCLK low and starting a 500 millisecond timer. When one or more of the keys is released *and* 500 milliseconds have passed, the keyboard will release KCLK. 500 milliseconds is the minimum time KCLK must be held low. The maximum KCLK time depends on how long the user holds the three reset keys down. Circuitry on the Amiga motherboard detects the 500 millisecond KCLK pulse.

After releasing KCLK, the keyboard jumps to its start-up code (internal RESET). This will initialize the keyboard in the same way as cold power-on.

**NOTE:** The keyboard must resend the “powerup key stream”!

## Matrix Table

Column	Row 5 (Bit 7)	Row 4 (Bit 6)	Row 3 (Bit 5)	Row 2 (Bit 4)	Row 1 (Bit 3)	Row 0 (Bit 2)
15 (PD.7)	(spare) (0E)	(spare) (1C)	(spare) (2C)	(spare) (47)	(spare) (48)	(spare) (49)
14 (PD.6)	* note 1 (5D)	<SHIFT> note 2 (30)	CAPS LOCK (62)	TAB (42)	~ ' (00)	ESC (45)
13 (PD.5)	+ note 1 (5E)	Z (31)	A (20)	Q (10)	! 1 (01)	( note 1 (5A)
12 (PD.4)	9 note 3 (3F)	X (32)	S (21)	W (11)	@ 2 (02)	F1 (50)
11 (PD.3)	6 note 3 (2F)	C (33)	D (22)	E (12)	# 3 (03)	F2 (51)
10 (PD.2)	3 note 3 (1F)	V (34)	F (23)	R (13)	\$ 4 (04)	F3 (52)
9 (PD.1)	. note 3 (3C)	B (35)	G (24)	T (14)	% 5 (05)	F4 (53)
8 (PD.0)	8 note 3 (3E)	N (36)	H (25)	Y (15)	^ 6 (06)	F5 (54)
7 (PC.7)	5 note 3 (2E)	M (37)	J (26)	U (16)	& 7 (07)	) note 1 (5B)
6 (PC.6)	2 note 3 (1E)	< , (38)	K (27)	I (17)	* 8 (08)	F6 (55)
5 (PC.5)	ENTER note 3 (43)	> . (39)	L (28)	O (18)	( 9 (09)	/ note 1 (5C)



Column	Row 5 (Bit 7)	Row 4 (Bit 6)	Row 3 (Bit 5)	Row 2 (Bit 4)	Row 1 (Bit 3)	Row 0 (Bit 2)
4 (PC.4)	7  note 3 (3D)	? / (3A)	: ; (29)	P (19)	) 0 (0A)	F7 (56)
3 (PC.3)	4  note 3 (2D)	(spare) (3B)	" ' (2A)	{ [ (1A)	_	F8 (57)
2 (PC.2)	1  note 3 (1D)	SPACE BAR (40)	<RET>  note 2 (2B)	} ] (1B)	+ = (0C)	F9 (58)
1 (PC.1)	0  note 3 (0F)	BACK SPACE (41)	DEL (46)	RETURN (44)	 \ (0D)	F10 (59)
0 (PC.0)	-  note 3 (4A)	CURS DOWN (4D)	CURS RIGHT (4E)	CURS LEFT (4F)	CURS UP (4C)	HELP (5F)

note 1: A500, A2000 and A3000 keyboards only (numeric pad )

note 2: International keyboards only (these keys are cutouts of the larger key on the US ASCII version.) The key that generates \$30 is cut out of the left Shift key. Key \$2B is cut out of return. These keys are labeled with country-specific markings.

note 3: Numeric pad.

The following table shows which keys are independently readable. These keys never generate ghosts or phantoms.

(Bit 6)	(Bit 5)	(Bit 4)	(Bit 3)	(Bit 2)	(Bit 1)	(Bit 0)
LEFT AMIGA (66)	LEFT ALT (64)	LEFT SHIFT (60)	CTRL (63)	RIGHT AMIGA (67)	RIGHT ALT (65)	RIGHT SHIFT (61)

---

## Special Codes

The special codes that the keyboard uses to communicate with the main unit are summarized here.

*About the special codes.* The special codes are 8-bit numbers; there is no up/down flag associated with them. However, the transmission bit order is the same as previously described.

Code	Name	Meaning
78	Reset warning.	Ctrl-Amiga-Amiga has been hit - computer will be reset in 10 seconds. (see text)
F9	Last key code bad,	next code is the same code retransmitted (used when keyboard and main unit get out of sync).
FA	Keyboard output buffer overflow	
FB	Unused (was controller failure)	
FC	Keyboard selftest failed	
FD	Initiate power-up key stream	(keys pressed at powerup)
FE	Terminate power-up key stream	
FF	Unused (was interrupt)	





---

# appendix H

## EXTERNAL DISK CONNECTOR INTERFACE

### General

The 23-pin female connector at the rear of the main computer unit is used to interface to and control devices that generate and receive MFM data. This interface can be reached either as a resource or under the control of a driver. The following pages describe the interface in both cases.

### Summary Table

Pin #	Name	Note	
1	RDY-	I/O	ID and ready
2	DKRD-	I	MFM input
3	GRND	G	-
4	GRND	G	-
5	GRND	G	-
6	GRND	G	-
7	GRND	G	-
8	MTRXD-	O	Motor control.
9	SEL2B-	O*	Select drive 2
10	DRESB-	O	Reset
11	CHNG-	I/O	Disk changed

12	+5v	PWR	540 mA average 870 mA surge
13	SIDEB-	O	Side 1 if low
14	WRPRO-	I/O	Write protect
15	TK0-	I/O	Track 0
16	DKWEB-	O	Write gate
17	DKWDB-	O	Write data
18	STEPB-	O	Step
19	DIRB	O	Direction (high is out)
20	SEL3B-	O*	Select drive 3
21	SEL1B-	O*	Select drive 1
22	INDEX-	I/O	Index
23	+12v	PWR	120 mA average 370 mA surge

### Key to Class:

- G ground, note connector shield grounded.
- I input pulled up to 5v by 1K ohm.
- I/O input in driver, but bidirectional input (1k pullup)
- O output pulled though 1K to 5v
- O\* output, separates resources.
- PWR available for external use, but currently used up by external drive.

## Signals When Driving a Disk

The following describes the interface under driver control.

SEL1B-, SEL2B-, SEL3B-

Select lines for the three external disk drives active low.

TK0-

A selected drive pulls this signal low whenever its read-write head is on track 00.

RDY-

When a disk drive's motor is on, this line indicates the selected disk is installed and rotating at speed. The driver ignores this signal. When the motor is off this is used as a ID data line. See below.

---

**WPRO-** (Pin #14)

A selected drive pulls this signal low whenever it has a write-protected diskette installed.

**INDEX-** (Pin #22)

A selected drive pulses this signal low once for each revolution of its motor.

**SIDEB-** (Pin #13)

The system drives this signal to all disk drives—low for side 1, high for side 0.

**STEPB-** (Pin #18)

Pulsed to step the selected drive's head.

**DIRB** (Pin #19)

The system drives this signal high or low to tell the selected drive which way to step when the **STEPB-** pulse arrives. Low means step in (to higher-numbered track); high means step out.

**DKRD-** (Pin #2)

A selected drive will put out read data on this line.

**DKWDB-** (Pin #17)

The system drives write data to all disks via this signal. The data is only written when **DKWEB-** is active (low). Data is written only to selected drives.

**DKWEB-** (Pin #16)

This signal causes a selected drive to start writing data (provided by **DKWDB-**) onto the disk.

**CHNG-** (Pin #11)

A selected drive will drive this signal low whenever its internal "disk change" latch is set. This latch is set when the drive is first powered on, or whenever there is no diskette in the drive. To reset the latch, the system must select the drive, and step the head. Of course, the latch will not reset if there is no diskette installed.

**MTRXD-** (Pin #8)

This is the motor control line for all four disk drives. When the system wants to turn on a disk drive motor, it first deselects the drive (if selected), pulls **MTRXD-** low, and selects the drive. To turn the motor off, the system deselects the drive, pulls **MTRXD-** high, and selects the drive. The system will always set **MTRXD-** at least 1.4 microseconds before it selects the drive, and will not change **MTRXD-** for at least 1.4 microseconds after selecting the drive. All external drives must have logic equivalent to a D flip-flop, whose D input is the **MTRXD-** signal, and whose clock input is activated by the off-to-on (high-to-low) transition of its **SELxB-** signal. As noted above, both the setup and hold times of

---

MTRXD- with respect to SELxB- will always be at least 1.4 microseconds. The output of this flip-flop controls the disk drive motor. Thus, the system can control all four motors using only one signal on the cable (MTRXD-).

#### DRESB- (Pin #10)

This signal is a buffered version of the system reset signal. Three things can make it go active (low):

- System power-up (DRESB- will go low for approximately one second);
- System CPU executes a RESET instruction (DRESB- will go low for approximately 17 microseconds);
- Hard reset from keyboard (lasts as long as keyboard reset is held down).

External disk drives should respond to DRESB- by shutting off their motor flip-flops and write protecting themselves.

A level of 3.75v or below on the 5v+ requires external disks to write-protect and reset the motor on line.

## Device I.D.

This interface supports a method of establishing the type of disk(s) attached. The I.D. sequence is as follows.

1. Drive MTRXD- low: Turn on the disk drive motor.
2. Drive SELxB- low: Activate drive select x, where x is the number of the selected drive.
3. Drive SELxB- high: Deactivate drive select x..
4. Drive MTRXD- high: Turn off disk drive motor.
5. Drive SELxB- low: Activate drive select x.
6. Drive SELxB- high: Deactivate drive select x.
7. Drive SELxB- low: Activate drive select x.
8. Read and save state of RDY.
9. Drive SELxB- high: Deactivate drive select x.



Repeat steps 7 through 9, 31 more times for a total of 32 iterations, in order to read 32 bits of data. The most significant bit is read first.

Steps 1 through 4 in the algorithm above turn on and off the disk drive motor. This initializes the serial shift register. After initialization, the SELxB signal is driven (first active then) inactive as in steps 5 and 6. Keep in mind that the SELxB signal is active-low.

Steps 7, 8 and 9 form a loop where (7) the SELxB signal is driven active (low), (8) the serial input data is read on RDY (pin 1) and (9) the SELxB signal is again driven high (inactive). This loop is performed 32 times, once for each of the bits in the input stream that comprise the device I.D.

Convert the 32 values of RDY- into a two 16-bit word. The most significant bit is the first value and so on. This 32-bit quantity is the device I.D..

The following I.D.s are defined:

0000 0000 0000 0000 0000 0000 0000 0000	Reserved (\$0000 0000)
1111 1111 1111 1111 1111 1111 1111 1111	Amiga standard 3.25(\$FFFF FFFF)
1010 1010 1010 1010 1010 1010 1010 1010	Reserved (\$AAAA AAAA)
0101 0101 0101 0101 0101 0101 0101 0101	48 TPI double-density, double-sided (\$5555 5555)
1000 0000 0000 0000 1000 0000 0000 0000	Reserved (\$8000 8000)
0111 1111 1111 1111 0111 1111 1111 1111	Reserved (\$7FFF 7FFF)
0000 1111 xxxx xxxx 0000 1111 xxxx xxxx	Available for users (\$0Fxx 0Fxx)
1111 0000 xxxx xxxx 1111 0000 xxxx xxxx	Extension reserved (\$F0xx F0xx)
xxxx 0000 0000 0000 xxxx 0000 0000 0000	Reserved (\$x000 x000)
xxxx 1111 1111 1111 xxxx 1111 1111 1111	Reserved (\$x000 x000)
0011 0011 0011 0011 0011 0011 0011 0011	Reserved (\$3333 3333)
1100 1100 1100 1100 1100 1100 1100 1100	Reserved (\$CCCC CCCC)



---

# appendix I

## HARDWARE EXAMPLE INCLUDE FILE

This appendix contains an include file that maps the hardware register names, given in Appendix A and Appendix B, to names that can be resolved by the standard include files. Use of these names in code sections of this manual places the emphasis on what the code is doing, rather than getting bogged down in include file names.

All code examples in this manual reference the names given in this file.

```
                IFND      HARDWARE_HW_EXAMPLES_I
HARDWARE_HW_EXAMPLES_I SET      1
**
**      Filename: hardware/hw_examples.i
**      $Release: 1.3 $
**
**      (C) Copyright 1985,1986,1987,1988,1989 Commodore-Amiga, Inc.
**      All Rights Reserved
**
*****

                IFND      HARDWARE_CUSTOM_I
                INCLUDE "hardware/custom.i"
                ENDC

*****
*
* This include file is designed to be used in conjunction with the hardware
* manual examples. This file defines the register names based on the
* hardware/custom.i definition file. There is no C-Language version of this
* file.
*
*****
*
* This instruction for the copper will cause it to wait forever since
* the wait command described in it will never happen.
*
COPPER_HALT      equ      $FFFFFFFE
```

```

*
*****
*
* This is the offset in the 680x0 address space to the custom chip registers
* It is the same as _custom when linking with AMIGA.lib
*
CUSTOM          equ      $DFF000
*
* Various control registers
*
DMACONR         equ      dmaconr      ; Just capitalization...
VPOSR          equ      vposr        ; " "
VHPOSR         equ      vhposr       ; " "
JOYODAT        equ      joy0dat      ; " "
JOY1DAT        equ      joy1dat      ; " "
CLXDAT         equ      clxdat       ; " "
ADKCONR        equ      adkconr      ; " "
POTODAT        equ      pot0dat      ; " "
POT1DAT        equ      pot1dat      ; " "
POTINP         equ      potinp       ; " "
SERDATR        equ      serdatr      ; " "
INTENAR        equ      intenar      ; " "
INTREQR        equ      intreqr      ; " "
REFPTR         equ      refptr       ; " "
VPOSW          equ      vposw        ; " "
VHPOSW         equ      vhposw       ; " "
SERDAT         equ      serdat       ; " "
SERPER         equ      serper       ; " "
POTGO          equ      potgo        ; " "
JOYTEST        equ      joytest      ; " "
STREQU         equ      strequ       ; " "
STRVBL         equ      strvbl       ; " "
STRHOR         equ      strhor       ; " "
STRLONG        equ      strlong      ; " "
DIWSTR         equ      diwstrt      ; " "
DIWSTOP        equ      diwstop      ; " "
DDFSTR         equ      ddfstrt      ; " "
DDFSTOP        equ      ddfstop     ; " "
DMACON         equ      dmacon       ; " "
INTENA         equ      intena       ; " "
INTREQ         equ      intreq       ; " "
*
* Disk control registers
*
DSKBYTR        equ      dskbytr      ; Just capitalization...
DSKPT          equ      dskpt        ; " "
DSKPTH         equ      dskpt        ; " "
DSKPTL         equ      dskpt+$02   ; " "
DSKLEN         equ      dsklen       ; " "
DSKDAT         equ      dskdat       ; " "
DSKSYNC        equ      dsksync     ; " "
*
* Blitter registers
*
BLTCON0        equ      bltcon0      ; Just capitalization...
BLTCON1        equ      bltcon1     ; " "
BLTAFWM        equ      bltafwm     ; " "
BLTALWM        equ      bltalwm     ; " "
BLTCPT         equ      bltcpt      ; " "
BLTCPTH        equ      bltcpt      ; " "
BLTCPTL        equ      bltcpt+$02

```

```

BLTBPT      equ      bltbpt      ; "      "
BLTBPTH     equ      bltbpt
BLTBPTL     equ      bltbpt+$02
BLTAPT      equ      bltapt      ; "      "
BLTAPTH     equ      bltapt
BLTAPTL     equ      bltapt+$02
BLTDPT      equ      bltdpt     ; "      "
BLTDPTH     equ      bltdpt
BLTDPTL     equ      bltdpt+$02
BLTSIZE     equ      bltsize    ; "      "
BLTCMOD     equ      bltcmmod   ; "      "
BLTBMOD     equ      bltbmod    ; "      "
BLTAMOD     equ      bltamod    ; "      "
BLTDMOD     equ      bltdmod    ; "      "
BLTCDAT     equ      bltcdat    ; "      "
BLTBDAT     equ      bltbdat    ; "      "
BLTADAT     equ      bltadat    ; "      "
BLTDDAT     equ      bltddat    ; "      "
*
* Copper control registers
*
COPCON      equ      copcon      ; Just capitalization...
COPINS      equ      copins     ; "      "
COPJMP1     equ      copjmp1    ; "      "
COPJMP2     equ      copjmp2    ; "      "
COP1LC      equ      cop1lc     ; "      "
COP1LCH     equ      cop1lc
COP1LCL     equ      cop1lc+$02
COP2LC      equ      cop2lc     ; "      "
COP2LCH     equ      cop2lc
COP2LCL     equ      cop2lc+$02
*
* Audio channel registers
*
ADKCON      equ      adkcon      ; Just capitalization...

AUD0LC      equ      aud0
AUD0LCH     equ      aud0
AUD0LCL     equ      aud0+$02
AUD0LEN     equ      aud0+$04
AUD0PER     equ      aud0+$06
AUD0VOL     equ      aud0+$08
AUD0DAT     equ      aud0+$0A

AUD1LC      equ      aud1
AUD1LCH     equ      aud1
AUD1LCL     equ      aud1+$02
AUD1LEN     equ      aud1+$04
AUD1PER     equ      aud1+$06
AUD1VOL     equ      aud1+$08
AUD1DAT     equ      aud1+$0A

AUD2LC      equ      aud2
AUD2LCH     equ      aud2
AUD2LCL     equ      aud2+$02
AUD2LEN     equ      aud2+$04
AUD2PER     equ      aud2+$06
AUD2VOL     equ      aud2+$08
AUD2DAT     equ      aud2+$0A

```

```

AUD3LC          equ      aud3
AUD3LCH         equ      aud3
AUD3LCL         equ      aud3+$02
AUD3LEN         equ      aud3+$04
AUD3PER         equ      aud3+$06
AUD3VOL         equ      aud3+$08
AUD3DAT         equ      aud3+$0A
*
*
*   The bitplane registers
*
BPL1PT          equ      bplpt+$00
BPL1PTH         equ      bplpt+$00
BPL1PTL         equ      bplpt+$02
BPL2PT          equ      bplpt+$04
BPL2PTH         equ      bplpt+$04
BPL2PTL         equ      bplpt+$06
BPL3PT          equ      bplpt+$08
BPL3PTH         equ      bplpt+$08
BPL3PTL         equ      bplpt+$0A
BPL4PT          equ      bplpt+$0C
BPL4PTH         equ      bplpt+$0C
BPL4PTL         equ      bplpt+$0E
BPL5PT          equ      bplpt+$10
BPL5PTH         equ      bplpt+$10
BPL5PTL         equ      bplpt+$12
BPL6PT          equ      bplpt+$14
BPL6PTH         equ      bplpt+$14
BPL6PTL         equ      bplpt+$16

BPLCON0         equ      bplcon0          ; Just capitalization...
BPLCON1         equ      bplcon1          ; " "
BPLCON2         equ      bplcon2          ; " "
BPL1MOD         equ      bpl1mod          ; " "
BPL2MOD         equ      bpl2mod          ; " "

DPL1DATA        equ      bpldat+$00
DPL2DATA        equ      bpldat+$02
DPL3DATA        equ      bpldat+$04
DPL4DATA        equ      bpldat+$06
DPL5DATA        equ      bpldat+$08
DPL6DATA        equ      bpldat+$0A
*
*
*   Sprite control registers
*
SPROPT          equ      sprpt+$00
SPROPTH         equ      SPROPT+$00
SPROPTL         equ      SPROPT+$02
SPR1PT          equ      sprpt+$04
SPR1PTH         equ      SPR1PT+$00
SPR1PTL         equ      SPR1PT+$02
SPR2PT          equ      sprpt+$08
SPR2PTH         equ      SPR2PT+$00
SPR2PTL         equ      SPR2PT+$02
SPR3PT          equ      sprpt+$0C
SPR3PTH         equ      SPR3PT+$00
SPR3PTL         equ      SPR3PT+$02
SPR4PT          equ      sprpt+$10
SPR4PTH         equ      SPR4PT+$00
SPR4PTL         equ      SPR4PT+$02

```

```

SPR5PT      equ      sprpt+$14
SPR5PTH     equ      SPR5PT+$00
SPR5PTL     equ      SPR5PT+$02
SPR6PT      equ      sprpt+$18
SPR6PTH     equ      SPR6PT+$00
SPR6PTL     equ      SPR6PT+$02
SPR7PT      equ      sprpt+$1C
SPR7PTH     equ      SPR7PT+$00
SPR7PTL     equ      SPR7PT+$02
;
; Note: SPRxDATB is defined as being +$06 from SPRxPOS.
; sd_datab should be defined as $06, however, in the 1.3 assembler
; include file hardware/custom.i it is incorrectly defined as $08.
;
SPR0POS     equ      spr+$00
SPR0CTL     equ      SPR0POS+sd_ctl
SPR0DATA    equ      SPR0POS+sd_dataaa
SPR0DATB    equ      SPR0POS+$06      ; should use sd_datab ...

SPR1POS     equ      spr+$08
SPR1CTL     equ      SPR1POS+sd_ctl
SPR1DATA    equ      SPR1POS+sd_dataaa
SPR1DATB    equ      SPR1POS+$06      ; should use sd_datab ...

SPR2POS     equ      spr+$10
SPR2CTL     equ      SPR2POS+sd_ctl
SPR2DATA    equ      SPR2POS+sd_dataaa
SPR2DATB    equ      SPR2POS+$06      ; should use sd_datab ...

SPR3POS     equ      spr+$18
SPR3CTL     equ      SPR3POS+sd_ctl
SPR3DATA    equ      SPR3POS+sd_dataaa
SPR3DATB    equ      SPR3POS+$06      ; should use sd_datab ...

SPR4POS     equ      spr+$20
SPR4CTL     equ      SPR4POS+sd_ctl
SPR4DATA    equ      SPR4POS+sd_dataaa
SPR4DATB    equ      SPR4POS+$06      ; should use sd_datab ...

SPR5POS     equ      spr+$28
SPR5CTL     equ      SPR5POS+sd_ctl
SPR5DATA    equ      SPR5POS+sd_dataaa
SPR5DATB    equ      SPR5POS+$06      ; should use sd_datab ...

SPR6POS     equ      spr+$30
SPR6CTL     equ      SPR6POS+sd_ctl
SPR6DATA    equ      SPR6POS+sd_dataaa
SPR6DATB    equ      SPR6POS+$06      ; should use sd_datab ...

SPR7POS     equ      spr+$38
SPR7CTL     equ      SPR7POS+sd_ctl
SPR7DATA    equ      SPR7POS+sd_dataaa
SPR7DATB    equ      SPR7POS+$06      ; should use sd_datab ...
*
* Color registers...
*
COLOR00     equ      color+$00
COLOR01     equ      color+$02
COLOR02     equ      color+$04
COLOR03     equ      color+$06
COLOR04     equ      color+$08

```

```
COLOR05      equ      color+$0A
COLOR06      equ      color+$0C
COLOR07      equ      color+$0E
COLOR08      equ      color+$10
COLOR09      equ      color+$12
COLOR10      equ      color+$14
COLOR11      equ      color+$16
COLOR12      equ      color+$18
COLOR13      equ      color+$1A
COLOR14      equ      color+$1C
COLOR15      equ      color+$1E
COLOR16      equ      color+$20
COLOR17      equ      color+$22
COLOR18      equ      color+$24
COLOR19      equ      color+$26
COLOR20      equ      color+$28
COLOR21      equ      color+$2A
COLOR22      equ      color+$2C
COLOR23      equ      color+$2E
COLOR24      equ      color+$30
COLOR25      equ      color+$32
COLOR26      equ      color+$34
COLOR27      equ      color+$36
COLOR28      equ      color+$38
COLOR29      equ      color+$3A
COLOR30      equ      color+$3C
COLOR31      equ      color+$3E
```

```
*****
```

```
**
**
```

```
ENDC      ; HARDWARE_HW_EXAMPLES_I
```



# appendix J

## CUSTOM CHIP PIN ALLOCATION LIST

This section gives the pin assignments used by the Amiga's custom chip set.

NOTE: \* Means an active low signal.

### ORIGINAL AGNUS PIN ASSIGNMENT

PIN #	DESIGNATION	FUNCTION	DEFINITION
01-09	D8-D0	Data bus lines 8 to 0	I/O
10	VCC	+5 Volt	I
11	RES*	System reset	I
12	INT3*	Interrupt level 3	O
13	DMAL	DMA request line	I
14	BLS*	Blitter slowdown	I
15	DBR*	Data bus request	O
16	ARW*	Agnus RAM write	O
17-24	RGA8-RGA1	Register address bus 8-1	I/O
25	CCK	Color clock	I
26	CCKQ	Color clock delay	I
27	VSS	Ground	I
28-36	DRA0-DRA8	DRAM address bus 0 to 8	O
37	LP*	Light pen input	I
38	VSU*	Vertical sync	I/O
39	CSU*	Composite sync	O
40	HSU*	Horizontal sync	I/O
41	VSS	Ground	I
42-48	D15-D9	Data bus lines 15 to 9	I/O

DENISE PIN ASSIGNMENT

-----

PIN #	DESIGNATION	FUNCTION	DEFINITION
01-07	D6-D0	Data bus lines 6 to 0	I/O
08	MIH	Mouse 1 horizontal	I
09	MOH	Mouse 0 horizontal	I
10-17	RGA8-RGA1	Register address bus 8-1	I
18	BURST*	Color burst	O
19	VCC	+5 Volt	I
20-23	R0-R3	Video red bits 0-3	O
24-27	B0-B3	Video blue bits 0-3	O
28-31	G0-G3	Video green bits 0-3	O
32	/CSYNC	Composite sync	I
33	ZD*	Background indicator	O
34	N/C	Not connected	N/C (old Denise)
	CDAC	CDAC clock	I (ECS Denise)
35	7M	7.15909 MHZ	I
36	CCK	Color clock	I
37	VSS	Ground	I
38	MOV	Mouse 0 vertical	I
39	M1V	Mouse 1 vertical	I
40-48	D15-D7	Data bus lines 15 to 7	I/O

PAULA PIN ASSIGNMENT

-----

PIN #	DESIGNATION	FUNCTION	DEFINITION
01-07	D8-D2	Data bus lines 8 to 2	I/O
08	VSS	Ground	I
09-10	D1-D0	Data bus lines 1 and 0	I/O
11	RES*	System reset	I
12	DMAL	DMA request line	O
13-15	IPL0*-IPL2	Interrupt lines 0-2	O
16	INT2*	Interrupt level 2	I
17	INT3*	Interrupt level 3	I
18	INT6*	Interrupt level 6	I
19-26	RGA8-RGA1	Register address bus 8-1	I
27	VCC	+5 Volt	I
28	CCK	Color clock	I
29	CCKQ	Color clock delay	I
30	AUDB	Right audio	O
31	AUDA	Left audio	O
32	POTOX	Pot 0X	I/O
33	POTOY	Pot 0Y	I/O
34	VSSANA	Analog ground	I
35	POT1X	Pot 1X	I/O
36	POT1Y	Pot 1Y	I/O
37	DKRD*	Disk read data	I
38	DKWD*	Disk write data	O
39	DKWE	Disk write enable	O
40	TXD	Serial transmit data	O
41	RXD	Serial receive data	I
42-48	D15-D9	Data bus lines 15 to 9	I/O

FAT AGNUS PIN ASSIGNMENT

-----

PIN #	DESIGNATION	FUNCTION	DEFINITION
-----	-----	-----	-----
01-14	RD15-RD2	Register bus lines 15 to 2	I/O
17	INT3*	Blitter ready interrupt	O
18	DMAL	Request audio/disk DMA	I
18	RD1	Register bus line 1	I/O
18	RST*	Reset	I
19	BLS*	Blitter slowdown	I
20	DBR*	Data bus request	O
21	RRW	DRAM Write/Read	O
22	PRW	Processor Write/Read	I
23	RGEN*	RG Enable	I
24	AS*	Address Strobe	I
25	RAMEN*	RAM Enable	I
26-33	RGA8-RGA1	Register address bus 8-1	O
34	28MHZ	Master clock	I
35	XCLK	Alternate master clock	I
36	XCLKEN*	Master clock enable	I
37	CDAC*	Inverted shifted 7MHZ clk	O
38	7MHZ	28MHZ clk divided by four	O
39	CCKQ	Color clock delay	O
40	CCK	Color clock	O
41	TEST	Test - access registers	I (old Fat Agnus)
	NTSC/PAL	Select video environment	I (ECS Fat Agnus)
43-51	MA0-MA8	Output bus lines 0 to 8	O
52	LDS*	Lower data strobe	I
53	UDS*	Upper data strobe	I
54	CASL*	Column addr strobe lower	O
55	CASU*	Column addr strobe upper	O
56	RAS1*	Row address strobe one	O
57	RAS0*	Row address strobe zero	O
59-77	A19-A1	Address bus lines 19 to 1	I
78	LP*	Light pen	O
79	VSU*	Vertical synch	I/O
80	CSU*	Composite video synch	O
81	HSU*	Horizontal synch	I/O
84	RDO	Register bus line 0	I/O



---

# appendix K

## ZORRO EXPANSION BUS

This appendix describes the complete Zorro III bus, first implemented in the Amiga 3000 computer. The Zorro III bus is a performance 32-bit expansion bus that is also upward compatible with the Zorro II bus (Amiga 2000 expansion bus). The main intent of the Zorro III bus is to allow fast 32-bit peripherals and memory devices to be added to a high performance Amiga, such as the Amiga 3000, while at the same time allowing standard Zorro II devices to be used wherever they make sense in such a system. This compatibility also insures that the Amiga 3000 will have a number of hardware and software compatible expansion devices available upon introduction, and that Amiga 2000 owners will be able to take their expansion card investment along with them should they migrate to a higher performance Amiga.

### INTENDED AUDIENCE

This appendix was written primarily for hardware engineers interested in designing Plug-In Cards for the Zorro III expansion bus. While it may occasionally be of use to software engineers interfacing to such Zorro III PICs, Amiga system software provides an interface layer (*expansion.library* in the Amiga OS) which manages the needs of most card-level software. A reasonable level of microcomputer knowledge is prerequisite to get much meaning out of these pages. A good understanding of the Motorola 680x0 processors will be quite useful, as will be an understanding of the Zorro II expansion bus used on earlier Amiga computers such as the Amiga 2000.

### AMIGA BUS HISTORY

The original Amiga computer, the Amiga 1000, was introduced in 1985. While it had no built-in standard for expandability, the capability for some form of expansion was considered extremely important; personal computer history up to that date had shown several times that an open hardware expansion capability was often critical to a personal computer's success and to its capability to adapt to new or unusual applications. The A1000 was designed with a connector

---

giving access to the internal 68000 bus and a few other system signals. Shortly after introduction, the formal expansion specification for a card chassis that would connect to the A1000 was published. This bus became commonly known as the Zorro bus.<sup>1</sup> While the backplane specification was very easy to implement with 1985 PAL technology based on the existing 68000 signals, the specification did incorporate a number of advanced features. Far more sophisticated than the IBM-XT/AT and Apple II buses in common use at the time, the Zorro bus allowed any slot to master the bus, and it linked expansion cards with the system software. Addressing jumpers were eliminated, the card's address instead being assigned by software, and cards could easily be identified by software and linked with appropriate driver programs, all with a minimum of user intervention.

With the introduction of the Amiga 2000 system, the Zorro bus was changed slightly. Additional discrete interrupt lines were added, replacing the encoded lines that couldn't easily be used by any bus resident device. As it turns out, these additional encoded lines weren't any more useful, as they couldn't be disabled by software, and as such, they're no longer considered an official part of the Zorro II bus specification (they are supported as part of Zorro III). Finally, the form factor was changed to match that of the IBM PC-AT card, acting as both a cost reduction and allowing the Zorro II bus to offer the PC-AT bus as one optional secondary bus extension. This modified specification became commonly known as the Zorro II bus, and it's the Amiga bus standard that's been in use for most of the Amiga's life. And it's a bus standard that will continue to be important.

## THE ZORRO III RATIONALE

With the creation of the Amiga 3000, it became clear that the Zorro II bus would not be adequate to support all of that system's needs. The Zorro II bus would continue to be quite useful, as the current Amiga expansion standard, and so it would have to be supported. A few unused pins on the Zorro II bus and the option of a bus controller custom LSI, gave rise to the Zorro III design, which supports the following features:

- Compatibility with all Zorro II devices.
- Full 32-bit address path for new devices.
- Full 32-bit data path for new devices.
- Bus speed independent of host system CPU speed.
- High speed bus block transfer mode.
- Bus locking for multiprocessor support.
- Cache disable for simple cache support.
- Fair arbitration for all bus masters.
- Cycle-by-cycle bus arbitration mode.
- High speed interrupt mode.

---

<sup>1</sup> The original "Zorro" name comes from the code name of one of the A1000 prototype boards. The "Zorro" board was the one that followed the "Lorraine," and was the board in the works when much of the expansion specifications were worked up. Since everyone uses the "Zorro" name, and no one's suggested a better name, we've stuck with it.

---

Some of the advanced features, such as burst modes, are designed in such a way as to make them optional; both master and slave arbitrate for them. In addition, it is possible with a bit of extra cleverness, to design a card that automatically configures itself for either Zorro II or Zorro III operation, depending on the status of a sensing pin on the bus.

The Zorro III bus is physically based on the same 100-pin single piece connector as the Zorro II bus. While some bus signals remain unchanged throughout bus operation, other signals change based on the specific bus mode in effect at any time. The bus is geographically mapped into three main sections: *Zorro II Memory Space*, *Zorro II I/O Space*, and *Zorro III Space*. The memory map in Figure K-1 shows how these three spaces are mapped in the A3000 system. The Zorro II space is limited to a 16 megabyte region, and since it has DMA access by convention to chip memory, it is in the original 68000 memory map for any bus implementation. The Zorro III space can physically be anywhere in 32-bit memory.

The Zorro III bus functions in one of two different major modes, depending on the memory address on the bus. All bus cycles start with a 32-bit address, since the full 32-bit address is required for proper cycle typing. If the address is determined to be in Zorro II space, a Zorro II compatible cycle is initiated, and all responding slave devices are expected to be Zorro II compatible 16-bit PICs. Should a Zorro III address be detected, the cycle completes when a Zorro III slave responds or the bus times out, as driven by the motherboard logic. It is very important that no Zorro III device respond in Zorro III mode to a Zorro II bus access; the two types of cycles make very different use of many of the expansion bus lines, and serious buffer contention can result if the cycle types are somehow mixed up. The Zorro III bus of course started with the Zorro II bus as its necessary base, but the Zorro III bus mechanisms were designed as much as possible to solve specific needs for high end Amiga systems, rather than extend any particular Zorro II philosophy when that philosophy no longer made any sense. There are actually several variations of the basic Zorro III cycle, though they all work on the same principles. The variations are for optimization of cycle times and for service of interrupt vectors. But all of this in due time.

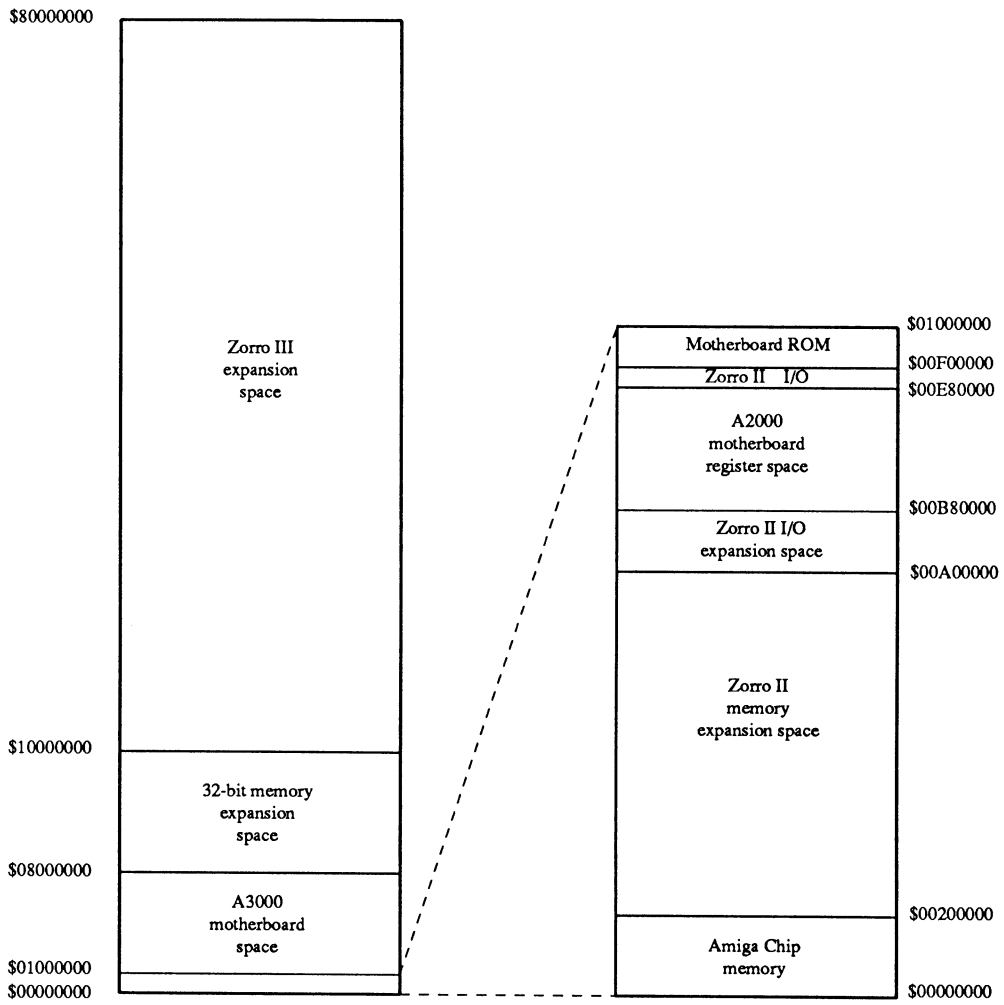

Figure K-1: Expansion Memory Map



---

## Zorro II Compatibility

The A3000 bus is a rather extensive superset of the A2000 bus design. The compatibility is based on distinct bus modes, rather than a simple extension to the existing bus mechanisms. Through the use of an integrated bus controller (the Fat Buster chip), the expansion bus configures itself differently for the 16-bit A2000-compatible Zorro II modes than the 32-bit Zorro III modes. As a result, while there are still only 100 pins on the expansion bus, some pins change function considerably depending on the bus activity that's currently in progress. While the Zorro II modes of the Zorro III bus are as compatible as possible with the Zorro II bus specification (especially the A2000 implementation of this specification), there are some small differences between the two expansion buses.

Aside from these differences, in general, it's important to understand the Zorro II bus in order to understand the Zorro III bus. The general features of the A3000 bus, like autoconfiguration, the master-slave bus architecture, and the physical attributes come from the Zorro II expansion bus. Other features of the Zorro III bus address shortcomings of the Zorro II architecture, but Zorro II has a hand in how some of these shortcomings are solved under Zorro III. Those with a full understanding of the Zorro II bus will mainly be concerned with the possible bus incompatibilities listed here.

### CHANGES FROM THE A2000 BUS

While much effort has been made to assure that the Zorro II mode of the A3000 bus is as compatible as possible with the A2000 bus, there are a few points to consider here. Primarily, the A3000's Zorro II modes are driven with a state machine that emulates the 68000 bus protocol. This emulation must be based on the published Motorola specifications detailing 68000 bus behavior. While this has the interesting effect of changing the Zorro II bus from CPUdependent to CPU independent, there's some margin for trouble. Zorro II PICs also designed to these specifications should have no trouble in the A3000 bus in most cases. However, anything designed based on observed 68000 behavior rather than documented 68000 operation is at serious risk of failing in an A3000 bus, as one might expect. There are also actual documented differences, which are listed below.

#### *6800 Bus Interface*

A major difference between the A3000 expansion bus in Zorro II mode and the A2000 bus is the absence of the signals /VPA and /VMA, which comprise the 6800/6502 peripheral support mechanism that's part of the 68000 bus interface. This mechanism was never a supported part of the Zorro II specification, however, and it should not be used by any PIC. Any Zorro II PIC that depends on /VPA or /VMA will not work in the A3000 bus. It was, in fact, impossible to legally use this on the A2000 bus. The E clock is, however, supported on the Zorro III bus, though its duty cycle may vary in some situations.

---

## ***Bus Memory Mapping and Cache Support***

Another change to the Zorro II implementation is that the bus mapping logic works a little differently. Zorro II address space is broken up into memory and I/O address space. Memory space is the standard 8 megabyte space from \$00200000-\$009FFFFFF. The I/O address space is mapped at \$00E80000-\$00EFFFFFF, and a new 1.5 megabyte section (previously reserved for motherboard devices) from \$00A00000-\$00B7FFFF. Zorro II cycles are not generated for non-Zorro II address space, even for 68000 space resources on the local bus. So, for example, a CPU access to chip memory would be visible to a Zorro II PIC in an A2000 backplane, but invisible to that same PIC in an A3000 backplane. Since this extra information on the Zorro II backplane can't be legally used by any PIC anyway, it should not be used by any existing A2000 PICs.

The reason for the two distinct mapping regions is for cache support of Zorro II PICs. All access by the local bus<sup>5</sup> master to Zorro II memory space results in the local bus cache enable signal being driven and a full port read (e.g., both bytes) regardless of the actual data transfer size being requested. A local bus access to Zorro II I/O space results in the local bus cache disable signal being driven and the data strobes for reads indicating the requested transfer size. This cache mapping mechanism was first implemented in the A2630 coprocessor card, so it's not an entirely new concept.

## ***Bus Synchronization Delays***

Due to the asynchronous nature of the local-to-expansion bus interface for Zorro II cycles, extra wait states may occasionally be added for local to expansion or expansion to local cycles. These are generally manifested as delays between consecutive cycles, since the bus controller is not going to require extra waiting during the cycle – things will have already been synchronized at that point. The synchronization problems get more difficult for Zorro II master access to local bus slaves, and as a result, wait states here are very common. The actual number of wait states generated in any case will be based on the particular implementation.

## ***Zorro II Master Access to Local Slaves***

The only supported local bus resource that's guaranteed accessible to a Zorro II expansion bus master as a slave device is chip bus memory. All I/O devices are implementation dependent and not supportable via DMA. Any attempted access to unsupported local bus resources as expansion slaves will result in an error condition being signaled on both the local and the expansion buses. Most other local bus resources, such as local bus fast memory, are located outside of Zorro II space on most systems and obviously not available to Zorro II masters.

---

<sup>5</sup> The *local bus*, motherboard bus, and CPU bus are the same thing; the immediate 680x0 bus connected directly to the CPU in an Amiga computer. Current Amiga computers typically support three distinct buses; the expansion bus, local bus, and chip bus. From the point of view of the expansion bus, the local and chip buses appear as a unified device which may be master or slave to the expansion bus.

---

### ***Bus Arbitration and Fairness***

The Zorro II bus is now arbitrated fairly. The normal slot-based order of precedence is given to requesting devices, just as in the A2000 implementation. As always, once a bus master assumes bus mastership, it has the bus for as long as it wants the bus (of course, trouble can result if a device takes the bus over for too long). Once a master gives up the bus, it will not be granted it back until all subsequent requests have been serviced.

Bus arbitration at its best will be slightly slower than in the A2000 implementation, due to the fairness logic, but it is impossible to jam the arbiter with asynchronous bus requests as in the A2000. The new style arbiter also holds off bus grants while hidden local bus cycles are in progress, so there's no guarantee of a minimum time between bus request and bus grant specified.

### ***Intelligent Cycle Spacing***

In order to permit a free intermix of Zorro II and Zorro III cycles, the bus control logic is capable of making intelligent decisions when spacing bus cycles. In some cases, a Zorro II cycle has some component that would naturally extend into a following cycle. The cycle spacing logic detects such a condition, and refuses to start a new cycle until the current one is complete, even if this extends beyond the defined bounds of a Zorro II cycle.

For Zorro II PICs that really follow the Zorro II specifications, this should have no effect. However, any Zorro II PIC that holds signals much beyond the end of a cycle, especially critical signals like /SLAVE and /DTACK, will likely incur additional wait states on the Zorro III bus. This is not intended as a license for making sloppy expansion card designs, just an acknowledgement that some Zorro II devices may cause a conflict with the faster Zorro III bus timings. The best approach is to make them work, even with a possible performance penalty.

### ***Bus Drive and Termination***

Finally, the Zorro III bus uses different bus termination than that in the A2000. The Zorro II specification didn't specify the termination expected; backplanes were built that didn't even have termination. The A2000 bus used a circuit consisting of a capacitor in series with a resistor to ground for most of the bus signals. This has good reflection cancelling properties without increasing crosstalk (a major concern on the 2-layer A2000 motherboard), but it does slow operations down measurably.

The main reason for the change on the A3000 backplane is to support the faster Zorro III bus modes. The multi-layer A3000 motherboard permits a reasonably high current bus without undue crosstalk. The thevenin termination makes switching logic levels start from a midpoint instead of a rail, especially for a bus coming out of tri-state (which, based on the Zorro III design, happens constantly). This should not cause problems with Zorro II cards, but it's conceivable that some cards may need to be adjusted to work in this bus (the Zorro III bus requires somewhat higher current capability than the Zorro II bus does. The A3000 does not support enough slots for loading to be a likely problem, but future Zorro III backplanes will have more slots and make this an important consideration).

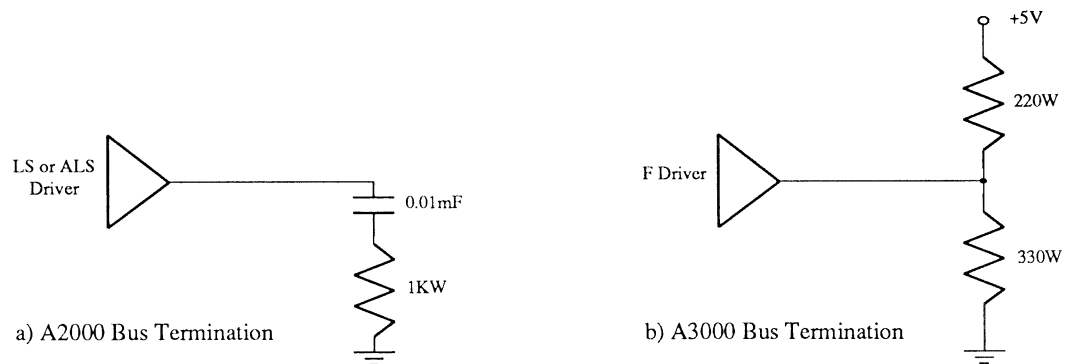

Figure K-2: A2000 vs. A3000 Bus Termination

### ***DMA Latency and Overlap***

Zorro II bus masters in a Zorro III backplane will, in many cases, receive a bus grant much sooner than they would in a standard Zorro II backplane. Additionally, in some cases, expansion bus cycles will overlap local bus cycles. The latency incurred on the Zorro II bus during heavy custom chip activity has been greatly reduced for any Zorro III bus master. This should be transparent to the card in question, though keep this in mind.

### ***Power Supply Differences***

The Zorro II bus is defined as supplying +5VDC @ 2 Amps to each slot, with one slot per backplane supplying 5.0VDC @ 4.0 Amps. The Zorro III bus only provides the 5.0VDC @ 2.0 Amps for each slot.

---

## ZORRO II BUS ARCHITECTURE

The Zorro II bus is a simple extension of the 68000 processor bus. Those without a working knowledge of the 68000 local bus will find *The 68000 User's Manual* from Motorola an excellent reference for many Zorro II issues. *The A500/A2000 Technical Reference Manual* from Commodore-Amiga is also required reading for any Zorro II design issues, as it includes a complete description of all the Commodore-Amiga details that aren't part of the 68000 specification.

The basic Zorro II bus is a buffered version of the 68000 processor bus, physically provided on a 100-pin one-piece connector. The bus is 16 bits wide, and provides 24 bits of addressing information. A bus cycle looks exactly like a 68000 bus cycle. The cycle is defined by an address strobe, terminated by a data transfer strobe, and qualified by a read/write strobe, some memory space qualifiers, and one or two byte selection strobes. The basic bus cycle runs for a total of four cycles of a 7.16MHz clock, though it can be extended to add wait states when required.

The Zorro II bus adds a number of features to the basic 68000 CPU bus. It supplies some Amiga system signals that are useful for expansion card designs, such as many of the Amiga system clocks. The bus provides a default data transfer signal, which expansion cards can easily use and modify rather than go to the trouble of creating their own. It provides a number of discrete interrupt lines which are mixed to provide the 68000 with its standard encoded interrupts. The 68000 bus arbitration protocol is used to allow multiple bus masters; arbitration of the bus requests are managed by the Zorro II bus controller to avoid contention between multiple masters. And, of course, the bus supplies a number of supply voltages for powering cards.

A powerful aspect of the Zorro II bus is its convention for automatically configuring expansion cards, AUTOCONFIG™. On system powerup, the system software interrogates each board to determine what kind of board is installed and how much memory space it needs on the bus. The software then tells each board where to reside in memory. The bus provides hardware lines to allow the boards to be configured in a daisy chained fashion regardless of which slots they occupy and to prevent damage to boards if accidentally configured to reside at the same memory location. Firmware standards also permit software to autoboot or autoinitialize any board, to match soft-loaded device drivers with individual boards, and to link memory boards into the appropriate system memory lists.

## SIGNAL DESCRIPTION

The Zorro II bus can be broken down into various logical signal groups. Some of these groups are unchanged in the Zorro III bus modes, others are drastically different. This section makes note of the original Zorro II name for each signal and the current Zorro III physical pin name for each signal, where different. Some of this information will be repeated in the Zorro III sections, where appropriate; nothing in this section is considered critical to understanding the Zorro III bus, but it is useful. As previously mentioned, the A2000 bus signals unsupported by the Zorro II

---

but it is useful. As previously mentioned, the A2000 bus signals unsupported by the Zorro II specification have been deleted from the Zorro III specification and the A3000 implementation of Zorro III; this section will, however, document those signals for reference purposes. Please see the Physical and Logical Signal Names section for a complete list with pin numbers of the various logical signals that appear on the physical bus during the different phases of the Zorro II and Zorro III bus cycles.

### **Power Connections**

The Zorro III expansion bus provides several different voltages designed to supply expansion devices. There are no changes here that affect Zorro II cards.

#### **Digital Ground (Ground)**

This is the digital supply ground used by all expansion cards as the return path for all expansion supplies.

#### **Main Supply (+5VDC)**

This is the main power supply for all expansion cards, and it is capable of sourcing large currents; each expansion slot can draw up to 2.0 Amps @ +5VDC. The extra power for one card in any backplane drawing up to 4.0 Amps @ +5VDC is no longer supported.

#### **Negative Supply (-5VDC)**

This is a negative version of the main supply, for small current loads only. There is no maximum load specified for the Zorro II bus on a per-slot basis; the A2000 implementation specifies 0.3 Amps @ -5VDC for the entire system.

#### **High Voltage Supply (+12VDC)**

This is a higher voltage supply, useful for communications cards and other devices requiring greater than digital voltage levels. This is intended for relatively small current loads only. There is no maximum load specified for the Zorro II bus on a per-slot basis; the A2000 implementation specifies 8.0 Amps @ +12VDC for the entire system, most of which is normally devoted to floppy and hard disk drive motors, not slots.

#### **Negative High Supply (-12VDC)**

Negative version of the high voltage supply, also commonly used in communications applications, and similarly intended for small loads only. There is no maximum load specified for the Zorro II bus on a per-slot basis; the A2000 implementation specifies 0.3 Amps @ -12VDC for the entire.

### **Clock Signals**

The Zorro III expansion bus provides clock signals for expansion boards. These clocks are for synchronous Zorro II designs and for other synchronous activity such as bus arbitration. While originally based on Amiga local bus clocks, these have no guaranteed relationship to any local bus activity in newer Amiga computers, but are maintained in Amiga computers as part of the expansion bus specification. The relationship between these clocks is illustrated in Figure K-3.

### /C1 Clock

This is a 3.58 MHz clock (3.55 MHz on PAL systems) that's synched to the falling edge of the 7M system clock.

### /C3 Clock

This is a 3.58 MHz clock (3.55 MHz on PAL systems) that's synched to the rising edge of the 7M system clock.

### CDAC Clock

This is a 7.16 MHz system clock (7.09 MHz on PAL systems) which trails the 7M clock by 90° (approximately 35ns).

### E Clock

This is the 68000 generated "E" clock, used for 6800 family peripherals driven by "E" and 6502 peripherals driven by  $\Phi_2$ . This clock is four 7M clocks high, six clocks low, as per the 68000 spec. Note that the bus does not support the rest of the 68000's 6800/6502 compatible interface; there may be better ways to clock such devices.

### 7M Clock

This is the 7.16 MHz system clock (7.09 MHz on PAL systems). This clock forms the basis for all Zorro II/68000 compatible activity, and for various other system functions, such as bus arbitration.

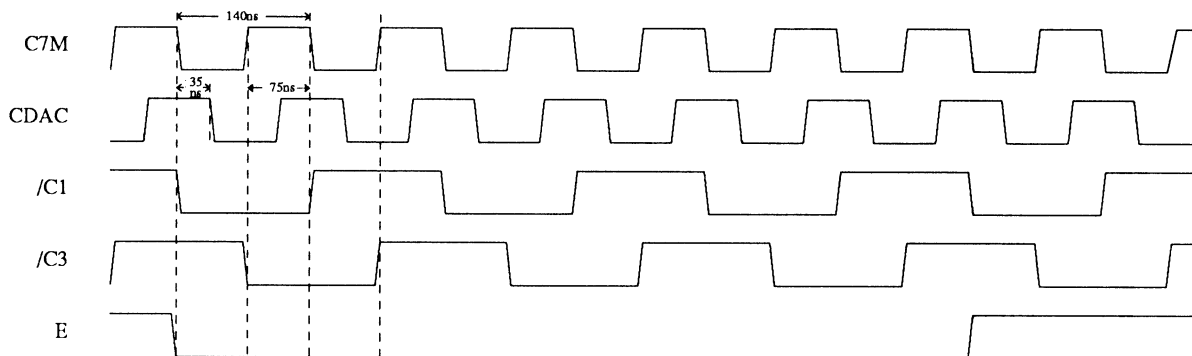

Figure K-3: Expansion Bus Clocks

## System Control Signals

The signals in this group are available for various types of system control; most of these have an immediate or near immediate effect on expansion cards and/or the system CPU itself.

### Bus Error (/BERR)

This is a general indicator of a bus fault condition. Any expansion card capable of detecting a hardware error relating directly to that card can assert /BERR when that bus error condition

---

is detected, especially any sort of harmful hardware error condition. This signal is the strongest possible indicator of a bad situation, as it causes all PICs to get off the bus, and will usually generate a level 2 exception on the host CPU. For any condition that can be handled in software and doesn't pose an immediate threat to hardware, notification via a standard processor interrupt is the better choice. The bus controller will drive /BERR in the event of a detected bus collision or DMA error (an attempt by a bus master to access local bus resources it doesn't have valid access permission for). All cards must monitor /BERR and be prepared to tri-state all of their on-bus output buffers whenever this signal is asserted. The current bus master should, if possible, retry the bus cycle after /BERR is negated unless conditions warrant otherwise. Since any number of devices may assert /BERR, and all bus cards must monitor it, any device that drives /BERR must drive with an open collector or similar device capable of sinking at least 12ma, and any device that monitors /BERR should place a minimal load on it (1 "F" type load or less). This signal is pulled high by a passive backplane resistor.

#### System Reset (/RST, /BUSRST) ≡ (/RESET, /IORST) for Zorro III

The bus supplies two versions of the system reset signal. The /RST signal is bidirectional and unbuffered, allowing an expansion card to hard reset the system. It should only be used by boards that need this reset capability, and is driven only by an open collector or similar device. The /BUSRST signal is a buffered output-only version of the reset signal that should be used as the normal reset input to boards not concerned with resetting the system on their own. All expansion devices are required to reset their autoconfiguration logic when /BUSRST is asserted. This signal is pulled high by a passive backplane resistor.

#### System Halt (/HLT)

This signal is similar to the 68000 processor halt signal, and is driven by a PIC with an open-collector or similar gate only. Its main use is to indicate a full-system reset. Based on the 68000 conventions, an I/O-only reset, such as initiated by the 680x0 RESET instruction, will drive only /RST and /BUSRST on the bus. A full-system reset, such as a powerup reset or a keyboard reset, drives /HLT low as well. PICs that wish to reset the system CPU as well as the bus and I/O devices drive /RST and /HLT, some bus devices such as processor cards may internally reset only on full-system resets. This signal is pulled high by a passive backplane resistor.

#### System Interrupts

Six of the decoded, level sensitive 680x0 interrupt inputs were originally available on the expansion bus, and these are labelled as /INT2, /INT6, /EINT1, /EINT4, /EINT5, /EINT7 on the Zorro II bus. Only the /INT2 and /INT6 interrupt inputs are actually supported by Commodore-Amiga as part of the Zorro II specification; the A2000 hardware did not provide the software with the required support mechanisms for the safe use of these lines. Each of these interrupt lines are shared by wired ORing, thus each line must be driven by an open-collector or equivalent output type, and all are pulled high by passive backplane resistors.



---

## **Slot Control Signals**

This group of signals is responsible for the control of operations between expansion slots.

### **Slave (/SLAVEN)**

Each slot has its own /SLAVE output, driven actively, all of which go into the collision detect circuitry. The ‘N’ refers to the expansion slot number of the particular /SLAVE signal. Whenever a Zorro II PIC is responding to an address on the bus, it must assert its /SLAVE output within 35ns of /AS asserted. The /SLAVE output must be negated at the end of a cycle within 50ns of /AS negated. Late /SLAVE assertion on a Zorro II bus can result in loss of data setup times and other problems. A late /SLAVE negation for Zorro II cards can cause a collision to be detected on the following cycle. While the Zorro III sloppy cycle logic eliminates this fatal condition, late /SLAVE negation can nonetheless slow system performance unnecessarily. If more than one /SLAVE output occurs for the same address, or if a PIC asserts its /SLAVE output for an address reserved by the local bus, a collision is registered and results in /BERR being asserted.

### **Configuration Chain (/CFGINN, /CFGOUTN)**

The slot configuration mechanism uses the bus signals /CFGOUTN and /CFGINN, where ‘N’ refers to the expansion slot number. Each slot has its own version of each, which make up the configuration chain between slots. Each subsequent /CFGIN is a result of all previous /CFGOUTs, going from slot 0 to the last slot on the expansion bus. During the AUTOCONFIG process, an unconfigured Zorro PIC responds to the 64K address space starting at \$00E80000 if its /CFGIN signal is asserted. All unconfigured PICs start up with /CFGOUT negated. When configured, or told to ‘shut up,’ a PIC will assert its /CFGOUT, which results in the /CFGIN of the next slot being asserted. The backplane passes on the state of the previous /CFGOUT to the next /CFGIN for any slot not occupied by a PIC, so there’s no need to sequentially populate the expansion bus slots.

### **Data Output Enable (DOE)**

This signal is used by an expansion card to enable the buffers on the data bus. The main Zorro II use of this line is to keep PICs from driving data on the bus until any other device is completely off the bus and the bus buffers are pointing in the correct direction. This prevents any contention on the data bus.

## **DMA Control Signals**

There are various signals on the expansion bus that coordinate the arbitration of bus masters. Native Zorro III bus masters use some of the same logical signals, but their arbitration protocol is considerably different.

### **PIC is DMA Owner (/OWN)**

This signal is asserted by an expansion bus DMA device when it becomes bus master. This output is to be treated as a wired-OR output between all expansion slots, any of which may have a PIC signaling bus mastership. Thus, this should be driven with an open-collector or similar output by any PIC using it. This signal is the main basis for data direction calculations between the local and expansion busses, and is pulled up by a backplane resistor.

#### Slot Specific Bus Arbitration (/BRN, /BGN)

These are the slot-specific /BRN and /BGN signals, where ‘N’ refers to the expansion slot number. The bus request from each board is taken in by the bus controller and ultimately used to take over the system from 680x0 on the local bus. The bus controller eventually returns one bus grant to the winner among all requesting PICs. From the point of view of the individual PIC, the protocol is very similar to that of the 68000 arbitration mechanism. The PIC asserts /BRN on the rising edge of 7M; some time later, /BGN is returned on the falling edge of 7M. The PIC waits for all bus activity to finish, asserts /OWN followed by /BGACK, then negates /BRN, assuming bus mastership. It retains mastership until it negates /BGACK followed by /OWN.

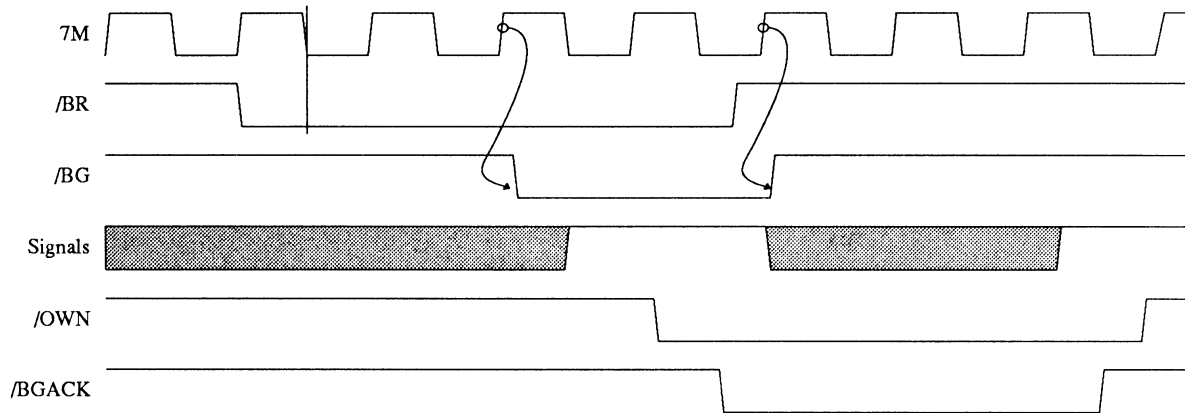

Figure K-4: Zorro II Bus Arbitration

#### Bus Grant Acknowledge (/BGACK)

Any Zorro II PIC that receives a bus grant asserts this signal as long as it maintains bus mastery. This signal may never be asserted until the bus grant has been received, /AS is negated, /DTACK is negated, and /BGACK itself is negated, indicating that all other potential bus masters have relinquished the bus. This output is driven as a wired-OR output, so all PICs must drive it with an open collector or equivalent device, and a passive pullup is supplied by the backplane.

#### Bus Want/Clear (/GBG) $\equiv$ (/BCLR) for Zorro III

This signal is asserted by the bus controller to indicate that a PIC wants to master the bus. A bus master assumes that the host CPU wants the bus, and that any time wasted as master is stealing time from the CPU. To avoid such waste, a master should use cache or FIFO to grab slow-coming data, and then transfer it all at once. /BCLR is asserted to indicate that additionally, another PIC wants the bus, and the current bus master should get off as soon as possible. This signal is equivalent to /GBG on the A2000 bus.

---

## **Addressing and Control Signals**

These signals are various items used for the addressing of devices in Zorro II mode by the local bus and any expansion DMA devices. Most of these signals are very much like 68000 generated bus signals bi-directionally buffered to allow any DMA device on the bus to drive the local bus when such a device is the bus master.

### **Read Enable (READ)**

This is the read enable for the bus, which is equivalent to the 68000's R/W output. READ asserted during a bus cycle indicates a read cycle, READ negated indicates a write cycle. Note that this signal may become valid in a cycle earlier than a 68000 R/W line would, but it remains valid at least as long at the cycle's end.

### **Address Bus (A1-A23)**

This is logically equivalent to the 68000's address bus, providing 16 megabytes of address space, although much of that space is not assigned to the expansion bus (see the memory map in Figure K-1).

### **Address Strobe (/AS) $\equiv$ (/CCS) for Zorro III**

This is equivalent to the 68000 /AS, called /CCS, for Compatibility Cycle Strobe, in the Zorro III nomenclature. The falling edge of this strobe indicates that addresses are valid, the READ line is valid, and a Zorro II cycle is starting. The rising edge signals the end of a Zorro II bus cycle, signaling the current slave to negate all slave-driven signals as quickly as possible. Note that /CCS, like /AS, can stay asserted during a read-modify-write access over multiple cycle boundaries. To correctly support such cycles, a device must consider both the state of /CCS and the state of the data strobes. Many current Zorro II cards don't correctly support this 680x0 style bus lock.

### **Data Bus (D0-D15)**

This is a buffered version of the 680x0 data bus, providing 16 bits of data accessible by word or either byte. A PIC uses the DOE signal to determine when the bus is to be driven on reads, and the data strobes to determine when data is valid on writes.

### **Data Strobes (/UDS, /LDS) $\equiv$ (/DS3, /DS2) for Zorro III**

These strobes fall on data valid during writes, and indicate byte select for both reads and writes. The lower strobe is used for the lower byte (even byte), the upper strobe is used for the upper byte (odd byte). There is one slight difference between these lines and the 68000 data strobes. On reads of Zorro II memory space, both /DS3 and /DS2 will be asserted, no matter what the actual size of the requested transfer is. This is required to support caching of the Zorro II memory space. For Zorro II I/O space, these strobes indicate the actual, requested byte enables, just as would a 68000 bus master.

---

#### Data Transfer Acknowledge (/DTACK)

This signal is used to normally terminate both Zorro bus cycles. For Zorro II modes, it is equivalent to the 68000's Data Transfer Acknowledge input. It can be asserted by the bus slave during a Zorro II cycle at any time, but won't be sampled by the bus master until the falling edge of the S4 state on the bus. Data will subsequently be latched on the S6 falling edge after this, and the cycle terminated with /AS negated during S7. If a Zorro II slave does nothing, this /DTACK will be driven by the bus controller with no wait states, making the bus essentially a 4-cycle synchronous bus. Any slow device on the bus that needs wait states has two options. It can modify the automatic /DTACK negating XRDY to hold off /DTACK. Alternately, it may assert /OVR to inhibit the bus controller's generation of /DTACK, allowing the slave to create its own /DTACK. Any /DTACK supplied by a slave must be driven with an open-collector or similar type output; the backplane provides a passive pullup.

#### Processor Status (FC0-FC2)

These signals are the cycle type or memory space bits, equivalent for the most part with the 68000 Processor Status outputs. They function mainly as extensions to the bus address, indicating which type of access is taking place. For Zorro II devices, any use of these lines must be gated with /BGACK, since they are not driven valid by Zorro II bus masters. However, when operating on the Zorro III backplane, Zorro II masters that don't drive the function codes will be seen generating an FC1 = 0, which results in a valid memory access. Zorro II cycles are not generated for invalid memory spaces when the CPU is the bus master.

#### /DTACK Override (/OVR)

This signal is driven by a Zorro II slave to allow that slave to prevent the bus controller's /DTACK generation. This allows the slave to generate its own /DTACK. The previous use of this line to disable motherboard memory mapping, which was unsupported on the A2000 expansion bus, has now been completely removed. The use of XDRY or /OVR in combination with /DTACK is completely up to the board designer – both methods are equally valid ways for a slave to delay /DTACK. In Zorro III mode, this pin is used for something completely different.

#### External Ready (XRDY)

This active high signal allows a slave to delay the bus controller's assertion of /DTACK, in order to add wait states. XRDY must be negated within 60ns of the bus master's assertion of /AS, and it will remain negated until the slave wants /DTACK. The /DTACK signal will be asserted by the bus controller shortly following the assertion of XRDY, providing the bus cycle is a S4 or later. XRDY is a wired-OR from all PICs, and as such, must be driven by an open collector or equivalent output. In Zorro III mode, this pin is used for something completely different.

---

## Zorro III Bus Architecture

While the Zorro II bus design was based in large part on an already existing bus cycle, the 68000 cycle, the Zorro III bus design had a much different set of preconditions. It is not modeled after any particular CPU specific bus protocol, but instead it's a logical outgrowth of both the need to support Zorro II cards on the same bus and the need to achieve various modern feature and performance goals. These goals were summarized in the Zorro Expansion Bus Introduction, now they'll be covered in greater detail here.

### BASIC ZORRO III BUS CYCLES

The basic Zorro III bus cycle is a multiplexed address/data cycle which supplies a full 32 bits worth of address and data per simple cycle. The cycle is a fully asynchronous cycle. The bus master for a given cycle supplies strobes to indicate when address is valid, write data is valid, and read data may be driven. In return, the bus slave for a cycle supplies a strobe to indicate that it is responding to a bus address, and a strobe to indicate that it is done with the bus data for a write cycle, or has supplied valid bus data for a read cycle. The minimum theoretical bus speed is governed only by setup and hold time requirements for the various bus signals. Actual bus speeds are always a function of the bus master and bus slave active for a given cycle. This is considerably different than the Zorro II bus, and for several good reasons, which are explained below.

#### *Design Goals*

For any computer bus, there are two basic possibilities concerning the fundamental operation of the bus; it's either synchronous or asynchronous. The difference is simple – the synchronous bus is ultimately tied to a clock of some sort, while the asynchronous bus has no defined relationship to any clock signal. While Motorola specifies the 68000 bus cycle as an asynchronous cycle, they're really referring to the fact that most 68000 inputs are internally synchronized with the bus clock, and therefore, synchronous setup times on the bus do not have to be met to avoid metastability.

But the 68000 bus, and the Zorro II bus by extension, are synchronous buses, based on a single bus clock (called E7M on the Zorro II bus). Most Zorro II signals are asserted relative to an edge of the bus clock, and most Zorro II inputs are sampled on an edge of the bus clock. The minimum Zorro II cycle is four bus clocks long, and every wait state added, regardless of the method, will result in a single additional bus clock wait, regardless of the asynchronous appearance of the termination and wait signals on the Zorro II bus.

The Zorro III bus is a fully asynchronous bus, in that all bus events are driven by strobes, and there is no reference clock. The choice of an asynchronous versus a synchronous bus design is governed by the intended application of the bus. Synchronous designs are preferred when a CPU and a memory system (e.g., master and slave) can be very tightly coupled to each other. Such designs generally require a tight adherence to timing based on the specific CPU. This is optimal

for tightly coupled systems, such the fast memory on the A3000 local bus. Synchronous designs can also be easier to do accurately, as the designer can use clock edges for scheduling events, and there's never any need to waste time in synchronizers to achieve a reliable design.

The design goals for an expansion bus are considerably different. While a fast memory circuit on a system motherboard can change for every new and better design, it's not feasible to require redesign of any significant number of expansion cards every time an improved motherboard design is created. And while a synchronous transfer can be optimal for matched clocks, it can be very inefficient for mismatched CPU and expansion clocks, as synchronizer delays must be introduced for any reliable operation. The A3000 project started with the need to support CPU systems at 16MHz and at 25MHz, and it's obvious that the growth of CPU clock speed will be here for some time to come. Zorro III cards are based on asynchronous handshaking between master and slave in both directions. This means that, as long as masters and slaves manage their own needs, any slave can work with any master. But as masters and slaves improve with technology, bus transfer speeds can automatically increase, without rendering any slower cards obsolete. The Zorro III bus attempts to address the needs of device expansion as much as the needs of memory expansion.

### **Simple Bus Cycle Operation**

The normal Zorro III bus cycle is quite different than the Zorro II bus in many respects. Figure K-5 shows the basic cycle. There is no bus clock visible on the expansion bus; the standard Zorro II clocks are still active during Zorro III cycles, but they have no relationship to the Zorro II bus cycle. Every bus event is based on a relationship to a particular bus strobe, and strobes are alternately supplied by master and slave.

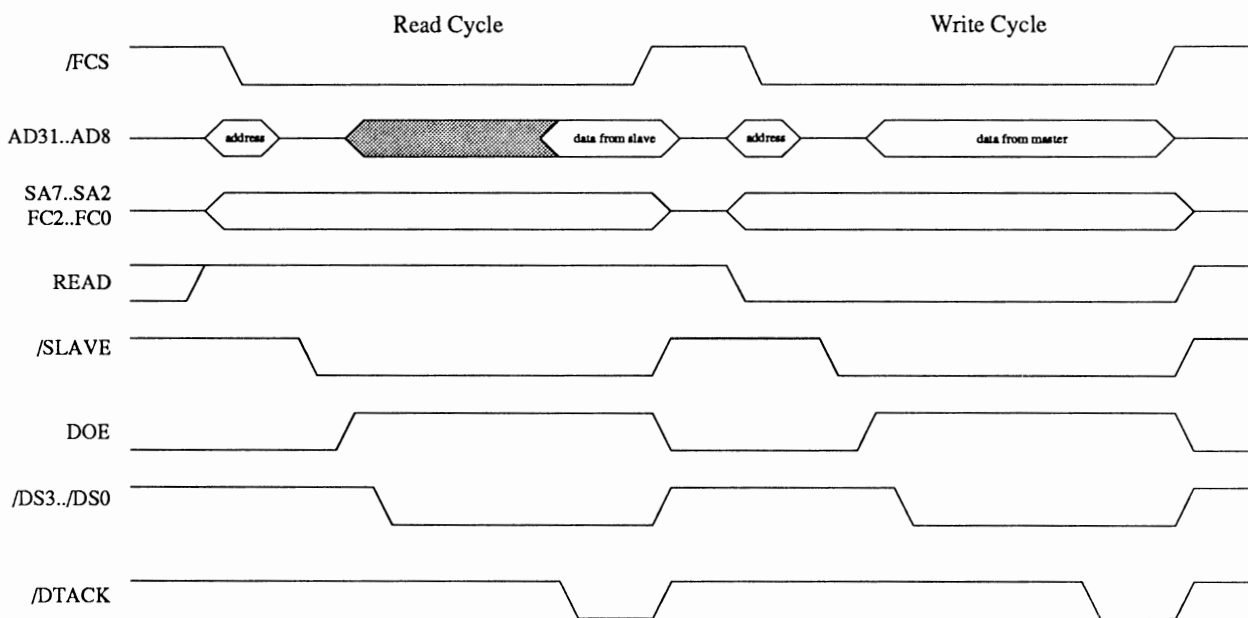

Figure K-5: Basic Zorro III Cycles

---

A Zorro III cycle begins when the bus master simultaneously drives addressing information on the address bus and memory space codes on the FCN lines, quickly following that with the assertion of the Full Cycle Strobe, /FCS; this is called the *address phase* of the bus. Any active slaves will latch the bus address on the falling edge of /FCS, and the bus master will tri-state the addressing information very shortly after /FCS is asserted. It's necessary only to latch A31-A8; the low order A7-A2 addresses and FCN codes are non-multiplexed.

As quickly as possible after /FCS is asserted, a slave device will respond to the bus address by asserting its /SLAVEN line, and possibly other special-purpose signals. The autoconfiguration process assigns a unique address range to each PIC base on its needs, just as on the Zorro II bus. Only one slave may respond to any given bus address; the bus controller will generate a /BERR signal if more than one slave responds to an address, or if a single slave responds to an address reserved for the local bus (this is called a bus collision, and should never happen in normal operation). Slaves don't usually respond to CPU memory space or other reserved memory space types, as indicated by the memory space code on the FCN lines (see the Signal Description section following this section for details).

The *data phase* is the next part of the cycle, and it's started when the bus master asserts DOE onto the bus, indicating that data operations can be started. The strobes are the same for both read and write cycles, but the data transfer direction is different.

For a read cycle, the bus master drives at least one of the data strobes /DSN, indicating the physical transfer size requested (however, cachable slaves must always supply all 32 bits of data). The slave responds by driving data onto the bus, and then asserting /DTACK. The bus master then terminates the cycle by negating /FCS, at which point the slave will negate its /SLAVEN line and tri-state its data. The cycle is done at this point. There are a few actions that modify a cycle termination, those will be covered in later sections.

The write cycle starts out the same way, up until DOE is asserted. At this point, it's the master that must drive data onto the bus, and then assert at least one /DSN line to indicate to the slave that data is valid and which data bytes are being written. The slave has the data for its use until it terminates the cycle by asserting /DTACK, at which point the master can negate /FCS and tri-state its data at any point. For maximum bus bandwidth, the slave can latch data on the falling edge of the logically ORed data strobes; the bus master doesn't sample /DTACK until after the data strobes are asserted, so a slave can actually assert /DTACK any time after /FCS.

## **ADVANCED MODE SUPPORT LOGIC**

The Zorro III bus provides support for some more advanced operations that weren't generally handled correctly on the Zorro II bus. Amiga computers have traditionally been supporting features that the more mainstream personal computers haven't. High speed DMA transfers and expansion coprocessors such as the Bridge Cards have been with the Amiga since the early days, and high performance main system CPUs with cache memory are now becoming common. The Zorro II bus never properly or easily supported such devices; the Zorro III bus attempts to make support of cache and coprocessor both possible and relatively straightforward. Other new features are covered in later sections.

---

## **Bus Locking**

The first advanced modification of the basic bus cycle is bus locking, via the `/LOCK` signal. Bus locking is a hardware convention that allows a bus master to guarantee several cycles will be atomic on the bus. This is necessary to support the sharing of special "mail-box" memory between a bus master and an alternate PIC-based processor; Bridge Cards are an example of this kind of device. The Zorro II bus itself supports bus locking via the 68000 convention. However, the 68000 style of bus locking is often difficult to implement, and support for it was often ignored in Zorro II designs, especially those not directly concerned with multiprocessor support.

The Zorro III mechanism involves no change to the basic bus cycle, other than the monitoring of this `/LOCK` signal, and as such is much more reasonable to support. The `/LOCK` signal is asserted by a bus master at address time and maintained across cycles to lock out shared memory coprocessors, allowing hardware backed semaphores to easily be used between such coprocessors. We expect multiprocessing will be a greater concern on the Zorro III bus than it is at present; video coprocessors, RISC devices, and special purpose processors for image processing or mathematics should find a comfortable home on the Zorro III bus.

## **Cache Support**

The other advanced cycle modifier on the Zorro III bus is the cache inhibit line, `/CINH`. On the Zorro II bus, there was originally no caching envisioned, and therefore no real support for caching of Zorro II PICs. First in the A2630 and later in the Zorro III bus' emulation of Zorro II, conventions were adopted to permit caching of Zorro II cards. These conventions aren't perfect; MMU tables will sometimes have to supplant this geographic mapping. While Zorro III doesn't have any cache consistency mechanisms for managing caches between several caching bus masters, it does allow cards that absolutely must not be cached to assert a cache inhibit line, `/CINH`, on a per-cycle basis (asserted at slave time by a responding slave). This cache management is basically the lowest level of a cache management system, mainly useful for support of I/O and other devices that shouldn't be cached. Software will be required for the higher levels of cache management.

## **MULTIPLE TRANSFER CYCLES**

The multiplexed address/data design of the Zorro III bus has some definite advantages. It allows Zorro III cards to use the same 100-pin connector as the Zorro II cards, which results in every bus slot being a 32-bit slot, even if there's an alternate connector in-line with any or all of the system slots; current alternate connectors include Amiga Video and PC-AT (now sometimes called ISA, for *Industry Standard Architecture*, now that it's basically beyond the control of IBM) compatible connectors. This design also makes implementation of the bus controller for a system such as the A3000 simpler. And it can result in lower cost for Zorro III PICs in many cases.



The main disadvantage of the multiplexed bus is that the multiplexing can waste time. The address access time is the same for multiplexed and non-multiplexed buses, but because of the multiplexing time, Zorro III PICs must wait until *data time* to assert data, which places a fixed limit on how soon data can be valid. The Zorro III Multiple Transfer Cycle is a special mode designed to allow the bus to approach the speed of a non-multiplexed design. This mode is especially effective for high speed transfers between memory and I/O cards.

As the name implies, the Multiple Transfer Cycle is an extension of the basic full cycle that results in multiple 32-bit transfers. It starts with a normal full cycle address phase transaction, where the bus master drives the 32-bit address and asserts the /FCS signal. A master capable of supporting a Multiple Transfer Cycle will also assert /MTCR at the same time as /FCS. The slave latches the address and responds by asserting its /SLAVEN line. If the slave is capable of multiple transfers, it'll also assert /MTACK, indicating to the bus master that it's capable of this extended cycle form. If either /MTCR or /MTACK is negated for a cycle, that cycle will be a basic full cycle.

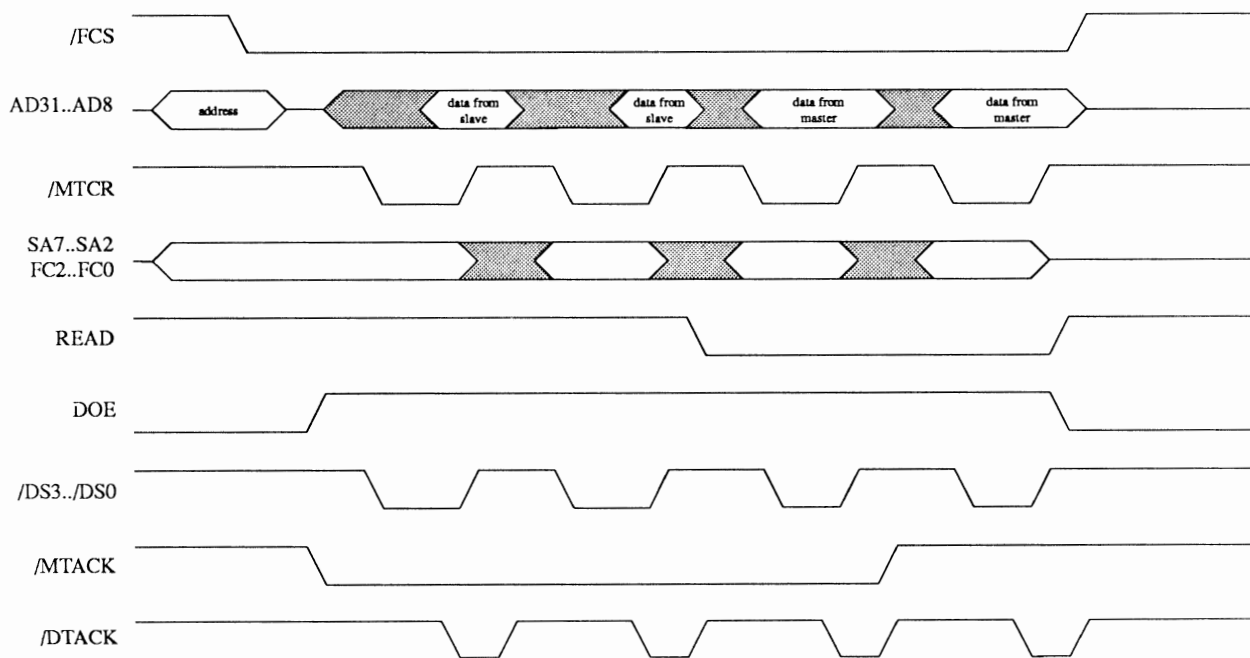

Figure K-6: Multiple Transfer Cycles

Assuming the multiple transfer handshake goes through, the multiple cycle continues to look similar to the basic cycle into the data phase. The bus master asserts DOE (possibly with write data) and the appropriate /DS<sub>N</sub>, then the slave responds with /DTACK (possibly with read data at the same time), just as usual. Following this, however, the cycle's character changes. Instead of terminating the cycle by negating /FCS, /DS<sub>N</sub>, and DOE, the master negates /DS<sub>N</sub> and /MTCR, but maintains /FCS and DOE. The slave continues to assert /SLAVEN, and the bus goes into what's called a *short cycle*.

---

The short cycle begins with the bus master driving the low order address lines A7-A2; these are the non-multiplexed addresses and can change without a new *address phase* being required (this is essentially a page mode, fully random accesses on this 256-byte page). The READ line may also change at this time. The master will then assert /MTCR to indicate to the slave that the short cycle is starting. For reads, the appropriate /DSN are asserted simultaneously with /MTCR, for writes, data and /DSN are asserted slightly after /MTCR. The slave will supply data for reads, then assert /DTACK, and the bus will terminate the short cycle and start into either another short cycle or a full cycle, depending on the multiple cycle handshaking that has taken place.

The question of whether a subsequent cycle will be a full cycle or a short cycle is answered by multiple cycle arbitration. If the master can't sustain another short cycle, it will negate /FCS and DOE along with /MTCR at the end of the current short cycle, terminating the full cycle as well. The master always samples the state of /MTACK on the falling edge of /MTCR. If a slave can't support additional short cycles, it negates /MTACK one short cycle ahead of time. On the following short cycle, the bus master will see that no more short cycles can be handled by the slave, and fully terminate the multiple transfer cycle once this last short cycle is done.

PICs aren't absolutely required to support Multiple Transfer Cycles, though it is a highly recommended feature, especially for memory boards. And of course, all PICs must act intelligently about such cycles on the bus; a card doesn't request or acknowledge any Multiple Transfer Cycle it can't support.

## QUICK BUS ARBITRATION

The Zorro II bus does an adequate job of supporting multiple bus masters, and the Zorro III bus extends this somewhat by introducing fair arbitration to Zorro II cards. However, some desirable features cannot be added directly to the Zorro II arbitration protocol. Specifically, Zorro III bus arbitration is much faster than the Zorro II style, it prohibits bus hogging that's possible under the Zorro II protocol, and it supports intelligent bus load balancing.

Load balancing requires a bit of explanation. A good analogy is to that of software multitasking; there, an operating system attempts to slice up CPU time between all tasks that need such time; here, a bus controller attempts to slice up bus time between all masters that need such time. With preemptive multitasking such as in the Amiga and UNIX OSs, equal CPU time can be granted to every task (possibly modified by priority levels), and such scheduling is completely under control of the OS; no task can hog the CPU time at the expense of all others. An alternate multitasking scheme is a popular add-on to some originally non-multitasking operating systems lately. In this scheme, each task has the CPU until it decides to give up the CPU, basically making the effectiveness of the CPU sharing at the mercy of each task. This is exactly the same situation with masters on the Zorro II bus. The Zorro III arbitration mechanism attempts to make bus scheduling under the control of the bus controller, with masters each being scheduled on a cycle-by-cycle basis.

When a Zorro III PIC wants to master the bus, it *registers* with the bus controller. This tells the bus controller to include that PIC in its scheduling of the expansion bus. There may be any number of other PICs registered with the bus controller at any given time. The CPU is always

scheduled expansion bus time, and other local bus devices, such as a hard disk controller, may be registered from time to time.

Once registered, a PIC sits idle until it receives a *grant* from the bus controller. A grant is permission from the bus controller that allows the PIC to master the Zorro III bus for one full cycle. A PIC always gets one full cycle of bus time when given a grant, and assuming it stays registered, it may receive additional full cycles. Within the full cycle, the PIC may run any number of Multiple Transfer Cycles, assuming of course the responding slave supports such cycles. For multiprocessor support, a PIC will be granted multiple atomic full cycles if it locks the bus. This feature is **only** for support of hardware semaphores and other such multiprocessor needs; it is not intended as a means of bus hogging!

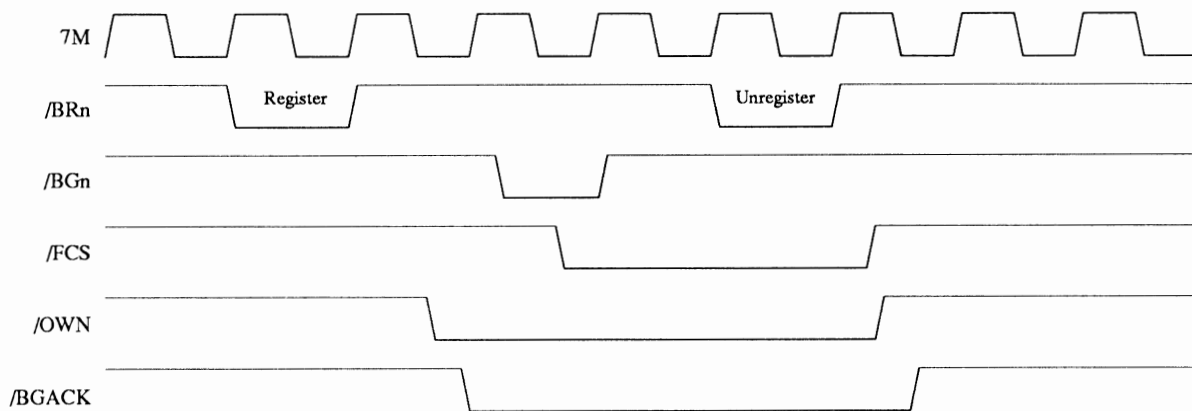

Figure K-7: Zorro III Bus Arbitration

Figure K-7 shows the basics of Zorro III bus arbitration. While it uses some of the same signals as the 680x0 inspired Zorro II bus arbitration mechanism, it has nothing to do with 680x0 bus arbitration; the /BRN and /BGN signals should be thought of as completely new signals. In order to register with the bus controller as a bus master, a PIC asserts its private /BRN strobe on the rising edge of the 7M clock, and negates it on the next rising edge. The bus controller will indicate mastership to a registered bus master by asserting its /BGN.

Once granted the bus, the PIC drives only the standard cycle signals: addresses, /FCS, /EDSN, data, etc. in a full cycle. The bus controller manages the assertion of /OWN and /BGACK, which are important only for bus management and Zorro II support. While a scheduling scheme isn't part of this bus specification, the bus master will only be guaranteed one bus cycle at a time. The /BGN line is negated shortly after the master asserts /FCS unless the bus controller is planning to grant multiple full cycles to the master. A locked bus will force the controller to grant multiple full cycles. Any master that works better with multiple cycles, such as devices with buffers to empty into memory, should run a Multiple Transfer Cycle to transfer several longwords during the same full cycle. For this reason, slave cards are encouraged to support Multiple Transfer Cycles, even if they don't necessarily run any faster during them.

---

Once a registered bus master has no more work to do, it unregisters with the bus controller. This works just like registering – the PIC asserts /BRN on the rise of 7M, then negates it on next rising 7M. This is best done during the last cycle the bus master requires on the bus. If a registered master gets a grant before unregistering and has no work to do, it can unregister without asserting /FCS, to give back the bus without running a cycle. It's always far better to make sure that the master unregisters as quickly as possible. Bus timeout causes an automatic unregistering of the registered master that was granted that timed-out cycle; this guarantees that an inactive registered master can't drag down the system. If a master sees a /BERR during a cycle, it should terminate that cycle immediately and re-try the same cycle. If the retried cycle results in a /BERR as well, nothing more can be done in hardware; notification of the driver program is the usual recourse.

The bus controller may have to mix Zorro II style bus arbitration in with Zorro III arbitration, as Zorro II and Zorro III cards can be freely mixed in a backplane. Because of this, Multiple Transfer Cycles, and the self-timed nature of Zorro III cards, there's no way to guarantee the latency between bus grants for a Zorro III card. The bus controller does, however, make sure that all masters are fairly scheduled so that no starvation occurs, if at all possible. Zorro III cards must use Zorro III style bus arbitration; although current Zorro III backplanes can't differentiate between Zorro II and Zorro III cards when they request (other than by the request mechanism), it can't be assumed that a backplane will support Zorro III cycles with Zorro II mastering, or visa-versa.

## QUICK INTERRUPTS

While the Zorro II bus has always supported shared interrupts, the Zorro III bus supports a mechanism wherein the interrupting PIC can supply its own vector. This has the potential to make such vectored interrupts much faster than conventional Zorro II chained interrupts, arbitrating the interrupting device in hardware instead of software.

A PIC supporting quick interrupts has on-board registers to store one or more vector numbers; the numbers are obtained from the OS by the device driver for the PIC, and the PIC/driver combination must be able to handle the situation in which no additional vectors are available. During system operation, this PIC will interrupt the system in the normal manner, by asserting one of the bus interrupt lines. This interrupt will cause an interrupt vector cycle to take place on the bus. This cycle arbitrates in hardware between all PICs asserting that interrupt, and it's a completely different type of Zorro III cycle, as illustrated in Figure 9-8.

The bus controller will start an interrupt vector cycle in response to an interrupt asserted by any PIC. This cycle starts with /FCS and /MTCR asserted, a FC code of 7 (CPU space), a CPU space cycle type, given by address lines A16-A19, of 15, and the interrupt number, which is on A1-A3 (A1 is on the /LOCK line, as in Zorro II cycles). The interrupt numbers 2 and 6 are currently defined, corresponding to /INT2 and /INT6 respectively; all others are reserved for future use. At this point, called the *polling phase*, any PIC that has asserted an interrupt and wants to supply a vector will decode the FC lines, the cycle type, match its interrupt number against the one on the bus, and assert /SLAVEN if a match occurs. Shortly thereafter, the /MTCR line is negated, and the slaves all negate /SLAVEN. But the cycle doesn't end.

The next step is called the vector phase. The bus controller asserts one /SLAVEN back to one of the interrupting PICs, along with /MTCR and /DS0, but no addresses are supplied. That PIC will then assert its 8 bit vector onto the logical D0-D7 (physically AD15-AD8) of the 32-bit data bus and /DTACK, as quickly as possible, thus terminating the cycle. The speed here is very critical; an automatic autovector timeout will occur very quickly, as any actual waiting that's required for the quick interrupt vector is potentially delaying the autovector response for Zorro II style interrupts. A PIC stops driving its interrupt when it gets the response cycle; it must also be possible for this interrupt to be cleared in software (e.g., the PIC must make choice of vectoring vs. autovectoring a software issue).

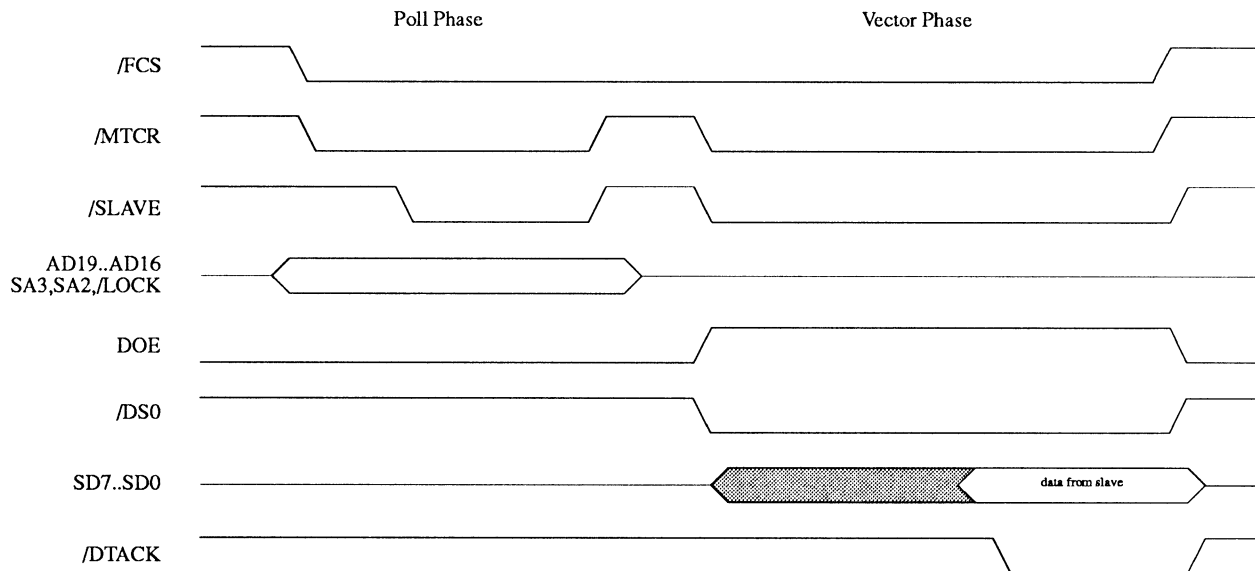

Figure K-8: Interrupt Vector Cycle

## COMPATIBILITY WITH ZORRO II DEVICES

As detailed in the Zorro II Compatibility section, the Zorro III bus supports a bus cycle mode very similar to the 68000-based Zorro II bus, and is expected to be compatible with all properly designed Zorro II PICs. As shown in Figure 9-1, Zorro II and Zorro III expansion spaces are geographically mapped on the Zorro III bus. The mapping logic resides on the bus, and operates on the bus address presented for any cycle. Every cycle starts out assuming a Zorro III cycle, but the mapping logic will inscribe a Zorro II cycle within the Zorro III cycle if the address range is right. Figure K-9 details the bus action for this mode.

The cycle starts out with the usual address phase activity; the bus master asserts /FCS after asserting the full 32-bit address onto the address bus. The bus decoder maps the bus address asynchronously and quickly, so that by the time /FCS is asserted, the memory space is determined. A Zorro II space access will cause A8-A23 to remain asserted, rather than being tri-stated along with A24-A31, as the Zorro III cycle normally does. The bus controller synchs the

asynchronous /FCS on the falling edge of CDAC, then drives /CCS (the /AS equivalent) out on the rising edge of 7M, based on that synched /FCS. For a read cycle, /DS3 and/or /DS2 (the /UDS and /LDS replacements, respectively) would be asserted along with /CCS; write cycles see those lines asserted on the next rising edge of 7M, at S4 time. The DOE line is also asserted at the start of S4.

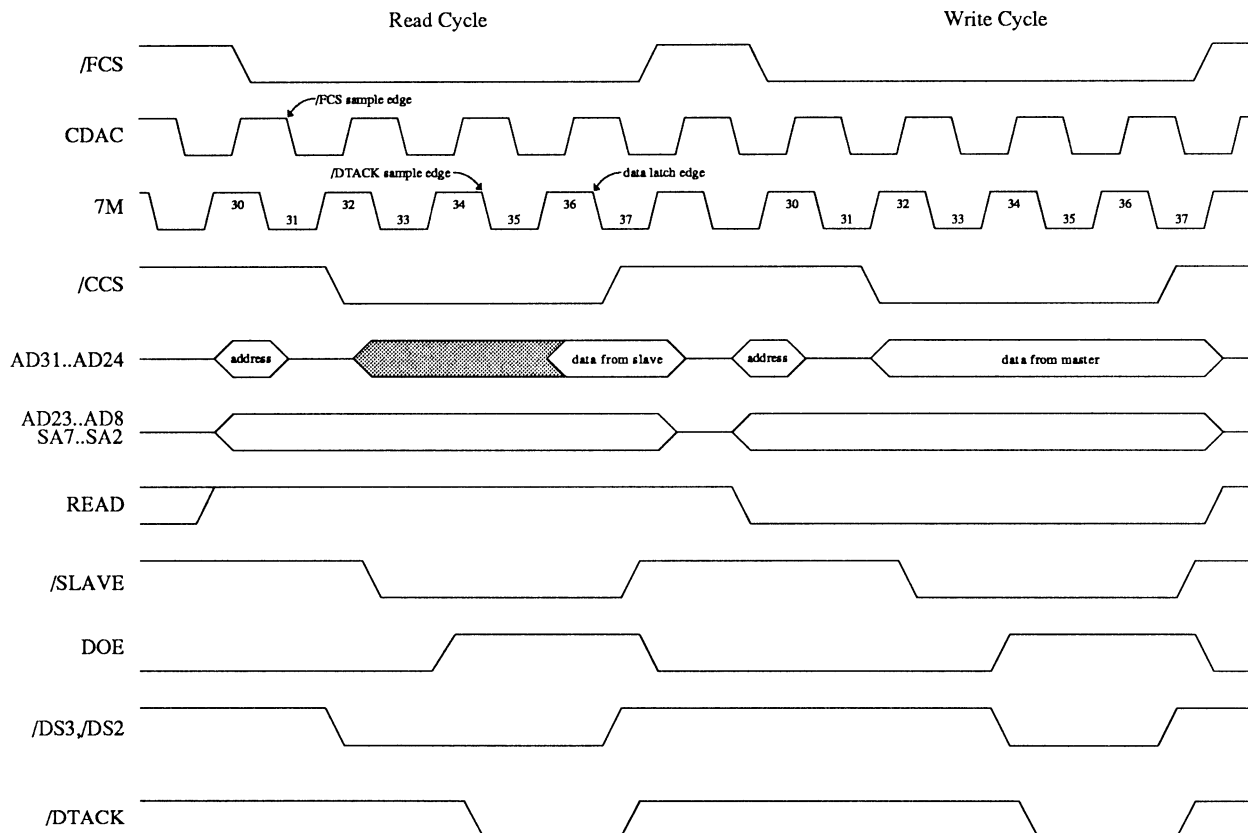

Figure K-9: Zorro II Within Zorro III

The bus controller starts to sample /DTACK on the falling edge of 7M between S4 and S5, adding wait states until /DTACK is encountered. As per Zorro II specs, the PIC need not create a /DTACK unless it needs that level of control; there are Zorro II signals to delay the controller-generated /DTACK, or take it over when necessary. The controller will drive its automatic /DTACK at the start of S4, leaving plenty of time for the sampling to come at S5. Once a /DTACK is encountered, cycle termination begins. The controller latches data on the falling 7M edge between S6 and S7, and also negates /CCS and the /DSN at this time. Shortly thereafter, the controller negates /DTACK (when controlling it), DOE, and tri-states the data bus, getting ready for the next cycle.

---

## Signal Description

The signals detailed here are the Zorro III mode signals. While some of this information is the same as in the Zorro II signal description in the Zorro II Compatibility section, many bus signals that seem alike behave differently in Zorro III mode than Zorro II mode. These can be a very important differences; thus the complete set of signals is detailed here.

### POWER CONNECTIONS

The expansion bus provides several different voltages designed to supply expansion devices. These are basically the same for the Zorro III bus as they were for the Zorro II bus, with the exception of one pin, and that the specification has been clarified a bit. Note that all Zorro III PICs must list their power consumption specifications.

#### Digital Ground (Ground)

This is the digital supply ground used by all expansion cards as the return path for all expansion supplies.

#### Main Supply (+5VDC)

This is the main power supply for all expansion cards, and it is capable of sourcing large currents; each PIC can draw up to 2.0 Amps @ +5VDC.

#### Negative Supply (-5VDC)

This is a negative version of the main supply, for small current loads only; each PIC can draw up to 60 mA @ -5VDC.

#### High Voltage Supply (+12VDC)

This is a higher voltage supply, useful for communications cards and other devices requiring greater than digital voltage levels. This is intended for relatively small current loads only; each PIC can draw up to 500mA @ +12VDC.

#### Negative High Supply (-12VDC)

Negative version of the high voltage supply, also used in communications applications, and similarly intended for small loads only; each PIC can draw up to 60 mA @ -12VDC.

---

## CLOCK SIGNALS

The expansion bus provides clock signals for expansion boards. The main use for these clocks on Zorro III cards is bus arbitration clocking. There is no relationship between any of these clocks and normal Zorro III bus activity. The relationship between these clocks is illustrated in *Figure 9-3*.

### /C1 Clock

This is a 3.58 MHz clock (3.55 MHz on PAL systems) that's synched to the falling edge of the 7M system clock.

### /C3 Clock

This is a 3.58 MHz clock (3.55 MHz on PAL systems) that's synched to the rising edge of the 7M system clock.

### CDAC Clock

This is a 7.16 MHz system clock (7.09 MHz on PAL systems) which trails the 7M clock by 90° (approximately 35ns).

### E Clock

This is the 68000 generated "E" clock, used for 6800 family peripherals driven by "E" and 6502 peripherals driven by  $\Phi_2$ . This clock is four 7M clocks high, six clocks low, as per the 68000 spec.

### 7M Clock

This is the 7.16 MHz system clock (7.09 MHz on PAL systems). This clock drives the bus master registration mechanism for Zorro III bus masters.

## SYSTEM CONTROL SIGNALS

The signals in this group are available for various types of system control; most of these have an immediate or near immediate effect on expansion cards and/or the system CPU itself.

### Hardware Bus Error/Interrupt (/BERR)

This is a general indicator of a bus fault or special condition of some kind. Any expansion card capable of detecting a hardware error relating directly to that card can assert /BERR when that bus error condition is detected, especially any sort of harmful hardware error condition. This signal is the strongest possible indicator of a bad situation, as it causes all PICs to get off the bus, and will usually generate a level 2 exception on the host CPU. For any condition that can be handled in software and doesn't pose an immediate threat to hardware, notification via a standard processor interrupt is the better choice. The bus controller will drive /BERR in the event of a detected bus collision or DMA error (an attempt by a bus master to access local bus resources it doesn't have valid access permission for). All cards must monitor /BERR and be prepared to tri-state all of their on-bus output buffers whenever this signal is asserted. An expansion bus master will attempt to retry a cycle



---

aborted by a single /BERR and notify system software in the case of two subsequent /BERR results. Since any number of devices may assert /BERR, and all bus cards must monitor it, any device that drives /BERR must drive with an open collector or similar device, and any device that monitors /BERR should place a minimal load on it. This signal is pulled high by a passive backplane resistor.

Note that, especially for the slave device being addressed, that /BERR alone is not always necessarily an indication of a bus failure in the pure sense, but may indicate some other kind of unusual condition. Therefore, a device should still respond to the bus address, if otherwise appropriate, when a /BERR condition is indicated. It simply tri-states its bus buffers and other outputs, and waits for a change in the bus state. If the /BERR signal is negated with the cycle unterminated, the special condition has been resolved and the slave responds to the rest of the cycle as it normally would have. If the cycle is terminated by the bus master, the resolution of the special condition has indicated that the addressed slave is not needed, and so the cycle terminates without the slave being used.

#### System Reset (/RESET, /IORST)

The bus supplies two versions of the system reset signal. The /RESET signal is bi-directional and unbuffered, allowing an expansion card to hard reset the system. It should only be used by boards that need this reset capability, and is driven only by an open collector or similar device. The /IORST signal is a buffered output-only version of the reset signal that should be used as the normal reset input to boards not concerned with resetting the system on their own. All expansion devices are required to reset their autoconfiguration logic when /IORST is asserted. These signals are pulled high by passive backplane resistors.

#### System Halt (/HLT)

This signal is driven, along with /RESET, to assert a full-system reset. A full-system reset is asserted on a powerup reset or a keyboard reset; any PIC that needs to differentiate between full system and I/O reset should monitor /HLT and /IORST unless it also needs to drive a reset condition. This is driven with an open-collector output, or the equivalent, and pulled up by a backplane resistor.

#### System Interrupts

Two of the decoded, level-sensitive 680x0 interrupt inputs are available on the expansion bus, and these are labeled as /INT2 and /INT6. Each of these interrupt lines is shared by wired ORing, thus each line must be driven by an open-collector or equivalent output type. Zorro III interrupts can be handled Zorro II style, via autovectors and daisy-chained polling, or they can be vectored using the quick interrupt protocol described in the Bus Architecture section. Zorro II and Zorro III systems originally provided /INT1, /INT4, /INT5, and /INT7 lines as well, but as these were never properly supportable by system software, they have been eliminated. Those lines are considered reserved for future use in a Zorro III system.

---

## SLOT CONTROL SIGNALS

This group of signals is responsible for the control of operations between expansion slots.

### Slave (/SLAVEN)

Each slot has its own /SLAVEN output, driven actively, all of which go into the collision detect circuitry. The “N” refers to the expansion slot number of the particular /SLAVE signal. Whenever a Zorro III PIC is responding to an address on the bus, it must assert its /SLAVEN output very quickly. If more than one /SLAVEN output occurs for the same address, or if a PIC asserts its /SLAVEN output for an address reserved by the local bus, a collision is registered and the bus controller asserts /BERR. The bus controller will assert /SLAVEN back to the interrupting device selected during a Quick Interrupt cycle, so any device supporting Quick Interrupts must be capable of tri-stating its /SLAVEN; all others can drive SLAVEN with a normal active output.

### Configuration Chain (/CFGINN, /CFGOUTN)

The slot configuration mechanism uses the bus signals /CFGOUTN and /CFGINN, where “N” refers to the slot number. Each slot has its own version of both signals, which make up the configuration chain between slots. Each subsequent /CFGINN is a result of all previous /CFGOUTs, going from slot 0 to the last slot on the expansion bus. During the autoconfiguration process, an unconfigured Zorro III PIC responds to the 64K address space starting at either \$00E80000 or \$FF000000 if its /CFGINN signal is asserted. All unconfigured PICs start up with /CFGOUTN negated. When configured, or told to “shut up,” a PIC will assert its /CFGOUTN, which results in the /CFGINN of the next slot being asserted. Backplane logic automatically passes on the state of the previous /CFGOUTN to the next /CFGINN for any slot not occupied by a PIC, so there’s no need to sequentially populate the expansion bus slots.

### Backplane Type Sense (SenseZ3)

This line can be used by the PIC to determine the backplane type. It is grounded on a Zorro II backplane, but floating on a Zorro III backplane. The Zorro III PIC connects this signal to a 1K pullup resistor to generate a real logic level for this line. It’s possible, though more complicated, to build a Zorro III PIC that can actually run in Zorro II mode when in a Zorro II backplane. It’s hardly necessary or required to support this backward compatibility mechanism, and in many cases it will be impractical. The Zorro III specification does require that this signal be used, at least, to shut the card down and pass /CFGIN to /CFGOUT when in a Zorro II backplane.

## DMA CONTROL SIGNALS

There are various signals on the expansion bus that coordinate the arbitration of bus masters. Zorro II bus masters use some of the same logical signals, but their arbitration protocol is considerably different.

#### PIC is DMA Owner (/OWN)

This is asserted by the bus controller when a master is about to go on the bus and indicates that some master owns the bus. Zorro II bus masters drive this, and some Zorro III slaves may find a need to monitor it, or /BGACK, to determine who's the bus master. This is ordinarily not important to Zorro III PICs, and they may not drive this line.

#### Slot Specific Bus Arbitration (/BRN, /BGN)

These are the slot-specific /BRN and /BGN signals, where "N" refers to the expansion slot number. The bus request from each board is taken in by the bus controller and ultimately used to take over the system from the primary bus master, which is always the local master. Zorro III PICs toggle /BRN to register or unregister as a master with the bus controller. /BGN is asserted to one registered PIC at a time, on a cycle by cycle basis, to indicate to the PIC that it gets the bus for one full cycle.

#### Bus Grant Acknowledge (/BGACK)

Asserted by the bus controller when a master is about to go on the bus. As with /OWN, most Zorro III PICs ignore this signal, and none may drive it.

#### Bus Want/Clear (/BCLR)

This signal is asserted by the bus controller to indicate that a PIC wants to master the bus; Zorro III cards can use this to determine if any Zorro II bus requests are pending; Zorro III bus requests don't affect /BCLR.

## ADDRESS AND RELATED CONTROL SIGNALS

These signals are various items used for the addressing of devices in Zorro III mode by bus masters either on the bus or from the local bus. The bus controller translates local bus signals (68030 protocol on the A3000) into Zorro III signals; masters are responsible for creating the appropriate signals via their own bus control logic.

#### Read Enable (READ)

Read enable for the bus; READ is asserted by the bus master during a bus cycle to indicate a read cycle, READ is negated to indicate a write cycle. READ is asserted at address time, prior to /FCS, for a full cycle, and prior to /MTCR for a short cycle. READ stays valid throughout the cycle; no latching required.

#### Multiplexed Address Bus (A8-A31)

These signals are driven by the bus master during address time, prior to the assertion of /FCS. Any responding slave must latch as many of these lines as it needs on the falling edge of /FCS, as they're tri-stated very shortly after /FCS goes low. These addresses always include all configuration address bits for normal cycles, and the cycle type information for Quick Interrupt cycles.

#### Short Address Bus (A2-A7)

These signals are driven by the bus master during address time, prior to the assertion of /FCS, for full cycles, and prior to the assertion of /MTCR for short cycles. They stay valid for the entire full or short cycle, and as such do not need to be latched by responding slaves.

### Memory Space (FC<sub>0</sub>-FC<sub>2</sub>)

The memory space bits are an extension to the bus address, indicating which type of access is taking place. Zorro III PICs must pay close attention to valid memory space types, as the space type can change the type of the cycle driven by the current bus master. The encoding is the same as the valid Motorola function codes for normal accesses. These are driven at address time, and like the low short address, are valid for an entire short or full cycle.

FC <sub>0</sub> FC <sub>1</sub>	FC <sub>2</sub>	Address	Space Type	Z3 Response
0	0	0	Reserved	None
0	0	1	User Data Space	Memory
0	1	0	User Program Space	Memory
0	1	1	Reserved	None
1	0	0	Reserved	None
1	0	1	Supervisor Data Space	Memory
1	1	0	Supervisor Program Space	Memory
1	1	1	CPU Space	Interrupts

Table K-1: Memory Space Type Codes

### Compatibility Cycle Strobe (/CCS)

This is equivalent to the Zorro II address strobe, /AS. A Zorro III PIC doesn't use this for normal operation, but may use it during the autoconfiguration process if configuring at the Zorro II address. AUTOCONFIG cycles at \$00E8xxxx always look like Zorro II cycles, though /FCS and the full Zorro III address is available, so a card can use either Zorro II or Zorro III addressing to start the cycle. However, using the /CCS strobe can save the designer the need to compare the upper 8 bits of the address. Data must be driven Zorro II style, though if the /DSN lines are respected for reads, /CINH is asserted, and /MTACK is negated, the resulting Zorro III cycle will fit within the expected Zorro II cycle generated by the bus controller. Yes, that should sound weird; it's based on the mapping of Zorro II vs. Zorro III signals, and of course the fact that /FCS always starts any cycle. Also note that a bus cycle with /CCS asserted and /FCS negated is always a Zorro II PIC-as-master cycle. Many Zorro III cards will instead configure at the alternate \$FF00xxxx base address, fully in Zorro III mode, and thus completely ignore this signal.

### Full Cycle Strobe (/FCS)

This is the standard Zorro III full cycle strobe. This is asserted by the bus master shortly after addresses are valid on the bus, and signals the start of any kind of Zorro III bus cycle. Shortly after this line is asserted, all the multiplexed addresses will go invalid, so in general, all slaves latch the bus address on the falling edge of /FCS. Also, /BGN line is negated for a Zorro III mastered cycle shortly after /FCS is asserted by the master.

---

## DATA AND RELATED CONTROL SIGNALS

The data time signals here manage the actual transfer of data between master and slave for both full and short cycle types. The burst mode signals are here too, as they're basically data phase signals even though they don't only concern the transfer of data.

### Data Output Enable (DOE)

This signal is used by an expansion card to enable the buffers on the data bus. The bus master drives this line to keep slave PICs from driving data on the bus until *data time*.

### Data Bus (D0-D31)

This is the Zorro III data bus, which is driven by either the master or the slave when DOE is asserted by the master (based on READ). It's valid for reads when /DTACK is asserted by the slave; on writes when at least one of /DS<sub>N</sub> is asserted by the master, for all cycle types.

### Data Strobes (/DS<sub>N</sub>)

These strobes fall during *data time*; /DS<sub>3</sub> strobes D<sub>24</sub>-D<sub>31</sub>, while /DS<sub>0</sub> strobes D<sub>0</sub>-D<sub>7</sub>. For write cycles, these lines signal data valid on the bus. At all times, they indicate which bytes in the 32-bit data word the bus master is actually interested in. For cachable reads, all four bytes must be returned, regardless of the value of the sizing strobes. For writes, only those bytes corresponding to asserted /DS<sub>N</sub> are written. Only contiguous byte cycles are supported; e.g., /DS<sub>3-0</sub> = 2, 4, 5, 6, or 10 is invalid.

### Data Transfer Acknowledge (/DTACK)

This signal is used to normally terminate a Zorro III cycle. The slave is always responsible for driving this signal. For a read cycle, it asserts /DTACK as soon as it has driven valid data onto the data bus. For a write cycle, it asserts /DTACK as soon as it's done with the data. Latching the data on writes may be a good idea; that can allow a slave to end the cycle before it has actually finished writing the data to its local memory.

### Cache Inhibit (/CINH)

This line is asserted at the same time as /SLAVEN to indicate to the bus master that the cycle must not be cached. If a device doesn't support caching, it must assert /CINH and actually obey the /DS<sub>N</sub> byte strobes for read cycles. Conversely, if the device supports caching, /CINH is negated and the device returns all four bytes valid on reads, regardless of the actual supplied /DS<sub>N</sub> strobes.

### Multiple Cycle Transfers (/MTCR, /MTACK)

These lines comprise the Multiple Transfer Cycle handshake signals. The bus master asserts /MTCR at the start of *data time* if it's capable of supporting Multiple Transfer Cycles, and the slave asserts /MTACK with /SLAVEN if it's capable of supporting Multiple Transfer Cycles. If the handshake goes through, /MTCR strobes in the short address and write data as long as the full cycle continues.

## Timing

Some of this information is considered preliminary. Nothing is expected to get any more speed critical, but as mentioned previously, the testing of Zorro III designs has just started at the time of this writing, final bus controllers are not yet available, and only a few PIC designs have even been conceived.

This section covers the various timing specifications in detail for different Zorro III operations. It's important to realize that this timing information is a specification. Actual Zorro III systems may offer much more relaxed timings. Today. The whole point of the specification is that as long as all Zorro III PICs and all Zorro III backplanes base things on the timings given here, they'll always work together nicely. Any design based on the actual characteristics of any particular backplane will very likely wind up working only on that particular backplane.

The philosophy of timing on the Zorro III bus is to keep things as simple as possible without compromising the performance goals of the bus. Zorro III PICs are expected to be based on F-Series or ACT-series TTL logic, fast PALs, and possibly full custom chip designs. It's very unlikely the designer will meet any of these specifications with the LS parts left over from old Zorro II card designs.

### STANDARD READ CYCLE TIMING

No.	Name	Symbol	Min	Max
1	Address setup to /FCS	TAFS	15ns	—
2	Address hold from /FCS	THAF	10ns	—
3	/FCS to /SLAVEN delay	TSLV	—	25ns
4	/FCS to DOE delay	TDOE	30ns	—
5	DOE to /DSN delay	TDS	10ns	—
6	Data setup to /DTACK	TRDS	0ns	—
7	/DTACK to /FCS off	TOFF	10ns	—
8	Master signal hold from /FCS off	THMC	0ns	5ns
9	Slave signal hold from /FCS off	THSC	0ns	15ns
11	/FCS to /CCS delay	TCCS	35ns	175ns
12	/CCS off to /FCS off	TOVL	40ns	—

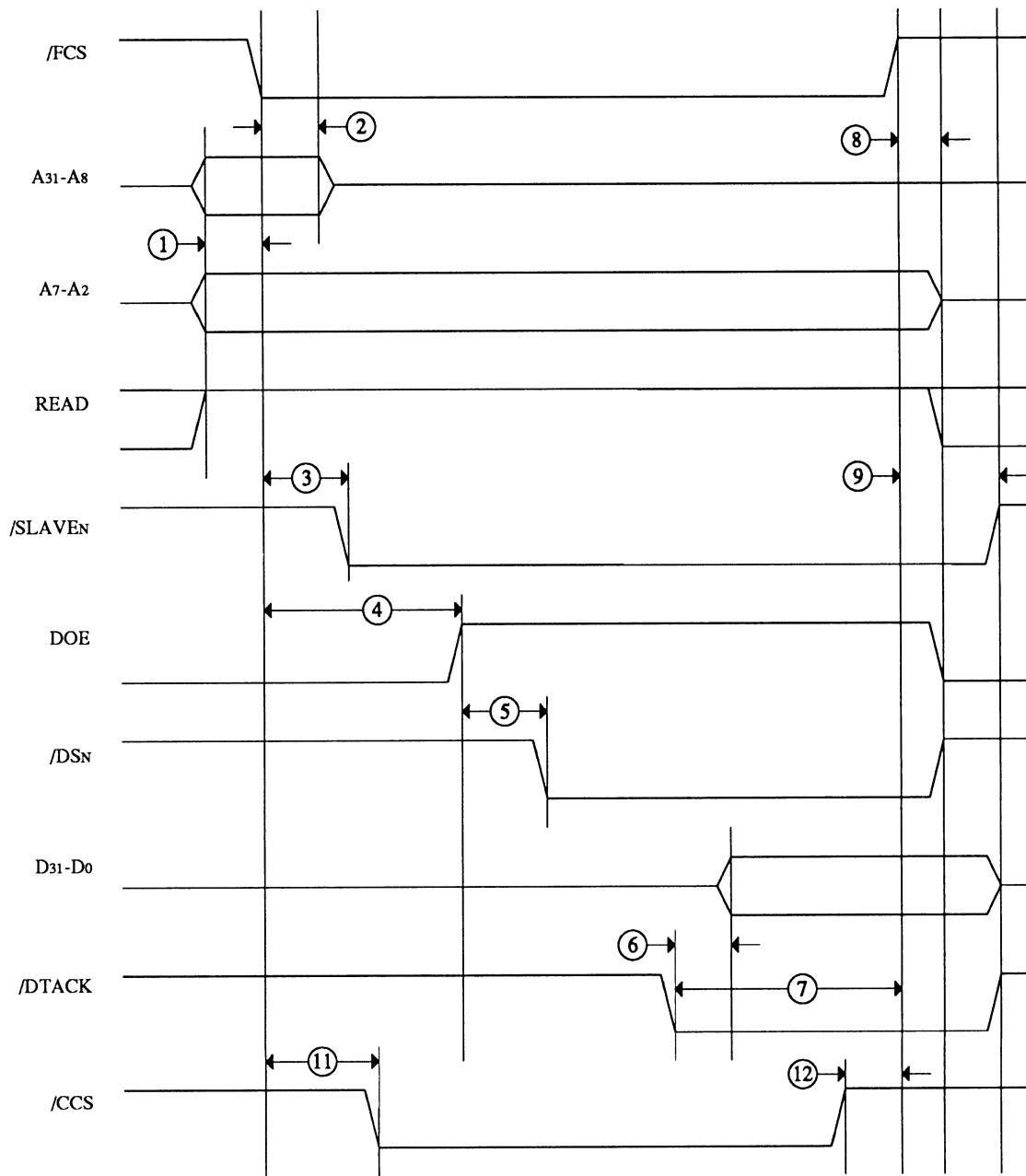

Figure K-10: Read Cycle Timing

## STANDARD WRITE CYCLE TIMING

No.	Name	Symbol	Min	Max
1	Address setup to /FCS	TAFS	15ns	—
2	Address hold from /FCS	THAF	10ns	—
3	/FCS to /SLAVEN delay	TSLV	—	25ns
4	/FCS to DOE delay	TDOE	30ns	—
5	DOE to /DSN delay	TDS	10ns	—
7	/DTACK to /FCS off	TOFF	10ns	—
8	Master signal hold from FCS off	THMC	0ns	5ns
9	Slave signal hold from /FCS off	THSC	0ns	15ns
10	Write data setup to /DSN	TWDS	5ns	—
11	/FCS to /CCS delay	TCCS	35ns	175ns
12	/CCS off to /FCS off	TOVL	40ns	—



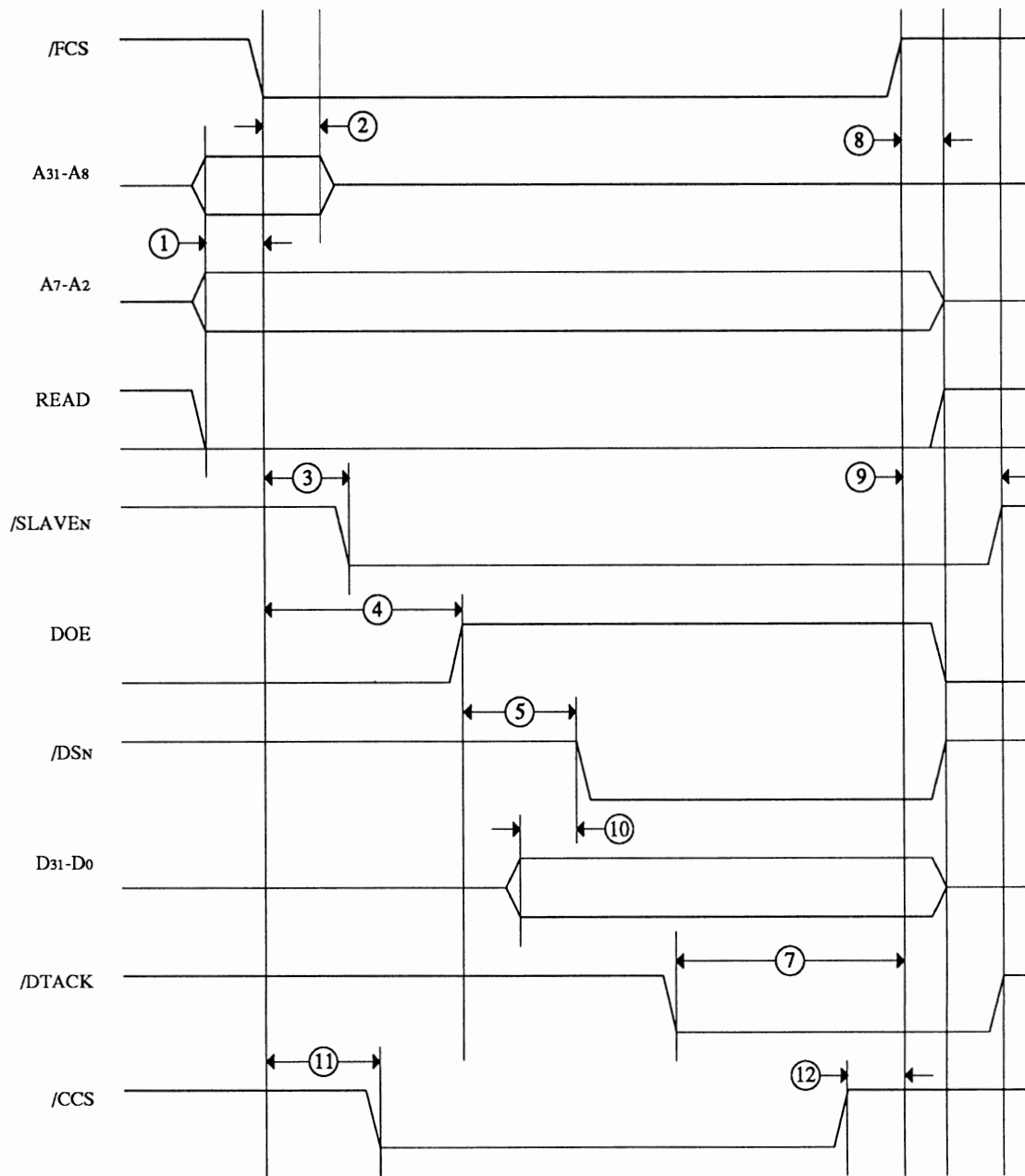

Figure K-11: Write Cycle Timing

## MULTIPLE TRANSFER CYCLE TIMING

No.	Name	Symbol	Min	Max
1	Address setup to /FCS	TAFS	15ns	–
2	Address hold from /FCS	THAF	10ns	–
3	/FCS to /SLAVEN, /MTACK delay	TSLV	–	25ns
4	/FCS to DOE delay	TDOE	30ns	–
5	DOE to /DSN, /MTCR delay	TDS	10ns	–
6	Data setup to /DTACK	TRDS	0ns	–
7	/DTACK to /FCS, /MTCR off	TOFF	10ns	–
8	Master signal hold from /FCS off	THMC	0ns	5ns
9	Slave signal hold from /FCS off	THSC	0ns	15ns
10	Write data setup to /DSN	TWDS	5ns	–
13	Address, READ setup to /MTCR	TAMS	5ns	–
14	/MTCR off to /MTCR on	TREF	10ns	–
15	Address, READ hold from /MTCR	THAM	0ns	–
16	/MTACK off to /MTCR	TBCD	10ns	–
17	Slave signal hold from /MTCR off	THSM	0ns	5ns

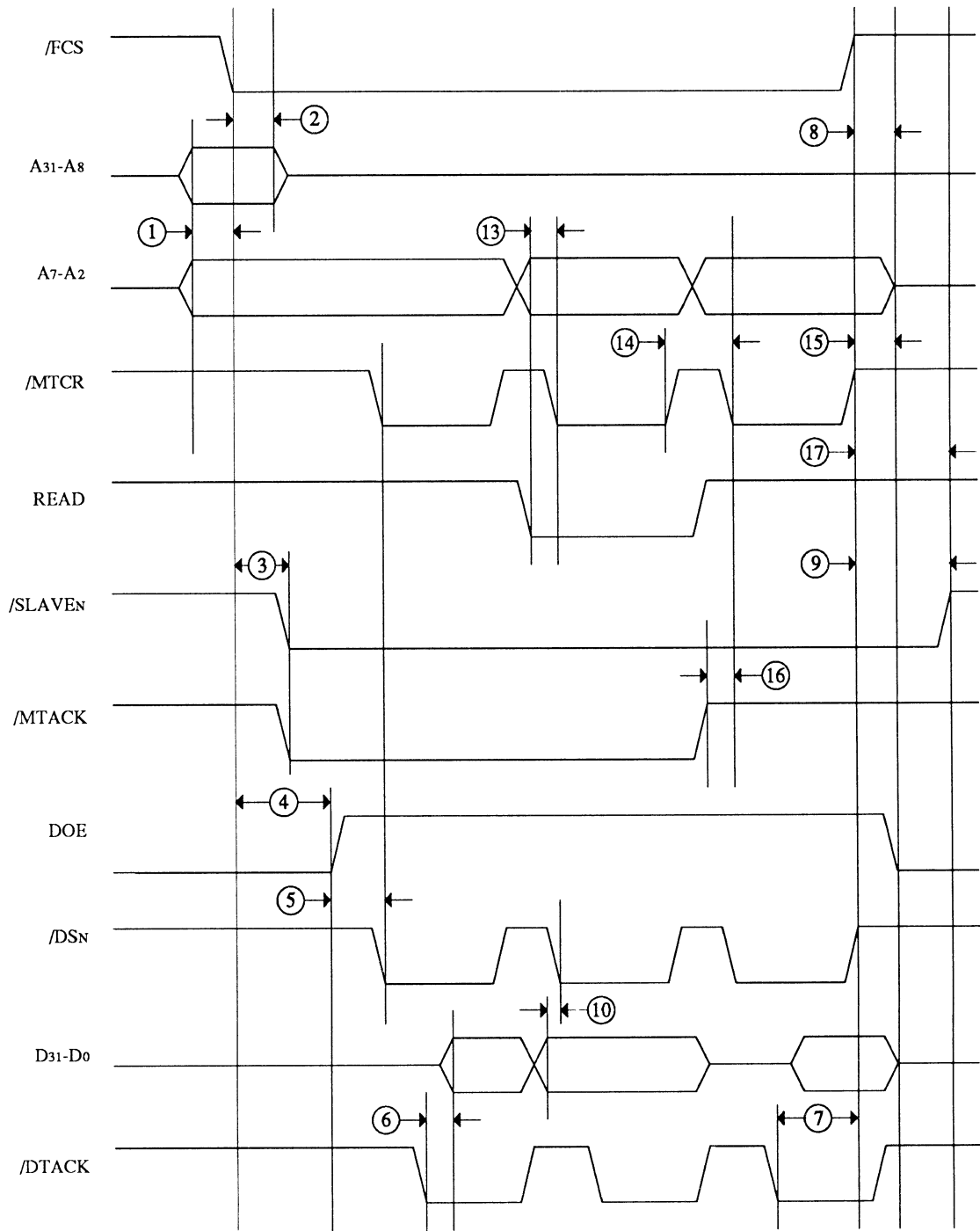

Figure K-12: Multiple Transfer Cycle Timing

### QUICK INTERRUPT CYCLE TIMING

No.	Name	Symbol	Min	Max
1	Address setup to /FCS	TAFS	15ns	–
2	Address hold from /FCS	THAF	10ns	–
3	/FCS to /SLAVEN delay	TSLV	–	25ns
5	DOE to /DSN delay	TDS	10ns	–
6	Data setup to /DTACK	TRDS	0ns	–
7	/DTACK to /FCS off	TOFF	10ns	–
8	Master signal hold from /FCS off	THMC	0ns	5ns
9	Slave signal hold from /FCS off	THSC	0ns	15ns
14	/MTCR off to /MTCR on	TREF	10ns	–
17	Slave signal hold from /MTCR off	THSM	0ns	5ns
18	Poll Phase time	TPOL	30ns	100ns
19	Vector Phase start to /DTACK time	TVEC	–	100ns

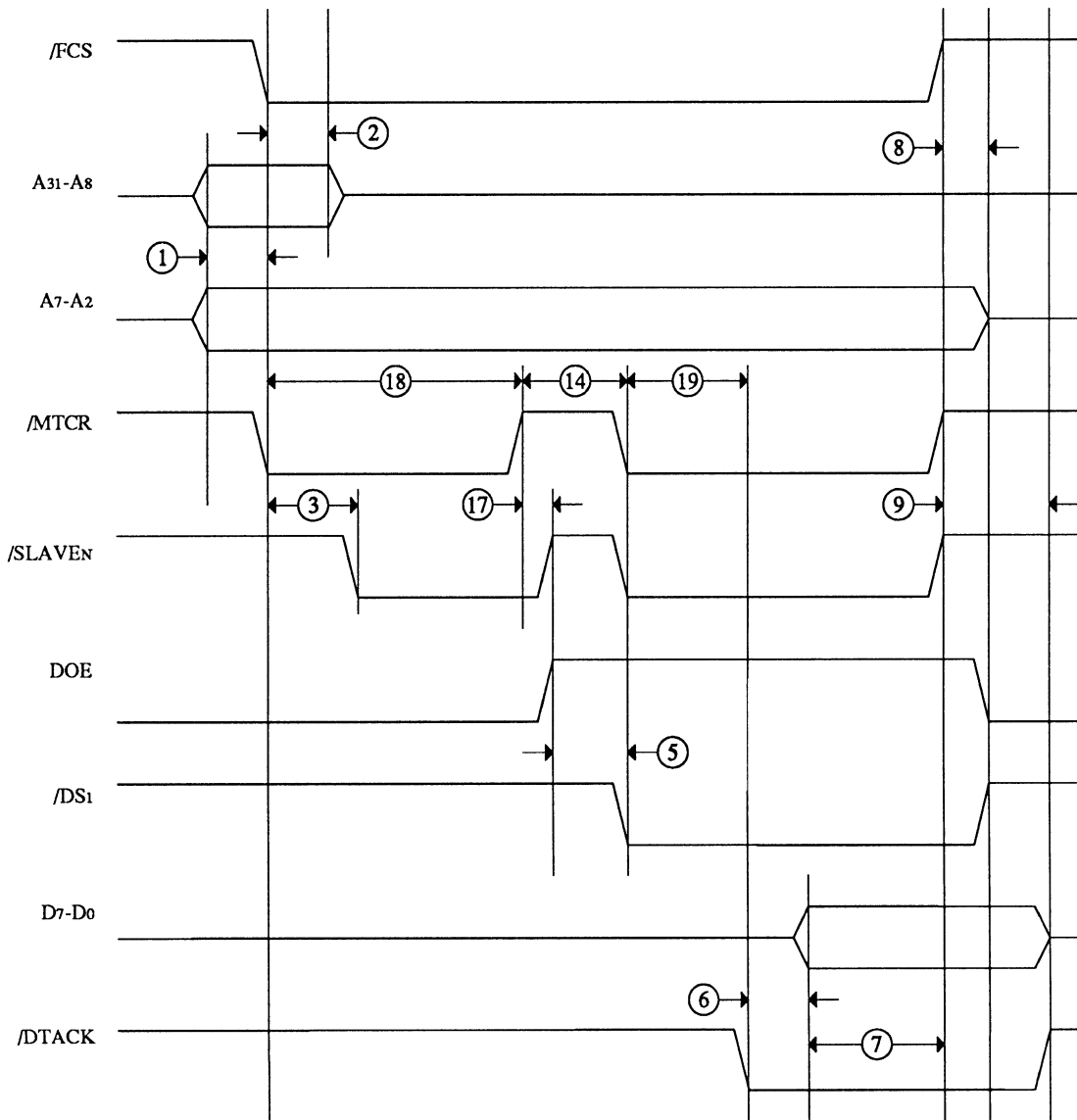

Figure K-13: Quick Interrupt Cycle Timing

---

## Electrical Specifications

The Zorro III bus has a number of electrical specifications that are very important for PIC designers to consider, along with the timing parameters of course. It's extremely important to base designs on the specification of the backplane, rather than the actual behavior of the backplane. New backplanes for new machines are designed to conform to the specification, they are not necessarily based on previous designs. This is especially important with the Zorro III bus, since timing is far more critical than in the past, and the bus controller is designed from this specification, rather than the reverse, as in the Amiga 2000.

### EXPANSION BUS LOADING

The Zorro III bus loading is specified based on typical TTL family "F" series buffer devices, though in reality, compatible CMOS devices are likely to be used in some bus controllers or PICs. Thus, it's important to accept the TTL levels as a minimum voltage level, and make sure that all inputs are the appropriate TTL levels, while outputs can be at TTL or CMOS voltage levels as long as they provide the required source and sink.

While some A2000 designs used "LS" or "ALS" buffers instead of "F," the bus will generally work with these older cards, at least with current backplane designs such as the A3000 backplane. However, Zorro III designs must exactly obey these loading rules; it's very probable that some future Zorro III machines will have a large number of slots. In such machines, PICs built on the Zorro II specification will still work in a lightly loaded bus, but may not function in a fully loaded bus. All Zorro III PICs built to spec will work in any Zorro III backplane, without any loading problems, if all loading and timing rules are followed by the PIC designer. The bus signals are divided up into the four groups shown in Table 9-2, based on the loading characteristics of the particular signal. The signals in each group are given here. Standard Signals

The majority of signals on the bus are in this group. These are bussed signals, driven actively on the bus by F-series (or compatible) drivers such as 74F245, usually tri-stated when ownership of the signal changed for master and slave, and generally terminated with a 220Ω/330Ω thevenin terminator. PICs can apply two standard loads to each of these signals when necessary.

/FCS	/CCS	/DS0-/DS3	/LOCK
A2-A7	AD8-AD31	SD0-SD7	READ
FC0-FC2	DOE	/IORST	/BCLR
/MTCR	/MTACK		

### ***Clock Signals***

All clock signals on the bus are in this group. Many designs are very sensitive to clock delay, skew, and rise/fall times, so loading on the clock lines must be kept to a minimum. These are bussed signals, actively driven by the backplane, and source terminated with a low value series resistor. PICs can apply one standard load to each of these signals when necessary. Zorro II cards have the same clock rules, so there should never be clocking problems when using either card type in a backplane.

/C3	CDAC	/C1	7M
E Clock			

### ***Open Collector Signals***

Many of the bus signals are shared via open collector or open drain outputs rather than via tri-stated signals; this is of course required for some asynchronous things like the shared interrupt lines, and it works well for other types of signals as well. Of course, a backplane resistor pulls these lines high, PICs only drive the line low.

/OWN	/BGACK	/CINH	/BERR
/DTACK	/RESET	/INT2	/INT6
/HLT			

### ***Non-bussed Signals***

The non-bussed, or slot specific, signals are involved with only one slot on the bus (e.g., each slot has its own copy). As a result, the drive requirements are much less for these signals. The backplane provides pullups or pulldowns, as required by the specific signal.

/CFGIN <sub>N</sub>	/CFGOUT <sub>N</sub>	/BR <sub>N</sub>	/BG <sub>N</sub>
SenseZ3	/SLAVEN		

---

## SLOT POWER AVAILABILITY

The system power for the Zorro III bus is totally based on the slot configurations. A backplane is always free to supply extra power, but it must meet the minimum requirements specified here. All PICs must be designed with the minimum specifications in mind, especially the tolerances.

Pin	Supply
5,6	+5 VDC $\pm$ 5% @ 2 Amps
8	-5 VDC $\pm$ 5% @ 60 mA
10	+12 VDC $\pm$ 5% @ 500mA
20	-12 VDC $\pm$ 5% @ 60mA

## TEMPERATURE RANGE

The Zorro III bus is specified for operation over a temperature range of 0° C to 70° C.



---

## **Mechanical Specifications**

This section covers the various mechanical details of Zorro III cards.

## BASIC ZORRO III PIC

This drawing shows the basic Zorro III PIC. All of the dimensions are in millimeters.

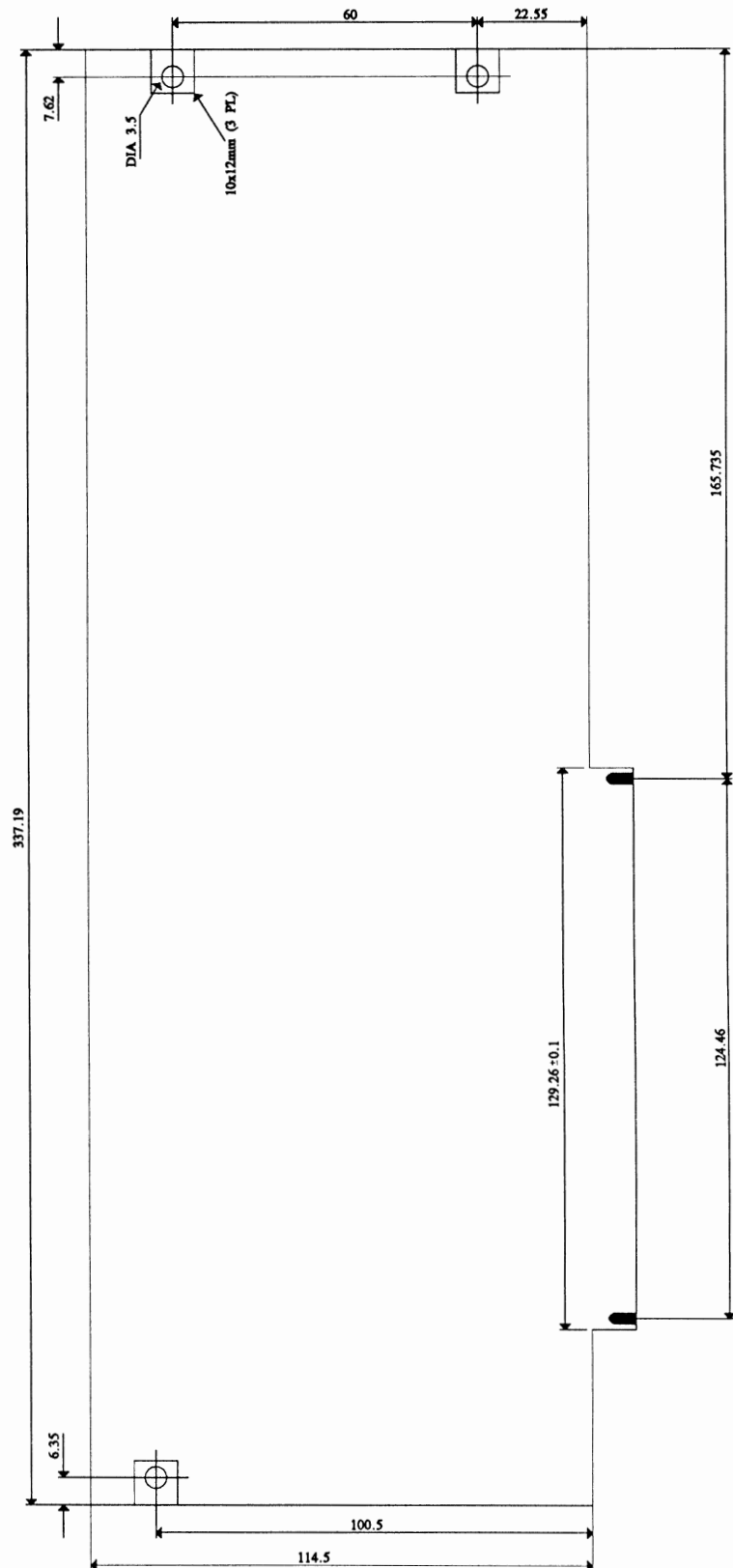

### PIC WITH ISA OPTION

This drawing shows the basic Zorro III PIC, with both Zorro III and the ISA Bus fingers specified. All of the dimensions are in millimeters.

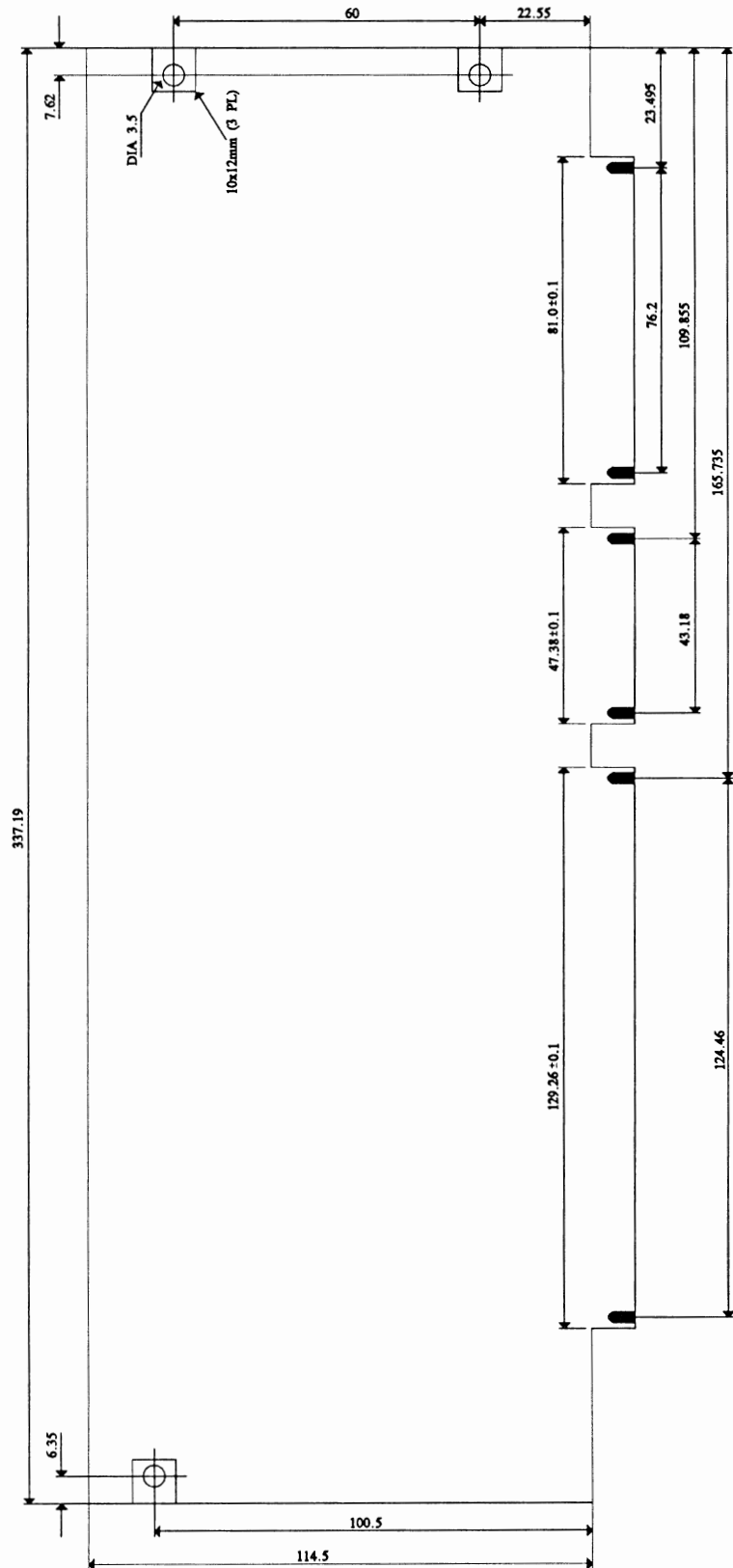

## PIC WITH VIDEO OPTION

This drawing shows the basic Zorro III PIC, with both Zorro III and the Amiga Video Slot fingers specified. All of the dimensions are in millimeters. Please consult the *A500/A2000 Technical Reference Manual* for the form factor specification of a video-only card that will fit both Amiga 2000 and Amiga 3000 computers.

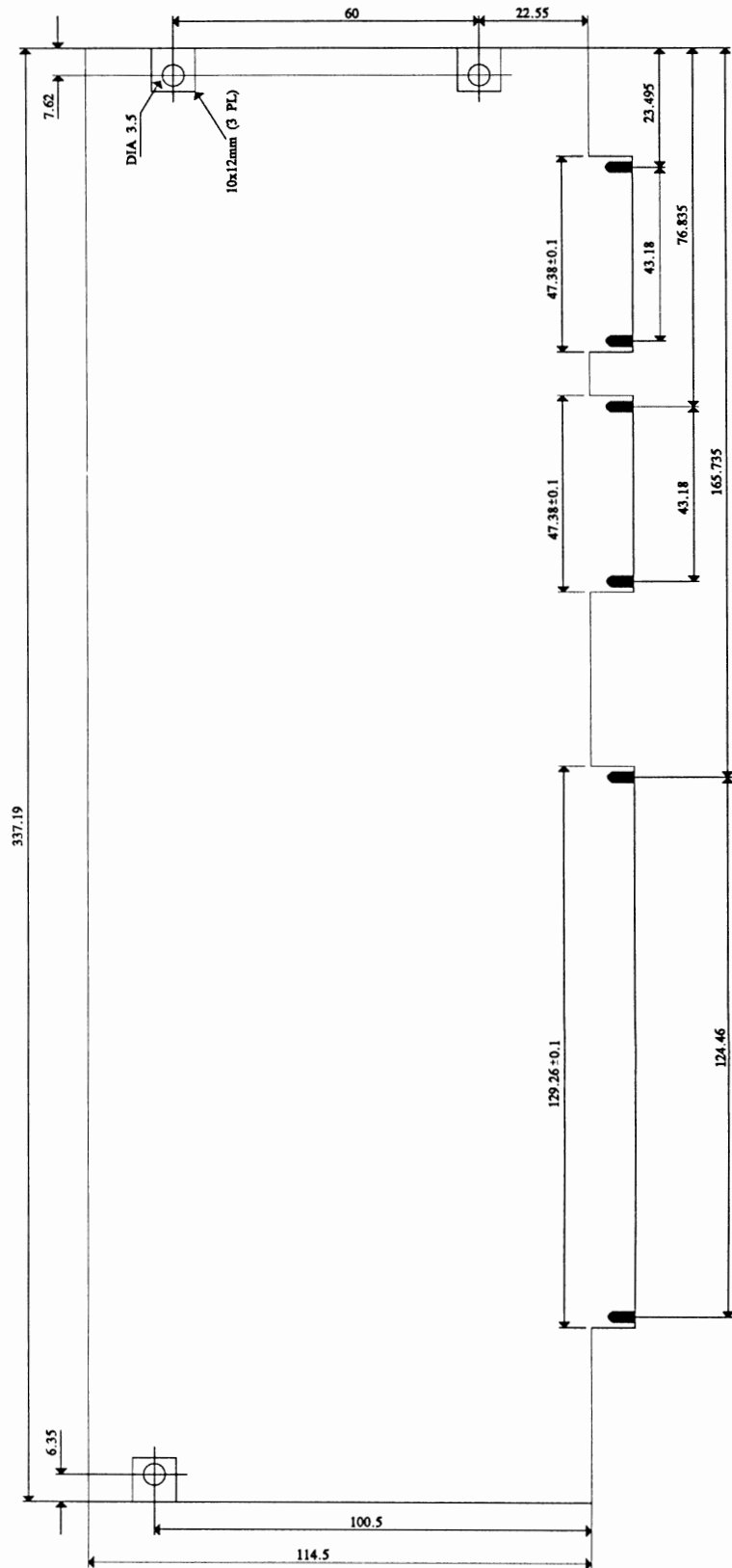

---

# AUTOCONFIG™

## THE AUTOCONFIG MECHANISM

The AUTOCONFIG mechanism used for the Zorro III bus is an extension of the original Zorro II configuration mechanism. The main reason for this is that the Zorro II mechanism works so well, there was little need to change anything. The changes are simply support for new hardware features on the Zorro III bus.

Amiga autoconfiguration is surprisingly simple. When an Amiga powers up or resets, every card in the system goes to its unconfigured state. At this point, the most important signals in the system are /CFGIN<sub>N</sub> and /CFGOUT<sub>N</sub>. As long as a card's /CFGIN<sub>N</sub> line is negated, that card sits quietly and does nothing on the bus (though memory cards should continue to refresh even through reset, and any local board activities that don't concern the bus may take place after /RESET is negated). As part of the unconfigured state, /CFGOUT<sub>N</sub> is negated by the PIC immediately on reset.

The configuration process begins when a card's /CFGIN<sub>N</sub> line is asserted, either by the backplane, if it's the first slot, or via the configuration chain, if it's a later card. The configuration chain simply ensures that only one unconfigured card will see an asserted /CFGIN<sub>N</sub> at one time. An unconfigured card that sees its /CFGIN<sub>N</sub> line asserted will respond to a block of memory called *configuration space*. In this block, the PIC will assert a set of read-only registers, followed by a set of write-only registers (the read-only registers are also known as AUTOCONFIG ROM). Starting at the base of this block, the read registers describe the device's size, type, and other requirements. The operating system reads these, and based on them, decides what should be written to the board. Some write information is optional, but a board will always be assigned a base address or be told to shut up. The act of writing the final bit of base address, or writing anything to a shutup address, will cause the PIC to assert its /CFGOUT<sub>N</sub>, enabling the next board in the configuration chain.

The Zorro II configuration space is the 64K memory block \$00E8xxxx, which of course is driven with 16-bit Zorro II cycles; all Zorro II cards configure there. The Zorro III configuration space is the 64K memory block beginning at \$FF00xxxx, which is always driven with 32-bit Zorro III cycles (PICs need only decode A31-A24 during configuration). A Zorro III PIC can configure in Zorro II or Zorro III configuration space, at the designer's discretion, but not both at once. All read registers physically return only the top 4 bits of data, on D31-D28 for either bus mode. Write registers are written to support nybble, byte, and word registers for the same register, again based on what works best in hardware. This design attempts to map into real hardware as simply as possible. Every AUTOCONFIG register is logically considered to be 8 bits wide; the 8 bits actually being nybbles from two paired addresses.

The register mappings for the two different blocks are shown in *Figure 9-10*. All the bit patterns mentioned in the following sections are logical values. To avoid ambiguity, all registers are referred to by the number of the first register in the pair, since the first pair member is the same for both mapping schemes. In the actual implementation of these registers, all read registers except for the 00 register are physically complemented; eg, the logical value of register 3C is always 0, which means in hardware, the upper nybbles of locations \$00E8003C and \$00E8003E, or \$FF00003C and \$FF00013C, both return all 1s.

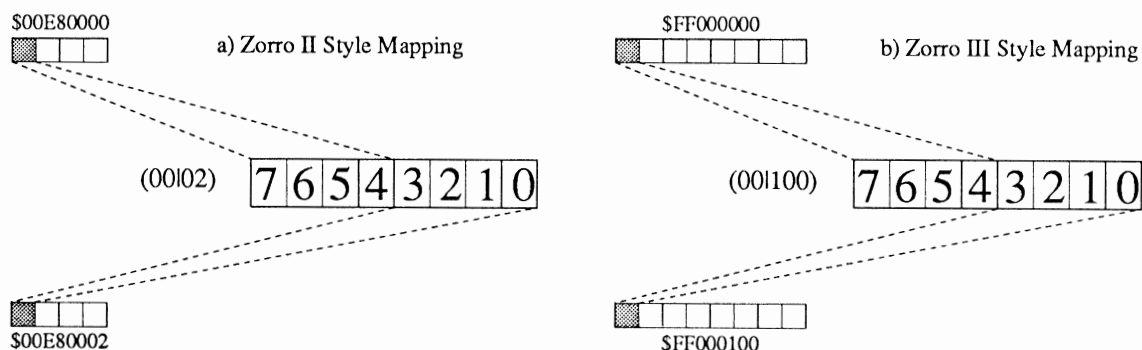

Figure K-14: Configuration Register Mapping

## REGISTER BIT ASSIGNMENTS

The actual register assignments are below. Most of the registers are the same as for the Zorro II bus, and are included here for completeness. The Amiga OS software names for these registers in the ExpansionRom or ExpansionControl structures are included.

Reg ZII ZIII Bit

00 02 100 7,6 These bits encode the PIC type:  
(er\_Type)

00	Reserved
01	Reserved
10	Zorro III
11	Zorro II

5 If this bit is set, the PIC's memory will be linked into the system free pool. The Zorro III register 08 may modify the size of the linked memory.

- 4 Setting this bit tells the OS to read an autoboot ROM.
- 3 This bit is set to indicate that the next board is related to this one; often logically separate PICs are physically located on the same card.
- 2-0 These bits indicate the configuration size of the PIC. This size can be modified for the Zorro III cards by the size extension bit, which is the new meaning of bit 5 in register 08.

Bits	Unextended	Extended
000	8 megabytes	16 megabytes
001	64 kilobytes	32 megabytes
010	128 kilobytes	64 megabytes
011	256 kilobytes	128 megabytes
100	512 kilobytes	256 megabytes
101	1 megabyte	512 megabytes
110	2 megabytes	1 gigabyte
111	4 megabytes	RESERVED

- 04 06 104 7-0 (er\_Product) The device's product number, which is completely up to the manufacturer. This is generally unique between different products, to help in identification of system cards, and it must be unique between devices using the automatic driver binding features.
- 08 0A 108 7 (er\_Flags) This was originally an indicator to place the card in the 8 megabyte Zorro II space, when set, or anywhere it'll fit, if cleared. Under the Zorro III spec, this is set to indicate that the board is basically a memory device, cleared to indicate that the board is basically an I/O device.
  - 6 This bit is set to indicate that the board can't be shut up by software, cleared to indicate that the board can be shut up.
  - 5 This is the size extension bit. If cleared, the size bits in register 00 mean the same as under Zorro II, if set, the size bits indicate a new size. The most common new Zorro III sizes are the smaller ones; all new sized cards get aligned on their natural boundaries.
  - 4 Reserved, must be 1 for all Zorro III cards.
  - 3-0 These bits indicate a board's sub-size; the amount of memory actually required by a PIC. For memory boards that auto-link, this is the actual amount of memory that will be linked into the system free memory pool. A memory card, with memory starting at the base address, can be automatically sized by the Operating System. This sub-size option is intended to support cards with variable setups without requiring variable physical configuration capability on such cards. It also may greatly simplify a Zorro III design, since 16-megabyte cards and up can be designed with a single latch and

comparator for base address matching, while 8 megabyte and smaller PICs require large latch/comparator circuits not available in standard TTL packages.

Bits	Encoding
0000	Logical size matches physical size
0001	Automatically sized by the Operating System
0010	64 kilobytes
0011	128 kilobytes
0100	256 kilobytes
0101	512 kilobytes
0110	1 megabyte
0111	2 megabytes
1000	4 megabytes
1001	6 megabytes
1010	8 megabytes
1011	10 megabytes
1100	12 megabytes
1101	14 megabytes
1110	Reserved
1111	Reserved

For boards that wish to be automatically sized by the operating system, a few rules apply. The memory is sized in 512K increments, and grows from the base address upward. Memory wraps are detected, but the design must insure that its data bus doesn't float when the sizing routine addresses memory locations that aren't physically present on the board; data bus pullups or pulldowns are recommended. This feature is designed to allow boards to be easily upgraded with additional or increased density memory without the need for memory configuration jumpers.

<b>0C</b>	0E 10C 7-0 (er_Reserved03)	Reserved, must be 0.
<b>10</b>	12 110 7-0	Manufacturer's number, high byte.
<b>14</b>	16 114 7-0 (er_Manufacturer)	Manufacturer's number, low bytes. These are unique, and can only be assigned by Commodore (CATS).
<b>18</b>	1A 118 7-0	Optional serial number, byte 0 (msb)
<b>1C</b>	1E 11C 7-0	Optional serial number, byte 1
<b>20</b>	22 120 7-0	Optional serial number, byte 2
<b>24</b>	26 124 7-0 (er_SerialNumber)	Optional serial number, byte 3 (lsb) This is for the manufacturer's use and can contain anything at all. The main intent is to allow a manufacturer to uniquely identify individual cards, but it can certainly be used for revision information or other data.



- 28 2A 128 7-0 Optional ROM vector, high byte.
- 2C 2E 12C 7-0 Optional ROM vector, low byte.  
(er\_InitDiagVec) If the ROM address valid bit (bit 4 of register (00I02)) is set, these two registers provide the sixteen bit offset from the board's base at which the start of the ROM code is located. If the ROM address valid bit is cleared, these registers are ignored.
- 30 32 130 7-0 Reserved, must be 0. Unsupported base register reset register under Zorro II<sup>6</sup>  
(er\_Reserved0c)
- 34 36 134 7-0 Reserved, must be 0.  
(er\_Reserved0d)
- 38 3A 138 7-0 Reserved, must be 0.  
(er\_Reserved0e)
- 3C 3E 13C 7-0 Reserved, must be 0.  
(er\_Reserved0f)
- 40 42 140 7-0 Reserved, must be 0. Unsupported control state register under Zorro II<sup>7</sup>  
(ec\_Interrupt)
- 44 46 144 7-0 High order base address register, write only.
- 48 4A 148 7-0 Low order base address register, write only.  
(ec\_Z3\_HighByte) The high order register takes bits 31-24 of the board's configured address, the low order register takes bits 23-16. For Zorro III boards configured in the Zorro II space, the configuration address is written both nybble and byte wide, with the ordering:  
(ec\_BaseAddress)

Reg	Nybble	Byte
46	A27-A24	N/A
44	A31-A28	A31-A24
4A	A19-A16	N/A
48	A23-A20	A23-A16

<sup>6</sup> The original Zorro specifications called for a few registers, like these, that remained active after configuration. Support for this is impossible, since the configuration registers generally disappear when a board is configured, and absolutely must move out of the \$00E8xxxx space. So since these couldn't really be implemented in hardware, system software has never supported them. They're included here for historical purposes.

<sup>7</sup> IBID

Note that writing to register 48 actually configures the board for both Zorro II and Zorro III boards in the Zorro II configuration block. For Zorro III PICs in the Zorro III configuration block, the action is slightly different. The software will actually write the configuration as byte and word wide accesses:

Reg	Byte	Word
48	A23-A16	N/A
44	A31-A24	A31-A16

The actual configuration takes place when register 44 is written, thus supporting any physical size of configuration register.

<b>4C</b>	4E	14C	7-0	Shut up register, write only. Anything written to 4C will cause a board that supports shut-up to completely disappear until the next reset.
	(ec_Shutup)			
<b>50</b>	52	150	7-0	Reserved, must be 0.
<b>54</b>	56	154	7-0	Reserved, must be 0.
<b>58</b>	5A	158	7-0	Reserved, must be 0.
<b>5C</b>	5E	15C	7-0	Reserved, must be 0.
<b>60</b>	62	160	7-0	Reserved, must be 0.
<b>64</b>	66	164	7-0	Reserved, must be 0.
<b>68</b>	6A	168	7-0	Reserved, must be 0.
<b>6C</b>	6E	16C	7-0	Reserved, must be 0.
<b>70</b>	72	170	7-0	Reserved, must be 0.
<b>74</b>	76	174	7-0	Reserved, must be 0.
<b>78</b>	7A	178	7-0	Reserved, must be 0.
<b>7C</b>	7E	17C	7-0	Reserved, must be 0.

## Physical and Logical Signal Names

The Amiga 3000 Bus signals vary based on the particular bus mode in effect. This table lists each physical pin by physical name, and then by the logical names for Zorro II mode, Zorro III mode, address phase, and Zorro III data mode, data phase.

PIN NO.	Physical Name	Zorro II Name	Zorro III Address Phase	Zorro III Data Phase
1	Ground	Ground	Ground	Ground
2	Ground	Ground	Ground	Ground
3	Ground	Ground	Ground	Ground
4	Ground	Ground	Ground	Ground
5	+5VDC	+5VDC	+5VDC	+5VDC
6	+5VDC	+5VDC	+5VDC	+5VDC
7	/OWN	/OWN	/OWN	/OWN
8	-5VDC	-5VDC	-5VDC	-5VDC
9	/SLAVEN	/SLAVEN	/SLAVEN	/SLAVEN
10	+12VDC	+12VDC	+12VDC	+12VDC
11	/CFGOUTN	/CFGOUTN	/CFGOUTN	/CFGOUTN
12	/CFGINN	/CFGINN	/CFGINN	/CFGINN
13	Ground	Ground	Ground	Ground
14	/C3	/C3 Clock	/C3 Clock	/C3 Clock
15	CDAC	CDAC Clock	CDAC Clock	CDAC Clock
16	/C1	/C1 Clock	/C1 Clock	/C1 Clock
17	/CINH	/OVR	/CINH	/CINH
18	/MTCR	XRDY	/MTCR	/MTCR
19	/INT2	/INT2	/INT2	/INT2
20	-12VDC	-12VDC	-12VDC	-12VDC
21	A5	A5	A5	A5
22	/INT6	/INT6	/INT6	/INT6
23	A6	A6	A6	A6
24	A4	A4	A4	A4
25	Ground	Ground	Ground	Ground
26	A3	A3	A3	A3
27	A2	A2	A2	A2
28	A7	A7	A7	A7
29	/LOCK	A1	/LOCK	/LOCK
30	AD8	A8	A8	D0
31	FC0	FC0	FC0	FC0
32	AD9	A9	A9	D1
33	FC1	FC1	FC1	FC1
34	AD10	A10	A10	D2
35	FC2	FC2	FC2	FC2
36	AD11	A11	A11	D3
37	Ground	Ground	Ground	Ground

PIN NO.	Physical Name	Zorro II Name	Zorro III Address Phase	Zorro III Data Phase
38	AD12	A12	A12	D4
39	AD13	A13	A13	D5
40	Reserved	(/EINT7)	Reserved	Reserved
41	AD14	A14	A14	D6
42	Reserved	(/EINT5)	Reserved	Reserved
43	AD15	A15	A15	D7
44	Reserved	(/EINT4)	Reserved	Reserved
45	AD16	A16	A16	D8
46	/BERR	/BERR	/BERR	/BERR
47	AD17	A17	A17	D9
48	/MTACK	(/VPA)	/MTACK	/MTACK
49	Ground	Ground	Ground	Ground
50	E Clock	E Clock	E Clock	E Clock
51	/DS0	(/VMA)	/DS0	/DS0
52	AD18	A18	A18	D10
53	/RESET	/RST	/RESET	/RESET
54	AD19	A19	A19	D11
55	/HLT	/HLT	/HLT	/HLT
56	AD20	A20	A20	D12
57	AD22	A22	A22	D14
58	AD21	A21	A21	D13
59	AD23	A23	A23	D15
60	/BRN	/BRN	/BRN	/BRN
61	Ground	Ground	Ground	Ground
62	/BGACK	/BGACK	/BGACK	/BGACK
63	AD31	D15	A31	D31
64	/BGN	/BGN	/BGN	/BGN
65	AD30	D14	A30	D30
66	/DTACK	/DTACK	/DTACK	/DTACK
67	AD29	D13	A29	D29
68	READ	READ	READ	READ
69	AD28	D12	A28	D28
70	/DS2	/LDS	/DS2	/DS2
71	AD27	D11	A27	D27
72	/DS3	/UDS	/DS3	/DS3
73	Ground	Ground	Ground	Ground
74	/CCS	/AS	/CCS	/CCS
75	SD0	D0	Reserved	D16
76	AD26	D10	A26	D26
77	SD1	D1	Reserved	D17
78	AD25	D9	A25	D25
79	SD2	D2	Reserved	D18
80	AD24	D8	A24	D24
81	SD3	D3	Reserved	D19
82	SD7	D7	Reserved	D23

PIN NO.	Physical Name	Zorro II Name	Zorro III Address Phase	Zorro III Data Phase
83	SD4	D4	Reserved	D20
84	SD6	D6	Reserved	D22
85	Ground	Ground	Ground	Ground
86	SD5	D5	Reserved	D21
87	Ground	Ground	Ground	Ground
88	Ground	Ground	Ground	Ground
89	Ground	Ground	Ground	Ground
90	Ground	Ground	Ground	Ground
91	SenseZ3	Ground	SenseZ3	SenseZ3
92	7M	E7M	7M	7M
93	DOE	DOE	DOE	DOE
94	/IORST	/BUSRST	/IORST	/IORST
95	/BCLR	/GBG	/BCLR	/BCLR
96	Reserved	(/EINT1)	Reserved	Reserved
97	/FCS	No Connect	/FCS	/FCS
98	/DS1	No Connect	/DS1	/DS1
99	Ground	Ground	Ground	Ground
100	Ground	Ground	Ground	Ground

## Zorro III Implementations

Functionally, there are two possible implementation levels in existence for the Zorro III bus. All of the features described in this chapter are required for a full compliance Zorro III bus. However, the original Amiga 3000 computers were shipped with a bus controller that supported only a subset of the Zorro III specification published here. This is, however, upgradable.

The A3000 implementation of the Zorro III bus is driven by a custom controller chip called Fat Buster. The specification of this chip and the A3000 hardware are fully capable of supporting the complete Zorro III bus, but the initial silicon on Fat Buster, called the Level 1 Fat Buster, omits some features. Missing are: support of Multiple Transfer Cycles; support for Zorro III style bus arbitration; support for Quick Interrupts.

The Level 2 version of Fat Buster has been in testing for some time at Commodore in West Chester, PA. Any developers who immediately intend to design PICs supporting these features are urged to contact Commodore Amiga Technical Support/Amiga Developer Support for more information on obtaining samples of this part for use in A3000 systems. These parts are likely to be introduced into production, and available as part of an A3000 upgrade, very soon. All Buster chip revisions "13G" and earlier support the Level 1 features. Buster chip revisions "13H" and later support Level 2 features and improved Level 1 features as well.



---

# GLOSSARY

**address**

A byte-numbered memory location. The Zorro II bus is based on a 24-bit address, the Zorro III bus on a 32-bit address.

**Agnus**

One of the three main Amiga custom chips. Contains the blitter, copper, and DMA circuitry.

**aliasing distortion**

A side effect of sound sampling, where two additional frequencies are produced, distorting the sound output.

**Alt keys**

Two keys on the keyboard to the left and right of the Amiga keys.

**Amiga keys**

Two keys on the keyboard to the left and right of the space bar.

**AmigaDOS**

The disk operating system (DOS) used by Amiga computers.

**amplitude**

In audio applications, the voltage or current output expressed as volume from a sound speaker.

**amplitude modulation**

In audio applications, a means of producing complex audio effects by using one audio channel to alter the amplitude of another.

**arbitration**

The unambiguous selection of one request out of a number of possible simultaneous requests for a resource. There are two kinds of arbitration in a Zorro III system; bus arbitration and quick interrupt arbitration.

**asserted**

The active state of a state, regardless of its logic sense.

---

**atomic cycle**

A cycle or set of cycles that are uninterruptable, and thus treated as a unit; both Multiple Transfer and LOCKed cycles are considered atomic under the Zorro III bus.

**attach mode**

1. With sprites, a mode in which a sprite uses two DMA channels for additional colors. 2. In sound production, combining two audio channels for frequency/amplitude modulation or for stereo sound.

**AUTOCONFIG™**

>From “automatic configuration,” the Zorro bus specification for how software and hardware cooperate to permit PIC addresses to be set by software and PIC type information to be determined by software.

**automatic mode**

1. With sprites, the normal mode in which the sprite DMA channel automatically retrieves and displays all of the data for a sprite. 2. In audio applications, the normal mode in which the audio DMA channels automatically retrieve sound data.

**backplane**

The cage or motherboard subsection into which PICs are inserted. The Amiga 2000 and Amiga 3000 computers have integral backplanes, the Amiga 500 and Amiga 1000 computers require add-on backplane cages for Zorro II compatibility.

**barrel shifter**

Blitter circuit that allows movement of images on pixel boundaries.

**baud rate**

Rate of data transmission through a serial port.

**beam counters**

Registers that keep track of the position of the video beam.

**bitmap**

An image made up of pixels. A bitmap is a complete definition for a video display consisting of one or more bitplanes stored in memory.

**bitplane**

A contiguous area of memory set aside for the video display and logically organized as if it were a rectangular shape. All displays consist of one or more bitplanes; each additional bitplane doubles the number of colors that can be displayed.

**bitplane animation**

A means of animating the display by moving around blocks of playfield data with the blitter.

**blanking interval**

Time period when the video beam is outside the display area.



---

**blitter**

An Amiga coprocessor with its own DMA channel used for data copying and line drawing.

**burst**

A short name for Multiple Transfer Cycle mode. Essentially, within one full Zorro III cycle there can be any number of Multiple Transfer Cycles. Each full cycle has a complete 32-bit address supplied and a complete 32-bit datum transferred. Each burst cycle supplies only the 8-bit page address, but transfers a complete 32-bit datum faster than the standard full cycle would allow.

**bus cycle**

One complete bus transaction, indicated by the assertion of at least one cycle strobe. For any single bus cycle, there is one address, one data value, one data direction, and one cycle type in effect.

**bus hogging**

When a bus master takes over the bus for an undue amount of time. The Zorro II bus leaves it completely up to the individual PIC to avoid bus hogging; the Zorro III bus schedules PICs with the bus controller to evenly distribute the bus load.

**bus starvation**

When a master can't get access to the bus, it is said to be starved. On the Zorro II bus, two busy masters can completely starve a third master. Complete starvation is impossible on the Zorro III bus, though a bus hogging Zorro II card can cause similar symptoms.

**byte**

A collection of eight signals into a logical group, and the smallest independently addressable quantity on the Zorro bus.

**Chip RAM**

The area of memory accessible to the Amiga's custom chip set used for graphics and sound data. The amount of Chip RAM varies from 512K to 2 megabytes depending on the Amiga model. *See* Fast RAM.

**clear**

1. To change a bit or flag to 0, its off or disabled state. Opposite of *set*. 2. To erase a screen or window display.

**CLI**

*See* Command Line Interface.

**clipping**

When a portion of a sprite is outside the display window and thus is not visible.

**clock**

A free running signal driven at a fixed frequency to the bus, used mainly for clocking state machines on Zorro II cards.

---

**collision**

A means of detecting when sprites, playfields, or playfield objects attempt to overlap in the same pixel position or attempt to cross some pre-defined boundary.

**color descriptor words**

Pairs of words that define each line of a sprite.

**color indirection**

The method used by the Amiga for coloring individual pixels. For each pixel, a binary number is formed from corresponding bits in each bitplane which refers to one of the 32 color registers.

**color palette**

*See* color table.

**color register**

One of 32 hardware registers containing colors that you can define. In general, each color register can be set to one of 4,096 colors from the Amiga's palette.

**color table**

The set of 32 color registers.

**Command Line Interface (Shell or CLI)**

A means of communicating with a computer by typing commands at the keyboard. On the Amiga, this is called the Shell and, along with Workbench and ARexx, is one of the three built-in user interfaces. Before the Shell was available, this interface was called the CLI.

**composite video**

A video signal, transmitted over a single coaxial cable, which includes both picture and sync information.

**controller**

Hardware device, such as a mouse, joystick, or light pen, used to move the pointer or furnish other input to the system.

**coordinates**

A pair of numbers shown in the form (x,y), where x is an offset from the left side of the display or display window and y is an offset from the top.

**copper**

Display-synchronized coprocessor that resides on one of the Amiga custom chips and directs the graphics display.

**coprocessor**

An extra processor that enhances system performance by doing a specialized task, such as graphics or math, very quickly. This frees the main processor to do other work. Every Amiga has at least three coprocessor chips named Paula, Agnus, and Denise to handle graphics and audio.

---

**cursor keys**

The four keys with directional arrows on them (found below the Del and Help keys on the Amiga).

**cycle strobe**

A bus signal that defines the boundary of a bus cycle; the Zorro II and Zorro III modes on a Zorro III bus each have their own cycle strobes. The current bus master always asserts the cycle strobes.

**data**

The contents of a memory location. The main purpose of a bus cycle is to transfer data between two locations. The Zorro II bus is based on a 16-bit data path, the Zorro III bus is based on a 32-bit data path.

**data fetch**

The number of words fetched for each line of the display.

**delay**

In playfield horizontal scrolling, specifies how many pixels the picture will shift for each display field. Delay controls the speed of scrolling.

**Denise**

One of the three main Amiga custom chips. Contains the circuitry for the color palette, sprites, and video output.

**depth**

Number of bitplanes in a display. Each additional bitplane doubles the number of colors that can be displayed.

**device**

A PIC; e.g., a Zorro bus master or bus slave.

**Digital-to-Analog Converter (DAC)**

A device that converts a binary quantity to an analog level.

**Direct Memory Access (DMA)**

An arrangement that allows coprocessors or other system devices to read or write memory directly, without having to interrupt the main processor. Devices that have direct access to Zorro III slaves are said to have DMA capability. These devices are also called masters.

**display field**

One complete scanning of the video beam from top to bottom of the video display screen.

**display mode**

One of the basic types of display; for example, high or low resolution, interlaced or non-interlaced, single or dual playfield.

---

**display time**

The amount of time to produce one display field, approximately 1/60th of a second.

**display window**

The portion of the bitmap selected for display. Also, the actual size of the on-screen display.

**DMA**

*See* Direct Memory Access.

**DMA latency**

This is the time between a bus request and a bus grant as seen by a PIC wishing to become bus master.

**dual-playfield mode**

A display mode that allows you to manage two separate display memories, giving you two separately controllable displays at the same time.

**Enhanced Chip Set (ECS)**

The upgraded versions of the Amiga's Agnus and Denise coprocessor chips. The ECS offers new display modes and expands the Amiga's graphic capabilities. Many of the benefits of the ECS are available only in conjunction with Release 2 of the operating system.

**equal-tempered scale**

A musical scale in which the frequency of each tone is the 12th root of 2 higher than the tone below it. The equal-tempered scale is used in almost all musical styles.

**Exec**

The Amiga system module which manages memory and performs other important low-level tasks.

**Fast RAM**

General-purpose memory used for programs and data; as opposed to *Chip RAM*.

**font**

A set of letters, numbers, and symbols sharing the same size and design.

**frequency**

In audio applications, the number of times per second a waveform repeats.

**frequency modulation**

In audio applications, a means of producing complex sounds by using one audio channel to affect the period of the waveform produced by another channel.

**genlock**

An optional feature of the Amiga that allows you to combine an external video source with Amiga's graphic display.

**grant**

The result of an arbitrated set of requests is a single grant; there are grants given for both the bus and quick interrupts.

---

**HAM**

*See* hold-and-modify.

**hidden cycles**

Cycles that occur on the local bus of a system, but can't be seen by devices on the expansion bus.

**high**

A signal driven to a logical +5V state is said to be high.

**high resolution (Hires)**

A horizontal display mode in which 640 pixels are displayed across a horizontal line in a normal-sized display. On the Amiga a high resolution display is often called Hires.

**hold-and-modify (HAM)**

A display mode that gives you extended color selection. Normally, the Amiga supports up to 32 different colors from a palette of 4,096. Hold-and-modify (HAM mode) allows all 4,096 colors on the screen at one time by placing some restrictions on which colors may be displayed near each other.

**interlace mode**

A vertical display mode where 400 lines are displayed from top to bottom of the video display in a normal-size display.

**interrupt**

An asynchronous line driven by a PIC to notify the CPU of some event, usually some hardware event governed by that PIC.

**joystick**

A controller device with a handle that swings up, down, left, or right, used to position something on the screen.

**light pen**

A controller device consisting of a stylus and tablet used for drawing something on the screen.

**local bus**

The main system bus of an Amiga computer is called the local bus. In general, the main CPU, video chips, chip memory, and any other built-in resources are on the local bus. The bus controller sits on both the local and expansion buses and manages the communications between them.

**longword**

Based on the Motorola conventions, a longword is equal to 4 bytes.

**low**

A signal driven to a logical +0V state is said to be low.

---

**low resolution (Lores)**

A horizontal display mode in which 320 pixels are displayed across a horizontal line in a normal-sized display. On the Amiga, a low resolution display is often called Lores.

**manual mode**

Non-DMA output. In sprites, a mode in which each line of a sprite is written in a separate operation. In audio applications, a mode in which audio data words are written one at a time to the output channel.

**master**

The device currently generating addresses for the expansion bus. There is only one master on the bus at a time, this being insured by the bus arbitration logic. The master also drives data on writes, the read, cycle, and data strobes, and several other signals.

**MIDI**

A communications standard which allows electronic music devices to share information. MIDI stands for Musical Instrument Digital Interface and is endorsed by the majority of musical instrument manufacturers.

**microsecond (us)**

One millionth of second (1/1,000,000).

**millisecond (ms)**

One thousandth of second (1/1,000).

**minterm**

One of eight possible logical combinations of data bits from three different data sources.

**modulo**

A number defining which data in memory belongs on each horizontal line of the display. Refers to the number of bytes in memory between the last word on one horizontal line and the beginning of the first word on the next line.

**motherboard**

The main system circuit board for any Amiga computer. Resources on the local bus of a machine are often called motherboard resources.

**mouse**

A controller device that can be rolled around to move something on the screen; also has buttons to give other forms of input.

**multitasking**

The ability to perform more than one operation, or task, at a time.

**nanosecond (ns)**

One billionth of a second (1/1,000,000,000).

---

**negated**

The inactive state of a signal, regardless of its logic sense.

**non-interlaced mode**

A display mode in which 200 lines are displayed from top to bottom of the video display in a normal-sized display.

**NTSC**

Short for National Television Standards Committee specification for composite video. NTSC is the standard used for video broadcasting in the US. Other video standards include PAL, used widely in Europe, and SECAM. When the Amiga is operating in an NTSC environment, the base crystal frequency is 28.63636 MHz.

**nybble**

A collection of four bits; one half of a byte. AUTOCONFIG ROMs are physically nybble-wide.

**overscan area**

The normally unused area surrounding a standard-size computer display. The overscan area is important in video applications.

**paddle controller**

A game controller that uses a potentiometer (variable resistor) to position objects on the screen.

**PAL**

Short for Phase Alternate Line. PAL is the video broadcast standard widely used in Europe. Although PAL is similar to the NTSC standard used in the US, the two systems are incompatible. Under PAL, the base Amiga crystal frequency is 28.37516 MHz.

**parallel port**

A connector on the back of the Amiga that allows extra equipment such as a printer to be attached. The parallel port transfers data one complete byte (8 bits) at a time, in contrast to the serial port which sends a single bit at a time.

**Paula**

One of the three main Amiga custom chips, Paula contains audio, disk, and interrupt circuitry.

**PIC**

Plug-In Card. Any Amiga expansion card is called a PIC for short.

**pitch**

1. The quality of a sound expressed as its highness or lowness. 2. The number of characters printed in a horizontal inch.

**pixels**

The dots of light that make up the Amiga screen display. A pixel is the smallest unit of display information for a given screen.

---

**playfield**

The background for all the other display elements on the Amiga. Playfields provide the hardware-level logic for creating the Amiga's display.

**playfield object**

Subsection of a playfield that is used in playfield animation.

**playfield animation**

*See* bitplane animation.

**pointer register**

Register that is continuously incremented to point to a series of memory locations.

**polarity**

True or false state of a bit.

**potentiometer**

An electrical analog device used to adjust some variable value.

**quantization noise**

In audio applications, noise introduced by round-off errors when you are trying to reproduce a signal by approximation.

**RAM**

Short for random access memory. RAM is the part of the Amiga's memory which can be used for data storage and is directly accessible by the CPU. RAM storage is volatile, meaning that data in RAM is lost when the Amiga is rebooted or turned off; as opposed to ROM memory which is permanent.

**raster**

The area in memory that completely defines a bitmap display.

**read-only**

Describes a register or memory area that can be read but not written.

**request**

Asking for the use of some resource; the Zorro III bus has two kinds of requests, bus requests and quick interrupt requests.

**resolution**

The number of pixels associated with a particular display mode. For example, a normal NTSC Hires screen has a resolution of 640 (horizontal) by 200 (vertical) pixels.

**ROM**

Short for read-only memory. ROM is the part of the Amiga's memory which is permanent, or non-volatile. The Amiga's operating system is stored in ROM.

**sample**

In audio applications, a single discrete data item which represents a waveform amplitude at a given instant. A group of samples taken over time is used to represent a waveform in the



---

Amiga's memory.

**sampling rate**

The number of samples played per second. Also used to mean the rate at which the samples were originally recorded.

**sampling period**

The value that determines how many clock cycles it takes to play one data sample.

**scroll**

To move a playfield smoothly in a vertical or horizontal direction.

**SCSI**

Acronym for Small Computer System Interface. SCSI is a standard interface protocol for connecting peripherals, especially hard disk drives and other mass storage devices, to computers.

**serial port**

A connector on the back of the Amiga that allows extra equipment such as a printer to be attached. The serial port transfers data one single bit at a time in contrast to the parallel port which sends one complete byte (8 bits) at a time.

**set**

To change a bit or flag to 1, its on or enabled state.; as opposed to *clear*.

**Shell**

The command line interface used to send typed commands to the Amiga. One of the three user interfaces built into the Amiga.

**slave**

The device currently responding to the address on the expansion bus. There is only one slave on the bus at a time; an error is signalled by the bus collision detect logic if multiple slaves respond to the same address. The slave also drives data on reads, the transfer acknowledge strobe, and several other signals.

**slot**

A physical port on a Zorro backplane, which supplies independent /SLAVEN /BRN, and /BGN lines, chained /CFGINN and /CFGOUTN lines, and is mechanically manifested as a 100 pin single-piece connector.

**sprite**

Easily movable graphics object that is produced by one of the eight sprite DMA channels and is independent of the playfield display.

**strobe address**

An address you put out to the bus in order to cause some other action to take place; the actual data written or read is ignored.

---

**task**

A software function spawned by a process. Each task is an operating system module or application program which is running and that has full control over its own virtual 68000 machine.

**termination**

Circuitry attached to a bus signal in order to minimize annoying analog things like ringing, reflections, crosstalk, and possibly random logic conditions which can arise when a bus is undriven.

**timbre**

The distinctive quality of a sound produced by its overtones.

**timeout**

A bus cycle terminated by the bus controller instead of by a responding slave device. If no slave responds to a bus cycle within a reasonable time period, the bus controller will terminate the cycle to prevent lockup of the system.

**transparent**

In graphics, a special color register definition that allows a background color to show through. Used in dual-playfield mode.

**tri-state**

A signal driven to a high impedance condition is said to be tri-stated.

**UART**

The circuit that controls the serial link to peripheral devices, short for Universal Asynchronous Receiver/Transmitter.

**video priority**

Defines which graphic objects (playfields and sprites) are shown in the foreground and which objects are shown in the background when they occupy the same area of the display. Higher-priority objects appear in front of lower-priority objects.

**video display**

Everything that appears on the screen of a video monitor or television.

**write-only**

Describes a register that can be written to but cannot be read.

**word**

Based on the Motorola conventions, a word is equal to 2 bytes.

**Zorro**

The name given to the Amiga bus specification. “Zorro I” refers to the original design for A1000 backplane boxes, “Zorro II” refers to the modification to this specification used for the A2000 and compatible backplanes, and “Zorro III” refers to the Zorro II compatible bus specification first used in the Amiga 3000 computer.





---

# INDEX

- \$00C00000, 5
- 60 Pin Edge Connector, 321
- 68000, 2, 5, 187
  - normal cycle, 196
  - test-and-set instruction, 196
- 68010, 1
- 68020, 1, 187
- 68030, 1
- 680x0, 19, 25, 34, 194, 223
  - instead of Copper, 35
  - interrupting, 35, 217
  - shared memory, 4
  - synchronizing with the video beam, 216
- 8361, 5
- 8370, 5
- 8371, 5
- 8372A, 5
- 8520, 157, 223, 241, 244, 251, 339
  - alarm, 344
  - handshaking, 341
  - input modes, 343
  - interval timers, 341
    - continuous, 342
    - force load, 342
    - one-shot, 342
    - PB on/off, 342
    - start/stop, 342
    - Toggle/pulse, 342
  - I/O ports, 341
  - read bit names, 343
  - register map, 340
  - signal assignments, 337
  - time-of-day clock, 344
  - write bit names, 343
- 86 Pin Edge Connector, 322
- A1000, 1, 5-7, 63-64, 238, 260
  - expansion port, 321
- A2000, 1, 5-7, 63, 157, 238, 260
- A3000, 1, 6-7, 260
  - expansion bus, 383
- A500, 1, 5-7, 63, 157, 238, 260
- Address Registers, 10
- ADKCON, 241, 250, 256
  - disk control bits, 249
  - in audio, 149-150
- Agnus, 2, 5, 164-165, 169
  - ECS fat Agnus, 295
  - fat agnus, 187
- Alarm, 344
- Aliasing
  - audio, 154
- AllocMem(), 52
- Amiga OS, 9
- Amplitude Modulation, 4
- Animated Objects, 6
- Animation, 176
- Apple II, 241
- Area Fill, 4, 184
- ATTACH, 120
- Attachment
  - audio, 150
  - sprites, 120
- Audio, 4, 9, 20
  - aliasing distortion, 154
  - amplitude modulation, 4
  - channels
    - attaching, 149, 164
    - choosing, 137
  - data, 137
  - data length registers, 139
  - data location registers, 138-139
  - data output rate, 140
  - decibel values, 140, 163
  - DMA, 138, 144, 147, 164

- equal-tempered scale, 158
- frequency modulation, 4
- in ECS, 310
- interrupts, 147, 220
- joining tones, 147
- low-pass filter, 155
- modulation, 164
  - amplitude, 149
  - frequency, 149
- noise reduction, 154
- non-DMA output, 157
- period, 140
- period register, 143
- playing multiple tones, 149
- producing a steady tone, 145
- sampling period, 141
- sampling rate, 141, 152, 156, 164
- state machine, 164
- stopping, 145
- system overhead, 153
- volume, 139, 163
- volume registers, 139
- waveform transitions, 152

Audio Channel, 19

AUDx, 220

AUDxEN, 144, 222

AUDxLCH, 138, 298

AUDxLCL, 138

AUDxLEN, 139

AUDxPER, 143, 298

AUDxVOL, 139

AUTOCONFIG, 7, 223, 430

Background color, 46

Barrel Shifter, 179

BBUSY, 222

Beam comparator, 124

Beam position
 

- comparison enable bits, 24
- detection of, 216
- in Copper use, 31
- registers, 216
- vertical, 23-24

Beam position counter, 216

BEAMCON0, 298, 305

Bitplanes
 

- coloring, 55
- DMA, 62
- in dual-playfield mode, 68
- setting the number of, 48
- setting the pointers, 54

Blitter, 4, 6, 9, 19
 

- address scanning, 173
- addressing, 170
- animation, 176
- area fill, 4, 184
- area filling
  - exclusive, 184
  - inclusive, 184
- blit time, 193
- blitter done flag, 186
- blitter-finished disable bit (BFD), 35
- blitter-nasty bit, 198
- block transfers, 171, 183
- BLTSIZE, 187
- bus sharing, 196
- clock, 193
- cookie-cut, 176, 181, 183
- copying, 169, 183
- cycle time, 193
- data fetch, 170
- data overlap, 182
- descending mode, 182-183
- DisownBlitter(), 187
- DMA enable, 181, 184, 187
- DMA priority, 194
- DMA time slots, 194
- equation-to-minterm conversion, 175
- example, 200
- FILL\_CARRYIN bit, 185
- height, 171
- immediate data, 170, 182
- in ECS, 296
- interrupts, 187, 220
- LF control byte, 174
- line drawing, 4
  - logic function, 191
  - octants, 190
  - registers, 189
- line drawing mode, 189
- line texture, 191
- linear data, 173
- logic equations, 175
- logic operations, 174
- masking, 181, 183-184

- minterms, 175
- modulo, 172
- modulo registers, 172
- octants, 189
- OwnBlitter(), 187
- packed font, 180
- pipelined, 188
- pointer registers, 170
- sequence of bus cycles, 188
- shifting, 182-183
- size of blit, 171
- starting operation, 169
- text, 180
- truth-table, 174
- Venn Diagrams, 178
- WaitBlit(), 187
- width, 171
- with the Copper, 35
- zero detection, 187
- Blitter Busy, 187
- Blitter registers
  - in line-drawing mode, 189
- Blitter shifting, 179
- BLTAXWM, 180
- BLTCON0, 182
  - DMA enable, 170
  - in line drawing, 189, 191
  - in logic operations, 174
  - in shift control, 179
- BLTCON0L, 298
- BLTCON1, 182, 189, 298
  - in area fill, 184
  - in blitter addressing, 182
  - in line drawing, 189-191
  - in shift control, 179
- BLTEN, 222
- BLTPRI, 222
- BLTSIZE, 169, 171-173, 186-187, 191, 308
- BLTSIZH, 298
- BLTSIZV, 298, 308
- BLTXDAT, 170
- BLTXMOD, 172
- BLTXPTH, 170, 298
- BLTXPTL, 170
- BPL1MOD, 62, 64
- BPL2MOD, 62, 64
- BPLCON0, 87, 229, 298, 300
  - enabling color, 63
  - in dual-playfield mode, 72
  - in hold-and-modify mode, 87
  - in interlacing, 51
  - in resolution mode, 49
  - in the Enhanced Chip Set, 300
  - selecting bitplanes, 48
  - setting bits, 48
  - with light pen, 239
- BPLCON1, 85
  - setting scrolling delay, 85
- BPLCON2, 72, 210, 298
  - in dual-playfield priority, 71
- BPLCON3, 298
- BPLCONx, 90, 307
- BPLEN, 222
- BPLxMOD, 75, 91
- BPLxPT, 91
- BPLxPTH, 52, 54, 61, 74
- BPLxPTL, 52, 54, 61, 74
- BPUx, 48, 87, 90
- Bridgeboard, 7
- BZERO, 222
- Cache, 187, 388
- CDANG, 26
- Chip Memory, 1, 5-6, 20, 105, 138, 169-170, 186, 223, 246
- Chip memory, 296
- CIA, 9, 157, 241, 251, 339
- CIAA
  - address map, 339
- CIAADDRA, 241
- CIAAPRA, 229, 232-233, 241
  - disk, 244
- CIAB
  - address map, 340
- CIABPRB
  - disk, 244
- Clock, 260
  - 8520, 344
  - alarm, 344
  - audio, 140-142, 159, 164
  - blitter, 193-194
  - color, 194, 255
  - keyboard, 251
  - system, 2, 193
- Clock Constant, 141, 159

---

Clock cycle, 4  
 Clock Interval, 141  
 CLXCON, 215  
 CLXDAT, 214  
 CNT, 251  
 Collision, 213  
     control register, 215  
     detection register, 213  
 Collision Detection, 4  
 Color  
     attached sprites, 122  
     background color, 46  
     color indirection, 42  
     color table, 46  
     enabling, 63  
     in dual-playfield mode, 70  
     in hold-and-modify mode, 86  
     in SuperHires mode, 301  
     in the Enhanced Chip Set, 301  
     sample register contents, 92  
     sprites, 102  
 Color Clock, 60, 194, 255, 304  
 Color Palette, 3, 19  
 Color Registers, 3  
 Color registers  
     contents, 46  
     loading, 47  
     names of registers, 46  
     sprites, 130  
 Color selection  
     in high resolution mode, 94  
     in hold-and-modify mode, 95  
     in low resolution mode, 93  
 COLOR00, 46, 55  
 COLOR\_ON, 89  
 COLORx, 10, 27-28, 46, 70-71, 87  
 Comparator, 124  
 Composite Video, 7  
 Control Register, 348  
     register A, 348  
         bitmap, 349  
     register B, 349  
         bitmap, 350  
 Controller Port  
     connection chart, 228  
     joystick, 232  
     mouse, 229  
     output to, 240  
     registers, 229  
     trackball, 229  
 Controllers  
     light pen, 238  
     potentiometers, 236  
     proportional  
         registers, 236  
     special, 240  
     types, 6  
 COP1LC, 25, 30, 32, 34  
 COP1LCH, 25, 298  
 COP1LCL, 25  
 COP2LC, 25-26, 33  
 COP2LCH, 25, 298  
 COP2LCL, 25  
 COPCON, 26, 298  
 COPEN, 30, 35, 222  
 COPJMP1, 26  
 COPJMP2, 26  
 Copper, 9, 19, 45, 54, 62-65, 80-82, 110,  
     122, 194, 197, 216, 219  
     affecting registers, 26  
     at reset, 30  
     bus cycles used, 20  
     comparison enable, 32  
     control register, 26  
     danger bit (CDANG), 26  
     DMA, 30  
     features, 20  
     horizontal beam position, 23  
     in interlaced mode, 34  
     in memory operations, 20  
     in vertical blanking interrupts, 219  
     instruction fetch, 25  
     instruction lists, 26, 28  
     instructions  
         description, 20  
         ordering, 27  
         summary, 36  
     interrupt, 219  
     interrupting the 680x0, 35  
     jump, 25  
     jump strobe addresses, 26  
     location registers, 25, 30, 32  
     loops and branches, 32  
     memory cycles, 22



- MOVE instruction, 21
- MOVE to registers, 21
- registers, 25
- resolution, 23-24
- SKIP instruction, 31-32
- starting, 26, 30
- stopping, 30
- strobe address, 25
- vertical beam position, 24
- WAIT instruction, 22, 30, 32
- with sprites, 113
- with the blitter, 26, 35
- Coprocessor
  - (see Copper), 19
- Copying data, 169
- CP/M, 241
- CTRL-AMIGA-AMIGA, 253
- Custom Chips, 2, 170, 255
  - control registers, 19
  - register, 263
  - steal cycles, 4
- Data-fetch
  - high resolution, 62
  - in basic playfield, 60
  - in horizontal scrolling, 82
- Data-fetch start
  - normal, 60
- Data-fetch stop
  - normal, 60
- DBLPF, 87, 90
- DDFSTOP, 60-61, 79, 82, 91, 99
- DDFSTRT, 60, 79, 82, 91, 99
- Decibel values, 163
- Denise, 2, 297
- DENISEID, 298
- Descending Mode
  - blitter, 182
- DEST, 170
- Digital Joystick
  - connection, 329
  - fire buttons, 329
- Disk, 20
  - controller, 6, 241
  - DMA, 246
  - DMA pointer registers, 246
  - drives, 6
  - external
    - identification, 335
    - interface, 334
    - limitations, 335
    - pins, 334
  - external connector, 367
    - device ID, 370
    - pins, 367
    - signals, 368
  - floppy, 4
  - input stream synchronization register (DSKSYNC), 250
  - internal
    - pins, 336
    - power, 336
  - interrupts, 220, 250
  - MFM Encoding, 249
  - read data register, 248
  - write, 246
- Disk Port, 320
- Display
  - size of, 57
- Display DMA, 20
- Display field, 40
- Display memory, 57
- Display modes, 41
- Display window
  - positioning, 57
  - size
    - maximum, 79, 306
    - normal, 58
  - starting position
    - horizontal, 58, 77, 306
    - vertical, 58, 77, 306
  - stopping position
    - horizontal, 59, 78, 306
    - vertical, 59, 79, 306
- DIWHIGH, 298, 306
- DIWSTOP, 59, 78, 91, 99, 219, 306
- DIWSTRT, 58-59, 76, 91, 99, 219, 306
- DMA, 4, 207
  - audio, 137-138, 141, 144-145, 147-148, 153, 157, 164-165, 194, 220
  - bitplanes, 62
  - blitter, 50, 170-174, 176, 179-181, 183-184, 187, 189, 191, 193-194, 196-198
  - control, 222

control register, 218, 222  
 copper, 19-20, 30  
 disk, 4, 194, 220, 241, 246-247, 250  
 display, 20, 194, 300  
 playfield, 62  
 sprites, 4, 27, 97, 102, 108-110, 115-118,  
 120-121, 123, 126-128, 194  
 DMA Contention, 193  
 DMA Priority, 194  
 DMAB\_BLTDONE, 187  
 DMACON, 222, 247  
     blitter done, 186  
     DMAF\_BLITHOG bit, 198  
     in audio, 144  
     in playfields, 62  
     stopping the Copper, 30  
     zero detection, 187  
 DMACONR, 222  
 DMAEN, 144, 222, 247  
 DMAF\_BLITHOG, 198  
 DMAF\_BLTNZERO, 187  
 DSK, 244  
 DSKBLK, 220  
 DSKBYTR, 241, 248  
 DSKCHANGE, 244  
 DSKDIREC, 244  
 DSKEN, 222  
 DSKINDEX, 244  
 DSKLEN, 241, 246-247  
 DSKMOTOR, 244  
 DSKPROT, 244  
 DSKPTH, 241, 246, 298  
 DSKRDY, 244  
 DSKSELx, 244  
 DSKSIDE, 244  
 DSKSTEP, 244  
 DSKSYN, 220  
 DSKSYNC, 241, 247, 250  
 DSKTRACK0, 244  
 Dual Playfield, 44  
     bitplane assignment, 68  
     description, 67  
     enabling, 72  
     high resolution colors, 71  
     in high resolution mode, 71  
     low resolution colors, 70  
     priority, 71  
     scrolling, 71  
 ECS  
     sprites, 302-303  
 ECS Registers  
     ECS Registers, 36  
 Enhanced Chip Set, 295  
     blitter, 296  
     ECS Registers, 131, 166, 169, 205, 224  
     memory, 296  
 Enhanced Chip Set (ECS)  
     ECS Registers, 95  
 Examples, 9  
 Expansion Boards, 7  
 Expansion Bus, 383  
 Expansion Connector, 7  
 Expansion connector, 385  
 External interrupts, 219  
 FAST, 249  
 Fast Memory, 5  
 Fat Agnus, 5, 187  
 Field time, 40  
 Floppy Disk, 4  
 Floppy: See DISK, 241  
 Frame Buffer, 6  
 Frequency Modulation, 4  
 Game Controller Port, 327  
 GAUD, 89  
 GCR, 250  
 Genlock, 2, 49, 51, 89, 159, 260  
     effect on background color, 46  
     in ECS, 296  
     in playfields, 89  
 HAM, 86  
 Hardware Connection, 353  
     address inputs, 354  
     chip select, 353  
     clock input, 353  
     data bus I/O, 354  
     interrupt request, 354  
     read/write input, 353  
     reset input, 354  
 HBSTOP, 298  
 HBSTRT, 298  
 HCENTER, 298  
 High resolution  
     color selection, 49, 94  
     memory requirements, 53

- SuperHires, 300
  - with dual playfields, 71
  - with ECS, 296
- HIRES, 87
- Hold-And-Modify, 3, 86
- HOMOD, 87, 90
- Horizontal blanking interval, 23, 304
- HSSTOP, 298
- HSSTRT, 298
- HSTART, 59, 91, 107, 113
- HSTOP, 59, 78, 91
- HTOTAL, 298, 304
- IBM PC, 6-7, 241
- Include Files, 10, 22
- INTENA, 218
- INTENAR, 218
- Interlaced mode
  - Copper in, 34
  - memory requirements, 53
  - modulo, 62
  - setting interlaced mode, 49
- Interleaved Memory, 4
- Internal Slots, 7
- Interrupt, 26, 34-35, 207, 217
  - 8520, 251
  - audio, 147-148, 153, 157, 164-165, 220
  - beam synchronized, 3
  - blitter, 35, 171, 187, 220
  - control registers, 217
  - copper, 25, 32, 216
  - Copper, 219
  - copper, 219
  - disk, 220, 245, 250
  - external, 219
  - graphics, 33
  - interrupt enable bit, 218
  - interrupt lines, 217
  - maskable, 217
  - nonmaskable, 217
  - parallel, 259
  - priorities, 220
  - registers, 218
  - serial, 255-256, 258
  - serial port, 220
  - setting and clearing bits, 218
  - vertical blanking, 219
- Interrupt Control Register, 346
  - read, 347
  - write, 347
- Interrupts
  - during vertical blanking, 219
- INTF\_BLIT, 187
- INTREQ, 35, 218
- INTREQR, 218
- Joy Stick Port, 323
- JOY0DAT/JOY1DAT
  - with joystick, 232
  - with mouse/trackball, 230
- Joystick
  - connections, 228
  - reading, 232
- JOYxDAT, 229
- Keyboard, 251, 357
  - Caps lock, 359
  - communications, 357
  - errors, 360
  - ghosting, 253
  - hard reset, 361
  - keycodes, 358
    - transmission, 358
  - matrix, 362
  - out-of-sync, 359
  - power up, 360
  - raw keycodes, 251
  - reading, 251
  - reset warning, 361
  - self test, 360
  - signals, 6, 357
  - special codes, 364
  - timing diagram, 358
- Keyboard Port, 319
- LACE, 51
- LED
  - caps-lock, 253
- Light Pen, 333
  - connections, 228
  - pins, 333
  - reading, 238
  - registers, 238
- Line Drawing, 4, 189
  - length, 191
  - logic function, 191
  - octants, 189
  - registers, 191

Low resolution  
     color selection, 93  
 LPEN, 89  
 Manual mode  
     in sprites, 123  
 Memory  
     adding, 7  
     blitter access to, 169  
 Memory allocation  
     audio, 138  
     formula for playfields, 76  
     playfields, 53  
 Memory Allocation  
     playfields, 76  
 Memory allocation  
     sprite data, 105  
 Memory Cycle Time, 194  
 Memory map, 388  
 MFM Encoding, 241, 249-250  
 MFMPREC, 249  
 MIDI, 318  
 Minterms, 175  
 Modulation  
     amplitude, 149  
     frequency, 149  
 Modulo  
     blitter, 172  
     in basic playfield, 61  
     in horizontal scrolling, 82  
     in interlaced mode, 62  
     in larger playfield, 73  
 Monitors - See Video, 260  
 Mouse  
     connections, 228  
     reading, 229  
 Mouse Port, 328  
 MOVE, 19-21  
 MSBSYNC, 249-250  
 MS-DOS, 6-7, 241  
 Multiprocessor, 223  
 Multitasking, 9  
 Noise  
     audio, 154  
 NTSC, 62, 100  
     audio, 140-141, 158-159  
     blitter, 193  
     clock, 2  
     playfield, 49, 52, 57-58  
     serial baud rate, 255  
     sprites, 100  
     vertical blank, 219  
     video, 3, 24, 27, 34, 40-41, 45, 304  
 Octants, 189  
 OVERRUN, 256  
 Overscan, 3, 57, 99  
 Packed Font, 180  
 Paddle Controller  
     connections, 228  
     reading, 234  
 PAL, 3, 62  
     audio, 140-141, 158-159  
     beam position, 216  
     blitter, 193  
     clock, 2  
     playfield, 49, 52, 57-58  
     serial baud rate, 255  
     sprites, 100  
     vertical blank, 219  
     video, 3, 24, 34, 40-41, 45, 304  
 Parallel, 9  
 Parallel Port, 227, 259, 319  
     pin assignment, 324  
     specification, 324  
     timing, 325  
 Paula, 2, 6, 255  
 Peripherals, 6-7  
 Pipeline, 188  
 Pixels  
     definition, 40  
     in sprites, 101  
 Playfield, 4, 6, 9  
 Playfields  
     allocating memory, 52  
     bitplane pointers, 54  
     collision, 213  
     color of pixels, 42-44  
     color register contents, 92  
     color table, 46  
     coloring the bitplanes, 45, 55  
     colors in a single playfield, 45  
     defining a scrolled playfield, 85  
     defining display window, 57  
     defining dual playfields, 72  
     defining the basic playfield, 63

- display window size
  - maximum, 79
  - normal, 58
- displaying, 62
- dual-playfield mode, 67
- enabling DMA, 62
- fetching data, 60-61, 79
- forming, 44
- high resolution, 42
  - color selection, 94
  - example, 66
- hold-and-modify, 95
- hold-and-modify mode, 86
- interlaced, 42
- interlaced example, 66
- low resolution, 42
  - colors, 93
- memory required, 52, 76
- modulo registers, 62
- multiple-playfield display, 89
- non-interlaced, 42
- normal, 42
- pointer registers, 66, 74
- priority, 210
- register summary, 89
- scrolling
  - horizontal, 82
  - vertical, 81
- selecting bitplanes, 48
- setting resolution mode, 49
- specifying modulo, 61, 73
- specifying the data fetch, 75
- with external video source, 89
- with genlock, 89
- with larger display memory, 73

Playfield-sprite priority, 209

Port Signal Assignments, 350

Ports

- controller, 227
- disk, 241
- parallel, 259
- serial, 255
- video, 260

POT0DAT, 236, 298

POT1DAT, 236, 298

POTGO, 229

POTGO / POTINP
 

- as digital I/O, 240
- as proportional inputs, 234

POTGOR, 229
 

- name changed. See POTINP, 240

POTxDAT, 229

Power up operation, 223

PRECOMPx, 249

Priority
 

- dual playfields, 71
- playfield-sprite, 209
- priority control register, 210
- sprites, 207

Productivity mode, 3

Proportional Controller, 331
 

- pins, 332

Proportional Controllers
 

- reading, 234

Proportional Joystick
 

- connections, 228
- reading, 234

RAM, 21, 47
 

- address space, 2
- at startup, 223
- chip, 6, 20, 138
- disk, 246
- expansion, 2, 7
- keyboard, 253

RAMEX, 321

Reboot, 223-224

Refresh, 20

Reset, 223

Resolution
 

- setting, 49

RF Modulator, 260

RF Monitor, 320

RGB
 

- analog, 260
- digital, 260

RGB Video, 7, 49, 63-64

ROM, 1, 6, 223, 253

RS-232, 6, 255

RS-232 and MIDI, 318

Sampling
 

- period, 141
- rate, 152

Scrolling
 

- data fetch, 82

- delay, 85
- horizontal, 82
- in dual-playfield mode, 71
- in high resolution mode, 82
- modulo, 82
- vertical, 81
- SCSI
  - Disk Port, 321
- SCSI Disk
  - internal
    - pins, 336
- SERDAT, 258-259
- SERDATR, 256
- Serial, 9
- Serial Port, 255
  - characteristics, 327
  - pin assignment, 326
  - specification, 326
  - timing, 327
- Serial Shift Register, 345
  - bidirectional feature, 346
  - input mode, 345
  - output mode, 345
- SERPER, 255
- SET/CLR, 35, 144-145, 218, 222, 249, 257
- Shifting
  - blitter, 182
- SKIP, 20
- Slow Memory, 5
- Sound generation, 134
- SPREN, 222
- Sprite, 4, 9, 19-20
- Sprite Colors, 27
- Sprite DMA, 27
- Sprites
  - address pointers, 110
  - arming and disarming, 123
  - attached
    - color registers, 131
    - colors, 122
    - control word, 120
    - copper list, 122
    - data words, 121, 123
  - clipped, 100
  - collision, 113, 213
  - color, 102, 302
  - color registers used, 103
  - comparator, 124, 126
  - control registers, 124, 126-127
  - control words, 107
  - data registers, 126, 129
  - data structure, 104
  - data words, 107
  - designing, 103
  - displaying
    - example, 111
    - steps in, 109
  - DMA, 110, 114
  - end-of-data words, 108
  - Enhanced Chip Set, 302-303
  - forming, 98
  - manual mode, 123
  - memory requirements, 105
  - moving, 113
  - overlapped, 118
  - parallel-to-serial converters, 124
  - pixels in sprites, 101
  - pointer registers, 127
    - initializing, 110
    - resetting, 110
  - position registers, 124, 126
  - priorities, 207
  - priority, 115, 118, 210
  - reuse, 114, 116
  - screen position
    - horizontal, 98, 107
    - vertical, 100
  - shape, 101
  - size, 101
  - vertical position, 107
  - with copper, 113
- SPRxCTL, 107, 123-124, 126, 128-129, 298, 303
- SPRxDATA, 123, 126, 129
- SPRxDATB, 123, 126, 129
- SPRxPOS, 107, 123-124, 126, 128-129, 303
- SPRxPT, 114
- SPRxPTH, 110, 126-127
- SPRxPTL, 110, 126-127
- SRCA, 170
- SRCB, 170
- SRCD, 170
- Stereo, 4
- STRLONG, 298

- System Clock, 2
- System Control Hardware, 9
- TAS, 196, 223
- Trackball, 328
  - connections, 228
  - reading, 229
- Trackdisk, 9
- TSRE, 259
- UART, 255
- UARTBRK, 257
- VBSTOP, 298
- VBSTRT, 298
- VCR, 46
- Vertical Blanking, 30, 32, 304
- VGA, 304
- VHPOSR, 229
  - with beam counter, 216
  - with light pen, 238
- VHPOSW
  - with beam counter, 216
- Video
  - analog RGB, 260
  - beam position, 3, 23
  - camera input, 7
  - composite, 260
  - digital RGB, 260
  - external sources, 89
  - interrupt, 3
  - laser disk input, 7
  - monitors, 7
  - monochrome, 260
  - output, 260
  - priority, 4
  - RF modulator, 260
  - RGB, 49, 63-64
  - synchronization, 3
  - VCR input, 7
  - video slot, 260
- Video Beam Position, 26
- Video Input, 46
- Video Port, 319
- Volume, 139
- VPOSR, 229, 298-299
  - in playfields, 66
  - with beam counter, 216
  - with light pen, 238-239
- VPOSW
  - with beam counter, 216
- VSSTOP, 298
- VSSTRT, 298
- VSTART, 59, 91, 107-108, 113
- VSTOP, 59, 78, 91, 107-108, 113
- VTOTAL, 298, 304
- WAIT, 19-20
- Waveform, 4
- Waveforms
  - audio, 134
- WORDSYNC, 249-250
- Zero Detection, 187
- Zorro Expansion Bus, 383
  - A2000, 384, 387, 391
  - A3000, 384, 387
  - autoconfiguration, 430
  - mechanical specifications, 427
  - memory mapping, 388
  - multiple transfer timing, 420
  - quick interrupt timing, 422
  - read timing, 416
  - write timing, 418
  - Zorro II signals, 391, 437-439
  - Zorro III signals, 409, 437-439











AMIGA TECHNICAL REFERENCE SERIES

# AMIGA<sup>®</sup> Hardware Reference Manual

The Amiga computers are exciting high-performance microcomputers with superb graphics, sound, multiwindow and multitasking capabilities. Their technologically advanced hardware is designed around the Motorola 68000 microprocessor family and sophisticated custom chips. The Amiga's unique system software provides programmers with unparalleled power, flexibility, and convenience in designing and creating programs.

Written by the technical experts at Commodore-Amiga, Inc., who design the Amiga hardware and system software, the *Amiga Hardware Reference Manual* presents an in-depth description of the Amiga's hardware and how it works. This new edition has been updated to cover the entire line of Amiga machines, from the Amiga 500 to the Amiga 3000. It includes:

- Explanations of the Amiga's Copper (graphics coprocessor), Blitter, sprite, playfield, and audio hardware components
- New sections on the capabilities of the Amiga's ECS (Enhanced Chip Set)
- Detailed information on the Amiga's Zorro expansion bus
- Specifications for the Amiga's external hardware connectors

The definitive source of information on the capabilities and features of the Amiga's custom chips and peripheral interfaces, the *Amiga Hardware Reference Manual* is an essential reference tool for the serious programmer who wishes to directly control allocated hardware resources.

The AMIGA TECHNICAL REFERENCE SERIES has been revised and updated to provide a comprehensive reference and tutorial for the entire line of Amiga computers and for Release 2 of the operating system. Other titles in the series include:

*Amiga User Interface Style Guide*

*Amiga ROM Kernel Reference Manual: Includes and Autodocs, Third Edition*

*Amiga ROM Kernel Reference Manual: Libraries, Third Edition*

*Amiga ROM Kernel Reference Manual: Devices, Third Edition*

Cover design by Hannus Design Associates

Addison-Wesley Publishing Company, Inc.

