

57 PRACTICAL PROGRAMS & GAMES IN BASIC

Programs for everything from space war games to blackjack...from craps to I Ching!

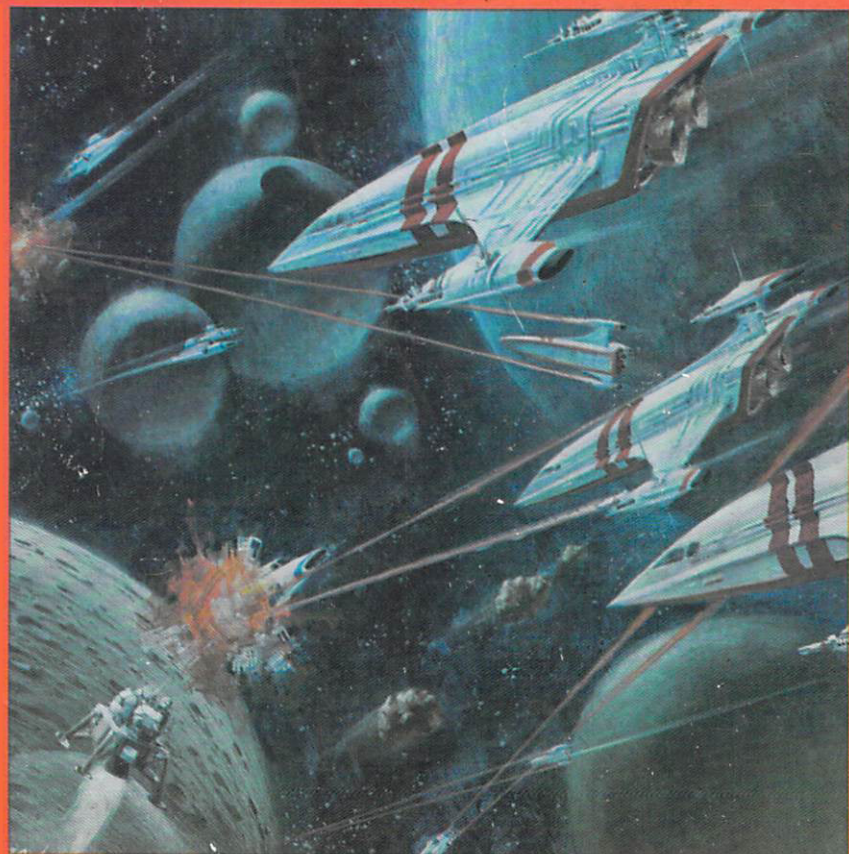

BY KEN TRACTON

**57 PRACTICAL
PROGRAMS & GAMES
IN BASIC**

**57 PRACTICAL
PROGRAMS & GAMES
IN BASIC**

BY KEN TRACTON

TAB **TAB BOOKS Inc.**
BLUE RIDGE SUMMIT, PA. 17214

FIRST EDITION

SIXTH PRINTING

Printed in the United States of America

Reproduction or publication of the content in any manner, without express permission of the publisher, is prohibited. No liability is assumed with respect to the use of the information herein.

Copyright © 1978 by TAB BOOKS Inc.

Library of Congress Cataloging in Publication Data

Tracton, Ken

57 practical programs & games in BASIC.

Includes index.

1. Mathematics—Computer programs. 2. Games—Computer programs. 3. Basic (Computer program language). I. Title.

QA76.6.T69 00.16'424 77-19006

ISBN 0-8306-9987-2

ISBN 0-8306-1000-6 pbk.

Cover illustration courtesy Atari Inc.

Preface

These programs are intended for the computer hobbyist or user who has access to a computer system with standard BASIC language available.

The various programs are written in such a manner that they will operate even with a simplified subset of full BASIC. The advanced programmer, with full BASIC available, can easily modify the programs to take advantage of the functions and capabilities of the full instruction set.

The programs were chosen not just for their intrinsic qualities, but also for their role as teaching aids.

I would like to take this opportunity to thank the following people who helped to make this book possible. Alec Grynspan, who supplied the Bubble-Sort program; Tom McRoberts, who was able to read my notes and typed the manuscript; Laura Semple, who drew the final drafts of the flow charts; Jane, who said programming is simple; and David, who named my Iguana.

I would like to extend a special thank you to Construction Data Systems, who allowed me access to their time-sharing facility on an IBM 370-158 computer systems.

Ken Tracton

Contents

Preface	5
Basic Statements.....	9
Annular Sections	12
Arithmetic Mean.....	15
Arithmetic Progression	18
Blackjack.....	21
Bubble Sort.....	26
Chi-Square Evaluation.....	27
Circle Determined by Three Points.....	30
Circular Sections	33
Compounded Amounts.....	36
Coordinate Translation and/or Rotation	41
Craps	44
Curve Tables (Plotting).....	48
Day of the Week.....	51
Determinant and Inverse of a 2×2 Matrix.....	54
Determinate Inverse of a 3×3 Matrix.....	57
Factorials	60
Fibonacci Numbers.....	62
First Derivative.....	66
Gamma Function and Generalized Factorial	69

Gaussian Probability Function.....	73
Gaussian Quadrature	75
Generalized Mean	78
Geometric Mean	81
Geometric Progression.....	83
Harmonic Mean	86
Harmonic Numbers.....	88
Harmonic Progressions	91
Hydrocarbon Combustion.....	95
Hyperbolic Functions	99
I Ching (The Chinese Book of Changes).....	103
Integral Between Two Limits	106
Interactive Growth Pattern.....	109
Inverse Hyperbolic Functions	113
L-Pad Minimum Loss System	118
Linear Interpolation.....	121
Logarithms of Any Base	124
Mean, Standard Deviation, Standard Error For Grouped Data.....	127
Moments, Skewness and Kurtosis.....	130

No Repetitions Probability	134
Number Guess Game	137
One-Arm Bandit.....	140
Permutations and Combinations	143
Pi-Network Impedance Matching	146
Points on the Circumference.....	149
Polar to Rectangular Conversion	152
Prime Test	155
Quadratic Equations	158
Rectangular to Polar Conversion	161
Rectangular Sections	164
Resistive Attenuator Design.....	167
Simultaneous Equations in Two Unknowns.....	171
Simultaneous Equations in Three Unknowns	174
Space Wars (1)	177
Space Wars (2)	184
Straight Line Depreciation	196
Vector Cross Product	199
Vector Dot Product and Norm.....	202

BASIC STATEMENTS

BASIC (Beginners' All-purpose Symbolic Instruction Code) was invented and developed between 1963 and 1964 by John Kemeny and Thomas Kurtz of Dartmouth College. Since its first use in 1964, BASIC has steadily gained popularity as a high-level computer language which the user can easily master. The essential vocabulary is below:

Statement	Example	Definition
CHANGE	CHANGE N\$ TO N	assigns to the elements of N the ASCII numeric value of the string N\$
DATA	DATA 15, -8, 76,...	the DATA statement assigns appropriate values to the variables listed in the READ statement
DEF	DEF FNR (X, Y) = (X 2 + Y 8)	a single line function is defined by the DEF statement
DIM	DIM Z(3, 4)	dimensions the elements of X as a 3 by 4 matrix
END	END	ends program execution
FNEND	FNEND	a multiline DEF statement must end with a FNEND (function end) statement
FOR-TO	FOR X = 2 TO 66	defines the FOR, NEXT loop
GOTO	GOTO 100	transfers execution to line 100
GOSUB	GOSUB 100	transfers program control to a subroutine commencing at 100
IF-THEN	IF A = X THEN 100	transfers program execution to 100 if the relational test is true
INPUT	INPUT X, Y,...	assigns to the variable(s) the values presented by the user from a user defined device
LET	LET A = V	assigns the value of V to A
NEXT	NEXT X	returns control to the beginning of the FOR-TO loop
ON-GO TO	ON M GO TO 10, 20, 30	as M ranges in values from 1 up to 1st, 2nd,...line number is transferred control, as follows to GO TO statement
PRINT	PRINT "LESLIE"	prints the alphanumeric string within quotation marks
RANDOMIZE	RANDOMIZE	assures each call to the RND produces a different order of random numbers
READ	READ L, K,...	reads values from the DATA statement found in the same program
REM	REM AREA	remark is placed in the program to be used only during listing as a debugging aid

Statement	Example	Definition
RESTORE	RESTORE	restores the data pointer
RETURN	RETURN	returns program execution to the next instruction following the subroutine call
RND	RND	produced a random number
STOP	STOP	stops program execution

LIBRARY FUNCTIONS

ABS	absolute value
ATN	arctangent
ASC	converts a ASCII character to its numeric value and assigns it
CHR\$	converts a numeric value to its ASCII character and assigns it
COS	cosine
COT	cotangent
DET	determinant
EXP	raise e to the x power
INT	truncates to an integer
LOC	determines the position of the pointer
LOF	determines the last storage location in a file
LOG	returns the log (base e) of the argument
RND	produces a random variable
SGN	determines the sign of a variable
SIN	sine
SQR	square root
TAB	positions printing head of a printer (CRT or LINE)
TAN	tangent

BASIC COMMAND FUNCTIONS

BYE	terminates time-sharing session
CATALOG	lists names of all files saved
GOOD-BYE	same as BYE
LIST	produced a listing of the current file
NEW	specifies that a new file is being formed
OLD	accesses an existing file
RENAME	allows the name of a current file to be changed
RUN	causes current program to be executed
SAVE	causes current program to be saved (stored)
SCRATCH	deletes the current file
SYSTEM	transfers control from BASIC to the system's monitor
UNSAVE	cancels storage of a file

exponential ↑
multiplication *

PROGRAMS

The programs appear in alphabetical order. Each one contains any applicable formulae, followed by an example of using the Program, the Flow Chart, and lastly, the Program itself.

ANNULAR SECTIONS

This program computes the various parameters; moment of inertia, polar moment of inertia and area; connected with an annular section.

FORMULAE

ANNULAR SECTION $I = \pi \frac{(d_2^4 - d_1^4)}{64}$ $A = \pi \frac{(d_2^2 - d_1^2)}{4}$

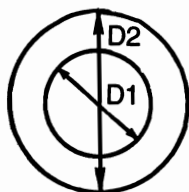

$$J = \pi \frac{(d_2^4 - d_1^4)}{32}$$

where I and J is in (in.³) and A is in (in.²).

EXAMPLE

INSIDE DIAMETER (D1) =

?

3

OUTSIDE DIAMETER (D2) =

?

4.11

MOMENT OF INERTIA = 10

POLAR MOMENT OF INERTIA = 20

AREA OF SECTION = 6.18

TYPE 1 TO CONTINUE, 0 TO STOP

?

0

* END

ANNULAR SECTIONS.

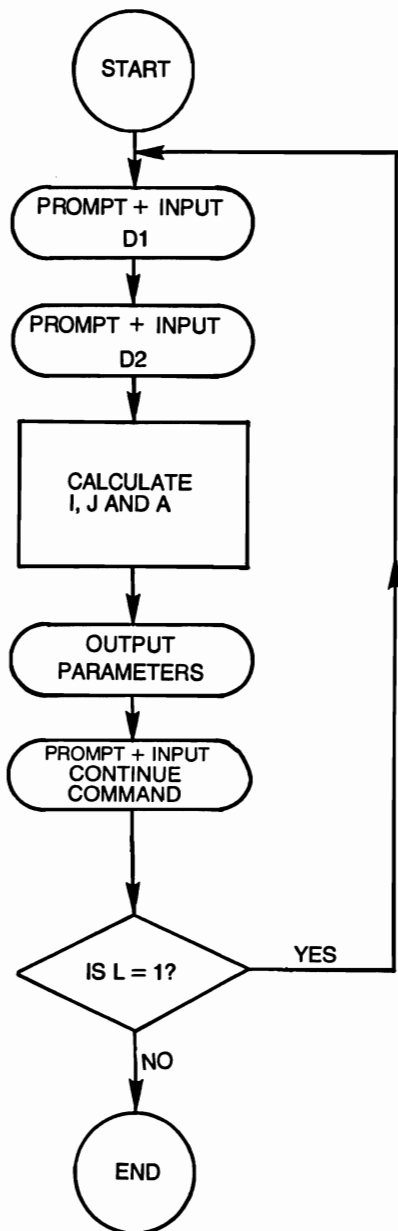

ANNULAR SECTIONS

```
10  REM THIS PROGRAM COMPUTES THE VARIOUS
20  REM PARAMETERS CONNECTED WITH AN ANNU-
    LAR
30  REM SECTION
40  PRINT "INSIDE DIAMETER (D1) = ";
50  INPUT D1
60  PRINT "OUTSIDE DIAMETER (D2) = ";
65  INPUT D2
70  LET P = 3.14159
80  LET I = (P*((D2↑ 4) - (D1↑ 4)))/64
90  LET J = I*2
100 LET A = (P*((D2↑ 2) - (D1↑ 2)))/4
110 PRINT "MOMENT OF INERTIA = ";I
120 PRINT "POLAR MOMENT OF INERTIA = ";J
130 PRINT "AREA OF SECTION = ";A
140 PRINT
150 PRINT "TYPE 1 TO CONTINUE, 0 TO STOP"
160 INPUT L
170 IF L = 1 THEN 190
180 STOP
190 PRINT
200 GO TO 40
210 END
```

ARITHMETIC MEAN

After each sample is entered the computer responds with sample number and the current mean. The program will continue to run until the operator types an exit or a break command.

FORMULA

$$\bar{A} = \frac{1}{N} \sum_{i=1}^N a_i$$

EXAMPLE

ENTER SAMPLE

?

5

N = 1 SAMPLE = 5 CURRENT MEAN = 5

ENTER SAMPLE

?

67

N = 2 SAMPLE = 67 CURRENT MEAN = 36

ENTER SAMPLE

?

5

N = 3 SAMPLE = 5 CURRENT MEAN = 25.6666

ENTER SAMPLE

?

45

N = 4 SAMPLE = 45 CURRENT MEAN = 30.5

ENTER SAMPLE

?

12

N = 5 SAMPLE = 12 CURRENT MEAN = 26.8000

ENTER SAMPLE

?

123

N = 6 SAMPLE = 123 CURRENT MEAN = 42.8333

ENTER SAMPLE

?

0

N = 7 SAMPLE = 0 CURRENT MEAN = 36.7142

ENTER SAMPLE

?

*END

ARITHMETIC MEAN

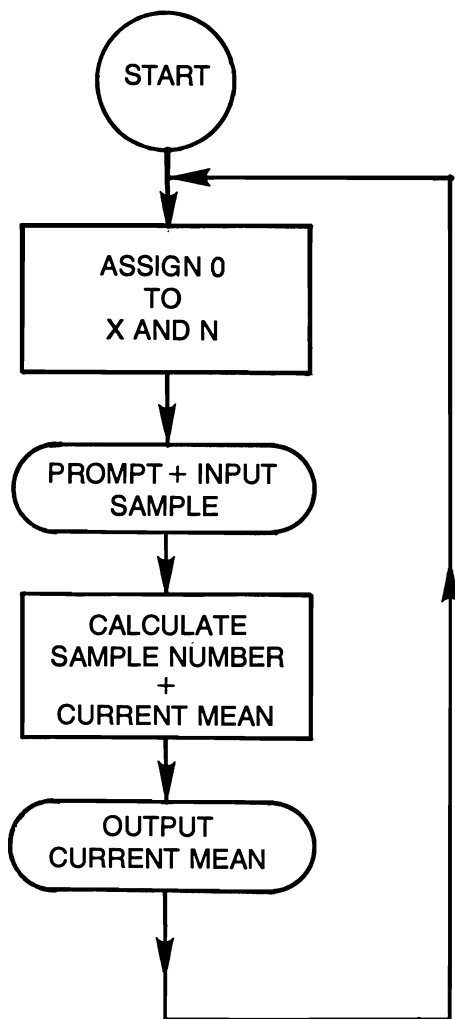

ARITHMETIC MEAN

```
10  REM THIS PROGRAM COMPUTES THE ARITHME-  
    TIC  
20  REM MEAN  
30  LET X = 0  
40  LET N = 0  
50  PRINT "ENTER SAMPLE";  
60  INPUT W  
70  LET N = N + 1  
80  LET X = X + W  
90  LET A = X/N  
100 PRINT "N = "; N, "SAMPLE = "; W, "CURRENT MEAN  
    = "; A  
110 GOTO 50  
120 END
```

ARITHMETIC PROGRESSION

From the following information; first term, common difference and number of terms, this program computes the arithmetic progression.

FORMULA

$$A, A + D, A + 2D, \dots A + ((N - 1)D)$$

EXAMPLE

FIRST TERM =

?

10

COMMON DIFFERENCE =

?

2

NUMBER OF TERMS =

?

5

FOR TABLE TYPE 1, IF NOT TYPE 0

?

1

ARITHMETIC PROGRESSION

TERM NUMBER

TERM PROGRESSION

1 10

2 12

3 14

4 16

5 18

SUM = 70

TYPE 1 TO CONTINUE, 0 TO STOP

?

0

*END

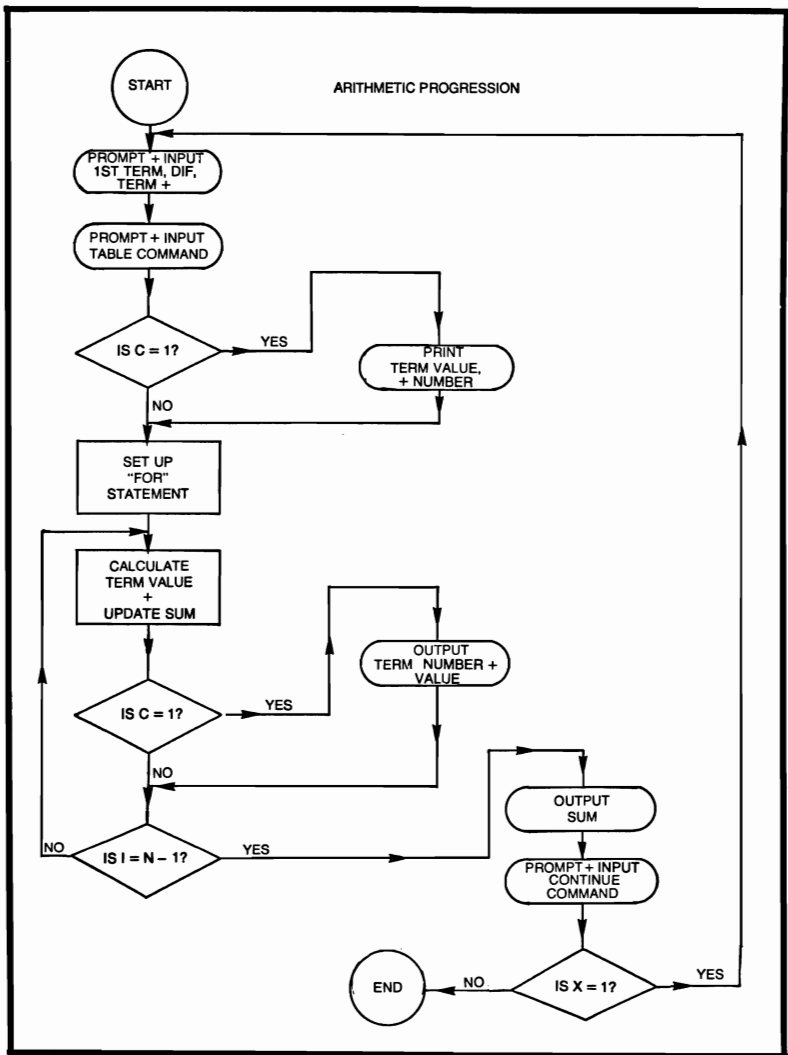

ARITHMETIC PROGRESSION

- 10 REM THIS PROGRAM COMPUTES ARITHMETIC PROGRESSION
- 20 PRINT "FIRST TERM = ";
- 30 INPUT A
- 40 PRINT "COMMON DIFFERENCE = ";
- 50 INPUT D
- 60 PRINT "NUMBER OF TERMS = ";

```
70 INPUT N
80 PRINT "FOR TABLE TYPE 1, IF NOT TYPE 0";
90 INPUT C
100 IF C = 1 THEN 120
110 GOTO 140
120 PRINT "ARITHMETIC PROGRESSION"
130 PRINT "TERM NUMBER", "TERM VALUE"
140 LET J = 0
150 FOR I = 0 TO N - 1
160 LET K = I + 1
170 LET L = A + (I*D)
180 LET J = J + L
190 IF C = 1 THEN 210
200 GOTO 220
210 PRINT K, L
220 NEXT I
230 PRINT "SUM = ";J
240 PRINT
250 PRINT "TYPE 1 TO CONTINUE, 0 TO STOP"
260 INPUT X
270 IF X = 1 THEN 290
280 STOP
290 PRINT
300 GOTO 20
310 END
```

BLACKJACK

Blackjack, or the game of 21, is played against the computer, it being the dealer. Cards are dealt from a self-replenishing deck. Standard rules are as follows:

- Blackjack wins unless the dealer also gets blackjack, in which case there is no winning player.
- The highest score below 21 wins.
- The dealer must draw a card if he is below 17, but must stand if he has 17 or greater.
- Aces count as 11 unless it would force a hand over 21, in which case the ace counts as 1.

EXAMPLE

RUN

IF INSTRUCTIONS ARE REQUIRED TYPE YES

IF NOT TYPE NO

?

NO

GOOD-LUCK-----MAY THE BEST ONE WIN

THE DEALER HAS A 9 SHOWING

YOU HAVE A 5 AND A 11

YOUR TOTAL IS 16

DO YOU WANT A HIT, OR DO YOU STAND

?

HIT

YOUR CARD IS 4

DO YOU WANT A HIT, OR DO YOU STAND

?

STAND

THE DEALER HAS 12

THE DEALER DRAWS A 5

HIS TOTAL IS 17

YOU HAVE 20

YOU HAVE WON!!!

DO YOU WISH TO PLAY AGAIN

TYPE YES OR NO

?

NO

BLACKJACK SAYS GOOD-BYE

*END

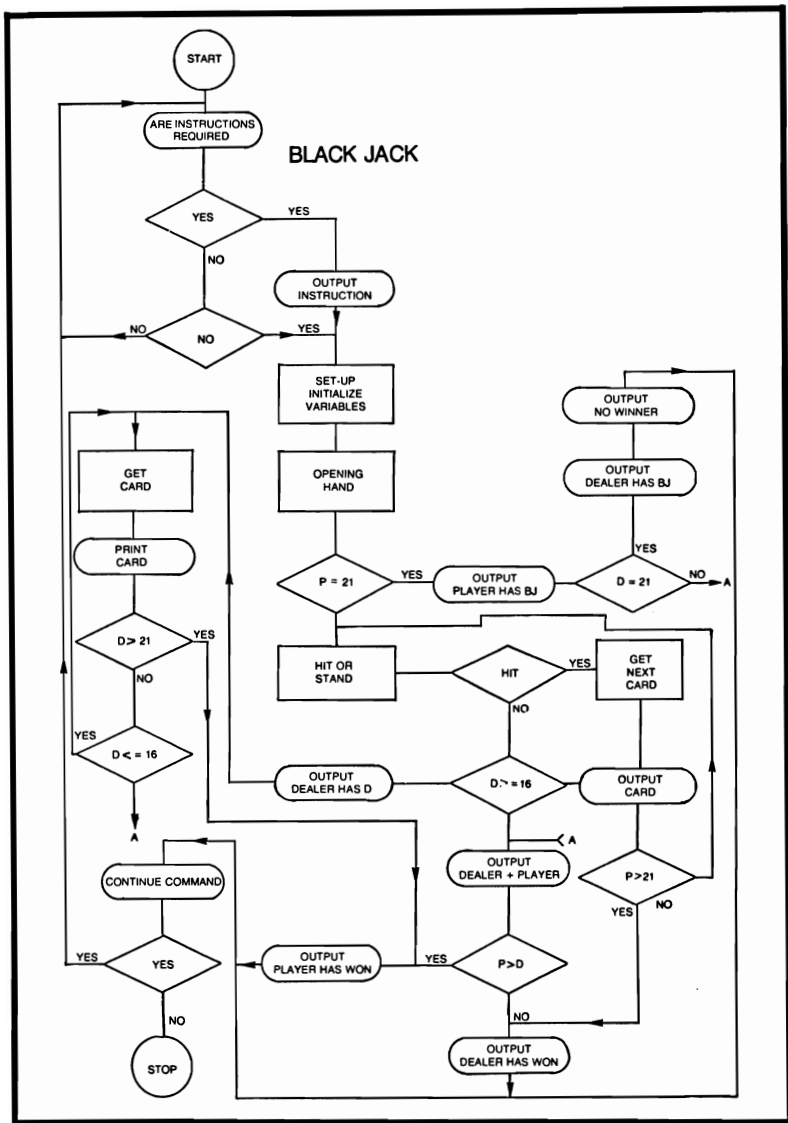

BLACKJACK

```

10  REM BLACKJACK
20  PRINT "IF INSTRUCTIONS ARE REQUIRED TYPE
    YES"
30  PRINT "IF NOT TYPE NO"
40  INPUT C$
50  IF C$ = "YES" THEN 90
  
```



```

60  IF C$ = "NO" THEN 340
70  PRINT "INVALID RESPONSE"
80  GOTO 20
90  PRINT
100 PRINT "*****BLACKJACK*****"
110 PRINT
120 PRINT "THE COMPUTER AS THE DEALER, DEALS
      TWO CARDS TO ITSELF"
130 PRINT "AND TWO CARDS TO THE PLAYER. THE
      PLAYER'S TWO CARDS"
140 PRINT "ARE SHOWN FACE UP, WHILE ONLY ONE OF
      THE DEALER'S"
150 PRINT "CARDS IS SHOWN. BOTH THE DEALER AND
      THE PLAYER"
160 PRINT "MAY DRAW ADDITIONAL CARDS."
170 PRINT "THE PLAYER'S GOAL IS TO REACH 21 OR
      LESS, BUT"
180 PRINT "BE CLOSER TO 21 THAN THE DEALER'S
      HAND."
190 PRINT "IF THE PLAYER'S OR THE DEALER'S HAND
      TOTALS"
200 PRINT "GREATER THAN 21 HE IS BUSTED! THE
      KING"
210 PRINT "THE QUEEN AND THE JACK ALL COUNT AS
      10 POINTS."
220 PRINT "ALL OTHER CARDS EXCEPT THE
      ACE COUNT AS THEIR FACE"
230 PRINT "VALUE SHOWS. THE ACE COUNTS AS 11
      UNLESS THIS"
240 PRINT "WOULD CAUSE THE HAND TO BE OVER 21,
      IN THAT"
250 PRINT "CASE THE ACE COUNTS AS 1."
260 PRINT "IF BOTH THE DEALER AND THE PLAYER
      GET BLACKJACK"
270 PRINT "WHICH IS A TWO CARD HAND TOTALING 21"
280 PRINT "NEITHER WINS, IT IS A PUSH"
290 PRINT "IF THE DEALER'S HAND IS BELOW OR
      EQUAL TO 16"
300 PRINT "HE MUST DRAW, AFTER 17 THE DEALER
      MUST STAND"
310 PRINT "TO RECEIVE A CARD YOU WANT A HIT-"
320 PRINT "TO STOP WHERE YOU ARE, YOU STAND-"
330 PRINT

```

```

340 PRINT"***GOOD-LUCK-----MAY THE BEST ONE
      WIN***"
350 REM 1ST HAND
355 RANDOMIZE
360 LET D = 0
370 LET P = D
380 GOSUB 820
390 LET D1 = C
400 GOSUB 820
410 LET D2 = C
420 GOSUB 890
430 LET P1 = C
440 GOSUB 890
450 LET P2 = C
460 PRINT
470 PRINT "THE DEALER HAS A ";D1;" SHOWING"
480 PRINT "YOU HAVE A ";P1;" AND A ";P2
490 PRINT "YOUR TOTAL IS ";P1 + P2
500 LET D = D1 + D2
510 LET P = P1 + P2
520 IF P = 21 THEN 640
530 GOSUB 960
540 IF L = 1 THEN 690
550 IF D <= 16 THEN 740
560 PRINT "THE DEALER HAS ";D
570 PRINT "YOU HAVE ";P
580 IF P > D THEN 620
590 REM WIN OR LOSS STATEMENTS
600 PRINT "THE DEALER HAS WON!!!"
610 GOTO 1060
620 PRINT "YOU HAVE WON!!!"
630 GOTO 1060
640 PRINT "***YOU HAVE BLACKJACK***"
650 IF D = 21 THEN 670
660 GOTO 560
670 PRINT "THE DEALER ALSO HAS BLACKJACK,
      SORRY NO WINNER"
680 GOTO 1060
690 GOSUB 890
700 PRINT "YOUR CARD IS ";C
710 LET P = P + C
720 IF P > 21 THEN 600
730 GOTO 530

```

```

740 PRINT "THE DEALER HAS ";D
750 GOSUB 820
760 LET D = D + C
770 PRINT "THE DEALER DRAWS A ";C
780 PRINT "HIS TOTAL IS ";D
790 IF D > 21 THEN 620
800 IF D <= 16 THEN 750
810 GOTO 560
820 LET C = 1 + INT(11*RND)
830 IF C = 11 THEN 850
840 GOTO 880
850 IF D + C > 21 THEN 870
860 GOTO 880
870 LET C = 1
880 RETURN
890 LET C = 1 + INT(11*RND)
900 IF C = 11 THEN 920
910 GOTO 950
920 IF P + C > 21 THEN 940
930 GOTO 950
940 LET C = 1
950 RETURN
960 PRINT "DO YOU WANT A HIT, OR DO YOU STAND"
970 INPUT Q$
980 IF Q$ = "HIT" THEN 1020
990 IF Q$ = "STAND" THEN 1040
1000 PRINT "INVALID RESPONSE"
1010 GOTO 960
1020 LET L = 1
1030 GOTO 1050
1040 LET L = 0
1050 RETURN
1060 PRINT
1070 PRINT "DO YOU WISH TO PLAY AGAIN"
1080 PRINT "TYPE YES OR NO"
1090 INPUT L$
1100 IF L$ = "YES" THEN 1130
1110 PRINT "BLACKJACK SAYS GOOD-BYE"
1120 STOP
1130 PRINT
1140 GOTO 20
1150 END

```

BUBBLE SORT

This program is actually a subroutine rather than a stand-alone program. It is intended to be used in conjunction with larger programs which require that data be placed in an array in ascending sequence.

BUBBLE SORT

```
10  REM THIS PROGRAM IS A BUBBLE SORT, WHICH
    PLACES THE
20  REM VALUES IN AN ARRAY IN ASCENDING SE-
    QUENCE
30  REM IT IS INTENDED TO BE AN EXAMPLE AND
    NOT A
40  REM SPECIFIC CASE.
50  REM THIS PROGRAM MAY BE CONVERTED INTO A
    SUBROUTINE
60  REM FOR USE IN A LARGER PROGRAM
70  REM THE ARRAY IS Z OF LENGTH N
80  REM Z IS ASSUMED TO HAVE BEEN DECLARED IN A
    DIM
90  REM STATEMENT AND N SET AHEAD OF TIME
100 LET I = N - 1
110 FOR J = 1 TO I
120 LET K = J + 1
130 FOR L = N TO K STEP - 1
140 IF Z(L) > Z(J) THEN 210
150 REM SAVE FIRST VALUE
160 LET T = Z(L)
170 LET Z(L) = Z(J)
180 LET Z(J) = T
190 REM IF Z IS THE KEY FOR SORTING MULTIPLE
200 REM ARRAYS AND EXTRA CODE HERE
210 NEXT L
220 NEXT J
230 RETURN
```

CHI-SQUARE EVALUATION

This program computes the chi-square evaluation from the inputted observed and expected frequencies. To terminate the evaluation the use simply inputs a 0 for the last expected frequency.

FORMULA

$$X^2 = \sum_{i=1}^N \frac{(O_i - E_i)^2}{E_i}$$

EXAMPLE

OBSERVED FREQUENCIES =

?

10

EXPECTED FREQUENCIES =

?

10

OBSERVED FREQUENCIES =

?

0

OBSERVED FREQUENCIES =

?

0

CHI-SQUARE = 0

TYPE 1 TO CONTINUE, 0 TO STOP

?

0

*END

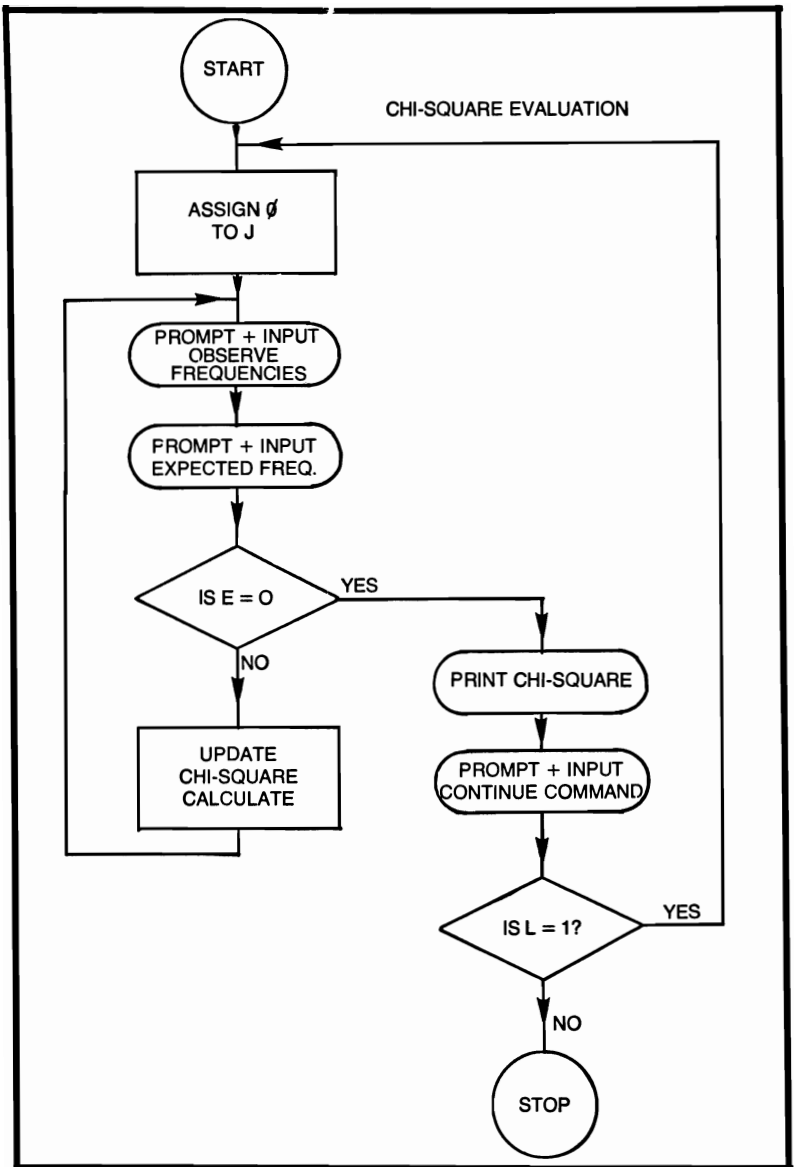

CHI-SQUARE EVALUATION

```

10  REM THIS PROGRAM COMPUTES CHI-SQUARE
20  REM EVALUATION ON THE OBSERVED TO
30  REM EXPECTED FREQUENCIES
40  LET J = 0
  
```

```
50 PRINT "OBSERVED FREQUENCIES = "  
60 INPUT D  
70 PRINT "EXPECTED FREQUENCIES = "  
80 INPUT E  
90 IF E = 0 THEN 130  
100 LET K = ((D - E)2)/E  
110 LET J = J + K  
120 GOTO 50  
130 PRINT "CHI-SQUARE = ";J  
140 PRINT "*****"  
150 PRINT "TYPE 1 TO CONTINUE, 0 TO STOP"  
160 INPUT L  
170 IF L = 1 THEN 190  
180 STOP  
190 PRINT  
200 GOTO 40  
210 END
```

CIRCLE DETERMINED BY THREE POINTS

The user inputs three noncolinear points, and the program responds with the center and the radius of the circle thus generated.

FORMULAE

$$y_0 = \frac{K_2 - K_1}{N_2 - N_1} \quad X_0 = K_2 - N_2 Y_0$$

$$r = (X_3 - X_0)^2 + (Y_3 - Y_0)^2$$

$$K_1 = \frac{(X_2 - X_1)(X_2 + X_1) + (Y_2 - Y_1)(Y_2 + Y_1)}{2(X_2 - X_1)}$$

$$K_2 = \frac{(X_3 - X_1)(X_3 + X_1) + (Y_3 - Y_1)(Y_3 + Y_1)}{2(X_3 - X_1)}$$

$$N_1 = \frac{Y_2 - Y_1}{X_2 - X_1} \quad N_2 = \frac{Y_3 - Y_1}{X_3 - X_1}$$

EXAMPLES

INPUT X1,Y1

?

2,3

INPUT X2,Y2

?

5,4

INPUT X3,Y3

?

6,4.5

CENTER X0,Y0 = - 1.25,17.25

RADIUS = 15.10

TO CONTINUE TYPE 1, IF NOT TYPE 0

?

0

*END

CIRCLE DETERMINED BY THREE POINTS

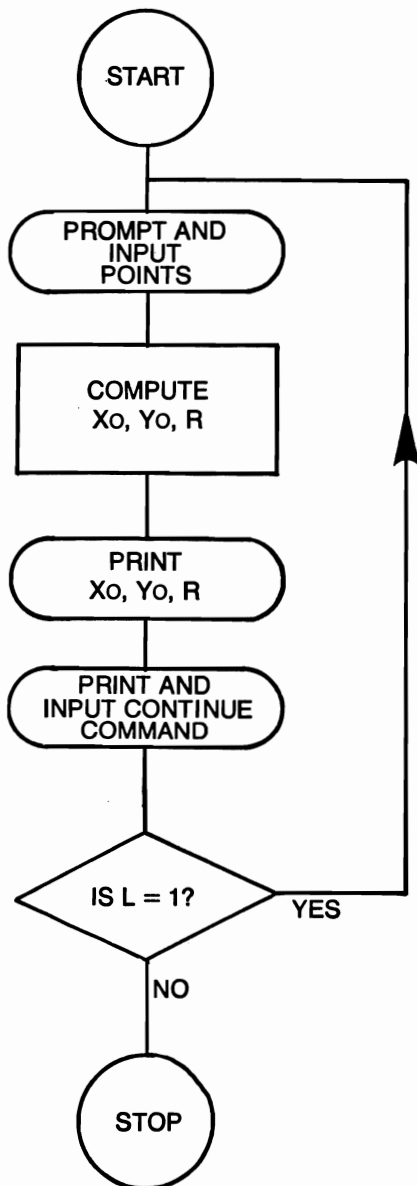

CIRCLE DETERMINED BY THREE POINTS

```
10  REM THIS PROGRAM COMPUTES THE CENTER
    AND RADIUS
20  REM OF A CIRCLE FROM 3 NON-COLINEAR POINTS
30  PRINT "INPUT X1,Y1";
40  INPUT X1, Y1
50  PRINT "INPUT X2,Y2";
60  INPUT X2,Y2
70  PRINT "INPUT X3,Y3";
80  INPUT X3,Y3
90  LET A = (Y2 - Y1)/(X2 - X1)
100 LET B = (Y3 - Y1)/(X3 - X1)
110 LET C = ((X2 - X1)*(X2 + X1))*
    + ((Y2 - Y1)*(Y2 + Y1))
120 LET D = C/(2*(X2 - X1))
130 LET E = ((X3 - X1)*(X3 + X1)) + ((Y3 - Y1)*
    (Y3 + Y1))
140 LET F = E/(2*(X3 - X1))
150 LET Y0 = (F - D)/(B - A)
160 LET X0 = F - (B*Y0)
170 LET R = SQR((X3 - X0)2 + (Y3 - Y0)2)
180 PRINT "CENTER X0,Y0 = ";X0;",";Y0
190 PRINT "RADIUS = ";R
200 PRINT
210 PRINT "TO CONTINUE TYPE 1, IF NOT TYPE 0"
220 INPUT L
230 IF L = 1 THEN 250
240 STOP
250 PRINT
260 GOTO 30
270 END
```

CIRCULAR SECTIONS

This program computes the various parameters: moment of inertia, polar moment of inertia and area connected within a circular section.

FORMULAE

CIRCULAR SECTION

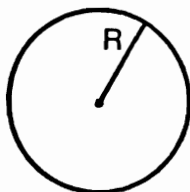

$$I = \frac{\pi D^4}{64}$$

$$A = \frac{\pi D^2}{4}$$

$$J = \frac{\pi D^4}{32}$$

where I & J are in in⁴ and A = in²

EXAMPLE

RADIUS

?

5

MOMENT OF INERTIA = 490.873

POLAR MOMENT OF INTERTIA = 981.746

AREA OF SECTION = 78.5397

TYPE 1 TO CONTINUE, 0 TO STOP

?

0

*END

CIRCULAR SECTIONS

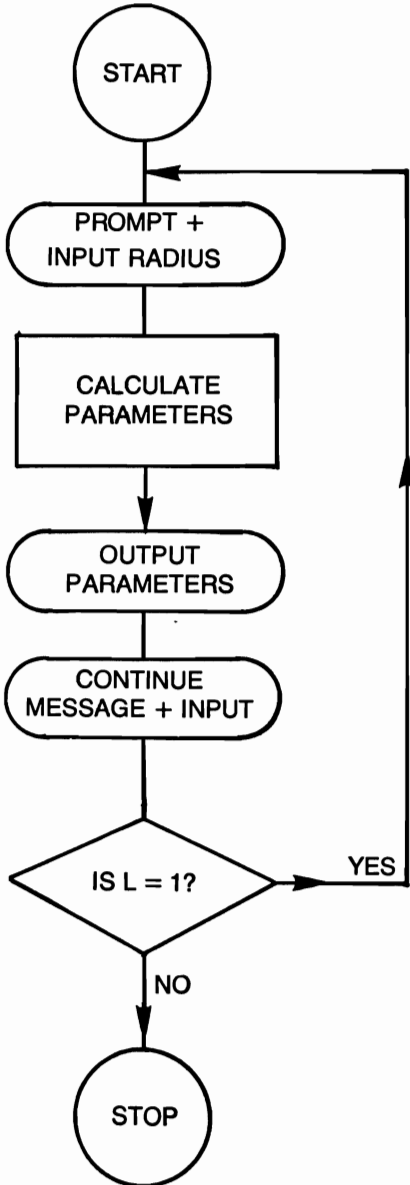

CIRCULAR SECTION

```
10  REM THIS PROGRAM COMPUTES THE PARA-
    METERS
20  REM CONNECTED WITH A CIRCULAR SECTION
30  PRINT "RADIUS"
40  INPUT R
50  LET P = 3.14159
60  LET D = 2*R
70  LET I = (P*(D↑4))/64
80  LET J = I*2
90  LET A = (P*(D↑2))/4
100 PRINT "MOMENT OF INERTIA = ";I
110 PRINT "POLAR MOMENT OF INERTIA = ";J
120 PRINT "AREA OF SECTION = ";A
130 PRINT "*****"
140 PRINT "TYPE 1 TO CONTINUE, 0 TO STOP"
150 INPUT L
160 IF L = 1 THEN 180
170 STOP
180 PRINT
190 GOTO 30
200 END
```

COMPOUNDED AMOUNTS

This program applies to an amount of principle placed into an account and compounded periodically, with no further deposits.

FORMULAE

$$X = Y(1 + I)^N \qquad N = \frac{\ln(X/Y)}{\ln(1 + I)}$$

$$Y = X(1 + I)^{-N} \qquad L = Y((1 + I)^N - 1)$$

where N = number of Time periods

I = interest rate (decimal) L = interest

Y = present value

X = future value

EXAMPLE

FUTURE VALUE(1)

PRESENT VALUE (2)

INTEREST (3)

PERIODIC INTEREST RATE (4)

NUMBER OF TIME PERIODS (5)

ENTER 1 TO 5

?

1

PRESENT VALUE =

?

100

INTEREST RATE =

?

10

NUMBER OF TIME PERIODS =

?

4

FUTURE VALUE = 146.41

TYPE 1 TO CONTINUE, 0 TO STOP

?

1

ENTER 1 TO 5

?

2

FUTURE VALUE =
?
200
INTEREST RATE =
?
.1
NUMBER OF TIME PERIODS =
?
5
PRESENT VALUE =124.18
TYPE 1 TO CONTINUE, 0 TO STOP
?
1
ENTER 1 TO 5
?
3
PRESENT VALUE =
?
300
INTEREST RATE =
?
.2
NUMBER OF TIME PERIODS =
?
6
INTEREST =595.80
TYPE 1 TO CONTINUE, 0 TO STOP
?
1
ENTER 1 TO 5
?
4
PRESENT VALUE =
?
100
FUTURE VALUE =
?
200
NUMBER OF TIME PERIODS =
?
5
INTEREST RATE = .15

TYPE 1 TO CONTINUE, 0 TO STOP
 ?
 1
 ENTER 1 TO 5
 ?
 5
 FUTURE VALUE =
 ?
 500
 PRESENT VALUE =
 ?
 250
 INTEREST RATE =
 ?
 .2
 NUMBER OF TIME PERIODS =3.8
 TYPE 1 TO CONTINUE, 0 TO STOP
 ?
 0
 *END

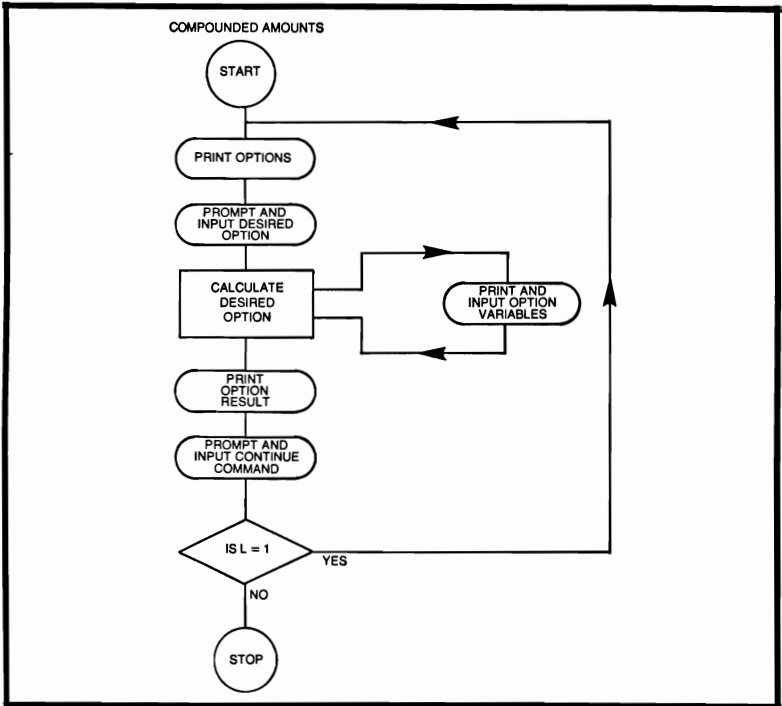

COMPOUNDED AMOUNTS

```
10  REM COMPOUNDED AMOUNTS
20  PRINT "FUTURE VALUE (1)"
30  PRINT "PRESENT VALUE (2)"
40  PRINT "INTEREST (3)"
50  PRINT "PERIODIC INTEREST RATE (4)"
60  PRINT "NUMBER OF TIME PERIODS (5)"
70  PRINT "ENTER 1 TO 5";
80  INPUT A
90  ON A GOTO 100,160,220,280,340
100 GOSUB 410
110 GOSUB 440
120 GOSUB 470
130 LET X = Y*((1 +D)↑N)
140 PRINT "FUTURE VALUE = ";X
150 GOTO 390
160 GOSUB 500
170 GOSUB 440
180 GOSUB 470
190 LET Y = X*((1 +D)↑N)
200 PRINT "PRESENT VALUE = ";Y
210 GOTO 390
220 GOSUB 410
230 GOSUB 440
240 GOSUB 470
250 LET L = Y*((1 +I)↑N) - 1)
260 PRINT "INTEREST = ";L
270 GOTO 390
280 GOSUB 410
290 GOSUB 500
300 GOSUB 470
310 LET I = ((X/Y)↑(1/N)) - 1
320 PRINT "INTEREST RATE = ";I
330 GOTO 390
340 GOSUB 500
350 GOSUB 410
360 GOSUB 440
370 LET N = (LOG(X/Y))/(LOG(1 + D))
380 PRINT "NUMBER OF TIME PERIODS = ";N
390 PRINT
400 PRINT "TYPE 1 TO CONTINUE, 0 TO STOP"
401 INPUT L
```

```
402 IF L = 1 THEN 404
403 STOP
404 PRINT
405 GOTO 70
410 PRINT "PRESENT VALUE = ";
420 INPUT Y
430 RETURN
440 PRINT "INTEREST RATE = ";
450 INPUT I
460 RETURN
470 PRINT "NUMBER OF TIME PERIODS = ";
480 INPUT N
490 RETURN
500 PRINT "FUTURE VALUE = ";
510 INPUT X
520 RETURN
530 END
```

COORDINATE TRANSLATION AND/OR ROTATION

This program will compute rectangular-coordinate translation and/or rotation. The origin is translated from (0,0) to a new point (X,Y) and the X,Y axes are rotated to an angle A to give new axes X',Y'.

FORMULAE

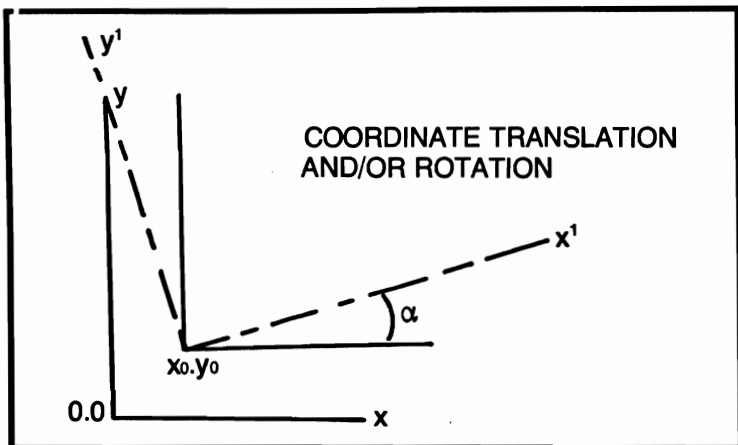

$$X' = (X - X_0)\cos \alpha + (Y - Y_0)\sin \alpha$$

$$Y' = -(X - X_0)\sin \alpha + (Y - Y_0)\cos \alpha$$

EXAMPLES

ANGLE OF ROTATION IN DEGREES=

?

45

COORDINATES OF NEW ORIGIN (X0,Y0)=

?

5,6

OLD COORDINATES OF DATA POINT (X1, Y1)=

?

8,9

SPECIFIED ROTATION = 45

NEW COORDINATES OF DATA POINT

X2 = 4.24

Y2 = 0

TYPE 1 TO CONTINUE, 0 TO STOP

?

0

*END

COORDINATE TRANSLATION AND/OR ROTATION

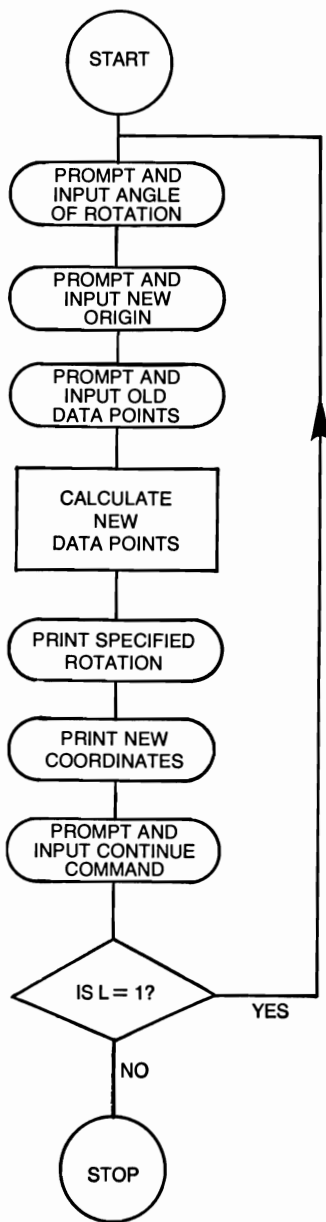

COORDINATE TRANSLATION AND/OR ROTATION

```
10  REM THIS PROGRAM COMPUTES RECTANGULAP  
    COORDINATE  
20  REM TRANSLATION AND/OR ROTATION  
30  PRINT "ANGLE OF ROTATION IN DEGREES = ";  
40  INPUT A  
50  LET B = (A*3.14159)/180  
60  PRINT "COORDINATES OF NEW ORIGIN (X0,Y0) =";  
70  INPUT X,Y  
80  PRINT "OLD COORDINATES OF DATA POINT (X1,Y1)  
    =";  
90  INPUT F,C  
100 LET Z = F - X  
110 LET W = C - Y  
120 LET D = (Z*COS(B)) + (W*SIN(B))  
130 LET E = - (Z*SIN(B)) + (W*COS(B))  
140 PRINT  
150 PRINT "SPECIFIED ROTATION =";A  
160 PRINT "NEW COORDINATES OF DATA POINT"  
170 PRINT "X2 = ";D  
180 PRINT "Y2 = ";E  
190 PRINT  
200 PRINT "TYPE 1 TO CONTINUE, 0 TO STOP"  
210 INPUT L  
220 IF L = 1 THEN 240  
230 STOP  
240 PRINT  
250 GOTO 30  
260 END
```

CRAPS

The following game-simulation is that of craps. Craps is a game that is played with two dice. The object of the game is to either win by throwing a 7 or an 11 on the first throw, or by matching your throw on the following throws. If on the first throw a 2, 3, or a 12 comes up you lose automatically; also, if you throw a 7 when looking for a match you lose too.

EXAMPLE

RUN

FOR RULES, TYPE RULES, OTHERWISE TYPE GO

?

GO

6

8

4

YOU THROW A 6 YOU WIN BY MATCHING

TO CONTINUE TYPE Y, IF NOT TYPE N

?

Y

FOR RULES, TYPE RULES, OTHERWISE TYPE GO

?

GO

YOU THROW A 7 YOU WIN

TO CONTINUE TYPE Y, IF NOT TYPE N

N

*END

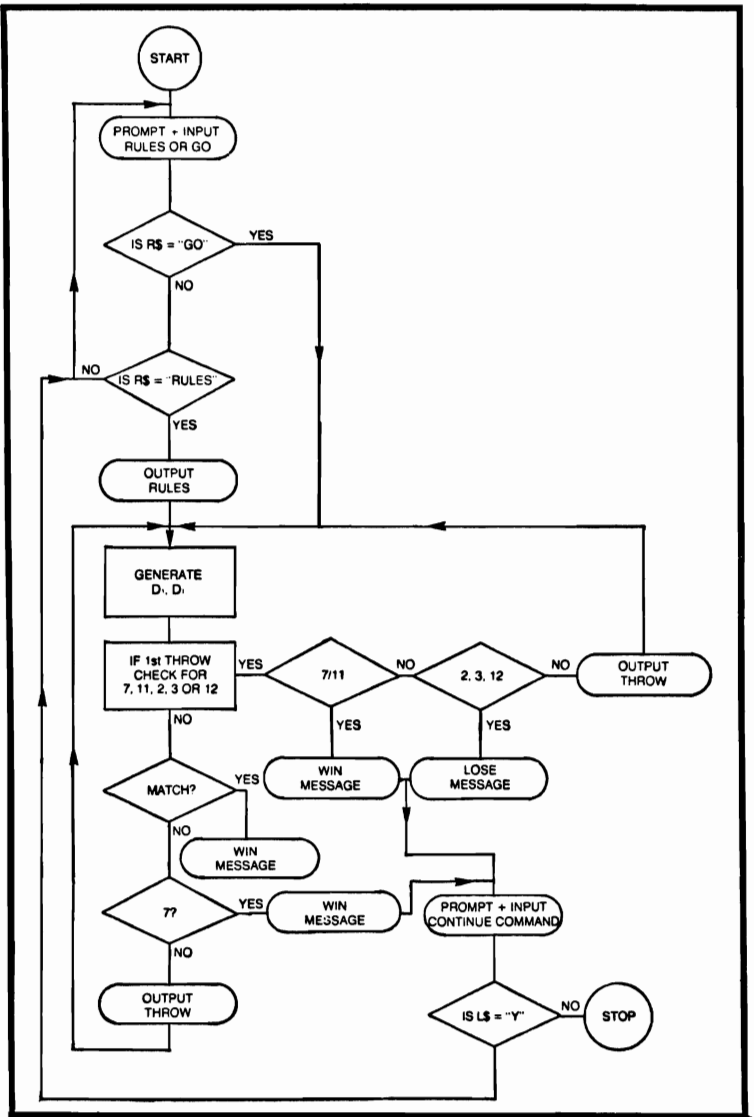

CRAPS

- 10 REM THIS PROGRAM SIMULATES THE GAME OF
CRAPS
- 20 RANDOMIZE
- 30 PRINT " FOR RULES, TYPE RULES, OTHERWISE
TYPE GO"
- 40 INPUT R\$

```

50  IF R$ = "RULES" THEN 90
60  IF R$ = "GO" THEN 140
70  PRINT "INVALID COMMAND"
80  GOTO 30
90  PRINT "A 7 OR 11 ON THE FIRST THROW WINS"
100 PRINT "YOU CAN ALSO WIN BY THROWING A
    4,5,6,8,9,10"
110 PRINT " AND MATCHING IT BEFORE THROWING A
    7. IF ON"
120 PRINT "THE FIRST THROW A 2,3 OR A 12 COMES UP"
130 PRINT "YOU LOSE AUTOMATICALLY"
140 LET J = 0
150 GOSUB 460
160 LET D1 =N
170 GOSUB 460
180 LET D2 = N
190 LET D3 = D1 + D2
200 LET J = J + 1
210 IF J = 1 THEN 260
220 IF D3 = D4 THEN 420
230 IF D3 = 7 THEN 440
240 PRINT "YOU THROW A ";D3
250 GOTO 150
260 IF D3 = 7 THEN 320
270 IF D3 = 2 THEN 340
280 IF D3 = 3 THEN 340
290 IF D3 = 12 THEN 340
300 IF D3 = 11 THEN 320
310 LET D4 = D3
315 GOTO 240
320 PRINT "YOU THROW A ";D3;" YOU WIN"
330 GOTO 350
340 PRINT "YOU THROW A ";D3;" YOU LOSE"
350 PRINT
360 PRINT "TO CONTINUE TYPE Y, IF NOT TYPE N"
370 INPUT L$
380 IF L$ = "Y" THEN 400
390 STOP
400 PRINT
410 GOTO 30
420 PRINT "YOU THROW A ";D3;" YOU WIN BY MATCH-
    ING"
430 GOTO 350

```



```
440 PRINT "YOU THROW A ";D3;" SORRY YOU LOSE"  
450 GOTO 350  
460 LET N = 1 + INT(6*RND)  
470 RETURN  
480 END
```

CURVE TABLES (PLOTING)

This program generates a series of data points, with which the user can plot curves. The data points generated lie between the values given for the starting value and the end point of X. Step size may be changed by using a step statement in conjunction with the FOR statement. The user must supply the equation of the curve in line 140.

EXAMPLE

(ASSUMING THE EQUATION IS $(2 * X) + 6$)

STARTING VALUE OF X =

?

5

END VALUE OF X =

?

10

TABLE

X	Y
---	---

5	16
---	----

6	18
---	----

7	20
---	----

8	22
---	----

9	24
---	----

10	26
----	----

TYPE 1 TO CONTINUE,0 TO STOP

?

0

*END

CURVE TABLES

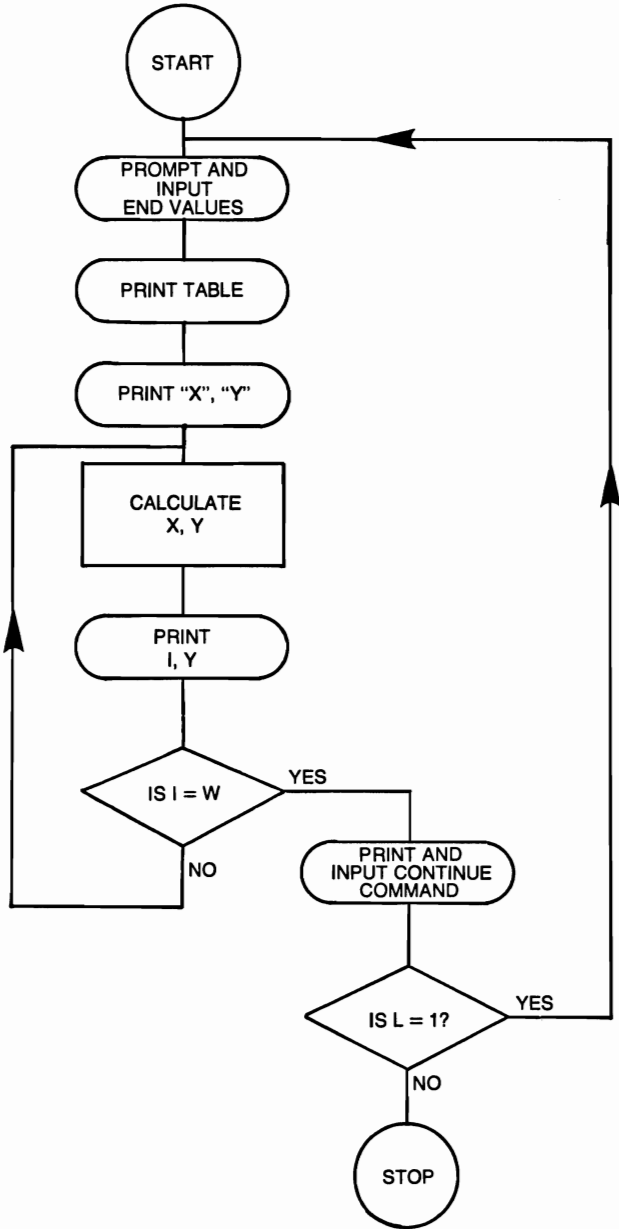

CURVE TABLES

```
10  REM THIS PROGRAM GENERATES A SERIES OF
20  REM DATA POINTS, WITH WHICH THE USER CAN
30  REM PLOT CURVES. THE DATA POINTS GENER-
    REMATED
40  REM LIE BETWEEN THE VALUES GIVEN FOR X
50  REM IF A STEP SIZE OTHER THAN 1 IS DERIVED
60  REM USE A STEP STATEMENT WITH THE FOR
    REM STATEMENTS
70  PRINT "STARTING VALUE OF X = ";
80  INPUT X
90  PRINT "END VALUE OF X = ";
100 INPUT W
110 PRINT "TABLE"
120 PRINT "X", "Y"
130 FOR I = X TO W
140 LET Y =
150 PRINT I, Y
160 NEXT I
170 PRINT
180 PRINT "TYPE 1 TO CONTINUE, 0 TO STOP"
190 INPUT L
200 IF L = 1 THEN 220
210 STOP
220 PRINT
230 GOTO 70
240 END
```

DAY OF THE WEEK

This computer program computes the day of the week (e.g., Monday) from the date entered. The date entered must not be prior 1753, this is due to changes involving the switch-over from the Julian to the Gregorian Calendar.

EXAMPLE

RUN

ENTER DAY(D), MONTH(M) AND YEAR(Y)

?

16,02,1977

THE DAY OF THE WEEK IS WEDNESDAY

FOR NEXT DATE IN YES, IF NOT

TYPE NO

?

NO

DAY OF THE WEEK SAYS GOOD-BYE

*END

DAYS OF THE WEEK

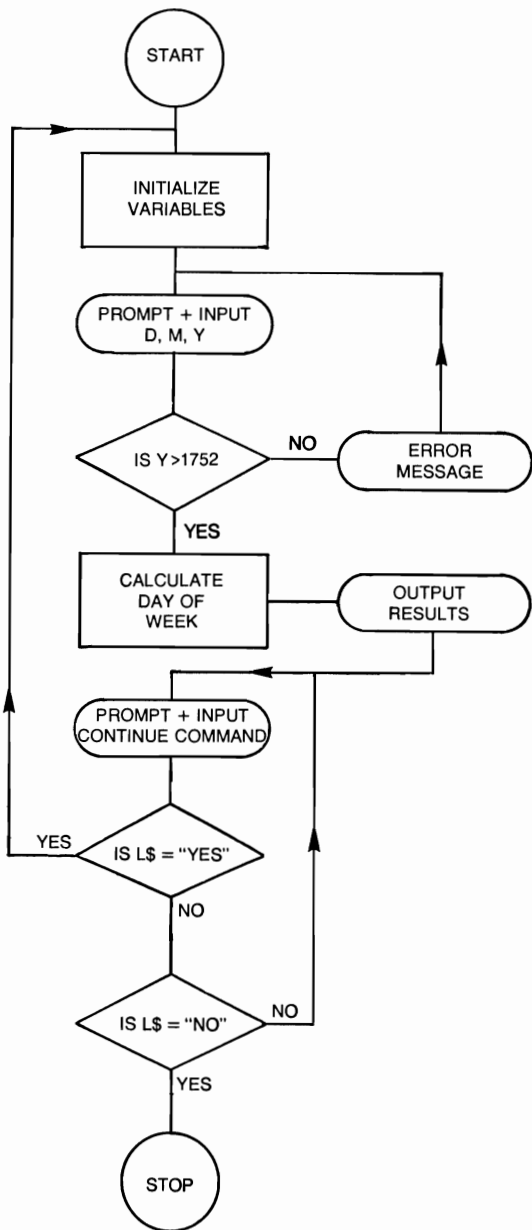

DAY OF THE WEEK

```
10  REM THIS PROGRAM COMPUTES THE DAY OF THE
    WEEK
20  REM RESTRICTION: THE DATE MUST BE AFTER
    1752
30  LET J$(1) = "SUNDAY"
40  LET J$(2) = "MONDAY"
50  LET J$(3) = "TUESDAY"
60  LET J$(4) = "WEDNESDAY"
70  LET J$(5) = "THURSDAY"
80  LET J$(6) = "FRIDAY"
90  LET J$(7) = "SATURDAY"
100 PRINT "ENTER DAY(D), MONTH(M) and YEAR(Y)"
110 INPUT D,M,Y
120 IF Y > 1752 THEN 150
130 PRINT "YEAR MUST NOT BE PRIOR TO 1753"
140 GOTO 100
150 LET K = INT(0.6 + (1/M))
160 LET L = Y - K
170 LET O = M + 12*K
180 LET P = L/100
190 LET Z1 = INT(P/4)
200 LET Z2 = INT(P)
210 LET Z3 = INT((5*L)/4)
220 LET Z4 = INT (13*(O + 1)/5)
230 LET Z = Z4 + Z3 - Z2 + Z1 + D - 1
240 LET Z=Z - (7*INT(Z/7)) + 1
250 PRINT "THE DAY OF THE WEEK IS "; J$(Z)
260 PRINT
270 PRINT "FOR NEXT DATE TYPE IN YES, IF NOT"
280 PRINT "TYPE NO"
290 INPUT L$
300 IF L$ = "YES" THEN 340
310 IF L$ = "NO" THEN 360
320 PRINT "INVALID COMMAND"
330 GOTO 270
340 PRINT
350 GOTO 30
360 PRINT "DAY OF THE WEEK SAYS GOOD-BYE"
370 END
```

DETERMINANT AND INVERSE OF A 2×2 MATRIX

The computer computes the inverse and determinant of a 2×2 matrix supplied by the user.

EXAMPLE

ENTER A11,A12

?

5,3

ENTER A21,A22

?

2,1

ORIGINAL MATRIX

5 3

2 1

INVERSE OF MATRIX

- 1 4

2 - 5

DETERMINANT = - 1

TYPE 1 TO CONTINUE, 0 TO STOP

?

0

*END

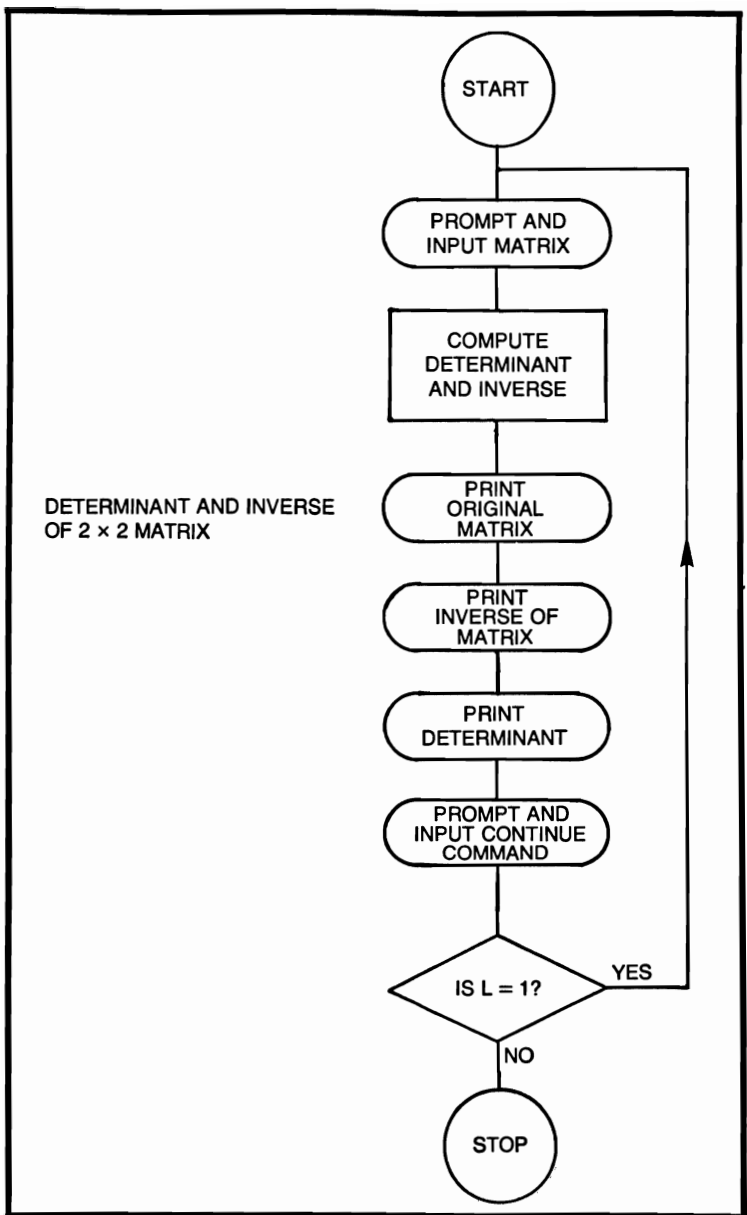

DETERMINANT AND INVERSE OF 2 × 2 MATRIX

- 10 REM THIS PROGRAM COMPUTES THE DETERMINANT AND
- 20 REM INVERSE OF A 2 × 2 MATRIX

```
30 PRINT "ENTER A11, A12";
40 INPUT A,B
50 PRINT "A21, A22";
60 INPUT C,D
70 LET E = (D*A) - (B*C)
80 LET F = D/E
90 LET G = - B/E
100 LET H = - C/E
110 LET I = A/E
120 PRINT "ORIGINAL MATRIX"
130 PRINT A,B
140 PRINT C,D
150 PRINT
160 PRINT "INVERSE OF MATRIX"
170 PRINT F,G
180 PRINT H,I
190 PRINT
200 PRINT "DETERMINANT = ";E
210 PRINT
220 PRINT "TYPE 1 TO CONTINUE, 0 TO STOP"
230 INPUT L
240 IF L = 1 THEN 30
250 STOP
260 PRINT
270 GOTO 30
280 END
```

DETERMINATE INVERSE OF A 3 × 3 MATRIX

The user inputs his original matrix, and the computer responds with the determinate and the inverse.

FORMULAE

$$\text{MATRIX} = \begin{pmatrix} A_1 & B_1 & C_1 \\ A_2 & B_2 & C_2 \\ A_3 & B_3 & C_3 \end{pmatrix} \quad \text{DET A} = A_1B_2C_3 + B_1C_2A_3 + C_1B_3A_2 - C_1B_2A_3 - C_2B_3A_1 - C_3A_2B_1$$

$$\text{INVERSE OF MATRIX A} = \begin{pmatrix} \alpha_1 & \beta_1 & \gamma_1 \\ \alpha_2 & \beta_2 & \gamma_2 \\ \alpha_3 & \beta_3 & \gamma_3 \end{pmatrix}$$

$$\alpha_1 = (B_2C_3 - B_3C_2)/\text{DET A}$$

$$\alpha_2 = (A_3C_2 - A_2C_3)/\text{DET A}$$

$$\alpha_3 = (A_2B_3 - A_3B_2)/\text{DET A}$$

$$\beta_1 = (B_3C_1 - B_1C_3)/\text{DET A}$$

$$\beta_2 = (A_1C_3 - A_3C_1)/\text{DET A}$$

$$\beta_3 = (A_3B_1 - A_1B_3)/\text{DET A}$$

$$\gamma_1 = (B_1C_2 - B_2C_1)/\text{DET A}$$

$$\gamma_2 = (A_2C_1 - A_1C_2)/\text{DET A}$$

$$\gamma_3 = (A_1B_2 - A_2B_1)/\text{DET A}$$

EXAMPLE

ENTER 3X3 MATRIX

?

1,4,2,2,4,2,3,5,1

ORIGINAL MATRIX

1 4 2

2 4 2

3 5 1

DETERMINANT = 6

INVERSE OF MATRIX

- 1 1 0

.67 - .83 .33

- .33 1.17 - .67

TYPE 1 TO CONTINUE, 0 TO STOP

?

0

*END

DETERMINANT AND INVERSE OF 3×3 M

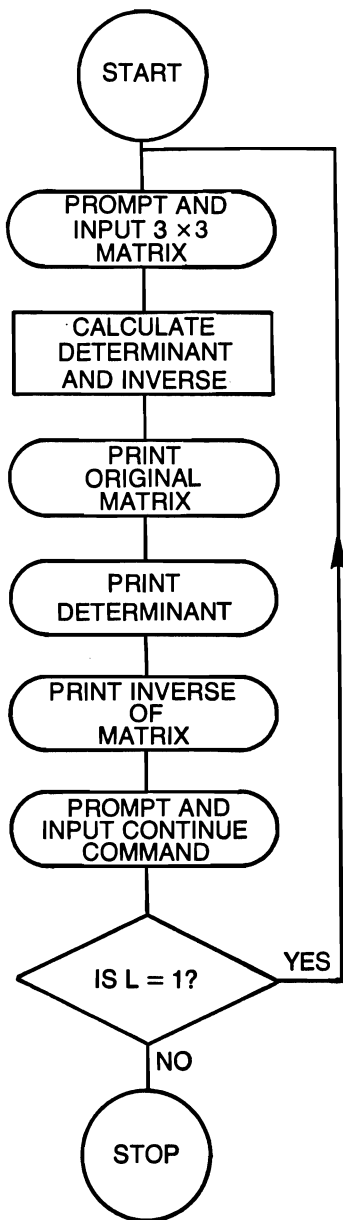

DETERMINANT AND INVERSE OF 3×3 MATRIX

```
10  REM THIS PROGRAM COMPUTES  $3 \times 3$  MATRIX
    OPERATIONS
20  PRINT "ENTER  $3 \times 3$  MATRIX"
30  INPUT A,B,C,D,E,F,G,H,I
40  REM COMPUTE DETERMINANT OF  $3 \times 3$ 
50  LET M = (A*E*I) + (B*F*G) + (C*H*D)
60  LET N = M - (C*E*G) - (F*H*A) - (I*D*B)
70  REM COMPUTE INVERSE
80  LET O = ((E*I) - (H*F))/N
90  LET P = ((G*F) - (D*I))/N
100 LET Q = ((D*H) - (G*E))/N
110 LET R = ((H*C) - (B*I))/N
120 LET S = ((A*I) - (G*C))/N
130 LET T = ((G*B) - (A*H))/N
140 LET U = ((B*F) - (E*C))/N
150 LET V = ((D*C) - (A*F))/N
160 LET W = ((A*E) - (D*B))/N
170 PRINT "ORIGINAL MATRIX"
180 PRINT A,B,C
190 PRINT D,E,F
200 PRINT G,H,I
210 PRINT
220 PRINT "DETERMINANT = ";N
230 PRINT
240 PRINT "INVERSE OF MATRIX"
250 PRINT O,R,U
260 PRINT P,S,V
270 PRINT Q,T,W
280 PRINT
290 PRINT "TYPE 1 TO CONTINUE, 0 TO STOP"
300 INPUT L
310 IF L = 1 THEN 20
320 STOP
330 END
```

FACTORIALS

This program computes by iterative multiplication of the factorial of X.

FORMULA

$$X(X - 1)(X - 2)\dots (X - X + 1)$$

EXAMPLE

X =

?

5

X = 5 X! = 120

TYPE 1 TO CONTINUE, 0 TO STOP

?

1

X =

?

7

X = 7 X! = 5040

TYPE 1 TO CONTINUE, 0 TO STOP

?

1

X =

?

18

X = 18 X! = 6.40237E15

TYPE 1 TO CONTINUE, 0 TO STOP

?

0

*END

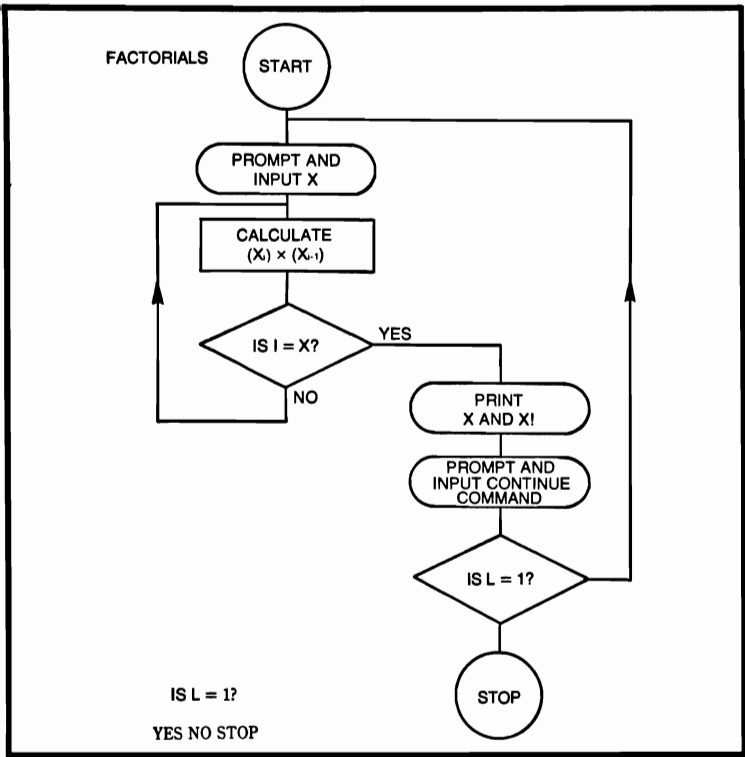

FACTORIALS

```

10  REM THIS PROGRAM COMPUTES THE FACTORIALS
    OF X
20  REM BY ITERATIVE MULTIPLICATIONS
30  PRINT "X = ";
40  INPUT X
50  LET Z = 1
60  FOR I = 1 TO X
70  LET Z = Z*I
80  NEXT I
90  PRINT "X = ";X,"X! = ";Z
100 PRINT "TYPE 1 TO CONTINUE, 0 TO STOP"
110 INPUT L
120 IF L = 1 THEN 140
130 STOP
140 PRINT
150 GOTO 30
160 END
  
```

FIBONACCI NUMBERS

This program computes a table of Fibonacci numbers from the first two terms entered by the user, who may also specify the maximum number of terms.

FORMULA

$F_i = i^{\text{th}}$ term in the sequence;

For any two terms the

first term = $f_i - 2$,

second term = $f_i - 1$

$$f_i = f_{i-1} + f_{i-2}$$

EXAMPLE

ENTER 1ST TERM

?

1

ENTER 2ND TERM

?

1

MAXIMUM NUMBER OF TERMS =

?

10

TABLE OF FIBONACCI NUMBERS

TERM NO.

FIBONACCI NUMBERS

1

1

2

1

3

2

4

3

5

5

6

8

7

13

8

21

9

34

10

55

MAXIMUM NUMBER OF TERMS REACHED

TYPE 1 TO CONTINUE, 0 TO STOP

?

1

ENTER FIRST TERM

?

27

ENTER SECOND TERM

?

963

MAXIMUM NUMBER OF TERMS =

?

5

TABLE OF FIBONACCI NUMBERS

TERM NO.	FIBONACCI NUMBERS
1	27
2	963
3	990
4	1953
5	2943

MAXIMUM NUMBER OF TERMS REACHED

TYPE 1 TO CONTINUE, 0 TO STOP

?

0

*END

FIBONACCI NUMBERS

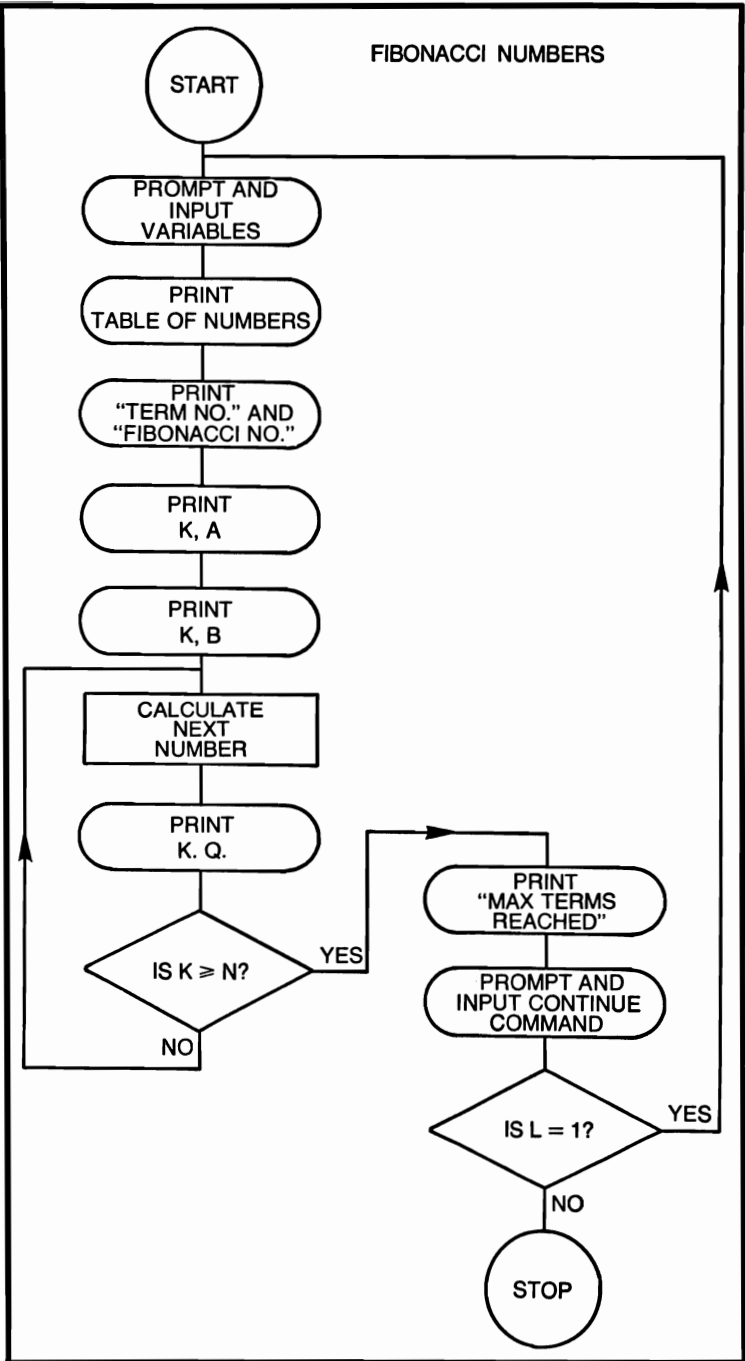

FIBONACCI NUMBERS

```
10  REM THIS PROGRAM COMPUTES A TABLE OF
    FIBONACCI NUMBERS
20  PRINT "ENTER FIRST TERM"
30  INPUT A
40  PRINT "ENTER SECOND TERM"
50  INPUT B
60  PRINT "MAXIMUM NUMBER OF TERMS = "
70  INPUT N
80  PRINT
90  PRINT "TABLE OF FIBONACCI NUMBERS"
100 PRINT "TERM NO.," "FIBONACCI NUMBER"
110 LET K = 1
120 PRINT K,A
130 LET K = 2
140 PRINT K,B
150 LET K = K + 1
160 LET Q = A + B
170 PRINT K,Q
180 LET A = B
190 LET B = Q
200 IF K >= N THEN 220
210 GOTO 150
220 PRINT "MAXIMUM NUMBER OF TERMS REACHED"
230 PRINT
240 PRINT "TYPE 1 TO CONTINUE, 0 TO STOP"
250 INPUT L
260 IF L = 1 THEN 280
270 STOP
280 PRINT
290 GOTO 20
300 END
```

FIRST DERIVATIVE

The user must supply the expression to complete the assignment statement in line 280. The computer will then derive the first derivative of the supplied equation.

FORMULA

$$f'(x) = \frac{f(x + \Delta x/2) - f(x - \Delta x/2)}{\Delta x} \quad x > 0$$

EXAMPLE

(ASSUMING THE EQUATION IS X^2)

VALUE OF X =

?

10

IF X = 10 THEN F(X) = 100

AND F'(X) = 20

TYPE 1 TO CONTINUE, 0 TO STOP

?

1

VALUE OF X =

?

20

IF X = 20 THEN F(X) = 400

AND F'(X) = 40

TYPE 1 TO CONTINUE, 0 TO STOP

?

0

*END

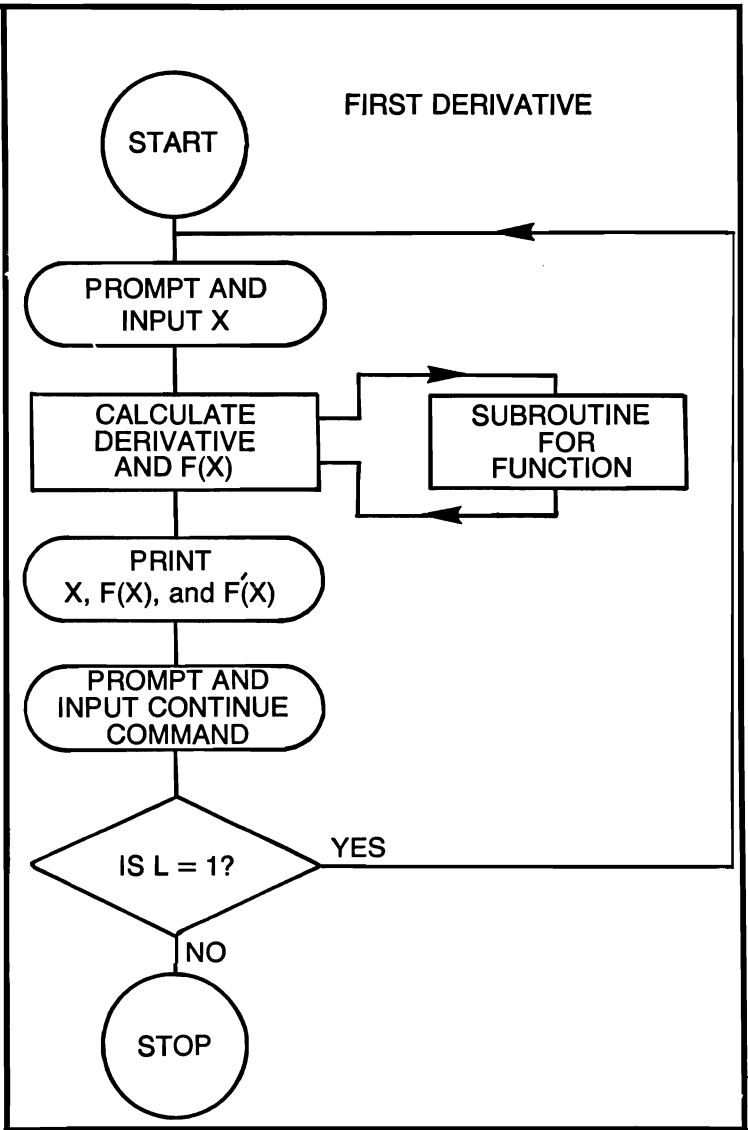

FIRST DERIVATIVE

```

10  REM THIS PROGRAM COMPUTES THE FIRST DE-
    RIVATIVE
20  REM OF A FUNCTION ENTERED BY THE USER
30  PRINT "VALUE OF X = ";
40  INPUT X
  
```

```

50 LET Y = X
60 LET Z = (X*(1E - 04))/2
70 LET W = X + Z
80 LET V = X - Z
90 LET X = W
100 GOSUB 280
110 LET A = P
120 LET X = V
130 GOSUB 280
140 LET B = P
150 LET X = Y
160 GOSUB 280
170 LET C = P
180 LET F = (A - B)/2*Z
190 PRINT "IF X = ";Y,"THEN F(X) = ";C
200 PRINT "AND F' (X) = ";F
210 PRINT
220 PRINT "TYPE 1 TO CONTINUE, 0 TO STOP"
230 INPUT L
240 IF L = 1 THEN 260
250 STOP
260 PRINT
270 GOTO 40
280 LET P =
290 RETURN
300 END

```

GAMMA FUNCTION AND GENERALIZED FACTORIAL

This program computes both the gamma function and the generalized factorial via polynomial approximation.

FORMULAE

$$\Gamma(X) = \int_0^{\infty} t^{x-1} e^{-t} dt$$

$$\Gamma(X) \cong (1 + A_1(Y) + A_2(Y)^2 + \dots + A_8(Y)^8)Z$$

where Y = fractional part of X

where $Z = (X - 1)(X - 2) \dots (X - N)$

and $X - N = 1 + Y$

EXAMPLE

RUN

TYPE G FOR THE GAMMA FUNCTION OR

TYPE F FOR THE GENERALIZED FACTORIAL

?

G

ENTER VALUE OF X

?

5

GAMMA (5) = 24

TO CONTINUE TYPE Y, IF NOT TYPE N

?

Y

TYPE G FOR THE GAMMA FUNCTION OR

TYPE F FOR THE GENERALIZED FACTORIAL

?

F

ENTER VALUE OF X

?

5

5! = 120

TO CONTINUE TYPE Y, IF NOT TYPE N

?

N

*END

GAMMA FUNCTION AND GENERALIZED FACTORIAL

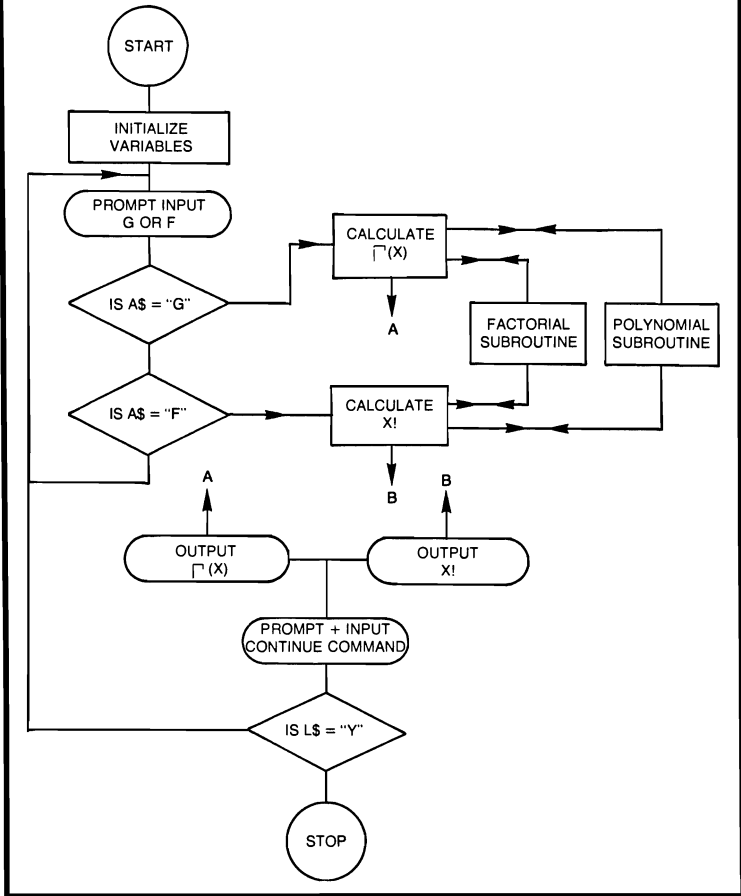

GAMMA FUNCTION AND GENERALIZED FACTORIAL

```

10  REM THIS PROGRAM GENERATES VIA POLY-
    NOMIAL
20  REM APPROXIMATION THE GAMMA FUNCTION
30  REM AND THE GENERALIZED FACTORIALS
40  LET A = 0.57717
50  LET B = 0.98821
60  LET C = 0.89706
70  LET D = 0.91821
80  LET E = 0.7567
90  LET F = 0.4822
100 LET G = 0.19353
    
```



```

110 LET H = 0.03587
120 PRINT "TYPE G FOR THE GAMMA FUNCTION OR"
130 PRINT "TYPE F FOR THE GENERALIZED FAC-
    TORIAL"
140 INPUT A$
150 IF A$ = "G" THEN 190
160 IF A$ = "F" THEN 300
170 PRINT "INVALID RESPONSE"
180 GOTO 120
190 PRINT "ENTER VALUE OF X"
200 INPUT X
210 LET K = X
220 LET K = K - 1
230 IF K >= 0 THEN 260
240 PRINT "X MUST BE EQUAL TO OR GREATER
    THAN 1"
250 GOTO 190
260 GOSUB 490
270 IF (X - 1) = INT(X - 1) THEN 410
280 GOSUB 570
290 GOTO 410
300 PRINT "ENTER VALUE OF X"
310 INPUT X
320 LET K = X
330 IF K >= 0 THEN 360
340 PRINT "X MUST BE GREATER THAN OR EQUAL
    TO 0"
350 GOTO 300
360 GOSUB 490
370 IF X = INT(X) THEN 390
380 GOSUB 570
390 PRINT X;"! = ";K
400 GOTO 420
410 PRINT "GAMMA (";X;) = ";K
420 PRINT
430 PRINT "TO CONTINUE TYPE Y, IF NOT TYPE N"
440 INPUT L$
450 IF L$ = "Y" THEN 470
460 STOP
470 PRINT
480 GOTO 120
490 LET J = 1
500 LET J = J*K

```

```
510 LET K = K - 1
520 IF K < 1 THEN 540
530 GOTO 500
540 LET L = K
550 LET K = J
560 RETURN
570 LET A1 = 1 + (A*L) + (B*(L↑2)) + (C*(L↑3))
580 LET A1 = A1 + (D*(L↑4)) + (E*(L↑5)) + (F*(L↑6))
590 LET A1 = A1 + (G*(L↑7)) + (H*(L↑8))
600 LET K = A1*K
610 RETURN
620 END
```

GAUSSIAN PROBABILITY FUNCTION

This program computes the Gaussian probability function of X.

FORMULA

$$f(X) = \frac{1}{\sqrt{2\pi}} e^{-\frac{X^2}{2}}$$

EXAMPLES

X =

?

3.2

F(X) = .00238

TO CONTINUE TYPE 1, 0 TO STOP

?

1

X =

?

4

F(X) = .000133

TO CONTINUE TYPE 1, 0 TO STOP

?

1

X =

?

1.2

F(X) = .19418

TO CONTINUE TYPE 1, 0 TO STOP

?

0

*END

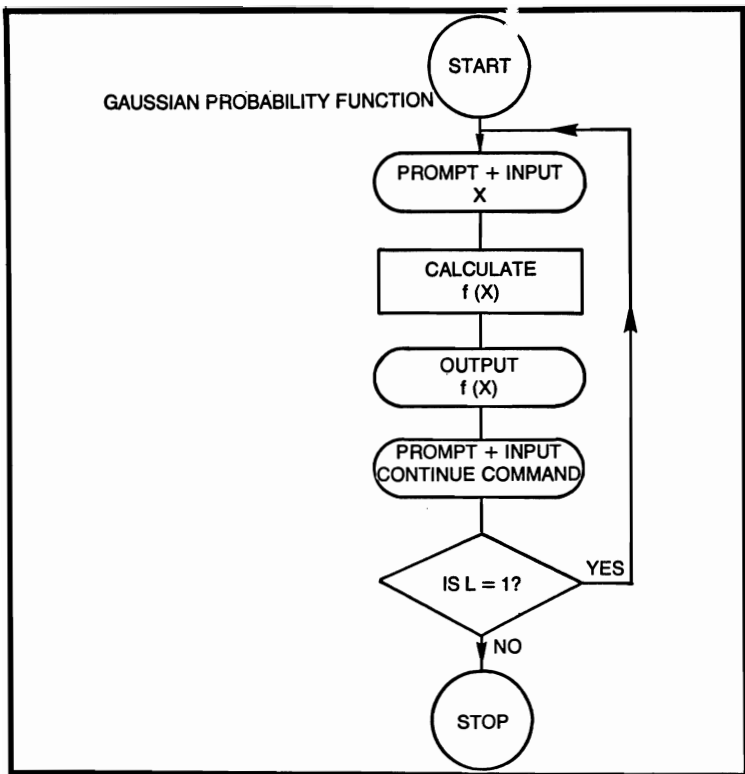

GAUSSIAN PROBABILITY FUNCTION

```

10  REM THIS PROGRAM COMPUTES THE GAUSSIAN
    REM PROBABILITY
20  REM FUNCTION OF X
30  PRINT "X = ";
40  INPUT X
50  LET A = EXP( -(X^2)/2)
60  LET B = .398942
70  LET C = B*A
80  PRINT "F(X) = ";C
90  PRINT
100 PRINT "TO CONTINUE TYPE 1, 0 TO STOP"
110 INPUT L
120 IF L = 1 THEN 140
130 STOP
140 PRINT
150 GOTO 30
160 END
  
```

GAUSSIAN QUADRATURE

This program computes the integral $f(x)dx$ for a finite A by the 6-point Gaussian-Legendre quadrature formula. It should be noted that $f(x)$ must be a single-valued function.

FORMULA

$$\int_A^{\infty} f(x)dx = \frac{1}{2} \sum_{i=1}^6 \frac{4D_i}{(1+C_i)^2} f\left(\frac{2}{1+C_i} + A - 1\right)$$

EXAMPLE

ENDPOINT A =

?

0

INTEGRAL = 0.92

TYPE 1 TO CONTINUE, 0 TO STOP

?

0

*END

The LET Q statement in line 470 must be completed by the user. Any single-valued expression may be used for $f(x)$.

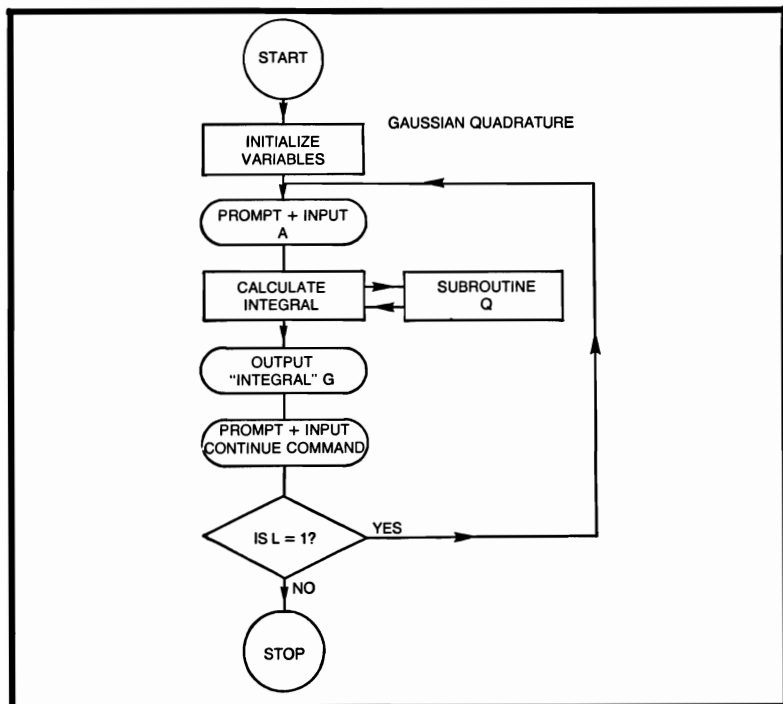

GAUSSIAN QUADRATURE

```
10  REM THIS PROGRAM COMPUTES THE INTEGRAL
    BETWEEN A
20  REM AND INFINITY BY GAUSSIAN QUADRATURE
30  LET C1 = .238619
40  LET C2 = - C1
50  LET C3 = .661209
60  LET C4 = - C3
70  LET C5 = .932470
80  LET C6 = - C5
90  LET D1 = .467914
100 LET D2 = .360762
110 LET D3 = .171324
120 LET J = 0
130 PRINT "ENDPOINT A = ";
140 INPUT A
150 LET X = (2/(1 + C1)) + (A - 1)
160 GOSUB 470
170 LET N = ((4*D1)/(1 + C1)^2)*Q
180 LET J = J + N
190 LET X = (2/(1 + C2)) + (A - 1)
200 GOSUB 470
210 LET N = ((4*D1)/(1 + C2)^2)*Q
220 LET J = J + N
230 LET X = (2/(1 + C3)) + (A - 1)
240 GOSUB 470
250 LET N = ((4*D2)/(1 + C3)^2)*Q
260 LET J = J + N
270 LET X = (2/(1 + C4)) + (A - 1)
280 GOSUB 470
290 LET N = ((4*D2)/(1 + C4)^2)*Q
300 LET J = J + N
310 LET X = (2/(1 + C5)) + (A - 1)
320 GOSUB 470
330 LET N = ((4*D3)/(1 + C5)^2)*Q
340 LET J = J + N
350 LET X = (2/(1 + C6)) + (A - 1)
360 GOSUB 470
370 LET N = ((4*D3)/(1 + C6)^2)*2
380 LET J = J + N
390 LET G = J/2
400 PRINT "INTEGRAL = ";G
```

```
410 PRINT "TYPE 1 TO CONTINUE, 0 TO STOP"  
420 INPUT L  
430 IF L = 1 THEN 450  
440 STOP  
450 PRINT  
460 GOTO 120  
470 LET Q =  
480 RETURN  
490 END
```

GENERALIZED MEAN

This program computes the generalized mean, which becomes equal to the arithmetic mean if the T entered by the user is 1, and equal to the harmonic mean if the user enters - 1.

FORMULA

$$M(T) = \left(\frac{1}{N} \sum_{K=1}^N x_K^T \right)^{\frac{1}{T}} \quad \text{where } X > 0$$

EXAMPLE

T =

?

4

INPUT SAMPLE

?

5

GENERALIZED MEAN

M(T) = 5 WHERE T = 4

TYPE 1 TO CONTINUE, 0 TO STOP

?

0

*END

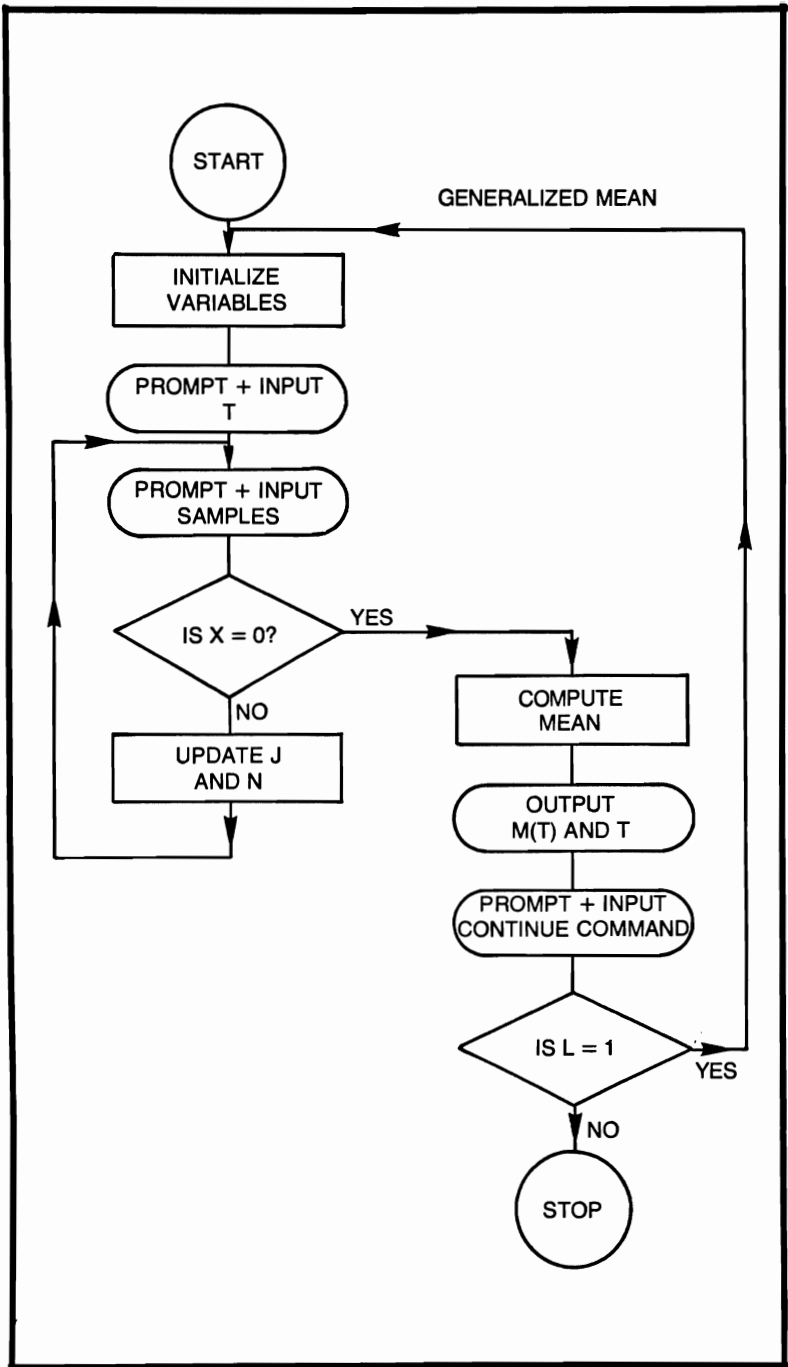

GENERALIZED MEAN

```
10  REM THIS PROGRAM COMPUTES THE GENER-
    ALIZED MEAN
20  REM IF T = 1, THEN THE GENERALIZED MEAN
    M(T)
30  REM IS EQUAL TO THE ARITHMETIC MEAN. IF
    T = - 1
40  REM THEN M(T) IS EQUAL TO THE HARMONIC
    MEAN
50  LET J = 0
60  LET N = 0
70  PRINT "T = ";
80  INPUT T
90  PRINT "INPUT SAMPLE";
100 INPUT X
110 IF X = 0 THEN 150
120 LET J = J + (X^T)
130 LET N = N + 1
140 GOTO 90
150 LET G = (J/N)^(1/T)
160 PRINT "GENERALIZED MEAN"
170 PRINT "M(T) = ";G, "WHERE T = ";T
180 PRINT
190 PRINT "TYPE 1 TO CONTINUE, 0 TO STOP"
200 INPUT L
210 IF L = 1 THEN 230
220 STOP
230 PRINT
240 GOTO 50
250 END
```

GEOMETRIC MEAN

This program computes the geometric mean of the sample entered by the user until a 0 is entered for the sample.

FORMULA

$$G = \sqrt[n]{(a_1)(a_2)\dots(a_n)}$$

EXAMPLE

SAMPLE =

?

2

NUMBER OF SAMPLES = 1 CURRENT SAMPLE = 2

CURRENT MEAN = 2

SAMPLE =

?

5

NUMBER OF SAMPLES = 2 CURRENT SAMPLE = 5

CURRENT MEAN = 3.1623

SAMPLE =

?

0

TYPE 1 TO CONTINUE, 0 TO STOP

?

0

*END

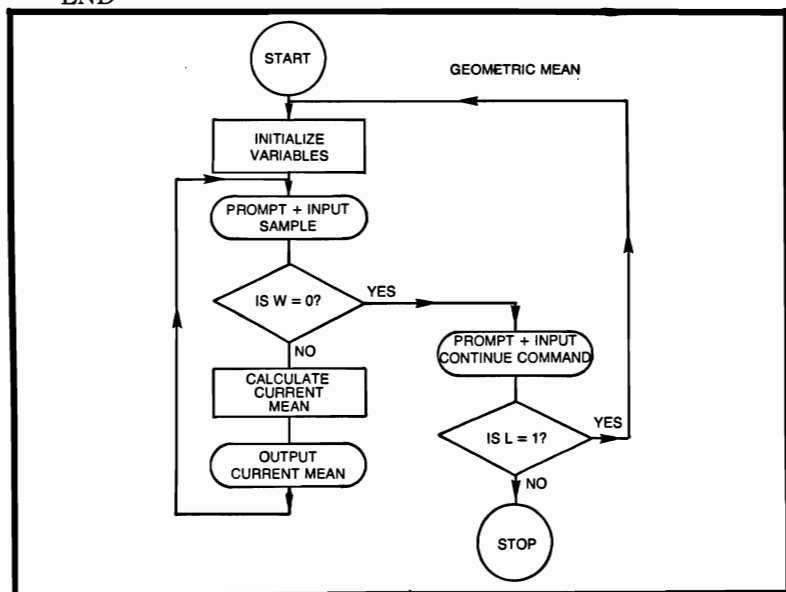

GEOMETRIC MEAN

```
10  REM THIS PROGRAM COMPUTES THE GEOMETRIC
    MEAN
20  REM AFTER EACH SAMPLE IS ENTERED, THE
    NUMBER OF
30  REM SAMPLES, THE CURRENT SAMPLE AND CUR-
    RENT MEAN
40  REM IS PRINTED.
50  LET Y = 1
60  LET N = 0
70  PRINT "SAMPLE = ";
80  INPUT W
90  IF W = 0 THEN 160
100 LET N = N + 1
110 LET Y = Y*W
120 LET G = Y^(1/N)
130 PRINT "NUMBER OF SAMPLES = ";N,"CURRENT
    SAMPLE = ";W
140 PRINT "CURRENT MEAN = ";G
150 GOTO 70
160 PRINT
170 PRINT "TYPE 1 TO CONTINUE, 0 TO STOP"
180 INPUT L
190 IF L = 1 THEN 210
200 STOP
210 PRINT
220 GOTO 50
230 END
```

GEOMETRIC PROGRESSION

From the following information: first term, ratio of terms, and number of terms, this program computes the geometric progression.

FORMULA

$$A, AR, AR^2, \dots, AR^{N-1}$$

EXAMPLE

FIRST TERM =

?

10

RATIO OF TERMS =

?

2

NUMBER OF TERMS =

?

5

FOR TABLE, TYPE 1, IF NOT TYPE 0

?

1

GEOMETRIC PROGRESSION

TERM NUMBER	TERM VALUE
-------------	------------

1	10
---	----

2	20
---	----

3	40
---	----

4	80
---	----

5	160
---	-----

SUM = 310

TYPE 1 TO CONTINUE, 0 TO STOP

?

0

*END

GEOMETRIC PROGRESSION

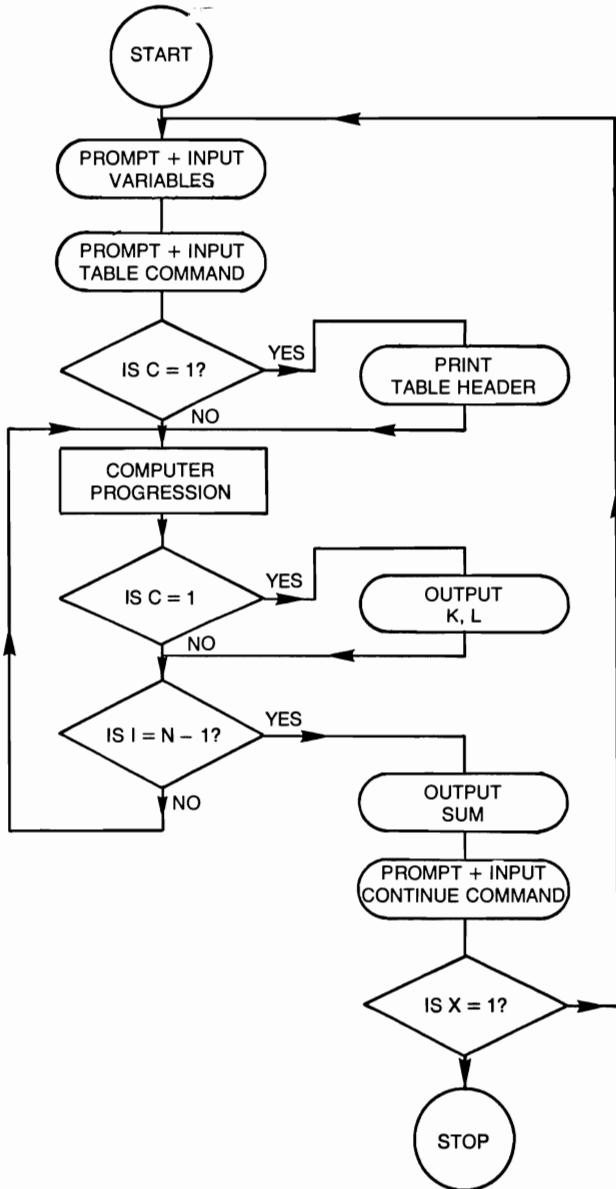

GEOMETRIC PROGRESSION

```
10    REM THIS PROGRAM COMPUTES THE VALUES AND
      THEIR SUM
20    REM OF A GEOMETRIC PROGRESSION
30    PRINT "FIRST TERM = ";
40    INPUT A
50    PRINT "RATIO OF TERMS = ";
60    INPUT R
70    PRINT "NUMBER OF TERMS = ";
80    INPUT N
90    PRINT "FOR TABLE TYPE 1, IF NOT TYPE 0"
100   INPUT C
110   IF C = 1 THEN 130
120   GOTO 160
130   PRINT
140   PRINT "GEOMETRIC PROGRESSION"
150   PRINT "TERM NUMBER";,"TERM VALUE";
160   LET J = 0
170   FOR I = 0 TO N - 1
180   LET K = I + 1
190   LET L = A*(RI)
200   LET J = J + L
210   IF C = 1 THEN 230
220   GOTO 240
230   PRINT K,L
240   NEXT I
250   PRINT "SUM = ";J
260   PRINT
270   PRINT "TYPE 1 TO CONTINUE, 0 TO STOP"
280   INPUT X
290   IF X = 1 THEN 310
300   STOP
310   PRINT
320   GOTO 30
330   END
```

HARMONIC MEAN

This program computes the harmonic mean of the samples entered by the user, until a 0 is entered for the sample.

FORMULA

$$H = \frac{N}{\sum_{i=1}^N \frac{1}{a_i}}$$

EXAMPLE

SAMPLE =

?

2

N = 1 SAMPLE = 2 CURRENT MEAN = 2

SAMPLE =

?

5

N = 2 SAMPLE = 5 CURRENT MEAN = 2.86

SAMPLE =

?

7

N = 3 SAMPLE = 7 CURRENT MEAN = 3.56

SAMPLE =

?

0

TYPE 1 TO CONTINUE, 0 TO STOP

?

0

*END

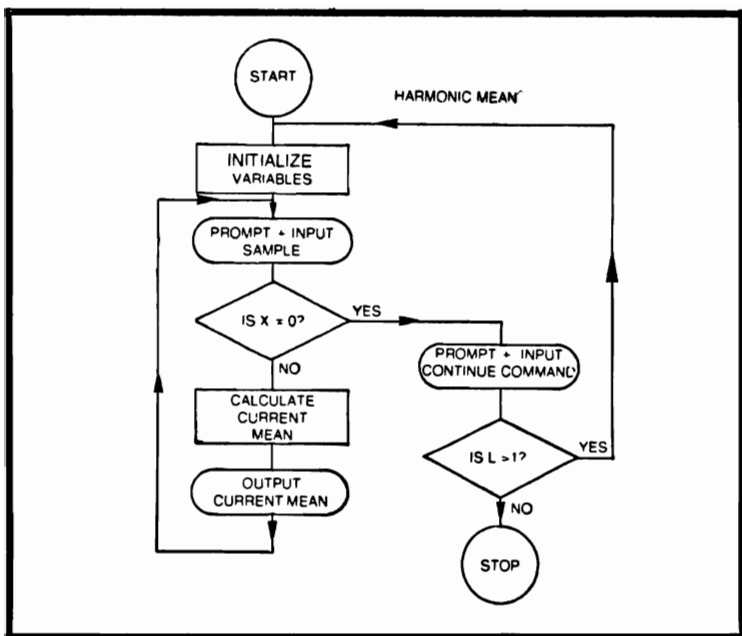

HARMONIC MEAN

```

10  REM THIS PROGRAM COMPUTES THE HARMONIC
    MEAN
20  REM OF THE SAMPLES ENTERED BY THE USER
30  LET Z = 0
40  LET N = 0
50  PRINT "SAMPLE = ";
60  INPUT X
70  IF X = 0 THEN 130
80  LET N = N + 1
90  LET Z = Z + (1/X)
100 LET H = N/Z
110 PRINT "N = ";N,"SAMPLE = ";X,"CURRENT MEAN
    = ";H
120 GOTO 50
130 PRINT
140 PRINT "TYPE 1 TO CONTINUE, 0 TO STOP"
150 INPUT L
160 IF L = 1 THEN 180
170 STOP
180 PRINT
190 GOTO 30
200 END
  
```

HARMONIC NUMBERS

This program computes the first N harmonic numbers where N is entered by the user.

FORMULA

$$1, 1 + 1/2, 1 + 1/2 + 1/3, 1 + 1/2 + 1/3 + 1/4 \dots$$

EXAMPLE

MAXIMUM TERM NUMBER

?

35

TERM NUMBER	TERM VALUE
1	1
2	1.5
3	1.83333
4	2.08333
5	2.28333
6	2.45
7	2.59285
8	2.71785
9	2.82896
10	2.92896
11	3.01987
12	3.10321
13	3.18013
14	3.25156
15	3.31822
16	3.38072
17	3.43955
18	3.49510
19	3.54774
20	3.59773
21	3.64535
22	3.69081
23	3.73429
24	3.77595
25	3.81595
26	3.85442
27	3.89145
28	3.92717
29	3.96165
30	3.99498

TERM NUMBER

TERM VALUE

31

4.02724

32

4.05849

33

4.08879

34

4.11821

35

4.14678

36

4.17456

*END

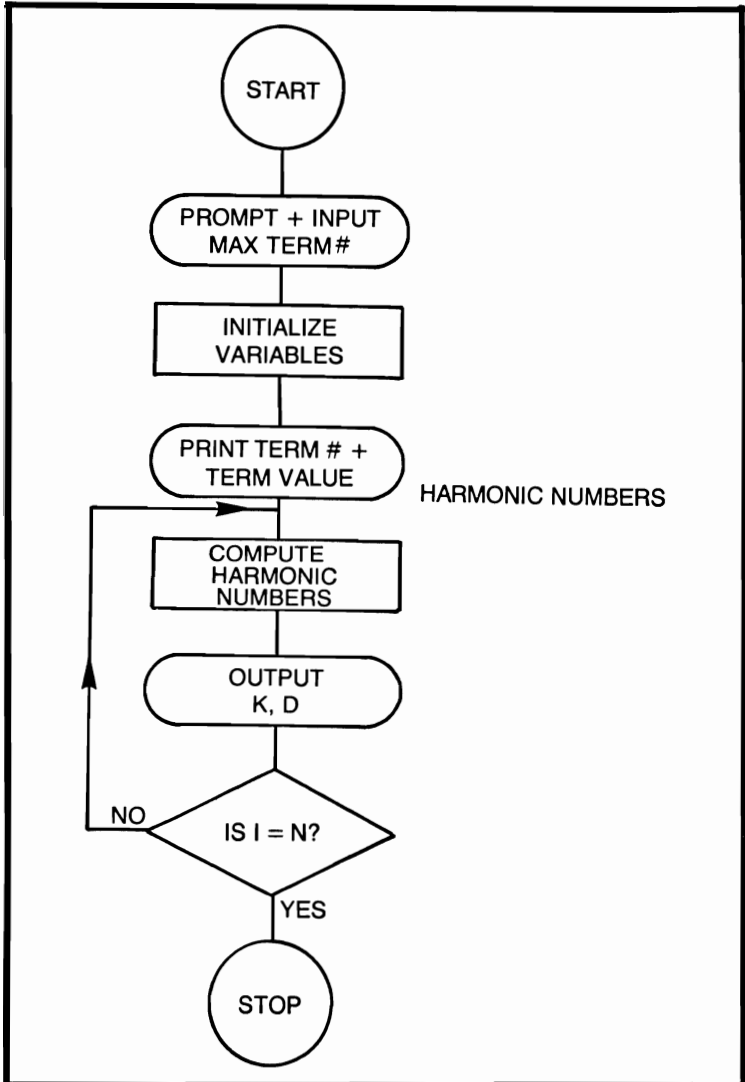

HARMONIC NUMBERS

```
10  REM THIS PROGRAM COMPUTES HARMONIC
    NUMBERS
20  PRINT "MAXIMUM TERM NUMBER"
30  INPUT N
40  LET K = 0
50  LET D = 0
60  PRINT "TERM NUMBER", "TERM VALUE"
70  FOR I = 0 TO N
80  LET K = I + 1
90  LET C = 1/K
100 LET D = D + C
110 PRINT K,D
120 NEXT I
130 PRINT
140 END
```

HARMONIC PROGRESSIONS

This program computes from the following information the values of A and B, the difference and the number of terms desired. At the user's option a table of progressions may be generated. In either case the sum of the number of terms is produced.

FORMULA

$$\frac{A}{B}, \frac{A}{B + D}, \frac{A}{B + 2D}, \dots, \frac{A}{B + (N - 1)D}$$

EXAMPLE

VALUE OF A =

?

10

VALUE OF B =

?

2

DIFFERENCE =

?

3

NUMBER OF TERMS =

?

20

FOR TABLE TYPE 1, IF NOT TYPE 0

?

1

HARMONIC PROGRESSION

TERM NUMBER TERM VALUE

1	5
2	2
3	1.25
4	.90901
5	.714286
6	.588235
7	.5
8	.434783
9	.384615
10	.344828
11	.3125
12	.285714

TERM NUMBER	TERM VALUE
13	.263158
14	.243802
15	.227273
16	.212766
17	.2
18	.188679
19	.178571
20	.169492

SUM = 14.4078

TYPE 1 TO CONTINUE, 0 TO STOP

?

0

*END

HARMONIC PROGRESSIONS

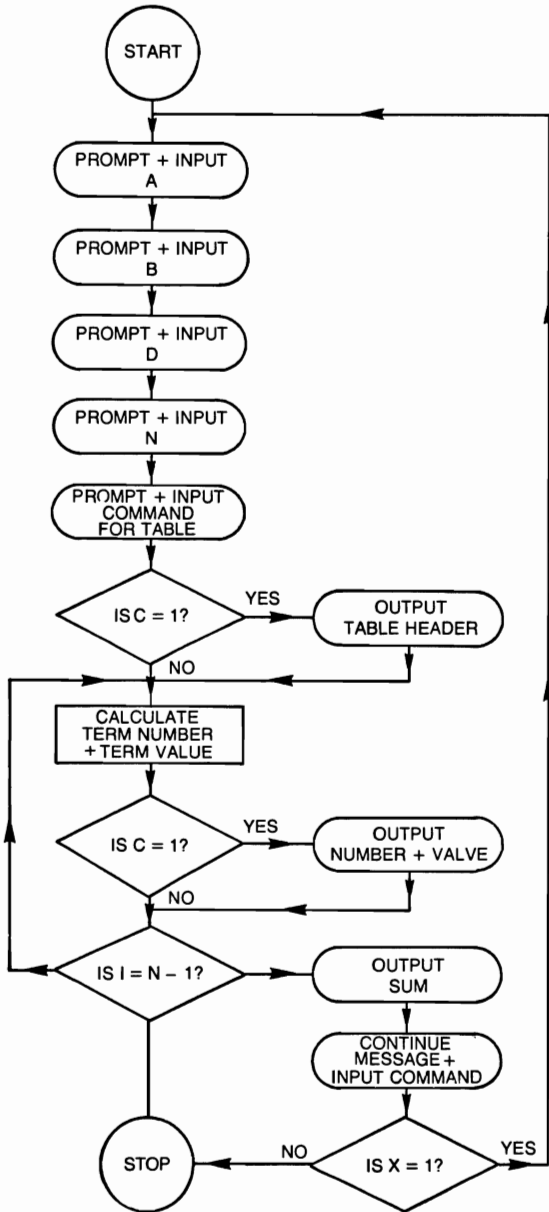

HARMONIC PROGRESSIONS

```
10  REM THIS PROGRAM COMPUTES A SERIES OF
    HARMONIC
20  REM PROGRESSIONS
30  PRINT "VALUE OF A = "
40  INPUT A
50  PRINT "VALUE OF B = "
60  INPUT B
70  PRINT "DIFFERENCE = "
80  INPUT D
90  PRINT "NUMBER OF TERMS = "
100 INPUT N
110 PRINT "FOR TABLE TYPE 1, IF NOT TYPE 0"
120 INPUT C
130 IF C = 1 THEN 150
140 GOTO 170
150 PRINT "HARMONIC PROGRESSION"
160 PRINT "TERM NUMBER", "TERM VALUE"
170 LET J = 0
180 FOR I = 0 TO N - 1
190 LET K = I + 1
200 LET L = A/(B + (I*D))
210 LET J = J + L
220 IF C = 1 THEN 240
230 GOTO 250
240 PRINT K,L
250 NEXT I
260 PRINT "SUM = ";J
270 PRINT "*****"
280 PRINT "TYPE 1 TO CONTINUE, 0 TO STOP"
290 INPUT X
300 IF X = 0 THEN 320
310 STOP
320 PRINT
330 GOTO 30
340 END
```

HYDROCARBON COMBUSTION

This program simulates the burning of a hydrocarbon compound; complete combustion is assumed, and the option of excess air is available.

FORMULAE

$$\text{AIR} = 1 + \% \text{ EXCESS AIR}/100$$

$$\text{O}_2 = \text{C} + \text{S} + \text{H}/4 - \text{O}/2$$

$$\text{AF(MOLES)} = \text{O}_2(4.762)\text{AIR}$$

$$\text{AF(MASS)} = 1.8094(\text{AF MOLES})/.7507\text{C} + 0.063\text{H}$$

$$+ 2.004\text{S} + 0.875\text{N} + \text{O}$$

$$\text{TOTAL MOLES} = \text{O}_2(4.762 \text{ AIR}) + \text{H}/4 + \text{O}/2 + \text{N}/2$$

$$\text{VOLUME \% CO}_2 = 100\text{C}/\text{M}$$

$$\text{VOLUME \% SO}_2 = 100\text{S}/\text{M}$$

$$\text{VOLUME \% H}_2\text{O} = 100\text{H}/2\text{M}$$

$$\text{VOLUME \% O}_2 = 100(\text{AIR} - 1)\text{O}_2/\text{M}$$

$$\text{VOLUME \% N}_2 = (100((3.762)\text{AIR}(\text{O}_2) + \text{N}/2))/\text{M}$$

EXAMPLE

RUN

FOR INSTRUCTIONS TYPE YES, IF NOT TYPE NO

?

NO

ENTER CARBON(C), HYDROGEN(H), OXYGEN(O), SULPHUR(S), NITROGEN(N) IN THAT ORDER

?

1,4,0,0,0

ENTER PERCENTAGE EXCESS AIR, IF ZERO

ENTER 0, EXAMPLE: - 34% ENTER AS 34

?

0

AIR-FUEL RATIO WITH RESPECT TO MOLES = 9.52

AIR-FUEL RATIO WITH RESPECT TO MASS = 17.19

TOTAL MOLES OF PRODUCTION = 10.52

*****PERCENTAGE OF VOLUME OF PRODUCTS*****

CARBON DIOXIDE = 9.50%

SULPHUR DIOXIDE = 0.0%

WATER = 19.0%

OXYGEN = 0.0%

NITROGEN = 71.49%

*****COMPLETE COMBUSTION ASSUMED*****

TO TRY NEXT COMPOUND TYPE YES

TO STOP TYPE NO

?

NO

COMBUSTION SAYS GOOD-BYE

*END

HYDROCARBON COMBUSTION

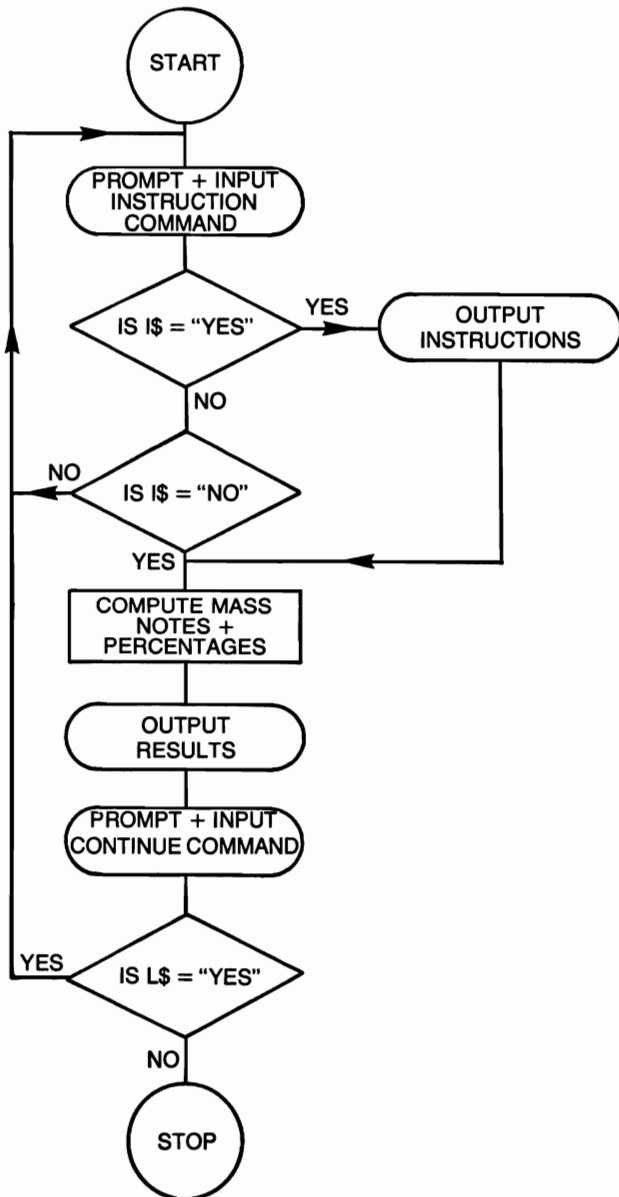

HYDROCARBON COMBUSTION

```
10  REM THIS PROGRAM COMPUTES THE PERCENT-
    AGES OF THE
20  REM PRODUCTS PRODUCED BY HYDROCARBON
    COMBUSTION
30  PRINT "FOR INSTRUCTIONS TYPE YES, IF NOT
    TYPE NO"
40  INPUT I$
50  IF I$ = "YES" THEN 90
60  IF I$ = "NO" THEN 130
70  PRINT "INVALID COMMAND"
80  GOTO 30
90  PRINT "THE AMOUNTS OF EACH ELEMENT MUST
    BE"
100 PRINT "ENTERED, EVEN IF THE AMOUNT IS ZERO"
110 PRINT "EXAMPLE: - METHANE (CH4) MUST BE
    ENTERED AS"
120 PRINT "C;1, H;4, O;0, S;0, N;0"
130 PRINT
140 PRINT "ENTER CARBON(C), HYDROGEN(H), OXY-
    GEN(O)"
150 PRINT "SULPHUR(S), NITROGEN(N) IN THAT
    ORDER"
160 INPUT C,H,O,S,N
170 PRINT "ENTER PERCENTAGE EXCESS AIR, IF
    ZERO"
180 PRINT "ENTER 0, EXAMPLE: - 34% ENTER AS 34"
190 INPUT E
200 LET E = 1 + (E/100)
210 LET O2 = C + S + (H/4) - (O/2)
220 LET A = O2*E*4.762
230 LET A1 = 1.8094*A
240 LET F = (0.7507*C) + (0.063*H) + (2.004*S)
250 LET F = (0.875*N) + O + F
260 LET A1 = A1/F
270 LET M = A + (HP4) + (O/2) + (N/2)
280 LET C2 = (C*100)/M
290 LET S2 = (S*100)/M
300 LET H2 = (H*100)/(2*M)
310 LET O3 = (100*(E- 1)*O2)/M
320 LET N2 = (100*((3.762*E*O2) +(N/2)))/M
330 PRINT
```

```

340 PRINT "AIR-FUEL RATIO WITH RESPECT TO
      MOLES = ";A
350 PRINT "AIR-FUEL RATIO WITH RESPECT TO
      MASS = ";A1
360 PRINT "TOTAL MOLES OF PRODUCT = ";M
370 PRINT "*****PERCENTAGE VOLUME OF PRO-
      DUCTS*****"
380 PRINT "CARBON DIOXIDE = ";C2;" %"
390 PRINT "SULPHUR DIOXIDE = ";S2;" %"
400 PRINT "WATER = ";H2;" %"
410 PRINT "OXYGEN = ";O3;" %"
420 PRINT "NITROGEN = ";N2;" %"
430 PRINT "*****COMPLETE COMBUSTION AS-
      SUMED*****"
440 PRINT
450 PRINT "TO TRY NEXT COMPOUND TYPE YES"
460 PRINT "TO STOP TYPE NO"
470 INPUT L$
480 IF L$ = "YES" THEN 510
490 PRINT "COMBUSTION SAYS GOOD-BYE"
500 STOP
510 PRINT
520 GOTO 30
530 END

```

HYPERBOLIC FUNCTIONS

This program computes the following hyperbolic trigonometric functions: sinH, cosH, tanH, cscH, secH, cotH.

FORMULAE

$$\sin H x = \frac{e^x - e^{-x}}{2}$$

$$\csc H x = \frac{1}{\sin H x}$$

$$\cos H x = \frac{e^x + e^{-x}}{2}$$

$$\sec H x = \frac{1}{\cos H x}$$

$$\tan H x = \frac{e^x - e^{-x}}{e^x + e^{-x}}$$

$$\cot H x = \frac{1}{\tan H x}$$

EXAMPLE

TYPE A NUMBER 1 TO 6 FOR FUNCTION DESIRED

?

1

X =

?

4

SINH 4 = 27.2899

TYPE 1 TO CONTINUE, 0 TO STOP

?

1

TYPE A NUMBER 1 TO 6 FOR FUNCTION DESIRED

?

2

X =

?

5

COSH 5 = 74.2099

TYPE 1 TO CONTINUE, 0 TO STOP

?

1

TYPE A NUMBER 1 TO 6 FOR FUNCTION DESIRED

?

3

X =

?

.02

TANH .02 = .019997

TYPE 1 TO CONTINUE, 0 TO STOP
?
1
TYPE A NUMBER 1 TO 6 FOR FUNCTION DESIRED
?
4
X =
?
3.5
CSCH 3.5 = .060449
TYPE 1 TO CONTINUE, 0 TO STOP
?
1
TYPE A NUMBER 1 TO 6 FOR FUNCTION DESIRED
?
5
X =
12
SECH 12 = .000012
TYPE 1 TO CONTINUE, 0 TO STOP
?
1
TYPE A NUMBER 1 TO 6 FOR FUNCTION DESIRED
?
6
X =
?
.3
COTH .3 = 3.43273
TYPE 1 TO CONTINUE, 0 TO STOP
?
0
*END

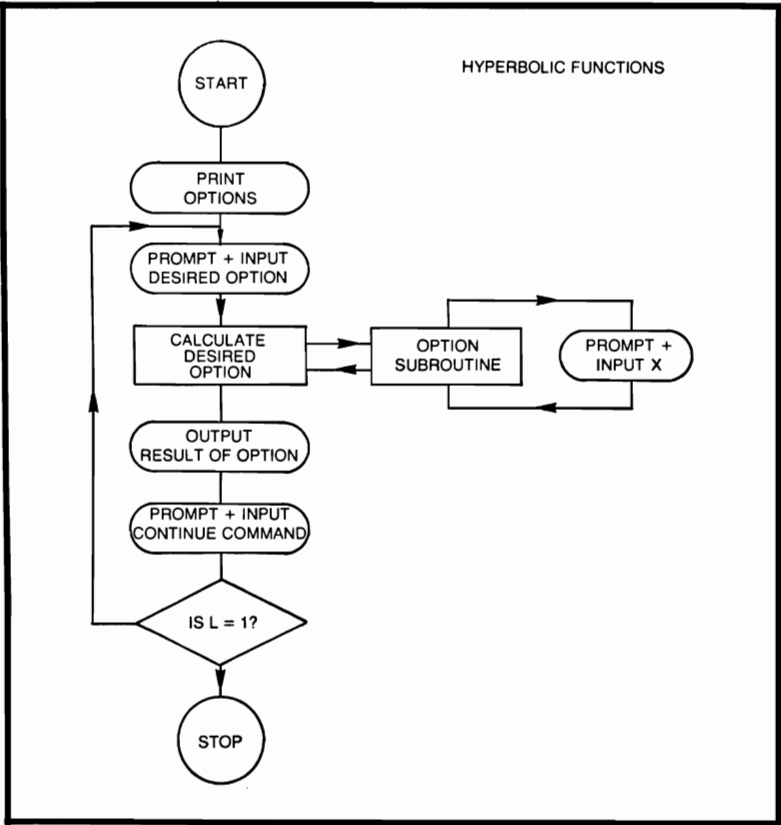

HYPERBOLIC FUNCTIONS

```

10  REM THIS PROGRAM COMPUTES HYPERBOLIC
    FUNCTIONS
20  PRINT "SINH (1)"
30  PRINT "COSH (2)"
40  PRINT "TANH (3)"
50  PRINT "CSCH (4)"
60  PRINT "SECH (5)"
70  PRINT "COTH (6)"
80  PRINT "TYPE A NUMBER 1 TO 6 FOR FUNCTION
    DESIRED"

90  INPUT C
100  ON C GOTO 110,160,200,270,320,370
110  GOSUB 490
120  GOSUB 520
130  LET Z = Y/2
  
```

```

140 PRINT "SINH";X;" = " ;Z
150 GOTO 420
160 GOSUB 490
170 GOSUB 540
180 LET Z = B/2
190 PRINT "COSH";X;" = ";Z
200 GOTO 420
210 GOSUB 490
220 GOSUB 520
230 GOSUB 540
240 LET Z = Y/B
250 PRINT "TANH";X;" = ";Z
260 GOTO 420
270 GOSUB 490
280 GOSUB 520
290 LET Z = 1/(Y/2)
300 PRINT "CSCH";X;" = ";Z
310 GOTO 420
320 GOSUB 490
330 GOSUB 540
340 LET Z = 1/(B/2)
350 PRINT "SECH";X;" = ";Z
360 GOTO 420
370 GOSUB 490
380 GOSUB 520
390 GOSUB 540
400 LET Z = 1/(Y/B)
410 PRINT "COTH";X;" = ";Z
420 PRINT
430 PRINT "TYPE 1 TO CONTINUE, 0 TO STOP"
440 INPUT L
450 IF L = 1 THEN 470
460 STOP
470 PRINT
480 GOTO 80
490 PRINT "X = "
500 INPUT X
510 RETURN
520 LET Y = EXP(X) - EXP(- X)
530 RETURN
540 LET B = EXP(X) + EXP(- X)
550 RETURN
560 END

```

I CHING (THE CHINESE BOOK OF CHANGES)

The I Ching is a collection of 64 hexagrams used to determine possible future events. It was inspired by the ancient Chinese. Each hexagram consists of six lines which may be broken (- -) or unbroken(---). The user of the I Ching may throw coins or sticks to produce the six lines. This program computes the six lines randomly on an algorithm using the date and time. The meanings of each of the possible 64 hexagrams may be looked up in the Chinese Book of Changes (The I Ching).

EXAMPLE

RUN

ENTER DATE AS M,D,Y

?

8,28,1977

ENTER TIME AS H,M(24 HOUR CLOCK)

?

9,56

--

--

--

TO CONTINUE TYPE Y, IF NOT TYPE N

?

N

THE I CHING SAYS GOOD-BYE

*END

I CHING

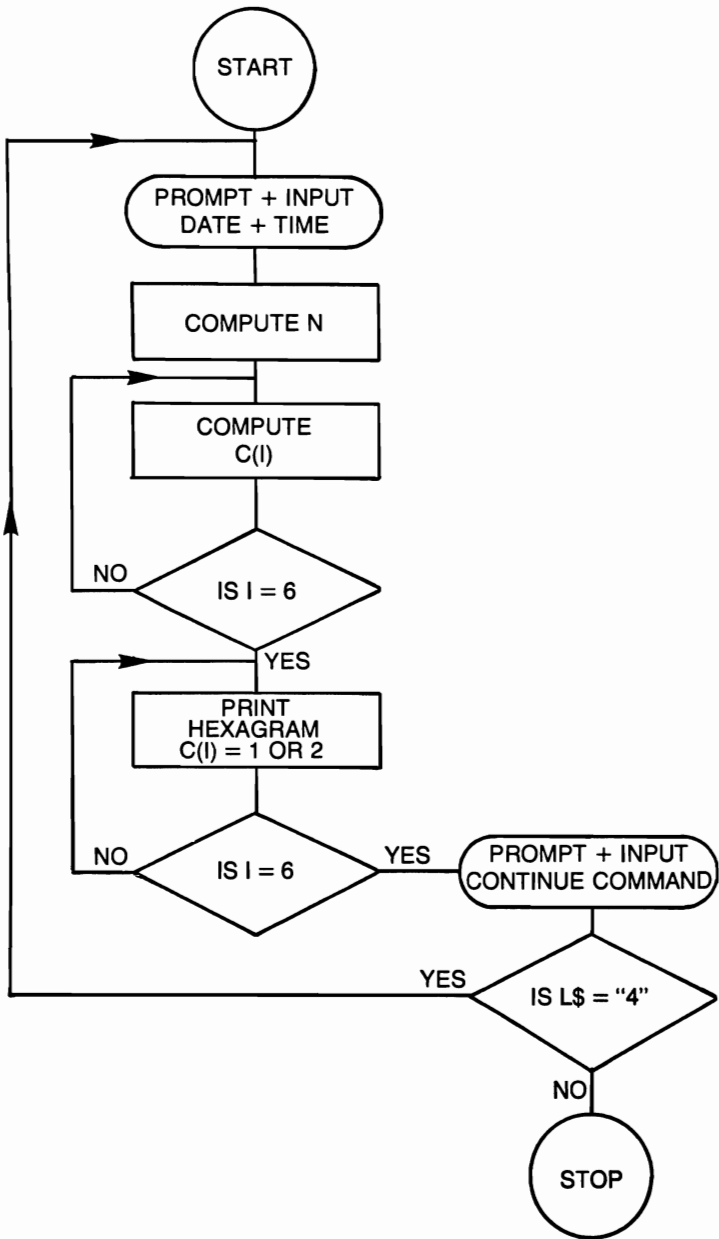

I CHING

```
10  REM THIS PROGRAM SIMULATES THE I CHING
20  RANDOMIZE
30  PRINT "ENTER DATE AS M,D,Y"
40  INPUT M,D,Y
50  PRINT "ENTER TIME AS H,M(24 HOUR CLOCK)"
60  INPUT H,M1
70  LET N = M + (D/30) + (Y/100) + H + (M1/60)
80  FOR I = 1 TO 6
90  LET K = N*RND(0)
100 LET K = K - INT(K)
110 LET C(I) = 1 + INT(2*K)
120 NEXT I
130 FOR I = 1 TO 6
140 IF C(I) = 1 THEN 170
150 PRINT "---"
160 GOTO 180
170 PRINT "- .-"
180 NEXT I
190 PRINT
200 PRINT "TO CONTINUE TYPE Y, IF NOT TYPE N"
210 INPUT L$
220 IF L$ = "Y" THEN 250
230 PRINT "THE I CHING SAYS GOOD-BYE"
240 STOP
250 PRINT
260 GOTO 30
270 END
```

INTEGRAL BETWEEN TWO LIMITS

This program computes the integral between the limits of finite points A and B for single-valued function $f(x)$ by the six-point Gauss-Legendre quadrature formula.

FORMULA

$$\int_a^b f(x) dx = \frac{b-a}{2} \sum_{i=1}^6 D_i f\left(\frac{C_i(b-a) + b+a}{2}\right)$$

EXAMPLE

Where $f(x) = 13x^2 - 6x^2 + \sin(x) + 1/x$

ENTER ENDPOINTS A,B

?

- 1,1

INTEGRAL = 4.28786

TYPE 1 TO CONTINUE, 0 TO STOP

?

0

*END

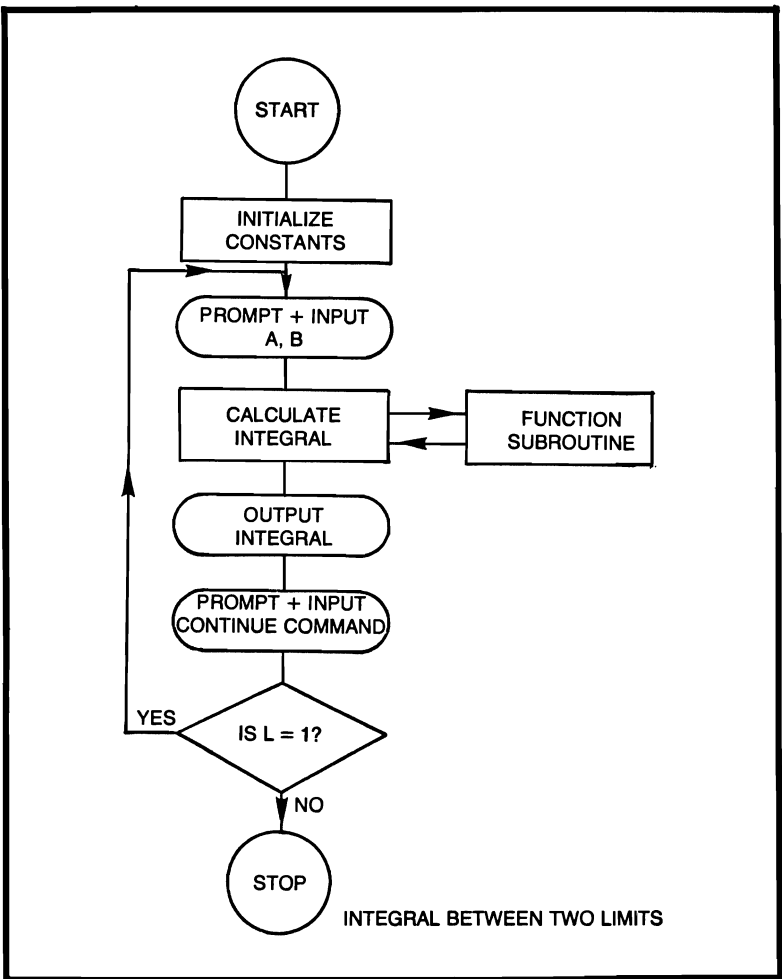

INTEGRAL BETWEEN TWO LIMITS

```

10  REM THIS PROGRAM COMPUTES THE INTEGRAL
    BETWEEN
20  REM THE LIMITS A AND B OF F(X)
30  LET C1 = .238619
40  LET C2 = C1
50  LET C3 = .661209
60  LET C4 = C3
70  LET C5 = .932470
80  LET C6 = C5
90  LET D1 = .467914
  
```

```

100 LET D2 = .360762
110 LET D3 = .171324
120 LET J = 0
130 PRINT "ENTER ENDPOINTS A,B"
140 INPUT A,B
150 LET Y = B - A
160 LET Z = B + A
170 LET X = ((C1*Y) + Z)/2
180 GOSUB 500
190 LET N = D1*Q
200 LET J = J + N
210 LET X = ((C2*Y) + Z)/2
220 GOSUB 500
230 LET N = D1*Q
240 LET J = J + N
250 LET X = ((C3*Y) + Z)/2
260 GOSUB 500
270 LET N = D2*Q
280 LET J = J + N
290 LET X = ((C4*Y) + Z)/2
300 GOSUB 500
310 LET N = D2*Q
320 LET J = J + N
330 LET X = ((C5*Y) + Z)/2
340 GOSUB 500
350 LET N = D3*Q
360 LET J = J + N
370 LET X = ((C6*Y) + Z)/2
380 GOSUB 500
390 LET N = D3*Y
400 LET J = J + N
410 LET G = (Y/2)*J
420 PRINT "INTEGRAL = ";G
430 PRINT
440 PRINT "TYPE 1 TO CONTINUE, 0 TO STOP"
450 INPUT L
460 IF L = 1 THEN 480
470 STOP
480 PRINT
490 GOTO 120
500 LET Q = 13*X↑2 - 6*X↑2 + SIN(X) + 1/X
510 RETURN
520 END

```

INTERACTIVE GROWTH PATTERN

This program computes a growth pattern between two quantities called X and Y, where the existence of Y depends on the destruction of an X, but to be just, X can propagate.

EXAMPLE

NUMBER OF DESTROYERS (Y) =

?

201

NUMBER OF CREATORS (X) =

?

347

PROPAGATION RATE OF X =

?

6

CHANCE OF MEETING BETWEEN X AND Y =

?

.01

TIME BETWEEN SAMPLE DISPLAYED =

?

.5

MAXIMUM GENERATIONS =

?

10

INTERACTIVE GROWTH PATTERN

CREATOR	DESTROYER
---------	-----------

1039	449
------	-----

1822	2558
------	------

0	24600
---	-------

0	12300
---	-------

0	6150
---	------

0	3075
---	------

0	1537
---	------

0	768
---	-----

0	384
---	-----

0	192
---	-----

MAXIMUM NUMBER OF GENERATIONS REACHED

FOR FURTHER GENERATIONS, TYPE 1, IF NOT 0

?

1

MAXIMUM GENERATIONS =

?

10	
0	96
0	48
0	24
0	12
0	6
0	3
0	1
0	0

ALL GROWTH ENDED
 NUMBER OF GENERATIONS = 18
 FOR NEXT PATTERN TYPE 1, 0 TO STOP
 ?
 0
 *END

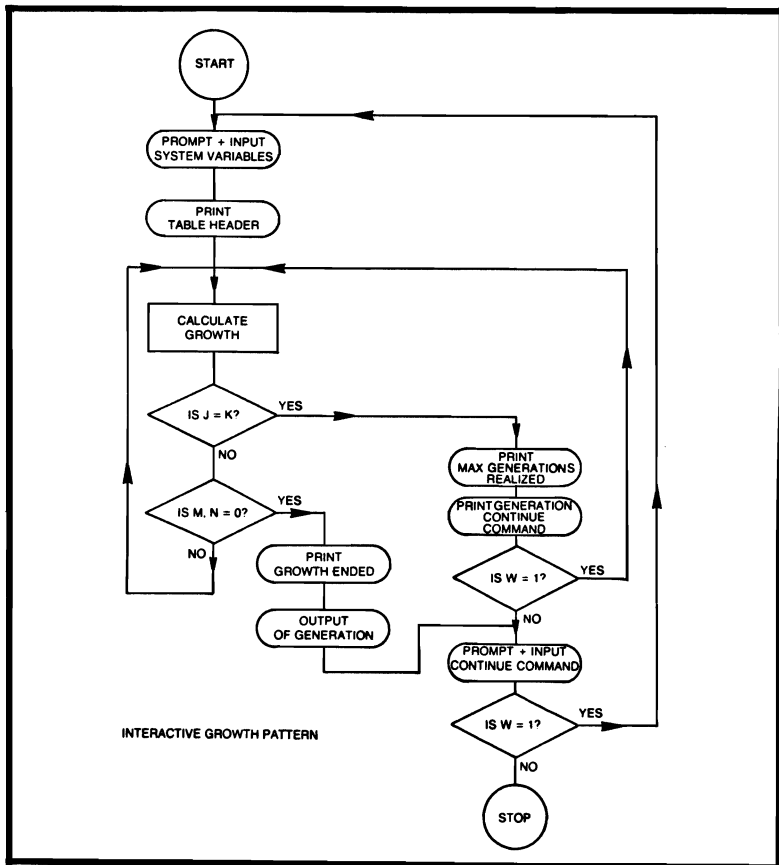

INTERACTIVE GROWTH PATTERN

```
10  REM THIS PROGRAM COMPUTES THE GROWTH
    PATTERN BETWEEN
20  REM A QUANTITY Y THE DESTROYER AND A
    QUANTITY X
30  REM THE CREATOR. X CAN PROPAGATE, AND ON A
40  REM CHANCE METTING BETWEEN X AND Y, X IS
    DESTROYED,
50  REM THUS INCREASING THE NUMBER OF YS.
60  PRINT "NUMBER OF DESTROYERS (Y) = ";
70  INPUT Y
80  PRINT "NUMBER OF CREATORS (X) = ";
90  INPUT X
100 PRINT "PROPAGATION RATE OF X = ";
110 INPUT Z
120 PRINT "CHANCE OF METTING BETWEEN X AND Y
    = ";
130 INPUT A
140 PRINT "TIME BETWEEN SAMPLES = ";
150 INPUT H
160 PRINT "MAXIMUM GENERATIONS = ";
170 INPUT K
180 LET J = 0
190 PRINT
200 PRINT "INTERACTIVE GROWTH PATTERN"
210 PRINT
220 PRINT "CREATOR", "DESTROYER"
230 IF J = K THEN 470
240 LET J = J + 1
250 LET B = A*X*Y
260 LET C = ((Y - B)*H) + Y
270 IF C < 0 THEN 390
280 LET Y = C
290 LET D = ((X*Z) - B)*H) + X
300 IF D < 0 THEN 140
310 LET X = D
320 LET M = INT(X)
330 LET N = INT(Y)
340 PRINT M,N
350 IF M = 0 THEN 370
360 GOTO 230
370 IF N = 0 THEN 430
380 GOTO 230
```

```
390 LET Y = 0
400 GOTO 290
410 LET X = 0
420 GOTO 320
430 PRINT "ALL GROWTH ENDED"
440 PRINT "NUMBER OF GENERATIONS = ";J
450 PRINT
460 GOTO 560
470 PRINT "MAXIMUM NUMBER OF GENERATIONS
REACHED"
480 PRINT
490 PRINT "FOR FURTHER GENERATIONS TYPE 1, IF
NOT 0"
500 INPUT W
510 IF W = 1 THEN 530
520 GOTO 560
530 PRINT "MAXIMUM GENERATIONS = ";
540 INPUT K
550 GOTO 230
560 PRINT
570 PRINT "FOR NEXT PATTERN TYPE 1, 0 TO STOP"
580 INPUT W
590 IF W = 1 THEN 610
600 STOP
610 PRINT
620 GOTO 60
630 END
```

INVERSE HYPERBOLIC FUNCTIONS

This program computes the following hyperbolic trigonometric functions: $\sin H^{-1}$, $\cos H^{-1}$, $\tan H^{-1}$, $\csc H^{-1}$, $\sec H^{-1}$, $\cot H^{-1}$

FORMULAE

$$\sin H^{-1}x = \ln(X + (x^2 + 1)^{.5})$$

$$\cos H^{-1}x = \ln(x + (x^2 - 1)^{.5})$$

$$\tan H^{-1}x = \frac{1}{2} \ln \left(\frac{1+x}{1-x} \right)$$

$$\csc H^{-1}x = \sin H^{-1} \left(\frac{1}{x} \right)$$

$$\sec H^{-1}x = \cos H^{-1} \left(\frac{1}{x} \right)$$

$$\cot H^{-1}x = \tan H^{-1} \left(\frac{1}{x} \right)$$

EXAMPLE

TYPE A NUMBER 1 TO 6 FOR FUNCTION DESIRED

?

1

X =

?

12

SINH - 1 12 = 3.17979

TYPE 1 TO CONTINUE, 0 TO STOP

?

1

TYPE A NUMBER 1 TO 6 FOR FUNCTION DESIRED

?

2

X =

?

45

COSH - 1 45 = 4.49969

TYPE 1 TO CONTINUE, 0 TO STOP

?

1

TYPE A NUMBER 1 TO 6 FOR FUNCTION DESIRED

?

3

```
X =  
?  
.00055  
TANH - 1 .00055 = .00055  
TYPE 1 TO CONTINUE, 0 TO STOP  
?  
1  
TYPE A NUMBER 1 TO 6 FOR FUNCTION DESIRED  
?  
4  
X =  
?  
23  
CSCH - 1 23 = .04346  
TYPE 1 TO CONTINUE, 0 TO STOP  
?  
1  
TYPE A NUMBER 1 TO 6 FOR FUNCTION DESIRED  
5  
X =  
?  
.125  
SECH - 1 .125 = 2.76866  
TYPE 1 TO CONTINUE, 0 TO STOP  
?  
1  
TYPE A NUMBER 1 TO 6 FOR FUNCTION DESIRED  
?  
6  
X =  
?  
8  
COTH - 1 8 = .12566  
TYPE 1 TO CONTINUE, 0 TO STOP  
?  
0  
*END
```

INVERSE HYPERBOLIC FUNCTIONS

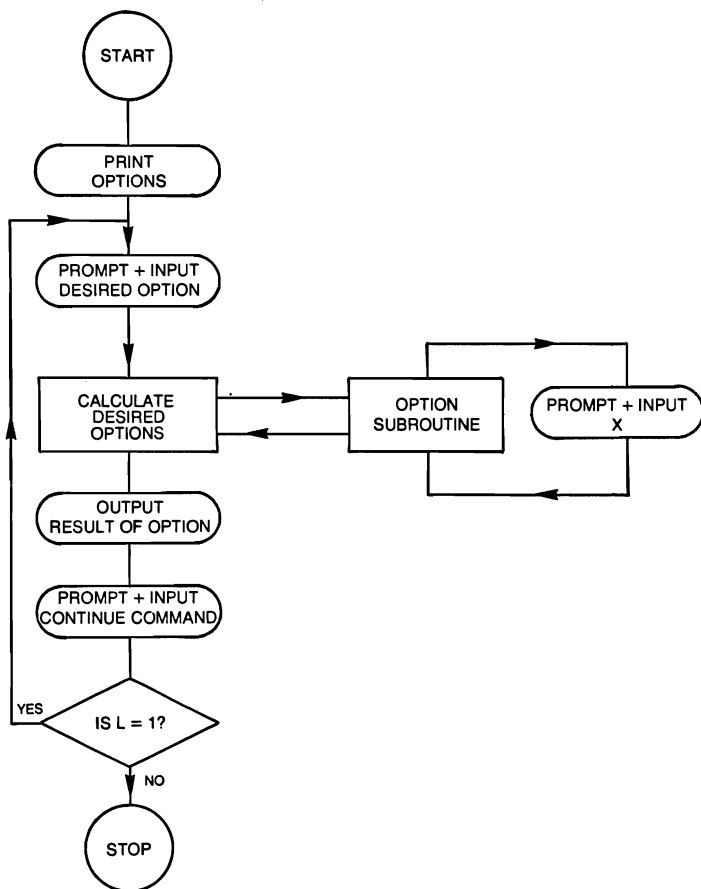

INVERSE HYPERBOLIC FUNCTIONS

```

10  REM THIS PROGRAM COMPUTES INVERSE HYPER-
    BOLIC FUNCTIONS
20  PRINT "SINH - 1 (1)"
30  PRINT "COSH - 1 (2)"
40  PRINT "TANH - 1 (3)"
50  PRINT "CSCH - 1 (4)"
60  PRINT "SECH - 1 (5)"
70  PRINT "COTH - 1 (6)"
  
```

```

80 PRINT "TYPE A NUMBER 1 TO 6 FOR FUNCTION
   DESIRED"
90 INPUT C
100 ON C GOTO 110,150,190,230,280,330
110 GOSUB 440
120 GOSUB 470
130 PRINT "SINH - 1";X;" = ";Z
140 GOTO 370
150 GOSUB 440
160 GOSUB 490
170 PRINT "COSH - 1";X;" = ";Z
180 GOTO 370
190 GOSUB 440
200 GOSUB 510
210 PRINT "TANH - 1";X;" = ";Z
220 GOTO 370
230 GOSUB 530
240 GOSUB 470
250 LET X = A
260 PRINT "CSCH - 1";X;" = ";Z
270 GOTO 370
280 GOSUB 530
290 GOSUB 490
300 LET X = A
310 PRINT "SECH - 1";X;" = ";Z
320 GOTO 370
330 GOSUB 530
340 GOSUB 510
350 LET X = A
360 PRINT "COTH - 1";X;" = ";Z
370 PRINT
380 PRINT "TYPE 1 TO CONTINUE, 0 TO STOP"
390 INPUT L
400 IF L = 1 THEN 420
410 STOP
420 PRINT
430 GOTO 80
440 PRINT "X = ";
450 INPUT X
460 RETURN
470 LET Z = LOG(X + SQR((X↑2) + 1))
480 RETURN
490 LET Z = LOG(X + SQR((X↑2) - 1))

```

```
500 RETURN
510 LET Z = (LOG((1 + X/(1 - X)))/2
520 RETURN
530 PRINT "X = ";
540 INPUT X
550 LET A = X
560 LET X = 1/X
570 RETURN
580 END
```

L-PAD MINIMUM LOSS SYSTEM

In systems where two resistive stages must be coupled, a minimum loss L-pad can be used for matching. A typical application for this pad would be to couple inputs and outputs of audio circuits. The user inputs the two impedances Z_1 and Z_2 ; the program responds with the L-pad resistors R_1 and R_2 , and also the system loss in decibels.

FORMULAE

L PAD MIN LOSS

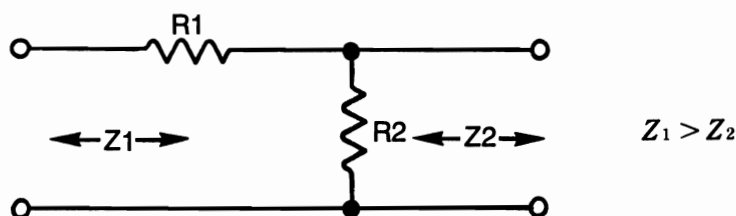

$$R_1 = Z_1 \sqrt{1 - \frac{Z_2}{Z_1}}$$

$$R_2 = \sqrt{\frac{Z_2}{1 - \frac{Z_2}{Z_1}}}$$

$$LOSS = 20 \log \left(\sqrt{\frac{Z_1}{Z_2}} + \sqrt{\frac{Z_1}{Z_2} - 1} \right)$$

EXAMPLE

1ST IMPEDANCE

?

300

2ND IMPEDANCE

?

75

COMPONENTS OF THE L-PAD

RESISTOR 1 = 259.807

RESISTOR 2 = 86.6025

LOSS IN DECIBELS = 11.4389

TYPE 1 TO CONTINUE, 0 TO STOP

?

0

*END

L-PAD MINIMUM LOSS SYSTEM

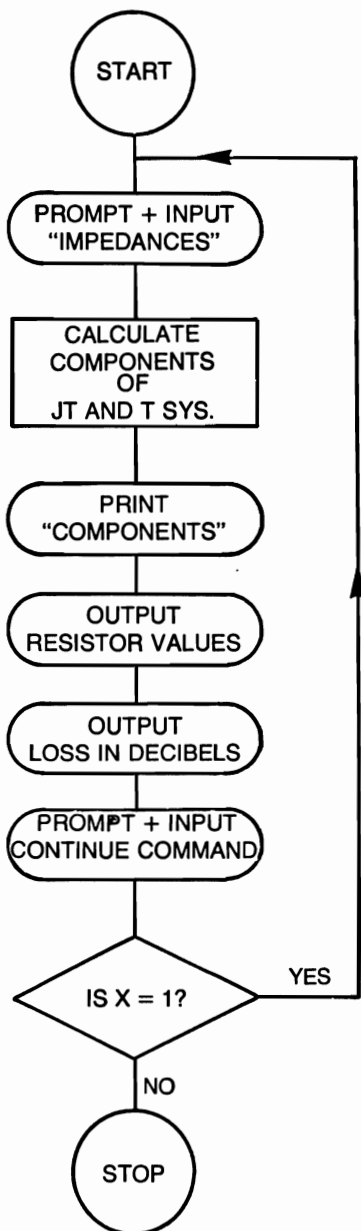

L-PAD MINIMUM LOSS SYSTEM

```
10  REM THIS PROGRAM COMPUTES THE VALUES OF
20  REM THE TWO RESISTANCES REQUIRED TO CON-
    STRUCT A
30  REM L-PAD OF MINIMUM LOSS
40  PRINT "1ST IMPEDANCE"
50  INPUT Z1
60  PRINT "2ND IMPEDANCE"
70  INPUT Z2
80  LET R1 = Z1*SQR(1 - (Z2/Z1))
90  LET R2 = Z2/SQR(1 - (Z2/Z1))
100 LET M = SQR(Z1/Z2) + SQR((Z1/Z2) - 1)
110 LET L = 20*(LOG(M)/LOG(10))
120 PRINT "COMPONENTS OF THE L-PAD"
130 PRINT "RESISTOR 1 = ";R1
140 PRINT "RESISTOR 2 = ";R2
150 PRINT "LOSS IN DECIBELS = ";L
160 PRINT
170 PRINT "TYPE 1 TO CONTINUE, 0 TO STOP"
180 INPUT X
190 IF X = 1 THEN 210
200 STOP
210 PRINT
220 GOTO 40
230 END
```

LINEAR INTERPOLATION

If Y is a function of X , and $Y_1 - Y_2$ are the values of the function at $X_1 - X_2$, respectively, Y may be computed for any value of X .

FORMULA

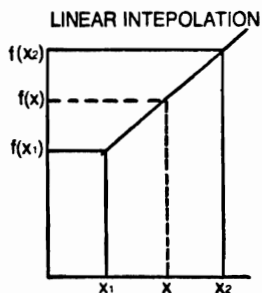

$$f(x) \cong \frac{(x_2 - x)(f(x_1)) + (x - x_1)(f(x_2))}{x_2 - x_1}$$

EXAMPLE

KNOWN VALUE OF X (X1,X2) =

?

10,50

KNOWN VALUES OF Y (F(X1),F(X2)) =

?

15,55

INTERPOLATE F(X) AT X =

?

60

INTERPOLATED F(X) = 65

TYPE 1 TO CONTINUE, 0 TO STOP

?

1

KNOWN VALUE OF X (X1,X2) =

?

43,98

KNOWN VALUES OF Y (F(X1), F(X2)) =

?

86,196

INTERPOLATE F(X) AT X =

?

1234

INTERPOLATED F(X) = 2468

TYPE 1 TO CONTINUE, 0 TO STOP

?

0

*END

LINEAR INTERPOLATION

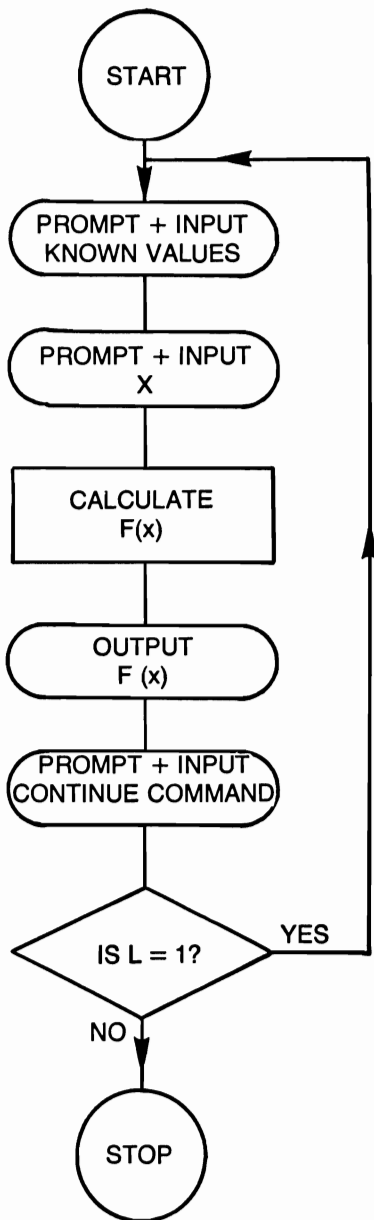

LINEAR INTERPOLATION

```
10  REM THIS PROGRAM COMPUTES LINEAR INTER-
    POLATION
20  PRINT "KNOWN VALUE OF X (X1,X2) = ";
30  INPUT X1,X2
40  PRINT "KNOWN VALUES OF Y (F(X1),F(X2)) = ";
50  INPUT Y1,Y2
60  PRINT "INTERPOLATE F(X) AT X = ";
70  INPUT X
80  LET G = ((X2 - X)*Y1) + ((X - X1)*Y2)
90  LET F = G/(X2 - X1)
100 PRINT "INTERPOLATED F(X) = ";F
110 PRINT
120 PRINT "TYPE 1 TO CONTINUE, 0 TO STOP"
130 INPUT L
140 IF L = 1 THEN 160
150 STOP
160 PRINT
170 GOTO 20
180 END
```

LOGARITHMS OF ANY BASE

This simple program allows the user to compute the value of a logarithm to any base. The number X and the base Y must both be positive if machine error is not to occur.

FORMULA

$$\log_y x = \frac{\ln x}{\ln y}$$

EXAMPLES

BASE =

?

16

X =

?

54

LOG 54 = 1.43872

TYPE 1 TO CONTINUE, 0 TO STOP

?

1

BASE =

?

567

X =

?

23

LOG 23 = .494529

TYPE 1 TO CONTINUE, 0 TO STOP

?

0

*END

LOGARITHMS OF ANY BASE

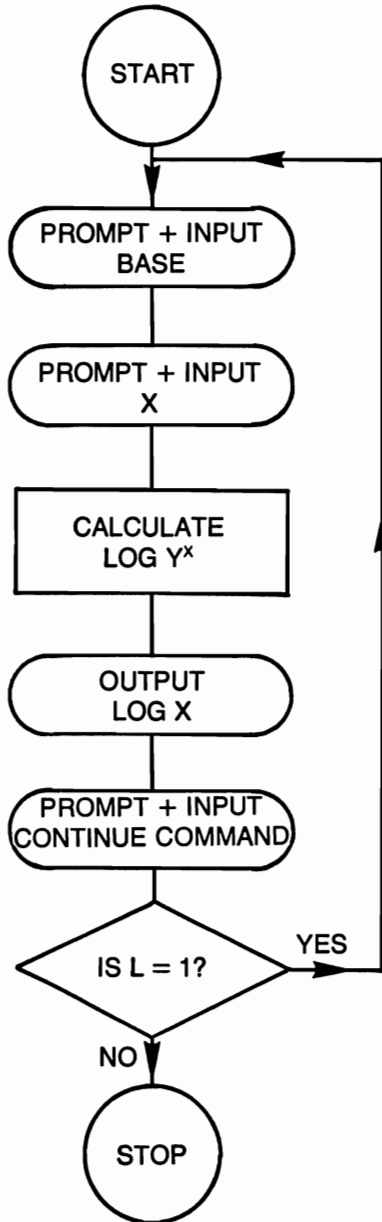

LOGARITHMS OF ANY BASE

```
10  REM THIS PROGRAM WILL COMPUTE THE LOG
20  REM OF ANY POSITIVE NUMBER X, TO ANY POSI-
    TIVE
30  REM BASE Y
40  PRINT "BASE = "
50  INPUT Y
60  PRINT "X = "
70  INPUT X
80  LET J = LOG(X)/LOG(Y)
90  PRINT "LOG";X;" = ";J
100 PRINT "TYPE 1 TO CONTINUE, 0 TO STOP"
110 INPUT L
120 IF L = 1 THEN 140
130 STOP
140 PRINT
150 GOTO 40
160 END
```

MEAN, STANDARD DEVIATION, STANDARD ERROR FOR GROUPED DATA

This program generates the mean, standard deviation and standard error for grouped data until the user enters a 0 for the value of the frequency.

FORMULAE

$$\text{Mean } \bar{x} = \frac{\sum f_i x_i}{\sum f_i}$$

$$\text{Standard error } S_{\bar{x}} = \frac{S}{\sqrt{\sum f_i}}$$

$$\text{Standard deviation } S = \frac{\sqrt{\sum f_i x_i^2 - (\sum f_i) \bar{x}^2}}{\sum f_i - 1}$$

EXAMPLE

ENTER SAMPLE VALUE AND FREQUENCY

?

5,2

ENTER SAMPLE VALUE AND FREQUENCY

?

10,3

ENTER SAMPLE VALUE AND FREQUENCY

?

6,1

ENTER SAMPLE VALUE AND FREQUENCY

?

0,0

NUMBER OF SAMPLES ENTERED = 3

MEAN = 7.67

STANDARD DEVIATION = 5.77

STANDARD ERROR = 2.36

TYPE 1 TO CONTINUE, 0 TO STOP

?

0

*END

MEAN, STANDARD DEVIATION, AND
STANDARD ERROR FOR GROUPED DATA

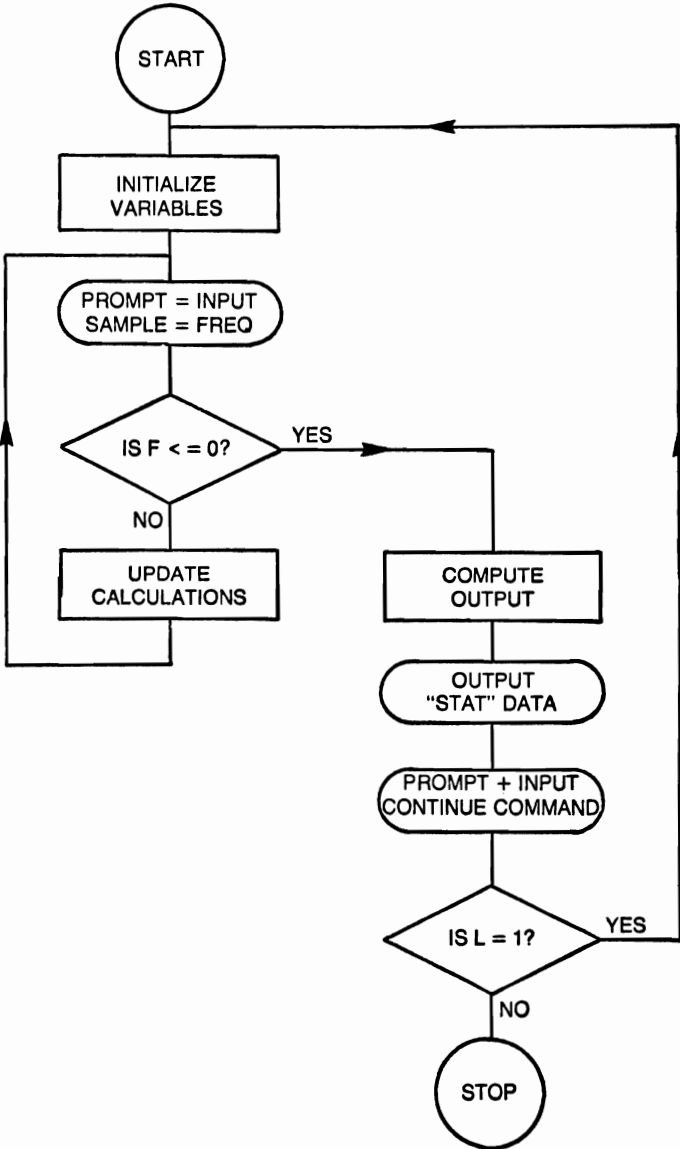

**MEAN, STANDARD DEVIATION, AND
STANDARD ERROR FOR GROUPED DATA**

```
10  REM THIS PROGRAM COMPUTES THE MEAN,  
    STANDARD  
20  REM DEVIATION AND STANDARD ERROR FOR  
    GROUPED DATA  
30  LET A = 0  
40  LET B = 0  
50  LET C = 0  
60  LET D = 0  
70  PRINT "ENTER SAMPLE VALUE AND FREQUENCY";  
80  INPUT X,F  
90  IF F <= 0 THEN 170  
100 LET A = A + 1  
110 LET B = B + F  
120 LET G = X*F  
130 LET C = C + G  
140 LET E = (X2)*F  
150 LET D = D + E  
160 GOTO 70  
170 LET H = C/B  
180 LET I = SQR(D - (B*(H2)))  
190 LET J = I/SQR(B)  
200 PRINT  
210 PRINT "NUMBER OF SAMPLES ENTERED = ";A  
220 PRINT "MEAN = ";H  
230 PRINT "STANDARD DEVIATION = ";I  
240 PRINT "STANDARD ERROR = ";J  
250 PRINT  
260 PRINT "TYPE 1 TO CONTINUE, 0 TO STOP"  
270 INPUT L  
280 IF L = 1 THEN 300  
290 STOP  
300 PRINT  
310 GOTO 30  
320 END
```

MOMENTS, SKEWNESS AND KURTOSIS

This program computes the first four moments where the first moment is the mean of the distribution and the second moment is the variance. Skewness is the departure of a frequency distribution from symmetry, and kurtosis is a property of distribution that expresses its relative peakedness.

FORMULAE

$$1^{\text{ST}}M = \bar{x} = \frac{1}{n} \sum_{i=1}^n x_i$$

$$2^{\text{ND}} M = M_2 = \frac{1}{n} \sum x_i^2 - \bar{x}^2$$

$$3^{\text{RD}}M = M_3 = \frac{1}{n} \sum x_i^3 - \frac{3}{n} \bar{x} \sum x_i^2 + 2\bar{x}^3$$

$$4^{\text{TH}}M = M_4 = \frac{1}{n} \sum x_i^4 - \frac{4}{n} \bar{x} \sum x_i^3 + \frac{6}{n} \bar{x}^2 \sum x_i^2 - 3\bar{x}^4$$

$$\text{SKEWNESS} = \gamma_1 = \frac{M_3}{M_2^{3/2}}$$

$$\text{KURTOSIS} \gamma_2 = \frac{M_4}{M_2^2}$$

EXAMPLE

NUMBER OF SAMPLES =

?

5

SAMPLE =

?

12

SAMPLE =

?

3

SAMPLE =

?

4

SAMPLE =

?

5

SAMPLE =

?

4

1ST MOMENT = 5.6

2ND MOMENT = 10.64

3RD MOMENT = 47.2319

4TH MOMENT = 347.331

MOMENT COEFFICIENTS

SKEWNESS = 1.36089 KURTOSIS = 3.06803

TYPE 1 TO CONTINUE, 0 TO STOP

?

0

*END

MOMENTS, SKEWNESS, AND KURTOSIS

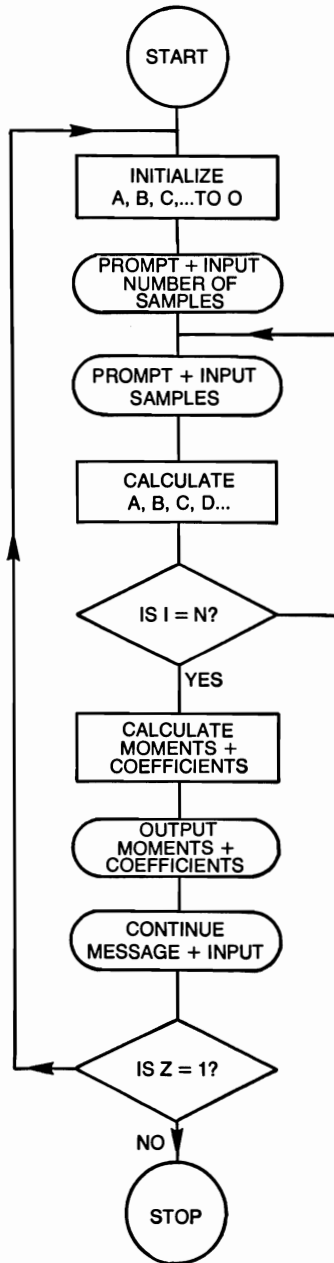

MOMENTS, SKEWNESS, AND KURTOSIS

```
10  REM THIS PROGRAM COMPUTES THE VALUES OF
    THE
20  REM FIRST 4 MOMENTS, SKEWNESS AND KUR-
    TOSIS
30  LET A = 0
40  LET B = 0
50  LET C = 0
60  LET D = 0
70  PRINT "NUMBER OF SAMPLES = "
80  INPUT N
90  FOR I = 1 TO N
100 PRINT "SAMPLE = "
110 INPUT X
120 LET A = A + X
130 LET B = B + (X↑2)
140 LET C = C + (X↑3)
150 LET D = D + (X↑4)
160 NEXT I
170 LET J = A/N
180 LET E = (B/N) - (J↑2)
190 LET F = (C/N) - ((3*J*B)/N) + (2*(J↑3))
200 LET G = (D/N) - ((4*J*C)/N)
210 LET H = G + ((6*(J↑2)*B)/N) - (3*(J↑4))
220 LET K = F/(E↑(3/2))
230 LET L = H/(E↑2)
240 PRINT "1ST MOMENT = ";J
250 PRINT "2ND MOMENT = ";E
260 PRINT "3RD MOMENT = ";F
270 PRINT "4TH MOMENT = ";H
280 PRINT "MOMENT COEFFICIENTS"
290 PRINT "SKEWNESS = ";K,"KURTOSIS = ";L
300 PRINT"*****"
310 PRINT "TYPE 1 TO CONTINUE, 0 TO STOP"
320 INPUT Z
330 IF Z = 1 THEN 350
340 STOP
350 PRINT
360 GOTO 30
370 END
```

NO REPETITIONS PROBABILITY

The user dictates the size of a population to be determined for a "No Repetitions" probability.

FORMULA

$$P = \left(1 - \frac{1}{M}\right) \left(1 - \frac{2}{M}\right) \dots \left(1 - \frac{N-1}{M}\right)$$

where $M \geq N \geq 1$

EXAMPLE

TOTAL POPULATION

?

56

SIZE OF SAMPLE

?

2

PROBABILITY = .982143

TYPE 1 TO CONTINUE, 0 TO STOP

?

1

TOTAL POPULATION

?

9

SIZE OF SAMPLE

?

4

PROBABILITY = .460905

TYPE 1 TO CONTINUE, 0 TO STOP

?

0

*END

NO REPETITIONS PROBABILITY

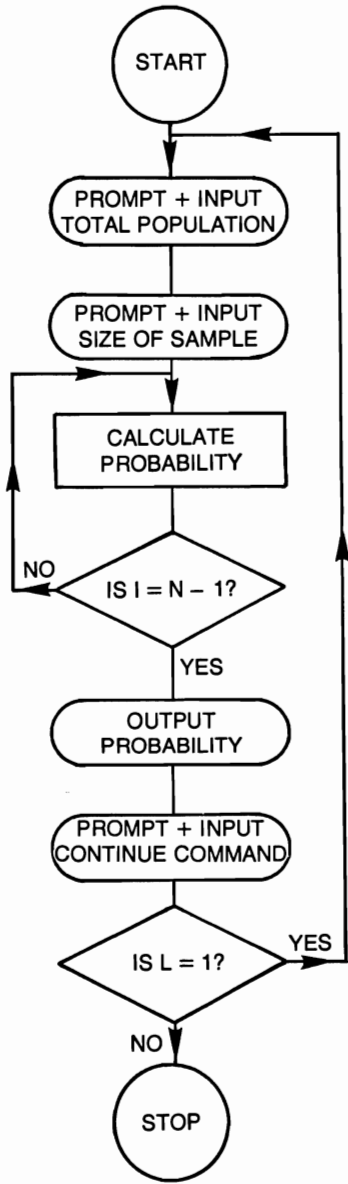

NO-REPETITIONS PROBABILITY

```
10  REM THIS PROGRAM COMPUTES THE "NO REP-
    ETITIONS"
20  REM PROBABILITY OF A SAMPLE
30  PRINT "*****"
35  PRINT "TOTAL POPULATION"
40  INPUT M
50  PRINT "SIZE OF SAMPLE"
60  INPUT N
70  LET J = 1
80  FOR I = 1 TO N - 1
90  LET K = 1 - (I/M)
100 LET J = J*K
110 NEXT I
120 PRINT "PROBABILITY = ";J
130 PRINT
140 PRINT "TYPE 1 TO CONTINUE, 0 TO STOP"
150 INPUT L
160 IF L = 1 THEN 30
170 STOP
180 END
```

NUMBER GUESS GAME

The object of this game is to guess in as few tries as possible the number chosen at random by the computer. (Hint: Use a binary search pattern.)

EXAMPLE

A RANDOM NUMBER HAS BEEN PICKED
TRY GUESSING IT, HINT THE NUMBER
IS FROM 1 TO 100
GOOD LUCK!!!
YOUR GUESS IS =
?
50
TOO HIGH, TRY AGAIN
YOUR GUESS IS =
?
25
TOO HIGH, TRY AGAIN
YOUR GUESS IS =
?
12
TOO LOW, TRY AGAIN
YOUR GUESS IS =
?
18
TOO LOW, TRY AGAIN
YOUR GUESS IS =
?
20
NOT BAD!!!-YOU GOT IT!!!
YOUR NUMBER OF TRIES WERE 5
IF YOU WANT TO TRY AGAIN TYPE 1
IF NOT TYPE 0
?
0
*END

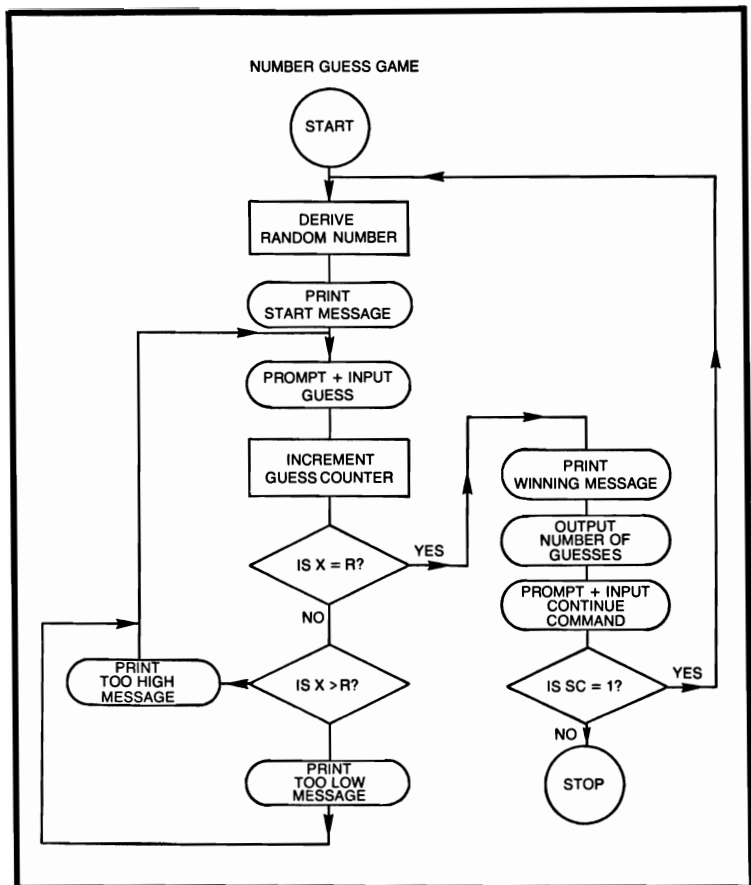

NUMBER GUESS GAME

```

10  REM THE COMPUTER CHOOSES A NUMBER FROM
20  REM 1 TO 100 AT RANDOM, THE OBJECT OF
30  REM THE GAME IS TO GUESS THE CHOSEN
40  REM NUMBER IN AS FEW GUESSES AS POSSIBLE
50  LET R = 1 + INT(100*RND)
60  LET Y = 0
70  PRINT "A RANDOM NUMBER HAS BEEN PICKED"
80  PRINT "TRY GUESSING IT, HINT THE NUMBER"
90  PRINT "IS FROM 1 TO 100"
100 PRINT "GOOD LUCK!!!"
110 PRINT
120 PRINT "YOUR GUESS IS = ";
130 INPUT X
  
```

```
140 LET Y = Y + 1
150 IF X = R THEN 180
160 IF X > R THEN 280
170 GOTO 300
180 PRINT "NOT BAD!!!-YOU GOT IT!!!"
190 PRINT "YOUR NUMBER OF TRIES WERE";Y
200 PRINT
210 PRINT "IF YOU WANT TO TRY AGAIN, TYPE 1"
220 PRINT "IF NOT TYPE 0"
230 INPUT L
240 IF L = 1 THEN 260
250 STOP
260 PRINT
270 GOTO 50
280 PRINT "TOO HIGH, TRY AGAIN"
290 GOTO 120
300 PRINT "TOO LOW, TRY AGAIN"
310 GOTO 120
320 END
```

ONE-ARM BANDIT

This computer program simulates the one-arm bandits that use three mechanical wheels. For detailed instructions, type yes to the instruction question in the program.

EXAMPLE

RUN

ARE INSTRUCTIONS REQUIRED

TYPE EITHER YES OR NO

?

NO

CHERRY CHERRY CHERRY

YOUR TOTAL EARNINGS ARE NOW \$89

TO CONTINUE TYPE Y, IF NOT TYPE N

?

N

ONE-ARM BANDIT SAYS GOOD-BYE

*END

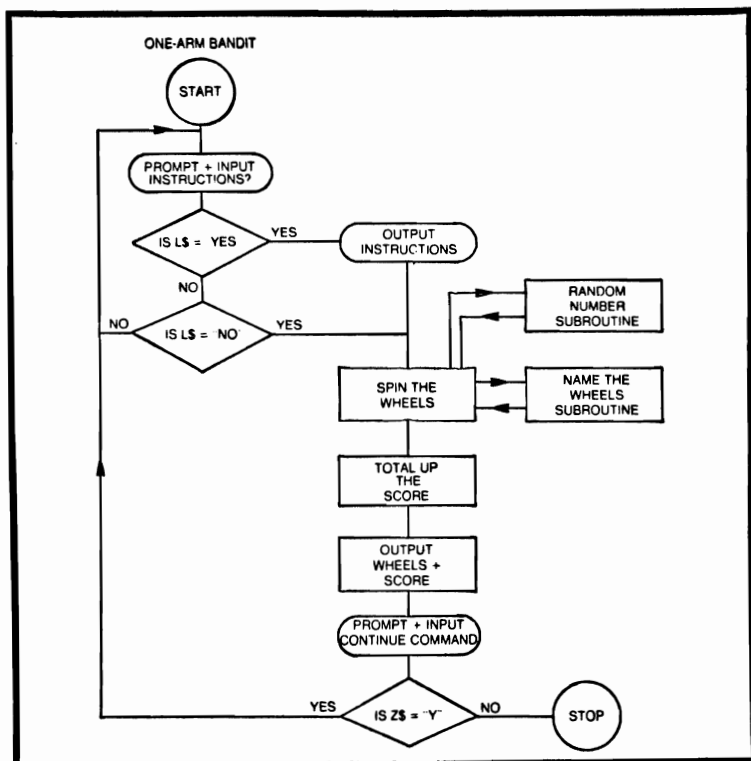

ONE-ARM BANDIT

```
10  REM THIS PROGRAM SIMULATES THE MECHANICAL
    CAL
20  REM THREE WHEEL ONE-ARM BANDIT
30  PRINT "ARE INSTRUCTIONS REQUIRED"
40  PRINT "TYPE EITHER YES OR NO"
50  INPUT L$
60  IF L$ = "YES" THEN 100
70  IF L$ = "NO" THEN 170
80  PRINT "INVALID COMMAND"
90  GOTO 30
100 PRINT "SCORING IS SIMPLE; 3 ORANGES, LEMONS OR"
110 PRINT "BANANAS EARN $10. 3 CHERRIES EARN $90."
120 PRINT "IF THE FIRST FRUIT IS AN APPLE YOU EARN $2"
130 PRINT "IF THE 1ST AND 2ND ARE APPLES YOU EARN $3"
140 PRINT "IF THE LAST FRUIT IS A CHERRY AND THE"
150 PRINT "OTHER TWO ARE THE SAME BUT NOT APPLES YOU"
160 PRINT "EARN $10. EACH TURN COSTS $1. GOODLUCK"
170 LET J = 0
180 PRINT
190 GOSUB 590
200 LET S1 = S
210 GOSUB 590
220 LET S2 = S
230 GOSUB 590
240 LET S3 = S
250 LET S = S1
260 GOSUB 610
270 LET S1$ = S$
280 LET S = S2
290 GOSUB 610
300 LET S2$ = S$
310 LET S = S3
320 GOSUB 610
330 LET S3$ = S$
340 IF S1$ = "CHERRY" THEN 380
350 IF S1$ = "APPLE" THEN 420
```

```

360 IF S1$ = S2$ THEN 440
370 GOTO 460
380 IF S1$ = S2$ THEN 400
390 GOTO 460
400 IF S2$ = S3$ THEN 480
410 GOTO 460
420 IF S1$ = S2$ THEN 500
430 GOTO 520
440 IS S2$ = S3$ THEN 540
450 IF S3$ = "CHERRY" THEN 540
460 LET J = J - 1
470 GOTO 550
480 LET J = J + 89
490 GOTO 550
500 LET J = J + 2
510 GOTO 550
520 LET J = J + 1
530 GOTO 550
540 LET J = J + 9
550 PRINT
560 PRINT S1$," ";S2$," ";S3$
570 PRINT "YOUR TOTAL EARNINGS ARE NOW $";J
580 GOTO 720
590 LET S = 1 + INT(5*RND)
600 RETURN
610 ON S GOTO 620, 640, 660, 680, 700
620 LET S$ = "CHERRY"
630 GOTO 710
640 LET S$ = "APPLE"
650 GOTO 710
660 LET S$ = "LEMON"
670 GOTO 710
680 LET S$ = "ORANGE"
690 GOTO 710
700 LET S$ = "BANANA"
710 RETURN
720 PRINT
730 PRINT "TO CONTINUE TYPE Y, IF NOT TYPE N"
740 INPUT Z$
750 IF Z$ = "Y" THEN 780
760 PRINT "ONE-ARM BANDIT SAYS GOOD-BYE"
770 STOP
780 PRINT
790 GOTO 190
800 END

```

PERMUTATIONS AND COMBINATIONS

This program computes permutations and combinations, where N is the number of items available and R is the size of the groups under consideration.

FORMULAE

$$P = \frac{N!}{(N - R)!}$$

$$C = \frac{N!}{R!(N - R)!}$$

EXAMPLE

ENTER N,R

?

12,5

PERMUTATIONS = 95040

COMBINATIONS = 792

TYPE 1 TO CONTINUE, 0 TO STOP

?

1

ENTER N,R

?

23,21

PERMUTATIONS = 1.2926E22

COMBINATIONS = 253

TYPE 1 TO CONTINUE, 0 TO STOP

?

0

*END

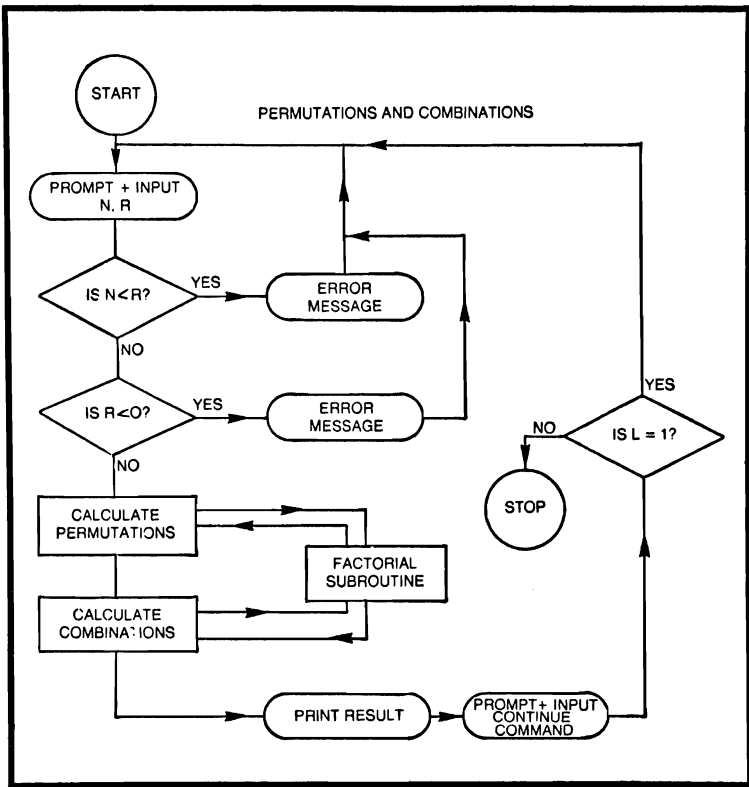

PERMUTATIONS AND COMBINATIONS

```

10  REM THIS PROGRAM COMPUTES PERMUTATIONS
20  REM AND COMBINATIONS, WHERE N = NUMBER
    OF
30  REM ITEMS AND R = SIZE OF GROUP SELECTED
40  PRINT "ENTER N,R";
50  INPUT N,R
60  IF N < R THEN 270
70  IF R < 0 THEN 290
80  LET T = N
90  GOSUB 310
100 LET A = T
110 LET T = N - R
120 GOSUB 310
130 LET B = T
140 LET P = A/B
150 LET T = R
  
```

```
160 GOSUB 310
170 LET C = A/(T*B)
180 PRINT "PERMUTATIONS = ";P
190 PRINT "COMBINATIONS = ";C
200 PRINT
210 PRINT "TYPE 1 TO CONTINUE, 0 TO STOP"
220 INPUT L
230 IF L = 1 THEN 250
240 STOP
250 PRINT
260 GOTO 40
270 PRINT "N < R,INVALID INPUT"
280 GOTO 40
290 PRINT "R < 0,INVALID INPUT"
300 GOTO 40
310 IF T = 0 THEN 390
320 IF T = 1 THEN 390
330 LET J = 1
340 FOR I = 2 TO T
350 LET J = J*I
360 NEXT I
370 LET T = J
380 GOTO 400
390 LET T = 1
400 RETURN
410 END
```

PI-NETWORK IMPEDANCE MATCHING

Often between two resistive impedances Z_1 and Z_2 a lossless network is desired. The computer expects the following information: $Z_1 - Z_2$, desired system Q and the operating frequency.

FORMULAE

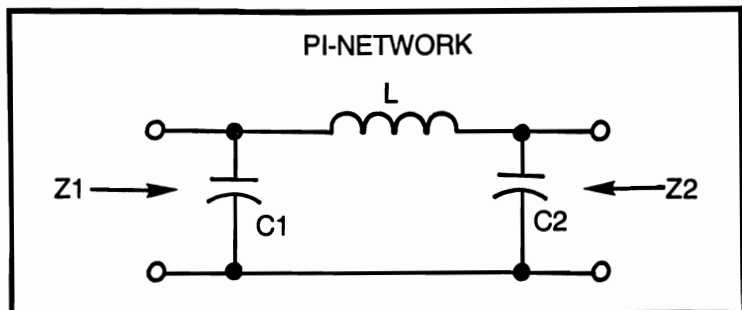

$Z_1 > Z_2$, f = frequency and Q is desired system Q

$$C_1 = \frac{1}{2\pi f X_{C1}} \quad C_2 = \frac{1}{2\pi f X_{C2}} \quad L = \frac{X_L}{2\pi f} \quad \frac{Z_2}{Z_1} (Q^2 + 1) > 1$$

and where

$$X_{C1} = \frac{Z_1}{Q}, \quad X_{C2} = \frac{Z_2}{\left(\frac{Z_2}{Z_1} (Q^2 + 1) - 1\right)^5}$$

$$X_L = \frac{QZ_1}{Q^2 + 1} \left(1 + \frac{Z_2}{QX_{C2}}\right)$$

EXAMPLE

ENTER 1ST IMPEDANCE

?

345

ENTER 2ND IMPEDANCE

?

300

ENTER DESIRED SYSTEM Q

?

20

```

ENTER OPERATING FREQUENCY
?
500
COMPONENTS OF PI-NETWORK
CAPACITOR 1 = 1.84527 E - 5
CAPACITOR 2 = 1.97846 E - 5
INDUCTOR = 1.05836 E - 2
TO CONTINUE TYPE 1, IF NOT 0
?
0
*END

```

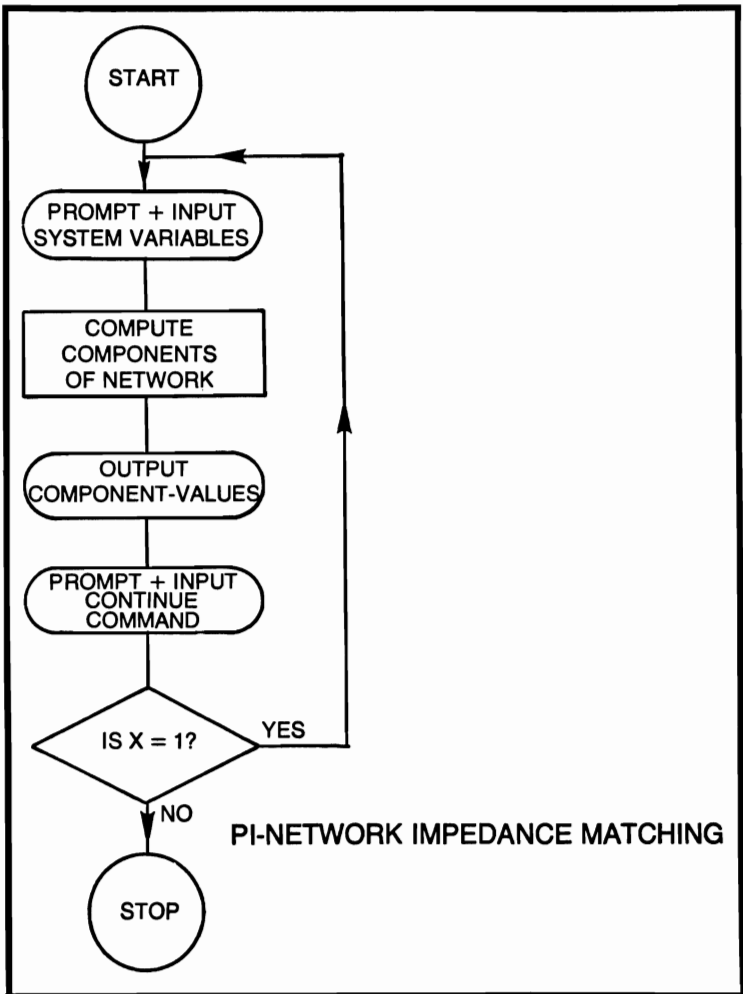

PI-NETWORK IMPEDANCE MATCHING

```
10  REM THIS PROGRAM COMPUTES THE COMPO-
    NENTS
20  REM OF A PI-NETWORK. TO MATCH TWO
30  REM IMPEDANCES
40  PRINT "ENTER 1ST IMPEDANCE"
50  INPUT Z1
60  PRINT "ENTER 2ND IMPEDANCE"
70  INPUT Z2
80  PRINT "ENTER DESIRED SYSTEM Q"
90  INPUT Q
100 PRINT "ENTER OPERATING FREQUENCY"
110 INPUT A
120 LET A = Z1/Q
130 LET C = ((Z2/Z1)*((Q↑2) + 1)) - 1
140 LET B = Z2/SQR(C)
150 LET E = (Z2/(Q*B)) + 1
160 LET D = E*((Q*Z1)/((Q↑2) + 1))
170 LET P = 6.28319
180 LET C1 = 1/(P*F*A)
190 LET C2 = 1/(P*F*B)
200 LET L = D/(P*F)
210 PRINT "COMPONENTS OF PI-NETWORK"
220 PRINT "CAPACITOR 1 = ";C1
230 PRINT "CAPACITOR 2 = ";C2
240 PRINT "INDUCTOR = ";L
250 PRINT
260 PRINT " TO CONTINUE TYPE 1, IF NOT 0"
270 INPUT X
280 IF X = 1 THEN 300
290 STOP
300 PRINT
310 GOTO 40
320 END
```

POINTS ON THE CIRCUMFERENCE

This program computes N equally spaced points on the circumference of a circle. Given radius and center of the circle, this program computes the rectangular coordinates of equally spaced points X_i, Y_i .

FORMULAE

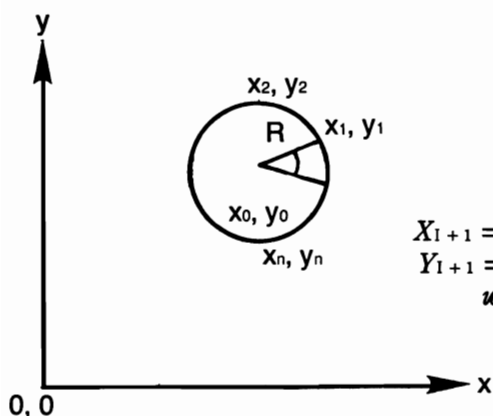

$$\begin{aligned} X_{i+1} &= X_0 + R \cos(\Theta + Zi) \\ Y_{i+1} &= Y_0 + R \sin(\Theta + Zi) \\ \text{where } Z &= 2\pi / N \end{aligned}$$

POINTS ON A CIRCUMFERENCE

EXAMPLE

CENTER OF CIRCLE(X_0, Y_0) =

?

2,2

ANGLE IN DEGREES OF FIRST POINT =

?

90

NUMBER OF POINTS DESIRED =

?

2

RADIUS OF CIRCLE =

?

1

COORDINATES

POINT 1 $X = 3$ $Y = 2$

POINT 2 $X = 2$ $Y = 1$

POINTS ON THE CIRCUMFERENCE

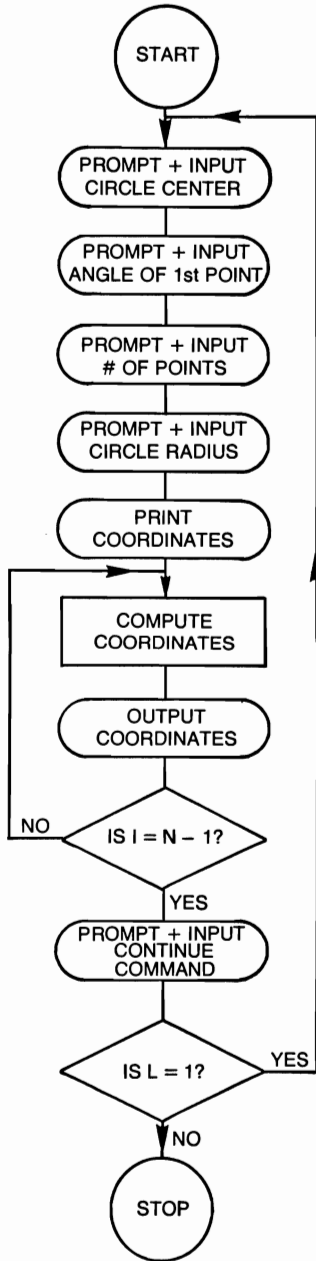

POINTS ON THE CIRCUMFERENCE

```
10  REM THIS PROGRAM COMPUTES N EQUALLY
    SPACED
20  REM POINTS ON THE CIRCUMFERENCE OF A
    CIRCLE
30  PRINT "CENTER OF CIRCLE (X0,Y0) = ";
40  INPUT X0,Y0
50  PRINT "ANGLE IN DEGREES OF 1ST POINT = ";
60  INPUT W
70  LET W = (W*3.14159)/180
80  PRINT "NUMBER OF POINTS DESIRED = ";
90  INPUT N
100 PRINT "RADIUS OF A CIRCLE = ";
110 INPUT R
120 LET Z = 6.28319/N
130 PRINT
140 PRINT "COORDINATES"
150 FOR I = 0 TO N - 1
160 LET X = X0 + (R*COS(W + Z*I))
170 LET Y = Y0 + (R*SIN(W + (Z*I)))
180 LET P = I + 1
190 PRINT "POINT;";P,"X = ";X,"Y = ";Y
200 NEXT I
210 PRINT
220 PRINT "TYPE 1 TO CONTINUE, 0 TO STOP"
230 INPUT L
240 IF L = 1 THEN 260
250 STOP
260 PRINT
270 GOTO 30
280 END
```

POLAR TO RECTANGULAR CONVERSION

This program converts given polar coordinates into rectangular coordinates.

FORMULAE

POLAR TO RECTANGULAR

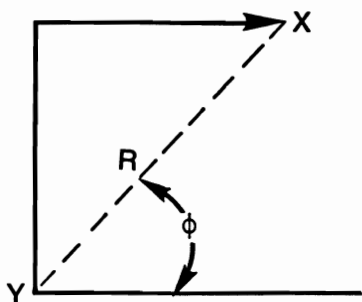

$$X = R \cos \phi$$

$$Y = R \sin \phi$$

EXAMPLE

POLAR COORDINATES

ANGLE W IN DEGREES =

?

45

MAGNITUDE R =

?

5

RECTANGULAR COORDINATES

X = 3.53553 Y = 3.53553

TYPE 1 TO CONTINUE, 0 TO STOP

?

POLAR COORDINATES

ANGLE W IN DEGREES =

?

20

MAGNITUDE R =

?

1

RECTANGULAR COORDINATES

X = .939693 Y = .34202

TYPE 1 TO CONTINUE, 0 STOP

?

0

*END

POLAR TO RECTANGULAR CONVERSION

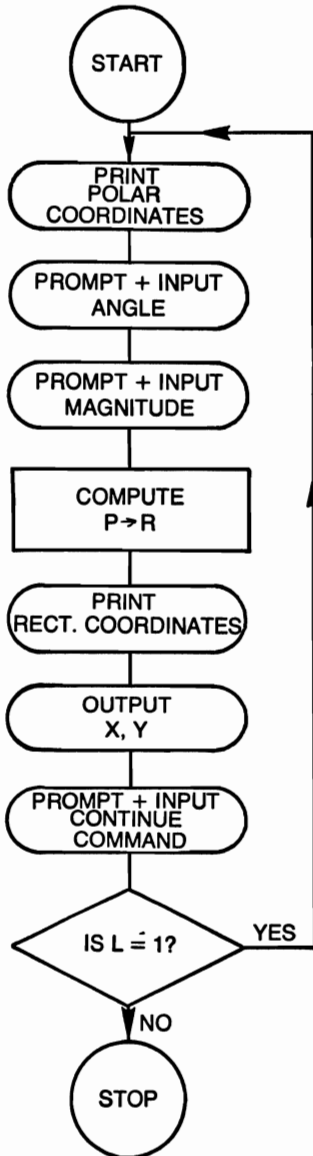

POLAR TO RECTANGULAR CONVERSION

```
10  REM THIS PROGRAM CONVERTS GIVEN POLAR
    COORDINATES
20  REM INTO RECTANGULAR COORDINATES
30  PRINT "POLAR COORDINATES"
40  PRINT "ANGLE W IN DEGREES = ";
50  INPUT W
60  LET W = (W*3.14159)/180
70  PRINT "MAGNITUDE R = ";
80  INPUT R
90  LET X = R*COS(W)
100 LET Y = R*SIN(W)
110 PRINT "RECTANGULAR COORDINATES"
120 PRINT "X = ";X,"Y = ";Y
130 PRINT
140 PRINT "TYPE 1 TO CONTINUE, 0 TO STOP"
150 INPUT L
160 IF L = 1 THEN 180
170 STOP
180 PRINT
190 GOTO 30
200 END
```

PRIME TEST

This program tests a given number to see whether or not it is prime. If so, it is thus indicated and if not, the smallest factor returned. The program will continue to cycle until a zero is entered as a test number.

EXAMPLES

```
ENTER THE TEST NUMBER,ZERO TO STOP
?
45
45 IS NOT A PRIME 3 IS THE SMALLEST FACTOR
ENTER THE TEST NUMBER,ZERO TO STOP
?
120078
120078 IS NOT A PRIME 2 IS THE SMALLEST FACTOR
ENTER THE TEST NUMBER,ZERO TO STOP
?
121
121 IS NOT A PRIME 11 IS THE SMALLEST FACTOR
ENTER THE TEST NUMBER,ZERO TO STOP
?
179
179 IS A PRIME
ENTER THE TEST NUMBER,ZERO TO STOP
?
0
GOOD-BYE FROM THE PRIME TESTER
*END
```

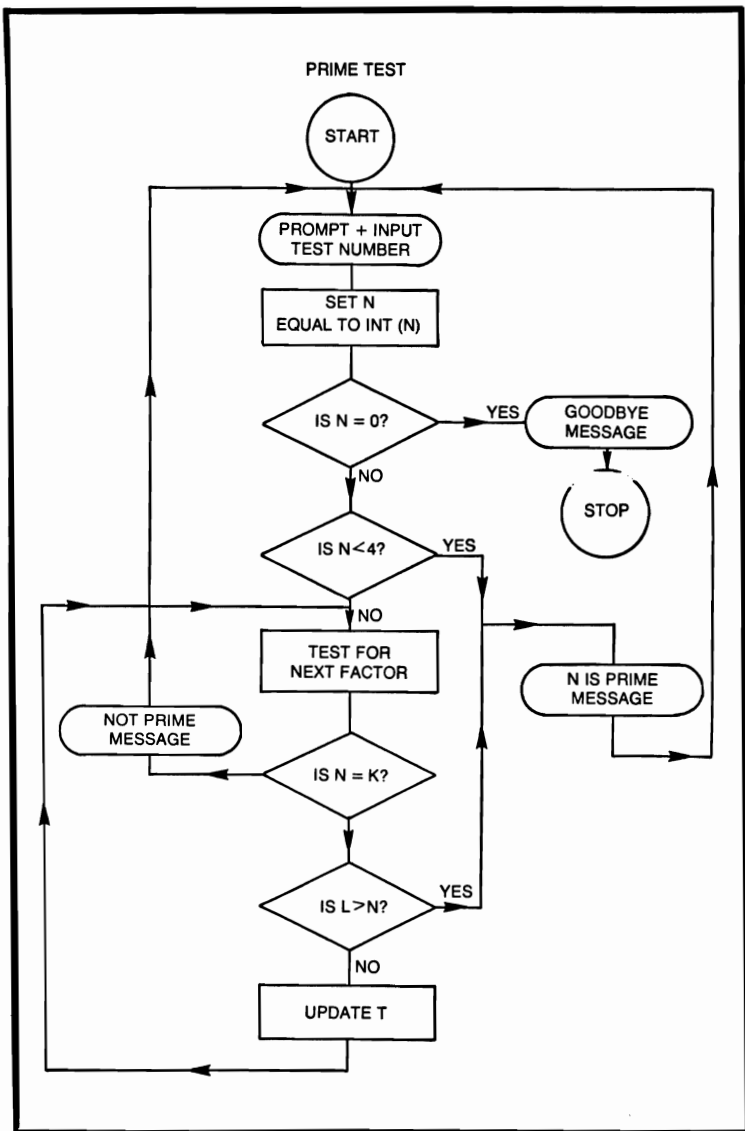

PRIME TESTER

```

10  REM THIS PROGRAM TESTS IF A NUMBER IS PRIME
20  REM IT CONTINUES TO CYCLE UNTIL ZERO IS EN-
    TERED
30  PRINT "ENTER THE TEST NUMBER, ZERO TO
    STOP"
  
```

```
40 INPUT N
50 LET N = INPUT (N)
60 IF N = 0 THEN 220
70 IF N < 4 THEN 180
80 LET I = 0
90 LET T = 2
100 LET J = INT(N/T)
110 LET K = J*T
120 IF N = K THEN 200
130 LET I = I + 1
140 LET L = T*T
150 IF L > N THEN 180
160 LET T = (I*2) + 1
170 GOTO 100
180 PRINT N; "IS A PRIME"
190 GOTO 30
200 PRINT N; "IS NOT A PRIME"; T; "IS THE SMALLEST
    FACTOR"
210 GOTO 30
220 PRINT "GOOD-BYE FROM THE PRIME TESTER"
230 END
```

QUADRATIC EQUATIONS

This program solves for x in a quadratic equation where a , b and c are given. Both real and complex roots are found.

FORMULAE

$$ax^2 + bx + c = \phi$$

$$x_1, x_2 = \frac{-b \pm \sqrt{b^2 - 4ac}}{2a}$$

$$D = (b^2 - 4ac)/4a^2$$

$D \geq \phi$ roots are real $D < \phi$ roots are complex

$$D \geq \phi$$

$$\text{IF } -\frac{b}{2a} \geq \phi \quad X_1 = -\frac{b}{2a} + \sqrt{D}$$

$$\text{IF } -\frac{b}{2a} < \phi \quad X_1 = -\frac{b}{2a} - \sqrt{D}$$

$$X_2 = \frac{C}{X_1 a}$$

$$D < 0$$

$$U + Vi = \frac{-b}{2a} \pm \frac{\sqrt{4ac - b^2}}{2a} i$$

EXAMPLES

ENTER VALUES FOR A,B AND C

?

1,1,0

ROOTS ARE REAL

1ST ROOT = - 1

2ND ROOT = 0

TYPE 1 TO CONTINUE, 0 TO STOP

?

1

ENTER VALUES FOR A,B AND C

?

10,10,10

ROOTS ARE COMPLEX

REAL PART = - 50

IMAGINARY PART = 86.6025

TYPE 1 TO CONTINUE, 0 TO STOP

?

0

*END

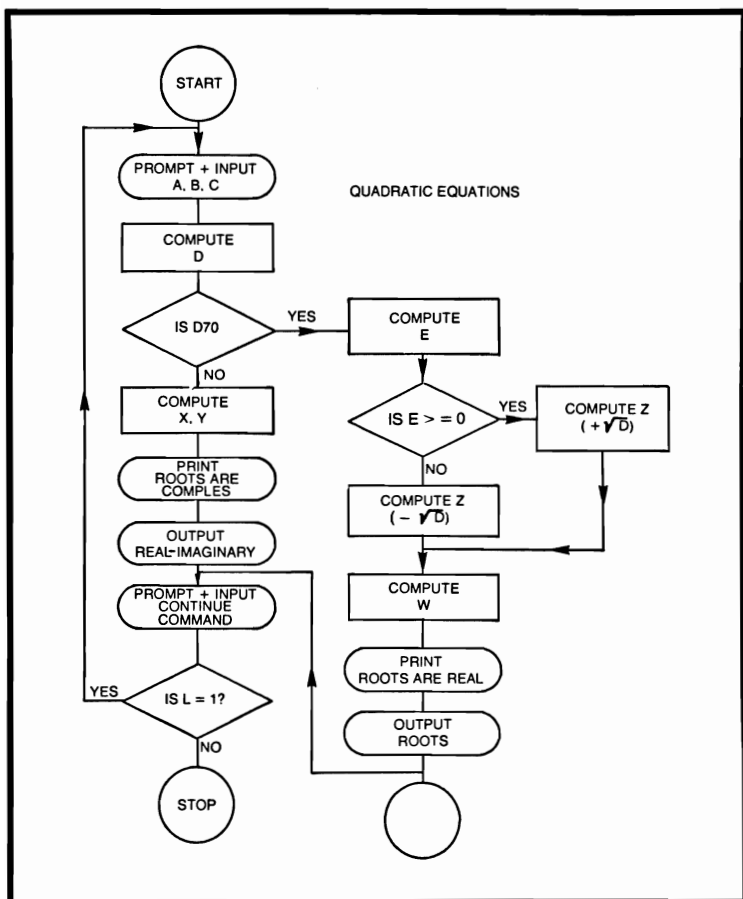

QUADRATIC EQUATION

```
10  REM THIS PROGRAM COMPUTES THE SOLUTION
    TO A
120  REM QUADRATIC EQUATION
130  PRINT "ENTER VALUES FOR A, B AND C"
140  INPUT A,B,C
150  LET D = ((B^2) - (4*A*C))/(4*A^2)
160  IF D >= 0 THEN 170
170  LET X = B/(2*A)
180  LET Y = (SQR((4*A*C) - B ^2))/(2*A)
190  PRINT "ROOTS ARE COMPLEX"
200  PRINT "REAL PART = ";X
210  PRINT "IMAGINARY PART = ";Y
220  GOTO 220
230  LET E = - B/(2*A)
240  IF E >= 0 THEN 170
250  LET Z = E - SQR(D)
260  GOTO 180
270  LET Z = E + SQR(D)
280  LET W = C/(Z*A)
290  PRINT "ROOTS ARE REAL"
300  PRINT 1ST ROOT = ";Z
310  PRINT "2ND ROOT = ";W
320  PRINT "*****"
330  PRINT "TYPE 1 TO CONTINUE, 0 TO STOP"
340  INPUT L
350  IF L = 1 THEN 270
360  STOP
370  PRINT
380  GOTO 30
390  END
```

RECTANGULAR TO POLAR CONVERSION

This program computes rectangular coordinates that are supplied by the user into polar coordinates.

FORMULAE

$$\phi = \text{TAN}^{-1} \frac{Y}{X} \quad R = \sqrt{X^2 + Y^2}$$

EXAMPLES

X =

?

10

Y =

?

10

POLAR COORDINATES

ANGLE IN DEGREES = 45.0000

MAGNITUDE = 14.1421

TYPE 1 TO CONTINUE, 0 TO STOP

?

1

X =

?

34

Y =

?

32

POLAR COORDINATES

ANGLE IN DEGREES = 43.2643

MAGNITUDE = 46.6904

TYPE 1 TO CONTINUE, 0 TO STOP

?

0

*END

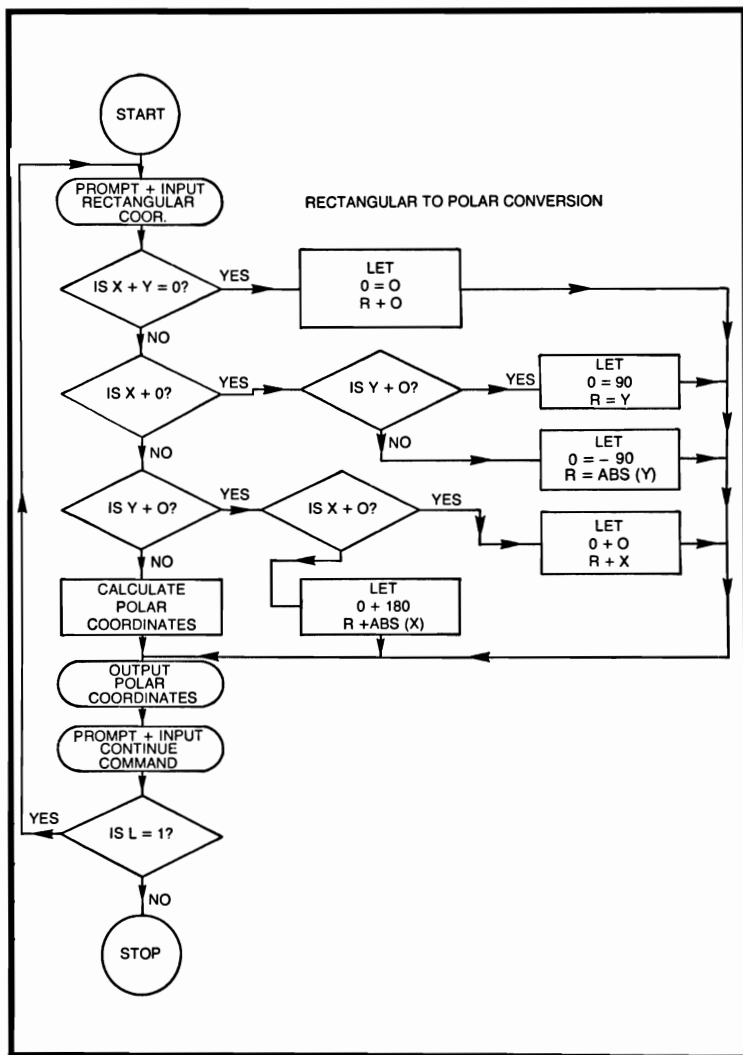

RECTANGULAR TO POLAR CONVERSION

```

10  REM THIS PROGRAM CONVERTS GIVEN RECTAN-
    GULAR
20  REM COORDINATES INTO POLAR COORDINATES
30  PRINT "RECTANGULAR COORDINATES"
40  PRINT "X = "
50  INPUT X
60  PRINT "Y="
  
```

```

70  INPUT Y
80  IF X + Y = 0 THEN 150
90  IF X = 0 THEN 180
100 IF Y = 0 THEN 250
110 LET W = ATN(Y/X)
120 LET W = (W*180)/3.14159
130 LET R = SQR(X↑2 + Y↑2)
140 GOTO 310
150 LET W = 0
160 LET R = 0
170 GOTO 310
180 IF Y > 0 THEN 220
190 LET W = - 90
200 LET R = ABS(Y)
210 GOTO 310
220 LET W = 90
230 LET R = Y
240 GOTO 310
250 X > 0 THEN 290
260 LET W = 180
270 LET R = ABS (X)
280 GOTO 310
290 LET W = 0
300 LET R = X
310 PRINT "POLAR COORDINATES"
320 PRINT "ANGLE IN DEGREES = "; W
330 PRINT "MAGNITUDE = "; R
340 PRINT "*****"
350 PRINT "TYPE 1 TO CONTINUE, 0 TO STOP"
360 INPUT L
370 IF L = 1 THEN 390
380 STOP
390 PRINT
400 GOTO 40
410 END

```

RECTANGULAR SECTIONS

This program computes various parameters: moment of inertia, polar moment of inertia, and area of section connected with a rectangular section.

FORMULAE

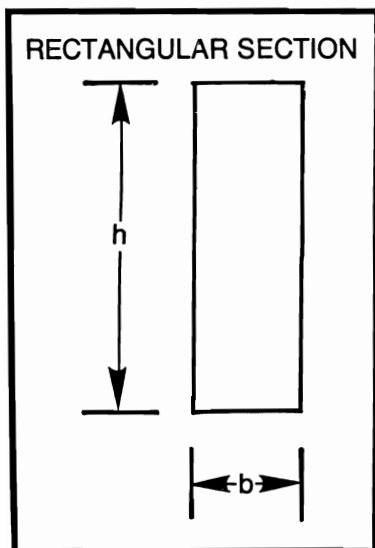

$$I = \frac{bh^3}{12} \quad \begin{array}{l} I \text{ and } J \text{ is in } (in^4) \\ A \text{ is in } (in^2) \end{array}$$

$$J = \frac{bh(b^2 + h^2)}{12}$$

$$A = bH$$

EXAMPLE

BASE =

?

3

HEIGHT =

?

5

MOMENT OF INERTIA = 31.25

POLAR MOMENT OF INERTIA = 42.50

AREA OF SECTION = 15

TYPE 1 TO CONTINUE, 0 TO STOP

?

0

*END

RECTANGULAR SECTIONS

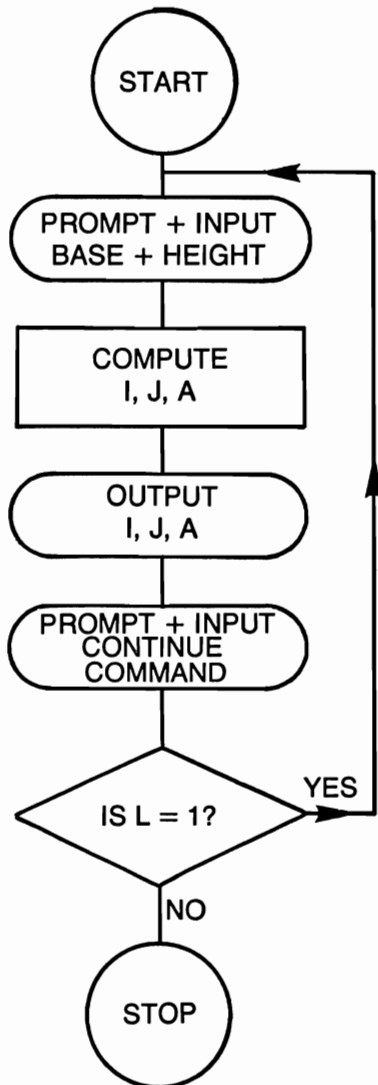

RECTANGULAR SECTIONS

```
10  REM THIS PROGRAM COMPUTES THE VARIOUS
    PARAMETERS
20  REM CONNECTED WITH A RECTANGULAR SEC-
    TION
30  PRINT "BASE = ";
40  INPUT B
50  PRINT "HEIGHT = "
60  INPUT H
70  LET I = (B*(H^3))/12
80  LET J = (B*H*(B^2 + H^2))/12
90  LET A = B*H
100 PRINT "MOMENT OF INERTIA = ";I
110 PRINT "POLAR MOMENT OF INERTIA = ";J
120 PRINT "AREA OF SECTION = ";A
130 PRINT
140 PRINT "TYPE 1 TO CONTINUE, 0 TO STOP"
150 INPUT L
160 IF L = 1 THEN 180
170 STOP
180 PRINT
190 GOTO 30
200 END
```

RESISTIVE ATTENUATOR DESIGN

This program computes the required three resistors to form either a Pi- or T-type resistive attenuator. This type of attenuator allows the user to choose a loss other than that of minimum.

FORMULAE

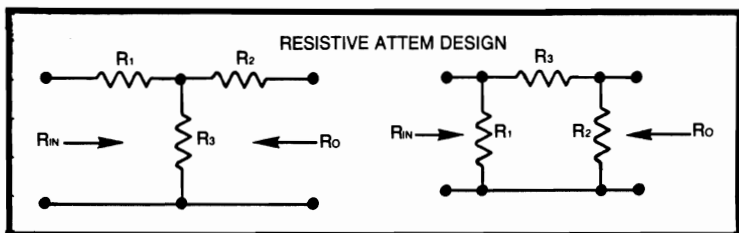

$R_{IN} > R_O$, and $N = \text{desired loss} \geq \text{minimum loss}$

$$\text{minimum loss} = 10 \log \left(\sqrt{\frac{R_{IN}}{R_O}} + \sqrt{\frac{R_{IN}}{R_O} - 1} \right)^2$$

T-type

$$R_3 = \frac{2 \sqrt{N R_{IN} R_O}}{N - 1}$$

$$R_1 = R_{IN} \left(\frac{N + 1}{N - 1} \right) - R_3$$

$$R_2 = R_O \left(\frac{N + 1}{N - 1} \right) - R_3$$

$$\pi\text{-type}$$

$$R_3 = \frac{1}{2} (N - 1) \left(\frac{R_{IN} R_O}{N} \right)^{1/2}$$

$$R_1 = \frac{1}{\frac{1}{R_{IN}} \left(\frac{N + 1}{N - 1} \right) - \frac{1}{R_3}}$$

$$R_2 = \frac{1}{\frac{1}{R_O} \left(\frac{N + 1}{N - 1} \right) - \frac{1}{R_3}}$$

EXAMPLE

INPUT RESISTANCE R(IN) =

?

500

OUTPUT RESISTANCE R(O) =

?

100

MINIMUM SYSTEM LOSS IN DECIBELS = 12.54

ENTER DESIRED LOSS IN DECIBELS

?

20

R(IN) = 500 R(O) = 100

DESIRED LOSS = 20

T ATTENUATOR

RESISTOR 1 = 464.9

RESISTOR 2 = 56.85

RESISTOR 3 = 45.17

PI ATTENUATOR

RESISTOR 1 = 879.6

RESISTOR 2 = 107.5

RESISTOR 3 = 1107

TYPE 1 TO CONTINUE, 0 TO STOP

?

0

*END

RESISTIVE ATTENUATOR DESIGN

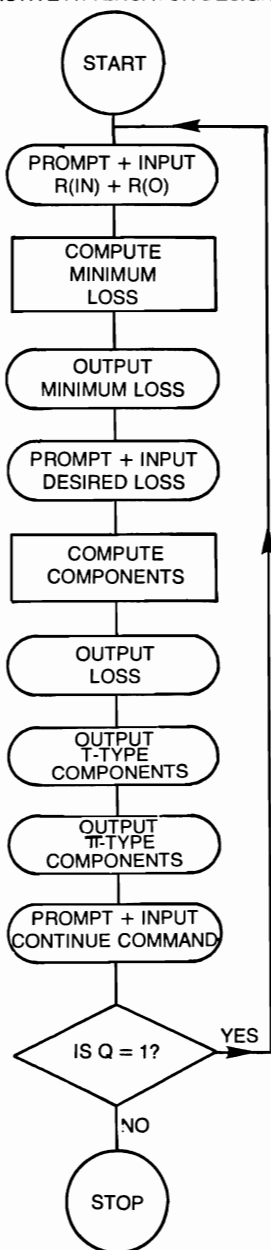

RESISTIVE ATTENUATOR DESIGN

```
10  REM THIS PROGRAM COMPUTES THE COMPO-
    NENTS
20  REM REQUIRED FOR A PI OR T TYPE
30  REM RESISTIVE ATTENUATOR
40  PRINT "INPUT RESISTANCE R(IN) = ";
50  INPUT X
60  PRINT "OUTPUT RESISTANCE R(0) = ";
70  INPUT Y
80  LET Z = X/Y
90  LET Q = (SQR(Z) + SQR(Z - 1))2
100 LET M = 10*(LOG(Q)/LOG(10))
110 PRINT "MINIMUM SYSTEM LOSS IN DECIBELS
    = ";M
120 PRINT "ENTER DESIRED LOSS IN DECIBELS";
130 INPUT L
140 LET N = 10 (L/10)
150 LET W = N - 1
160 LET U = N + 1
170 LET A = 2*(SQR(X*Y*N))
180 LET B = (X*(U/W)) - A
190 LET C = (Y*(U/W)) - A
200 LET D = (W*SQR((X*Y)/N))/2
210 LET E = 1/((U/W)/X) - (1/D)
220 LET F = 1/((U/W)/Y) - (1/D)
230 PRINT "R(IN) = ";X,"R(0) = ";Y
240 PRINT "DESIRED LOSS = ";L
250 PRINT
260 PRINT "T ATTENUATOR"
270 PRINT "RESISTOR 1 = ";B
280 PRINT "RESISTOR 2 = ";C
290 PRINT "RESISTOR 3 = ";A
300 PRINT
310 PRINT "PI ATTENUATOR"
320 PRINT "RESISTOR 1 = ";E
330 PRINT "RESISTOR 2 = ";F
340 PRINT "RESISTOR 3 = ";D
350 PRINT
360 PRINT "TYPE 1 TO CONTINUE, 0 TO STOP"
370 INPUT Q
380 IF Q = 1 THEN 400
390 STOP
400 PRINT
410 GOTO 40
420 END
170
```

SIMULTANEOUS EQUATIONS IN TWO UNKNOWNNS

The user supplies the components of two $AX + BY = C$ type equations, also giving the computer the opportunity to state if the solution is impossible.

FORMULAE

$$X = \frac{ED - BF}{AD - BC} = \frac{\begin{vmatrix} E & B \\ F & D \end{vmatrix}}{\begin{vmatrix} A & B \\ C & D \end{vmatrix}} \quad Y = \frac{AF - EC}{AD - BC} = \frac{\begin{vmatrix} A & E \\ C & F \end{vmatrix}}{\begin{vmatrix} A & B \\ C & D \end{vmatrix}}$$

EXAMPLE

$AX + BY = E$

$CX + DY = F$

ENTER PARAMETERS, A,B,C,D,E,F

?

10,20,45,23,56,78

SOLUTION $X = 9.6$ $Y = - 2.55$

TYPE 1 TO CONTINUE, 0 TO STOP

?

1

$AX + BY = E$

$CX + DY = F$

ENTER PARAMETERS A,B,C,D,E,F

10,10,789,2,2,6

NO SOLUTION, OR NO UNIQUE SOLUTION EXISTS

TYPE 1 TO CONTINUE, 0 TO STOP

?

0

*END

SIMULTANEOUS EQUATIONS IN TWO UNKNOWNNS

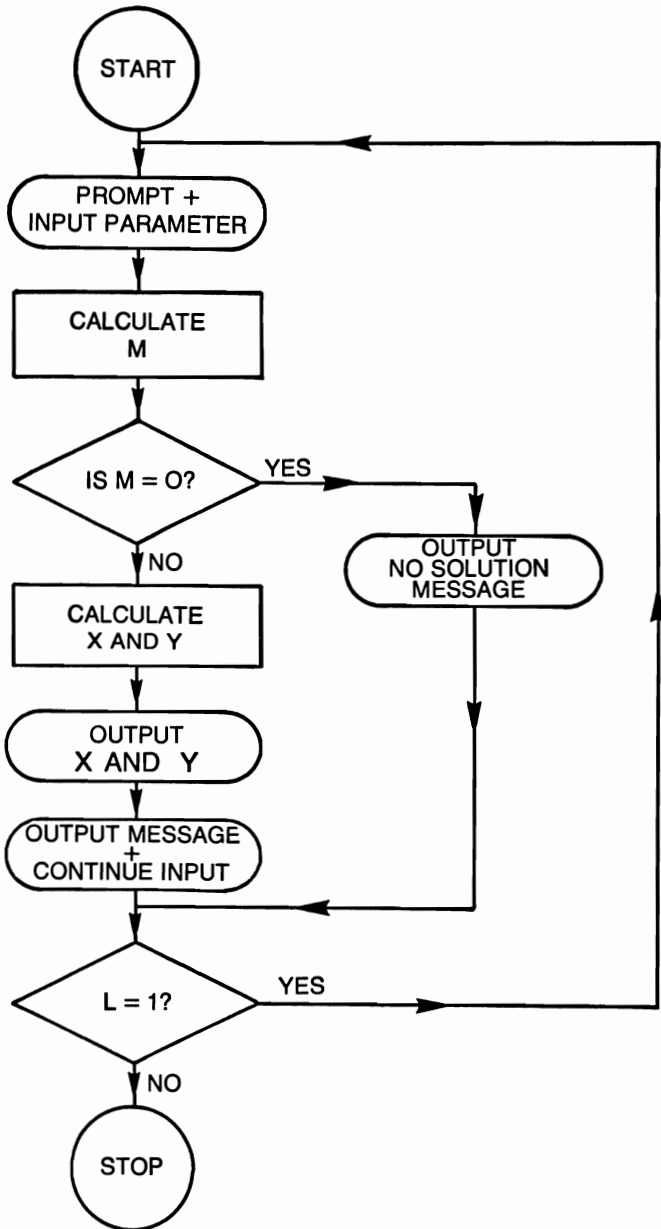

SIMULTANEOUS EQUATIONS IN TWO UNKNOWNNS

```
10  REM THIS PROGRAM COMPUTES SIMULTANEOUS
    EQUATIONS
20  REM IN TWO UNKNOWNNS
30  PRINT "AX + BY = E"
40  PRINT "CX + DY = F"
50  PRINT "ENTER PARAMETERS A,B,C,D,E,F"
60  INPUT A,B,C,D,E,F
70  LET M = (A*D) - (B*C)
80  IF M = 0 THEN 140
90  LET X = ((E*D) - (B*F))/M
100 LET Y = ((A*F) - (E*C))/M
110 PRINT "SOLUTION", "X = ";X, "Y = ";Y
120 PRINT "*****"
130 GOTO 160
140 PRINT "NO SOLUTION, OR NO UNIQUE SOLUTION
    EXISTS"
150 PRINT "*****"
160 PRINT "TYPE 1 TO CONTINUE, 0 TO STOP"
170 INPUT L
180 IF L = 1 THEN 200
190 STOP
200 PRINT
210 GOTO 30
220 END
```

SIMULTANEOUS EQUATIONS IN THREE UNKNOWNNS

The computer solves a system of three equations in three unknownns with the parameters supplied by the user.

EXAMPLE

SOLVE FOR 3 EQUATIONS IN 3 UNKNOWNNS

OF THE TYPE $AX + BY + CZ = D$

ENTER FIRST EQUATION(A,B,C,D)

?

1,4,6,3

ENTER SECOND EQUATION(A,B,C,D)

?

- 3,8,0, - 2

ENTER THIRD EQUATION(A,B,C,D)

?

4, - 5,2,6

SOLUTION

$X = 2.65516$ $Y = .741935$ $Z = - .435483$

TYPE 1 TO CONTINUE, 0 TO STOP

?

0

*END

SIMULTANEOUS EQUATIONS IN THREE UNKNOWNNS

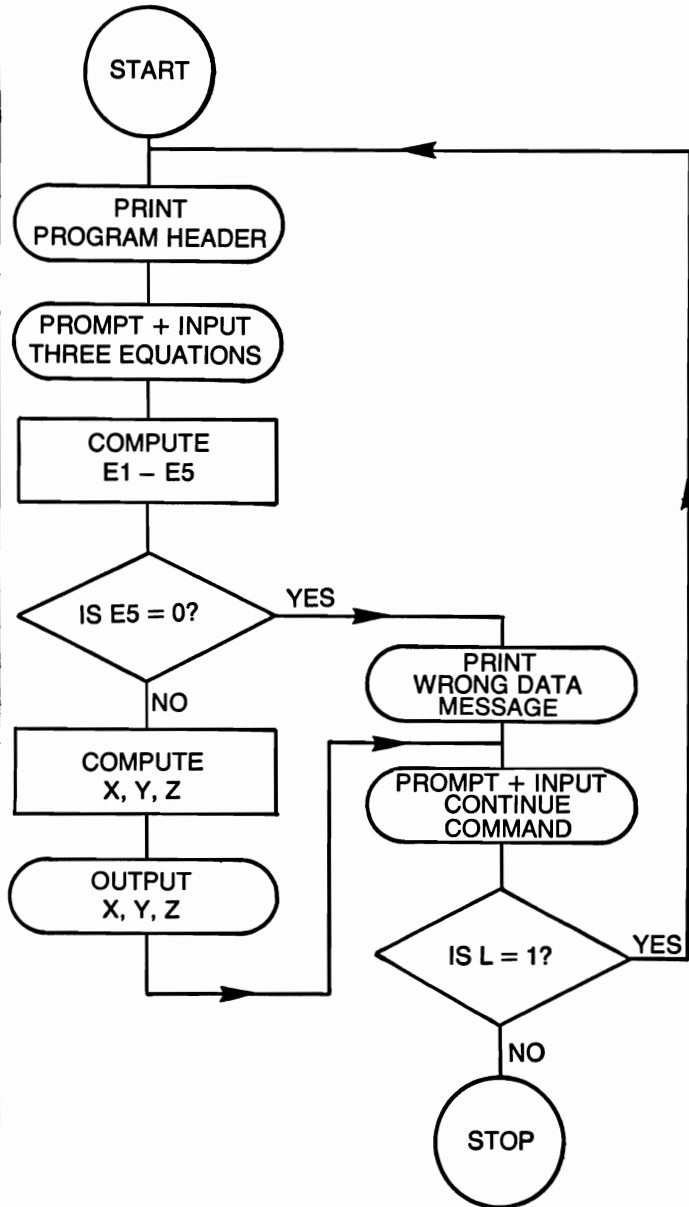

SIMULTANEOUS EQUATIONS IN THREE UNKNOWNNS

```
10  REM THIS PROGRAM COMPUTES THE SOLUTION
    TO
110  REM A SYSTEM OF 3 EQUATIONS IN 3 UNKNOWNNS
120  PRINT "SOLVE FOR 3 EQUATIONS IN 3 UNKNOWNNS"
130  PRINT "OF THE TYPE AX + BY + CZ = D"
140  PRINT "ENTER 1ST EQUATION (A,B,C,D)"
150  INPUT A1,B1,C1,D1
160  PRINT "ENTER 2ND EQUATION (A,B,C,D)"
170  INPUT A2,B2,C2,D2
180  PRINT "ENTER 3RD EQUATION (A,B,C,D)"
190  INPUT A3,B3,C3,D3
200  LET E1 = ((B1*A2)/A1) - B2
210  LET E2 = ((C1*A2)/A1) - C2
220  LET E3 = ((B1*A3)/A1) - B3
230  LET E4 = ((C1*A3)/A1) - C3
240  LET E5 = ((E1*E4) - (E2*E3))
250  IF E5 = 0 THEN 260
260  LET E6 = ((D1*A2)/A1) - D2
270  LET E7 = ((D1*A3)/A1) - D3
280  LET Y = ((E6*E4) - (E2*E7))/E5
290  LET Z = ((E1*E7) - (E6*E3))/E5
300  LET X = (D1/A1) - ((B1/A1)*Y) - ((C1/A1)*Z)
310  PRINT "SOLUTION"
320  PRINT "X = ";X,"Y = ";Y,"Z = ";Z
330  GOTO 260
340  PRINT "INSUFFICIENT OR ERRONEOUS DATA EN-
    TERED"
350  PRINT
360  PRINT "TYPE 1 TO CONTINUE, 0 TO STOP"
370  INPUT L
380  IF L = 1 THEN 310
390  STOP
400  PRINT
410  GOTO 30
420  END
```

SPACE WARS (1)

The game of Space Wars, as simulated by this program, is a battle between two ships, one the enemy, the other the player. The player has the following options: rotate the ship, move the ship, fire the laser cannon, fire the laser, or self-destruct. The object of this game is to destroy the enemy. The enemy, also being armed with a laser cannon and a laser, fires on you, so be careful.

EXAMPLE

RUN

ARE INSTRUCTIONS REQUIRED? TYPE EITHER
YES OR NO

?

YES

THERE ARE 5 EXECUTIVE COMMANDS; TURN THE
SHIP(1), MOVE(2), FIRE LASER CANNON(3),
FIRE LASER(4) AND SELF-DESTRUCT(5)
THE CANNON MUST BE FIRED WITHIN 10 DEGREES
OF 90 TO BE EFFECTIVE. NEGATIVE DEG TURNS TO-
WARDS

0 AND POSITIVE DEG TOWARDS 180. ENTERING NEGATIVE
KM

MOVES YOU TOWARDS THE ENEMY, WHILE POSITIVE
MOVES

YOU AWAY. LASER EFFECTIVENESS IS RANDOM, DUE TO
SHIELDING, DISTANCE AND INTERSTELLAR DEBRIS

*****GOOD-LUCK*****

MAY THE FORCE BE WITH YOU

DISTANCE TO ENEMY 3.7 E0 3KM

BEARING IS 87 DEGREES

THE SKY FIGHTER HAS FIRED HIS LASER

YOUR TOTAL ENERGY IS NOW 9.75E03 UNITS

THE ENEMY HAS 9.5E03 UNITS OF ENERGY LETS
WHICH COMMAND DO YOU WISH TO EXECUTE

?

2

HOW MANY KM TO TRANSVERSE

?

- 3.3E03

DISTANCE TO ENEMY 400KM

BEARING IS 87 DEGREES

THE SKY FIGHTER HAS FIRED HIS LASER

YOUR TOTAL ENERGY IS NOW 9.32E03 UNITS
THE ENEMY HAS 9.0E03 UNITS OF ENERGY LEFT
WHICH COMMAND DO YOU WISH TO EXECUTE

?

5

YOU HAVE INSTRUCTED THE ON-BOARD COMPUTER
TO SELF-DESTRUCT, THE REACTOR HAS GONE
CRITICAL, YOU HAVE GONE TO MEET THE FORCE
YOUR DESTRUCTION HAS ALSO DESTROYED
THE SKY FIGHTER, YOU WILL BE REMEMBERED
AS A HERO

SPACE WARS IS OVER
TO PLAY SPACE WARS AGAIN TYPE GO,
OTHERWISE TYPE NO

?

NO

SPACE WARS SAYS GOOD-BYE

*END

SPACE WARS (1)

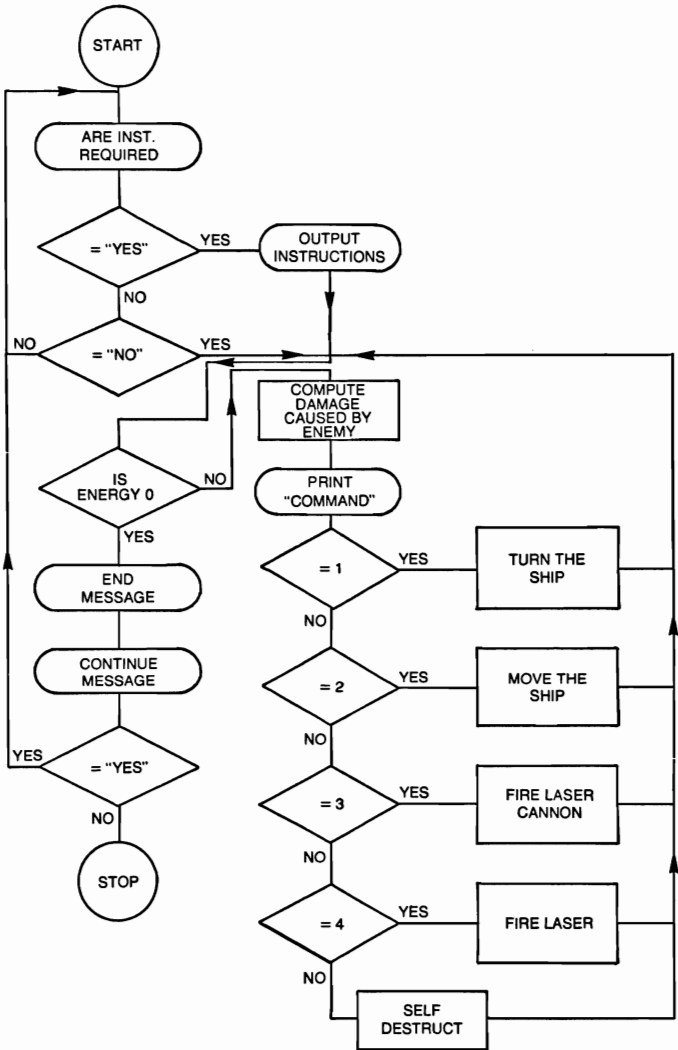

SPACE WARS (1)

```
10  REM THIS PROGRAM IS THE GAME OF SPACE
    WARS
20  REM TWO SHIPS BATTLE, YOU MUST DESTROY
    THE
30  REM ENEMY TO SAVE THE REPUBLIC
40  RANDOMIZE
50  PRINT "ARE INSTRUCTIONS REQUIRED? TYPE
    EITHER"
60  PRINT "YES OR NO"
70  INPUT A$
80  IF A$ = "YES" THEN 120
90  IF A$ = "NO" THEN 250
100 PRINT "INVALID RESPONSE"
110 GOTO 50
120 PRINT
130 PRINT "THERE ARE 5 EXECUTIVE COMMANDS;
    TURN THE"
140 PRINT "SHIP(1), MOVE(2), FIRE LASER CANNON(3),"
150 PRINT "FIRE LASER(4) AND SELF-DESTRUCT(5)"
160 PRINT "THE CANNON MUST BE FIRED WITHIN 10
    DEGREES"
170 PRINT "OF 90 TO BE EFFECTIVE. NEGATIVE DEG
    TURNS TOWARDS"
180 PRINT "0 AND POSITIVE DEG TOWARDS 180. EN-
    TERING NEGATIVE KM"
190 PRINT "MOVES YOU TOWARDS THE ENEMY, WHILE
    POSITIVE MOVES"
200 PRINT "YOU AWAY. LASER EFFECTIVENESS IS
    RANDOM, DUE TO"
210 PRINT "SHIELDING, DISTANCE AND INTERSTEL-
    LAR DEBRIS"
220 PRINT
230 PRINT "*****GOOD-LUCK*****"
240 PRINT "MAY THE FORCE BE WITH YOU"
250 LET E1 = 1E04
260 LET E2 = E1
270 LET D = 1E03 + INT(5E05*RND)
280 LET B = 1 + INT(180*RND)
290 GOSUB 340
300 GOSUB 390
310 LET E1 = E1 - D1
320 GOSUB 500
```

```

330 GOTO 690
340 IF D > = 1E05 THEN 370
350 LET L = 1
360 GOTO 380
370 LET L = 0
380 RETURN
390 IF L = 0 THEN 440
400 LET H2 = (1 + INT(100*RND))/100
410 LET D1 = 500*H2
420 LET E2 = E2 - 500
430 GOTO 490
440 LET M1 = 1 + INT(2*RND)
450 IF M1 = 1 THEN 470
455 LET D1 = 1000
460 GOTO 480
470 LET D1 = 0
480 LET E2 = E2 - 1000
490 RETURN
500 PRINT
510 PRINT "DISTANCE TO ENEMY ";D;"KM"
520 PRINT "BEARING IS ";B;" DEGREES"
530 IF L = 1 THEN 560
540 PRINT "THE SKY FIGHTER HAS FIRED THE LASER
      CANNON"
550 GOTO 570
560 PRINT "THE SKY FIGHTER HAS FIRED HIS LASER"
570 PRINT "YOUR TOTAL ENERGY IS NOW";E1;"
      UNITS"
580 PRINT "THE ENEMY HAS ";E2;" UNITS OF ENERGY
      LEFT"
590 IF E1 < = 0 THEN 620
600 IF E2 < = 0 THEN 650
610 GOTO 680
620 PRINT "YOUR ENERGY LEVEL IS ZERO, THE
      ENEMY"
630 PRINT "HAS WON, YOU HAVE BECOME ONE WITH
      THE FORCE!"
640 GOTO 1180
650 PRINT "THE ENEMY HAS RUN OUT OF ENERGY,
      YOU"
660 PRINT "HAVE WON"
670 GOTO 1180
680 RETURN

```

```

690 PRINT
700 PRINT "WHICH COMMAND DO YOU WISH TO EXECUTE"
710 INPUT C
720 ON C GOTO 730, 840, 1010, 1100, 1140
730 PRINT "HOW MANY DEGREES OF ROTATION"
740 INPUT B1
750 IF B + B1 = 0 THEN 800
760 IF B + B1 > 180 THEN 820
770 LET B = B + B1
780 LET E1 = E1 - (10*ABS(B1))
790 GOTO 290
800 PRINT "YOUR ANGLE MUST BE GREATER THAN 0 DEGREES"
810 GOTO 730
820 PRINT "YOUR ANGLE MUST BE LESS THAN 181 DEGREES"
830 GOTO 730
840 PRINT "HOW MANY KM TO TRANSVERSE"
850 INPUT K
860 IF D + K = 0 THEN 910
870 IF D + K > 1E06 THEN 960
880 LET D = D + K
890 LET E1 = E1 - (ABS(K/1000))
900 GOTO 290
910 PRINT "YOU HAVE TRIED TO CLOSE THE DISTANCE TO ZERO"
920 PRINT "BETWEEN YOU AND THE ENEMY, THE ON-BOARD"
930 PRINT "COMMAND COMPUTER WILL NOT EXECUTE THIS MANEUVER"
940 PRINT
950 GOTO 840
960 PRINT "YOU HAVE TRIED TO EXCEED THE DISTANCE WHERE"
970 PRINT "ANY OF YOUR WEAPONS ARE EFFECTIVE"
980 PRINT "THE ON-BOARD COMPUTER WILL NOT"
990 PRINT "EXECUTE THIS MANEUVER"
1000 GOTO 840
1010 LET E1 = E1 - 1000
1020 IF B > = 80 THEN 1050
1030 PRINT "YOUR ANGLE IS TOO SMALL, YOU HAVE MISSED"

```



```

1040 GOTO 290
1050 IF B < = 100 THEN 1080
1060 PRINT "YOUR ANGLE IS TOO GREAT, YOU HAVE
      MISSED"
1070 GOTO 290
1080 LET E2 = E2 - 1000
1090 GOTO 290
1100 LET E1 = E1 - 500
1110 LET D2 = (1 + INT(100*RND))/100
1120 LET E2 = E2 - (D2*500)
1130 GOTO 290
1140 PRINT "YOU HAVE INSTRUCTED THE ON-BOARD
      COMPUTER"
1150 PRINT "TO SELF-DESTRUCT, THE REACTOR HAS
      GONE"
1160 PRINT "CRITICAL, YOU HAVE GONE TO MEET THE
      FORCE"
1170 IF D < = 500 THEN 1200
1180 PRINT "SPACE WARS IS OVER"
1190 GOTO 1240
1200 PRINT "YOUR DESTRUCTION HAS ALSO DE-
      STROYED"
1210 PRINT "THE SKY FIGHTER, YOU WILL BE REMEM-
      BERED"
1220 PRINT "AS A HERO"
1230 GOTO 1180
1240 PRINT
1250 PRINT "TO PLAY SPACE WARS AGAIN TYPE GO,"
1260 PRINT "OTHERWISE TYPE NO"
1270 INPUT Z$
1280 IF Z$ = "GO" THEN 1310
1290 PRINT "SPACE WARS SAYS GOOD-BYE"
1300 STOP
1310 PRINT
1320 GOTO 50
1330 END

```

SPACE WARS (2)

This computer simulation requires considerably more memory than any other program in the book. For the user who is memory limited, the following may be done. Deleting the REM statements, removing the instructions, and reducing the string lengths in the messages will reduce the memory requirement by about 50 percent.

EXAMPLE

RUN

ARE INSTRUCTIONS FOR SPACE WARS REQUIRED? TYPE
EITHER YES OR NO

?

YES

*****SPACE WARS*****

THE DEATH STAR SPACE STATION, YOUR GOAL, IS HEAVILY

SHIELDED AND MOUNTS MORE FIREPOWER THAN HALF THE IMPERIAL FLEET. BUT, ITS DEFENSES WERE PRIMARILY DESIGNED TO FEND OFF LARGE-SCALE CAPITAL

SPACE-SHIP ASSAULTS. A SMALL, ONE- OR TWO-MAN X-WING FIGHTER SHOULD BE ABLE TO SLIP THROUGH ITS DEFENSIVE SCREENS. YOUR MISSION IS TO DESTROY THE DEATH STAR!!! ON ITS SURFACE THERE IS A SMALL THERMAL EXHAUST PORT. ITS SIZE BELIES ITS IMPORTANCE

AS IT APPEARS TO BE AN UNSHIELDED SHAFT THAT RUNS DIRECTLY INTO THE MAIN REACTOR SYSTEM POWERING THE DEATH STAR SPACE STATION. SINCE THIS SERVES AS AN EMERGENCY OUTLET FOR WASTE HEAT IN THE EVENT OF REACTOR OVERPRODUCTION, ITS USEFULNESS

WOULD BE ELIMINATED BY ENERGY-PARTICLE SHIELDING.

A DIRECT HIT WOULD INITIATE A CHAIN REACTION THAT WOULD DESTROY THE STATION, THUS PROTECTING THE REPUBLIC

*****EXECUTIVE COMMANDS ARE*****

- (1) FIRE HIGH-ENERGY TORPEDO
- (2) FIRE LASER CANNON
- (3) FIRE LASER
- (4) PROPULSION OF X-WING

THE BATTLE COMPUTER OPTION MAY BE USED WITH
COMMANDS

2 AND 3. THE ENERGY TORPEDO IS USED TO DESTROY
THE DEATH STAR WITH, EACH TORPEDO EXPENDS 20,000
UNITS OF ENERGY. THE LASER CANNON MAY BE USED
AGAINST THE SKY FIGHTERS, IT REQUIRES 5,000 UNITS
THE LASER USES 1,000 ENERGY UNITS PER SHOT AND IT
IS ALSO USED AGAINST THE SKY FIGHTERS.

THE BATTLE COMPUTER REQUIRES 500 ENERGY UNITS,
BUT,

GUARANTEES A DIRECT HIT ON A SKY FIGHTER. TO DE-
STROY A SKY FIGHTER YOU MUST DEplete IT OF EN-
ERGY.

MOVING THE X-WING SPACE CRAFT IS IMPERATIVE AS
THE ENERGY TORPEDO MUST BE FIRED WITHIN 1000KM
OF THE DEATH STAR. X-WING PROPULSION REQUIRES
1 ENERGY UNIT PER KM

GOOD-LUCK

MAY THE FORCE BE WITH YOU

DISTANCE TO DEATH STAR IS NOW 1E05KM
THE SKY FIGHTER HAS FIRED HIS LASER CANNON
THE DARK LORD IS EXTREMELY DANGEROUS!!!
THE SMITH LORD HAS USED A LASER CANNON ENERGY
BEAM

YOUR TOTAL ENERGY IS NOW 4.98E05
WHICH COMMAND DO YOU WISH TO EXECUTE

?

4

HOW MANY UNITS OF ENERGY DO YOU WISH TO FEED TO
THE HYPER-ATOMIC DRIVE UNIT, (1 UNIT/1KM)

****CAUTION**** TOO MUCH ENERGY WILL OVER-HEAT
THE REACTOR, INPUT NO MORE THAN 22,500 UNITS
AT ANY ONE TIME

?

30,000

IN WHICH DIRECTION, AWAY (A) OR TOWARDS (T)
THE DEATH STAR

?

T

YOU HAVE WASTED 3.0E04 UNITS OF ENERGY
THE REACTOR IS CRITICALLY OVERHEATED

DISTANCE TO DEATH STAR IS NOW 1E05KM
THE SKY FIGHTER HAS FIRED HIS LASER CANNON
RADER'S ON-BOARD ATTACK COMPUTER HAS MATCHED
YOUR COURSE, HIS WEAPONS ARE READY
THE SMITH LORD HAS USED A LASER CANNON ENERGY
BEAM

YOUR TOTAL ENERGY IS NOW 4.39E05 UNITS
WHICH COMMAND DO YOU WISH TO EXECUTE
?

4
HOW MANY UNITS OF ENERGY DO YOU WISH TO FEED TO
THE HYPER-ATOMIC DRIVE UNIT, (1 UNIT/1KM)
CAUTION TOO MUCH ENERGY WILL OVER-HEAT
THE REACTOR, INPUT NO MORE THAN 22,500 UNITS
AT ANY ONE TIME

?
20,000
IN WHICH DIRECTION, AWAY (A) OR TOWARDS (T)
THE DEATH STAR

?
T
DISTANCE TO DEATH STAR IS NOW 8.0E04KM
THE SKY FIGHTER HAS FIRED HIS LASER CANNON
CAUTION GARTH RADER IS THE BEST SHOT IN THE
IMPERIAL FLEET, PLUS HE USES THE BAD SIDE OF THE
FORCE

THE SMITH LORD HAS USED A LASER CANNON ENERGY
BEAM
YOUR TOTAL ENERGY IS NOW 4.1E05 UNITS
WHICH COMMAND DO YOU WISH TO EXECUTE

?
////////////////////////////////////
TO PLAY SPACE WARS AGAIN TYPE GO, IF
NOT TYPE NO

?
NO
SPACE WARS SAY GOOD-BYE AND MAY THE FORCE
BE WITH YOU

*END
The ///// indicate where the program was terminated, this simula-
tion may be played for a considerable length of time. In the interest of
saving space and leaving the unexpected to the user only a portion of
a typical run has been shown.

SPACE WARS (2)

```
10  REM THIS COMPUTER SIMULATION IS AN AD-
    VANCED VERSION OF
20  REM THE SPACE WARS GAME. YOUR MISSION IS
    TO DESTROY THE
30  REM DEATH STAR. YOU MAY BE ATTACKED BY
    THE DEATH STAR'S
40  REM DEFENSES AND BY THE SKY FIGHTERS
50  RANDOMIZE
60  PRINT "ARE INSTRUCTIONS FOR SPACE WARS
    REQUIRED? TYPE"
70  PRINT "EITHER YES OR NO"
80  INPUT A$
90  IF A$ = "YES" THEN 130
100 IF A$ = "NO" THEN 540
110 PRINT "YOU HAVE ISSUED AN INVALID RE-
    SPONSE"
120 GOTO 60
130 PRINT
140 PRINT "*****SPACE
    WARS*****"
150 PRINT "THE DEATH STAR SPACE STATION, YOUR
    GOAL, IS HEAVILY"
160 PRINT "SHIELDED AND MOUNTS MORE
    FIREPOWER THAN HALF"
170 PRINT "THE IMPERIAL FLEET. BUT, ITS DE-
    FENSES WERE"
180 PRINT "PRIMARILY DESIGNED TO FEND OFF
    LARGE-SCALE CAPITAL"
190 PRINT "SPACE-SHIP ASSAULTS. A SMALL, ONE-OR
    TWO-MAN"
200 PRINT "X-WING FIGHTER SHOULD BE ABLE TO
    SLIP THROUGH"
210 PRINT "ITS DEFENSIVE SCREENS. YOUR MISSION,
    IS TO DESTROY"
220 PRINT "THE DEATH STAR!!! ON ITS SURFACE
    THERE IS A SMALL"
230 PRINT "THERMAL EXHAUST PORT. ITS SIZE BE-
    LIES ITS IMPORTANCE"
240 PRINT "AS IT APPEARS TO BE AN UNSHIELDED
    SHAFT THAT RUNS"
250 PRINT "DIRECTLY INTO THE MAIN REACTOR
    SYSTEM, POWERING"
```

260 PRINT "THE DEATH STAR SPACE STATION. SINCE
THIS SERVES"
270 PRINT "AS AN EMERGENCY OUTLET FOR WASTE
HEAT IN THE"
280 PRINT "EVENT OF REACTOR OVERPRODUCTION,
ITS USEFULNESS"
290 PRINT "WOULD BE ELIMINATED BY ENERGY-
PARTICLE SHIELDING"
300 PRINT "A DIRECT HIT WOULD INITIATE A CHAIN
REACTION THAT"
310 PRINT "WOULD DESTROY THE STATION, THUS
PROTECTING THE"
320 PRINT "REPUBLIC"
330 PRINT "*****EXECUTIVE COMMANDS
ARE*****"
340 PRINT "(1) FIRE HIGH-ENERGY TORPEDO"
350 PRINT "(2) FIRE LASER CANNON"
360 PRINT "(3) FIRE LASER"
370 PRINT "(4) PROPULSION OF X-WING"
380 PRINT "THE BATTLE COMPUTER OPTION MAY BE
USED WITH COMMANDS"
390 PRINT "2 AND 3. THE ENERGY TORPEDO IS USED
TO DESTROY"
400 PRINT "THE DEATH STAR WITH, EACH TORPEDO
EXPENDS 20,000"
410 PRINT "UNITS OF ENERGY. THE LASER CANNON
MAY BE USED"
420 PRINT "AGAINST THE SKY FIGHTERS, IT RE-
QUIRES 5,000 UNITS"
430 PRINT "THE LASER USES 1,000 ENERGY UNITS
PER SHOT AND IT"
440 PRINT "IS ALSO USED AGAINST THE SKY FIGHT-
ERS."
450 PRINT "THE BATTLE COMPUTER REQUIRES 500
ENERGY UNITS, BUT,"
460 PRINT "GUARANTEES A DIRECT HIT ON A SKY
FIGHTER. TO DESTROY"
465 PRINT "A SKY FIGHTER YOU MUST DEplete IT OF
ENERGY."
470 PRINT "MOVING THE X-WING SPACE CRAFT IS IM-
PERATIVE AS"
480 PRINT "THE ENERGY TORPEDO MUST BE FIRED
WITHIN 100KM"

```

490 PRINT "OF THE DEATH STAR. X-WING PROPUL-
      SION REQUIRES"
500 PRINT "1 ENERGY UNIT PER KM"
510 PRINT "*****"
520 PRINT " GOOD-LUCK "
530 PRINT "MAY THE FORCE BE WITH YOU"
535 PRINT "*****"
536 REM X-WING ENERGY AND SKY ENERGY
540 LET X1 = 5E05
550 LET T1 = 1E04
560 LET T2 = 5E04
570 LET D = 1E05
580 GOSUB 630
590 GOSUB 730
600 GOSUB 830
610 GOSUB 1040
620 GOSUB 1500
625 GOTO 580
630 IF D > 1E04 THEN 660
640 LET L = 1
650 GOTO 700
660 LET L = 0
670 LET H = (1 + INT(100*RND))/100
680 LET E1 = 5000*H
690 GOTO 720
700 LET H = (1 + INT(100*RND))/100
710 LET E1 = 1000*H
720 RETURN
730 IF D > 5E03 THEN 760
740 LET K = 1
750 GOTO 800
760 LET K = 0
770 LET H = (1 + INT(100*RND))/100
780 LET E2 = 8000*H
790 GOTO 820
800 LET H = (1 + INT(100*RND))/100
810 LET E2 = 3000*H
820 RETURN
830 IF D < 3E03 THEN 860
840 LET E3 = 0
850 GOTO 880
860 LET H = (1 + INT(100*RND))/100
870 LET E3 = 2E04*H

```

```

880 LET T1 = T1 - E1
890 LET T2 = T2 - E2
900 IF T1 <= 0 THEN 920
910 GOTO 950
920 LET E1 = 0
930 LET Y = 1
940 GOTO 960
950 LET Y = 0
960 IF T2 <= 0 THEN 980
970 GOTO 1010
980 LET E2 = 0
990 LET Z = 1
1000 GOTO 1020
1010 LET Z = 0
1020 LET X1 = X1 - E1 - E2 - E3
1030 RETURN
1040 PRINT "DISTANCE TO DEATH STAR IS NOW";
      D;"KM"
1045 IF Y = 1 THEN 1100
1050 IF L = 0 THEN 1080
1060 PRINT "THE SKY FIGHTER HAS FIRED HIS LASER"
1070 GOTO 1110
1080 PRINT "THE SKY FIGHTER HAS FIRED HIS LASER
      CANNON"
1090 GOTO 1110
1100 PRINT "THE SKY FIGHTER IS OUT OF ACTION!!!"
1110 IF Z = 1 THEN 1180
1120 GOTO 1220
1130 IF K = 0 THEN 1160
1140 PRINT"THE DARK LORD HAS FIRED HIS HIGH
      ENERGY LASER"
1150 GOTO 1360
1160 PRINT"THE SMITH LORD HAS USED A LASER CAN-
      NON ENERGY BEAM"
1170 GOTO 1360
1180 PRINT "GARTH RADER HAS EXPENDED ALL HIS
      WEAPON'S ENERGY"
1190 PRINT "SUPPLY. HE IS CURRENTLY ESCAPING TO
      THE ENDS OF"
1200 PRINT "THE GALAXY. ***THE FORCE IS WITH
      YOU***"
1210 GOTO 1360

```



```

1220 LET C = 1 + (5*RND)
1230 ON C GOTO 1240, 1270, 1290, 1310, 1330
1240 PRINT "***CAUTION*GARTH RADER IS THE BEST
      SHOT IN THE"
1250 PRINT "IMPERIAL FLEET, PLUS HE USES THE BAD
      SIDE OF THE FORCE"
1260 GOTO 1130
1270 PRINT "THE DARK LORD IS EXTREMELY
      DANGEROUS!!!"
1280 GOTO 1130
1290 PRINT "***CAUTION RADER IS INHUMANLY ACCU-
      RATE CAUTION**"
1300 GOTO 1130
1310 PRINT "THE SMITH LORD'S PRECISION IS AWE-
      SOME"
1320 GOTO 1130
1330 PRINT "RADER'S ON-BOARD ATTACK COMPUTER
      HAS MATCHED"
1340 PRINT "YOUR COURSE, HIS WEAPONS ARE
      READY"
1350 GOTO 1130
1360 IF D <= 3E03 THEN 1380
1370 GOTO 1410
1380 PRINT "***YOU ARE CLOSER THAN 3000KM TO
      THE SPACE STATION"
1390 PRINT "THE DEATH STAR'S AUTOMATIC DE-
      FENSE NETWORK HAS BEEN"
1400 PRINT "ACTIVATED. ***USE EXTREME CAU-
      TION***"
1410 PRINT
1415 PRINT "YOUR TOTAL ENERGY IS NOW ";X1;"
      UNITS"
1420 IF X1 < 2E04 THEN 1140
1430 GOTO 1490
1440 PRINT "YOU HAVE DEPLETED YOUR ENERGY
      SUPPLY, THE DEATH"
1450 PRINT "STAR WILL NOW DESTROY YOUR HOME
      PLANET"
1460 PRINT "YOU WILL BE A HERO NOWHERE AND RE-
      MEMBERED BY NONE"
1470 PRINT "*****YOU HAVE MISUSED THE
      FORCE*****"
1480 GOTO 2690

```

```

1490 RETURN
1500 PRINT
1510 PRINT "WHICH COMMAND DO YOU WISH TO EXECUTE"
1520 INPUT B
1530 ON B GOTO 1540, 1690, 2030, 2320
1540 IF D <= 1000 THEN 1590
1550 PRINT "YOU HAVE WASTED A TORPEDO, YOU ARE FARTHER"
1560 PRINT "AWAY THAN 1000KM"
1570 LET X1 = X1 - 2E04
1580 GOTO 2680
1590 LET H = 1 + (INT(100*RND))
1600 IF H >= 50 THEN 1640
1610 PRINT "YOU SHOULD HAVE USED THE FORCE, YOU HAVE MISSED"
1620 LET X1 = X1 - 2E04
1630 GOTO 2680
1640 PRINT "THE FORCE WAS WITH YOU, YOU HAVE SINGLE-HANDED"
1650 PRINT "DESTROYED THE DEATH STAR. YOU HAVE SAVED THE"
1660 PRINT "REPUBLIC AND PRINCESS LEAH ARGONA WILL LOVE"
1670 PRINT "YOU FOREVER."
1680 GOTO 2740
1690 PRINT "THE CANNON IS READY, DO YOU WISH COMPUTER ASSISTANCE"
1700 PRINT "ENTER EITHER YES OR NO"
1710 INPUT C$
1720 IF C$ = "YES" THEN 1820
1730 IF C$ = "NO" THEN 1880
1740 PRINT "INVALID RESPONSE"
1750 GOTO 1700
1760 PRINT "WHICH FIGHTER THE SKY "S" OR RADER "R"
1770 INPUT C$
1780 IF C$ = "T" THEN 1840
1790 IF C$ = "V" THEN 1860
1800 PRINT "WHICH???"
1810 GOTO 1760
1820 LET Q = 5000
1830 GOTO 1760

```

```

1840 LET T1 = T1 - Q
1850 GOTO 1960
1860 LET T2 = T2 - Q
1870 GOTO 1960
1880 PRINT "DO YOU WISH TO FIRE ON GARTH RADER
      (R) OR"
1890 PRINT "ON THE SKY FIGHTER (S)"
1900 INPUT C$
1910 LET Q = 5000*((1 + INT(100*RND))/100)
1920 IF C$ = "S" THEN 1980
1930 IF C$ = "R" THEN 2000
1940 PRINT "WHICH ENEMY???"
1950 GOTO 1880
1960 LET X1 = X1 - 5500
1970 GOTO 2660
1980 LET T1 = T1 - Q
1990 GOTO 2010
2000 LET T2 = T2 - Q
2010 LET X1 = X1 - 5000
2020 GOTO 2660
2030 PRINT "YOU HAVE DECIDED ON USING THE
      LASER"
2040 PRINT "DO YOU WISH COMPUTER ASSISTANCE,
      YES OR NO"
2050 INPUT C$
2060 IF C$ = "YES" THEN 2100
2070 IF C$ = "NO" THEN 2120
2080 PRINT "THE COMPUTER RESPONSES ONLY TO A
      YES OR A NO"
2090 GOTO 2040
2100 LET J = 1
2110 GOTO 2130
2120 LET J = 0
2130 PRINT "WHICH FIGHTER THE SKY (S) OR RADER
      (R)"
2140 PRINT "DO YOU WISH TO FIRE ON"
2150 INPUT C$
2160 IF J = 1 THEN 2190
2170 LET Q = 1000*((1 + INT(100*RND))/100)
2180 GOTO 2200
2190 LET Q = 1000
2200 IF C$ = "S" THEN 2240
2210 IF C$ = "R" THEN 2260

```

```

2220 PRINT "WHICH TARGET?????"
2230 GOTO 2130
2240 LET T1 = T1 - Q
2250 GOTO 2270
2260 LET T2 = T2 - Q
2270 IF J = 1 THEN 2300
2280 LET X1 = X1 - 1000
2290 GOTO 2660
2300 LET X1 = X1 - 1500
2310 GOTO 2660
2320 PRINT "HOW MANY UNITS OF ENERGY DO YOU
      WISH TO FEED TO"
2330 PRINT "THE HYPER-ATOMIC DRIVE UNIT, (1
      UNIT/1KM)"
2340 PRINT "***CAUTION** TOO MUCH ENERGY WILL
      OVER-HEAT"
2350 PRINT "THE REACTOR, INPUT NO MORE THAN
      22,500 UNITS"
2360 PRINT "AT ANY ONE TIME"
2370 INPUT F
2380 PRINT "IN WHICH DIRECTION, AWAY (A) OR TO-
      WARDS (T)"
2390 PRINT "THE DEATH STAR"
2400 INPUT C$
2410 IF F > 2.25E04 THEN 2470
2420 IF C$ = "A" THEN 2500
2430 IF C$ = "T" THEN 2620
2440 PRINT "DON'T YOU KNOW WHICH DIRECTION YOU
      WANT TO GO TO"
2450 GOTO 2380
2460 REM OVERHEATING THE REACTOR
2470 PRINT "YOU HAVE WASTED ";F;" UNITS OF
      ENERGY"
2480 PRINT "THE REACTOR IS CRITICALLY OVER-
      HEATED"
2490 GOTO 2640
2500 LET D = D + F
2510 IF D > = 1.5E05 THEN 2540
2520 GOTO 2640
2530 REM WENT TOO FAR
2540 PRINT "WHERE ARE YOU GOING?? THE BATTLE IS
      IN THE"
2550 PRINT "OPPOSITE DIRECTION"

```

```

2560 GOTO 2640
2570 PRINT "YOU HAVE SMASHED INTO THE DARK
      STAR*****"
2580 PRINT "WHERE DID YOU LEARN TO FLY, GARTH
      RADER"
2590 PRINT "IS LAUGHING AT YOU;; OH!! BY THE
      WAY---"
2600 PRINT "** * * * * * YOU HAVE LOST * * * * * "
2610 GOTO 2690
2620 LET D = D - F
2630 IF D <= 0 THEN 2570
2640 LET X1 = X1 - F
2650 GOTO 2680
2660 PRINT "THE SKY FIGHTER'S ENERGY IS NOW
      ";T1;"UNITS"
2670 PRINT "THE DARK LORD'S ENERGY IS" ;T2;"
      UNITS"
2680 RETURN
2690 PRINT "YOU ARE AN INCOMPETENT GOOD
      KNIGHT"
2700 PRINT "YOU HAVE DISGRACED THE MEMORY OF"
2710 PRINT "OBI- SAN COYOTE! WHOSE SIDE ARE YOU
      ON??"
2720 PRINT "WHY DON'T YOU PROVE YOUR WORTH
      AND TRY AGAIN"
2730 GOTO 2760
2740 PRINT "OBI- SAN COYOTE WOULD BE PROUD OF
      YOU"
2750 PRINT "YOU ARE INDEED A **GOOD KNIGHT**"
2760 PRINT
2770 PRINT "TO PLAY SPACE WARS AGAIN TYPE GO, IF"
2780 PRINT "NOT TYPE NO"
2790 INPUT L$
2800 IF L$ = "GO" THEN 2840
2810 IF L$ = "NO" THEN 2860
2820 PRINT "DO YOU WANT TO STOP OR PLAY
      AGAIN?????"
2830 GOTO 2770
2840 PRINT
2850 GOTO 50
2860 PRINT "SPACE WARS SAY GOOD-BYE AND MAY
      THE FORCE BE WITH YOU"
2870 END

```

STRAIGHT LINE DEPRECIATION

This program computes the value depreciation of an item by the straight line method.

FORMULA

X_c = last current value, D = depreciation per year,

X_1 = new current value

$$X_c - D = X_1$$

EXAMPLE

ORIGINAL VALUE =

?

10000

LIFETIME IN YEARS =

?

12

YEARLY DEPRECIATION = 833.333

YEAR	VALUE
1	9166.66
2	8333.33
3	7500.
4	6666.66
5	5833.33
6	5000.
7	4166.66
8	3333.33
9	2500.
10	1666.66
11	333.333
12	0

TYPE 1 TO CONTINUE, 0 TO STOP

?

0

*END

STRAIGHT LINE DEPRECIATION

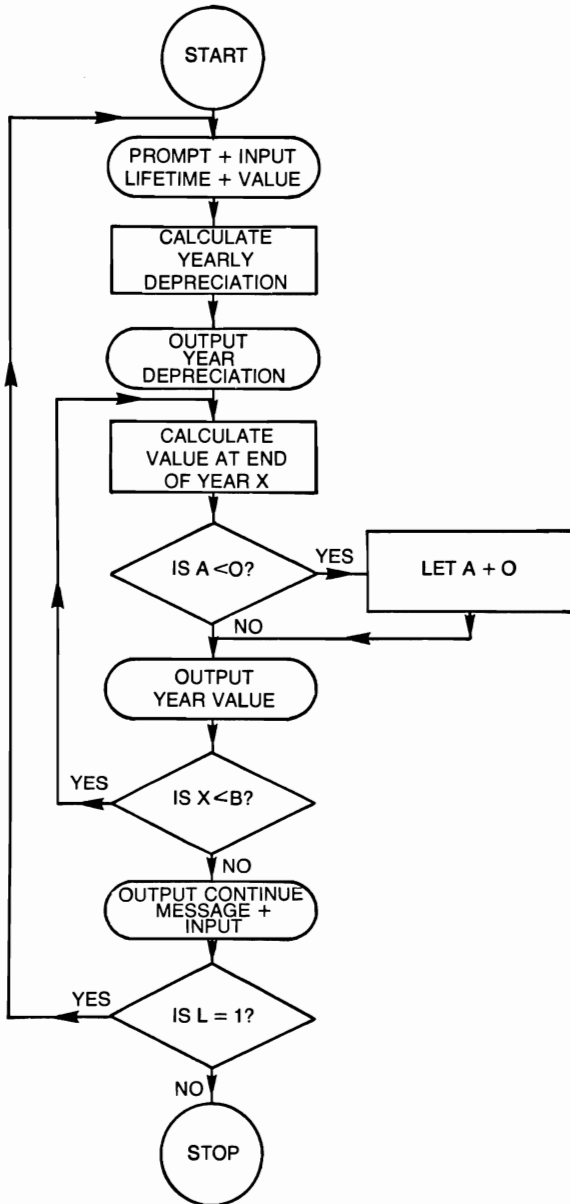

STRAIGHT LINE DEPRECIATION

```
10  REM THIS PROGRAM COMPUTES VALUE DEP-  
    CIATION  
20  REM BY THE STRAIGHT LINE METHOD  
30  PRINT "ORIGINAL VALUE = ";  
40  INPUT A  
50  PRINT "LIFETIME IN YEARS = ";  
60  INPUT B  
70  LET C = A/B  
80  PRINT "YEARLY DEPRECIATION = ";C  
90  PRINT  
100 PRINT "YEAR", "VALUE"  
110 LET X = 0  
120 LET X = X + 1  
130 LET A = A - C  
140 IF A < 0 THEN 160  
150 GOTO 170  
160 LET A = 0  
170 PRINT X,A  
180 IF X < B THEN 120  
190 PRINT "*****"  
200 PRINT "TYPE 1 TO CONTINUE, 0 TO STOP"  
210 INPUT L  
220 IF L = 1 THEN 240  
230 STOP  
240 PRINT  
250 GOTO 30  
260 END
```

VECTOR CROSS PRODUCT

If $A(A_1, A_2, A_3)$ and $B(B_1, B_2, B_3)$ are two three-dimensional vectors then the cross product of A and B is denoted by $A \times B$. The program responds with a solution represented by X, Y and Z .

FORMULAE

$$A \times B = \begin{vmatrix} A_2A_3 \\ B_2B_3 \end{vmatrix}, - \begin{vmatrix} A_1A_3 \\ B_1B_3 \end{vmatrix}, \begin{vmatrix} A_1A_2 \\ B_1B_2 \end{vmatrix}$$
$$= (A_2B_3 - A_3B_2, A_3B_1 - A_1B_3, A_1B_2 - A_2B_1)$$

EXAMPLES

ENTER 1ST VECTOR (A1,A2,A3)

?

10,11,10

ENTER 2ND VECTOR (B1,B2,B3)

?

4,3,4

VECTOR CROSS PRODUCT

X = 14 Y = 0 Z = - 14

+++++

TYPE 1 TO CONTINUE, 0 TO STOP

?

1

ENTER 1ST VECTOR (A1,A2,A3)

?

12,23,34

ENTER 2ND VECTOR (B1,B2,B3)

?

23,41,67

VECTOR CROSS PRODUCT

X = 147 Y = - 22 Z = - 37

+++++

TYPE 1 TO CONTINUE, 0 TO STOP

?

0

*END

VECTOR CROSS PRODUCT

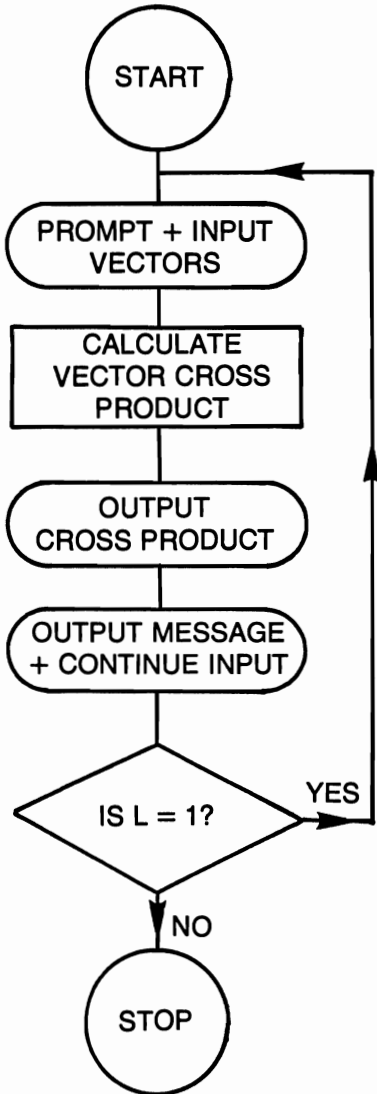

VECTOR CROSS PRODUCT

```
10  REM THIS PRODUCT COMPUTES THE CROSS PRO-
    DUCT
20  REM OF TWO VECTORS
30  PRINT "ENTER 1ST VECTOR (A1,A2,A3)"
40  INPUT A1,A2,A3
50  PRINT "ENTER 2ND VECTOR (B1,B2,B3)"
60  INPUT B1,B2,B3
70  LET X = (A2*B3) - (A3*B2)
80  LET Y = (A3*B1) - (A1*B3)
90  LET Z = (A1*B2) - (A2*B1)
100 PRINT "VECTOR CROSS PRODUCT"
110 PRINT "X = ";X,"Y = ";Y,"Z = ";Z
120 PRINT "+++++"
130 PRINT "TYPE 1 TO CONTINUE, 0 TO STOP"
140 INPUT L
150 IF L = 1 THEN 170
160 STOP
170 PRINT
180 GOTO 30
190 END
```

VECTOR DOT PRODUCT AND NORM

This program computes the vector dot product, also known as the scalar product and the norms of two vectors.

FORMULAE

$\vec{A} = (A_1, A_2, A_3)$ and $\vec{B} = (B_1, B_2, B_3)$ are two vectors

NORM of \vec{A} is denoted $|\vec{A}|$ and \vec{B} is denoted $|\vec{B}|$

$$|\vec{A}| = \sqrt{A_1^2 + A_2^2 + A_3^2}$$

$$|\vec{B}| = \sqrt{B_1^2 + B_2^2 + B_3^2}$$

$$\vec{A} \cdot \vec{B} = A_1 B_1 + A_2 B_2 + A_3 B_3$$

EXAMPLE

ENTER FIRST VECTOR (A1,A2,A3)

?

2,3,4

ENTER SECOND VECTOR (B1,B2,B3)

?

5,6,7

DOT PRODUCT = 56

NORM OF 1ST VECTOR = 5.38516

NORM OF 2ND VECTOR = 10.4880

TYPE 1 TO CONTINUE, 0 TO STOP

?

0

*END

DOT PRODUCT AND NORM

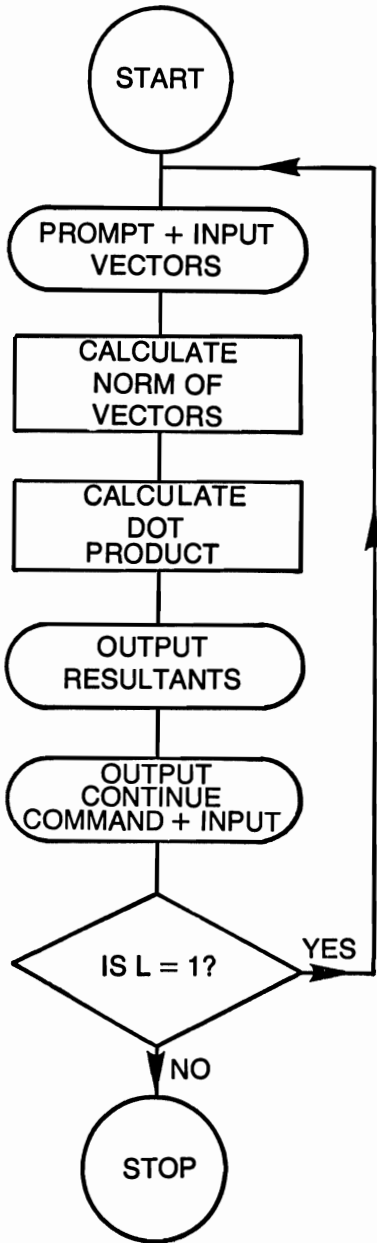

VECTOR DOT PRODUCT AND NORM

```
10  REM THIS PROGRAM COMPUTES DOT PRODUCT
    AND
20  REM THE NORMS OF TWO VECTORS
30  PRINT "ENTER 1ST VECTOR (A1,A2,A3)"
40  INPUT A1,A2,A3
50  PRINT "ENTER 2ND VECTOR (B1,B2,B3)"
60  INPUT B1,B2,B3
70  REM CALCULATE NORM OF A VECTOR
80  LET X = SQR((A1↑2) + (A2↑2) + (A3↑2))
90  REM CALCULATE NORM OF B VECTOR
100 LET Y = SQR((B1↑2) + (B2↑2) + (B3↑2))
110 REM CALCULATE DOT PRODUCT
120 LET Z = (A1*B1) + (A2*B2) + (A3*B3)
130 PRINT "DOT PRODUCT = ";Z
140 PRINT "NORM OF 1ST VECTOR = ";X
150 PRINT "NORM OF 2ND VECTOR = ";Y
160 PRINT "*****"
170 PRINT "TYPE 1 TO CONTINUE, 0 TO STOP"
180 INPUT L
190 IF L = 1 THEN 210
200 STOP
210 PRINT
220 GOTO 30
230 END
```

57 PRACTICAL PROGRAMS & GAMES IN BASIC

From arithmetic progression to statistical permutations to one-arm bandits, here are 57 practical, useful and fun programs designed to help you really put your minicomputer to work!

Game programs include blackjack, one-arm bandit, craps, and two space war games. Math and accounting programs include compounding, straight-line depreciation, statistical permutations, instant derivatives, and solutions for integrals—even a whole section of geometric solutions for modern-day Euclids. For history buffs, there is a Day-of-the-Week program for any date back through 1753.

Each program begins with an introductory paragraph describing its capabilities, and continues with a typical program sequence and flowchart. All programs will run on any floating point BASIC.

The author is a veteran computer programmer with extensive experience in developing software in various languages for a wide range of hardware systems.

OTHER POPULAR TAB BOOKS OF INTEREST

Beginner's Guide to Microprocessors

(No. 995—\$5.95 paper; \$8.95 hard)

Programming Microprocessors

(No. 985—\$6.95 paper; \$9.95 hard)

Miniprocessors: From Calculators to Computers

(No. 971—\$5.95 paper; \$9.95 hard)

Microprocessor Programming For Computer Hobbyists

(No. 952—\$8.95 paper; \$12.95 hard)

Microprocessor/Microprogramming Handbook

(No. 785—\$6.95 paper; \$9.95 hard)

Computer Programming Handbook

(No. 752—\$9.95 paper; \$12.95 hard)

Simplified Computer Programming—The Easy RPG Way

(No. 676—\$5.95 paper; \$8.95 hard)

Beginner's Guide to Computer Programming

(No. 574—\$7.95 paper)

TAB BOOKS

ALSO PUBLISHERS OF MODERN SPORTS CAR & MODERN AIRCRAFT SERIES
BLUE RIDGE SUMMIT, PA. 17214

Send for FREE TAB Catalog describing over 750 current titles in print.

ISBN 0-8306-1000-6

Prices higher in Canada