

Advanced  
**6502**  
Programming



Rodnay Zaks



# ADVANCED 6502 PROGRAMMING

RODNAY ZAKS



BERKELEY • PARIS • DÜSSELDORF

SYM is a trademark of Synertek Systems, Inc.  
KIM is a trademark of MOS Technology, Inc.  
AIM65 is a trademark of Rockwell International, Inc.  
"COMPUTEACHER" and "GAMES BOARD" are trademarks of Sybex, Inc.

Cover design by Daniel Le Noury  
Technical illustrations by Guy S. Orcutt and j. trujillo smith

Every effort has been made to supply complete and accurate information. However, Sybex assumes no responsibility for its use, nor for any infringements of patents or other rights of third parties which would result. No license is granted by the equipment manufacturers under any patent or patent rights. Manufacturers reserve the right to change circuitry at any time without notice.

© 1982 SYBEX Inc., 2344 Sixth Street, Berkeley, CA 94710. World rights reserved. No part of this publication may be stored in a retrieval system, transmitted, or reproduced in any way, including but not limited to photocopy, photograph, magnetic or other record, without the prior agreement and written permission of the publisher.

Based on *6502 Games* by Rodney Zaks, © 1980 SYBEX Inc.

Library of Congress Card Number: 82-160235  
ISBN 0-89588-089-X  
Printed in the United States of America  
10 9 8 7 6 5 4 3 2 1

# Contents

	<b>Preface</b>	<b>vii</b>
<b>1</b>	<b>Introduction</b>	<b>1</b>
	Optional Hardware Support	2
	Connecting the System	4
	Games Board Interconnect	7
	<u>The Keyboard Input Routine</u>	13
<b>2</b>	<b>Generating Square Waves (Music Player)</b>	<b>20</b>
	Introduction	20
	The Rules	20
	A Typical Game	22
	The Connections	22
	The Algorithm	22
	The Program	23
<b>3</b>	<b>Pseudo Random Number Generator (Translate)</b>	<b>41</b>
	Introduction	41
	The Rules	41
	A Typical Game	42
	The Algorithm	43
	The Program	43
<b>4</b>	<b>Hardware Random Number Generator (Hexguess)</b>	<b>59</b>
	Introduction	59
	The Rules	59
	A Typical Game	59
	The Algorithm	60
	The Program	60
<b>5</b>	<b>Simultaneous Input/Output (Magic Square)</b>	<b>73</b>
	Introduction	73
	The Rules	73
	A Typical Game	76
	The Algorithm	78
	The Program	80
<b>6</b>	<b>Simple Real Time Simulation (Spinner)</b>	<b>87</b>
	Introduction	87
	The Rules	87
	The Algorithm	88
	The Program	89

<b>7</b>	<b>Real Time Simulation (Slot Machine)</b>	<b>99</b>
	Introduction	99
	The Rules	99
	A Typical Game	100
	The Algorithm	101
	The Program	112
<b>8</b>	<b>Real Time Strategies (Echo)</b>	<b>137</b>
	Introduction	137
	The Rules	137
	A Typical Game	139
	The Algorithm	141
	The Program	144
<b>9</b>	<b>Using Interrupts (Mindbender)</b>	<b>162</b>
	Introduction	162
	The Rules	162
	A Typical Game	162
	The Algorithm	165
	The Program	167
<b>10</b>	<b>Complex Evaluation Technique (Blackjack)</b>	<b>189</b>
	Introduction	189
	The Rules	189
	A Typical Game	190
	The Program	194
<b>11</b>	<b>Artificial Intelligence (Tic-Tac-Toe)</b>	<b>218</b>
	Introduction	218
	The Rules	218
	A Typical Game	218
	The Algorithm	224
	The Program	247
	<b>Appendices</b>	<b>287</b>
	A. 6502 Instructions—Alphabetic	287
	B. 6502 Instruction Set—Hex and Timing	288
	<b>Index</b>	<b>290</b>

# Preface

This book has been designed to teach you advanced programming techniques for the 6502 microprocessor in a systematic and progressive way. Developing a program involves devising a suitable algorithm and appropriate data structures, and then coding the algorithm. In the case of a microprocessor such as the 6502, the design of the algorithm and the data structures is generally constrained by three conditions:

1. The amount of memory available is often limited or must be minimized; i.e., the program must be terse.
2. The highest possible execution speed may be required. Efficient coding of the program into assembly level language instructions then becomes an essential consideration. In particular, the use of registers must be optimized.
3. The specific input/output design requires an understanding of the input and output chips and their programming.

Thus, when evaluating designs for an algorithm and data structures, the programmer must weigh the merits of the various techniques in terms of his skill, the memory limitations, the required speed of execution, and the overall probability of success.

Advanced programming for the 6502, therefore, involves knowledge of all the chips that may be affected by the program, in addition to the usual programming skills concerned with the algorithm, the data structures, and the efficient use of internal instructions and registers. This book provides a comprehensive and complete overview of all the important techniques required to program a 6502 system efficiently. The book has been designed as an educational text. Each chapter introduces new concepts, chips, or techniques in turn. In the final chapters more complex algorithms are presented, which integrate the techniques presented throughout the book.

For clarity and consistency, this book uses a specific 6502-based system on which all the programs will run. The details are presented in Chapter 1. However, the programs and techniques presented here are applicable to all 6502-based systems. Similarly, all the programs studied in this book are presented in the form of realistic games involving successively all the techniques described. They cover most types of applications ranging from simple input/output techniques to sophisticated real-time simulations, including the handling of interrupts and the design of complex data structures.

A case study approach is used, and each chapter contains the following:

1. A description of the concepts and techniques to be studied
2. The specifications of the program's behavior and a typical session with the program, i.e., the problem to be solved
3. The algorithm(s): theory of operation, design, and trade-offs
4. The actual program: data structures, programming techniques, specific subroutines, merits of alternative techniques, and a complete program listing.

Variations and exercises are also proposed in each chapter.

Thus, you will first study the definition of the problem, then observe the expected program behavior, and then learn how to devise a possible solution (algorithm plus data structures). Finally, you will design a complete program for this algorithm in 6502 assembly level language, paying specific attention to the required data structures, the efficient use of registers, the input/output chips, and the techniques used for efficient programming.

You will sharpen your skills at using input/output techniques including timers and interrupts. But most importantly, you will be consistently reminded of the trade-offs between ease in programming, use of memory, efficiency of execution, and algorithmic improvements by use of specialized hardware or software techniques.

In order to learn the advanced programming techniques presented in this book, it is not necessary to build any actual hardware. However, it is necessary to write programs on your own along the ten chapters of this book. By showing you and explaining in detail the design of many actual programs, the author hopes to facilitate your next step: actual programming.

## **Acknowledgments**

The author would like to acknowledge the contributions of Chris Williams and Eric Novikoff, who thoroughly checked all of the games programs and contributed numerous ideas for improvements.

The author is particularly indebted to Eric Novikoff for his valuable assistance throughout all phases of the manuscript's production, and for his meticulous supervision of the final text.

The author would also like to express his appreciation to Rockwell International and in particular, to Scotty Maxwell, who made available to him one of the very first system 65 development systems. The availability of this powerful development tool, at the time the first version of this book was being written, was a major help for the accurate and efficient check-out of all the programs.





# 1. Introduction

In order to learn the techniques and study the program examples presented in this book, no specific equipment is required. However, the availability of a 6502-based system is a major advantage to develop and test 6502 programs on your own. Bear in mind that each 6502-based system will have a somewhat different input/output configuration. The techniques presented in this book are applicable to all, and the programs can be easily adapted once you understand input/output operations.

To read this book, you should be familiar with the 6502 instruction set and basic programming techniques on the level of *Programming the 6502*. A basic knowledge of input/output techniques is also recommended. (This topic is covered in *6502 Applications*.)

The programs presented in Chapters 2 through 11 range from simple to complex. In order to implement these programs, algorithms will be devised and data structures will be designed. This is the process any disciplined computer programmer must go through when designing a

program solution for a given problem. The ten case studies presented in this book will also familiarize you with common input/output techniques. Toward the end of the book, you will find that the problems presented pose increasingly complex intellectual challenges to devising efficient solutions. All the strategies presented in this book, including the one used for the Tic-Tac-Toe game in Chapter 1, are believed to be original. These strategies and the design process will be analyzed in detail. As an additional design constraint intended to teach you efficient design, all the algorithms and data structures presented in this book have been designed to result in a program that can reside within less than 1K of available memory.

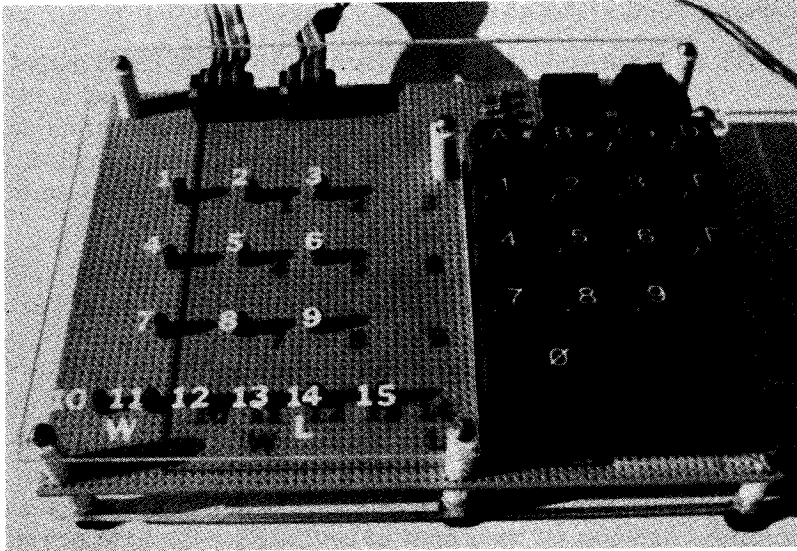
The programs presented in this book have been tested on actual hardware by many users and have been found to be error-free in the conditions under which they were tested. As in any large set of programs, however, inadequacies or improvements may be found.

### **OPTIONAL HARDWARE SUPPORT**

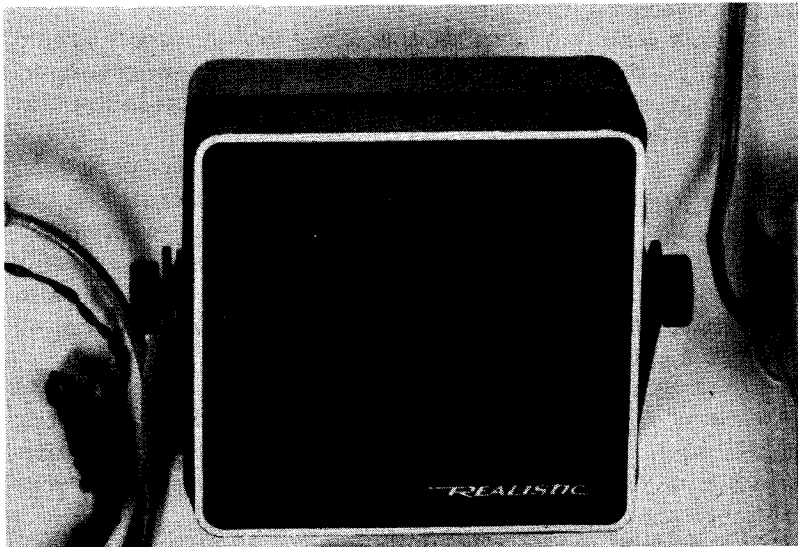
The programs contained in this book can be developed on any 6502-based system. However, in order to be executed they require a specific input/output environment. For the sake of simplicity, a uniform hardware environment has been used throughout this book. It assumes a 6502-based board, the SYM board (by Synertek Systems), and an additional input/output board, called the Games Board, which can be easily built. For completeness, an overview of the SYM board and a complete description of the Games Board will be provided in this chapter. However, it is not necessary to purchase or build these boards to understand the information presented in this book. The Games Board may also be adapted easily to other 6502-based computers such as Commodore or Apple computers. The programs remain essentially unchanged except for input/output device allocations.

The Games Board can also be simulated on a standard terminal by displaying information on a CRT screen and capturing input from a normal alphanumeric keyboard.

A photograph of the Games Board is shown in Figure 1.1. The keyboard on the right is used to provide inputs to the microcomputer board, while the LEDs on the left are used to display the information sent by the program. The specific use of the keys and the LEDs will be explained in each chapter. A speaker is also provided for sound effects. It can be mounted in an enclosure (box) for improved sound quality (see Figure 1.2). This input/output board can be easily built at home from a small number of low cost components.



**Fig. 1.1: The Games Board**



**Fig. 1.2: Enclosure May Be Used for Improved Sound**

## CONNECTING THE SYSTEM

If you wish to assemble the actual system and build the input/output board, read on. If you are not interested in building any actual hardware, proceed to the description of an important program subroutine that will be used repeatedly in this book: the keyboard input routine.

Four essential components are required to assemble the Games Board:

- 1 - the power supply
- 2 - the SYM board
- 3 - the Games Board
- 4 - (preferably) a cassette recorder

The first requirement is to connect the wires to the power supply. If it is not already so equipped, two sets of wires must be connected to it. (See Figure 1.3.) First, it must be connected to a power cord. Second, the ground and plus 5V wires must be connected to the SYM power connector, as per the manufacturer's specifications.

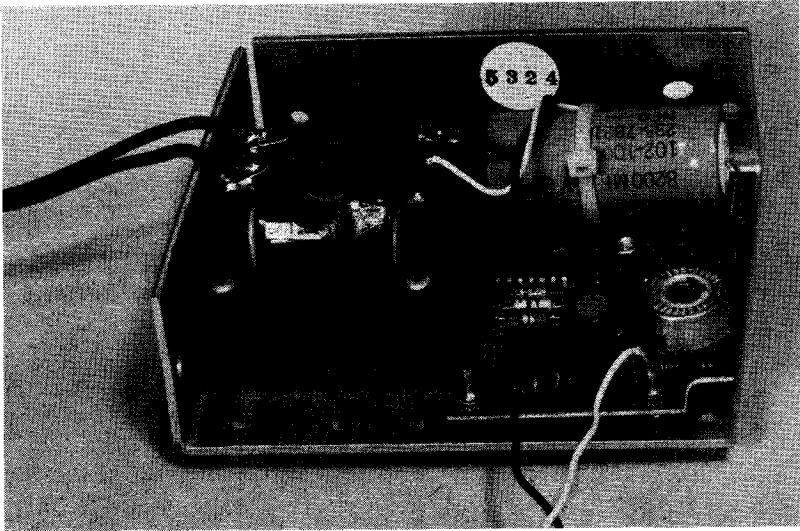
Next, the Games Board should be physically connected to the SYM. Two edge connectors are required for the SYM: both the A connector and the AA connector are used. (See Figure 1.4.) There is also a power source connector.

Always be careful to insert the connectors with the proper side up (usually the printed side). An error in inserting the power connector, in particular, will have highly unpleasant results. Errors in inserting the I/O connectors are usually less damaging.

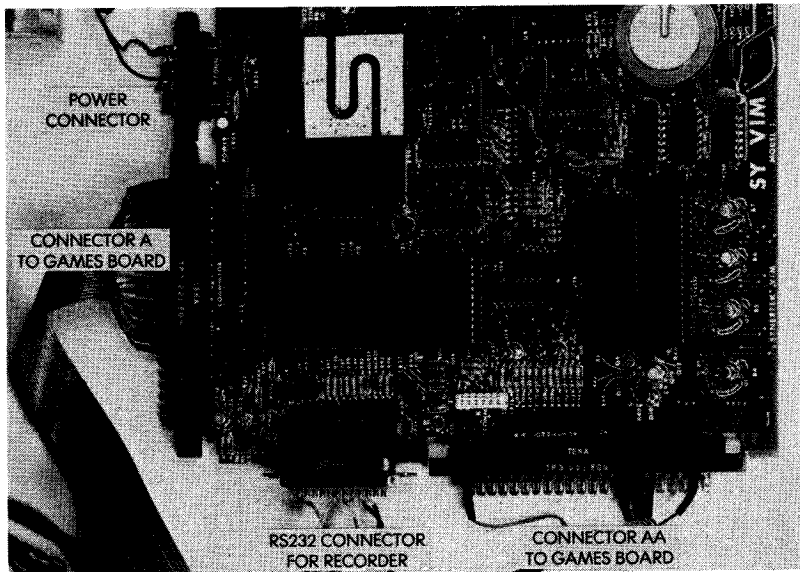
Finally, if a cassette recorder is to be used (highly recommended), the SYM board must be connected to a tape recorder. At the minimum, the "monitor" or "earphone" wires should be connected, and preferably the "remote" wire as well. If new programs are going to be stored on tape, the "record" or "microphone" wire should also be connected. (See Figure 1.5.) Details for these connections are given in the SYM manual.

At this point the system is ready to be used. (See Figure 1.6.) If you have one of the games cassettes (available separately from Sybex), simply load the cassette into the tape recorder. Press the RST key after powering up your SYM, and load the appropriate game into your SYM. You are ready to play.

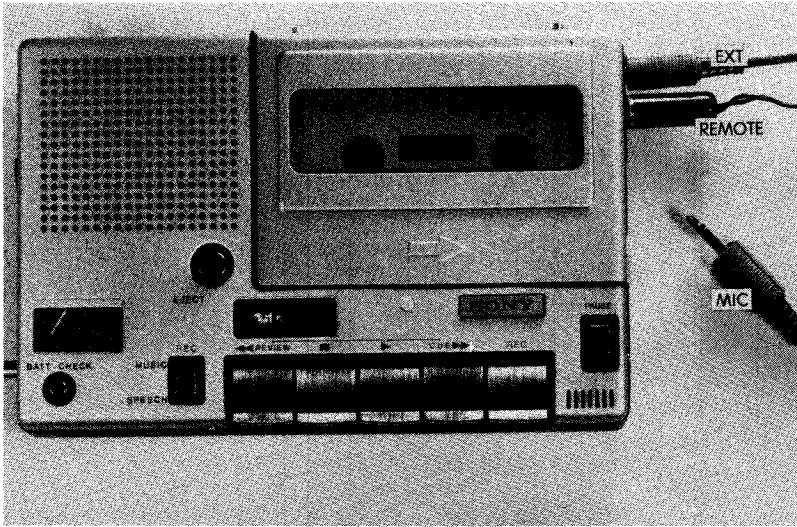
Otherwise, you should enter the hexadecimal object code of the game on the SYM keyboard. All games are started by jumping to location 200 ("GO 200").



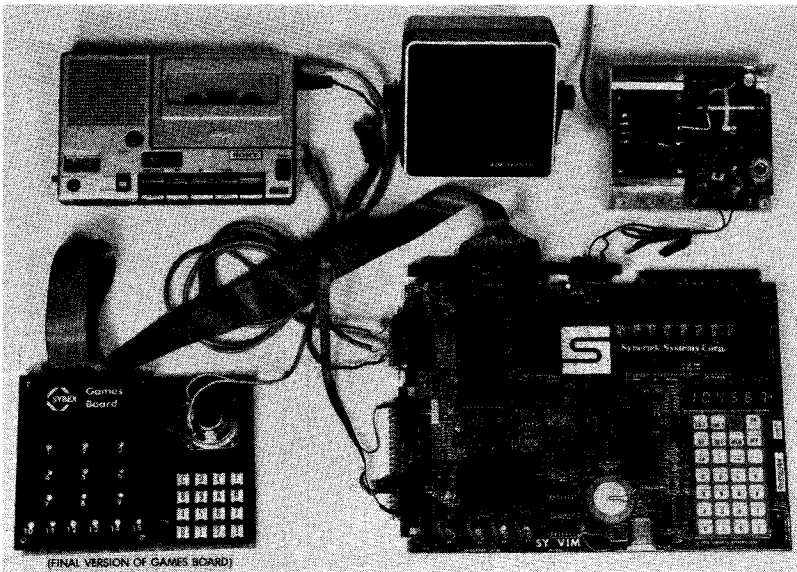
**Fig. 1.3: Two Wires Must Be Connected to the Power Supply**



**Fig. 1.4: The Games Board is Connected to the SYM with 2 Connectors  
(Note also Power and Cassette Connectors)**



**Fig. 1.5: Connecting the Cassette Recorder**



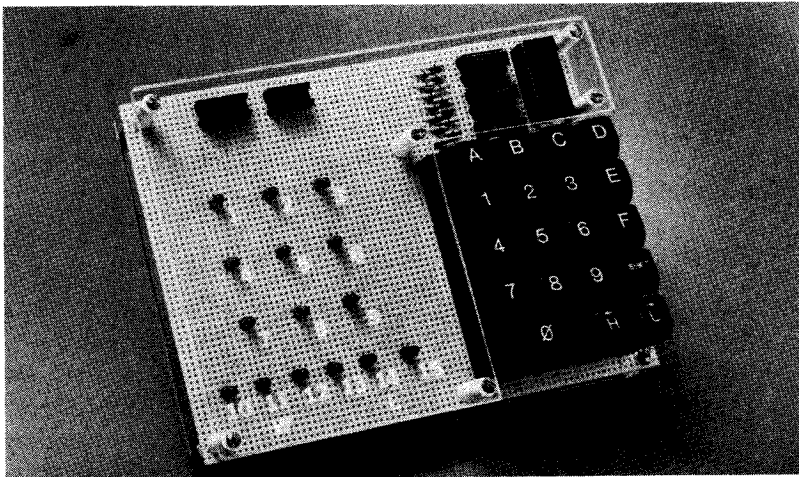
**Fig. 1.6: The System is Ready to be Used**

## GAMES BOARD INTERCONNECT

### The Keyboard

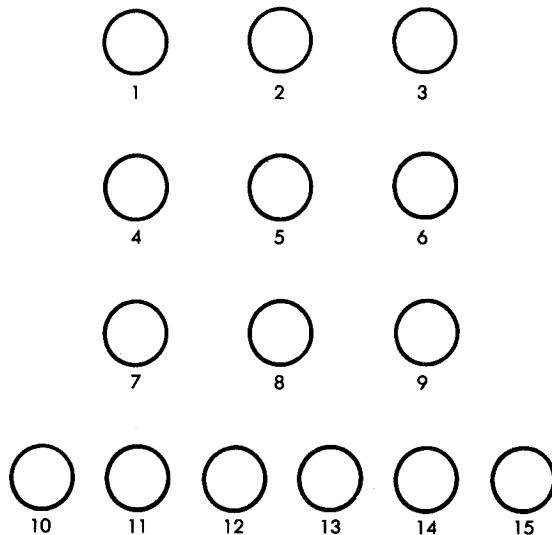
The board's components are shown in Figure 1.7. The LED arrangement used for the games is shown in Figure 1.8. The keyboard used here is of the "line per key" type, and does not use a matrix arrangement. Sixteen keys are required for the games, even though more keys are often provided on a number of "standard keyboards," such as the one used in the prototype of Figure 1.7. On this prototype, the three keys at the bottom right-hand corner are not used (keys H, L, and "shift").

Figure 1.9 shows how a 1-to-16 decoder (the 74154) is used to identify the key which has been pressed, while tying up only four output lines (PB0 to PB3) — four lines allow 16 codes. The keyboard scanning program will send the numbers 0-15 in succession out on lines PB0-PB3. In response, the 74154 decoder will decode its input (4 bits) into each one of the 16 outputs in sequence. For example, when the number "0000" (binary) is output on lines PB0 to PB3, the 74154 decoder grounds line 1 corresponding to key "0". This is illustrated in Figure 1.9. After outputting each four-bit combination, the scanning program reads the value of PA7. If the key currently grounded was not pressed, PA7 will be high. If the corresponding key was pressed, PA7 will be grounded and a logical "0" will be read. For example, in



**Fig. 1.7: Games Board Elements (Prototype)**





**Fig. 1.8: The LEDs**

Figure 1.10, a key closure for key 1 has been detected. As in any scanning algorithm, a good program will debounce the key closures by implementing a delay. For more details on specific keyboard interfacing techniques, the reader is referred to reference C207 — *Microprocessor Interfacing Techniques*.

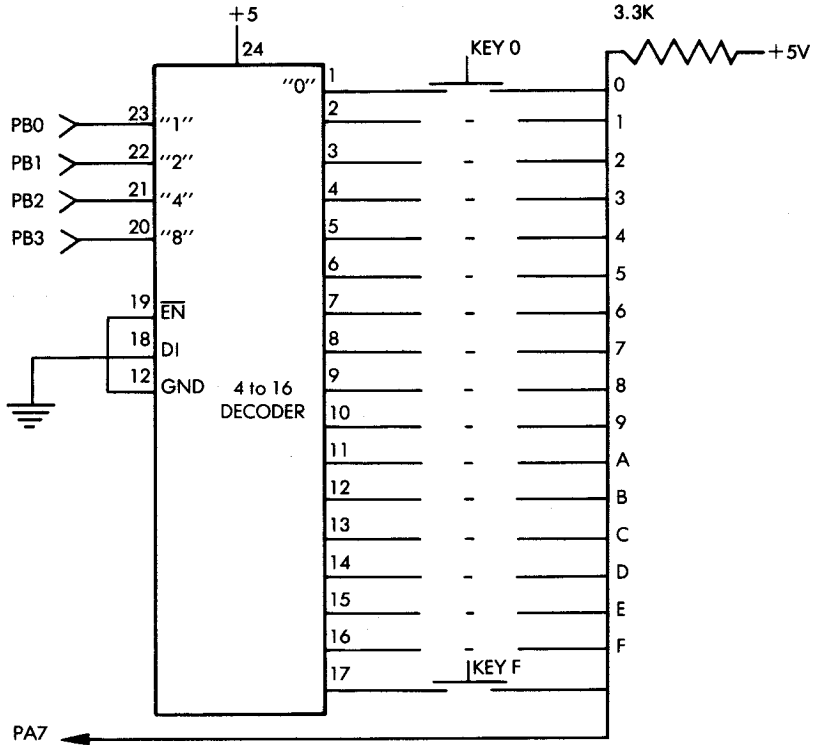
In the actual design, the four inputs to the 74154 (PB0 to PB3) are connected to VIA #3 of the SYM. PA7 is connected to the same VIA. The 3.3 K resistor on the upper right-hand corner of Figure 1.9 pulls up PA7 and guarantees a logic level “1” as long as no grounding occurs.

The GETKEY program, or a similar routine, is used by all the programs in this book and will be described below.

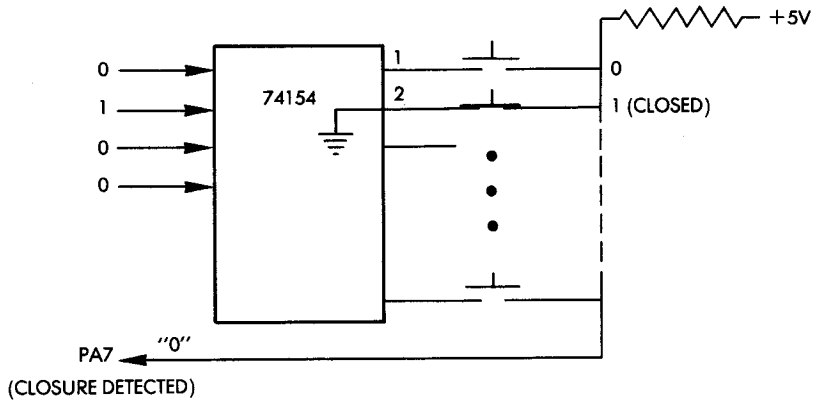
### The LEDs

The connection of the fifteen LEDs is shown in Figure 1.11. Three 7416 LED drivers are used to supply the necessary current (16 mA).

The LEDs are connected to lines PA0 to PA7 and PB0 to PB7, excepting PB6. These ports belong to VIA #1 of the SYM. An LED is lit by simply selecting the appropriate input pin of the corresponding driver. The resulting arrangement is shown in Figure 1.12 and Figure 1.13.

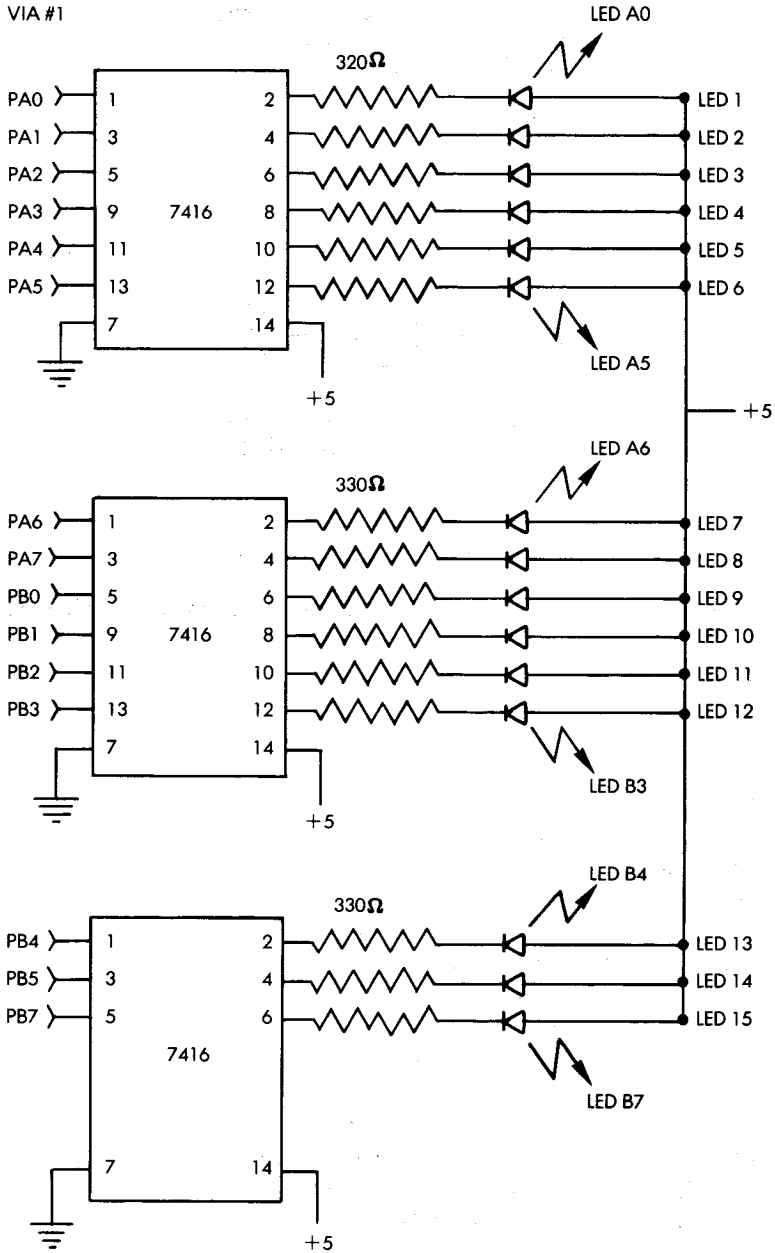


**Fig. 1.9: Decoder Connection to Keyboard**

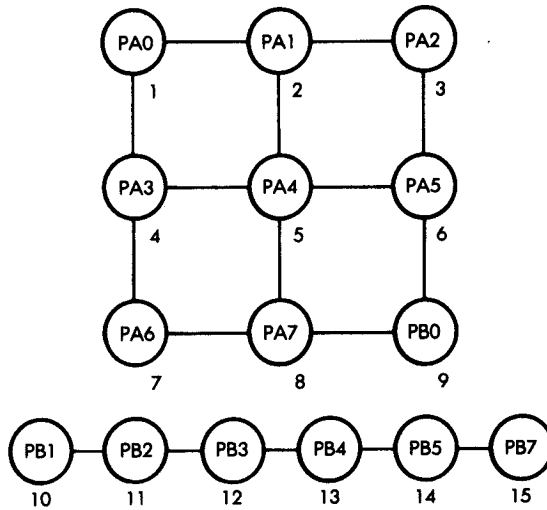


**Fig. 1.10: Detecting a Key Closure**

# ADVANCED 6502 PROGRAMMING



**Fig. 1.11: LED Connection**



**Fig. 1.12: LED Arrangement on the Board**

The resistors shown in Figure 1.11 are 330-ohm resistors designed as current limiters for the 7416 gates.

The output routines will be described in the context of specific games.

### Required Parts

- One 6'' × 9'' vector-board
- One 4-to-16 decoder (74154)
- Three inverting hex drivers (7416)
- One 24-pin socket
- Three 14-pin sockets (for the drivers)
- One 16-key keyboard, unencoded
- Fifteen 330-ohm resistors
- One 3.3 K-ohm resistor
- One decoupling capacitor (.1 mF)
- Fifteen LEDs
- One speaker
- One 50-ohm or 110-ohm resistor (for the speaker)
- Two 15''-20'' long 16-conductor ribbon cables
- One package of wire-wrap terminal posts
- Wire-wrap wire
- Solder

A soldering iron and a wire-wrapping tool will also be required.

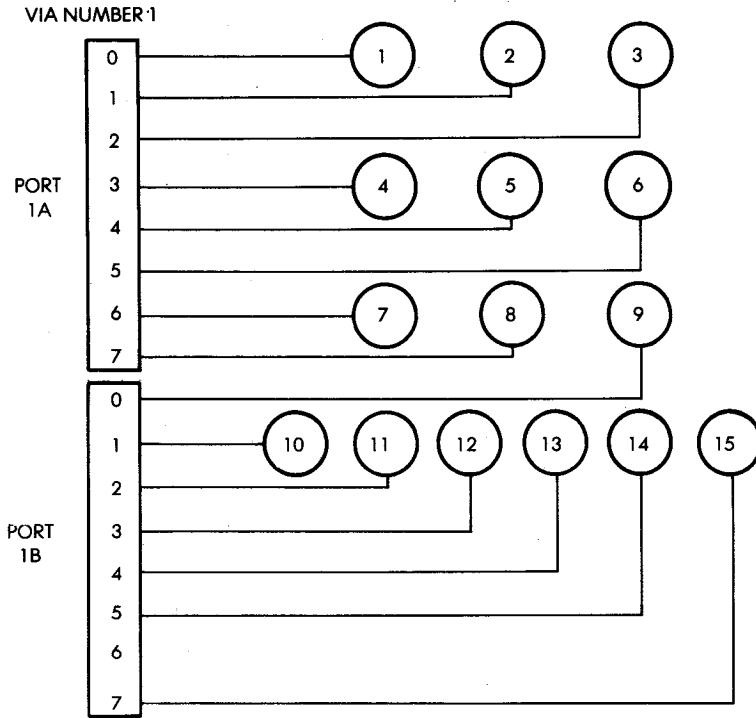
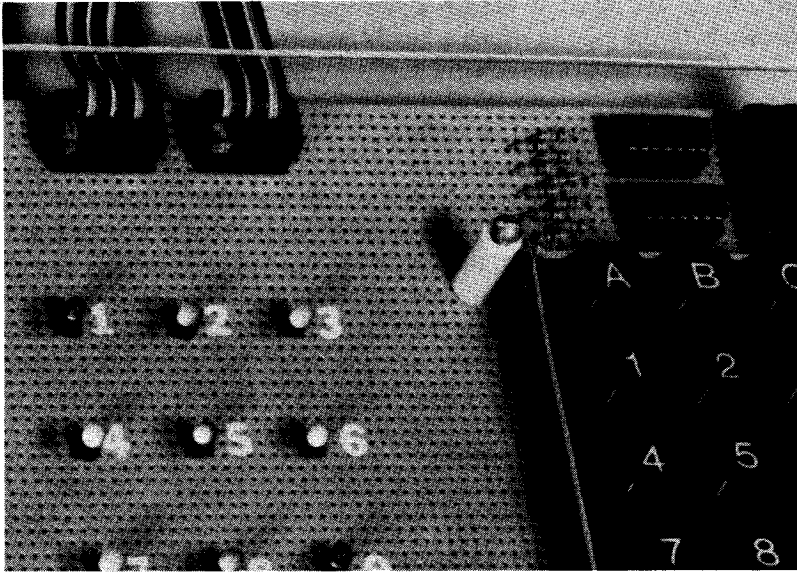


Fig. 1.13: Detail of LED Connection to the Ports

### Assembly

A suggested assembly procedure is the following: the keyboard can be glued directly to the perf board. Sockets and LEDs can be positioned on the board and held in place temporarily with tape. All connections can then be wire-wrapped. In the case of the prototype, the connections to the keyboard were soldered in order to provide reliable connections since they were not designed as wire-wrap leads. Wire-wrap terminal posts were used for common connections.

Additionally, on the prototype two sockets were provided for convenience when attaching the ribbon cable connector to the Games Board. They are not indispensable, but their use is strongly suggested in order to be able to conveniently plug and unplug cables. (They appear in the top left corner of the photograph in Figure 1.14.) A 14-pin socket and a 16-pin socket are used for this purpose. Wire-wrap terminal posts can be used instead of these sockets to attach the ribbon cable directly to the perf board. The other end of the ribbon cable is



**Fig. 1.14: Games Board Detail**

simply attached to the edge connectors of the SYM. When connecting the ribbon cable at either end, always be very careful to connect it to the appropriate pins (do not connect it upside down). The Games Board derives its power from the SYM through the ribbon cable connection. Connecting the cable in reverse will definitely have adverse effects.

The speaker may be connected to any one of the output drivers PB4, PB5, PB6, or PB7 of VIA #3. Each of these output ports is equipped with a transistor buffer. A 110-ohm current-limiting resistor is inserted in series with the speaker.

### **THE KEYBOARD INPUT ROUTINE**

This routine, called "GETKEY," is a utility routine which will scan the keyboard and identify the key that was pressed. The corresponding code will be contained in the accumulator. It has provisions for bounce, repeat, and rollover.

Keyboard bounce is eliminated by implementing a 50 ms delay upon detection of key closure.

The repeat problem is solved by waiting for the key currently

pressed to be released before a new value is accepted. This corresponds to the case in which a key is pressed for an extended period of time. Upon entering the GETKEY routine, a key might already be depressed. It will be ignored until the program detects that a key is no longer pressed. The program will then wait for the next key closure. If the processing program using the GETKEY routine performs long computations, there is a possibility that the user may push a new key on the keyboard before GETKEY is called again. This key closure will be ignored by GETKEY, and the user will have to press the key again.

Most of the programs described in this book have audible prompts in the form of a tone which is generated every time the player should respond. Note that when a tone is being generated or during a delay loop in a program, pressing a key will have absolutely no effect.

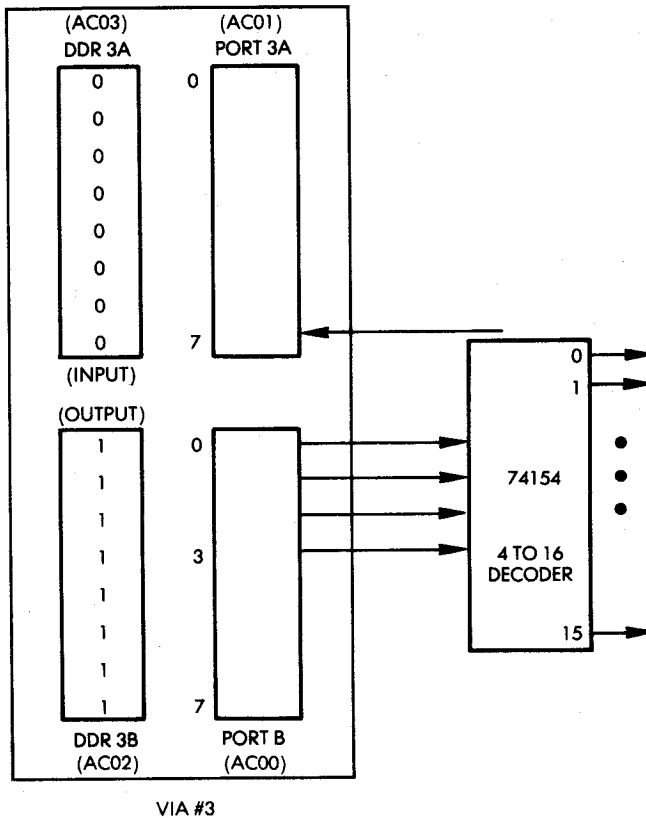


Fig. 1.15: VIA Connection to Keyboard Decoder

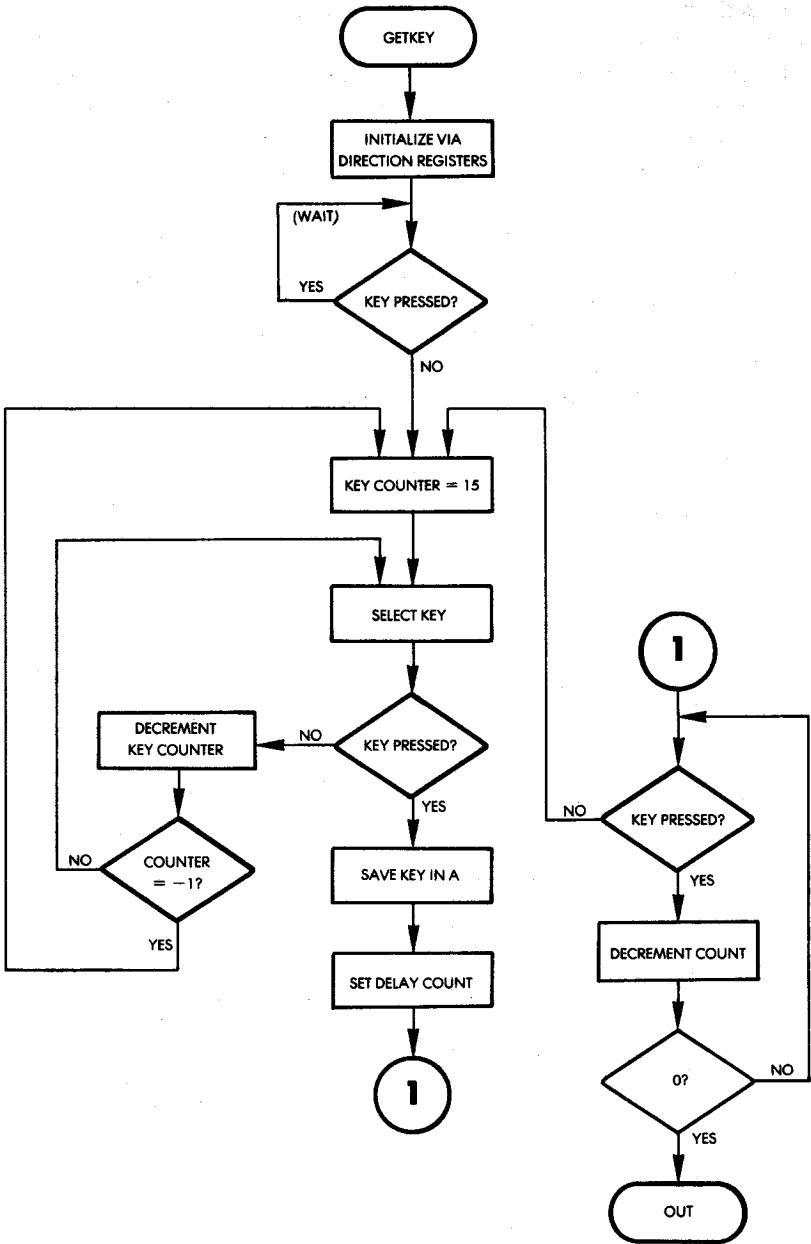


Fig. 1.16: GETKEY Flowchart



## ADVANCED 6502 PROGRAMMING

The hardware configuration for the GETKEY routine is shown in Figure 1.9. The corresponding input/output chip on the SYM is shown in Figure 1.15. VIA #3 of the SYM board is used to communicate with the keyboard. Port B of the VIA is configured for output and lines 0 through 3 are gated to the 74154 (4-to-16 decoder), connected to the keyboard itself. The GETKEY routine will output the hexadecimal numbers "0" through "F," in sequence, to the 74154. This will result in the grounding of the corresponding output line of the 74154. If a key is pressed, bit 7 of VIA #3 of Port A will be grounded. The program logic is, therefore, quite simple, and the corresponding flowchart is shown in Figure 1.16.

The program is shown in Figure 1.17. Let us examine it. The GETKEY routine can be relocated, i.e., it may be put anywhere in the memory. In order to conserve space, it has been located at memory locations 100 to 12E. It is important to remember that this is the low stack memory area. Any user programs which might require a full stack would overwrite this routine and thus destroy it. To prevent this possibility, it could be located elsewhere. For all of the programs that will be developed in this book, however, this placement is adequate. The first four instructions of the routine condition the data direction registers of VIA #3. The data direction register for Port A is set for input (all zeroes), while the data direction register for Port B is set for output (all ones). This is illustrated in Figure 1.15.

```
LDA #0
STA DDR3A
LDA #$FF
STA DDR3B
```

Two instructions are required to test bit 7 of Port 3A, which indicates whether a key closure has occurred:

```
START      BIT PORT3A
           BPL START
```

The key counter is initially set to the value 15, and will be decremented until a key closure is encountered. Index register X is used to contain this value, as it can readily be decremented with the DEX instruction:

```
RSTART    LDX #15
```

This value (15) is then output to the 74154 and results in the selection

```

;GETKEY' KEYBOARD INPUT ROUTINE
;READS AND DEBOUNCES KEYBOARD, RETURNS WITH KEY NUMBER
;IN ACCUMULATOR IF KEY DOWN.
;OPERATION: SENDS NUMBERS 0-F TO 74154 (4 TO 16
;LINE DECODER), WHICH GROUNDS ONE SIDE OF KEYSWITCHES
;ONE AT A TIME. IF A KEY IS DOWN, PA7 OF VIA #3 WILL BE
;GROUNDED, AND THE CURRENT VALUE APPLIED TO THE 74154 W
;BE THE KEY NUMBER. WHEN THE PROGRAM DETECTS A KEY CLOS
;CHECKS FOR KEY CLOSURE FOR 50 MS. TO ELIMINATE BOUNCE.
;NOTE: IF NO KEY IS PRESSED, GETKEY WILL WAIT.
;
;
;      .=$100           ;NOTE: GETKEY IS IN LOW STACK
DDR3A  = $AC03         ;DATA DIRECTION REG A FOR VIA #3
DDR3B  = $AC02         ;DATA DIRECTION REG B FOR VIA #3
PORT3A = $AC01         ;VIA#3 PORT A IN/OUT REGS
PORT3B = $AC00         ;VIA#3 PORT B IN/OUT REGS
;
0100: A9 00           LDA #0
0102: BD 03 AC       STA DDR3A           ;SET KEY STROBE PORT FOR INPUT
0105: A9 FF           LDA #$FF
0107: BD 02 AC       STA DDR3B           ;SET KEY# PORT FOR OUTPUT
010A: 2C 01 AC START BIT PORT3A       ;SEE IF KEY IS STILL DOWN FROM
;LAST KEY CLOSURE: KEYSTOBE IN 'N'
;STATUS BIT.
010D: 10 FB           BPL START           ;IF YES, WAIT FOR KEY RELEASE
010F: A2 0F RSTART  LDX #15           ;SET KEY# COUNTER TO 15
0111: BE 00 AC NXTKEY STX PORT3B       ;OUTPUT KEY # TO 74154
0114: 2C 01 AC       BIT PORT3A       ;SEE IF KEY DOWN: STROBE IN 'N'
0117: 10 05           BPL BOUNCE       ;IF YES, GO DEBOUNCE
0119: CA             DEX               ;DECREMENT KEY #
011A: 10 F5           BPL NXTKEY       ;NO, DO NEXT KEY
011C: 30 F1 RSTART  BMI RSTART         ;START OVER.
011E: 8A BOUNCE     TXA               ;SAVE KEY NUMBER IN A
011F: A0 12           LDY #12         ;OUTER LOOP CNT LOAD FOR
;DELAY OF 50 MS.
0121: A2 FF LP1     LDX #$FF         ;INNER 11 US. LOOP
0123: 2C 01 AC LP2     BIT PORT3A     ;SEE IF KEY STILL DOWN
0126: 30 E7 RSTART  BMI RSTART         ;IF NOT, KEY NOT VALID, RESTART
0128: CA             DEX               ;
0129: D0 F8 LP2     BNE LP2           ;THIS LOOP USES 2115*5 US
012B: 88             DEY               ;
012C: D0 F3 LP1     BNE LP1           ;OUTER LOOP: TOTAL IS 50 MS.
012E: 60             RTS             ;DONE: KEY# IN A.

SYMBOL TABLE:
DDR3A  AC03           DDR3B  AC02           PORT3A  AC01
PORT3B AC00           START  010A         RSTART  010F
NXTKEY 0111         BOUNCE 011E         LP1     0121
LP2     0123
DONE

```

Fig. 1.17: GETKEY Program

of line 17 connected to key 15 (“F”). The BIT instruction above is used to test the condition of bit 7 of Port 3A to determine whether this key has been pressed.

```

NXTKEY    STX PORT3B
           BIT PORT3A
           BPL BOUNCE

```

If the key were closed, a branch would occur to “BOUNCE,” and a

delay would be implemented to debounce it; otherwise, the counter is decremented, then tested for underflow. As long as the counter does not become negative, a branch back occurs to location NXTKEY. This loop is repeated until a key is found to be depressed or the counter becomes negative. In that case, the routine loops back to location RSTART, restarting the process:

```

DEX
BPL NXTKEY
BMI RSTART
    
```

Note that this will result in the detection of the highest key pressed in the case in which several keys are pressed simultaneously. In other words, if keys “F” and “3” were pressed simultaneously, key “F” would be identified as depressed, while key “3” would be ignored. Avoiding this problem is called *multiple-key rollover protection* and will be suggested as an exercise:

**Exercise 1-1:** *In order to avoid the multiple-key rollover problem, modify the GETKEY routine so that all 15 key closures are monitored. If more than one key is pressed, the key closure is to be ignored until only one key closure is sensed.*

Once the key closure has been identified, the corresponding key number is saved in the accumulator. A delay loop is then implemented in order to provide a 50 ms debouncing time. During this loop, the key closure is constantly monitored. If the key is released, the routine is restarted. The delay itself is implemented using a standard two-level, nested loop technique.

```

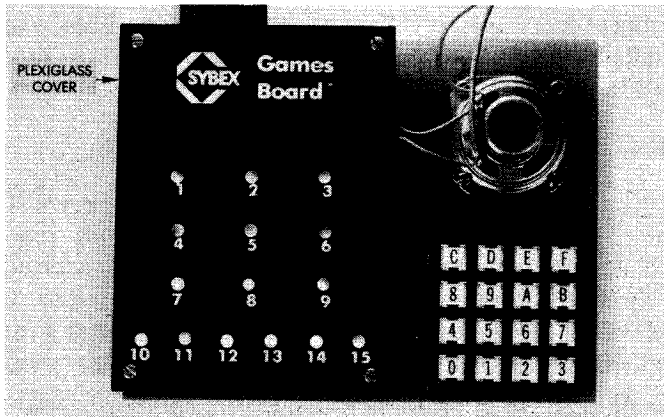
BOUNCE    TXA
          LDY #$12
LP1       LDX #$FF
LP2       BIT PORT3A
          BMI RSTART
          DEX
          BNE LP2
          DEY
          BNE LP1
    
```

**Exercise 1-2:** *The value used for the outer loop counter (“\$12,” or 12 hexadecimal) may not be quite accurate. Compute the exact duration*

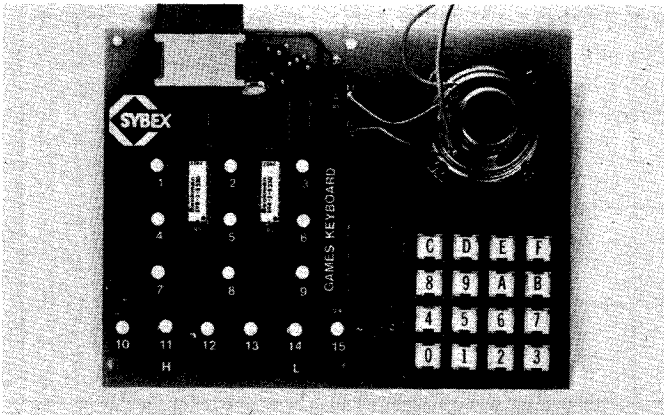
*of the delay implemented by the instructions above, using the tables showing the duration of each instruction in the Appendix.*

## SUMMARY

Executing the games programs requires a simple Games Board which provides the basic input/output facilities. The required hardware and software interface has been described in this chapter. Photographs of the assembled board which evolved from the prototype are shown in Figures 1.18 and 1.19.



**Fig. 1.18: "Production" Games Board**



**Fig. 1.19: Removing the Cover**

## 2. Generating Square Waves (Music Player)

### INTRODUCTION

This program will teach you how to synthesize frequencies by generating square waves. It will use a table-driven algorithm to generate tones and play music. It will make systematic use of indexed addressing techniques.

### THE RULES

This game allows music to be played directly on the keyboard of a computer. In addition, the program will simultaneously record the notes that are played, and then automatically play them back upon request. Keys "0" through "C" on the keyboard are used to play the musical notes. (See Figure 2.1.) Key "D" is used to specify a rest. Key "E" is used to play back the musical sequence stored in the memory. Finally, key "F" is used to clear the memory, i.e., to start a new game. The following paragraph will describe the usual sequence of the game.

A (A)	B (B)	C (C)	D (REST)
1 (A)	2 (B)	3 (C)	E (PBK)
4 (D)	5 (E)	6 (F)	F (RST)
7 (F#)	8 (G)	9 (G#)	0 (G)

KEY NUMBER	NOTE	KEY NUMBER	NOTE
0	G	8	G
1	A	9	G#
2	B	A	A
3	C	B	B
4	D	C	C
5	E	D	REST
6	F	E	PLAY BACK
7	F#	F	RESTART

Fig. 2.1: Playing Music on the Keyboard

**9th Symphony:**

5-5-6-8-8-8-6-5-4-3-3-4-5-5-4-4-D-5-  
 5-6-8-8-6-5-4-3-3-4-5-4-3-3-D-4-4-  
 5-3-4-6-5-3-4-6-5-4-3-4-D

**Clementine:**

3-3-3-D-2-D-5-5-5-D-3-D-3-5-8-D-D-  
 8-6-5-4-D-D-D-4-5-6-D-6-D-5-4-5-D-  
 3-D-3-5-4-D-D-2-3-4-3

**Frere Jacques:**

3-4-5-3-3-4-5-3-5-6-8-D-5-6-8-D-8-  
 A-8-6-5-D-3-D-8-A-8-6-5-D-3-D-3-D-  
 2-D-3-D-D-D-3-D-2-D-3

**Jingle Bells:**

5-5-5-D-5-5-5-D-5-8-3-4-5-D-D-D-6-  
 6-6-6-6-5-5-5-8-8-6-4-3

**London Bridge:**

8-A-8-6-5-6-8-D-4-5-6-D-5-6-8-D-8-  
 A-8-6-5-6-8-D-4-D-8-D-5-3

**Mary Had a Little Lamb:**

5-4-3-4-5-5-5-D-4-4-4-D-5-8-8-D-5-  
 4-3-4-5-5-5-5-4-4-5-4-3

**Row Row Row Your Boat:**

3-D-3-D-3-4-5-D-5-4-5-6-8-D-D-D-C-  
 C-8-8-5-5-3-3-8-6-5-4-3

**Silent Night:**

8-D-D-A-8-D-5-D-D-D-8-D-D-A-8-D-5-  
 D-D-D-3-D-D-3-D-B-D-D-D-C-D-D-C-  
 D-8-D-D-C-D-8-5-8-D-6-D-4-D-3

**Twinkle Twinkle Little Star:**

3-3-8-8-A-A-8-D-6-6-5-5-4-4-3-D-8-  
 8-6-6-5-5-4-D-3-3-8-8-A-A-8-D-6-6-  
 5-5-4-4-3

Fig. 2.2: Simple Tunes for Computer Music

## A TYPICAL GAME

Press key "F" to start a new game. A three-note warble will be heard, confirming that the internal memory has been erased. Play the tune on keys "O" through "D" (using the notes and the rest features). Up to 254 notes may be played and stored in the memory. At any point, the playback key ("E") may be pressed and the notes and rests that were just played on the keyboard (and simultaneously stored in the memory) will be reproduced. The musical sequence may be played as many times as desired by simply pressing key "E." Examples of simple tunes or musical sequences that can be played on the computer are shown in Figure 2.2.

## THE CONNECTIONS

This game uses the keyboard plus the speaker. The speaker is connected in series to one of the buffered output lines of PORT B of VIA #3, via a 110-ohm current limiting resistor. PB4, PB5, PB6, or PB7 of VIA #3 are used, as they are driven by a transistor buffer on the SYM. For higher quality music, it is recommended that the speaker be placed in a small box-type enclosure. The value of the resistor may also be adjusted for louder volume (without going below 50-ohm) to limit the current in the transistor.

## THE ALGORITHM

A tone (note) is simply generated by sending a square wave of the appropriate frequency to the speaker, i.e., by turning it on and off at the required frequency. This is illustrated in Figure 2.3. The length of time during which the speaker is on or off is known as the half-period. In this program, the frequency range of 195 to 523 Hertz is provided. If N is the frequency, the period T is the inverse of the frequency, or:

$$T = 1/N$$

Therefore, the half-periods will range from  $1/(2 \times 195) = .002564$  to

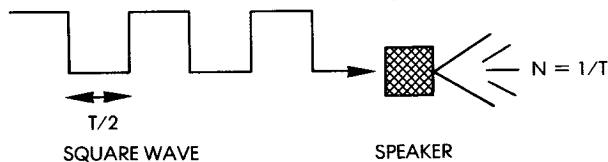


Fig. 2.3: Generating a Tone

$1/(2 \times 523) = .000956$  seconds. A classic loop delay will be used to implement the required frequency.

Actual computations for the various program parameters will be presented below.

## THE PROGRAM

The program is located at memory addresses 200 through 2DD, and the recorded musical sequence or tune is stored starting at memory location 300. Up to 254 notes may be recorded in 127 bytes.

### Data Structures

Three tables are used in this program. They are shown in Figure 2.4. The recorded tune is stored in a table starting at address 300. The note constants, used to establish the frequency at which the speaker will be toggled, are stored in a 16-byte table located at memory address 2C4. The note durations, i.e., the number of half-cycles required to implement a uniform note duration of approximately .21 second, are stored in a 16-byte table starting at memory address 2D1. Within the tune table, two "nibble"-pointers are used: PILEN during input and PTR during output. (Each 8-bit byte in this table contains two notes.) In order to obtain the actual table entry from the nibble-pointer, the pointer is simply shifted one bit position to the right. The remaining value becomes a byte-pointer, while the bit shifted into the carry flag specifies the left or the right half of the byte. The two tables called CONSTANTS and NOTE DURATIONS are simply reference tables used to determine the half-frequency of a note and the number of times the speaker should be triggered once a note has been identified or specified. Both of these tables are accessed indirectly using the X register.

### Some Music Theory

A brief survey of general music conventions is in order before describing the actual program. The frequencies used to generate the desired notes are derived from the equally tempered scale, in which the frequencies of succeeding notes are in the ratio:

$$1 : \sqrt[12]{2}$$

The frequencies for the middle C octave are given in Figure 2.5. When computing the corresponding frequencies of the higher or the



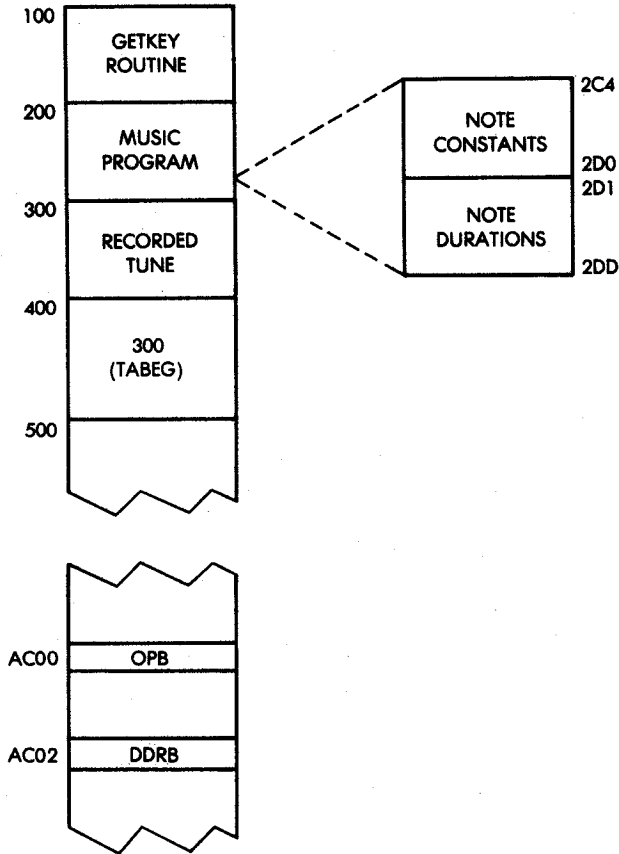


Fig. 2.4: Memory Map

lower octave, they are simply obtained by multiplying by two, or dividing by two, respectively.

### Generating the Tone

The half-period delay for the square wave sent to the speaker is implemented using a program loop with a basic  $10 \mu s$  cycle time. In the program, the "loop index," or iteration counter is used to count the number of  $10 \mu s$  cycles executed. The loop will result in a total delay of:

$$(\text{loop index}) \times 10 - 1 \text{ microseconds}$$

## GENERATING SQUARE WAVES

NOTE	FREQUENCY (HERTZ)
A	220.00
A#	223.08
B	246.94
C	261.62
C#	277.18
D	293.66
D#	311.13
E	329.63
F	349.23
F#	369.99
G	391.99
G#	415.30

**Fig. 2.5: Frequencies for the Middle C Octave**

On the last iteration of the loop (when the loop index is decremented to zero), the branch instruction at the end will fail. This branch instruction will execute faster, so that one microsecond (assuming a 1 MHz clock) must be subtracted from the total delay duration. The tone generation routine is shown below:

```

TONE      STA  FREQ
          LDA  #$FF
          STA  DDRB
          LDA  #$00
          LDX  DUR
FL2       LDY  FREQ
FL1       DEY
          CLC
          BCC  .+ 2
          BNE  FL1
          EOR  #$FF
          STA  OPB
          DEX
          BNE  FL2
          RTS
    
```

INNER  
LOOP

OUTER  
LOOP

Note the “classic” nested loop design. Every time it is entered, the outer loop adds an additional thirteen microseconds delay: 14 microseconds for the extra instructions (LDY, EOR, STA, DEX, and

BNE), minus one microsecond for responding to the unsuccessful inner loop branch. The total outer loop delay introduced is therefore:

$$(\text{loop index}) \times 10 + 13 \text{ microseconds}$$

Remember that one pass through the outer loop represents only a half-period for the note.

### Computing the Note Constants

Let "ID" be the inner loop delay and "OD" be the outer loop additional delay. It has been established in the previous paragraph that the half-period is  $T/2 = (\text{loop index}) \times 10 + 13$  or,

$$T/2 = (\text{loop index}) \times ID + OD$$

The note constant stored in the table is the value of the "index" required by the program. It is easily derived from the equation that:

$$\text{note constant} = \text{loop index} = (T - 2 \times OD)/2 \times ID$$

The period may be expressed in function of the frequency as  $T = 1/N$  or, in microseconds:

$$T = 10^6/N$$

Finally, the above equation becomes:

$$\text{note constant} = (10^6/N - 2 \times OD)/2 \times ID$$

For example, let us compute the note constant corresponding to the frequency for middle C. The frequency corresponding to middle C is shown in Figure 2.5. It is 261.62 Hertz. The "OD" delay has been shown above to be 13 microseconds, while "ID" was set to 10 microseconds. The note constant equation becomes:

$$\begin{aligned} \text{note constant} &= (10^6/N - 2 \times 13)/2 \times 10 \\ &= \frac{1000000/261.62 - 26}{20} \\ &= 190 \text{ (or BE in hexadecimal)} \end{aligned}$$

It can be verified that this corresponds to the fourth entry in the table

NOTE		NOTE	CONSTANT	NOTE	CONSTANT
BELOW MIDDLE C } G A B	FE E2 C9	MIDDLE C } C D E F F# G G# A B	BE	ABOVE MIDDLE C } C	5E
			A9		
			96		
			8E		
			86		
			7E		
			77		
			70		
			64		

Fig. 2.6: Note Constants

at address NOTAB (see Figure 2.9 at the end of the listing, at address 02C4). The note constants are shown in Figure 2.6.

**Exercise 2-1:** Using the table in Figure 2.6, compute the corresponding frequency, and check to see if the constants have been chosen correctly.

### Computing the Note Durations

The DURTAB table stores the note durations expressed in numbers equivalent to the number of half-cycles for each note. These durations have been computed to implement a uniform duration of approximately .2175 second per note. If D is the duration and T is the period, the following equation holds:

$$D \times T = .2175$$

where D is expressed as a number of periods. Since, in practice, half-periods are used, the required number D' of half-periods is:

$$D' = 2D = 2 \times .2175 \times N$$

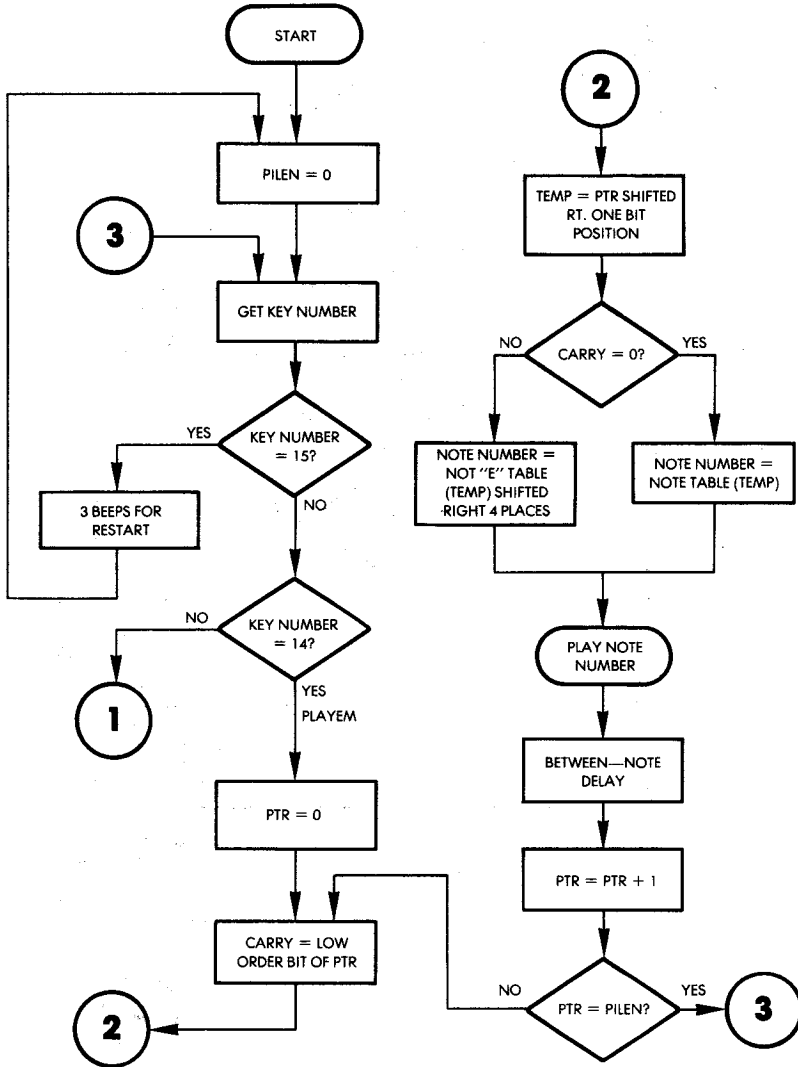
For example, in the case of the middle C:

$$D = 2 \times .2175 \times 261.62 = 133.8 \approx 114 \text{ decimal (or 72 hexadecimal)}$$

**Exercise 2-2:** Compute the note durations using the equation above, and the frequency table in Figure 2.5 (which needs to be expanded). Verify that they match the numbers in table DURTAB at address 2D1. (See Figure 2.9)

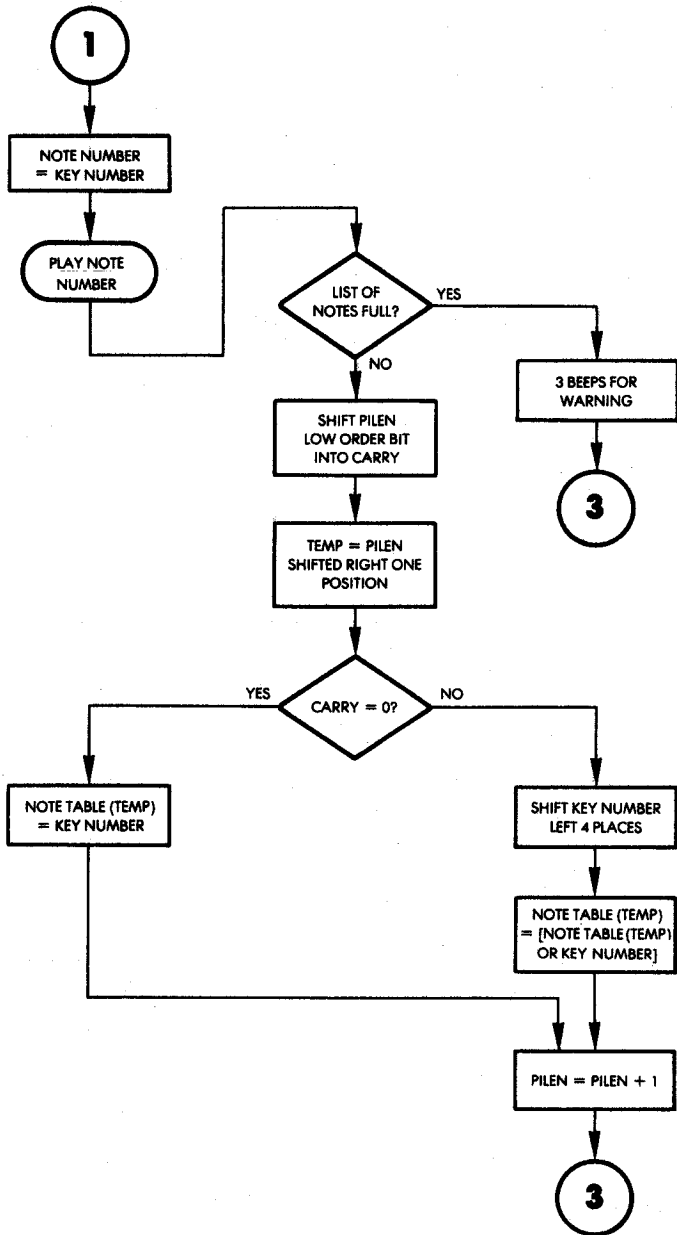
**Program Implementation**

The program has been structured in two logical parts. The corresponding flowchart is shown in Figure 2.7. The first part of the program is responsible for collecting the notes and begins at label



**Fig. 2.7: Music Flowchart**

# GENERATING SQUARE WAVES



**Fig. 2.7: Music Flowchart (Continued)**

“NUMKEY.” (The program is shown in Figure 2.9). The second part begins at the label “PLAYEM” and its function is to play the stored notes. Both parts of the program use the PLAYNOTE subroutine which looks up the note and duration constants, and plays the note. This routine begins at the label “PLAYIT,” and its flowchart is shown in Figure 2.8.

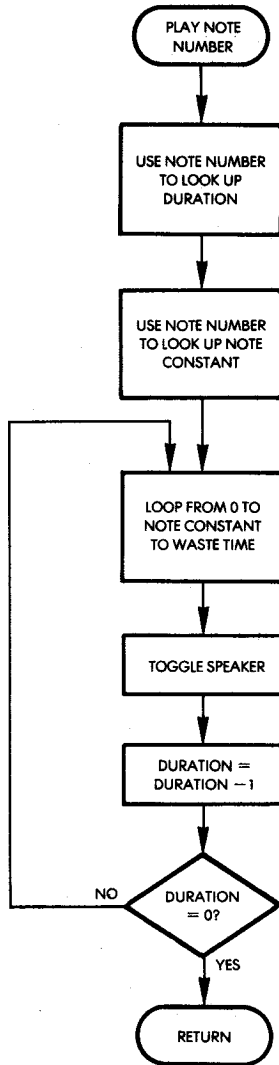


Fig. 2.8: PLAYIT Flowchart

## GENERATING SQUARE WAVES

```

; MUSIC PLAYER PROGRAM
; USES 16 - KEY KEYBOARD AND BUFFERED SPEAKER
;PROGRAM PLAYS STORED MUSICAL NOTES.
;THERE ARE TWO MODES OF OPERATION: INPUT AND PLAY.
;INPUT MODE IS THE DEFAULT, AND ALL NON-COMMAND KEYS
;PRESSED (O-D) ARE STORED FOR REPLAY, IF AN OVERFLOW
;OCCURS, THE USER IS WARNED WITH A THREE-TONE WARNING.
;THE SAME WARBLING TONE IS ALSO USED TO SIGNAL A
;RESTART OF THE PROGRAM.
;
GETKEY = $100
PILEN = $00          ;LENGTH OF NOTE LIST
TEMP = $01          ;TEMPORARY STORAGE
PTR = $02          ;CURRENT LOCATION IN LIST
FREQ = $03          ;TEMPORARY STORAGE FOR FREQUENCY
DUR = $04          ;TEMP STORAGE FOR DURATION
TABEG = $300        ;TABLE TO STORE MUSIC
OFB = $AC00         ;VIA OUTPUT PORT B
DDBR = $AC02        ;VIA PORT B DIRECTION REGISTER
. = $200           ;ORIGIN
;
;COMMAND LINE INTERPRETER
; $F AS INPUT MEANS RESET POINTERS, START OVER.
; $E MEANS PLAY CURRENTLY STORED NOTES
; ANYTHING ELSE IS STORED FOR REPLAY.
;
0200: A9 00      START LDA #0          ;CLEAR NOTE LIST LENGTH
0202: 85 00          STA PILEN
0204: 18          CLC          ;CLEAR NIBBLE MARKER
0205: 20 00 01    NXKEY JSR GETKEY
0206: C9 0F          CMP #15        ;IS KEY #15?
020A: D0 05          BNE NXTST    ;NO, DO NEXT TEST
020C: 20 87 02    JSR BEEP3      ;TELL USER OF CLEARING
020F: 90 EF          BCC START    ;CLEAR POINTERS AND START OVER
0211: C9 0E          NXTST CMP #14    ;IS KEY #14?
0213: D0 04          BNE NUMKEY    ;NO, KEY IS NOTE NUMBER
0215: 20 48 02    JSR PLAYEM     ;PLAY NOTES
0218: 18          CLC
0219: 90 EA          BCC NXKEY     ;GET NEXT COMMAND
;
;ROUTINE TO LOAD NOTE LIST WITH NOTES
;
021B: 85 01      NUMKEY STA TEMP    ;SAVE KEY, FREE A
021D: 20 70 02    JSR PLAYIT     ;PLAY NOTE
0220: A5 00          LDA PILEN     ;GET LIST LENGTH
0222: C9 FF          CMP #$FF     ;OVERFLOW?
0224: D0 05          BNE OK        ;NO, ADD NOTE TO LIST
0226: 20 87 02    JSR BEEP3      ;YES, WARN USER
0229: 90 DA          BCC NXKEY     ;RETURN TO INPUT MODE
022B: 4A          OK LSR A        ;SHIFT LOW BIT INTO NIBBLE POINTER
022C: A8          TAY          ;USE SHIFTED NIBBLE POINTER AS
;BYTE INDEX
022D: A5 01          LDA TEMP      ;RESTORE KEY#
022F: B0 09          BCS FINBYT    ;IF BYTE ALREADY HAS 1 NIBBLE,
;FINISH IT AND STORE
0231: 29 0F          AND #$00001111 ;1ST NIBBLE, MASK HIGH NIBBLE
0233: 99 00 03    STA TABEG,Y    ;SAVE UNFINISHED 1/2 BYTE
0236: E6 00          INC PILEN     ;POINT TO NEXT NIBBLE
023B: 90 CB          BCC NXKEY     ;GET NEXT KEYSTROKE
023A: 0A          FINBYT ASL A     ;SHIFT NIBBLE 2 TO HIGH ORDER
023B: 0A          ASL A
023C: 0A          ASL A
023D: 0A          ASL A
023E: 19 00 03    ORA TABEG,Y    ;JOIN 2 NIBBLES AS BYTE
0241: 99 00 03    STA TABEG,Y    ;...AND STORE.
0244: E6 00          INC PILEN     ;POINT TO NEXT NIBBLE IN NEXT BYTE
0246: 90 BD          BCC NXKEY     ;RETURN

```

**Fig. 2.9: Music Program**



# ADVANCED 6502 PROGRAMMING

```

;
; ROUTINE TO PLAY NOTES
;
0248: A2 00   PLAYEM LDX #0           ;CLEAR POINTER
024A: B6 02           STX PTR
024C: A5 02           LDA PTR           ;LOAD ACUM W/CURRENT PTR VAL
024E: 4A           LOOP   LSR A           ;SHIFT NIBBLE INDICATOR INTO CARRY
024F: AA           TAX           ;USE SHIFTED NIBBLE POINTER
;AS BYTE POINTER
0250: BD 00 03       LDA TABEG,X       ;LOAD NOTE TO PLAY
0253: B0 04           BCS ENDBYT       ;LOW NIBBLE USED, GET HIGH
0255: 29 0F           AND #%00001111   ;MASK OUT HIGH BITS
0257: 90 06           BCC FINISH       ;PLAY NOTE
0259: 29 F0       ENDBYT AND #%11110000   ;THROW AWAY LOW NIBBLE
025B: 4A           LSR A           ;SHIFT INTO LOW
025C: 4A           LSR A
025D: 4A           LSR A
025E: 4A           LSR A
025F: 20 70 02   FINISH JSR PLAYIT       ;CALCULATE CONSTANTS & PLAY
0262: A2 20           LDX #*20         ;BETWEEN-NOTE DELAY
0264: 20 9C 02       JSR DELAY
0267: E6 02           INC PTR           ;ONE NIBBLE USED
0269: A5 02           LDA PTR
026B: C5 00           CMP PILEN        ;END OF LIST?
026D: 90 DF           BCC LOOP         ;NO, GET NEXT NOTE
026F: 60           RTS           ;DONE

;
;ROUTINE TO DO TABLE LOOK UP, SEPARATE REST
;
0270: C9 0D       PLAYIT CMP #13           ;REST?
0272: D0 06           BNE SOUND       ;NO.
0274: A2 54           LDX #*54         ;DELAY=NOTE LENGTH=.21SEC
0276: 20 9C 02       JSR DELAY
0279: 60           RTS
027A: AA           SOUND  TAX           ;USE KEY# AS INDEX..
027B: BD D1 02       LDA DURTAB,X     ;...TO FIND DURATION.
027E: 85 04           STA DUR          ;STORE DURATION FOR USE
0280: BD C4 02       LDA NOTAB,X     ;LOAD NOTE VALUE
0283: 20 AB 02       JSR TONE
0286: 60           RTS

;
;ROUTINE TO MAKE 3 TONE SIGNAL
;
0287: A9 FF       BEEP3  LDA #*FF       ;DURATION FOR BEEPS
0289: 85 04           STA DUR
028B: A9 4B           LDA #*4B         ;CODE FOR E2
028D: 20 AB 02       JSR TONE         ;1ST NOTE
0290: A9 3B           LDA #*3B         ;CODE FOR D2
0292: 20 AB 02       JSR TONE
0295: A9 4B           LDA #*4B
0297: 20 AB 02       JSR TONE
029A: 1B           CLC
029B: 60           RTS

;
;VARIABLE-LENGTH DELAY
;
029C: A0 FF       DELAY LDY #*FF
029E: EA           DLY   NOP
029F: D0 00           BNE .+2
02A1: 8B           DEY
02A2: D0 FA           BNE DLY         ;10 US LOOP
02A4: CA           DEX
02A5: D0 F5           BNE DELAY       ;LOOP TIME = 2556*[X]
02A7: 60           RTS

;
;ROUTINE TO MAKE TONE: # OF 1/2 CYCLES IS IN 'DUR',
;AND 1/2 CYCLE TIME IS IN A. LOOP TIME=20*[A]+26 US

```

**Fig. 2.9: Music Program (Continued)**

# GENERATING SQUARE WAVES

```

;SINCE TWO RUNS THROUGH THE OUTER LOOP MAKES
;ONE CYCLE OF THE TONE.
;
02A8: 85 03      TONE STA FREQ      ;FREQ IS TEMP FOR # OF CYCLES
02AA: A9 FF      LDA #$FF      ;SET UP DATA DIRECTION REG
02AC: 8D 02 AC   STA DDRB
02AF: A9 00      LDA #$00      ;A IS SENT TO PORT, START HI
02B1: A6 04      LDX DUR
02B3: A4 03      FL2 LDY FREQ
02B5: 88         FL1 DEY
02B6: 18         CLC
02B7: 90 00      BCC .+2
02B9: D0 FA      BNE FL1      ;INNER, 10 US LOOP
02BB: 49 FF      EOR #$FF      ;COMPLEMENT I/O PORT
02BD: 8D 00 AC   STA OPB      ;...AND SET IT
02C0: CA         DEX
02C1: D0 F0      BNE FL2      ;OUTER LOOP
02C3: 60         RTS

;TABLE OF NOTE CONSTANTS
;CONTAINS:
;COCTAVE BELOW MIDDLE C3 : G,A,B
;COCTAVE OF MIDDLE C3 : C,D,E,F,F#,G,G#,A,B
;COCTAVE ABOVE MIDDLE C3 : C
;
02C4: FE      NOTAB .BYT $FE,$E2,$C9,$BE,$A9,$96,$8E
02C5: E2
02C6: C9
02C7: BE
02C8: A9
02C9: 96
02CA: 8E
02CB: 86      .BYT $86,$7E,$77,$70,$64,$5E
02CC: 7E
02CD: 77
02CE: 70
02CF: 64
02D0: 5E

;TABLE OF NOTE DURATIONS IN # OF 1/2 CYCLES
;SET FOR A NOTE LENGTH OF ABOUT .21 SEC.
;
02D1: 55      DURTAB .BYT $55,$60,$6B,$72,$80,$8F,$94
02D2: 60
02D3: 6B
02D4: 72
02D5: 80
02D6: 8F
02D7: 94
02D8: A1      .BYT $A1,$AA,$B5,$BF,$D7,$E4
02D9: AA
02DA: B5
02DB: BF
02DC: D7
02DD: E4

SYMBOL TABLE:
GETKEY  0100      FILEN      0000      TEMP      0001
PTR     0002      FREQ      0003      DUR      0004
TABEG   0300      OPB       AC00      DDRB     AC02
START   0200      NXKEY     0205      NXTST    0211
NUMKEY  021B      OK        022B      FINBYT   023A
PLAYEM  0248      LOOP      024E      ENDBYT   0259
FINISH  025F      PLAYIT    0270      SOUND    027A
BEEP3   0287      DELAY     029C      DLY      029E
TONE    02A8      FL2       02B3      FL1      02B5
NOTAB   02C4      DURTAB    02D1

%
```

**Fig. 2.9: Music Program (Continued)**

## ADVANCED 6502 PROGRAMMING

The main routines are called, respectively, NXKEY, NUMKEY, and BEEP3 for the note-collecting program, and PLAYEM and DELAY for the note-playing program. Finally, common utility routines are TONE and PLAYIT.

Let us examine these routines in greater detail. The program resides at memory addresses 200 and up. Note that the program, like most others in this book, assumes the availability of the GETKEY routine described in Chapter 1.

The operation of the NXKEY routine is straightforward. The next key closure is obtained by calling the GETKEY routine:

```
START      LDA #0
           STA PILEN      Initialize length of list to 0
           CLC
NXKEY      JSR GETKEY
```

The value read is then compared to the constants “15” and “14” for special action. If no match is found, the constant is stored in the note list using the NUMKEY routine.

```
           CMP #15
           BNE NXTST
           JSR BEEP3
           BCC START
NXTST      CMP #14
           BNE NUMKEY
           JSR PLAYEM
           CLC
           BCC NXKEY
```

**Exercise 2-3:** *Why are the last two instructions in this routine used instead of an unconditional jump? What are the advantages and disadvantages of this technique?*

Every time key number 15 is pressed, a special three-tone routine called BEEP3 is played. The BEEP3 routine is shown at address 0287. It plays three notes in rapid succession to indicate to the user that the notes in the memory have been erased. The erasure is performed by resetting the list length PILEN to zero. The corresponding routine appears below:

## GENERATING SQUARE WAVES

BEEP3	LDA #\$FF STA DUR LDA #\$4B JSR TONE LDA #\$38 JSR TONE LDA #\$4B JSR TONE CLC RTS	Beep duration constant  Code for E2 1st note Code for D2 2nd note Code for E2 3rd note
-------	---	---

Its operation is straightforward.

The NUMKEY routine will save the code corresponding to the note in the memory. As in the case of a Teletype program, the computer will echo the character which has been pressed in the form of an audible sound. In other words, every time a key has been pressed, the program will play the corresponding note. This is performed by the next two instructions:

```
NUMKEY   STA TEMP
         JSR PLAYIT
```

The list length is then checked for overflow. If an overflow situation is encountered, the player is advised through the use of the three-tone sequence of BEEP3:

LDA PILEN CMP #\$FF BNE OK JSR BEEP3 BCC NXKEY	Get length of list Overflow? No: add note to list Yes: warn player Read next key
--	--

Otherwise, the new nibble (4 bits) corresponding to the note identification number is shifted into the list:

OK	LSR A  TAY LDA TEMP	Shift low bit into nibble pointer  Use as byte index Restore key #
----	------------------------------	---

Note that the nibble-pointer is divided by two and becomes a byte index. It is then stored in register Y, which will be used later to perform

## ADVANCED 6502 PROGRAMMING

an indexed access to the appropriate byte location within the table (STA TABEG,Y).

Depending on the value which has been shifted into the carry bit, the nibble is stored either in the high end or in the low end of the table's entry. Whenever the nibble must be saved in the high-order position of the byte, a 4-bit shift to the left is necessary, which requires four instructions:

```
BCS FINBYT      Test if byte has a nibble
AND #%00001111 Mask high nibble
STA TABEG,Y     Save
INC PILEN       Next nibble
BCC NXKEY
FINBYT ASL A
        ASL A
        ASL A
        ASL A
```

Finally, it can be saved in the appropriate table address,

```
ORA TABEG,Y
STA TABEG,Y
```

The pointer is incremented and the next key is examined:

```
INC PILEN
BCC NXKEY
```

Let us look at this technique with an example. Assume:

```
PILEN = 9      (length of list)
TEMP = 6       (key pressed)
```

The effect of the instructions is:

```
OK          LSR A          A will contain 4, C will contain 1
            TAY           Y = 4
            LDA TEMP      A = 6
            BCS FINBYT    C is 1 and the branch occurs
```

The situation in the list is:

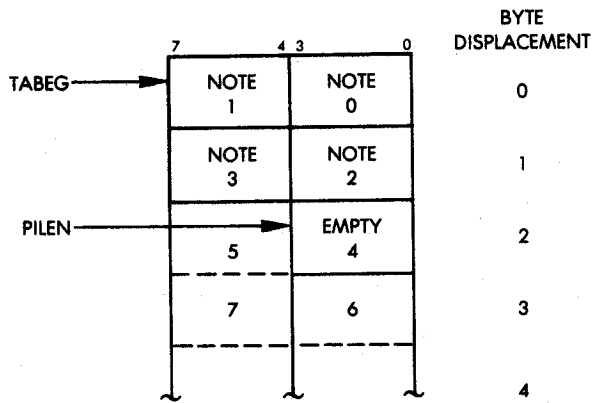


Fig. 2.10: Entering a Note in the List

Shift "6" into the high-order position of A:

```

FINBYT   ASL A
          ASL A
          ASL A
          ASL A           A = 60 (hex)
    
```

Write A into table:

```

ORA TABEG,Y   A = 6X (where X is the
              previous nibble in the table)

STA TABEG,Y   Restore old nibble with new
              nibble
    
```

**The Subroutines**

***PLAYEM Subroutine***

The PLAYEM routine is also straightforward. The PTR memory location is used as the running nibble-pointer for the note table. As before, the contents of the running nibble-pointer are shifted to the right and become a byte pointer. The corresponding table entry is then loaded using an indexed addressing method:

## ADVANCED 6502 PROGRAMMING

```

PLAYEM   LDX #0
          STX PTR           PTR = 0
          LDA PTR
LOOP     LSR A
          TAX
          LDA TABEG,X
          BCS ENDBYT
          AND #%00001111
          BCC FINISH
ENDBYT   AND #%11110000
          LSR A
          LSR A
          LSR A
          LSR A
    
```

Depending upon the value of the bit which has been shifted into the carry, either the high-order nibble or the low-order nibble will be extracted and left-justified in the accumulator. The subroutine **PLAYIT** described below is used to obtain the appropriate constants and to play the note:

```

FINISH   JSR PLAY IT      Play note
    
```

A delay is then implemented between two consecutive notes, the running pointer is incremented, a check occurs for a possible end of list, and the loop is reentered:

```

          LDX #$20         Delay constant
          JSR DELAY        Delay between notes
          INC PTR          One nibble used
          LDA PTR
          CMP PILEN        Check for end of list
          BCC LOOP         No: get next note
          RTS              Done
    
```

### *PLAYIT Subroutine*

The **PLAYIT** subroutine plays the note or implements a rest, as specified by the nibble passed to it in the accumulator. This subroutine is called "PLAYNOTE" on the program flowchart. It merely looks up the appropriate duration for the note from table **DURTAB**, and saves it at address **DUR** (at memory location 4). It then loads the appropriate half-period value from the table at address **NOTAB** into the

## GENERATING SQUARE WAVES

A register, using indexed addressing, and calls subroutine TONE to play it:

PLAYIT	CMP #13	Check for a rest
	BNE SOUND	No
	LDX #\$54	Delay = .21 sec (note duration)
	JSR DELAY	If rest was specified
	RTS	
SOUND	TAX	Use key # as index
	LDA DURTAB,X	To look up duration
	STA DUR	
	LDA NOTAB,X	
	JSR TONE	
	RTS	

### *TONE Subroutine*

The TONE subroutine implements the appropriate wave form generation procedure described above, and toggles the speaker at the appropriate frequency to play the specified note. It implements a traditional two-level, nested loop delay, and toggles the speaker by complementing the output port after each specified delay has elapsed:

```
TONE      STA  FREQ
```

A contains the half-cycle time on entry. It is stored in FREQ. The loop timing will result in an output wave-length of:

$$(20 \times A + 26) \mu s$$

Port B is configured as output:

```
LDA  #$FF
STA  DDRB
```

Registers are then initialized. A is set to contain the pattern to be output. X is the outer loop counter. It is set to the value DUR which contains the number of half cycles at the time the subroutine is called:

```
LDA  #$00
LDX  DUR
```



## ADVANCED 6502 PROGRAMMING

The inner loop counter Y is then initialized to `FREQ`, the frequency constant:

```
FL2      LDY FREQ
```

and the inner loop delay is generated as usual:

```
FL1      DEY
          CLC
          BCC . + 2
          BNE FL1          10 μs inner loop
```

Then the output port is toggled by complementing it:

```
EOR #$FF
STA OPB
```

and the outer loop is completed:

```
DEX
BNE FL2
RTS
```

The `DELAY` subroutine is shown in Figure 2.9 at memory location `29C` and is left as an exercise.

### SUMMARY

This program uses a simple algorithm to remember and play tunes. All data and constants are stored in tables. Timing is implemented by nested loops. Indexed addressing techniques are used to store and retrieve data. Sound is generated by a square wave.

### EXERCISES

**Exercise 2-4:** *Change the note constants to implement a different range of notes.*

**Exercise 2-5:** *Store a tune in memory in advance. Trigger it by pressing key "0."*

**Exercise 2-6:** *Rewrite the program so that it will store the note and duration constants in memory when they are entered, and will not need to look them up when the tune is played. What are the disadvantages of this method?*

# 3. Pseudo Random Number Generator (Translate)

## INTRODUCTION

This program will use a pseudo random number generator, display patterns from tables, measure elapsed time, and generate delays. It will check your knowledge of basic input/output techniques before we proceed to more complex concepts.

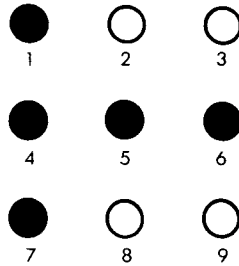
## THE RULES

This is a game designed for two competing players. Each player tries to quickly decipher the computer's coded numbers. The players are alternately given a turn to guess. Each player attempts to press the hexadecimal key corresponding to a 4-bit binary number displayed by the program. The program keeps track of the total guessing time for each player, up to a limit of about 17 seconds. When each player has correctly decoded a number, the players' response times are compared to determine who wins the turn. The first player to win ten turns wins the match.

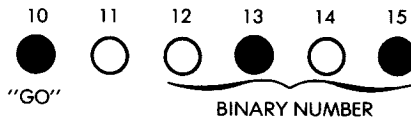
The program signals each player's turn by displaying an arrow pointing either to the left or to the right. The player on the right will be signaled first to initiate the game. The program's "prompt" is shown in Figure 3.1.

A random period of time will elapse after this prompt, then the bottom row of LEDs on the Games Board will light up. The left-most LED (LED #10) signals to the player to proceed. The four right-most LEDs (LEDs 12, 13, 14, and 15) display the coded binary number. This is shown in Figure 3.2. In this case, player 1 should clearly press key number 5. If the player guesses correctly, the program switches to player 2. Otherwise, player 1 will be given another chance until his or her turn (17 seconds) is up. It should be noted here that for each number presented to the player, the total guessing time is accumulated to a maximum of about 17 seconds. When the maximum is reached, the bottom row will go blank and a new number will be displayed.

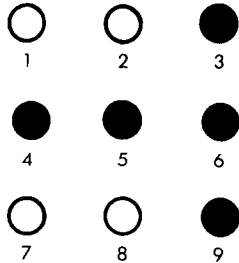
The program signals player 2's turn (the player on the left) by displaying a left arrow on the LEDs as shown in Figure 3.3. Once both players have had a turn to guess a binary digit, the program will signal



**Fig. 3.1: Prompt Signals the Right Player to Play**



**Fig. 3.2: Bottom Row of LEDs Displays Number to be Guessed**



**Fig. 3.3: It is Player 2's Turn (Left Player)**

the winner by lighting up either the left-most or the right-most three LEDs of the bottom row. The winner is the player with the shortest guessing time. The game is continued until one player wins ten times. He or she then wins the match. The computer signals the match winner by blinking the player's three LEDs ten times. At the end of the match, control is returned to the SYM-1 monitor.

### A TYPICAL GAME

The right arrow lights up. The following LED pattern appears at the bottom: 10, 13, 14, 15. The player on the right (player 1) pushes key

“C,” and the bottom row of LEDs goes blank, as the answer is incorrect. Because player 1 did not guess correctly and he or she still has time left in this turn, a new number is offered to player 1. LEDs 10, 13, 14, and 15 light up and the player pushes key “7.” He or she wins and now the left arrow lights up, indicating that it is player 2’s turn. This time the number proposed is 10, 12, 15. The left player pushes key “9.” At this point, LEDs 10, 11, and 12 light up, indicating that the player is the winner for this turn as he/she has used less total time to make a correct guess than player 1.

Let us try again. The right arrow lights up; the number to translate appears in LEDs 10, 13, 14, and 15. Player 1 pushes key “7,” and a left arrow appears. The next number lights LEDs 10 and 14. Player 2 pushes key “2.” Again, the left-most three LEDs light up at the bottom, as player 2 was faster than player 1 at providing the correct answer.

## THE ALGORITHM

The flowchart corresponding to the program is shown in Figure 3.4. A first waiting loop is implemented to measure the time that it takes for player 1 to guess correctly. Once player 1 has achieved a correct guess, his or her total time is accumulated in a variable called TEMP. It is then player 2’s turn, and a similar waiting loop is implemented. Once both players have submitted their guesses, their respective guessing times are compared. The player with the least amount of time wins, and control flows either to the left or to the right, as shown by labels 1 and 2 on the flowchart in Figure 3.4. A secondary variable called PLYR1 or PLYR2 is used to count the number of games won by a specific player. This variable is incremented for the player who has won and tested against the value 10. If the value 10 has not been reached, a new game is started. If the value 10 has been reached, the player with this score is declared the winner of the match.

## THE PROGRAM

The corresponding program uses only one significant data structure. It is called NUMTAB and is used to facilitate the display of the random binary numbers on the LEDs. Remember that LED #10 must always be lit (it is the “proceed” LED). LED #11 must always be off. LEDs 12, 13, 14, and 15 are used to display the binary number. Remember also that bit position 6 of Port 1B is not used. As a result, displaying a “0” will be accomplished by outputting the pattern

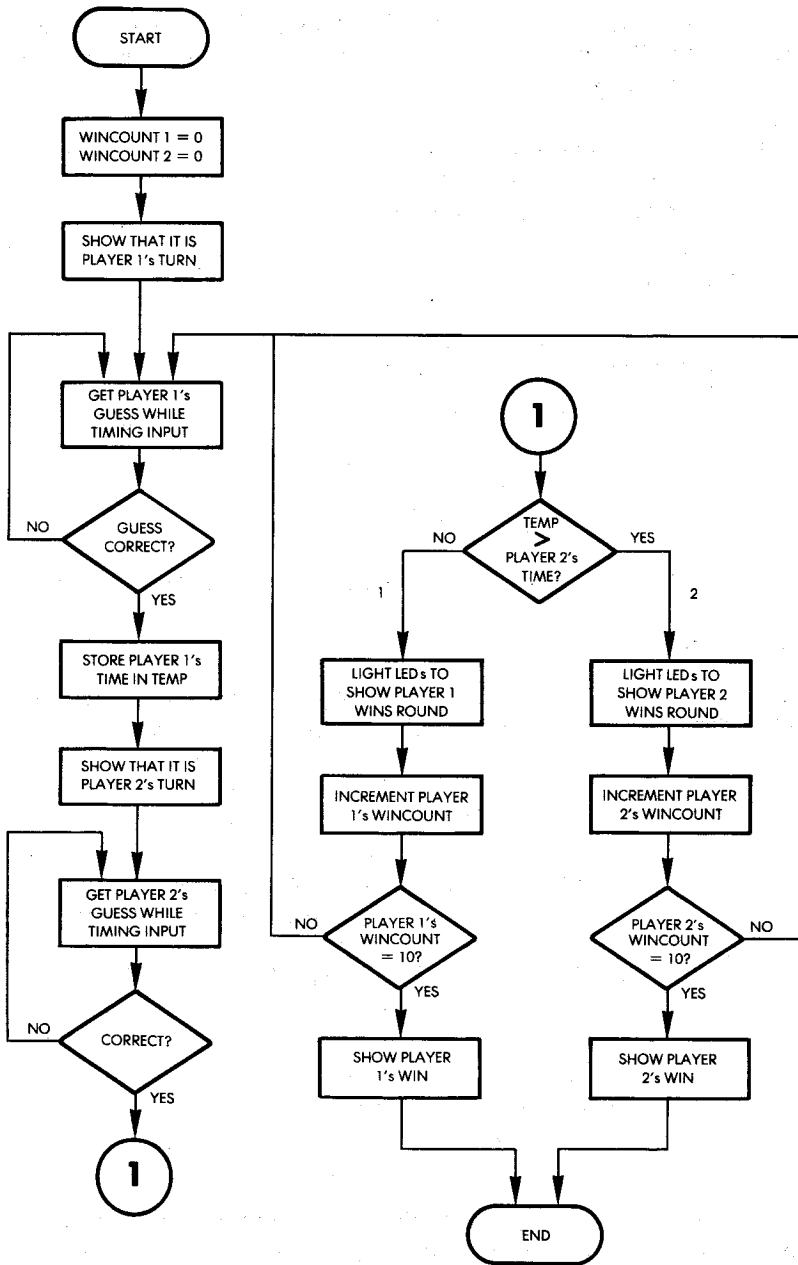
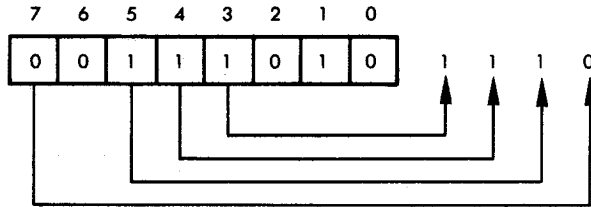


Fig. 3.4: Translate Flowchart

## PSEUDO RANDOM NUMBER GENERATOR

“0000010.” Outputting a “1” will be accomplished with the pattern “1000010.” Outputting “2” will be accomplished with the pattern “00100010.” Outputting “3” will be accomplished with the pattern “10100010,” etc. (See Figure 3.5)

The complete patterns corresponding to all sixteen possibilities are stored in the NUMTAB table of the program. (See Figure 3.6.) Let us examine, for example, entry 14 in the NUMTAB (see line 0060 of the program). It is “00111010.” The corresponding binary number to be displayed is, therefore: “00111.”



It is “1110” or 14. Remember that bit 6 on this port is always “0.”

### Low Memory Area

Memory locations 0 to 1D are used to store the temporary variables and the NUMTAB table. The functions of the variables are:

TEMP	Storage for random delay-length
CNTIH,CNTLO	Time used by a player to make his or her move
CNT1H,CNT1L	Time used by player 1 to make his or her move (permanent storage)
PLYR1	Score for Player 1 (number of games won so far, up to a maximum of ten)
PLYR2	Same for player 2
NUMBER	Random number to be guessed
SCR and following	Scratch area used by the random number generator

In the assembler listing, the method used to reserve memory locations in this program is different from the method used in the program in Chapter 2. In the MUSIC program, memory was reserved for the variables by simply declaring the value of the symbols representing the

# ADVANCED 6502 PROGRAMMING

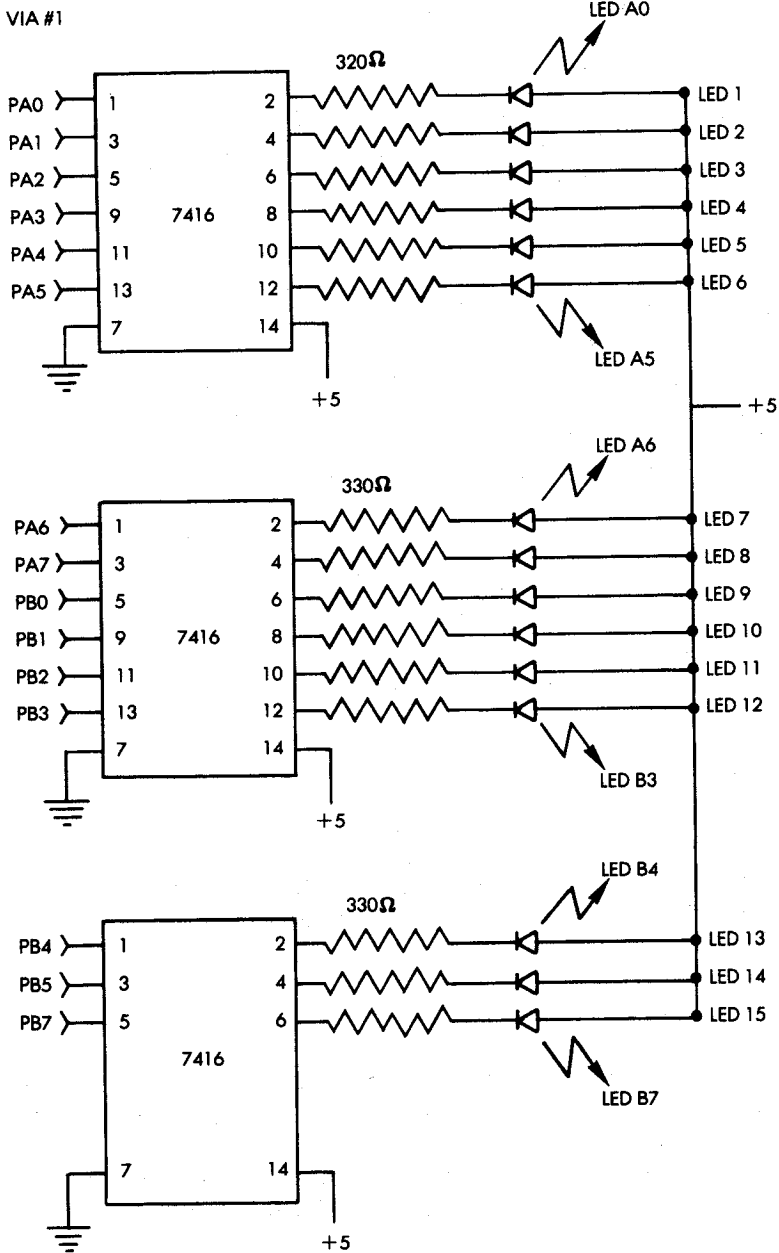


Fig. 3.5: LED Connections

## PSEUDO RANDOM NUMBER GENERATOR

variable locations with the statement:

**<VARIABLE NAME> = <MEMORY ADDRESS>**

In this program, the location counter of the assembler is incremented with expressions of the form:

**\* = \* + n**

Thus, the symbols for the variable locations in this program are declared as "labels," while, in the MUSIC program, they are "symbols" or "constant symbols."

The program in this chapter consists of one main routine, called MOVE, and five subroutines: PLAY, COUNTER, BLINK, DELAY, RANDOM. Let us examine them. The data direction registers A and B for the VIA's #1 and #3 of the board must first be initialized. DDR1A, DDR1B, and DDR3B are configured as outputs:

```
START      LDA #$FF
           STA DDR1A
           STA DDR1B
           STA DDR3B
```

DDR3A is conditioned as input:

```
LDA #0
STA DDR3A
```

Finally, the variables PLYR1 and PLYR2, used to accumulate the number of wins by each player, are initialized to zero:

```
STA PLYR1
STA PLYR2
```

The main body of MOVE is then entered. A right arrow will be displayed to indicate that it is player 2's turn. A reminder of the LEDs connections is shown in Figure 3.5. In order to display a right arrow, LEDs 1, 4, 5, 6, and 7 must be lit (refer also to Figure 3.1). This is accomplished by outputting the appropriate code to Port 1A:

```
MOVE      LDA #%01111001
           STA PORT1A      Display right arrow
```



## ADVANCED 6502 PROGRAMMING

The bottom line of LEDs must be cleared:

```
LDA #0
STA PORT1B
```

Finally, the counters measuring elapsed time must be cleared:

```
STA CNTLO
STA CNTHI
```

We are ready to play:

```
JSR PLAY
```

The PLAY routine will be described below. It returns to the calling routine with a time-elapsed measurement in locations CNTLO and CNTHI.

Let us return to the main program (line 0082 in Figure 3.6). The time-elapsed duration which has been accumulated at locations CNTLO and CNTHI by the PLAY routine is saved in a set of permanent locations reserved for player 1, called CNT1L, CNT1H:

```
LDA CNTLO
STA CNT1L
LDA CNTHI
STA CNT1H
```

It is then player 2's turn, and a left arrow is displayed. This is accomplished by turning on LEDs 3, 4, 5, and 6:

```
LDA #%000111100 Display left arrow
STA PORT1A
```

Then LED #9 is turned on to complete the left arrow:

```
LDA #1
STA PORT1B
```

As before, the time-elapsed counter is reset to zero:

```
LDA #0
STA CNTLO
STA CNTHI
```

# PSEUDO RANDOM NUMBER GENERATOR

```

LINE # LOC      CODE      LINE
0002 0000      ;/TRANSLATE'
0003 0000      ;PROGRAM TO TEST 2 PLAYER'S SPEED
0004 0000      ;IN TRANSLATING A BINARY NUMBER TO A SINGLE
0005 0000      ;HEXADECIMAL DIGIT. EACH PLAYER IS GIVEN A
0006 0000      ;TURN, AS SHOWN BY A LIGHTED LEFT OR RIGHT
0007 0000      ;POINTER. THE NUMBER WILL SUDDENLY FLASH ON
0008 0000      ;LEDS 12-15, ACCOMPANIED BY THE LIGHTING
0009 0000      ;OF LED #10. THE PLAYER MUST THEN
0010 0000      ;PUSH THE CORRESPONDING BUTTON. AFTER
0011 0000      ;BOTH PLAYERS TAKE TURNS, RESULTS ARE
0012 0000      ;SHOWN ON BOTTOM ROW. AFTER 10 WINS,
0013 0000      ;A PLAYER'S RESULTS WILL FLASH,
0014 0000      ;SHOWING THE BETTER PLAYER. THEN
0015 0000      ;THE GAME RESTARTS.
0016 0000      ;
0017 0000      ;I/O:
0018 0000      ;
0019 0000      PORT1A = $A001          ;LEDS 1-8
0020 0000      PORT1B = $A000          ;LEDS 9-15
0021 0000      DDR1A = $A003
0022 0000      DDR1B = $A002
0023 0000      PORT3A = $AC01          ;KEY STROBE INPUT.
0024 0000      PORT3B = $AC00          ;KEY # OUTPUT.
0025 0000      DDR3A = $AC03
0026 0000      DDR3B = $AC02
0027 0000      ;
0028 0000      ;VARIABLE STORAGE:
0029 0000      ;
0030 0000      * = $0
0031 0000      ;
0032 0000      TEMP **=*+1
0033 0001      CNTHI **=*+1          ;TEMPORARY STORAGE FOR AMT. OF
0034 0002      ;TIME PLYR USES TO GUESS.
0035 0002      CNTLO **=*+1
0036 0003      CNT1H **=*+1          ;AMT. OF TIME PLYR1 USES TO GUESS.
0037 0004      CNT1L **=*+1
0038 0005      PLYR1 **=*+1          ;SCORE OF # WON FOR PLYR1.
0039 0006      PLYR2 **=*+1          ;PLAYER 2 SCORE.
0040 0007      NUMBER **=*+1      ;STORES NUMBER TO BE GUESSED.
0041 0008      SCR **=*+6          ;SCRATCHPAD FOR RND. # GEN.
0042 000E      ;
0043 000E      ;TABLE OF 'REVERSED' NUMBERS FOR DISPLAY
0044 000E      ;IN BITS 3-8 OF PORT1B, OR LEDS 12-15.
0045 000E      ;
0046 000E 02      NUMTAB .BYTE $00000010
0047 000F 82      .BYTE $10000010
0048 0010 22      .BYTE $00100010
0049 0011 A2      .BYTE $10100010
0050 0012 12      .BYTE $00010010
0051 0013 92      .BYTE $10010010
0052 0014 32      .BYTE $00110010
0053 0015 B2      .BYTE $10110010
0054 0016 0A      .BYTE $00001010
0055 0017 8A      .BYTE $10001010
0056 0018 2A      .BYTE $00101010
0057 0019 AA      .BYTE $10101010
0058 001A 1A      .BYTE $00011010
0059 001B 9A      .BYTE $10011010
0060 001C 3A      .BYTE $00111010
0061 001D BA      .BYTE $10111010
0062 001E      ;
0063 001E      ;MAIN PROGRAM
0064 001E      ;
0065 001E      * = $200
0066 0200      ;
0067 0200 A9 FF      START LDA #$FF          ;SET UP PORTS
0068 0202 8D 03 A0      STA DDR1A
0069 0205 8D 02 A0      STA DDR1B
0070 0208 8D 02 AC      STA DDR3B
0071 020B A9 00      LDA #0
0072 020D 8D 03 AC      STA DDR3A
0073 0210 85 05      STA PLYR1          ;CLEAR NO. OF WINS.
0074 0212 85 06      STA PLYR2
0075 0214 A9 79      MOVE LDA $20111001
0076 0216 8D 01 A0      STA PORT1A          ;SHOW RIGHT ARROW.
0077 0219 A9 00      LDA #0
0078 021B 8D 00 A0      STA PORT1B
0079 021E 85 02      STA CNTLO          ;CLEAR COUNTERS.
0080 0220 85 01      STA CNTHI
0081 0222 20 8C 02      JSR PLAY          ;GET PLAYER 1'S TIME.
0082 0225 A5 02      LDA CNTLO          ;XFER TEMP COUNT TO PERMANENT STORAGE.
0083 0227 85 04      STA CNT1L
0084 0229 A5 01      LDA CNTHI

```

Fig. 3.6: Translate Program

# ADVANCED 6502 PROGRAMMING

```

0085 022B 85 03      STA CNT1H
0086 022F A9 3C      LDA #X00011100 ;SHOW LEFT ARROW.
0087 022F 8D 01 A0   STA PORT1A
0088 0232 A9 01      LDA #1
0089 0234 8D 00 A0   STA PORT1B
0090 0237 A9 00      LDA #0
0091 0239 85 02      STA CNTLO      ;CLEAR COUNTERS.
0092 023B 85 01      STA CNTHI
0093 023D 20 8C 02   JSR PLAY      ;GET PLAYER 2'S TIME.
0094 0240 A5 01      LDA CNTHI     ;GET PLAYER 2'S COUNT AND...
0095 0242 C5 03      CMP CNT1H    ;COMPARE TO PLAYER 1'S.
0096 0244 F0 04      BEQ EQUAL    ;CHECK LOW ORDER BYTES TO RESOLVE WINNER.
0097 0246 90 27      BCC PLR2     ;PLAYER 2 HAS SMALLER COUNT, SHOW IT.
0098 0248 B0 08      BCS PLR1     ;PLAYER 1 HAS SMALLER COUNT, SHOW IT.
0099 024A A5 02      EQUAL LDA CNTLO ;HI BYTES WERE EQUAL, SO
0100 024C             ;CHECK LOW BYTES.
0101 024C C5 04      CMP CNT1L    ;COMPARE SCORES.
0102 024E 90 1F      BCC PLR2     ;PLAYER 2 WINS, SHOW IT.
0103 0250 B0 00      BCS PLR1     ;PLAYER 1 WINS, SHOW IT.
0104 0252 A9 F0      PLR1 LDA #X11110000 ;LIGHT RIGHT SIDE OF BOTTOM ROW
0105 0254 8D 00 A0   STA PORT1B    ;TO SHOW WIN.
0106 0257 A9 00      LDA #0
0107 0259 8D 01 A0   STA PORT1A    ;CLEAR LOW LEDS.
0108 025C A9 40      LDA #$40     ;WAIT A WHILE TO SHOW WIN.
0109 025E 20 E3 02   JSR DELAY
0110 0261 E4 05      INC PLYR1    ;PLAYER 1 WINS ONE MORE...
0111 0263 A9 0A      LDA #10     ;...HAS HE WON 10?
0112 0265 C5 05      CMP PLYR1
0113 0267 D0 AB      BNE MOVE
0114 0269 A9 F0      LDA #X11110000 ;IF NOT, PLAY ANOTHER ROUND.
0115 026B 20 CB 02   JSR BLINK    ;YES - GET BLINK PATTERN.
0116 026E 60          RTS          ;BLINK WINNING SIDE.
0117 026F A9 0E      PLR2 LDA #X1110    ;ENDGAME! RETURN TO MONITOR.
0118 0271 8D 00 A0   STA PORT1B    ;LIGHT LEFT SIDE OF BOTTOM.
0119 0274 A9 00      LDA #0
0120 0276 8D 01 A0   STA PORT1A    ;CLEAR LOW LEDS.
0121 0279 A9 40      LDA #$40     ;WAIT A WHILE TO SHOW WIN.
0122 027B 20 E3 02   JSR DELAY
0123 027E E4 04      INC PLYR2    ;PLAYER 2 HAS WON ANOTHER ROUND....
0124 0280 A9 0A      LDA #10     ;...HAS HE WON 10?
0125 0282 C5 04      CMP PLYR2
0126 0284 D0 8E      BNE MOVE
0127 0286 A9 0E      LDA #X1110    ;IF NOT, PLAY ANOTHER ROUND.
0128 0288 20 CB 02   JSR BLINK    ;YES-GET PATTERN TO BLINK LEDS.
0129 028B 60          RTS          ;BLINK THEM
0130 028C             ;END.
0131 028C             ;
0132 028C             ;SUBROUTINE 'PLAY'
0133 028C             ;GETS TIME COUNT OF EACH PLAYER, AND IF
0134 028C             ;BAD GUESSES ARE MADE, THE PLAYER IS
0135 028C             ;GIVEN ANOTHER CHANCE, THE NEW TIME ADDED TO
0136 028C             ;THE OLD.
0137 028C             ;
0137 028C 20 F4 02   PLAY JSR RANDOM    ;GET RANDOM NUMBER.
0138 028F 20 E3 02   JSR DELAY    ;RANDOM - LENGTH DELAY.
0139 0292 20 F4 02   JSR RANDOM    ;GET ANOTHER.
0140 0295 29 0F      AND #$0F     ;KEEP UNDER 16 FOR USE AS
0141 0297 85 07      STA NUMBER   ;NUMBER TO GUESS.
0142 0299 AA          TAX          ;USE AS INDEX TO...
0143 029A B5 0E      LDA NUMTAB,X ;..GET REVERSED PATTERN FROM TABLE ...
0144 029C 0D 00 A0   ORA PORT1B   ;...TO DISPLAY IN LEDS 12-15.
0145 029F 8D 00 A0   STA PORT1B
0146 02A2 20 B5 02   JSR CNTSUB   ;GET KEYSTROKE & DURATION COUNT.
0147 02A5 C4 07      CPY NUMBER   ;IS KEYSTROKE CORRECT GUESS?
0148 02A7 F0 0B      BEQ DONE    ;IF SO, DONE.
0149 02A9 A9 01      LDA #01     ;NO: CLEAR OLD GUESS FROM LEDS.
0150 02AB 2D 00 A0   AND PORT1B
0151 02AE 8D 00 A0   STA PORT1B
0152 02B1 4C 8C 02   JMP PLAY     ;TRY AGAIN W/ANOTHER NUMBER.
0153 02B4 60          DONE RTS      ;RETURN W/ DURATION IN CNTLO+CNTHI
0154 02B5             ;
0154 02B5             ;SUBROUTINE 'COUNTER'
0155 02B5             ;GETS KEYSTROKE WHILE KEEPING TRACK OF AMT OF
0156 02B5             ;TIME BEFORE KEYPRESS.
0157 02B5             ;
0158 02B5             ;
0159 02B5 A0 0F      CNTSUB LDY ##F ;SET UP KEY# COUNTER.
0160 02B7 8C 00 AC   KEYLP STY PORT3B ;OUTPUT KEY# TO KEYBOARD MPXR.
0161 02BA 2C 01 AC   BIT PORT3A   ;KEY DOWN?
0162 02BD 10 0B      BPL FINISH   ;IF YES, DONE.
0163 02BF 88          DEC          ;COUNT DOWN KEY #.
0164 02C0 10 F5      BPL KEYLP    ;TRY NEXT KEY.
0165 02C2 E6 02      INC CNTLO   ;ALL KEYS TRIED, INCREMENT COUNT.

```

Fig. 3.6: Translate Program (Continued)

# PSEUDO RANDOM NUMBER GENERATOR

```

0166 02C4 D0 EF          BNE CNTSUB      ;TRY KEYS AGAIN IF NO OVERFLOW.
0167 02C6 E6 01          INC CNTHI      ;OVERFLOW, INCREMENT HIGH BYTE.
0168 02C8 D0 EB          BNE CNTSUB      ;TRY KEYS AGAIN.
0169 02CA 60             FINISH RTS      ;DONE: TIME RAN OUT OR KEY PRESSED.
0170 02CB                ;
0171 02CB                ;SUBROUTINE 'BLINK'
0172 02CB                ;BLINKS LEDS WHOSE BITS ARE SET IN ACCUMULATOR
0173 02CB                ;ON ENTRY.
0174 02CB                ;
0175 02CB A2 14          BLINK LDX #20     ;20 BLINKS.
0176 02CD 86 01          STX CNTHI      ;SET BLINK COUNTER.
0177 02CF 85 02          STA CNTLO      ;BLINK REGISTER.
0178 02D1 A5 02          BLOOP LDA CNTLO  ;GET BLINK PATTERN.
0179 02D3 4D 00 A0       EOR PORT1B     ;BLINK LEDS.
0180 02D6 8D 00 A0       STA PORT1B
0181 02D9 A9 0A          LDA #10        ;SHORT DELAY.
0182 02DB 20 E3 02       JSR DELAY
0183 02DE C6 01          DEC CNTHI
0184 02E0 D0 EF          BNE BLOOP      ;LOOP IF NOT DONE.
0185 02E2 60             RTS
0186 02E3                ;
0187 02E3                ;SUBROUTINE 'DELAY'
0188 02E3                ;CONTENTS OF REG. A DETERMINES DELAY LENGTH.
0189 02E3                ;
0190 02E3 85 00          DELAY STA TEMP
0191 02E5 A0 10          DL1 LDY #10
0192 02E7 A2 FF          DL2 LDX #FF
0193 02E9 CA             DL3 DEX
0194 02EA D0 FD          BNE DL3
0195 02EC 88             DEY
0196 02ED D0 F8          BNE DL2
0197 02EF C6 00          DEC TEMP
0198 02F1 D0 F2          BNE DL1
0199 02F3 60             RTS
0200 02F4                ;
0201 02F4                ;SUBROUTINE 'RANDOM'
0202 02F4                ;RANDOM NUMBER GENERATOR.
0203 02F4                ;RETURNS RANDOM NUMBER IN ACCUM.
0204 02F4                ;
0205 02F4 38             RANDOM SEC
0206 02F5 A5 09          LDA SCR+1
0207 02F7 65 0C          ADC SCR+4
0208 02F9 65 0D          ADC SCR+5
0209 02FB 85 08          STA SCR
0210 02FD A2 04          LDX #4
0211 02FF B5 08          RNDLP LDA SCR,X
0212 0301 95 09          STA SCR+1,X
0213 0303 CA             DEX
0214 0304 10 F9          BPL RNDLP
0215 0306 60             RTS
0216 0307                .END

```

## SYMBOL TABLE

SYMBOL VALUE

BLINK	02CB	BLOOP	02D1	CNT1H	0003	CNT1L	0004
CNTHI	0001	CNTLO	0002	CNTSUB	02B5	DDR1A	A003
DDR1B	A002	DDR3A	AC03	DDR3B	AC02	DELAY	02E3
DL1	02E5	DL2	02E7	DL3	02E9	DONE	02B4
EQUAL	024A	FINISH	02CA	KEYLP	02B7	MOVE	0214
NUMBER	0007	NUMTAB	000E	PLAY	028C	PLR1	0252
PLR2	026F	PLYR1	0005	PLYR2	0006	PORT1A	A001
PORT1B	A000	PORT3A	AC01	PORT3B	AC00	RANDOM	02F4
RNDLP	02FF	SCR	0008	START	0200	TEMP	0000

END OF ASSEMBLY

**Fig. 3.6: Translate Program (Continued)**

## ADVANCED 6502 PROGRAMMING

and player 2 can play:

### JSR PLAY

The time elapsed for player 2 is then compared to the time elapsed for player 1. If player 2 wins, a branch occurs to PLR2. If player 1 wins, a branch occurs to PLR1. The high bytes are compared first. If they are equal, the low bytes are compared in turn:

	LDA CNTHI	
	CMP CNT1H	Compare high bytes
	BEQ EQUAL	
	BCC PLR2	Player 2 has lower time?
	BCS PLR1	Player 1 does
EQUAL	LDA CNTLO	Compare low bytes
	CMP CNT1L	
	BCC PLR2	
	CMP CNT1L	
	BCC PLR2	
	BCS PLR1	

Once the winner has been identified, the bottom row of LEDs on his or her side will light up, pointing to the winner. Let us follow what happens when PLR1 wins, for example. Player 1's right-most three LEDs (LEDs 13 through 15) are lit up:

```
PLR1      LDA #%11110000
          STA PORT1B
```

The other LEDs on the Games Board are cleared:

```
LDA #0
STA PORT1A
```

A DELAY is then implemented, and we get ready to play another game, up to a total of 10:

```
LDA #$40
JSR DELAY
```

The score for player 1 is incremented:

```
INC PLYR1
```

## PSEUDO RANDOM NUMBER GENERATOR

It is compared to 10. If it is less than 10, a return occurs to the main MOVE routine:

```
LDA #10
CMP PLYR1
BNE MOVE
```

Otherwise, the maximum score of 10 has been reached and the game is over. The LEDs on the winner's side will blink:

```
LDA #%011110000 Blink pattern
JSR BLINK
RTS
```

The corresponding sequence for player 2 is listed at address PLR2 (line 117 on Figure 3.6):

```
PLR2      LDA #%01110
          STA PORT1B
          LDA #0
          STA PORT1A
          LDA #$40
          JSR DELAY
          INC PLYR2
          LDA #10
          CMP PLYR2
          BNE MOVE
          LDA #%01110
          JSR BLINK
          RTS
```

### The Subroutines

#### *PLAY Subroutine*

The PLAY subroutine will first wait for a random period of time before displaying the binary number. This is accomplished by calling the RANDOM subroutine to obtain the random number, then the DELAY subroutine to implement the delay:

```
PLAY      JSR RANDOM
          JSR DELAY
```

## ADVANCED 6502 PROGRAMMING

The **RANDOM** subroutine will be described below. Another random number is then obtained. It is trimmed down to a value between 0 and 15, inclusive. This will be the binary number displayed on the LEDs. It is stored at location **NUMBER**:

```
JSR RANDOM
AND #0F      Mask off high nibble
STA NUMBER
```

The **NUMTAB** table, described at the beginning of this section, is then accessed to obtain the correct pattern for lighting the LEDs using indexed addressing. Register **X** contains the number between 0 and 15 to be displayed:

```
TAX          Use X as index
LDA NUMTAB,X Retrieve pattern
```

The pattern in the accumulator is then stored in the output register in order to light the LEDs. Note that the pattern is OR'ed with the previous contents of the output register so that the status of LED 9 is not changed:

```
ORA PORT1B
STA PORT1B
```

Once the random number has been displayed in binary form on the LEDs, the subroutine waits until the player presses a key. The **CNTSUB** subroutine is used for this purpose:

```
JSR CNTSUB
```

It will be described below.

The value returned in register **Y** by this subroutine is compared to the number to be guessed, which is stored at memory address **NUMBER**. If the comparison succeeds, exit occurs. Otherwise, all LEDs are cleared using an **AND**, to prevent changing the status of LED 9, and the subroutine is reentered. Note that the remaining time for the player will be decremented every time the **CNTSUB** subroutine is called. It will eventually decrement to 0, and this player will be given another number to guess:

PSEUDO RANDOM NUMBER GENERATOR

	CPY NUMBER	Correct guess?
	BEQ DONE	
	LDA #01	No: clear old guess
	AND PORT1B	
	STA PORT1B	
	JMP PLAY	Try again
DONE	RTS	

**Exercise 3-1:** *Modify PLAY and/or CNTSUB so that, upon timeout, the player loses the current round, as if the maximum amount of time had been taken to make the guess.*

**CNTSUB Subroutine**

The CNTSUB subroutine is used by the PLAY subroutine previously described. It monitors a player's keystroke and records the amount of time elapsed until the key is pressed. The key scanning is performed in the usual way:

CNTSUB	LDY #\$F	
KEYLP	STY PORT3B	
	BIT PORT3A	
	BPL FINISH	
	DEY	Count down key #
	BPL KEYLP	Next key
FINISH	BNE CNTSUB	

Each time that all keys have been scanned unsuccessfully, the time elapsed counter is incremented (CNTLO,CNTHI):

	INC CNTLO
	BNE CNTSUB
	INC CNTHI
	BNE CNTSUB
FINISH	RTS

Upon return of the subroutine, the number corresponding to the key which has been pressed is contained in index register Y.

**Exercise 3-2:** *Insert some "do-nothing" instructions into the CNTSUB subroutine so that the guessing time is longer.*



***BLINK Subroutine***

The LEDs specified by the accumulator contents are blinked (turned on and off) ten times by this subroutine. It uses memory location CNTHI and CNTLO as scratch registers, and destroys their previous contents. Since the LEDs must alternately be turned on and off, an exclusive-OR instruction is used to provide the automatic on/off feature by performing a complementation. Because two complementations of the LED status must be done to blink the LEDs once, the loop is executed 20 times. Note also that LEDs must be kept lit for a minimum amount of time. If the “on” delay was too short, the LEDs would appear to be continuously lit. The program is shown below:

BLINK	LDX #20	20 blinks
	STX CNTHI	Blink counter
	STA CNTLO	Blink register
BLOOP	LDA CNTLO	Get blink pattern
	EOR PORT1B	Blink LEDs
	STA PORT1B	
	LDA #10	Short delay
	JSR DELAY	
	DEC CNTHI	
	BNE BLOOP	Loop if not done
	RTS	

***DELAY Subroutine***

The DELAY subroutine implements a classic three-level, nested loop design. Register X is set to a maximum value of FF (hexadecimal), and used as the inner loop counter. Register Y is set to the value of 10 (hexadecimal) and used as the level-2 loop counter. Location TEMP contains the number used to adjust the delay and is the counter for the outermost loop. The subroutine design is straightforward:

DELAY	STA TEMP
DL1	LDY #\$10
DL2	LDX #\$FF
DL3	DEX
	BNE DL3
	DEY

```

BNE DL2
DEC TEMP
BNE DL1
RTS

```

**Exercise 3-3:** *Compute the exact duration of the delay implemented by this subroutine as a function of the number contained in location TEMP.*

### **RANDOM Subroutine**

This simple random number generator returns a semi-random number into the accumulator. A set of six locations from memory address 0008 ("SCR") have been set aside as a scratch-pad for this generator. The random number is computed as 1 plus the contents of the number in location SCR + 1, plus the contents of the number in location SCR + 4, plus the contents of the number in location SCR + 5:

```

RANDOM   SEC
        LDA SCR + 1
        ADC SCR + 4
        ADC SCR + 5
        STA SCR

```

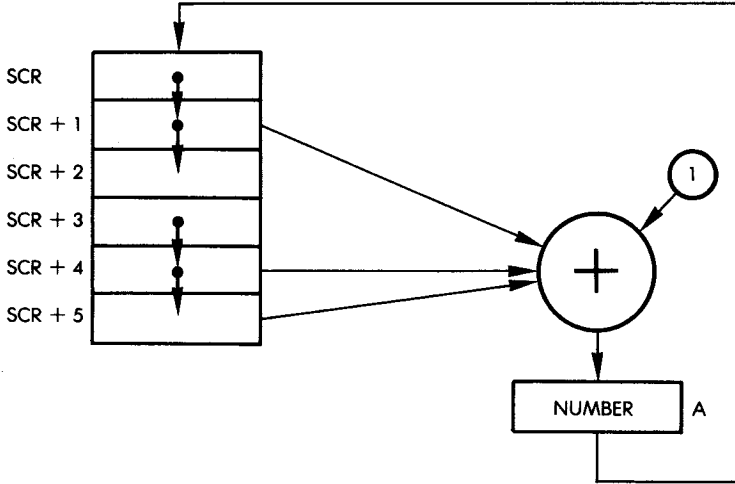
The contents of the scratch area (SCR and following locations) are then shifted down in anticipation of the next random number generation:

```

RNDLP   LDX #4
        LDA SCR,X
        STA SCR + 1,X
        DEX
        BPL RNDLP
        RTS

```

The process is illustrated in Figure 3.7. Note that it implements a seven-location circular shift. The random number which has been computed is written back in location SCR, and all previous values at memory locations SCR and following are pushed down by one position. The previous contents of SCR + 5 are lost. This ensures that the numbers will be reasonably random.



**Fig. 3.7: Random Number Generation**

**SUMMARY**

This game involved two players competing with each other. The time was kept with nested loops. The random number to be guessed was generated by a pseudo-random number generator. A special table was used to display the binary number. LEDs were used on the board to indicate each player's turn to display the binary number, and to indicate the winner.

**Exercise 3-4:** *What happens in the case in which all memory locations from SCR to SCR + 5 were initially zero?*

## **4. Hardware Random Number Generator (Hexguess)**

### **INTRODUCTION**

In this chapter random numbers will be generated using the timer's latch on an input/output chip. More complex algorithms will be devised and simultaneous light and sound effects will be created.

### **THE RULES**

The object of this game is to guess a secret 2-digit number generated by the computer. This is done by guessing a number, then submitting this number to the computer and using the computer's response (indicating the proximity of the guessed number to the secret number) to narrow down a range of numbers in which the secret number resides. The program begins by generating a high-pitched beep which signals to the player that it is ready for a number to be typed. The player must then type in a two-digit hexadecimal number. The program responds by signaling a win if the player has guessed the right number. If the player has guessed incorrectly, the program responds by lighting up one to nine LEDs, indicating the distance between the player's guess and the correct number. One lit LED indicates that the number guessed is a great distance away from the secret number, and nine lit LEDs indicate that the number guessed is very close to the secret number.

If the guess was correct, the program generates a warbling tone and flashes the LEDs on the board. The player is allowed a maximum of ten guesses. If he or she fails to guess the correct number in ten tries, a low tone is heard and a new game is started.

### **A TYPICAL GAME**

The computer beeps, notifying us that we should type in a guess.

Our guess is: "40"

The computer lights 4 LEDs      We are somewhat off

## ADVANCED 6502 PROGRAMMING

Next guess: "C0"	
Computer's answer: 3 LEDs	We are going further away
Next guess: "20"	
Computer's response: 3	The number must be between C0 and 20
Next guess: "80"	
Response: 5	We are getting closer
Next guess: "75"	
Response: 5	It's not just below 80
Next guess: "90"	
Response: 4	We're wandering away
Next guess: "65"	
Response: 7	Now we're closing in
Next guess: "60"	
Response: 9	
Next guess: "5F"	
Response: 8	
Next guess: "61"	
We win!!! All the LEDs flash and a high warbling tone is heard.	

### THE ALGORITHM

The flowchart for Hexguess is shown in Figure 4.1. The algorithm is straightforward:

- a random number is generated
- a guess is entered
- the closeness of the number guessed to the secret number is evaluated. Nine levels of proximity are available and are displayed by an LED on the board. A closeness or proximity table is used for this purpose.
- a win or a loss is signaled
- more guesses are allowed, up to a maximum of ten.

### THE PROGRAM

#### Data Structures

The program consists of one main routine called GETGES, and two subroutines called LITE and TONE. It uses one simple data structure

# HARDWARE RANDOM NUMBER GENERATOR

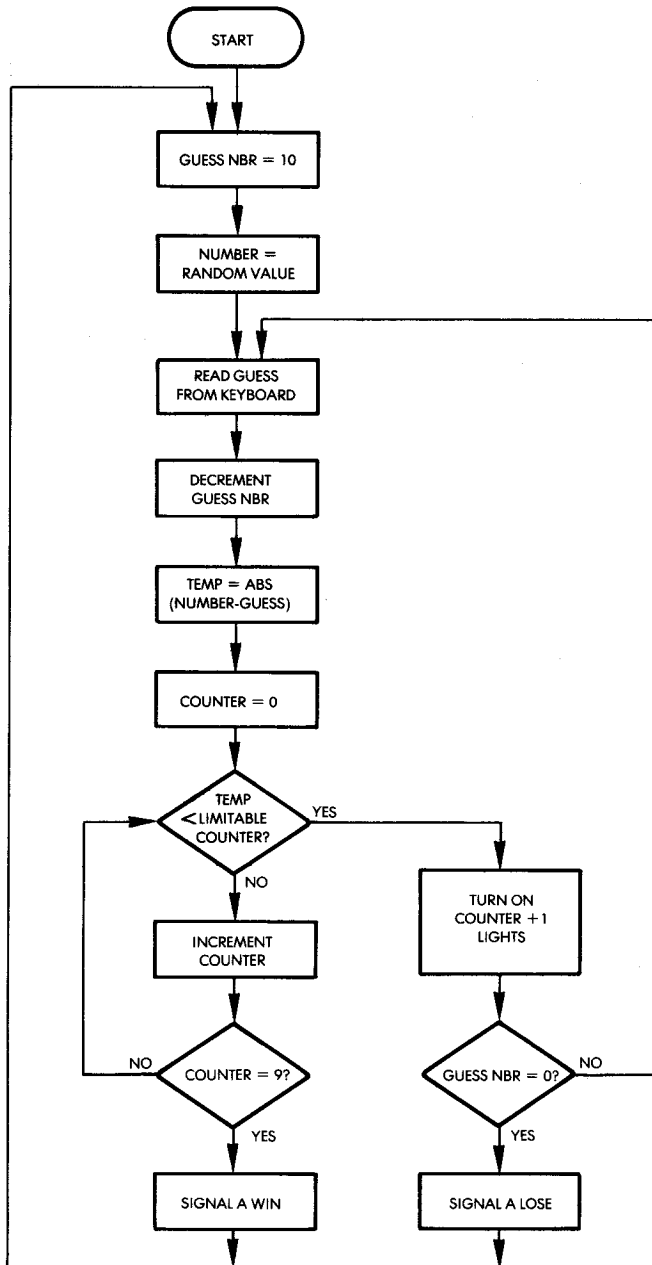


Fig. 4.1: Hexguess Flowchart

— a table called LIMITS. The flowchart is shown in Figure 4.1, and the program listing appears in Figure 4.2.

The LIMITS table contains a set of nine values against which the proximity of the guess to the computer's secret number will be tested. It is essentially exponential and contains the sequence: 1,2,4,8,16,32,64,128,200.

### Program Implementation

Let us examine the program itself. It resides at memory address 200 and may not be relocated. Five variables reside in page zero:

GUESS is used to store the current guess  
 GUESS# is the number of the current guess  
 DUR and FREQ are the usual parameters required to generate a tone (TONE subroutine)  
 NUMBER is the secret computer number

As usual, the data direction registers VIA #1 and VIA #3 are conditioned in order to drive the LED display and read the keyboard:

```
LDA #$FF
STA DDR1A      OUTPUT
STA DDR1B      OUTPUT
STA DDR3B      OUTPUT
```

Memory location DUR is used to store the duration of the tone to be generated by the TONE subroutine. It is initialized to "FF" (hex):

```
STA DUR
```

The memory location GUESS# is used to store the number of guesses. It is initialized to 10:

```
START    LDA #$0A
          STA GUESS#
```

The LEDs on the Games Board are turned off:

```
LDA #00
STA PORT1A
STA PORT1B
```

## HARDWARE RANDOM NUMBER GENERATOR

```

;HEXGUESS'
;HEXADECIMAL NUMBER GUESSING GAME.
;THE OBJECT OF THE GAME IS TO GUESS A HEXADECIMAL
;NUMBER THAT THE COMPUTER HAS THOUGHT UP.
;WHEN THE COMPUTER "BEEPS", A GUESS SHOULD
;BE ENTERED. GUESSES ARE TWO DIGIT HEXADECIMAL
;NUMBERS. WHEN TWO DIGITS HAVE BEEN RECEIVED,
;THE COMPUTER WILL DISPLAY THE NEARNESS
;OF THE GUESS BY LIGHTING A NUMBER OF
;LEDS PROPORTIONAL TO THE CLOSENESS OF
;THE GUESS. TEN GUESSES ARE ALLOWED.
;IF A GUESS IS CORRECT, THEN THE COMPUTER
;WILL FLASH THE LEDES AND MAKE A WARBLING
;TONE.
;THE ENTRY LOCATION IS $200.
;
GETKEY = $100
;6522 VIA #1 ADDRESSES:
TIMER = $A004 ;LOW LATCH OF TIMER 1
DDR1A = $A003 ;PORTA DATA DIRECTION REG.
DDR1B = $A002 ;PORTB DATA DIRECTION REG.
PORT1A = $A001 ;PORT A
PORT1B = $A000 ;PORT B
;6522 VIA #3 ADDRESSES:
DDR3B = $AC02 ;PORTB DATA DIRECTION REG.
PORT3B = $AC00 ;PORT B
;STORAGES:
GUESS = $00
GUESS# = $01
DUR = $02
FREQ = $03
NUMBER = $04
;
; = $200
0200: A9 FF LDA #$FF ;SET UP DATA DIRECTION REGISTERS
0202: 8D 03 A0 STA DDR1A
0205: 8D 02 A0 STA DDR1B
0208: 8D 02 AC STA DDR3B
020B: 85 02 STA DUR ;SET UP TONE DURATIONS.
020D: A9 0A START LDA #$0A ;10 GUESSES ALLOWED
020F: 85 01 STA GUESS#
0211: A9 00 LDA #00 ;BLANK LEDES
0213: 8D 01 A0 STA PORT1A
0214: 8D 00 A0 STA PORT1B
0219: AD 04 A0 LDA TIMER ;GET RANDOM NUMBER TO GUESS
021C: 85 04 STA NUMBER ;...AND SAVE.
021E: A9 20 GETGES LDA #$20 ;SET UP SHORT HIGH TONE TO
;SIGNAL USER TO INPUT GUESS.
0220: 20 96 02 JSR TONE ;MAKE BEEP.
0223: 20 00 01 JSR GETKEY ;GET HIGH ORDER USER GUESS
0224: 0A ASL A ;SHIFT INTO HIGH ORDER POSITION
0227: 0A ASL A
0228: 0A ASL A
0229: 0A ASL A
022A: 85 00 STA GUESS ;SAVE
022C: 20 00 01 JSR GETKEY ;GET LOW ORDER USER GUESS
022F: 29 0F AND #200001111 ;MASK HIGH ORDER BITS.
0231: 05 00 ORA GUESS ;ADD HIGH ORDER NIBBLE.
0233: 85 00 STA GUESS ;FINAL PRODUCT SAVED.
0235: A5 04 LDA NUMBER ;GET NUMBER FOR COMPARE
0237: 38 SEC
0238: E5 00 SBC GUESS ;SUBTRACT GUESS FROM NUMBER
;TO DETERMINE NEARNESS OF GUESS.
023A: 80 05 BCS ALRIGHT ;POSITIVE VALUE NEEDS NO FIX.
023C: 49 FF EOR #11111111 ;MAKE DISTANCE ABSOLUTE
023E: 38 SEC ;MAKE IT A TWO'S COMPLEMENT
023F: 69 00 ADC #00 ;...NOT JUST A ONES COMPLEMENT.

```

Fig. 4.2: Hexguess Program



# ADVANCED 6502 PROGRAMMING

```

0241: A2 00    ALRIGHT LDX #00    ;SET CLOSENESS COUNTER TO DISTANT
0243: DD AD 02 LOOP      CMP LIMITS,X  ;COMPARE NEARNESS OF GUESS TO
                                ;TABLE OF LIMITS TO SEE HOW MANY
                                ;LIGHTS TO LIGHT.

0246: B0 27                BCS SIGNAL  ;NEARNESS IS BIGGER THAN LIMIT, SO
                                ;GO LIGHT INDICATOR.

0248: E8                INX                ;LOOK AT NEXT CLOSENESS LEVEL.
0249: E0 09                CPX #9                ;ALL NINE LEVELS TRIED?
024B: D0 F6                BNE LOOP          ;NO, TRY NEXT LEVEL.
024D: A9 0B                WIN      LDA #11          ;YES: WIN! LOAD NUMBER OF BLINKS
024F: 85 00                STA GUESS        ;USE GUESS AS TEMP
0251: A9 FF                LDA #FF          ;LIGHT LEDS
0253: 8D 01 A0            STA PORT1A
0256: 8D 00 A0            STA PORT1B
0259: A9 32                WOW      LDA #50          ;TONE VALUE
025B: 20 96 02            JSR TONE        ;MAKE WIN SIGNAL
025E: A9 FF                LDA #FF
0260: 4D 01 A0            EOR PORT1A     ;COMPLEMENT PORTS
0263: 8D 01 A0            STA PORT1A
0266: 8D 00 A0            STA PORT1B
0269: C6 00                DEC GUESS      ;BLINKS/TONES DONE?
026B: D0 EC                BNE WOW        ;NO, DO AGAIN
026D: F0 9E                BEQ START     ;YES, START NEW GAME.
026F: E8                SIGNAL INX      ;INCREMENT CLOSENESS-LEVEL
                                ;COUNTER SO AT LEAST 1 LED IS LIT.
                                ;CLEAR HIGH LED PORT

0270: A9 00                LDA #0
0272: 8D 00 A0            STA PORT1B
0275: 20 8E 02            JSR LITE       ;GET LED PATTERN
0278: 8D 01 A0            STA PORT1A     ;SET LEDS
027B: 90 05                BCC CC        ;IF CARRY SET PBO = 1
027D: A9 01                LDA #01
027F: 8D 00 A0            STA PORT1B
0282: C6 01                CC      DEC GUESS#  ;ONE GUESS USED
0284: D0 98                BNE GETGES    ;SOME LEFT, GET NEXT.
0286: A9 BE                LDA #BE       ;LOW TONE SIGNALS LOSE
0288: 20 96 02            JSR TONE
028B: 4C 0D 02            JMP START     ;NEW GAME.

;
;ROUTINE TO MAKE PATTERN OF LIT LEDS BY SHIFTING A
;STRING OF ONES TO THE LEFT IN THE ACCUMULATOR UNTIL
;THE BIT POSITION CORRESPONDING TO THE NUMBER IN X
;IS REACHED.
;
028E: A9 00                LITE      LDA #0        ;CLEAR ACCUMULATOR FOR PATTERN
0290: 38                SHIFT    SEC            ;MAKE LOW BIT HIGH.
0291: 2A                ROL A      ;SHIFT IT IN
0292: CA                DEX        ;ONE BIT DONE...
0293: D0 FB                BNE SHIFT   ;LOOP IF NOT DONE.
0295: 60                RTS        ;RETURN

;
;TONE GENERATION ROUTINE.
;
0296: 85 03                TONE     STA FREQ
0298: A9 00                LDA #00
029A: A6 02                LDX DUR
029C: A4 03                FL2     LDY FREQ
029E: 88                FL1     DEY
029F: 18                CLC
02A0: 90 00                BCC .+2
02A2: D0 FA                BNE FL1
02A4: 49 FF                EOR #FF
02A6: 8D 00 AC            STA PORT3B
02A9: CA                DEX
02AA: D0 F0                BNE FL2
02AC: 60                RTS

;
;TABLE OF LIMITS FOR CLOSENESS LEVELS.
;

```

Fig. 4.2: Hexguess Program (Continued)

## HARDWARE RANDOM NUMBER GENERATOR

```

02AD: CB          LIMITS  .BYTE 200,128,64,32,16,8,4,2,1
02AE: 80
02AF: 40
02B0: 20
02B1: 10
02B2: 0B
02B3: 04
02B4: 02
02B5: 01

SYMBOL TABLE:
GETKEY      0100          TIMER      A004          DDR1A      A003
DDR1B      A002          PORT1A     A001          PORT1B     A000
DDR3B      AC02          PORT3B     AC00          GUESS      0000
GUESS#     0001          DUR        0002          FREQ       0003
NUMBER     0004          START      020D          GETGES     021E
ALRIGHT    0241          LOOP       0243          WIN        024D
WOW        0259          SIGNAL     026F          CC         02B2
LITE       028E          SHIFT      0290          TONE       0296
FL2        029C          FL1        029E          LIMITS     02AD

%

```

**Fig. 4.2: Hexguess Program (Continued)**

The program will generate a random number which must be guessed by the player. A reasonably random number is obtained here by reading the value of timer1 of VIA #1. It is then stored in memory address NUMBER:

```

LDA TIMER      Low latch of timer 1
STA NUMBER

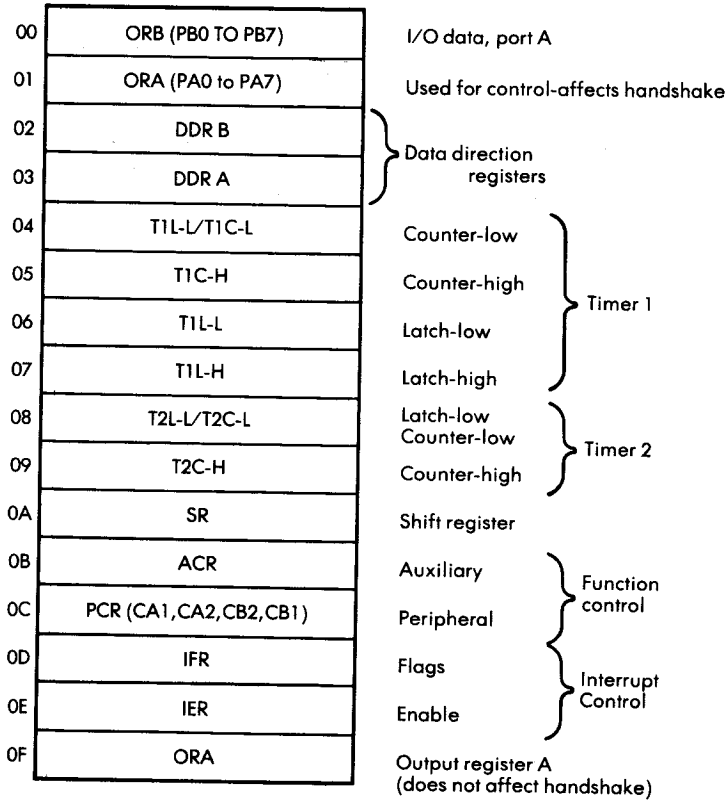
```

A random number generator is not required because requests for random numbers occur at random time intervals, unlike the situation in most of the other games that will be described. An important observation on the use of T1CL of a 6522 VIA is that it is often called a “latch” but it is a “counter” when performing a read operation! Its contents are *not* frozen during a read as they would be with a latch. They are continuously decremented. When they decrement to 0, the counter is reloaded from the “real” latch.

Note that in Figure 4.3 T1L-L is shown twice — at addresses 04 and 06. This is a possible source of confusion and should be clearly understood. Location 4 corresponds to the counter; location 6 corresponds to the latch. Location 4 is read here.

We are ready to go. A high-pitched tone is generated to signal the player that a guess may be entered. The note duration is stored at

# ADVANCED 6502 PROGRAMMING



**Fig. 4.3: 6522 VIA Memory Map**

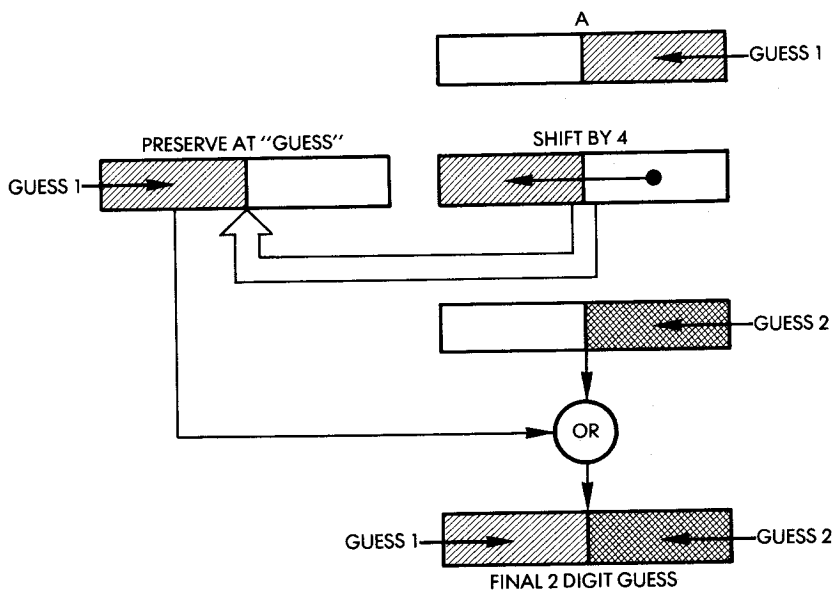
memory location DUR while the note frequency is set by the contents of the accumulator:

```

GETGES      LDA #$20      High pitch
            JSR TONE
  
```

Two key strokes must be accumulated for each guess. The GETKEY subroutine is used to obtain the number of the key being pressed, which is then stored in the accumulator. Once the first character has been obtained, it is shifted left by four positions into the high nibble position, and the next character is obtained. (See Figure 4.4.)

## HARDWARE RANDOM NUMBER GENERATOR



**Fig. 4.4: Collecting the Player's Guess**

```
JSR GETKEY
ASL A
ASL A
ASL A
ASL A
STA GUESS
JSR GETKEY
```

Once the second character has been transferred into the accumulator, the previous character, which had been saved in memory location GUESS, is retrieved and OR'ed back into the accumulator:

```
AND #%00001111
ORA GUESS
```

It is stored back at memory location GUESS:

```
STA GUESS
```

## ADVANCED 6502 PROGRAMMING

Now that the guess has been obtained, it must be compared against the random number stored by the computer at memory location NUMBER. A subtraction is performed:

```
LDA NUMBER
SEC
SBC GUESS
```

Note that if the difference is negative, it must be complemented:

```
BCS ALRIGHT      Positive?
EOR #%11111111   It is negative: complement
SEC              Make it two's complement
ADC #00          Add one
```

Once the "distance" from the guess to the actual number has been computed, the "closeness-counter" must be set to a value between 1 and 9 (only nine LEDs are used). This is done by a loop which compares the absolute "distance" of the guess from the correct number to a bracket value in the LIMITS table. The number of the appropriate bracket value becomes the value assigned to the proximity or closeness of the guessed number to the secret number. Index register X is initially set to 0, and the indexed addressing mode is used to retrieve bracket values. Comparisons are performed as long as the "distance" is less than the bracket value, or until X exceeds 9, i.e., until the highest table value is looked up.

```
ALRIGHT  LDX #00
LOOP     CMP LIMITS,X   Look up limit value
        BCS SIGNAL
        INX            Closeness is less
        CPX #9        Keep trying 10 times
        BNE LOOP
```

At this point, unless a branch has occurred to SIGNAL, the distance between the guess and the actual number is 0: it is a win. This is signaled by blinking the LEDs and by generating a special win tone:

```
WIN     LDA #11
        STA GUESS      Scratch storage
        LDA #FF
```

## HARDWARE RANDOM NUMBER GENERATOR

	STA PORT1A	
	STA PORT1B	
WOW	LDA #50	Tone pitch
	JSR TONE	Generate tone

The blinking is generated by complementing the LEDs repeatedly:

LDA #\$FF	
EOR PORT1A	Complement ports
STA PORT1A	
STA PORT1B	

The loop is executed again:

```
DEC GUESS
BNE WOW
```

Finally, when the loop index (GUESS) reaches zero, a branch occurs back to the beginning of the main program: START:

```
BEQ START
```

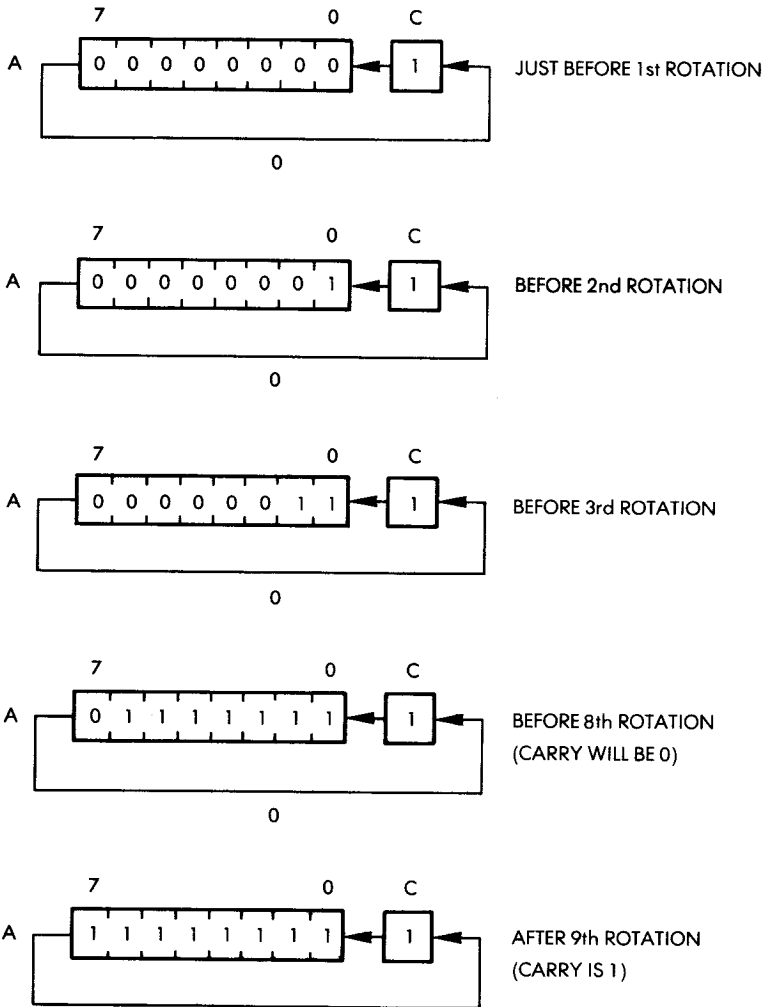
If, however, the current guess is not correct, a branch to SIGNAL occurs during bracket comparison, with the contents of the X register being the proximity value: i.e., the number of LEDs to light. Depending on the closeness of the guess to the secret number, LEDs #1 to #9 will be turned on:

SIGNAL	INX	Increment closeness level
	LDA #0	Clear high LED port
	STA PORT1B	
	JSR LITE	Get LED pattern
	STA PORT1A	
	BCC CC	If carry set, PB0 = 1
	LDA #01	
	STA PORT1B	

The number of LEDs to turn on is in X. It must be converted into the appropriate pattern to put on the output port. This is done by the LITE subroutine, described below.

If LED #9 is to be turned on, the carry bit is set by LITE. An ex-

PLICIT test of the carry for this case is done above (the pattern 01 is then sent to PORT1B). The number of the current guess is decremented next. If it is 0, the player has lost: the lose signal is generated and a



**Fig. 4.5: Obtaining the LED pattern for 8 LED's**

## HARDWARE RANDOM NUMBER GENERATOR

new game is started; otherwise, the next guess is obtained:

CC	DEC GUESS#	
	BNE GETGES	Any guesses left?
	LDA #\$BE	Low tone
	JSR TONE	
	JMP START	New game

### The Subroutines

#### *LITE Subroutine*

The LITE subroutine will generate the pattern required to light up LEDs #1 to #8, depending on the number contained in register X. The required "1" bits are merely shifted right in the accumulator as register X is being decremented. An example is given in Figure 4.5.

4.5.

Upon exit from the subroutine, the accumulator contains the correct pattern required to light up the specified LEDs. If LED #9 is included, the pattern would consist of all ones, and the carry bit would be set:

LITE	LDA #0	
SHIFT	SEC	Starting "1"
	ROL A	Rotate the "1" to position
	DEX	Done?
	BNE SHIFT	
	RTS	

#### *TONE Subroutine*

The TONE subroutine will generate a tone for a duration specified by a constant in memory location DUR, at the frequency specified by the contents of the accumulator. Index register Y is used as the inner loop counter. The tone is generated, as usual, by turning the speaker connected to PORT3B on and off successively during the appropriate period of time:

TONE	STA FREQ
	LDA #\$00
	LDX DUR
FL2	LDY FREQ
FL1	DEY



```
CLC
BCC . + 2
BNE FL1
EOR #$FF
STA PORT3B
DEX
BNE
RTS
```

## SUMMARY

This time, the program used the timer's latch (i.e., a hardware register) rather than a software routine as a random number generator. A simple "LITE" routine was used to display a value, and the usual TONE routine was used to generate a sound.

## EXERCISES

**Exercise 4-1:** *Improve the Hexguess program by adding the following feature to it. At the end of each game, if the player has lost, the program will display [the number which the player should have guessed] for approximately 3 seconds, before starting a new game.*

**Exercise 4-2:** *What would happen if the SEC at location 290 hexadecimal were left out?*

**Exercise 4-3:** *What are the advantages and disadvantages of using the timer's value to generate a random number? What about the successive numbers? Will they be related? Identical?*

**Exercise 4-4:** *How many times does the above program blink the lights when it signals a win?*

**Exercise 4-5:** *Examine the WIN routine (line 24D). Will the win tone be sounded once or several times?*

**Exercise 4-6:** *What is the purpose of the two instructions at addresses 29F and 2A0? (Hint: read Chapter 2.)*

**Exercise 4-7:** *Should the program start the timer?*

**Exercise 4-8:** *Is the number of LEDs lit in response to a guess linearly related to the closeness of a guess?*

## 5. Simultaneous Input/Output (Magic Square)

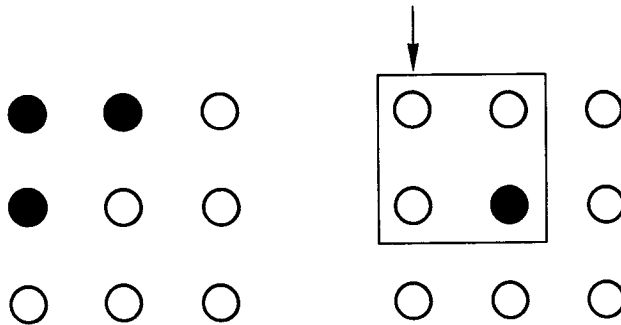
### INTRODUCTION

Special visual patterns will be created by this program. Random numbers will be generated by the hardware source, the timer. Delays, blinkers, and counters will be used.

### THE RULES

The object of the game is to light up a perfect square on the board, i.e., to light LEDs 1, 2, 3, 6, 9, 8, 7, and 4 but not LED #5 in the center.

The game is started with a random pattern. The player may modify the LED pattern on the board through the use of the keyboard, since each of the keys complements a group of LEDs. For example, each of the keys corresponding to the corner LED positions (key numbers: 1, 3, 9, and 7) complements the pattern of the square to which it is attached. Key #1 will complement the pattern formed by LEDs 1, 2, 4, 5. Assuming that LEDs 1, 2, and 4 are lit, pressing key #1 will result in the following pattern: 1-off, 2-off, 4-off, 5-on.



The pattern formed by LEDs 1, 2, 4, and 5 has been complemented and only LED #5 is lit after pressing key #1. Pressing key #1 again will result in: 1, 2, and 4-on with 5-off. Pressing a key twice results in two

## ADVANCED 6502 PROGRAMMING

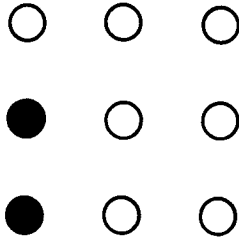
successive complementations, i.e., it cancels out the first action.

Similarly, key #9 complements the lower right-hand square formed by LEDs 5, 6, 8, and 9.

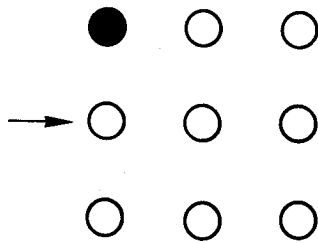
Key #3 complements the pattern formed by LEDs 2, 3, 5, and 6.

Key #7 complements the pattern formed by LEDs 4, 5, 7, and 8.

The "edge keys" corresponding to LEDs 2, 4, 6, and 8 complement the pattern formed by the three LEDs of the outer edge of which they are a part. For example, pressing key #2 will complement the pattern for LEDs 1, 2, and 3. Assume an initial pattern with LEDs 1, 2, and 3 lit. Pressing key #2 will result in obtaining the complemented pattern, i.e., turning off all three LEDs. Similarly, assume an initial pattern on the left vertical edge where LEDs 4 and 7 are lit.



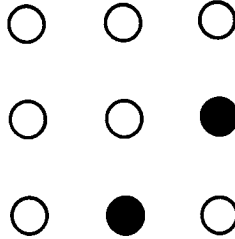
Pressing key #4 will result in a pattern where LED #1 is lit and LEDs 4 and 7 are turned off.



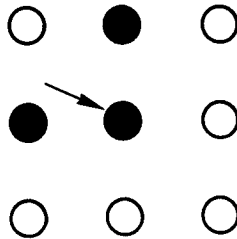
KEY 4 HAS BEEN PRESSED

Likewise, key #8 will complement the pattern formed by LEDs 7, 8, and 9, and key #6 will complement the pattern formed by LEDs 3, 6, and 9.

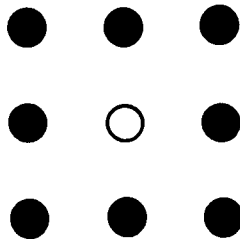
Finally, pressing key #5 (the center LED position) will result in complementing the pattern formed by LEDs 2, 4, 5, 6, and 8. For example, assume the following initial pattern where only LEDs 6 and 8 are lit:



Pressing key #5 will result in lighting up LEDs 2, 4, and 5:



The winning combination in which all LEDs on the edge of the square are lit is obtained by pressing the appropriate sequence of keys.



## ADVANCED 6502 PROGRAMMING

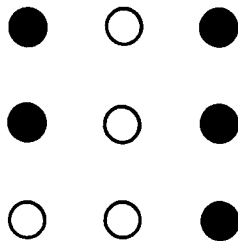
The mathematical proof that it is always possible to achieve a "win" is left as an exercise for the reader. The program confirms that the player has achieved the winning pattern by flashing the LEDs on and off.

Key "0" must be used to start a new game. A new random pattern of lit LEDs will be displayed on the board. The other keys are ignored.

### A TYPICAL GAME

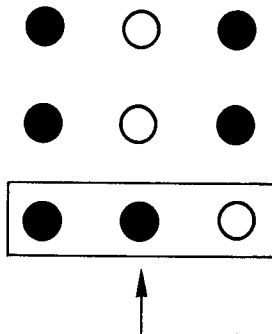
Here is a typical sequence:

The initial pattern is: 1-3-4-6-9.



Move: press key #8.

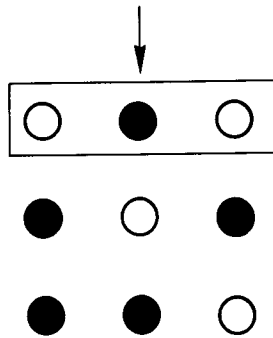
The resulting pattern is: 1-3-4-6-7-8.



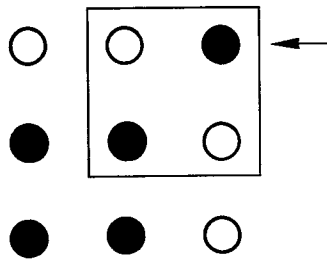
Next move: press key #2.

The resulting pattern is: 2-4-6-7-8.

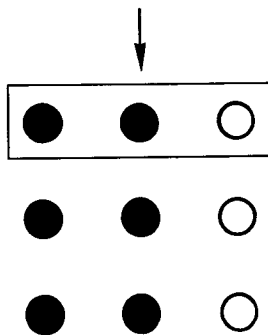
SIMULTANEOUS INPUT/OUTPUT



Next move: press key #3.  
The resulting pattern is: 3-4-5-7-8.



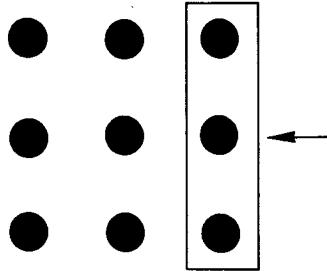
Next move: press key #2.  
The resulting pattern is 1-2-4-5-7-8.



## ADVANCED 6502 PROGRAMMING

Next move: press key #6.

The resulting pattern is 1-2-3-4-5-6-7-8-9.



Note that this is a “classic” pattern in which all LEDs on the board are lit. It is not a winning situation, as LED #5 should be off. Let us proceed.

Next move: the end of this game is left to the mathematical talent of the reader. The main purpose was to demonstrate the effect of the various moves.

Hint: a possible winning sequence is 2-4-6-8-5!

General advice: in order to win this game, try to arrive quickly at a symmetrical pattern on the board. Once a symmetrical pattern is obtained, it becomes a reasonably simple matter to obtain the perfect square. Generally speaking, a symmetrical pattern is obtained by hitting the keys corresponding to the LEDs which are off on the board but which should be “on” to complete the pattern.

### THE ALGORITHM

A pattern is generated on the board using random numbers. The key corresponding to the player’s move is then identified, and the appropriate group of LEDs on the board is complemented.

A table must be used to specify the LEDs forming a group for each key.

The new pattern is tested against a perfect square. If one exists, the player wins. Otherwise, the process begins anew.

The detailed flowchart is shown in Figure 5.1.

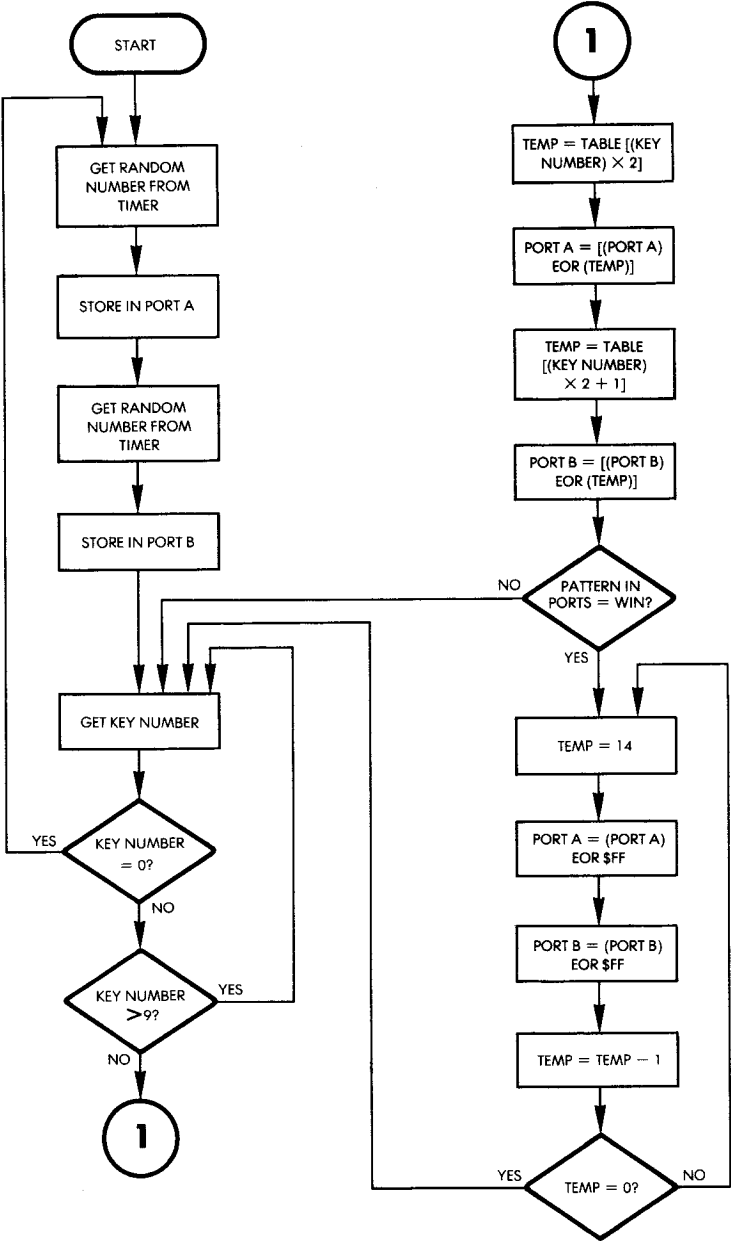


Fig. 5.1: Magic Square Flowchart



**THE PROGRAM**

**Data Structures**

The main problem here is to devise an efficient way to complement the correct LED pattern whenever a key is pressed. The complementation itself may be performed by an Exclusive-OR instruction. In this case, the pattern used with the EOR instruction should contain a "1" in each LED position which is to be complemented, and "0"s elsewhere. The solution is quite simple: a nine-entry table, called TABLE, is used. Each table entry corresponds to a key and has 16 bits of which only nine are used inasmuch as only nine LEDs are used. Each of the nine bits contains a "1" in the appropriate position, indicating the LED which will be affected by the key.

For example, we have seen that key number 1 will result in complementing LEDs 1, 2, 4, and 5. The corresponding table entry is therefore: 0, 0, 0, 1, 1, 0, 1, 1, where bits 1, 2, 4, and 5 (starting the numbering at 1, as with the keys) have been set to "1." Or, more precisely, using a 16-bit pattern:

0, 0, 0, 0, 0, 0, 0, 0, 0, 0, 0, 1, 1, 0, 1, 1

The complete table appears below in Figure 5.2.

KEY	PATTERN	
1	00011011	00000000
2	00000111	00000000
3	00110110	00000000
4	01001001	00000000
5	10111010	00000000
6	00100100	00000001
7	11011000	00000000
8	11000000	00000001
9	10110000	00000001

**Fig. 5.2: Complementation Table**

**Program Implementation**

A random pattern of LEDs must be lit on the board at the beginning of the game. This is done, as in the previous chapter, by reading the value of the VIA #1 timer. If a timer were not available, a random number-generating routine could be substituted.

## SIMULTANEOUS INPUT/OUTPUT

```

; 'MAGIC SQUARE' PROGRAM
;KEYS 1-9 ON THE HEX KEYBOARD ARE EACH ASSOCIATED
;WITH ONE LED IN THE 3X3 ARRAY. WHEN A KEY IS PRESSED,
;IT CHANGES THE PATTERN OF THE LIT LEDS IN THE ARRAY.
;THE OBJECT OF THE GAME IS TO CONVERT THE RANDOM
;PATTERN THE GAME STARTS WITH TO A SQUARE OF LIT
;LEDS BY PRESSING THE KEYS. THE LEDS WILL FLASH WHEN
;THE WINNING PATTERN IS ACHIEVED.
;KEY #0 CAN BE USED AT ANY TIME TO RESTART
;THE GAME WITH A NEW PATTERN.
;
GETKEY  = $100
T1CL   = $A004           ;LOW REGISTER OF TIMER IN 6522 VIA
PORT1  = $A001           ;6522 VIA PORT A
PORT2  = $A000           ;6522 VIA PORT B
TEMP   = $0000           ;TEMPORARY STORAGE
DDRA   = $A003           ;DATA DIRECTION REGISTER OF PORT A
DDRB   = $A002           ;SAME FOR PORT B
      ,= $200
;
;COMMENTS: THIS PROGRAM USES A TIMER REGISTER FOR A
; RANDOM NUMBER SOURCE. IF NONE IS AVAILABLE, A
; RANDOM NUMBER GENERATOR COULD BE USED, BUT
; DUE TO ITS REPEATABILITY, IT WOULD NOT WORK AS
; WELL. THIS PROGRAM USES PORT A'S REGISTERS FOR
; STORAGE OF THE LED PATTERN. SINCE WHAT IS READ
; BY THE PROCESSOR IS THE POLARITY OF THE
; OUTPUT LINES, AN EXCESSIVE LOAD ON THE LINES WOULD
; PREVENT THE PROGRAM FROM WORKING CORRECTLY.
;
0200: A9 FF          LDA #$FF      ;SET UP PORTS FOR OUTPUT
0202: 8D 03 A0      STA DDRA
0205: 8D 02 A0      STA DDRB
0208: AD 04 A0      START LDA T1CL   ;GET 1ST RANDOM NUMBER
020B: 8D 01 A0      STA PORT1
020E: AD 04 A0      LDA T1CL   ;...AND SECOND.
0211: 29 01        AND #01    ;MASK OUT BOTTOM ROW LEDS
0213: 8D 00 A0      STA PORT2
0214: 20 00 01     KEY   JSR GETKEY
0219: C9 00        CMP #0     ;KEY MUST BE 1-9: IS IT 0?
021B: F0 EB        BEQ START  ;YES, RESTART GAME WITH NEW BOARD.
021D: C9 0A        CMP #10    ;IS IT LESS THAN 10?
021F: 10 F5        BPL KEY    ;+ IF KEY >=10, SO GET ANOTHER
;
;FOLLOWING SECTION USES KEY NUMBER AS INDEX TO FIND IN
;TABLE A BIT PATTERN USED TO COMPLEMENT LED'S
;
0221: 38          SEC          ;DECREMENT A FOR TABLE ACCESS
0222: E9 01      SRC #1
0224: 0A          ASL A        ;MULTIPLY A*2, SINCE EACH ENTRY IN
;TABLE IS TWO BYTES.
0225: AA          TAX          ;USE A AS INDEX
0226: AD 01 A0    LDA PORT1    ;GET PORT CONTENTS FOR COMPLEMENT
0229: 5D 6B 02    EOR TABLE,X ;EOR PORT CONTENTS W/PATTERN
022C: 8D 01 A0    STA PORT1    ;RESTORE PORT1
022F: AD 00 A0    LDA PORT2    ;DO SAME WITH PORT2,
0232: 5D 6C 02    EOR TABLE+1,X ;...USING NEXT TABLE ENTRY.
0235: 29 01      AND #01     ;MASK OUT BOTTOM ROW LEDS
0237: 8D 00 A0    STA PORT2    ;...AND RESTORE.
;
;THIS SECTION CHECKS FOR WINNING PATTERN IN LEDS
;
023A: 4A          LSR A        ;SHIFT BIT 0 OF PORT 1 INTO CARRY.
023B: 90 D9      BCC KEY    ;IF NOT WIN PATTERN, GET NEXT MOVE
023D: AD 01 A0    LDA PORT1    ;LOAD PORT1 FOR WIN TEST
0240: C9 EF      CMP #211101111 ;CHECK FOR WIN PATTERN
0242: D0 D2      BNE KEY    ;NO WIN, GET NEXT MOVE

```

—Fig. 5.3: Magic Square Program—

# ADVANCED 6502 PROGRAMMING

```

;
;WIN BLINK LED'S EVERY 1/2 SEC, 4 TIMES
;
0244: A9 0E          LDA #14
0246: 85 00          STA TEMP          ;LOAD NUMBER OF BLINKS
0248: A2 20          BLINK LDX ##20          ;DELAY CONSTANT FOR .08 SEC
024A: A0 FF          DELAY LDY ##FF          ;OUTER LOOP OF VARIABLE DELAY
;ROUTINE, WHOSE DELAY TIME
;IS 2556 * (CONTENTS OF X ON ENTER
;10 MICROSEC LOOP V

024C: EA           DLY   NOP
024D: D0 00          BNE ,+2
024F: 88           DEY
0250: D0 FA          BNE DLY
0252: CA           DEX
0253: D0 F5          BNE DELAY
0255: AD 01 A0       LDA PORT1          ;GET PORTS AND COMPLEMENT THEM
0258: 49 FF          EOR ##FF
025A: 8D 01 A0       STA PORT1
025D: AD 00 A0       LDA PORT2
0260: 49 01          EOR #1
0262: 8D 00 A0       STA PORT2
0265: C6 00          DEC TEMP          ;COUNT DOWN NUMBER OF BLINKS
0267: D0 DF          BNE BLINK          ;DO AGAIN IF NOT DONE
0269: F0 AB          BEQ KEY           ;GET NEXT MOVE

;
;TABLE OF CODES USED TO COMPLEMENT LEDS
;
026B: 1B           TABLE .BYT %00011011,%00000000
026C: 00
026D: 07           .BYT %00000111,%00000000
026E: 00
026F: 36           .BYT %00110110,%00000000
0270: 00
0271: 49           .BYT %01001001,%00000000
0272: 00
0273: BA           .BYT %10111010,%00000000
0274: 00
0275: 24           .BYT %00100100,%00000001
0276: 01
0277: D8           .BYT %11011000,%00000000
0278: 00
0279: C0           .BYT %11000000,%00000001
027A: 01
027B: B0           .BYT %10110000,%00000001
027C: 01

SYMBOL TABLE:
GETKEY      0100      T1CL      A004      PORT1     A001
PORT2      A000      TEMP      0000      DDRA      A003
DDRB       A002      START     0208      KEY       0216
BLINK      0248      DELAY     024A      DLY       024C
TABLE      026B

%

```

Fig. 5.3: Magic Square Program (Continued)

The data direction registers for Ports A and B of the VIA are configured for output to drive the LEDs:

```
LDA #$FF
STA DDRA
STA DDRB
```

The “random” numbers are then obtained by reading the value of timer 1 of the VIA and are used to provide a random pattern for the LEDs. (Two numbers provide 16 bits, of which 9 are kept.)

```
START    LDA T1CL      Get 1st number
          STA PORT1  Use it
          LDA T1CL      Get 2nd number
          AND #01      Keep only position 0
          STA PORT2  Use it
```

An explanation of the use of T1CL has been presented in the previous chapter. The program then monitors the keyboard for the key stroke of the player. It will accept only inputs “0” through “9” and will reject all others:

```
KEY      JSR GETKEY
          CMP #0        Is key 0?
          BEQ START
          CMP #10
          BPL KEY       If key = 10 get another
```

If the player has pressed key “0,” the program is restarted with a new LED display. If it is a value between “1” and “9” that is pressed, the appropriate change must be performed on the LED pattern. The key number will be used as an index to the table of complementation codes. Since the keys are labeled 1 through 9, the key number must first be decremented by 1 in order to be used as an index. Since the table contains double-byte entries, the index number must also be multiplied by 2. This is performed by the following three instructions:

```
SEC
SBC #1    Subtract 1
ASL A     Multiply by 2
```

## ADVANCED 6502 PROGRAMMING

Remember that a shift left is equivalent to a multiplication by 2 in the binary system. The resulting value is used as an index and stored in index register X:

TAX

The LED pattern is stored in the Port A data registers. It will be complemented by executing an EOR instruction on Port 1, then repeating the process for Port 2:

```
LDA PORT1
EOR TABLE,X      Complement Port1
STA PORT1
LDA PORT2
EOR TABLE + 1,X  Same for Port2
AND #01           Mask out unused bits
STA PORT2
```

Note that assembly-time arithmetic is used to specify the second byte in the table:

```
EOR TABLE + 1,X
```

Once the pattern has been complemented, the program checks for a winning pattern. To do so, the contents of Port 2 and Port 1 must be matched against the correct LED pattern. For Port 2, this is "0, 0, 0, 0, 0, 0, 0, 1." For Port 1, this is "1, 1, 1, 0, 1, 1, 1, 1." Bit 0 of Port 2 happens presently to be contained in the accumulator and can be tested immediately after a right shift:

```
LSR A             Shift bit 0 of Port 2
BCC KEY
```

The contents of Port 1 must be explicitly compared to the appropriate pattern:

```
LDA PORT1
CMP #%11101111
BNE KEY
```

To confirm the win, LEDs are now blinked on the board. TEMP is used as a counter variable; X is used to set the fixed delay duration. Y is used as a counter for the innermost loop. Each port is complemented after the delay has elapsed.

	LDA #14	
	STA TEMP	Load number of blinks
BLINK	LDX #\$20	Delay constant for .08 sec
DELAY	LDY #\$FF	Outer loop of variable delay routine, whose delay time is $2556 \times$ (Contents of X on entry) $10 \mu\text{s}$ loop
DLY	NOP	
	BNE . + 2	
	DEY	
	BNE DLY	
	DEX	
	BNE DELAY	
	LDA PORT1	Get ports and complement them
	EOR #\$FF	
	STA PORT1	
	LDA PORT2	
	EOR #1	
	STA PORT2	
	DEC TEMP	Count down number of blinks
	BNE BLINK	Do again if not done
	BEQ KEY	Get next key

## SUMMARY

This game of skill required a special table to perform the various complementations. The timer is used directly to provide a pseudo-random number, rather than a program. The LED pattern is stored directly in the I/O chip's registers.

## EXERCISES

**Exercise 5-1:** Rewrite the end of the program using a delay subroutine.

**Exercise 5-2:** Will the starting pattern be reasonably random?

## ADVANCED 6502 PROGRAMMING

**Exercise 5-3:** *Provide sound effects.*

**Exercise 5-4:** *Allow the use of key "A" to perform a different change such as a total complementation.*

**Exercise 5-5 (more difficult):** *Write a program which allows the computer to play and win.*

**Exercise 5-6:** *Add to the previous exercise the following feature: record the number of moves played by the computer, then play against the computer. You must win in fewer moves. You may specify an identical starting pattern for yourself and the computer. In this case, you should start, then let the computer "show you." If the computer requires more moves than you do, you are either an excellent player, a lucky player, or you are a poor programmer. Perhaps you are using the wrong algorithm!*

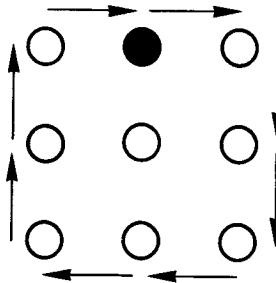
## 6. Simple Real Time Simulation (Spinner)

### INTRODUCTION

This program will react in real time to an operator input. The game will operate at multiple levels of difficulty using more complex loop counters.

### THE RULES

A light spins around the square formed by LEDs 1, 2, 3, 6, 9, 8, 7, and 4, in a counterclockwise fashion.



The object of the game is to stop the light by hitting the key corresponding to the LED at the exact time that the LED lights up. Every time that the spinning light is stopped successfully, it will start spinning at a faster rate. Every time that the player fails to stop the LED within 32 spins, the light will stop briefly on LED #4, then resume spinning at a slower pace. The expert player will be able to make the light spin faster and faster, until the maximum speed is reached. At this point, all the LEDs on the Games Board (LEDs 1 through 15) light up simultaneously. It is a win, and a new game is started.

Each win is indicated to the player by a hesitation of the light on the LED corresponding to the key pressed. When a complete game is won, all LEDs on the Games Board will be lit.



This game can also be used to sharpen a player's reflexes, or to test his or her reaction time. In some cases, a player's reaction may be too slow to catch the rotating LED even at its slowest speed. In such a case, the player may be authorized to press two, or even three, consecutive keys at once. This extends the player's response time. For example, with this program, if the player would press keys 7, 8, and 9 simultaneously, the light would stop if it was at any one of those positions (7, 8, or 9).

### THE ALGORITHM

The flowchart is presented in Figure 6.1. The game may operate at eight levels of difficulty, corresponding to the successive speeds of the "blip" traveling with increased rapidity around the LED square. An 8-bit counter register is used for two functions simultaneously. (See Figure 6.2.) The lower 3 bits of this register are used as the "blip-counter" and point to the current position of the light on the LED square. Three bits will select one of eight LEDs. The left-most 5 bits of this register are used as a "loop-counter" to indicate how many times the blip traverses the loop. Five bits allow up to 32 repetitions. LEDs are lit in succession by incrementing this counter. Whenever the blip-counter goes from "8" to "0," a carry will propagate into the loop-counter, incrementing it automatically. Allocating the 8 bits of register Y to two different conceptual counters facilitates programming. Another convention could be used.

Every time that an LED is lit, the keyboard is scanned to determine whether the corresponding key has been pressed. Note that if the key was pressed prior to the LED being lit, it will be ignored. This is accomplished with an "invalid flag." Thus, the algorithm checks to see whether or not a key was initially depressed and then ignores any further closures if it was. A delay constant is obtained by multiplying the difficulty level by four. Then, during the delay while the LED is lit, a new check is performed for a key closure if no key had been pressed at the beginning of this routine. If a key had been pressed at the beginning it will be treated as a miss, and the program will not check again to see if the key was pressed as the "invalid flag" will have been set.

Every time the correct key is pressed during the delay while the LED is on (left branch of the flowchart in the middle section of Figure 6.1), the value of the difficulty level is decremented (a lower difficulty number results in a higher rotation speed). For every miss on the part

of the player, the difficulty value is incremented up to 15, resulting in a slower spin of the light. Once a difficulty level of 0 has been reached, if a hit is recorded, all LEDs on the board will light to acknowledge the situation.

## THE PROGRAM

### Data Structures

The program uses two tables. The KYTBL table stores the key numbers corresponding to the circular LED sequence: 1,2,3,6,9,8,7,4. It is located at memory addresses 0B through 12. See the program listing in Figure 6.3.

The second table, LTABLE, contains the required bit patterns which must be sent to the VIA's port to illuminate the LEDs in sequence. For example, to illuminate LED #1, bit pattern "00000001", or 01 hexadecimal, must be sent. For LED #2, the bit pattern "00000010" must be sent, or 02 hexadecimal. Similarly, for the other LEDs, the required pattern is: 04, 20, 00, 80, 40; 0B in hexadecimal.

Note that there is an exception for LED #9. The corresponding pattern is "0" for Port 1, and bit 0 of Port 2 must also be turned on. We will need to check for this special situation later on.

### Program Implementation

Three variables are stored in memory page 0:

DURAT	Is the delay between two successive LED illuminations
DIFCLT	Is the "difficulty level" (reversed)
DNTST	Is a flag used to detect an illegal key closure when scanning the keys

As usual, the program initializes the three required data direction registers: DDR1 on both Port A and Port B for the LEDs, and DDR3B for the keyboard:

```
START      LDA #$FF
           STA DDRIA
           STA DDRIB
           STA DDR3B
```

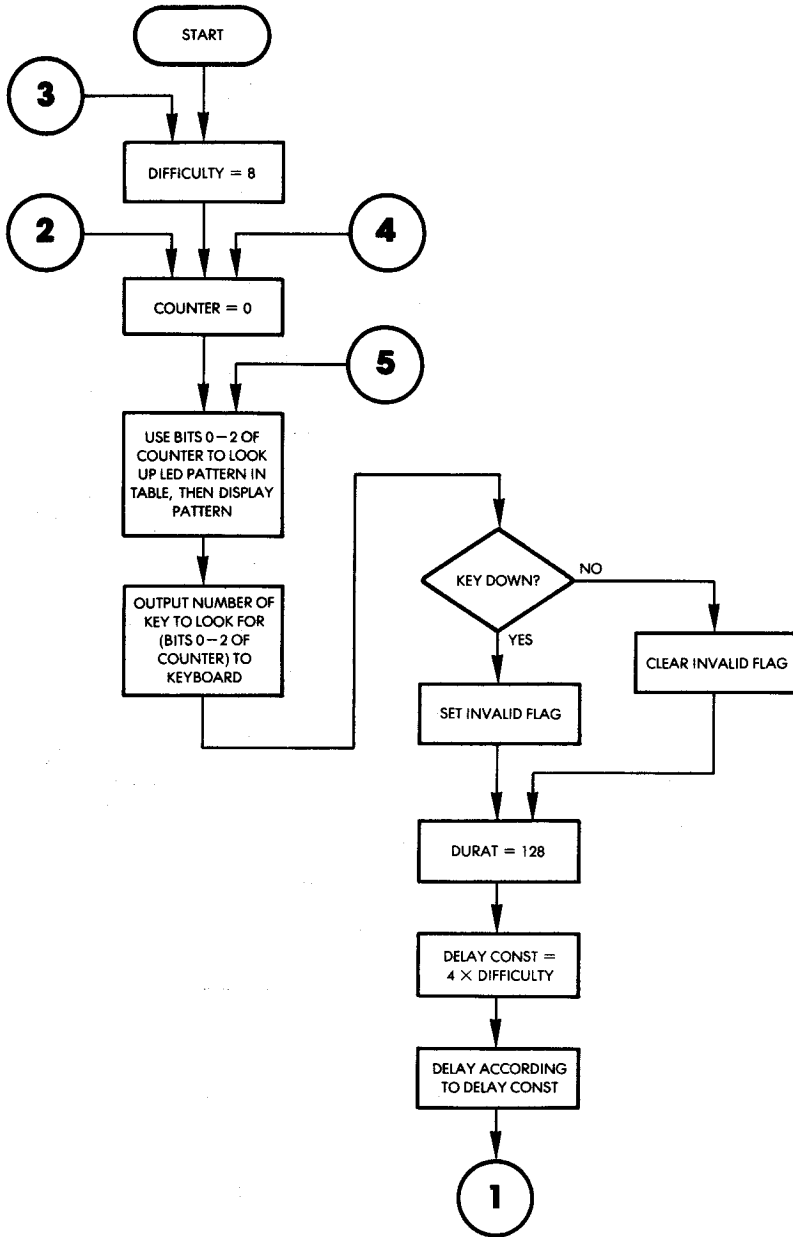


Fig. 6.1: Spinner Flowchart

# SIMPLE REAL TIME SIMULATION

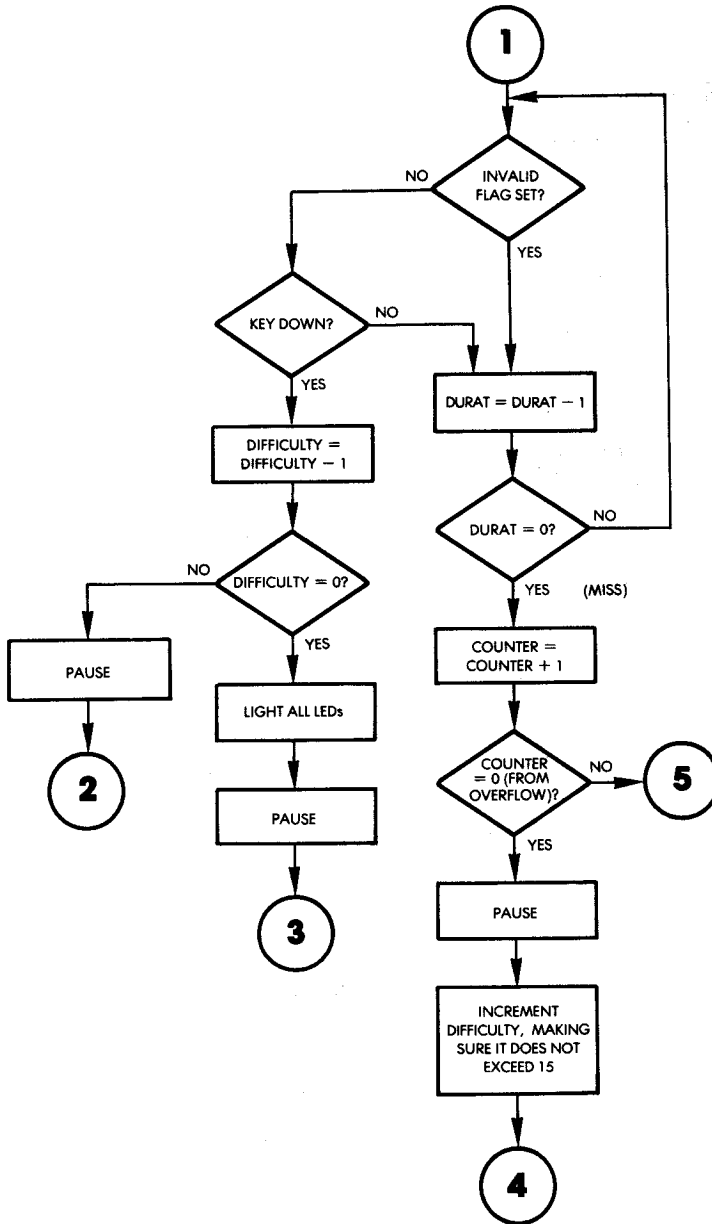
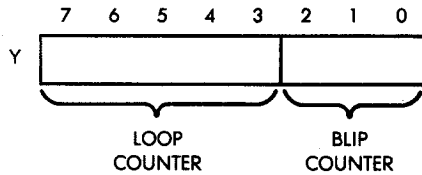


Fig. 6.1: Spinner Flowchart (Continued)



**Fig. 6.2: Dual Counter**

The difficulty level is set to 8, an average value:

```
LDA #8
STA DFCLT
```

The keystrobe port is conditioned for input:

```
STA DDR3A
```

The Y register, to be used as our generalized loop-plus-blip-counter, is set to '0':

```
NWGME    LDY #0
```

The key-down indicator is also set to "0":

```
LOOP     LDA #0
          STA DNTST
```

LED #9 is cleared:

```
STA PORT1B
```

The lower 3 bits of the counter are extracted. They contain the blip-counter and are used as an index into the LED pattern table:

TYA	Y contains counter
AND #\$07	Extract lower 3 bits
TAX	Use as index

The pattern is obtained from LTABL, using an indexed addressing

# SIMPLE REAL TIME SIMULATION

```

LINE # LOC      CODE      LINE
0002 0000      ; 'SPINNER'
0003 0000      ;PROGRAM TO TEST REACTION TIME OF PLAYER.
0004 0000      ;BLIP OF LIGHT SPINS AROUND EDGE
0005 0000      ;OF 3X3 LED MATRIX, AND USER MUST PRESS
0006 0000      ;CORRESPONDING KEY. IF, AFTER A NUMBER OF
0007 0000      ;SPINS, CORRECT KEY HAS NOT BEEN PRESSED,
0008 0000      ;BLIP SPINS SLOWER. IF CORRECT KEY HAS BEEN
0009 0000      ;PRESSED, BLIP SPINS FASTER. ALL
0010 0000      ;LEDS LIGHT WHEN SUCCESSFUL KEYPRESS
0011 0000      ;OCCURS ON MAXIMUM SPEED.
0012 0000      ;
0013 0000      ;I/O :
0014 0000      ;
0015 0000      PORT1A = $A001          ;LEDS 1-8
0016 0000      PORT1B = $A000          ;LEDS 8-15
0017 0000      DDR1A = $A003
0018 0000      DDR1B = $A002
0019 0000      PORT3A = $AC01          ;KEY STROBE INPUT.
0020 0000      PORT3B = $AC00          ;KEY # OUTPUT.
0021 0000      DDR3A = $AC03
0022 0000      DDR3B = $AC02
0023 0000      ;
0024 0000      ;VARIABLE STORAGE:
0025 0000      ;
0026 0000      * = $0
0027 0000      ;
0028 0000      DURAT *=*+1          ;DURATION OF INTER-MOVEMENT DELAY.
0029 0001      DIFCLT *=*+1          ;DIFFICULTY LEVEL.
0030 0002      DNTST *=*+1          ;SET TO $01 IF KEY DOWN AT START
0031 0003          ;OF INTER-MOVEMENT DELAY.
0032 0003      ;
0033 0003      ;TABLE OF PATTERNS TO BE SENT TO LED
0034 0003      ;MATRIX AT EACH LOOP COUNT.
0035 0003      ;SET FOR CLOCKWISE ROTATION STARTING AT LED #1.
0036 0003      ;
0037 0003 01      LTABLE .BYTE $01,$02,$04,$20,$00,$80,$40,$08
0037 0004 02
0037 0005 04
0037 0006 20
0037 0007 00
0037 0008 80
0037 0009 40
0037 000A 08
0038 000B      ;
0039 000B      ;TABLE OF PATTERNS TO BE SENT TO KEYBOARD
0040 000B      ;TO TEST IF LEDES ARE ON AT EACH LOOP COUNT.
0041 000B      ;
0042 000B 01      KYTBL .BYTE 1,2,3,6,9,8,7,4
0042 000C 02
0042 000D 03
0042 000E 06
0042 000F 09
0042 0010 08
0042 0011 07
0042 0012 04
0043 0013      ;
0044 0013      ;MAIN PROGRAM
0045 0013      ;
0046 0013      * = $200
0047 0200      ;
0048 0200 A9 FF      START LDA #$FF          ;SET I/O REGISTERS.
0049 0202 8D 03 A0      STA DDR1A
0050 0205 8D 02 A0      STA DDR1B
0051 0208 8D 02 AC      STA DDR3B
0052 020B A9 08          LDA #8
0053 020D 85 01          STA DIFCLT          ;SET DIFFICULTY.
0054 020F 8D 03 AC      STA DDR3A          ;SET KEYSTROBE PORT.
0055 0212 A0 00          LDY #0             ;RESET LOOP/BLIP COUNTER.
0056 0214 A9 00          LOOP LDA #0
0057 0216 85 02          STA DNTST          ;CLEAR KEYDOWN INDICATOR.
0058 0218 8D 00 A0          STA PORT1B        ;CLEAR HI LED PORT.
0059 021B 98             TYA                ;USE LOWER 3 BITS OF MAIN COUNTER
0060 021C 29 07          AND #$07          ;AS INDEX TO FIND LED PATTERN
0061 021E AA             TAX                ;IN TABLE OF PATTERNS.
0062 021F B5 03          LDA LTABLE,X      ;GET PATTERN FOR LED TO

```

**Fig. 6.3: Spinner Program**

# ADVANCED 6502 PROGRAMMING

```

0063 0221                ;BE TURNED ON.
0064 0221 8D 01 A0      STA PORT1A      ;STORE IN LED PORT.
0065 0224 D0 05        BNE CHECK      ;IF PATTERN <> 0, SKIP.
0066 0226 A9 01        LDA #1         ;PATTERN=0, SO SET HI BIT.
0067 0228 8D 00 A0      STA PORT1B
0068 022B B5 0B      CHECK LDA KYTBL,X   ;GET KEY# TO TEST FOR.
0069 022D 8D 00 AC      STA PORT3B      ;STORE IN KEYPORT.
0070 0230 2C 01 AC      BIT PORT3A      ;STROBE HI?
0071 0233 30 04        BMI DELAY      ;IF NOT, SKIP.
0072 0235 A9 01      INVALID LDA #01     ;STOBE HI: SET KEY DOWN MARKER.
0073 0237 B5 02      STA DNTST
0074 0239 A9 80      DELAY LDA #$80     ;GET # OF LOOP CYCLES (DELAY LENGTH)
0075 023B B5 00      STA DURAT
0076 023D A5 01      DL1  LDA DIFCLT    ;MULTIPLY DIFFICULTY COUNTER
0077 023F 0A         ASL A             ;BY FOUR TO DETERMINE DELAY
0078 0240 0A         ASL A             ;LENGTH.
0079 0241 AA         TAX
0080 0242 26 02      DL2  ROL DNTST     ;DELAY ACCORDING TO DIFCLT.
0081 0244 66 02      ROR DNTST
0082 0246 CA         DEX
0083 0247 D0 F9      BNE DL2         ;LOOP 'TIL COUNT = 0
0084 0249 A5 02      LDA DNTST     ;GET KEY DOWN FLAG.
0085 024B D0 05      BNE NOTST     ;IF KEY WAS DOWN AT BEGINNING OF
0086 024D                ;DELAY, DON'T TEST IT.
0087 024D 2C 01 AC      BIT PORT3A      ;CHECK KEY STROBE.
0088 0250 10 19      BPL HIT         ;KEY HAS CLOSED DURING DELAY: HIT.
0089 0252 C6 00      NOTST DEC DURAT    ;COUNT DELAY LOOP DOWN.
0090 0254 D0 E7      BNE DL1         ;LOOP IF NOT 0.
0091 0256 C8         INY             ;INCREMENT MAIN SPIN COUNTER.
0092 0257 D0 BB      BNE LOOP     ;IF 32 LOOPS NOT DONE, DO NEXT LOOP
0093 0259 A6 01      LDX DIFCLT    ;NO HITS THIS TIME, MAKE NEXT
0094 025B                ;EASIER.
0095 025B EB         INX
0096 025C 8A         TXA             ;MAKE SURE DIFFICULTY DOES NOT
0097 025D C9 10      CMP #16      ;EXCEED 15
0098 025F D0 02      BNE OK
0099 0261 A9 0F      LDA #15
0100 0263 B5 01      OK   STA DIFCLT
0101 0265 20 80 02   JSR WAIT     ;PAUSE A BIT.
0102 0268 4C 12 02   JRP NWGME    ;START NEW ROUND.
0103 026B 20 80 02   HIT   JSR WAIT     ;PAUSE A BIT.
0104 026E C6 01      DEC DIFCLT    ;MAKE NEXT GAME HARDER.
0105 0270 D0 A0      BNE NWGME    ;IF DIFFICULTY NOT 0 (HARDEST),
0106 0272                ;PLAY NEXT GAME.
0107 0272 A9 FF      LDA #$FF     ;PLAYER HAS MADE IT TO TOP
0108 0274 8D 01 A0      STA PORT1A    ;DIFFICULTY LEVEL, LIGHT ALL LEDS.
0109 0277 8D 00 A0      STA PORT1B
0110 027A 20 80 02   JSR WAIT     ;PAUSE A BIT.
0111 027D 4C 00 02   JMP START    ;PLAY ANOTHER GAME.
0112 0280                ;
0113 0280                ;SUBROUTINE 'WAIT'
0114 0280                ;SHORT DELAY.
0115 0280                ;
0116 0280 A0 FF      WAIT  LDY #$FF
0117 0282 A2 FF      LP1   LDX #$FF
0118 0284 66 00      LP2   ROR DURAT
0119 0286 26 00      ROL DURAT
0120 0288 66 00      ROR DURAT
0121 028A 26 00      ROL DURAT
0122 028C CA         DEX
0123 028D D0 F5      BNE LP2
0124 028F 8B         DEY
0125 0290 D0 F0      BNE LP1
0126 0292 60         RTS
0127 0293                .END

```

SYMBOL TABLE

SYMBOL	VALUE
CHECK	022B DDR1A A003 DDR1B A002 DDR3A AC03
DDR3B	AC02 DELAY 0239 DIFCLT 0001 DL1 023D
DL2	0242 DNTST 0002 DURAT 0000 HIT 026B
INVALID	0235 KYTBL 000B LOOP 0214 LP1 0282
LP2	0284 LTABLE 0003 NOTST 0252 NWGME 0212
OK	0263 PORT1A A001 PORT1B A000 PORT3A AC01
PORT3B	AC00 START 0200 WAIT 0280

END OF ASSEMBLY

Fig. 6.3: Spinner Program (Continued)

mechanism with register X, and this pattern is output on Port 1A to light up the appropriate LED:

```
LDA LTABLE, X    Get pattern
STA PORT1A      Use it to light up LED
```

As we indicated in the previous section, an explicit check must be made for the pattern "0," which requires that bit 0 of Port B be turned on. This corresponds to LED #9:

```
BNE CHECK      Was pattern = 0?
LDA #1         If not, set LED #9
STA PORT1B
```

Once the correct LED has been lit, the keyboard must be inspected to determine whether the player has already pressed the correct key. The program only checks the key number corresponding to the LED being lit:

```
CHECK          LDA KYTBL, X    X contains correct pointer
                STA PORT 3B    Select correct key
                BIT PORT 3A    Strobe hi?
                BMI DELAY     If not, skip
```

If the corresponding key is down (a strobe high on Port 3A is detected), the key-down flag, DNTST, is set to "1":

```
INVALID        LDA #01
                STA DNTST
```

This is an illegal key closure. It will be ignored. A delay to keep the LED lit is implemented by loading a value in memory location DURAT. This location is used as a loop-counter. It will be decremented later on and will cause a branch back to location DL1 to occur:

```
DELAY          LDA #$80
                STA DURAT
```

The difficulty counter, DIFCLT, is then multiplied by four. This is accomplished by two successive left shifts:



## ADVANCED 6502 PROGRAMMING

```
DL1      LDA DIFCLT
          ASL A
          ASL A
          TAX
```

The result is saved in index register X. It will determine the delay length. The lower the "difficulty-level," the shorter the delay will be.

The delay loop is then implemented:

```
DL2      ROL DNTST
          ROR DNTST
          DEX
          BNE DL2      Loop til count = 0
```

The key-down flag, DNTST, is then retrieved from memory and tested. If the key was down at the beginning of this routine, the program branches to location NOTST. Otherwise, if a closure is detected, a hit is reported and a branch occurs to location HIT:

```
          LDA DNTST
          BNE NOTST
          BIT PORT3A   Check key strobe
          BPL HIT
```

At NOTST, the external delay loop proceeds: the value of DURAT is decremented and a branch back to location DL1 occurs, unless DURAT decrements to "0." Whenever the delay decrements to "0" without a hit, the main counter (register Y) is incremented by 1. This results in advancing the blip-counter (lower three bits of register Y) to the next LED. However, if the blip-counter was pointing to LED #4 (the last one in our sequence), the loop-counter (upper 5 bits of register Y) will automatically be incremented by 1 when the blip-counter advances. If the value 32 is reached for the loop-counter, the value of register Y after incrementation will be "0" (in fact, an overflow will have occurred into the carry bit). This condition is tested explicitly:

```
NOTST    DEC DURAT
          BNE DL1      Loop if not 0
          INY          Increment counter
          BNE LOOP     32 loops?
```

## SIMPLE REAL TIME SIMULATION

Once the Y register has overflowed, i.e., 32 loops have been executed, the difficulty value is increased, resulting in a slower spin:

```
LDX DIFCLT    No hits. Make it easier
INX
```

The maximum difficulty level is 15, and this is tested explicitly:

```
TXA          Only A may be compared
CMP #16
BNE OK
LDA #15      Stay at 15 maximum
OK           STA DIFCLT
```

Finally, a brief pause is implemented:

```
JSR WAIT
```

and a new spin is started:

```
JMP NWGME
```

In the case of a hit, a pause is also implemented:

```
HIT          JSR WAIT
```

then the game is made harder by decrementing the difficulty count (DIFCLT)

```
DEC DIFCLT
```

The difficulty value is tested for "0" (fastest possible spin). If the "0" level has been reached, the player has won the game and all LEDs are illuminated:

```
BNE NWGME    If not 0, play next game
LDA #$FF     It is a win
STA PORT1A   Light up
STA PORT1B
```

The usual pause is implemented, and a new game is started:

## ADVANCED 6502 PROGRAMMING

```
JSR WAIT
JMP START
```

The pause is achieved with the usual delay subroutine called “WAIT.” It is a classic, two-level nested loop delay subroutine, with additional do-nothing instructions inserted at address 0286 to make it last longer:

```
WAIT      LDY #$FF
LP1       LDX #$FF
LP2       ROR DURAT
          ROL DURAT
          ROR DURAT
          ROL DURAT
          DEX
          BNE LP2
          DEY
          BNE LP1
          RTS
```

### SUMMARY

This program implemented a game of skill. Multiple levels of difficulty were provided in order to challenge the player. Since human reaction time is slow, all delays were implemented as delay loops. For efficiency, a special double-counter was implemented in a single register: the blip counter—loop counter.

### EXERCISES

**Exercise 6-1:** *There are several ways to “cheat” with this program. Any given key can be vibrated rapidly. Also, it is possible to press any number of keys simultaneously, thereby massively increasing the odds. Modify the above program to prevent these two possibilities.*

**Exercise 6-2:** *Change the rotation speed of the light around the LEDs by modifying the appropriate memory location. (Hint: this memory location has a name indicated at the beginning of the program.)*

**Exercise 6-3:** *Add sound effects.*

## **7. Real Time Simulation (Slot Machine)**

### **INTRODUCTION**

This program simulates an actual electro-mechanical machine and operates in real time. It performs a complex score evaluation using indexed addressing techniques as well as special data structures to facilitate and expedite the process.

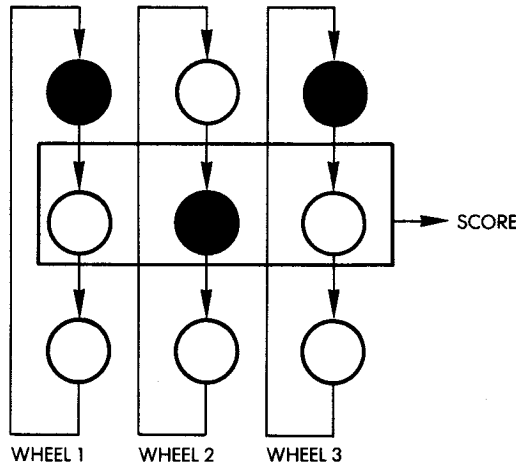
### **THE RULES**

This program simulates a Las Vegas-type slot machine. The rotation of the wheels on a slot machine is simulated by three vertical rows of lights on LED columns 1-4-7, 2-5-8, and 3-6-9. The lights "rotate" around these three columns, and eventually stop. (See Figure 7.1.) The final light combination representing the player's score is formed by LEDs 4-5-6, i.e., the middle horizontal row.

At the beginning of each game, the player is given eight points. The player's score is displayed by the corresponding LED on the Games Board. At the start of each game, LED #8 is lit, indicating this initial score of 8.

The player starts the slot machine by pressing any key. The lights start spinning on the three vertical rows of LEDs. Once they stop, the combination of lights in LEDs 4, 5, and 6 determines the new score. If either zero or one LED is lit in this middle row, it is a lose situation, and the player loses one point. If two LEDs are lit in the middle row, the player's score is increased by one point. If three LEDs are lit in the middle row, three points are added to the player's score.

Whenever a total score of zero is obtained, the player has lost the game. The player wins the game when his or her score reaches 16 points. Everything that happens while the game is being played produces tones from the machine. While the LEDs are spinning, the speaker crackles, reinforcing the feeling of motion. Whenever the lights stop rotating, a tone sounds in the speaker, at a high pitch if it is a win situation, or at a low pitch if it is a lose situation. In particular, after a player takes his or her turn, if there are three lights in the mid-



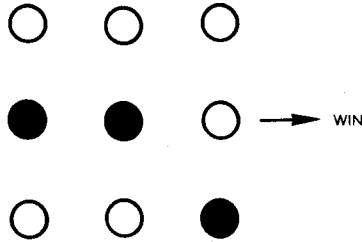
**Fig. 7.1: The Slot Machine**

dle row (a win situation), the speaker will go beep-beep-beep in a high pitch, to draw attention to the fact that the score is being incremented by three points. Whenever the maximum of 16 points is reached, the player has obtained a “jackpot.” At this point all the LEDs on the board will light up simultaneously, and a siren sound will be generated (in ascending tones). Conversely, whenever a null score is reached, a siren will be sounded in descending tones.

Note that, unlike the Las Vegas model, this machine will let you win frequently! Good luck. However, as you know, it is not as much a matter of luck as it is a matter of programming (as in Las Vegas machines). You will find that both the scoring and the probabilities can be easily modified through programming.

### **A TYPICAL GAME**

The Games Board initially displays a lit LED in position 8, indicating a starting score of 8. At this point the player should select and press a key. For this example let’s press key 0. The lights start spinning. At the end of this spin, LEDs 4, 5, and 9 are lit. (See Figure 7.2.) This is a win situation and one point will be added to the score. The high-pitch tone sounds. LED #9 is then lit to indicate the total of the 8 previous points plus the one point obtained on this spin.



**Fig. 7.2: A Win Situation**

Key 0 is pressed again. This time only LED 5 in the middle row is lit after the spin. The score reverts back to 8. (Remember, the player loses 1 point from his or her score if either zero or only one LED in the middle row is lit after the spin.)

Key 0 is pressed again; this time LEDs 5 and 6 light up resulting in a score of nine.

Key 0 is pressed again. LED 4 is lit at the end of the spin, and LED 8 lights up again.

Key 0 is pressed. LED 6 is lit. The score is now 7, etc.

### **THE ALGORITHM**

The basic sequencing for the slot machine program is shown in the flowchart in Figure 7.3. First, the score is displayed, then the game is started by the player's key stroke and the LEDs are spun. After this, the results are evaluated: the score is correspondingly updated and a win or lose situation is indicated.

The LED positions in a column are labeled 0, 1, 2, from the top to bottom. LEDs are spun by sequentially lighting positions 0, 1, 2, and then returning to position 0. The LEDs continue to spin in this manner and their speed of rotation diminishes until they finally come to a stop. This effect is achieved by incrementing the delay between each successive actuation of an LED within a given column. A counter-register is associated with each "wheel," or column of three LEDs. The initial contents of the three counters for wheels 1, 2, and 3 are obtained from a random number generator. In order to influence the odds, the random number must fit within a programmable bracket called (LOLIM, HILIM). The value of this counter is transferred to a temporary memory location. This location is regularly decremented until it reaches the value "0." When the value 0 is reached, the next LED on

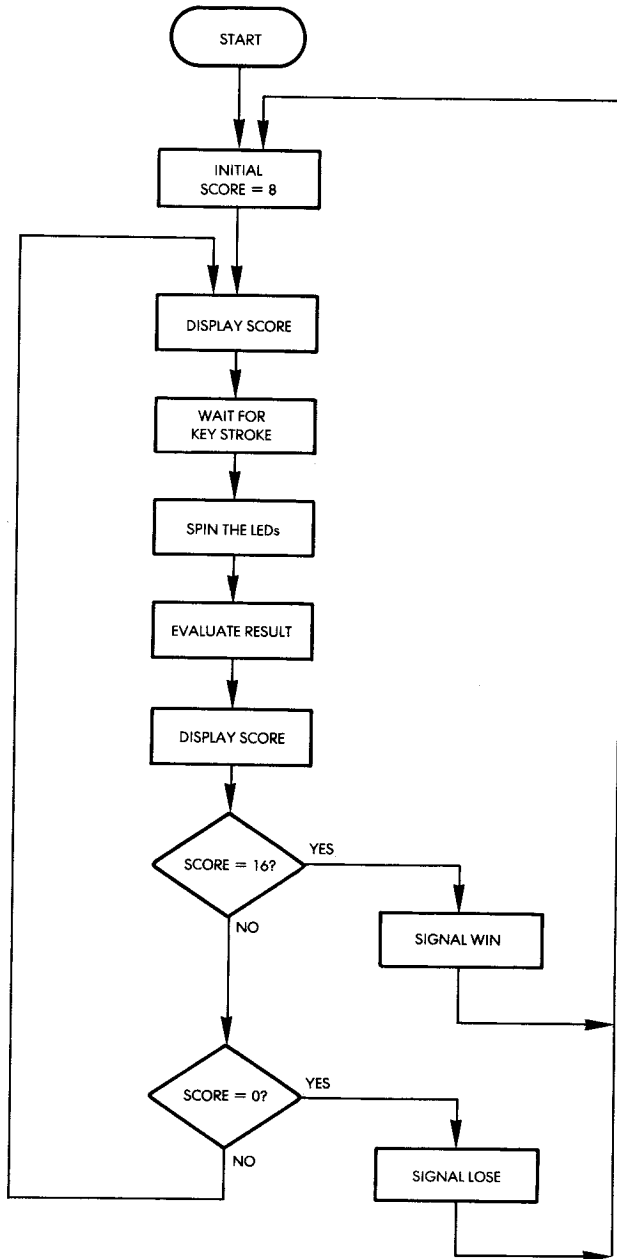


Fig. 7.3: Slots Flowchart

the “wheel” is lit. In addition, the original counter contents are incremented by one, resulting in a longer delay before lighting up the next LED. Whenever the counter overflows to 0, the process for that wheel stops. Thus, by using synchronous updating of the temporary memory locations, the effect of asynchronously moving LED “blips” is achieved. When all LEDs have stopped, the resulting position is evaluated.

The flowchart corresponding to this DISPLAY routine is shown in Figure 7.4. Let us analyze it. In steps 1, 2, and 3 the LED pointers are initialized to the top row of LEDs (position 0). The three counters used to supply the timing interval for each wheel are filled with numbers from a random number generator. The random number is selected between set limits. Finally, the three counters are copied into the temporary locations reserved for decrementing the delay constants.

Let us examine the next steps presented in Figure 7.4:

4. The wheel pointer  $X$  is set at the right-most column:  $X = 3$ .
5. The corresponding counter for the current column (column 3 this time) is tested for the value 0 to see if the wheel has stopped. It is not 0 the first time around.
- 6,7. The delay constant for the column of LEDs determined by the wheel pointer is decremented, then it is tested against the value 0. If the delay is not 0, nothing else happens for this column, and we move to the left by one column position:
  16. The column pointer  $X$  is decremented:  $X = X - 1$
  17.  $X$  is tested against zero. If  $X$  is zero, a branch occurs to step 5. Every time that  $X$  reaches the value zero, the same situation may have occurred in all three columns. All wheel counters are, therefore, tested for the value zero.
  18. If all counters are zero, the spin is finished and exit occurs. If all counters are not zero, a delay is implemented, and a branch back to (4) occurs.

Back to step 7:

7. If the delay constant has reached the value zero, the next LED down in the column must be lit.
8. The LED pointer for the wheel whose number is in the wheel pointer is incremented.
9. The LED pointer is tested against the value 4. If 4 has not been reached, we proceed; otherwise, it is reset to the value 1. (LEDs are designated externally by positions 1, 2, and 3 from



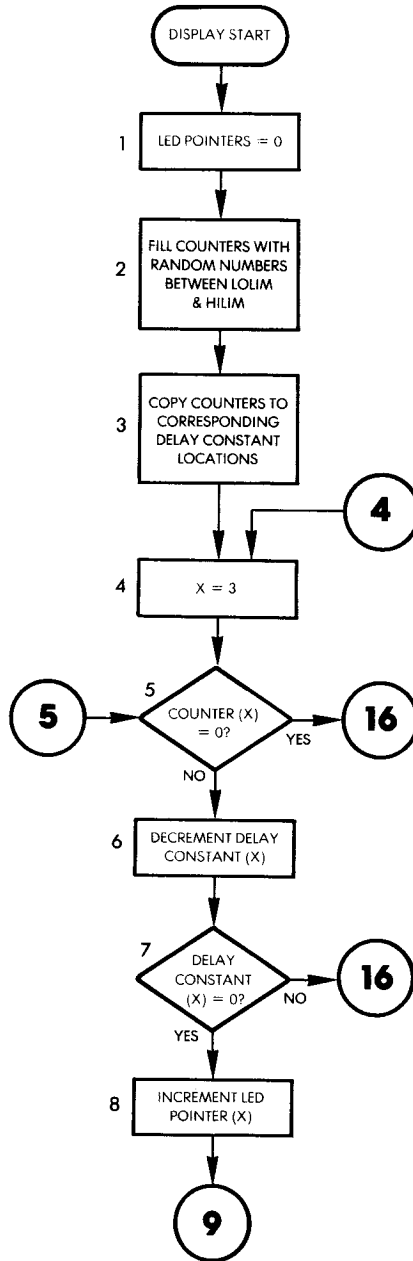


Fig. 7.4: DISPLAY Flowchart

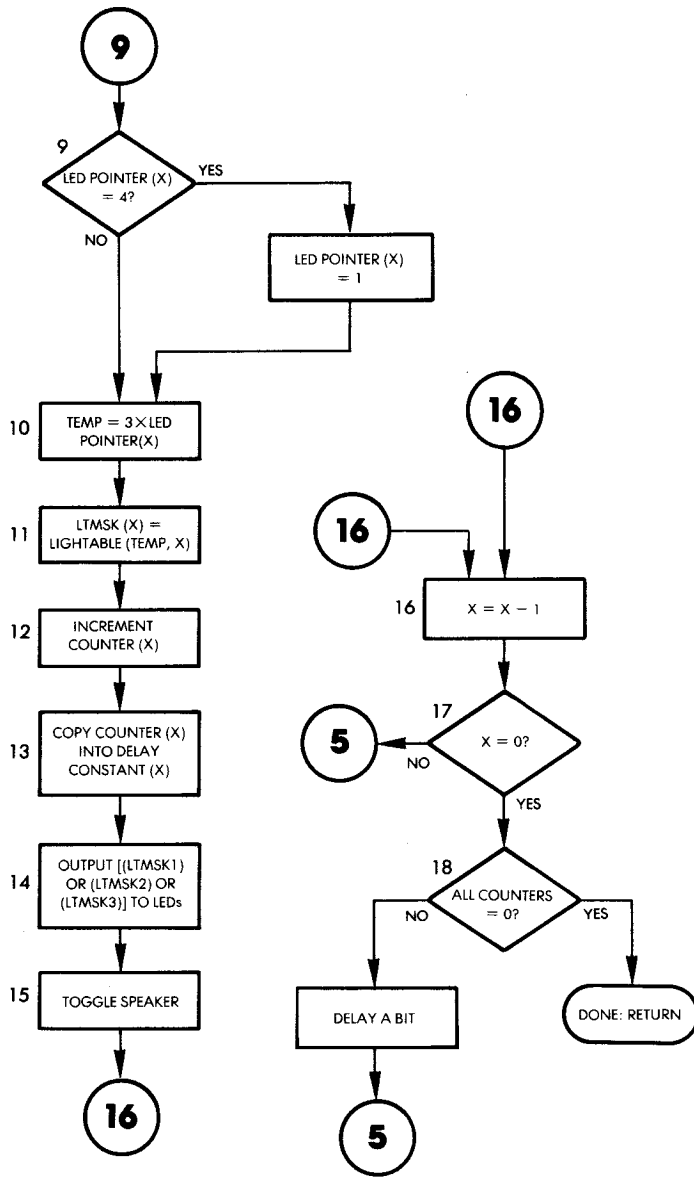


Fig. 7.4: DISPLAY Flowchart (Continued)

- top to bottom. The next LED to be lit after LED #3 is LED #1.)
- 10,11. The LED must be lit on the board, and a table LIGHTABLE is utilized to obtain the proper pattern.
  12. The counter for the appropriate wheel is incremented. Note that it is not tested against the value zero. This will occur only when the program moves to the left of wheel 1. This is done at location 18 in the flowchart, where the counters are tested for the value zero.
  13. The new value of the counter is copied into the delay constant location, resulting in an increased delay before the next LED actuation.
  14. The current lighting patterns of each column are combined and displayed.
  15. As each LED is lit in sequence, the speaker is toggled (actuated) .
  16. As usual, we move to the column on the left and proceed as before.

Let us go back to the test at step 5 in the flowchart:

5. Note that whenever the counter value for a column is zero, the LED in that column has stopped moving. No further action is required. This is accounted for in the flowchart by the arrow to the right of the decision box at 5: the branch occurs to 16 and the column pointer is decremented, resulting in no change for the column whose counter was zero.

Next, the evaluation algorithm must evaluate the results once all LEDs have stopped and then it must signal the results to the player. Let us examine it.

### **The Evaluation Process**

The flowchart for the EVAL algorithm is shown in Figure 7.5. The evaluation process is also illustrated in Figure 7.6, which shows the nine LEDs and the corresponding entities associated with them. Referring to Figure 7.6, X is a row-pointer and Y is a column- or wheel-pointer. A value counter is associated with each row. It contains the total number of LEDs lit in that row. This value counter will be converted into a score according to specific rules for each row. So far, we have only used row 2 and have defined a winning situation as being one in which two or three LEDs were lit in that row. However, many other combinations are possible and are allowed by this mechanism.

Exercises will be suggested later for other winning patterns.

The total for all of the scores in each row is added into a total called SCORE, shown at the bottom right-hand corner of Figure 7.6.

Let us now refer to the flowchart in Figure 7.5. The wheel- or column pointer Y is set initially to the right-most column:  $Y = 3$ .

2. The temporary counters are initialized to the value zero.
3. Within the current column (3), we need only look at the row which has a lit LED. This row is pointed to by LED-POINTER. The corresponding row value is stored in:  
 $X = \text{LED POINTER}(Y)$
4. Since an LED is lit in the row pointed to by X, the value counter for that row is incremented by one.

Assuming the LED situation of Figure 7.7, the second value counter has been set to the value 1.

5. The next column is examined:  $Y = Y - 1$ .

If Y is not 0, we go back to (3); otherwise the evaluation process may proceed to its next phase.

**Exercise 7-1:** *Using the flowchart of Figure 7.5, and using the example of Figure 7.7, show the resulting values contained in the value counters when we finally exit from the test at (6) in the flowchart of Figure 7.5.*

The actual number of LEDs lit in each row must now be transformed into a score. The SCORETABL is used for that purpose. If the scoring rules contained in this table are changed, they will completely modify the way the game is played.

The score table contains four byte-long numbers per row. Each number corresponds to the score to be earned by the player when 0, 1, 2, or 3 LEDs are lit in that row. The logical organization of the score table is shown in Figure 7.8. The entries in the table correspond to the score values which have been selected for the program presented at the beginning of this chapter. Any combination of LEDs in rows 1 or 3 scores 0. Any combination of 2 LEDs in row 2 scores 1, but, three LEDs score 3. Practically, this means that the score value of row 1 is obtained by merely using an indexed access technique with the number of LEDs lit as the index. For row 2, a displacement of four must be added for table access. In row 3, an additional displacement of four must be added. Mathematically, this translates to:

$$\text{SCORE} = \text{SCORETABL}[(X - 1) \times 4 + 1 + Y]$$

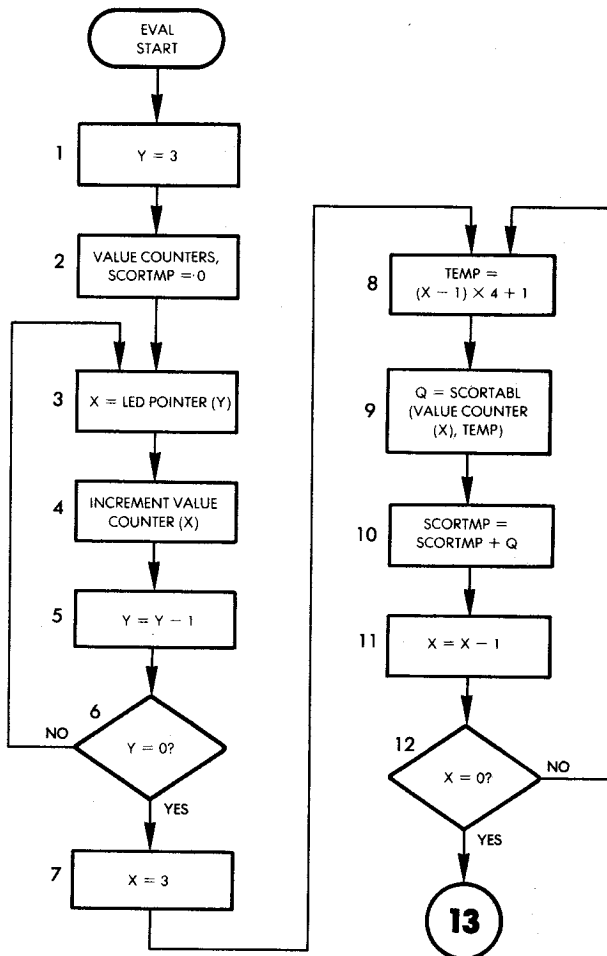


Fig. 7.5: EVAL Flowchart

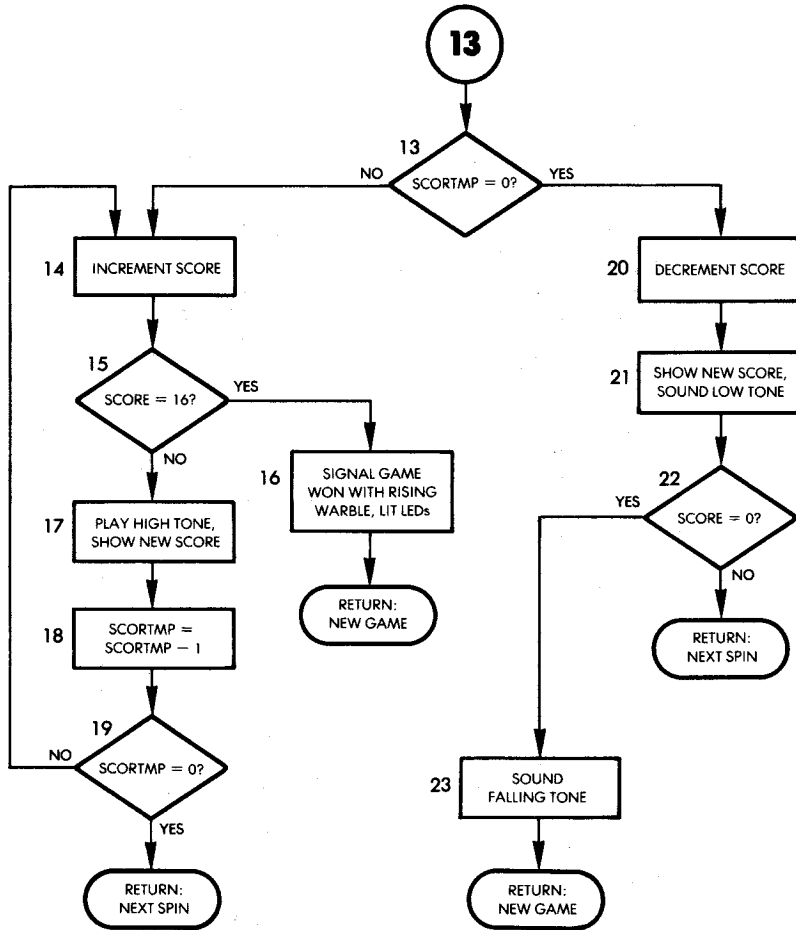
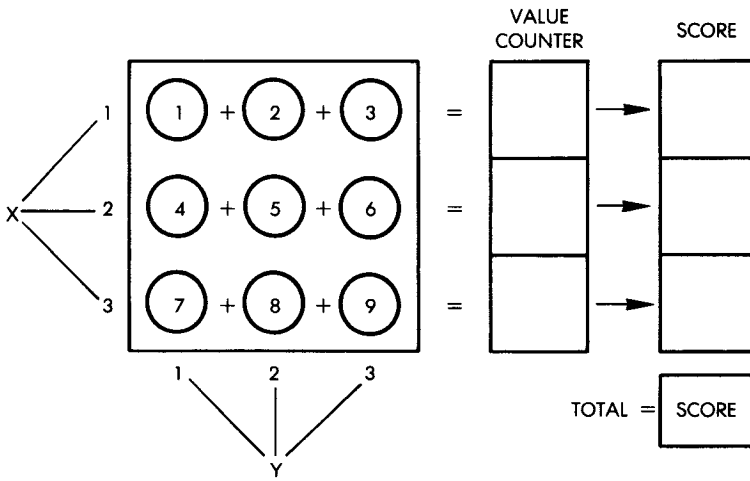
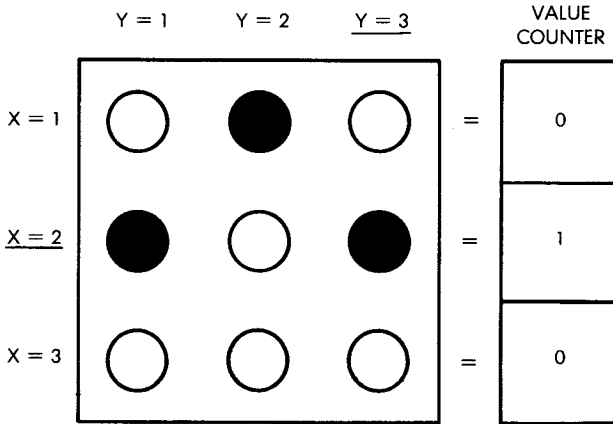


Fig. 7.5: EVAL Flowchart (Continued)



**Fig. 7.6: Evaluation Process on the Board**



**Fig. 7.7: An Evaluation Example**

where X is the row number and Y is the number of LEDs lit for that row. Since this technique allows each of the three rows to generate a score, the program must test the value counter in each row to obtain the total score.

This is accomplished by steps 7 and 8: the row pointer is initialized

0	1	2	3	NUMBER LEDs LIT
0	0	0	0	ROW 1
0	0	1	3	ROW 2
0	0	0	0	ROW 3

**Fig. 7.8: The Score Table**

to 3, and a score table displacement pointer is set up:

$$\text{TEMP} = (X - 1) \times 4 + 1$$

9. Next, the value of the score is obtained from the table:

$$Q = \text{SCORTABL}(\text{value counter } (X), \text{TEMP})$$

The value of that row's score is obtained by accessing the score table indexed by the number of LEDs lit, contained in the value counter for that row, plus a displacement equal to TEMP. The intermediate score is obtained by adding this partial score to any previous value:

10.  $\text{SCORTMP} = \text{SCORTMP} + Q$
11. Finally, the row number is decremented, and the process is repeated until X reaches the value 0.
12. Whenever X reaches the value 0, the score for this spin has been computed and stored in location SCORTMP.
13. At this point, the score computed above (SCORTMP) is examined by the program, and two possibilities exist: if the SCORTMP is 0, a branch occurs to 20, where the game score is decremented. If SCORTMP is not 0, the game score will be increased by the score for this spin — SCORTMP. Let us follow this path first.
14. The total game score is incremented by one.
15. It is then tested for the maximum value of 16.



## ADVANCED 6502 PROGRAMMING

16. If the maximum score of 16 is reached in step 15, a special audible and visual signal is generated to reward the player. A new game may be started.
17. If 16 is not reached in step 15, the updated game score is shown to the player, accompanied by a high-pitched tone.
18. The amount by which the game score must be increased, SCORTMP, is decremented.
19. If SCORTMP is not zero, more points must be added to the game score, and a branch occurs to 14. Otherwise, the player may enter the next spin.

Let us now follow the other path from position thirteen on the flowchart, where the total score had been tested:

20. The score for this spin is 0, so the game score is decremented.
21. It is displayed to the player along with a low tone.
22. The new score is tested for the minimum value 0. If this minimum value has been reached, the player has lost. Otherwise, the player may keep playing.
23. A descending siren-type tone is generated to indicate the loss, and the game ends.

## THE PROGRAM

### Data Structures

Two tables are used by this program: 1) the score table is used to compute a score from the number of LEDs lit in each row — this has already been described; 2) the LTABLE is used to generate the appropriate code on the I/O port to light the specified LED. Each entry within this table contains a pattern to be OR'ed into the I/O register to light the specified LED.

Vertically, in the memory, the table entries correspond to the first column, the second column, and then the third column of LEDs. Looking at the program on lines 39, 40, and 41, the rows of digits correspond respectively to the columns of LEDs. For example, the third entry in the table, i.e., 64 decimal, or 40 hexadecimal (at address 001C) corresponds to the third LED in the first column on the Games Board, or LED 7.

### Page Zero Variables

The following variables are stored in memory:  
— TEMP is a scratch location

# REAL TIME SIMULATION

```

LINE # LOC      CODE      LINE
0002 0000          #SLOT MACHINE SIMULATOR PROGRAM.
0003 0000          #PRESS ANY KEY TO START 'SPIN'.
0004 0000          #SCORE DETERMINED BY ARRAY 'SCORTB'.
0005 0000          #8 POINTS INITIAL SCORE, ONE POINT PENALTY
0006 0000          #FOR EACH BAD SPIN.
0007 0000          #
0008 0000          * = $0
0009 0000          TEMP **++1          #TEMPORARY STORAGE.
0010 0001          SCORTP **++1         #TEMPORARY SCORE STORAGE.
0011 0002          SCORE **++1        #SCORE.
0012 0003          DUR **++1         #DURATION OF TONES.
0013 0004          FREQ **++1        #FREQUENCY OF TONES.
0014 0005          SPEEDS **++3      #SPEEDS OF REVOLUTION FOR LEDES
0015 0008          #IN COLUMNS
0016 0008          INDX **++3       #DELAY COUNTERS FOR LED REVOLUTIONS.
0017 0008          INCR **++3       #POINTERS FOR LED POSITIONS.
0018 000E          #USED TO FETCH PATTERNS OUT OF TABLES.
0019 000E          LTHSK **++3       #PATTERNS FOR LIT LEDES
0020 0011          VALUES **++3      #NO. OF LIT LEDES IN EACH ROW.
0021 0014          RND **++6        #SCRATCHPAD FOR RND # GEN.
0022 001A          #
0023 001A          #I/O
0024 001A          #
0025 001A          PORT1A = $A001       #VIA#1 PORT A I/O REG (LEDES)
0026 001A          DDR1A = $A003       #VIA#1 PORT A DATA DIRECTION REG.
0027 001A          PORT1B = $A000       #VIA#1 PORT B I/O REG. (LEDES)
0028 001A          DDR1B = $A002       #VIA#1 PORT B DATA DIRECTION REG.
0029 001A          PORT3B = $AC00       #VIA#3 PORT B I/O REG. (SPKR)
0030 001A          DDR3B = $AC02       #VIA#3 PORT B DATA DIRECTION REG.
0031 001A          T1CL = $A004
0032 001A          #
0033 001A          #ARRAYS
0034 001A          #
0035 001A          #ARRAY OF PATTERNS TO LIGHT LEDES.
0036 001A          #ARRAY ROWS CORRESPOND TO COLUMNS OF LED
0037 001A          #ARRAY, AND COLUMNS TO ROWS. FOR EXAMPLE, THIRD
0038 001A          #BYTE IN ROW ONE WILL LIGHT LED 7.
0039 001A          LTABLE .BYTE 1,8,64
0039 001B          01
0039 001C          08
0040 001D          40
0040 001E          10
0040 001F          80
0041 0020          04
0041 0021          20
0041 0022          00
0042 0023          #ARRAY OF SCORES RECEIVED FOR CERTAIN
0043 0023          #PATTERNS OF LIT LEDES.
0044 0023          #ROWS CORRESPOND TO ROWS IN LED ARRAY.
0045 0023          #COLUMNS CORRESPOND TO NUMBER OF LEDES
0046 0023          #LIT IN THAT ROW.
0047 0023          #I.E., 3 LEDES IN MIDDLE ROW IS 3 PTS.
0048 0023          SCORTB .BYTE 0,0,0,0
0048 0024          00
0048 0025          00
0048 0026          00
0049 0027          00
0049 0028          00
0049 0029          01
0049 002A          03
0050 002B          00
0050 002C          00
0050 002D          00
0050 002E          00
0051 002F          #
0052 002F          #***** MAIN PROGRAM *****
0053 002F          #
0054 002F          GETKEY = $100
0055 002F          * = $200
0056 0200          LDA #$FF          #SET UP PORTS.

```

**Fig. 7.9: Slot Machine Program**

# ADVANCED 6502 PROGRAMMING

```

0057 0202 8D 03 A0          STA DDR1A
0058 0205 8D 02 A0          STA DDR1B
0059 0208 8D 02 AC          STA DDR3B
0060 020B AD 04 A0          LDA T1CL          ;GET SEED FOR RANDOM # GEN.
0061 020E 85 15            STA RND+1
0062 0210 A9 08            START LDA #8          ;INITIAL SCORE IS EIGHT.
0063 0212 85 02            STA SCORE
0064 0214 A8              TAY          ;SHOW INITIAL SCORE
0065 0215 20 3D 03        JSR LIGHT
0066 0218 20 00 01        KEY JSR GETKEY        ;ANY KEY PRESSED STARTS PROGRAM.
0067 021B 20 27 02        JSR DISPLY        ;SPIN WHEELS
0068 021E 20 A7 02        JSR EVAL          ;CHECK SCORE AND SHOW IT
0069 0221 A5 02            LDA SCORE
0070 0223 D0 F3            BNE KEY          ;IF SCORE <> 0, GET NEXT PLAY.
0071 0225 F0 E9            BEQ START        ;IF SCORE = 0, RESTART.
0072 0227                ;
0073 0227                ;SUBROUTINE TO DISPLAY 'SPINNING' LEDS,
0074 0227                ;FIND COMBINATION TO USED TO DETERMINE SCORE.
0075 0227                ;
0076 0227                ;
0077 0227                ;
0078 0227                ;
0079 0227 A9 00            DISPLY LDA #0          ;RESET POINTERS.
0080 0229 85 08            STA INCR
0081 022B 85 0C            STA INCR+1
0082 022D 85 0D            STA INCR+2
0083 022F A0 02            LDRND LDY #2          ;SET INDEX FOR 3 ITERATIONS.
0084 0231 20 80 03        GETRND JSR RANDOM        ;GET RANDOM #.
0085 0234 C9 87            CMP #HILIM        ;TOO LARGE?
0086 0236 B0 F9            BCS GETRND        ;IF SO, GET ANOTHER.
0087 0238 C9 5A            CMP #LOLIM        ;TOO SMALL?
0088 023A 90 F5            BCC GETRND        ;IF SO, GET ANOTHER.
0089 023C 99 08 00        STA INDX,Y        ;SAVE IN LOOP INDEXES AND
0090 023F 99 05 00        STA SPEEDS,Y     ;LOOP SPEED COUNTERS.
0091 0242 88              DEY
0092 0243 10 EC            BPL GETRND        ;GET NEXT RND #.
0093 0245 A2 02            UPDATE LDX #2      ;SET INDEX FOR THREE ITERATIONS.
0094 0247 B4 05            UPDTLP LDY SPEEDS,X    ;IS SPEED(X)=0?
0095 0249 F0 44            BEQ NXTUPD        ;IF SO, DO NEXT UPDATE.
0096 024B D6 08            DEC INDX,X        ;DECREMENT LOOP INDEX(X)
0097 024D D0 40            BNE NXTUPD        ;IF LOOPINDEX(X) < 0,
0098 024F                ;DO NEXT UPDATE.
0099 024F LDY INCR,X          ;INCREMENT POINTER(X).
0100 0251 C8              INY
0101 0252 C0 03            CPY #3            ;POINTER = 3?
0102 0254 D0 02            BNE NORST        ;IF NOT SKIP...
0103 0256 A0 00            LDY #0            ;...RESET OF POINTER TO 0.
0104 0258 94 08            NORST STY INCR,X    ;RESTORE POINTER(X).
0105 025A 86 00            STX TEMP         ;MULTIPLY X BY 3 FOR ARRAY ACCESS.
0106 025C 8A              TXA
0107 025D 0A              ASL A
0108 025E 18              CLC
0109 025F 65 00            ADC TEMP
0110 0261 75 0B            ADC INCR,X        ;ADD COLUMN# TO PTR(X) FOR ROW#.
0111 0263 A8              TAY
0112 0264 B9 1A 00        LDA LTABLE,Y      ;XFER TO Y FOR INDEXING.
0113 0267 95 0E            STA LTMSK,X      ;GET PATTERN FOR LED.
0114 0269 B4 05            SPDUPD LDY SPEEDS,X  ;STORE IN LIGHT MASK(X).
0115 026B C8              INY              ;INCREMENT SPEED(X).
0116 026C 94 05            STY SPEEDS,X    ;RESTORE.
0117 026E 94 08            STY INDX,X      ;RESET LOOP INDEX(X).
0118 0270 A9 00            LEDUPD LDA #0           ;UPDATE LIGHTS.
0119 0272 8D 00 A0        STA PORT1B        ;RESET LED #9
0120 0275 A5 10            LDA LTMSK+2      ;COMBINE PATTERNS FOR OUTPUT.
0121 0277 D0 07            BNE OFFLD9      ;IF MASK#3 < 0, LED 9 OFF.
0122 0279 A9 01            LDA #01          ;TURN ON LED 9.
0123 027B 8D 00 A0        STA PORT1B
0124 027E A9 00            LDA #0           ;RESET A SO PATTERN WON'T BE BAD.
0125 0280 05 0E            OFFLD9 ORA LTMSK   ;COMBINE REST OF PATTERNS.
0126 0282 05 0F            ORA LTMSK+1
0127 0284 8D 01 A0        STA PORT1A        ;SET LIGHTS.
0128 0287 AD 00 AC          LDA PORT3B        ;TOGGLE SPEAKER.

```

Fig. 7.9: Slot Machine Program (Continued)

```

0129 028A 49 FF      EOR **FF
0130 028C 8D 00 AC  STA PORT3B
0131 028F CA          NXTUPD  DEX          ;DECREMENT X FOR NEXT UPDATE.
0132 0290 10 B5      BPL UPITLP      ;IF X>=0, DO NEXT UPDATE.
0133 0292 A0 50      LDY #SFDPRM     ;DELAY A BIT TO SLOW
0134 0294 88          WAIT    DEY          ;FLASHING OF LEDES.
0135 0295 D0 FD      BNE WAIT
0136 0297 A5 05      LDA SPEEDS      ;CHECK IF ALL COLUMNS OF
0137 0299             ;LEDS STOPPED.
0138 0299 05 06      ORA SPEEDS+1
0139 029B 05 07      ORA SPEEDS+2
0140 029D D0 A6      BNE UPDATE     ;IF NOT, DO NEXT SEQUENCE
0141 029F             ;OF UPDATES.
0142 029F A9 FF      LDA **FF
0143 02A1 85 03      STA DUR        ;DELAY TO SHOW USER PATTERN.
0144 02A3 20 30 03   JSR DELAY
0145 02A6 60          RTS          ;ALL LEDES STOPPED, DONE.
0146 02A7             ;
0147 02A7             ;SUBROUTINE TO EVALUATE PRODUCT OF SPIN, AND
0148 02A7             ;DISPLAY SCORE W/ TONES FOR WIN, LOSE, WIN+ENDGAME,
0149 02A7             ;AND LOSE+ENDGAME.
0150 02A7             ;
0151 02A7             HITONE = #20
0152 02A7             LOTONE = #F0
0153 02A7 A9 00      EVAL    LDA #0          ;RESET VARIABLES.
0154 02A9 85 11      STA VALUES
0155 02AB 85 12      STA VALUES+1
0156 02AD 85 13      STA VALUES+2
0157 02AF 85 01      STA SCORTP
0158 02B1 A0 02      LDY #2          ;SET INDEX Y FOR 3 ITERATIONS
0159 02B3             ;TO COUNT # OF LEDES ON IN EACH ROW.
0160 02B3 B6 0B      CNTLP  LDX INCR,Y      ;CHECK POINTER(Y), ADDING
0161 02B5 F4 11      INC VALUES,X   ;UP # OF LEDES ON IN EACH ROW.
0162 02B7 88          DEY
0163 02B8 10 F9      BPL CNTLP      ;LOOP IF NOT DONE.
0164 02BA A2 02      LDX #2 SET INDEX X FOR 3 ITERATIONS.
0165 02BC             ;OF LOOP TO FIND SCORE.
0166 02BC 8A          SCORLP  TXA          ;MULTIPLY INDEX BY FOUR FOR ARRAY
0167 02BD             ;ROW ACCESS.
0168 02BD 0A          ASL A
0169 02BE 0A          ASL A
0170 02BF 18          CLC          ;ADD # OF LEDES ON IN ROW(X) TO...
0171 02C0 75 11      ADC VALUES,X   ;..ARRIVE AT COLUMN ADDRESS IN ARRAY.
0172 02C2 A8          TAY          ;USE AS INDEX
0173 02C3 B9 23 00   LDA SCORTB,Y   ;GET SCORE FOR THIS SPIN.
0174 02C6 18          CLC
0175 02C7 65 01      ADC SCORTP     ;ADD TO ANY PREVIOUS SCORES
0176 02C9             ;ACCUMULATED IN THIS LOOP.
0177 02C9 85 01      STA SCORTP     ;RESTORE
0178 02CB CA          DEX
0179 02CC 10 EE      BPL SCORLP     ;LOOP IF NOT DONE
0180 02CE A9 60      LDA **60 SET UP DURATIONS FOR TONES.
0181 02D0 85 03      STA DUR
0182 02D2 A5 01      LDA SCORTP     ;GET SCORE FOR THIS SPIN.
0183 02D4 F0 34      BEQ LOSE      ;IF SCORE IS 0, LOSE A POINT.
0184 02D6 E6 02      INC SCORE     ;RAISE OVERALL SCORE BY ONE.
0185 02D8 A4 02      LDY SCORE     ;GET SCORE
0186 02DA C0 10      CPY #16      ;WIN W/ 16 PTS?
0187 02DC F0 10      BEQ WINEND    ;YES : WIN+ENDGAME.
0188 02DE 20 3D 03   JSR LIGHT     ;SHOW SCORE.
0189 02E1 A9 20      LDA #HITONE   ;PLAY HIGH BEEP.
0190 02E3 20 64 03   JSR TONE
0191 02E6 20 30 03   JSR DELAY     ;SHORT DELAY.
0192 02E9 C6 01      DEC SCORTP     ;DECREMENT SCORE TO BE ADDED TO...
0193 02EB             ;OVERALL SCORE BY ONE.
0194 02EB D0 E9      BNE WIN       ;LOOP IF SCORE XFER NOT COMPLETE.
0195 02ED 60          RTS          ;DONE, RETURN TO MAIN PROGRAM.
0196 02EE A9 FF      WINEND  LDA **FF   ;TURN ALL LEDES ON TO SIGNAL WIN.
0197 02F0 8D 01 A0   STA PORT1A
0198 02F3 8D 00 A0   STA PORT1B
0199 02F6 85 00      STA TEMP      ;SET FREQ PARM FOR RISING WARBLE.
0200 02FB A9 00      LDA #0
0201 02FA 85 02      STA SCORE     ;CLEAR TO FLAG RESTART.

```

Fig. 7.9: Slot Machine Program (Continued)

# ADVANCED 6502 PROGRAMMING

```

0202 02FC A9 04          LDA #4
0203 02FE 85 03          STA DUR          ;SHORT DURATION FOR INDIVIDUAL
0204 0300                ;BEEPS IN WARBLE.
0205 0300 A5 00          RISE LDA TEMP          ;GET FREQUENCY....
0206 0302 20 64 03      JSR TONE          ;...FOR BEEP.
0207 0305 C6 00          DEC TEMP          ;NEXT BEEP WILL BE HIGHER.
0208 0307 D0 F7          BNE RISE          ;DO NEXT BEEP IF NOT DONE.
0209 0309 60            RTS            ;RETURN FOR RESTART.
0210 030A C6 02          LOSE DEC SCORE          ;IF SPIN BAD, SCORE=SCORE-1
0211 030C A4 02          LDY SCORE          ;SHOW SCORE
0212 030E 20 3D 03      JSR LIGHT
0213 0311 A9 F0          LDA #LOTONE          ;PLAY LOW LOSE TONE.
0214 0313 20 64 03      JSR TONE
0215 0316 A4 02          LDY SCORE          ;GET SCORE TO SEE ....
0216 0318 F0 01          BEQ LOSEND          ;IF GAME IS OVER.
0217 031A 60            RTS            ;IF NOT, RETURN FOR NEXT SPIN.
0218 031B A9 00          LOSEND LDA #0          ;SET TEMP FOR USE AS FREQ PARM
0219 031D 85 00          STA TEMP          ;IN FALLING WARBLE.
0220 031F 8D 01 A0      STA PORT1A          ;CLEAR LED #1.
0221 0322 A9 04          LDA #4
0222 0324 85 03          STA DUR
0223 0326 A5 00          FALL LDA TEMP
0224 0328 20 64 03      JSR TONE          ;PLAY BEEP.
0225 032B E6 00          INC TEMP          ;NEXT TONE WILL BE LOWER.
0226 032D D0 F7          BNE FALL
0227 032F 60            RTS            ;RETURN FOR RESTART.
0228 0330                ;
0229 0330                ;VARIABLE LENGTH DELAY SUBROUTINE.
0230 0330                ;DELAY LENGTH = (2046*(CONTENTS OF DUR)+10) US.
0231 0330                ;
0232 0330 A4 03          DELAY LDY DUR          ;GET DELAY LENGTH.
0233 0332 A2 FF          DL1 LDX #$FF          ;SET CNTR FOR INNER 2040 US. LOOP
0234 0334 D0 00          DL2 BNE #+2          ;WASTE TIME.
0235 0336 CA            DEX            ;DECREMENT INNER LOOP CNTR.
0236 0337 D0 FB          BNE DL2          ;LOOP 'TILL INNER LOOP DONE.
0237 0339 88            DEY            ;DECREMENT OUTER LOOP CNTR.
0238 033A D0 F6          BNE DL1          ;LOOP 'TILL DONE.
0239 033C 60            RTS            ;RETURN.
0240 033D                ;
0241 033D                ;SUBROUTINE TO LIGHT LED CORRESPONDING
0242 033D                ;TO THE CONTENTS OF REGISTER Y ON ENTERING.
0243 033D                ;
0244 033D A9 00          LIGHT LDA #0          ;CLEAR REG. A FOR BIT SHIFT.
0245 033F 85 00          STA TEMP          ;CLEAR OVERFLOW FLAG.
0246 0341 8D 01 A0      STA PORT1A          ;CLEAR LOW LEDS.
0247 0344 8D 00 A0      STA PORT1B          ;CLEAR HIGH LEDS.
0248 0347 C0 0F          CPY #15          ;CODE FOR UNCONNECTED BIT?
0249 0349 F0 01          BEQ #+3          ;IF SO, NO CHNG.
0250 034B 88            DEY            ;DECREMENT TO MATCH.
0251 034C 38            SEC            ;SET BIT TO BE SHIFTED HIGH.
0252 034D 2A            LTSHFT ROL A          ;SHIFT BIT LEFT.
0253 034E 90 05          BCC LTCC          ;IF CARRY SET, OVERFLOW HAS
0254 0350                ;OCCURRED INTO HIGH BYTE.
0255 0350 A2 FF          LDX #$FF          ;SET OVERFLOW FLAG.
0256 0352 84 00          STX TEMP
0257 0354 2A            ROL A            ;MOVE BIT OUT OF CARRY.
0258 0355 88            DEY            ;ONE LESS BIT TO BE SHIFTED.
0259 0356 10 F5          BPL LTSHFT          ;SHIFT AGAIN IF NOT DONE.
0260 0358 A6 00          LDX TEMP          ;GET OVERFLOW FLAG.
0261 035A D0 04          BNE HIBYTE          ;IF FLAG<>0, OVERFLOW: A CONTAINS
0262 035C                ;HIGH BYTE.
0263 035C 8D 01 A0      LOBYTE STA PORT1A          ;STORE A IN LOW ORDER LEDS.
0264 035F 60            RTS            ;RETURN.
0265 0360 8D 00 A0      HIBYTE STA PORT1B          ;STORE A IN HIGH ORDER LEDS.
0266 0363 60            RTS            ;RETURN.
0267 0364                ;
0268 0364                ;TONE GENERATION SUBROUTINE.
0269 0364                ;
0270 0364 85 04          TONE STA FREQ
0271 0366 A9 FF          LDA #$FF
0272 0368 8D 00 AC      STA PORT3B
0273 036B A9 00          LDA #00

```

Fig. 7.9: Slot Machine Program (Continued)

```

0274 036D A6 03          LDX DUR
0275 036F A4 04          FL2 LDY FREQ
0276 0371 88            FL1 DEY
0277 0372 18            CLC
0278 0373 90 00          BCC #+2
0279 0375 D0 FA          BNE FL1
0280 0377 49 FF          EOR #$FF
0281 0379 8D 00 AC       STA PORT3B
0282 037C CA            DEX
0283 037D D0 F0          BNE FL2
0284 037F 60            RTS
0285 0380                ;
0286 0380                ;RANDOM NUMBER GENERATOR SUBROUTINE.
0287 0380                ;
0288 0380 38            RANDOM SEC
0289 0381 A5 15          LDA RND+1
0290 0383 65 18          ADC RND+4
0291 0385 65 19          ADC RND+5
0292 0387 85 14          STA RND
0293 0389 A2 04          LDX #4
0294 038B 85 14          RNDSH LDA RND,X
0295 038D 95 15          STA RND+1,X
0296 038F CA            DEX
0297 0390 10 F9          BPL RNDSH
0298 0392 60            RTS
0299 0393                .END

SYMBOL TABLE

SYMBOL  VALUE

CNTLP  02B3  DDR1A  A003  DDR1B  A002  DDR3B  AC02
DELAY  0330  DISPLY  0227  DL1     0332  DL2     0334
DUR    0003  EVAL    02A7  FALL    0326  FL1     0371
FL2    036F  FREQ    0004  GETKEY  0100  GETRND  0231
HIBYTE 0360  HILIM   00B7  HITONE  0020  INCR    000B
INDX   000B  KEY     0218  LDRND   022F  LEDUPD  0270
LIGHT  033D  LOBYTE  035C  LOLIM   005A  LOSE    030A
LOSEND 031B  LOTONE  00F0  LTABLE  001A  LTCC    0355
LTMSK  000E  LTSHFT  034D  NORST   0258  NXTUPD  028F
OFFLD9 0280  PORT1A  A001  PORT1B  A000  PORT3B  AC00
RANDOM  0380  RISE    0300  RND     0014  RNDSH   038B
SCORE  0002  SCORLP  02BC  SCORTB  0023  SCORTP  0001
SPDPRM 0050  SPDUPD  0269  SPEEDS  0005  START   0210
TICL   A004  TEMP    0000  TONE    0364  UPDATE  0245
UPDTLP 0247  VALUES 0011  WAIT    0294  WIN     02D6
WINEND 02EE

END OF ASSEMBLY

```

Fig. 7.9: Slot Machine Program (Continued)

- SCORTP is used as a temporary storage for the score gained or lost on each spin
- SCORE is the game score
- DUR and FREQ specify the usual constants for tone generation
- SPEEDS (3 locations) specify the revolution speeds for the three columns
- INDX (3 locations): delay counters for LED revolutions
- INCR (3 locations): pointers to the LED positions in each column used to fetch patterns out of tables
- LTMSK (3 locations): patterns indicating lit LEDs
- VALUES (3 locations): number of LEDs lit in each column
- RND (6 locations): scratch-pad for random number generator.

### Program Implementation

The program consists of a main program and two main subroutines: DISPLY and EVAL. It also contains some utility subroutines: DELAY for a variable length delay, LIGHT to light the appropriate LED, TONE to generate a tone, and RANDOM to generate a random number.

The main program is stored at memory locations 200 and up. As usual, the three data-direction registers for Ports A and B of VIA#1 and for Port B of VIA#3 must be conditioned as outputs:

```
LDA #$FF
STA DDR1A
STA DDR1B
STA DDR3B
```

As in previous chapters, the counter register of timer 1 is used to provide an initial random number (a seed for the random number generator). This seed is stored at memory location RND + 1, where it will be used later by the random number generation subroutine:

```
LDA T1CL
STA RND + 1
```

On starting a new game, the initial score is set to 8. It is established:

```
START    LDA #8
          STA SCORE
```

and displayed:

```
TAY          Y must contain it
JSR LIGHT
```

The LIGHT subroutine is used to display the score by lighting up the LED corresponding to the contents of register Y. It will be described later.

The slot machine program is now ready to respond to the player. Any key may be pressed:

```
KEY      JSR GETKEY
```

As soon as a key has been pressed, the wheels must be spun:

JSR DISPLY

Once the wheels have stopped, the score must be evaluated and displayed with the accompanying sound:

JSR EVAL

If the final score is not "0," the process is restarted:

LDA SCORE  
BNE KEY

and the user may spin the wheels again. Otherwise, if the score was "0," a new game is started:

BEQ START

This completes the body of the main program. It is quite simple because it has been structured with subroutines.

### **The Subroutines**

The algorithms corresponding to the two main subroutines DISPLY and EVAL have been described in the previous section. Let us now consider their program implementation.

#### ***DISPLY Subroutine***

Three essential subroutine parameters are LOLIM, HILIM, and SPDPRM. For example, lowering LOLIM will result in a longer spinning time for the LEDs. Various other effects can be obtained by varying these three parameters. One might be to include a win almost every time! Here LOLIM = 90, HILIM = 134, SPDPRM = 80.

Memory location INCR is used as a pointer to the current LED position. It will be used later to fetch the appropriate bit pattern from the table, and may have the value 0, 1, or 2 (pointing to LED positions 1, 2, or 3). The three pointers for the LEDs in each column are stored respectively at memory locations INCR, INCR + 1, and INCR + 2. They are initialized to 0:



## ADVANCED 6502 PROGRAMMING

```
DISPLY      LDA #0
            STA INCR
            STA INCR + 1
            STA INCR + 2
```

Note that in the previous examples (such as Figure 7.7), in order to simplify the explanations, we have used pointers X and Y to represent the values between 1 and 3. Here, X and Y will have values ranging between 0 and 2 to facilitate indexing. The wheel pointer is set to the right-most wheel:

```
LDRND      LDY #2
```

An initial random number is obtained with the RANDOM subroutine:

```
GETRND     JSR RANDOM
```

The number returned by the subroutine is compared with the acceptable low limit and the acceptable high limit. If it does not fit within the specified interval, it is rejected, and a new number is obtained until one is found which fits the required interval.

```
            CMP #HILIM      Too large?
            BCS GETRND      If so, get another
            CMP #LOLIM      Too small?
            BCC GETRND      If so, get another
```

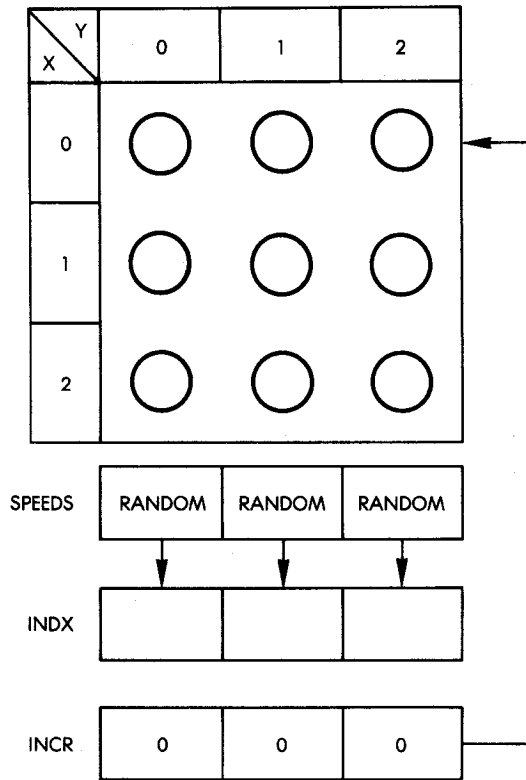
The valid random number is then stored in the index location INDX and in the SPEEDS location for the current column. (See Figure 7.10.)

```
            STA INDX,Y
            STA SPEEDS,Y
```

The same process is carried out for column 1 and column 0:

```
            DEY
            BPL GETRND      Get next random #
```

Once all three columns have obtained their index and speed, a new iteration loop is started, using register X as a wheel counter:



**Fig. 7.10: Spinning the Wheels**

UPDATE    LDX #2            Set counter for 3 iterations

The speed is tested for the value 0:

UPDTLP    LDY SPEEDS,X    Is speed (X) = 0?  
           BEQ NXTUPD    If so, update next column

As long as the speed is not 0, the next LED in that column will have to be lit. The delay count is decremented:

DEC INDX,X            Decrement loop, index (X)

## ADVANCED 6502 PROGRAMMING

If the delay has not decremented to 0, a branch occurs to NXTUPD which will be described below. Otherwise, if the delay counter INDX is decremented to 0, the next LED should be lit. The LED pointer is incremented with a possible wrap-around if it reaches the value 3:

	BNE NXTUPD	If loop index(X) $\neq$ 0, do next update
	LDY INCR,X	Inc pointer
	INY	
	CPY #3	Pointer = 3?
	BNE NORST	If not, skip
	LDY #0	Reset to 0
NORST	STY INCR,X	Restore pointer(X)

The new value of the LED pointer is stored back into INCR for the appropriate column. (Remember that within the UPDATE routine, X points at the column.) In order to light the appropriate LED, a bit pattern must be obtained from LTABLE. Note that LTABLE (and also SCORTB) is treated conceptually, as if it was a two-dimensional array, i.e., having rows and columns. However, both LTABLE and SCORTB appear in memory as a contiguous series of numbers. Thus, in order to obtain the address of a particular element, the row number must be multiplied by the number of columns and then added to the column number.

The table will be accessed using the indexed addressing mode, with register Y used as the index register. In order to access the table, X must first be multiplied by 3, then the value of INCR (i.e., the LED pointer) must be added to it.

Multiplication by 3 is accomplished through a left shift followed by an addition, since a left shift is equivalent to multiplication by 2:

	STX TEMP	Multiply X by 3
	TXA	
	ASL A	Left shift
	CLC	
	ADC TEMP	Plus one

The value of INCR is added, and the total is transferred into register Y so that indexed addressing may be used. Finally, the entry may be retrieved from LTABLE:

```

ADC INCR,X
TAY
LDA LTABLE,Y    Get pattern for LED

```

Once the pattern has been obtained, it is stored in one of three memory locations at address LTMSK and following. The pattern is stored at the memory location corresponding to the column currently being updated, where the LED has "moved." The lights will be turned on only after the complete pattern for all three columns has been implemented. As a result of the LED having moved one position within that column, the speed constant must be incremented:

```

STA LTMSK,X
SPDUPD    LDY SPEEDS,X
          INY
          STY SPEEDS,X

```

The index is set so that it is equal to the new speed:

```

STY INDX,X

```

Note that special handling will now be necessary for LED #9. The pattern to be displayed on the first eight LEDs was stored in the LTABLE. The fact that LED #9 must be lit is easily recognized by the fact that the pattern for column #3 shows all zeroes; since one LED must be lit at all times within that column, it implies that LED #9 will be lit:

```

LEDUPD    LDA #0
          STA PORT1B    Reset LED 9

```

Next, the pattern for the third column is obtained from the location where it had been saved at LTMSK + 2. It is tested for the value of 0:

```

LDA LTMSK + 2
BNE OFFLD9

```

If this pattern is 0, then LED #9 must be turned on:

```

LDA #01

```

STA PORT1B

Otherwise, a branch occurs to location OFFLD9, and the remaining LEDs will be turned on. The pattern contained in the accumulator which was obtained from LTMSK + 2, is successively OR'ed with the patterns for the second and first columns:

```

                                LDA #0
OFFLD9                          ORA LTMSK
                                ORA LTMSK + 1
    
```

At this point, A contains the final pattern which must be sent out in the output port to turn on the required LED pattern. This is exactly what happens:

STA PORT1A

At the same time, the speaker is toggled:

```

                                LDA PORT3B
                                EOR #$FF
                                STA PORT3B
    
```

It is important to understand that even though only the LED for one of the three columns has been moved, it is necessary to simultaneously turn on LEDs in all of the columns or the first and second columns would go blank!

Once the third column has been taken care of, the next one must be examined. The column pointer X is therefore decremented, and the process is continued:

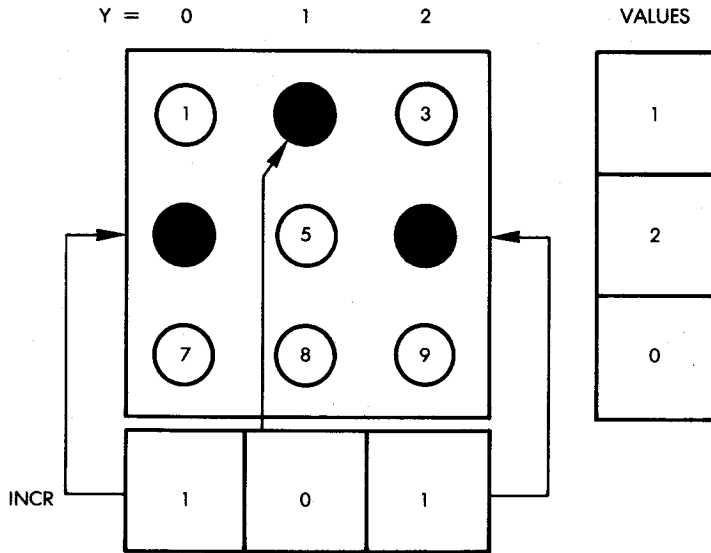
```

NDTUPD                          DEX
                                BPL UPDTLP      If X >= 0 do next update
    
```

Once the second and the first columns have been handled, a delay is implemented to avoid flashing the LEDs too fast. This delay is controlled by the speed parameter SPDPRM:

```

                                LDY #SPDPRM
WAIT                              DEY
                                BNE WAIT
    
```



**Fig. 7.11: Evaluating the End of A Spin**

Once this complete cycle has been executed, the speed location for each column is checked for the value 0. If all columns are 0, the spin is finished:

```
LDA SPEEDS
ORA SPEEDS + 1
ORA SPEEDS + 2
BNE UPDATE
```

Otherwise, a branch occurs at the location UPDATE. If all LEDs have stopped, a pause must be generated so that the user may see the pattern:

```
LDA #$FF
STA DUR
JSR DELAY
```

and exit occurs:

```
RTS
```

**Exercise 7-2:** *Note that the contents of the three SPEEDS locations have been OR'ed to test for three zeroes. Would it have been equivalent to add them together?*

***EVAL Subroutine***

This subroutine is the user output interface. It computes the score achieved by the player and generates the visual and audio effects. The constants for frequencies for the high tone generated by a win situation and the low tone generated by a lose situation are specified at the beginning of this subroutine:

```
HITONE = $20
LOTONE = $F0
```

The method used to compute the number of LEDs lit per row has been discussed and shown in Figure 7.7. The number of LEDs lit for each row is initially reset to 0:

```
EVAL      LDA #0
          STA VALUES
          STA VALUES + 1
          STA VALUES + 2
```

The temporary score is also set to 0:

```
STA SCORTP
```

Index register Y will be used as a column pointer, and the number of LEDs lit in each row will be computed. The number of the LED lit for the current column is obtained by reading the appropriate INCR entry. See the example in Figure 7.11. The value contained in each of the three locations reserved for INCR is a row number. This row number is stored in register X, and is used as an index to increment the appropriate value in the VALUES table. Notice how this is accomplished in just two instructions, by cleverly using the indexed addressing feature of the 6502 twice:

```
· CNTLP   LDY #2           3 iterations
          LDX INCR,Y
          INC VALUES,X
```

Once this is done for column 2, the process is repeated for columns 1 and 0:

```
DEY
BPL CNTLP
```

Now, another iteration will be performed to convert the final numbers entered in the VALUES table into the actual scores as per the specifications of the score table, SCORTB. Index register X is used as a row-pointer for VALUES and SCORTB.

```
LDX #2
```

Since the SCORTB table has four one-byte entries per row level, in order to access the correct byte within the table the row number must first be multiplied by 4, then the corresponding "value" (number of LEDs lit) for that row must be added to it. This provides the correct displacement. The multiplication by 4 is implemented by two successive left shifts:

```
SCORLP    TXA
          ASL A
          ASL A
```

The number presently contained in the accumulator is equal to 4 times the value contained in X, i.e., 4 times the value of the row-pointer. To obtain the final offset within the SCORTB table, we must add to that the number of LEDs lit for that row, i.e., the number contained in the VALUES tables. This number is retrieved, as usual, by performing an indexed addressing operation:

```
CLC
ADC VALUES,X    Column address in array
```

This results in the correct final offset for accessing SCORTB.

The indexed access of the SCORTB table can now be performed. Index register Y is used for that purpose, and the contents of the accumulator are transferred to it:

```
TAY
```



## ADVANCED 6502 PROGRAMMING

The access is performed:

```
LDA SCORTB,Y    Get score for this spin
```

The correct score for the number of LEDs lit within the row pointed to by index register X is now contained in the accumulator. The partial score obtained for the current row is added to the running total for all rows:

```
CLC
ADC SCORTP      Total the scores
STA SCORTP      Save
```

The row number is then decremented so that the next row can be examined. If X decrements from the value 0, i.e., becomes negative, we are done; otherwise, we loop:

```
DEX
BPL SCORLP
```

At this point, a total score has been obtained for the current spin. Either a win or a lose must be signaled to the player, both visually and audibly. In anticipation of activating the speaker, the memory location DUR is set to the correct tone duration:

```
LDA #$60
STA DUR
```

The score is then examined: if 0, a branch occurs to the LOSE routine:

```
LDA SCORTP
BEQ LOSE
```

Otherwise, it is a win. Let us examine these two routines.

### *WIN Routine*

The final score for the user (for all spins so far) is contained in memory location SCORE. This memory location will be incremented one point at a time and checked every time against the maximum value 16. Let us do it:

```

WIN          INC SCORE
             LDY SCORE
             CPY #16

```

If the maximum value of 16 has been reached, it is the end of the game and a branch occurs to location WINEND:

```

             BEQ WINEND

```

Otherwise, the score display must be updated and a beep must be sounded:

```

             JSR LIGHT

```

The LIGHT routine will be described below. It displays the score to the player. Next, a beep must be sounded.

```

             LDA #HITONE
             JSR TONE

```

The TONE routine will be described later.

A delay is then implemented:

```

             JSR DELAY

```

then the score for that spin is decremented:

```

             DEC SCORTP

```

and checked against the value 0. If it is 0, the scoring operation is complete; otherwise, the loop is reentered:

```

             BNE WIN
             RTS

```

#### *WINEND Routine*

This routine is entered whenever a total score of 16 has been reached. It is the end of the game. All LEDs are turned on simultaneously, and a siren sound with rising frequencies is activated. Finally, a restart of the game occurs.

## ADVANCED 6502 PROGRAMMING

All LEDs are turned on by loading the appropriate pattern into Port 1A and Port 1B:

```
LDA #$FF
STA PORT1A    Turn on all LEDs
STA PORT1B
```

Variables are reinitialized: the total score becomes 0, which signals to the main program that a new game must be started, the DUR memory location is set to 4 to control the duration of time for which the beeps will be sounded, and the frequency parameter is set to "FF" at location TEMP:

```
STA TEMP      Freq. parameter
LDA #0
STA SCORE     Clear for restart
LDA #4
STA DUR       Beep duration
```

The TONE subroutine is used to generate a beep:

```
RISE          LDA TEMP      Get frequency
              JSR TONE      Generate beep
```

The beep frequency constant is then decremented, and the next beep is sounded at a slightly higher pitch:

```
DEC TEMP
BNE RISE
```

Whenever the frequency constant has been decremented to 0, the siren is complete and the routine exits:

```
RTS
```

### *LOSE Routine*

Now let us examine what happens in the case of a lose situation. The events are essentially symmetrical to those that have been described for the win.

In the case of a loss, the score needs to be updated only once. It is decremented by 1:

LOSE            DEC SCORE

The lowered score is displayed to the user:

LDY SCORE  
JSR LIGHT

An audible tone is generated:

LDA #LOTONE  
JSR TONE

The final value of the score is checked to see whether a "0" score has been reached. If so, the game is over; otherwise, the next spin is started:

LDY SCORE  
BEQ LOSEND  
RTS

Let us look at what happens when a "0" score is reached (LOSEND). A siren of decreasing frequencies will be generated. All LEDs will go blank on the board:

LOSEND        LDA #0  
              STA TEMP  
              STA PORT1A        Clear LED #1

The beep duration for each frequency is set to a value of 4, stored at memory location DUR:

LDA #4  
STA DUR

The beep for the correct frequency is then generated:

FALL            LDA TEMP  
                  JSR TONE            Play beep

Next, the frequency constant is increased by 1, and the process is restarted until the TMP register overflows.

```

INC TEMP           Next tone will be lower
BNE FALL
RTS
    
```

This completes our description of the main program. Let us now examine the four subroutines that are used. They are: DELAY, LIGHT, TONE, and RANDOM.

***DELAY Subroutine***

This subroutine implements a delay; the duration of the delay is set by the contents of memory location DUR. The resulting delay length will be equal to  $(2046 \times \text{DUR} + 10)$  microseconds. The delay is implemented using a traditional two-level, nested loop structure. The inner-loop delay is controlled by index register X, while the outer-loop delay is controlled by index register Y, which is initialized from the contents of memory location DUR. Y is therefore initialized:

```

DELAY           LDY DUR
    
```

The inner loop delay is then implemented:

```

DL1           LDX #$FF
DL2           BNE * + 2           Waste time
              DEX                Inner loop counter
              BNE DL2           Inner loop
    
```

And, finally, the outer loop is implemented:

```

              DEY
              BNE DL1
              RTS
    
```

**Exercise 7-3:** *Verify the exact duration of the delay implemented by the DELAY subroutine.*

***LIGHT Subroutine***

This subroutine lights the LED corresponding to the number contained in register Y. Remember that the fifteen LEDs on the Games

Board are numbered externally from 1 to 15 but are connected to bits 0 to 7 of Port 1A and 0 to 7 of Port 1B. Thus, if a score of 1 must be displayed, bit 0 of Port 1A must be turned on. Generally, bit N of Port 1A must be turned on when N is equal to the score minus one. However, there is one exception. To see this, refer to Figure 1.4 showing the LED connections. Notice that bit 6 of Port 1B is not connected to any LEDs. Whenever a score of fifteen must be displayed, bit 7 of Port 1B must be turned on. This exception will be handled in the routine by simply not decrementing the score when it adds up to fifteen.

The correct pattern for lighting the appropriate LED will be created by shifting a "1" into the accumulator at the correct position. Other methods will be suggested in the exercise below. Let us first initialize:

```
LIGHT      LDA #0
           STA TEMP
           STA PORT1A
           STA PORT1B
```

We must first look at the situation where the score contained in Y is 15 and where we do nothing (no shift):

```
CPY #15           Code for uncorrected bit?
BEQ * + 3        If so, no change
```

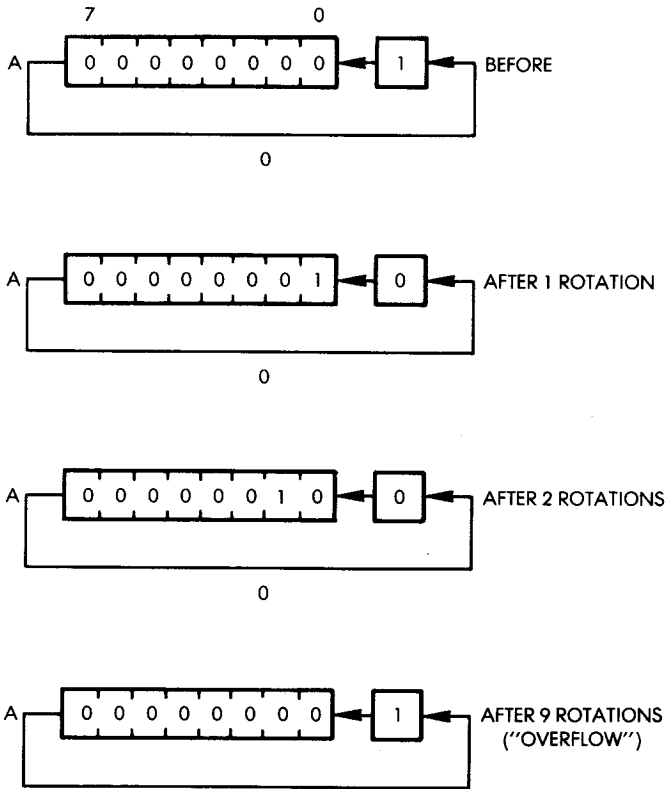
For any other score, it is first decremented, then the shift is performed:

```
           DEY           Decrement to internal code
           SEC           Set bit to be shifted
LTSHFT    ROL A
```

The contents of the accumulator were zeroed in the first instruction of this subroutine. The carry is set to the value 1, then shifted into the right-most position of A. (See Figure 7.12.) This process will be repeated as many times as necessary. Since we must count from 1 to 14, or 0 to 13, an overflow will occur whenever the "1" that is rotated in the accumulator "falls off" the left end. As long as this does not happen, the shifting process continues, and a branch to location LTCC is implemented:

```
BCC LTCC
```

## ADVANCED 6502 PROGRAMMING



**Fig. 7.12: Creating the LED Pattern**

However, if the "1" bit does fall off the left end of the accumulator, the value "FF" is loaded at memory location TEMP to signal this occurrence. Remember that the value was cleared in the second instruction of the LIGHT subroutine.

```
LDX #$FF
STX TEMP
```

The "1" bit is then moved from the carry into the right-most position of the accumulator. Later, the value contained in memory location TEMP will be checked, and this will determine whether the pattern contained in the accumulator is to be sent to Port 1A or to Port 1B.

The shifting process continues. The counter is decremented, and, if it reaches the value "0," we are done; otherwise, the process is repeated:

```

                                ROL A
LTCC                            DEY
                                BPL LTSHFT
    
```

Once the process is completed, the value of memory location TEMP is examined. If this value is "0," it indicates that no overflow has occurred and Port 1A must be used. If this value is not "0," i.e., it is "FF," then Port 1B must be used:

```

                                LDX TEMP           Get overflow flag
                                BNE HIBYTE
LOBYTE                           STA PORT1A       A sent to low LEDs
                                RTS               Return
HIBYTE                           STA PORT1B       A sent to high LEDs
                                RTS
    
```

***TONE Subroutine***

This subroutine generates a beep. The frequency of the beep is determined by the contents of the accumulator on entry; the duration of the beep is set by the contents of the memory location DUR. This has already been described in Chapter 2.

***RANDOM Subroutine***

This is a simple random number generator. The subroutine has already been described in Chapter 3.

***Exercise 7-4:*** *Suggest another way to generate the correct LED pattern in the accumulator, without using a sequence of rotations.*

**Game Variations**

The three rows of LEDs supplied on the Games Board may be interpreted in a way that is different from the one used at the beginning of this chapter. Row 1 could be interpreted as, say, cherries. Row 2 could be interpreted as stars, and row 3 could be interpreted as oranges. Thus, an LED lit in row 1 at the end of a spin shows a cherry, while



two LEDs in row 3 show two oranges. The resulting combination is one cherry and two oranges. The scoring table used in this program can be altered to score a different number of points for each combination, depending upon the number of cherries, oranges, or stars present at the end of the spin. It becomes simply a matter of modifying the values entered into the scoring table. When new values are entered into the scoring table a completely different scoring result will be implemented. No other alterations to the program will be needed.

### **SUMMARY**

This program, although simple in appearance, is relatively complex and can lead to many different games, depending upon the evaluation formula used once the lights stop. For clarity, it has been organized into separate routines that can be studied individually.

## **8. Real Time Strategies (Echo)**

### **INTRODUCTION**

A stack technique is used to accumulate information. It is compared to the use of scratch locations.

### **THE RULES**

The object of this game is to recognize and duplicate a sequence of lights and sounds which are generated by the computer. Several variations of this game, such as "Simon" and "Follow Me" (manufacturer trademarks\*), are sold by toy manufacturers. In this version, the player must specify, before starting the game, the length of the sequence to be recognized. The player indicates his or her length preference by pressing the appropriate key between 1 and 9. At this point the computer generates a random sequence of the desired length. It may then be heard and seen by pressing any of the alphabetic keys (A through F).

When one of the alphabetic keys is pressed, the sequence generated by the program is displayed on the corresponding LEDs (labeled 1 through 9) on the Games Board, while it is simultaneously played through the loudspeaker as a sequence of notes. While this is happening, the player should pay close attention to the sounds and/or lights, and then enter the sequence of numbers corresponding to the sequence he or she has identified. Every time that the player presses a correct key, the corresponding LED on the Games Board lights up, indicating a success. Every time a mistake is made, a low-pitched tone is heard.

At the end of the game, if the player has guessed successfully, all LEDs on the board will light up and a rising scale (succession of notes) is played. If the player has failed to guess correctly, a single LED will light up on the Games Board indicating the number of errors made, and a descending scale will be played.

If the player guessed the series correctly, the game will be restarted. Otherwise, the number of errors will be cleared and the player will be given another chance to guess the series.

---

\*"Follow Me" is a trademark of Atari, Inc., "Simon" is a trademark of Milton Bradley Co.

At any time during a game, the player may press one of the alphabetic keys that will allow him or her to hear the sequence again. All previous guesses are then erased, and the player starts guessing again from the beginning.

Two LEDs on the bottom row of the LED matrix are used to communicate with the player:

LED 10 (the left-most LED) indicates “computer ready — enter the length of the sequence desired.”

LED 11 lights up immediately after the player has specified the length of the sequence. It will remain lit throughout the game and it means that you should “enter your guess.”

At this point, the player has three options:

1. To press a key corresponding to the number in the sequence that he or she is attempting to recognize.
2. To press key 0. This will result in restarting the game.
3. To press keys A through F. This will cause the computer to play the sequence again, and will restart the guessing sequence.

### Variations

The program provides a good test for your musical abilities. It is suggested that you start each new game by just listening to the sequence as it is played on the loudspeaker, without looking at the LEDs. This is because the LEDs on the Games Board are numbered, and it is fairly easy to remember the light sequence simply by memorizing the numbers. This would be too simple. The way you should play it is to start with a one-note sequence. If you are successful, continue with a two-note sequence, and then with a three-note sequence. Match your skills with other players. The player able to recognize the longest sequence is the winner. Note that some players are capable of recognizing a nine-note sequence fairly easily.

After a certain number of notes are played (e.g., when more than five notes are played), in order to facilitate the guessing you may allow the player to look at the LEDs on the Games Board. Another approach might be to allow the player to press one of the alphabetic keys at any time in order to listen to the sequence again. However, you may want to require that the player pay a penalty for doing this. This could be achieved by requiring that the player recognize a second sequence of the same length before trying a longer one. This means that if, for example, a player attempts to recognize a five-note sequence but becomes nervous after making a mistake and forgets the sequence,

that player will be allowed to press one of the alphabetic keys and hear the sequence again. However, if the player is successful on the second attempt, he or she must then recognize another five-note sequence before proceeding to a six-note one.

You can be even tougher and specify that any player is allowed a replay of the stored pattern a maximum of two, three, or five times per game. In other words, throughout the games a player may replay the sequence he or she is attempting to guess by pressing one of the alphabetic keys, but this resource may be used no more than  $n$  times.

### *An ESP Tester*

Another variation of this game is to attempt to recognize the sequence without listening to it or seeing it! Clearly, in such a case you can rely only on your ESP (Extra Sensory Perception) powers to facilitate guessing. In order to determine whether you have ESP or not, set the length of the initial sequence to "1." Then, hit the key in an attempt to guess the note selected by the program. Try this a number of times. If you do not have ESP your results should be random. Statistically, you should win one out of nine times which is only one-ninth of the time, or 11.11% of the time. Note that this percentage is valid only for a large number of guesses.

If you win more than 11% of the time, you may have ESP! If your score is higher than 50%, you should definitely run for political office or immediately apply for a top management position in business. If your score is less than 11%, you have "negative ESP" and you should consider looking both ways before crossing the street.

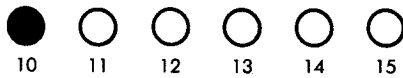
The following is an exercise for readers who have a background in statistics.

**Exercise 8-1:** *Compute the statistical probability of guessing a correct two-number sequence, and a correct four-number sequence.*

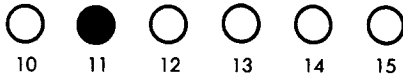
## **A TYPICAL GAME**

The program starts at location 200. As usual, LED 10 lights up as shown in Figure 8.1. We specify a series of length two by pushing key "2" on the keyboard. The LED display as it appears in Figure 8.2, means "enter your guess."

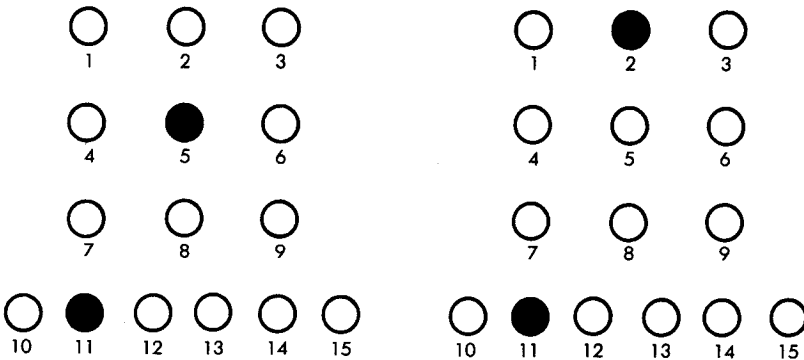
We want to hear the tunes so we push key "F." In response, LEDs 5 and 2 light up briefly on the Games Board and corresponding tones



**Fig. 8.1: Specify Length of Sequence to Duplicate**



**Fig. 8.2: Enter Your Guess**



**Fig. 8.3: Follow Me**

are heard through the speaker. This is illustrated in Figure 8.3. We must now enter the sequence we have recognized. We push "5" on the keyboard. In response, LED 11 goes blank and LED 5 lights up briefly. Simultaneously, the corresponding note is played through the speaker. It is a successful guess!

Next, we press key "2." LED 2 lights up, and the speaker produces the matching tone indicating that our second guess has also been successful. A moment later, all LEDs on the board light up to congratulate us and the rising scale is sounded. It is a sequence of notes of increasing frequencies meant to confirm that we have guessed suc-

cessfully. The game is then restarted, and LED 10 lights up, as shown in Figure 8.1.

Let us now follow a losing sequence: LED 10 is lit at the beginning of the game, as in Figure 8.1. This time we press key "1" in order to specify a one-note sequence. Led 11 lights up, as shown in Figure 8.2. We press key "F," and the note is played on the speaker. (We do not look at the Games Board to see which LED lights up, as that would be too easy.) We press key "3." A "lose" sound is heard, and LED 1 lights up indicating that one mistake has been made. A decreasing scale is then played (notes of decreasing frequencies) to confirm to the unfortunate player that he or she has guessed the sequence incorrectly. The game is then continued with the same sequence and length, i.e., the situation is once again the one indicated in Figure 8.2.

If at this point the player wants to change the length of the sequence, or enter a new sequence, he or she must explicitly restart the game by pressing key 0. After pressing key 0, the situation will be the one indicated in Figure 8.1, where the length of the sequence can be specified again.

## THE ALGORITHM

The flowchart for this program is shown in Figure 8.4. Let us examine it, step-by-step:

1. The program tells the player to select a sequence length by lighting LED 10 on the Games Board.
2. The sequence length is read from the keyboard. (Keys 0 and A-F are ignored at this point.)
3. The two main variables are initialized to "0," i.e., the number of guesses and the number of errors are cleared.
4. A sequence table of the appropriate length must then be generated using random numbers whose values are between 1 and 9.
5. Next, LED 11 is lit, and the player's keystroke is read.
6. If it is "0," the game is restarted. Otherwise, we proceed.
7. If the keystroke value is greater than or equal to 10, it is an alphabetic character and we branch off to the right part of the flowchart into steps 8 and 9. The recorded sequence is displayed to the player, all variables are reinitialized to 0, and the guessing process is restarted. If the keystroke was a number between 1 and 9, it must be matched against the stored value. We go to 10 on the flowchart.

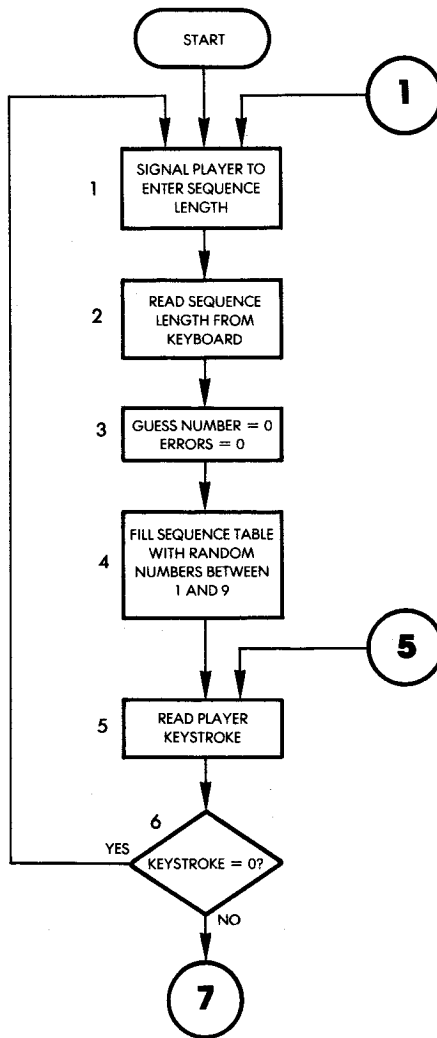


Fig. 8.4: Echo Flowchart

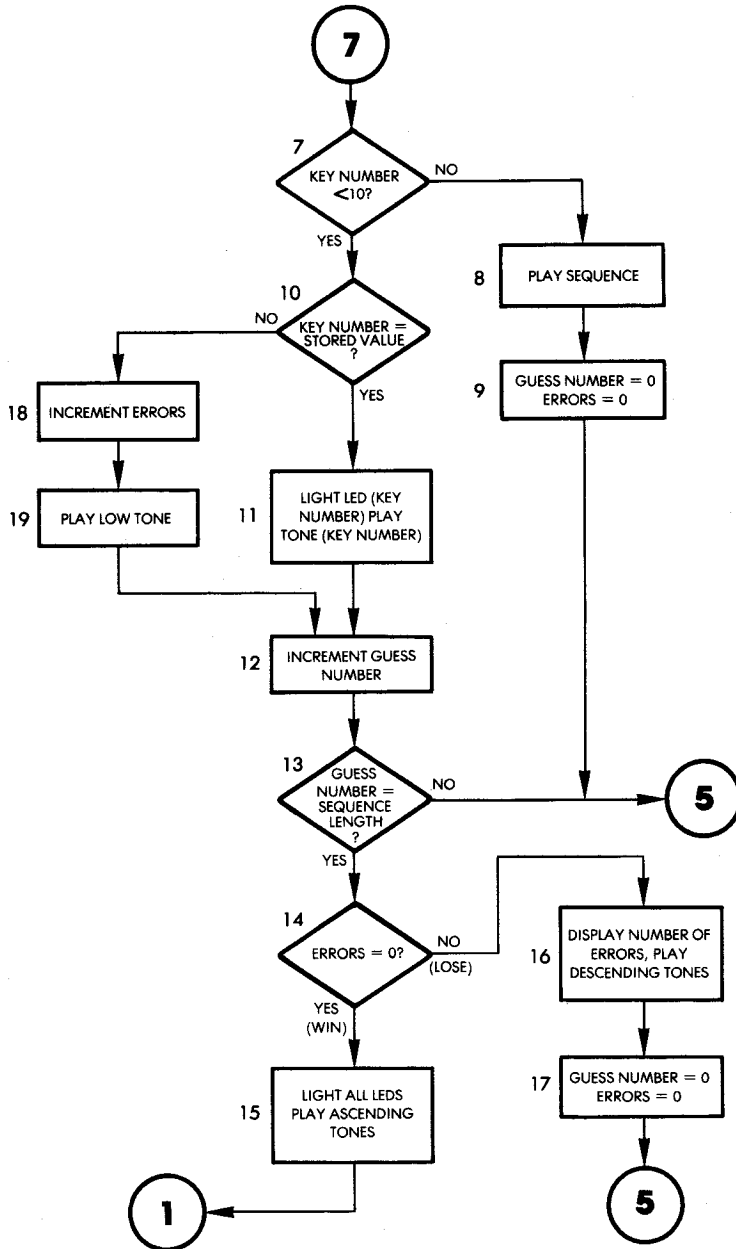


Fig. 8.4: Echo Flowchart (Continued)



10. If the guess was correct, we branch right on the flowchart to step 11.
11. Since the key pressed matches the value stored in memory, the corresponding LED on the Games Board is lit, and the tone corresponding to the key that has been pressed is played.
12. The guessed number is incremented, and then it is compared to the maximum length of the sequence to be guessed.
13. A check is made to see if the maximum length of the sequence has been reached. If it has not, a branch occurs back to step 5 on the flowchart, and the next keystroke is obtained. If the maximum length of the sequence has been reached, we proceed down the flowchart to the box labeled 14.
14. The total number of errors made by the player is checked. The variable ERRORS is tested against the value "0." If it is "0" it is a winning situation and a branch occurs to box 15.
15. All LEDs on the board are lit, a sequence of ascending tones is played, and a branch occurs back to the beginning of the game.  
Let us now go back to box 14. If the number of errors was greater than zero, this is a "lose" situation and a branch occurs to box 16.
16. The number of errors is displayed, and a sequence of descending tones is played.
17. All variables are reset to 0, and a branch occurs to box 5, giving the player another chance to guess the series.  
Now we shall turn our attention back to box 10 on the flowchart, where the value of the key was being tested against the stored value. We will assume this time that the guess was wrong, and branch to the left of box 10.
18. The number of errors made by the player is incremented by one.
19. A low tone is played to indicate the losing situation. The program then branches back to box 12 and proceeds as before.

### THE PROGRAM

The complete program appears in Figure 5.1. The program uses two tables, and several variables. The two tables are NOTAB used to specify the note frequencies, and DURTAB used to specify the note durations. Both of these tables were introduced in Chapter 2, and will not be described here. Essentially, they provide the delay constants required to implement a note of the appropriate frequency and to play it for the appropriate length of time. Note that it is possible to modify

LINE #	LOC	CODE	LINE
0002	0000		; 'ECHO'
0003	0000		;PATTERN/TONE RECALL AND ESP TEST PROGRAM.
0004	0000		;THE USER GUESSES A PATTERN OF LIT LERS AND
0005	0000		;THEIR ASSOCIATED TONES. THE TONE/LIGHT
0006	0000		;COMBINATION CAN BE PLAYED; SO THAT THE USER
0007	0000		;MUST REMEMBER IT AND REENTER IT CORRECTLY.
0008	0000		; OPERATING THE PROGRAM:
0009	0000		;THE STARTING ADDRESS IS \$200
0010	0000		;THE BOTTOM ROW OF LERS IS AN INDICATOR
0011	0000		;FOR PROGRAM STATUS: THE LEFTMOST
0012	0000		;ONE (\$10) INDICATES THAT THE PROGRAM
0013	0000		;IS EXPECTING THE USER TO INPUT THE LENGTH
0014	0000		;OF THE SEQUENCE TO BE GUESSED.
0015	0000		;THE LED SECOND FROM THE LEFT (\$11) INDICATES
0016	0000		;THAT THE PROGRAM EXPECTS EITHER A GUESS (1-9),
0017	0000		;THE COMMAND TO RESTART THE GAME (0), OR
0018	0000		;THE COMMAND TO PLAY THE SEQUENCE (A-F).
0019	0000		;THE KEYS 1-9 ARE ASSOCIATED WITH THE
0020	0000		;LERS 1-9.
0021	0000		;LOOKING AT THE SEQUENCE WHILE IN THE MIDDLE
0022	0000		;OF GUESSING IT WILL ERASE ALL PREVIOUS
0023	0000		;GUESSES (RESET GESNO AND ERRO TO 0).
0024	0000		;AFTER A WIN, THE PROGRAM RESTARTS.
0025	0000		;
0026	0000		;LINKAGES:
0027	0000		GETKEY = \$100
0028	0000		;
0029	0000		;VARIABLE STORAGES:
0030	0000		DIGITS = \$00 ;NUMBER OF DIGITS IN SEQUENCE
0031	0000		GESNO = \$01 ;NUMBER OF CURRENT GUESS.
0032	0000		;(WHERE THE USER IS IN THE SERIES)
0033	0000		ERRO = \$02 ;NUMBER OF ERRORS MADE IN
0034	0000		;GUESSING CURRENT SEQUENCE.
0035	0000		DUR = \$03 ;TEMP STORAGE FOR NOTE DURATION.
0036	0000		FREQ = \$04 ;TEMP STORAGE FOR NOTE FREQUENCY.
0037	0000		TEMP = \$05 ;TEMPORARY STORAGE FOR X REG.
0038	0000		TABLE = \$06 ;STORAGE FOR SEQUENCE
0039	0000		RND = \$0F ;SCRATCHPAD FOR RANDOM # GEN.
0040	0000		;\$522 VIA #1 ADDRESSES:
0041	0000		PORT1A = \$A001
0042	0000		DDR1A = \$A003
0043	0000		PORT1B = \$A000
0044	0000		DDR1B = \$A002
0045	0000		TICL = \$A004
0046	0000		;\$522 VIA #3 ADDRESSES
0047	0000		PORT3B = \$AC00
0048	0000		DDR3B = \$AC02
0049	0000		;
0050	0000		* = \$200
0051	0200		;
0052	0200	A9 FF	START LDA #\$FF ;SET UP DATA DIRECTION REGISTERS.
0053	0202	8D 03 A0	STA DDR1A
0054	0205	8D 02 A0	STA DDR1B
0055	0208	8D 02 AC	STA DDR3B
0056	020B	A9 00	LDA #0 ;CLEAR VARIABLE STORAGES
0057	020D	8D 01 A0	STA PORT1A ;...AND LERS
0058	0210	85 02	STA ERRO
0059	0212	85 01	STA GESNO
0060	0214	AD 04 A0	LDA TICL ;GET SEED FOR RND # GEN.
0061	0217	85 10	STA RND#1 ;AND STORE IN RND SCRATCH.
0062	0219	85 13	STA RND#4
0063	021B	A9 02	LDA #X010 ;TURN LED #10 ON TO INDICATE
0064	021D	8D 00 A0	STA PORT1B ;NEED FOR LENGTH INPUT.
0065	0220	20 00 01	DIGKEY JSR GETKEY ;GET LENGTH OF SERIES.
0066	0223	C9 00	CMP #0 ;IS IT 0 ?
0067	0225	F0 F9	BEQ DIGKEY ;IF YES, GET ANOTHER.
0068	0227	C9 0A	CMP #10 ;LENGTH GREATER THAN 9?
0069	0229	10 F5	BPL DIGKEY ;IF YES, GET ANOTHER.
0070	022B	85 00	STA DIGITS ;SAVE VALID LENGTH

Fig. 8.5: Echo Program

# ADVANCED 6502 PROGRAMMING

```

0071 022D AA TAX ;USE LENGTH-1 AS INDEX FOR FILLING...
0072 022E CA DEX ;...SERIES W/RANDOM VALUES.
0073 022F B6 05 FILL STX TEMP ;SAVE X FROM 'RANDOM'
0074 0231 20 E7 02 JSR RANDOM
0075 0234 A6 05 LDX TEMP ;RESTORE X
0076 0236 FB SED ;DO A DEIMAL ADJUST
0077 0237 18 CLC
0078 0238 69 00 ADC #0
0079 023A D8 CLD
0080 023B 29 0F AND #0F ;REMOVE UPPER NYBBLE SO
0081 023D ;NUMBER IS <10
0082 023D F0 F0 BEQ FILL ;# CAN'T BE ZERO.
0083 023F 95 06 STA TABLE,X ;STORE # IN TABLE
0084 0241 CA DEX ;DECREMENT FOR NEXT
0085 0242 10 EB BPL FILL ;LOOP IF NOT DONE
0086 0244 A9 00 KEY LDA #0 ;LEAR LEDS
0087 0246 BD 01 A0 STA PORT1A
0088 0249 A9 04 LDA #0100 ;TURN INPUT INDICATOR ON.
0089 024B BD 00 A0 STA PORT1B
0090 024E 20 00 01 JSR GETKEY ;GET GUESS OR PLAY CMD.
0091 0251 C9 00 CMP #0 ;IS IT 0 ?
0092 0253 F0 AB STRTJP BEQ START ;IF YES, RESTART.
0093 0255 C9 0A CMP #10 ;NUMBER < 10 ?
0094 0257 30 22 BMI EVAL ;IF YES, EVALUATE GUESS.
;
;ROUTINE TO DISPLAY SERIES TO BE GUESSED BY
;LIGHTING LEDS AND PLAYING TONES IN SEQUENCE.
;
0098 0259 SHOW LDX #0
0099 0259 A2 00 STX GESNO ;CLEAR ALL CURRENT GUESSES.
0100 025B 86 01 STX ERRS ;CLEAR CURRENT ERRORS.
0101 025D 86 02 SHOWLP LDA TABLE,X ;GET XTH ENTRY IN SERIES TABLE.
0102 025F B5 06 STX TEMP ;SAVE X
0103 0261 86 05 JSR LIGHT ;LIGHT LED#(TABLE(X))
0104 0263 20 CF 02 JSR PLAY ;PLAY TONE#(TABLE(X))
0105 0266 20 FA 02 LDY #FF ;SET LOOP CNTR. FOR DELAY
0106 0269 A0 FF DELAY ROR DUR ;WASTE TIME
0107 026B 66 03 ROL DUR
0108 026D 26 03 DEY ;COUNT DOWN...
0109 026F 88 BNE DELAY ;IF NOT DONE, LOOP AGAIN.
0110 0270 D0 F9 LDX TEMP ;RESTORE X
0111 0272 A6 05 INX ;INCREMENT INDEX TO SHOW NEXT
0112 0274 EB CPX DIGITS ;ALL DIGITS SHOWN?
0113 0275 E4 00 BNE SHOWLP ;IF NOT, SHOW NEXT.
0114 0277 D0 E6 BEQ KEY ;DONE: GET NEXT INPUT.
0115 0279 F0 C9 ;
;ROUTINE TO EVALUATE GUESSES OF PLAYER.
;
0116 027B EVAL LDX GESNO ;GET NUMBER OF GUESS.
0117 027E CMP TABLE,X ;GUESS = CORRESPONDING DIGIT?
0118 027E BEQ CORECT ;IF YES, SHOW PLAYER.
0119 027B A6 01 WRONG INC ERRS ;GUESS WRONG, ANOTHER ERROR.
0120 027D D5 06 LDA #80 ;DURATION FOR LOW TONE TO INDICATE
0121 027F F0 0D STA DUR ;BAD GUESS.
0122 0281 E6 02 LDA #FF ;FREQUENCY CONSTANT
0123 0283 A9 80 JSR PLYTON ;PLAY IT
0124 0285 85 03 BEQ ENDCHK ;CHECK FOR ENDGAME
0125 0287 A9 FF CORECT JSR LIGHT ;VALIDATE CORRECT GUESS...
0126 0289 20 04 03 JSR PLAY
0127 028C F0 06 BEQ ENDCHK ;CHECK FOR ENDGAME
0128 028E 20 CF 02 CORECT JSR LIGHT ;VALIDATE CORRECT GUESS...
0129 0291 20 FA 02 JSR PLAY
0130 0294 E6 01 ENDCHK INC GESNO ;ONE MORE GUESS TAKEN.
0131 0296 A5 00 LDA DIGITS
0132 0298 C5 01 CMP GESNO ;ALL DIGITS GUESSED?
0133 029A D0 AB BNE KEY ;IF NOT, GET NEXT.
0134 029C A5 02 LDA ERRS ;GET NUMBER OF ERRORS.
0135 029E C9 00 CMP #0 ;ANY ERRORS?
0136 02A0 F0 15 BEQ WIN ;IF NOT, PLAYER WINS.
0137 02A2 20 CF 02 LOSE JSR LIGHT ;SHOW NUMBER OF ERRORS.
0138 02A5 A9 09 LDA #9 ;PLAY 8 DESCENDING TONES
0139 02A7 48 LOSELP PHA
0140 02A8 20 FA 02 JSR PLAY
0141 02AB 68 PLA

```

Fig. 8.5: Echo Program (Continued)

```

0142 02AC 3B          SEC
0143 02AD E9 01     SBC #1
0144 02AF D0 F6     BNE LOSELP
0145 02B1 85 01     STA GESNO ;CLEAR VARIABLES
0146 02B3 85 02     STA ERRS
0147 02B5 F0 8D     BEQ KEY ;GET NEXT GUESS SEQUENCE
0148 02B7 A9 FF     WIN LDA #FF ;TURN ALL LEIS ON FOR WIN
0149 02B9 8D 01 A0   STA PORT1A
0150 02BC 8D 00 A0   STA PORT1B
0151 02BF A9 01     LDA #1 ;PLAY 8 ASCENDING TONES
0152 02C1 48       WINLP PHA
0153 02C2 20 FA 02  JSR PLAY
0154 02C5 68       PLA
0155 02C6 18       CLC
0156 02C7 69 01     ADC #01
0157 02C9 C9 0A     CMP #10
0158 02CB D0 F4     BNE WINLP
0159 02CD F0 84     BEQ STRTJP ;USE DOUBLE-JUMP FOR RESTART
0160 02CF           ;
0161 02CF           ;ROUTINE TO LIGHT NTH LED, WHERE N IS
0162 02CF           ;THE NUMBER PASSED AS A PARAMETER IN
0163 02CF           ;THE ACCUMULATOR.
0164 02CF           ;
0165 02CF 48       LIGHT PHA ;SAVE A
0166 02D0 AB       TAY ;USE A AS COUNTER IN Y
0167 02D1 A9 00     LDA #0 ;CLEAR A FOR BIT SHIFT
0168 02D3 8D 00 A0  STA PORT1B ;CLEAR HI LEIS.
0169 02D6 38       SEC ;GENERATE HI BIT TO SHIFT LEFT.
0170 02D7 2A       LTSHT ROL A ;MOVE HI BIT LEFT.
0171 02D8 88       DEY ;DECREMENT COUNTER
0172 02D9 D0 FC     BNE LTSHT ;SHIFTS DONE?
0173 02DB 8D 01 A0  STA PORT1A ;STORE CORRECT PATTERN
0174 02DE 90 05     RCC LTCC ;BIT 9 NOT HI, DONE.
0175 02E0 A9 01     LDA #1
0176 02E2 8D 00 A0  STA PORT1B ;TURN LED 9 ON.
0177 02E5 68       LTCC PLA ;RESTORE A
0178 02E6 60       RTS ;DONE.
0179 02E7           ;
0180 02E7           ;RANDOM NUMBER GENERATOR: RETURNS W/ NEW
0181 02E7           ;RANDOM NUMBER IN A.
0182 02E7           ;
0183 02E7 38       RANDOM SEC
0184 02E8 A5 10     LDA RND+1
0185 02EA 65 13     ADC RND+4
0186 02EC 65 14     ADC RND+5
0187 02EE 85 0F     STA RND
0188 02F0 A2 04     LDX #4
0189 02F2 B5 0F     RNDLP LDA RND,X
0190 02F4 95 10     STA RND+1,X
0191 02F6 CA       DEX
0192 02F7 10 F9     BPL RNDLP
0193 02F9 60       RTS
0194 02FA           ;
0195 02FA           ;ROUTINE TO PLAY TONE WHOSE NUMBER IS PASSED
0196 02FA           ;IN BY ACCUM. IF ENTERED AT PLYTON, IT WILL
0197 02FA           ;PLAY TONE WHOSE LENGTH IS IN DUR, FREQUENCY
0198 02FA           ;IN ACCUMULATOR.
0199 02FA           ;
0200 02FA AB       PLAY TAY ;USE TONE# AS INDEX...
0201 02FB 88       DEY ;DECREMENT TO MATCH TABLES
0202 02FC B9 27 03  LDA DURTAB,Y ;GET DURATION FOR TONE# N.
0203 02FF 85 03     STA DUR ;SAVE IT.
0204 0301 B9 1E 03  LDA NOTAB,Y ;GET FREQ. CONST FOR TONE# N
0205 0304 85 04     PLYTON STA FREQ ;SAVE IT.
0206 0306 A9 00     LDA #0 ;SET SPKR PORT LD.
0207 0308 8D 00 AC  STA PORT3B
0208 030B A6 03     LDX DUR ;GET DURATION IN # OF 1/2 CYCLES.
0209 030D A4 04     FL2 LDY FREQ ;GET FREQUENCY
0210 030F 88       FL1 DEY ;COUNT DOWN DELAY...
0211 0310 18       CLC ;WASTE TIME
0212 0311 90 00     BCC *+2

```

Fig. 8.5: Echo Program (Continued)

# ADVANCED 6502 PROGRAMMING

```

0213 0313 D0 FA          BNE FL1 ;LOOP FOR DELAY
0214 0315 49 FF          EOR #$FF ;COMPLEMENT PORT
0215 0317 8D 00 AC       STA PORT3B
0216 031A CA             DEX          ;COUNT DOWN DURATION...
0217 031B D0 F0          BNE FL2 ;LOOP TIL NOTE OVER.
0218 031D 60             RTS          ;DONE.
0219 031E                ;
0220 031E                ;TABLE FOR NOTE FREQUENCIES.
0221 031E                ;
0222 031E C9             NOTAB  .BYTE $C9,$BE,$A9,$96,$BE,$7E,$70,$64,$5E
0222 031F BE
0222 0320 A9
0222 0321 96
0222 0322 8E
0222 0323 7E
0222 0324 70
0222 0325 64
0222 0326 5E
0223 0327                ;
0224 0327                ;TABLE FOR NOTE DURATIONS.
0225 0327                ;
0226 0327 6B             DURTAB .BYTE $6B,$72,$80,$8F,$94,$AA,$BF,$D7,$E4
0226 0328 72
0226 0329 80
0226 032A 8F
0226 032B 94
0226 032C AA
0226 032D BF
0226 032E D7
0226 032F E4
0227 0330                .END

SYMBOL TABLE
SYMBOL  VALUE
CORECT  028E  DDR1A  A003  DDR1B  A002  DDR3B  A002
DELAY   026B  DIGITS  0000  DIGKEY  0220  DUR     0003
DURTAB  0327  ENDCHK  0294  ERRS    0002  EVAL   027B
FILL    022F  FL1     030F  FL2     030B  FREQ   0004
GESNO   0001  GETKEY  0100  KEY     0244  LIGHT  02CF
LOSE    02A2  LOSELP  02A7  LTCC    02E5  LTRSHFT 02B7
NOTAB   031E  PLAY    02FA  PLYTON  0304  PORT1A  A001
PORT1B  A000  PORT3B  AC00  RANDOM  02E7  RND     000F
RNDLP   02F2  SHGW    0259  SHOWLP  025F  START  0200
STRJTP  0253  TICL    A004  TABLE  0006  TEMP   0005
WIN     02B7  WINLP   02C1  WRONG   02B1

END OF ASSEMBLY

```

**Fig. 8.5: Echo Program (Continued)**

the difficulty of the game by increasing or decreasing the duration during which each note is played. Clearly, reducing the duration makes the game more difficult. Increasing the duration will usually make it easier, up to a point. You are encouraged to try variations.

The main variables used by the program are the following:

DIGITS contains the number of digits in the sequence to be recognized.

GESNO indicates the number of the current guess, i.e., which of the notes in the series the user is attempting to recognize.

ERRS indicates the number of errors made by the player so far.

TABLE is the table containing the sequence to be recognized.

A few other memory locations are reserved for passing parameters to subroutines or as scratch-pad storage. They will be described within the context of the associated routines.

As usual, the program starts by setting the data direction registers for Port 1A, Port 1B and Port 3B to an output configuration:

```
START      LDA #$FF
           STA DDR1A
           STA DDR1B
           STA DDR3B
```

Next, all LEDs on the board are turned off:

```
LDA #0
STA PORT1A
```

and the two variables, ERRS and GESNO, are set to 0:

```
STA ERRS
STA GESNO
```

The random number generator is primed by obtaining a seed and storing it at locations RND + 1 and RND + 4:

```
LDA TICL           Read timer counter.
STA RND + 1
STA RND + 4
```

The game is now ready to start. LED 10 must be turned on to indicate to the player that the game is ready:

```
LDA #%010         Pattern for LED 10
STA PORT1B        Specify length
```

The keyboard is scanned for the player input using the usual GETKEY subroutine (described in Chapter 1):

```
DIGKEY    JSR GETKEY
```

It is checked for the value "0":

## ADVANCED 6502 PROGRAMMING

CMP #0  
BEQ DIGKEY      If = 0, get another one

If the entry was "0," the program waits for another keystroke. Otherwise, it is compared to the value 10:

CMP #10              Sequence longer than 9  
BPL DIGKEY

If the sequence length is greater than 9, it is also rejected. Accepting only valid inputs, using a bracket is known as "reasonableness testing" or "bracket-filtering."

If all is fine, the length of the sequence to be recognized is stored at memory location DIGITS:

STA DIGITS          Length of sequence

A running pointer is then computed and stored at location TEMP. It is equal to the previous length minus 1:

TAX                  Use X for computation  
DEX                  Decrement  
FILL                STX TEMP

The RANDOM subroutine is then called to provide a first random number:

JSR RANDOM

The position pointer in the series of notes now being generated is retrieved from TEMP, and stored in index register X in anticipation of storing the new random number in TABLE:

LDX TEMP

The value of the random number contained in the accumulator is then converted to a decimal value between 0 and 9. This process can be performed in various ways. Here, we take advantage of the special decimal mode available on the 6502. The decimal mode is set by specifying:

SED                  Set decimal mode

Note that the carry flag must be cleared, prior to an addition:

CLC                      Clear carry

The trick used here is to add “0” to the random number contained in the accumulator. The result in the right part of A is guaranteed to be a digit between 0 and 9, since we are operating in the decimal mode. Naturally, any other number could also be added to A to make its contents “decimal”; however, this would change the distribution of the random numbers, and some numbers in the series such as 0, 1, and 2 might never appear. Once this conversion has been performed, the decimal mode is simply turned off:

ADC #0                  Add “0” in decimal mode  
CLD                      Clear decimal mode

This is a powerful 6502 facility used to a great advantage in this instance. In order to guarantee that the result left in A be a decimal number between 0 and 9, the upper nibble of the byte is removed by masking it off:

AND #\$0F

Finally, a value of “0” is not allowed, and a new number must be obtained if this is the current value of the accumulator:

BEQ FILL

**Exercise 8-2:** *Could we avoid this special case for “0” by adding a value other than “0” to A above?*

If this is not the current value of the accumulator, we have a decimal number between 1 and 9 that is reasonably random, which can now be stored in the table. Remember that index register X has been preloaded with the current number’s position in the sequence (retrieved from memory location TEMP). It can be used, as is, as an index:

STA TABLE,X          Store # in table

The number pointer is then decremented in anticipation of the next iteration:



DEX

and the loop is reentered until the table of random numbers becomes full:

BPL FILL

We are now ready to play. LED 12 will be turned on, signaling to the player that he or she may enter a guess:

```

KEY          LDA #0
              STA PORT1A
              LDA #%0100
              STA PORT1B
    
```

The player's guess is then read from the keyboard:

```

          JSR GETKEY      Get guess
    
```

It must be tested for "0" or for an alphabetic value. Let us test for "0":

```

          CMP #0          Is it 0?
STRTJP   BEQ START      If yes, restart
    
```

If it is "0," the game is restarted, and a branch occurs to location START. If it is not "0," we must check for an alphabetic character:

```

          CMP #10        Number < 10?
          BMI EVAL       If yes, evaluate correctness
    
```

If the value of the input keystroke is less than ten, it is a guess and is evaluated with the EVAL routine. Otherwise, the program executes the SHOW routine to display the series.

*The SHOW Routine*

We will assume here that an alphabetic key has been pressed. BMI fails, and we enter the SHOW routine. This routine plays the computer-generated tune and lights up the corresponding sequence of LEDs. Also, whenever this routine is entered, the guessing sequence is

restarted and the temporary variables are reset to 0:

SHOW	LDX #0	
	STX GESNO	
	STX ERRS	Reset all variables

The first table entry is obtained, the corresponding LED is lit, and the corresponding tone is played:

SHOWLP	LDA TABLE,X	Get Xth entry in table
	STX TEMP	Save X
	JSR LIGHT	Light LED # TABLE (X)
	JSR PLAY	Play tone # TABLE (X)

An internote delay is then implemented using Y as the loop counter and two dummy instructions to extend the delay:

	LDY #\$FF	
DELAY	ROR DUR	Dummy instruction
	ROL DUR	Dummy
	DEY	Count down
	BNE DELAY	End of loop test

We are now ready to perform the same operation for the next note in the current table. The index pointer is restored and incremented:

	LDX TEMP	Restore X
	INX	Increment it

It is then compared to the maximum number of digits stored in the table. If the maximum has been reached, the display operation is complete and we go back to label KEY. Otherwise, the next tone is sounded, and we go back to label SHOWLP:

	CPX DIGITS	All digits shown?
	BNE SHOWLP	
	BEQ KEY	Done, get next input

### *The EVAL Routine*

Let us now examine the routine which evaluates the guess of the

## ADVANCED 6502 PROGRAMMING

player. It is the EVAL routine. The value of the corresponding entry in TABLE is obtained and compared to the player's input:

EVAL	LDX GESNO	Load guess number into X
	CMP TABLE,X	Compare guess to number
	BEQ CORECT	If correct, tell player

If there is a match, a branch occurs to location CORECT; otherwise, the program proceeds to label WRONG. Let us examine this case. If the guess is wrong, one more error is recorded:

WRONG	INC ERRS
-------	----------

A low tone is played:

LDA #\$80	
STA DUR	
LDA #\$FF	
JSR PLYTON	Play it

A jump then occurs to location ENDCHK:

BEQ ENDCHK	Check for end of game
------------	-----------------------

**Exercise 8-3:** *Examine the BEQ instruction above. Will it always result in a jump to label ENDCHK? (Hint: determine whether or not the Z bit will be set at this point.)*

**Exercise 8-4:** *What are the merits of using BEQ (above) versus JMP?*

Now we shall consider what happens in the case of a correct guess. If the guess is correct, we light up the corresponding LED and play the corresponding tone. Both subroutines assume that the accumulator contains the specified number:

CORECT	JSR LIGHT	Turn on LED
	JSR PLAY	Play note to confirm

We must now determine whether we have reached the end of a sequence or not, and take the appropriate action. The number of guesses is incremented and compared to the maximum length of the

stored tune:

ENDCHK	INC GESNO	One more guess
	LDA DIGITS	
	CMP GESNO	All digits guessed?
	BNE KEY	If not, get next key closure

If we are not done yet, a branch occurs back to label KEY. Otherwise, we have reached the end of a game and must signal either a “win” or a “lose” situation. The number of errors is checked to determine this:

LDA ERRS	Get number of errors
CMP #0	No error?
BEQ WIN	If not, player wins

If a “win” is identified, a branch occurs to label WIN. This will be described below. Let us examine now what happens in the case of a “lose”:

LOSE	JSR LIGHT	Show number of errors
------	-----------	-----------------------

The number of errors is displayed by lighting up the corresponding LED. Remember that the accumulator was conditioned prior to entering this routine and contained the value of ERRS, i.e., the number of errors so far.

Next, a sequence of eight descending tones is played. The top of the stack is used to contain the remaining number of tones to be played:

LOSELP	LDA #9	Play 8 descending tones
	PHA	Save A on stack
	JSR PLAY	Play tone
	PLA	Restore A

Once a tone has been played, the remaining number of tones to be played is decremented by one and tested for “0”:

SEC	Set carry (for subtract)
SBC #1	Subtract one
BNE LOSELP	

**Exercise 8-5:** *Note how the top of the stack has been used as a tem-*

## ADVANCED 6502 PROGRAMMING

*porary scratch location. Can you suggest an alternative way to achieve the same result without using the stack?*

**Exercise 8-6:** *Discuss the relative merits of using the stack versus using other techniques to provide temporary working locations for the program. Are there potential dangers inherent in using the stack?*

Eight successive tones are played. Then the two work variables, GESNO and ERRS, are reset to "0," and a branch occurs back to the beginning of the program:

STA GESNO	Clear variables
STA ERRS	
BEQ KEY	Get next guess sequence

Let us examine now what happens in a "win" situation. All LEDs on the Games Board are turned on simultaneously:

WIN	LDA #\$FF	It is a win: turn all LEDs on
	STA PORT1A	
	STA PORT1B	

Next, a sequence of eight ascending tones is played. The tone number is stored in the accumulator and will be used as an index by the PLAY subroutine to generate an appropriate note. As before, the top of the stack is used to provide working storage:

	LDA #1	A will be incremented to 9
WINLP	PHA	Save A on the stack
	JSR PLAY	
	PLA	

The number of tones which have been played is then incremented by 1 and compared to the maximum value of 9:

	CLC	Clear carry for addition
	ADC #01	
	CMP #10	

As long as the maximum of 9 has not been reached, a branch occurs back to label WINLP:

BNE WINLP

Otherwise, a new game is started:

BEQ STRTJP      Double jump for restart

This completes the description of the main program. Three subroutines are used by this program. They will now be described.

### The Subroutines

#### *LIGHT Subroutine*

This subroutine assumes that the accumulator contains the number of the LED to be lit. The subroutine will light up the appropriate LED on the Games Board. It will achieve this result by writing a "1" in the appropriate position in the accumulator and then sending it to the appropriate output port. Either Port 1A will be used (for LEDs 1 through 8) or Port 1B (for LED 9). The "1" bit is written in the appropriate position in the accumulator by performing a sequence of shifts. The number of shifts is equal to the position of the LED to be lit. Index register Y is used as a shift-counter. The number of the LED to be lit is saved in the stack at the beginning of the subroutine and will be restored upon exit. Note that this is a classic way to preserve the contents of an essential register during subroutine execution so that the contents of the accumulator will be unchanged upon subroutine exit. If this was not the case, the calling program would have to explicitly preserve the contents of the accumulator prior to calling the LIGHT subroutine. Then it might have to load it back into the accumulator prior to using another one of the routines, such as the PLAY routine. Because LIGHT and PLAY are normally used in sequence, it is more efficient to make it the subroutine's responsibility to save the contents of the accumulator. Let us do it:

LIGHT      PHA      Preserve A

The shift-counter is then set up:

TAY      Use Y as shift counter

and the accumulator is initialized to "0":

## ADVANCED 6502 PROGRAMMING

LDA #0                      Clear A

LED 9 is turned off in case it was lit:

STA PORT1B

The shifting loop is then implemented. The carry bit is initially set to "1," and it will be shifted left in the accumulator as many times as necessary:

```
LTSHFT            SEC                      Set carry
                  ROL A
                  DEY
                  BNE LTSHFT
```

The correct bit pattern is now contained in the accumulator and displayed on the Games Board:

STA PORT1A

However, one special case may arise: if LED 9 has been specified, the contents of the accumulator are "0" at this point, but the carry bit has been set to "1" by the last shift. This case must be explicitly tested for:

```
BCC LTCC            Is bit 9 set?
```

If this situation exists, the accumulator must be set to the value "00000001," and output to Port 1B:

```
LDA #1
STA PORT1B          Turn LED 9 on
```

We finally exit from the routine without forgetting to restore the accumulator from the stack where it had been saved:

```
LTCC                PLA                      Restore A
                     RTS
```

**Exercise 8-7:** *List the registers destroyed or altered by this subroutine every time it is executed.*

**Exercise 8-8:** Assume that register *Y* must be left unchanged upon leaving this subroutine. What are the required program changes, if any?

### *RANDOM Subroutine*

This subroutine generates a new random number and returns its value in *A*. Its operation has been described in Chapter 4.

### *PLAY Subroutine*

This subroutine will normally play the tone corresponding to the number contained in the accumulator. Optionally, it may be entered at location *PLYTON* and will then play the tone corresponding to the frequency set by the accumulator and corresponding to the length specified by the contents of memory location *DUR*. Let us examine it.

Index register *Y* is used as an index to the two tables required to determine the note duration and the note frequency. In this game, up to 9 notes may be played, corresponding to LEDs and keys 1 through 9. Index register *Y* is first conditioned:

<i>PLAY</i>	<i>TAY</i>	Use tone # as index
	<i>DEY</i>	Decrement to internal value

Note that the index register must be decremented by one. This is because key 1 corresponds to entry number 0 in the table, and so on. The duration and frequencies are obtained from tables *DURTAB* and *NOTAB* using the indexed addressing mode. They are stored respectively at locations *DUR* and *FREQ*:

	<i>LDA DURTAB,Y</i>	Get duration
	<i>STA DUR</i>	Save it
	<i>LDA NOTAB,Y</i>	Get frequency
<i>PLYTON</i>	<i>STA FREQ</i>	Save it

The speaker is then turned off:

	<i>LDA #0</i>	
	<i>STA PORT3B</i>	Set speaker Port 3B

Two loops will now be implemented. An inner loop will use register *Y* as the delay-counter to implement the correct frequency for the note.



## ADVANCED 6502 PROGRAMMING

Register X will be used in the outer loop and will generate the tone for the appropriate duration of time.

Let us condition the two counter registers:

	LDX DUR	Get duration in # of 1/2 cycles
FL2	LDY FREQ	Get frequency

Next, let us implement the inner loop delay:

FL1	DEY	
	CLC	Waste time
	BCC * + 2	
	BNE FL1	Delay loop

Note that two “do-nothing” instructions have been placed inside the loop to generate a longer delay. At the end of this inner loop delay the contents of the output port connected to the loudspeaker are complemented in order to generate a square wave.

	EOR #\$FF	Complement port
--	-----------	-----------------

Note that, once more, EOR #\$FF is used to complement the contents of a register.

	STA PORT3B	
--	------------	--

The outer loop can then be completed:

	DEX	
	BNE FL2	Outer loop
	RTS	

## SUMMARY

This program demonstrates how simple it is to implement electronic keyboard games that sound for input/output and that are challenging to adult players.

**Exercise 8-9:** *The duration and frequency constants for the nine notes are shown in Figure 8.6. What are the actual frequencies generated by the program?*

<b>NOTE</b>	<b>FREQUENCY CONSTANT</b>	<b>DURATION CONSTANT</b>
1	C9	6B
2	BE	72
3	A9	80
4	96	8F
5	8E	94
6	7E	AA
7	70	BF
8	64	D7
9	5E	E4

**Fig. 8.6: Frequency and Duration Constants**

## **9. Using Interrupts (Mindbender)**

### **INTRODUCTION**

Interrupts are generated by using the programmable interrupt timer of the 6522 VIA, a common 6502 I/O chip. The programmable interrupt timer is used in the free-running mode to generate a wave form.

### **THE RULES**

This game is inspired by the commercial game of MasterMind (trademarked by the manufacturer, Invicta Plastics, Ltd.). In this game, one or more players compete against the computer (and against each other). The computer generates a sequence of digits — for example, a sequence of five digits between “0” and “9” — and the player attempts to guess the sequence of five numbers in the correct order. The computer responds by telling the player how many of the digits have been guessed accurately, and how many were guessed in their correct location in the numerical sequence.

LEDs 1 through 9 on the Games Board are used to display the computer’s response. A blinking LED is used to indicate that the player’s guess contains a correct digit which is located in the right position in the sequence. A steadily lit LED is used to indicate a digit correctly guessed but appearing out of sequence. Several players can match their skills against each other. For a given complexity level — say, for guessing a sequence of seven digits—the player that can correctly guess the number sequence with the fewest guesses is the winner.

The game may also be played with a handicap whereby a given player has to guess a sequence of  $n$  digits while the other player has to guess a sequence of only  $n - 1$  digits. This is a serious handicap, since increasing the level of difficulty by one is quite significant.

### **A TYPICAL GAME**

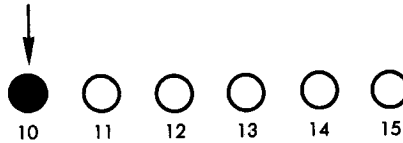
Both audio and visual feedback are used to play this game.

### The Audio Feedback

Every time that a player has entered his or her sequence of guesses, the computer responds by sounding a specific tone. A low tone indicates an incorrect guess; a high tone indicates that the sequence was guessed correctly.

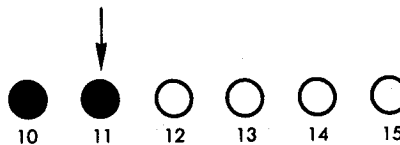
### The Visual Feedback

At the beginning of each game, LED #10 is lit, requesting the length of the sequence to be guessed. This is shown in Figure 9.1. The player then specifies the sequence length as a number from 1 through 9. Any other input will be ignored.



**Fig. 9.1: Enter Length of Sequence**

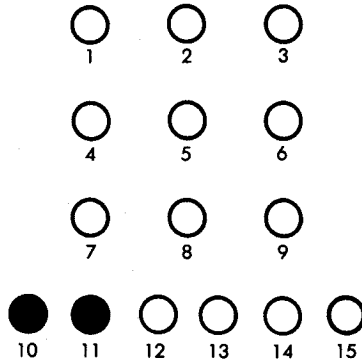
As soon as the length has been specified, for example, let's say the length "2" has been selected, LED #11 lights up. This means "Enter your guess." (See Figure 9.2.) At this point the player enters his or her guess as a sequence of two digits. Let us now play a game.



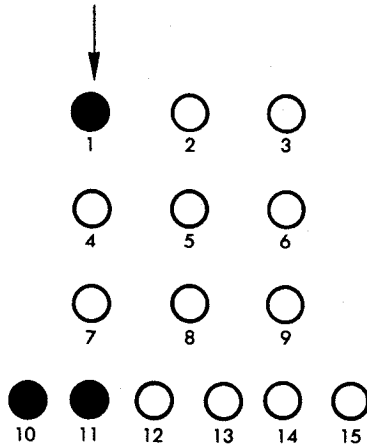
**Fig. 9.2: Enter Your Guess**

The player types in the sequence "1,2." A low tone sounds, LEDs 10 and 11 go out briefly, but nothing else happens. The situation is indicated in Figure 9.3. Since LEDs 1 through 9 are blank, there is no correct digit in the guess. Digits "1" and "2" must be eliminated. Let us try another guess.

We type "3,4." A low tone sounds, but this time LED #1 is steadily on, as indicated in Figure 9.4. From this we know that either "3" or



**Fig. 9.3: Player Enters Wrong Guess**



**Fig. 9.4: One Correct Digit in the Correct Position**

“4” is one of the digits and that it belongs in the other position. Conversely, the sequence “4,3,” must have one good digit in the right position. Just to be sure let us perform a test.

We now type “4,3.” A low tone sounds, indicating that the sequence is not correct, but this time LED #1 is on and blinking. This proves that our reasoning is correct, and we proceed.

We now try “4,5.” A high-pitched sound is heard and LEDs 1 and 2

light up briefly, indicating that those digits have been guessed correctly and that we have won our first game.

At the end of the game, the situation reverts to the one at the beginning, as indicated in Figure 9.1. Note that typing in a value other than “1” through “9” as a guess will restart the game.

There is a peculiarity to the game: if the number to be guessed contains two identical digits, and the player enters this particular digit in one of its two correct locations, the computer response will indicate this digit as being both the right digit in the right place and the right digit in the wrong place!

## THE ALGORITHM

The flowchart for Mindbender is shown in Figure 9.5. Interrupts are used to blink the LEDs. Interrupts will be generated automatically by the programmable interval timer of VIA #1 at approximately 1/15th-of-a-second intervals.

Referring to Figure 9.5, all of the required registers and memory locations will be initialized first. Next (box 2 on the flowchart), the length of the sequence to be guessed is read from the keyboard. The validity bracket “1” to “9” is used to “filter” the player’s input.

Next, a random sequence must be generated. In box 3 of the flowchart, a sequence of random numbers is generated and stored in a digit table, starting at address DIG0.

In box 5, the computer’s sequence of numbers is compared — one number at a time — with the player’s guess. The algorithm takes one digit from the computer sequence and matches it in order against every digit of the player sequence. As we have already indicated, this may result in lighting up two LEDs, if ever there are two or more identical digits in the number to be guessed and the player has specified only one digit. One digit may be flagged as being in the right place, and also as being correct but in the wrong location(s).

Note that, alternatively, another comparison algorithm could be used in which each digit of the player’s sequence is compared in turn with each digit of the computer’s sequence.

Once the digits have been compared, the resulting score is displayed on the LEDs (box 6). Finally, a test is made for a win situation (box 7), and the appropriate sound is generated (box 8).

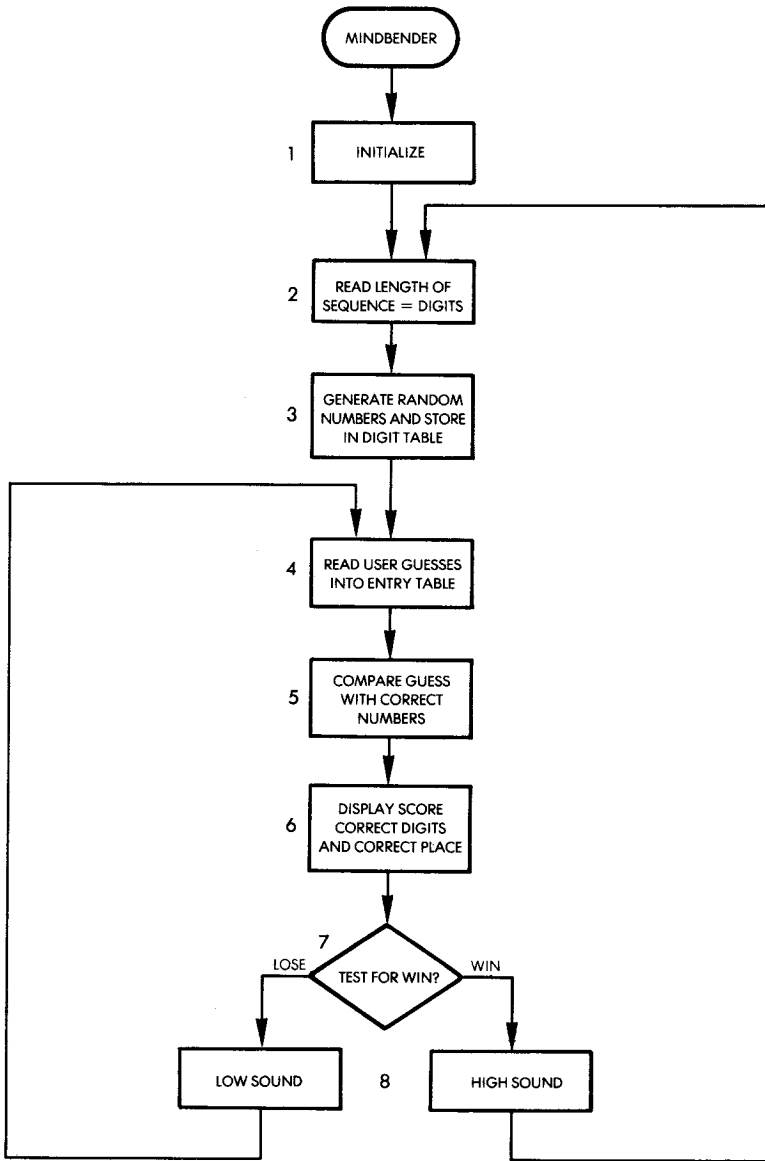


Fig. 9.5: Mindbender Flowchart

## THE PROGRAM

### Data Structures

Two tables of nine entries are used to store, respectively, the computer's sequence and the player's sequence. They are stored starting at addresses DIG0 and ENTRY0. (See Figure 9.6.)

### The Variables

Page 0 is used, as usual, to provide additional working registers, i.e., to store the working variables. The use of page 0 is indicated as a "memory map" in Figure 9.6. The first nine locations are used for the program variables. The function of each variable is indicated in the illustration and will be described in detail as we examine the program below. Locations "09" through "0E" are reserved for the random table used to generate the random numbers. Locations "0F" through "17" are used for the DIG0 table used to store the computer-generated sequence of random numbers. Finally, locations "18" and following are used to contain the sequence of digits typed by the user.

The memory locations used for addressing input/output and for interrupt vectoring are shown in Figure 9.7. Locations "A00" through "A05" are used to address Ports A and B of VIA #1 as well as timer T1. The memory map for a 6522 VIA is shown in Figure 9.8.

Location "A00B" is used to access the auxiliary control register, while location "A00E" accesses the interrupt-enable register. For a detailed description of these registers the reader is referred to the *6502 Applications Book* (reference D302).

Memory locations "A67E" and "A67F" are used to set up the interrupt vector. The starting address of the interrupt-handling routine will be stored at this memory location. In our program, this will be address "03EA." This is the routine in charge of blinking the LEDs. It will be described below. Finally, Port 3 is addressed at memory locations "AC00" and "AC02."

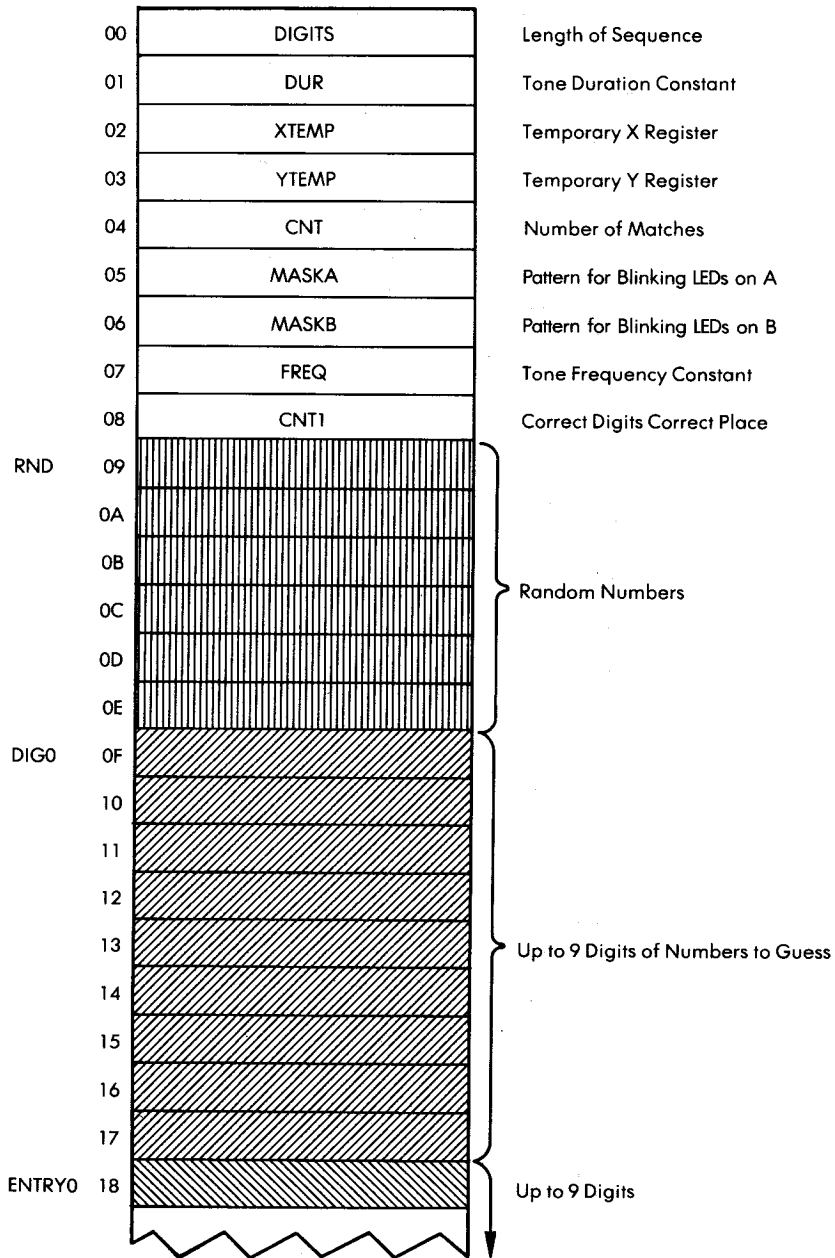
### Program Implementation

A detailed flowchart for the Mindbender program is shown in Figure 9.9. Let us now examine the program itself. (See Figure 9.13.)

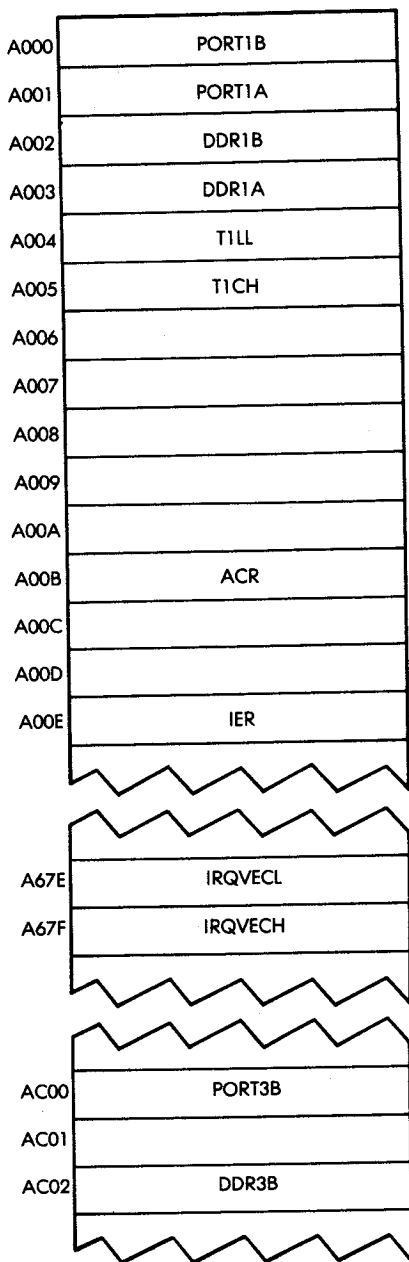
The initialization block resides at memory addresses 0200-0239 hexadecimal and conditions interrupts and I/O. First, interrupts are conditioned. Prior to modifying the interrupt vector which resides at ad-



# ADVANCED 6502 PROGRAMMING



**Fig. 9.6: Low Memory Map**



**Fig. 9.7: High Memory Map**

ADVANCED 6502 PROGRAMMING

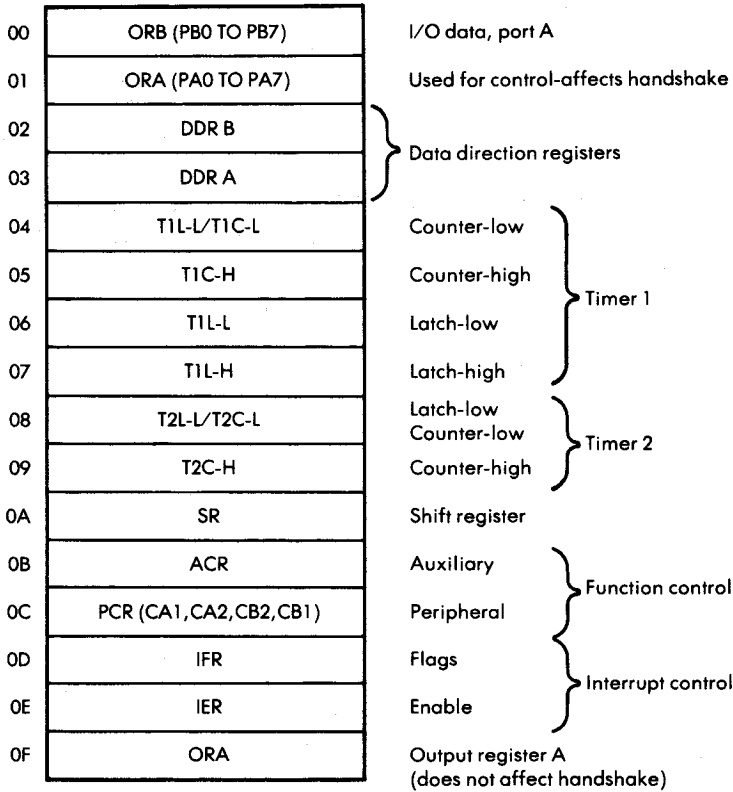


Fig. 9.8: 6522 VIA Memory Map

addresses "A67E" and "A67F" (see Figure 9.7) access to this protected area of memory must be authorized. This is performed by the ACCESS subroutine, which is part of the SYM monitor:

JSR ACCESS

Next, the new interrupt vector can be loaded at the specified location. The value "03EA" is entered at address IRQVEC:

```

LDA #$EA           Low interrupt vector
STA IRQVECL
LDA #$03           High interrupt vector
STA IRQVECH
    
```

Now the internal registers of the 6522 VIA #1 must be conditioned to set up the interrupts. The interrupt-enable register (IER) will enable or disable interrupts. Each bit position in the IER matches the corresponding one in the interrupt flag register (IFR). Whenever a bit position is "0," the corresponding interrupt is disabled. Bit 7 of IER plays a special role. (See Figure 9.10.) When IER bit 7 is "0," each "1" in the remaining bit positions of IER will clear the corresponding enable flag. When IER bit 7 is "1," each "1" written in IER will play its normal role and set an enable. All interrupts are, therefore, disabled by setting bit 7 to "0" and all remaining bits in the IER to ones:

```
LDA #$7F
STA IER
```

Next, bit 6, which corresponds to the timer 1 interrupt, is enabled. In order to do this, bit 7 of IER is set to "1," as is bit 6:

```
LDA #$C0
STA IER
```

Next, timer 1 will be set in the "free-running mode." Remember that, with the 6522, the timer can be used in either the "one-shot" mode or the "free-running mode." Bits 6 and 7 of the auxiliary control register are used to select timer 1 operating modes. (See Figure 9.11.) In this instance, bit 7 is set to "0" and bit 6 is set to "1":

```
LDA #$40
STA ACR
```

Prior to using the timer in the output mode, its counter-register must be loaded with a 16-bit value. This value specifies the duration of the square pulse to be generated. The maximum value "FFFF" is used here:

```
LDA #$FF
STA T1LL
STA T1CH
```

The actual wave form from timer 1 is shown in Figure 9.12. In order to compute the exact duration of the pulse, note that the pulse dura-

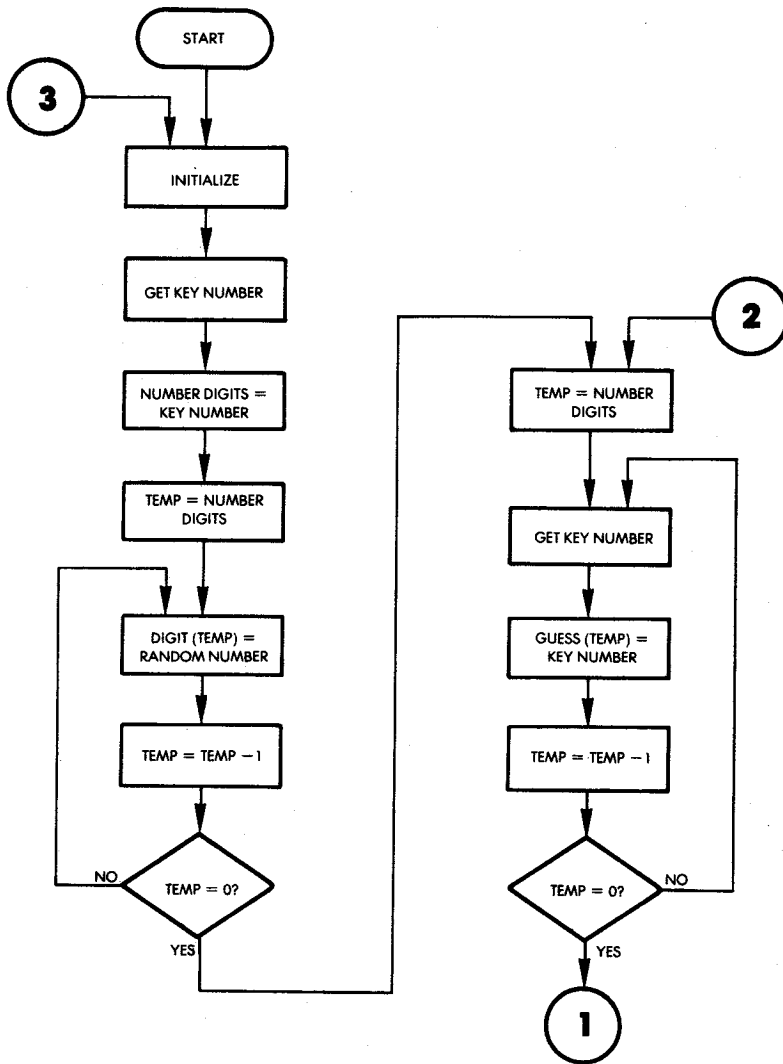


Fig. 9.9: Detailed Mindbender Flowchart

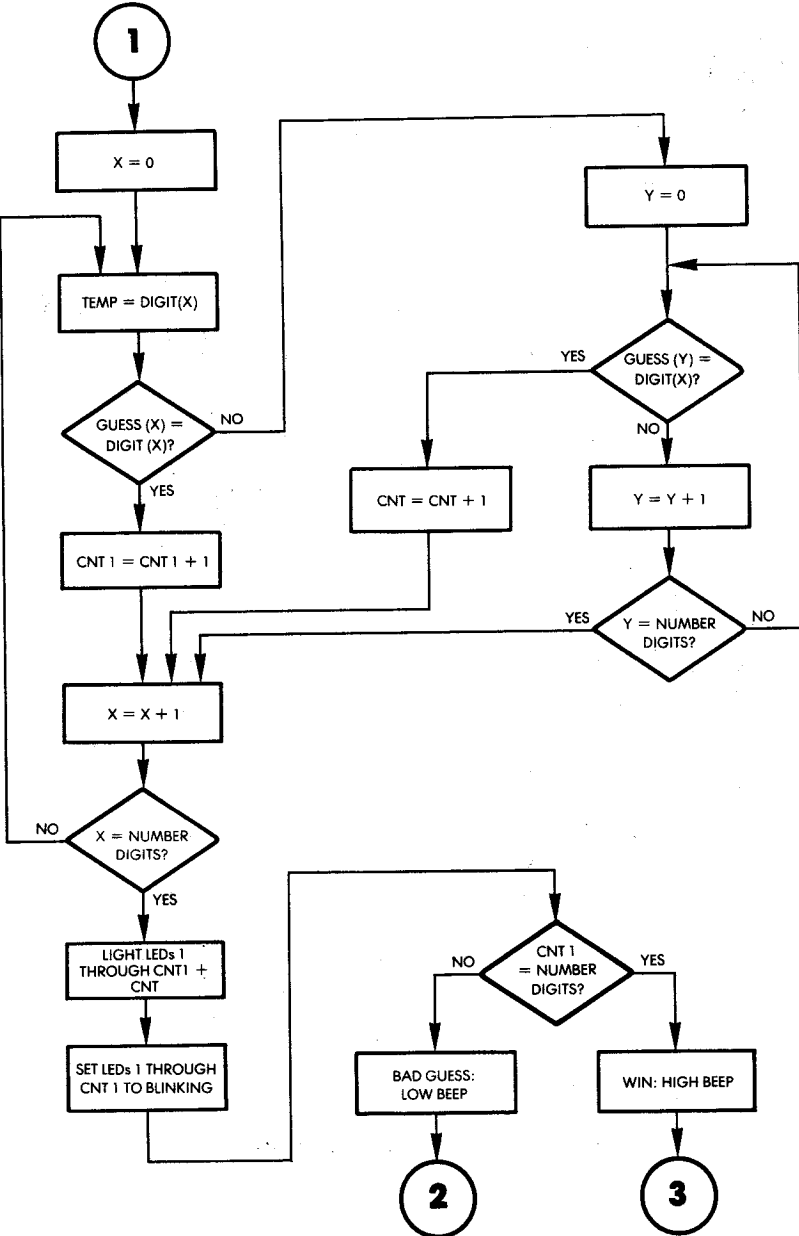
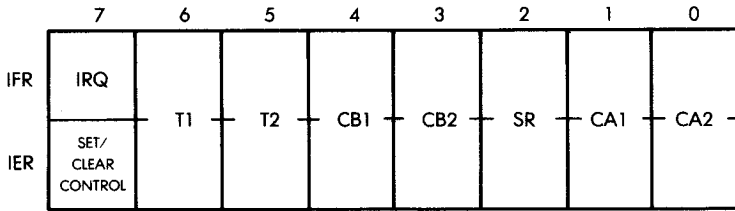


Fig. 9.9: Detailed Mindbender Flowchart (Continued)

ADVANCED 6502 PROGRAMMING



**Fig. 9.10: Interrupt Registers**

tion will alternate between  $n + 1.5$  cycles and  $n + 2$  cycles, where  $n$  is the initial value loaded in the counter register.

Next, interrupts are enabled:

CLI

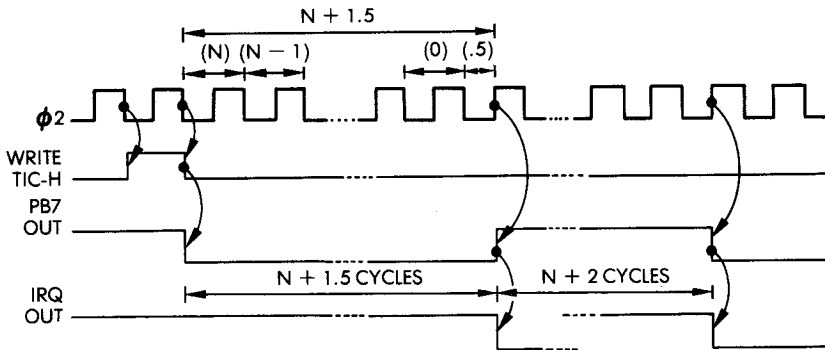
and the three ports used by this program are configured in the appropriate direction:

STA DDR1A      Output  
 STA DDR1B      Output  
 STA DDR3B      Output

All LEDs are then cleared:

ACR7 OUTPUT ENABLE	ACR6 INPUT ENABLE	MODE
0	0 (ONE-SHOT)	GENERATE TIME OUT INT WHEN T1 LOADED PB7 DISABLED
0	1 (FREE RUN)	GENERATE CONTINUOUS INT PB7 DISABLED
1	0 (ONE-SHOT)	GENERATE INT AND OUTPUT PULSE ON PB7 EVERYTIME T1 IS LOADED = ONE-SHOT AND PROGRAMMABLE WIDTH PULSE
1	1 (FREE RUN)	GENERATE CONTINUOUS INT AND SQUARE WAVE OUTPUT ON PB7

**Fig. 9.11: 6522 Auxiliary Control Register Selects Timer 1 Operating Modes**



**Fig. 9.12: Timer 1 in Free Running Mode**

```
KEY1      LDA #0
          STA PORT1A
          STA PORT1B
```

and the blink masks are initially set to all 0's:

```
          STA MASKA
          STA MASKB
```

LED 10 is now turned on in order to signal to the player that he or she should specify the number of digits to be guessed:

```
          LDA #00000010    Select LED 10
          STA PORT1B       Turn it on
```

The key pressed is read using the usual GETKEY routine:

```
          JSR GETKEY       Get # digits
```

A software filter is implemented at this point. The value of the key read from the keyboard is validated as falling within the range "1" through "9." If it is greater than 9, or less than 1, the entry is ignored:

```
          CMP #10
          BPL KEY1
          CMP #0
          BEQ KEY1
```



## ADVANCED 6502 PROGRAMMING

Once validated, the length specified for the sequence is stored at memory location DIGITS:

```
STA DIGITS
```

A sequence of random numbers must now be generated.

### *Generating a Sequence of Random Numbers*

The initial random number is obtained from the counter and used to start the random number generator. The theory behind this technique has been described before.

Locations RND + 1, RND + 4, and RND + 5 are seeded with the same number:

```
LDA TILL
STA RND + 1
STA RND + 4
STA RND + 5
```

Then a random number is obtained using the RANDOM subroutine:

	LDY DIGITS	Get # of digits to guess
	DEY	Count to 0
RAND	JSR RANDOM	Filling them with values

The resulting random number is set to a BCD value which guarantees that the last digit will be between 0 and 9:

```
SED
ADC #00      Decimal Adjust
CLD
```

It is then truncated to the lower 4 bits:

```
AND #$00001111
```

Once the appropriate random digit has been obtained, it is saved at the next location of the digit table, using index register Y as a running pointer:

```
STA DIG0,Y
```

The counter Y is then decremented, and the loop executed until all required digits have been generated:

```
DEY
BPL RAND
```

### *Collecting the Player's Guesses*

Index register X will serve as a running pointer for the ENTRY table used to collect the player's guess. It is initialized to the value "0," and stored at memory location XTEMP:

```
EXTRA      LDA #0           Clear pointer
           STA XTEMP
```

LEDs 10 and 11 are then turned on to signal the player that he or she may enter his or her sequence:

```
LDA #$00000110
STA PORT1B
```

The key pressed by the player is read with the usual GETKEY routine:

```
KEY2      JSR GETKEY
```

If the key pressed is greater than 9, it is interpreted as a request to restart the game:

```
CMP #10
BPL KEY1
```

Otherwise, the value of the index register X is retrieved from memory location XTEMP and is used to perform an indexed store of the accumulator to the appropriate location in the ENTRY table:

```
LDX XTEMP
STA ENTRY0,X   Store guess in table
```

The running pointer is then incremented, and stored back in memory:

## ADVANCED 6502 PROGRAMMING

```
INX
STX XTEMP
```

Then, the value of the running pointer is compared to the maximum number of digits to be fetched from the keyboard and, as long as this number is not reached, a loop occurs back to location KEY2:

```
CPX DIGITS      All numbers fetched?
BNE KEY2        If not, get another
```

Once the player has entered his or her sequence, the digits must be compared to the computer-generated sequence. In anticipation of the display of a possible win the LEDs on the board are blanked and the masks are cleared:

```
LDX #0
STX PORT1A
STX PORT1B
STX MASKA
STX MASKB
```

Two locations in memory will be used to contain the number of correct digits and the number of correct digits in the correct location. They are initially cleared:

```
STX CNT          Number of matches
STX CNT1        Number of correct digits
```

Each entry of the DIG0 table will now be compared in turn to all entries of the ENTRY0 table. Each digit is loaded from the DIGIT table and immediately compared to the corresponding ENTRY contents:

```
DIGLP          LDA DIG0,X
                CMP ENTRY0,X
```

If it is not the right digit at the right place, there is no exact match. We will then check to see if the digit appears at any other place within the ENTRY table:

```
BNE ENTRYCMP
```

Otherwise, one more exact match is recorded by incrementing location CNT1, and the next digit is examined:

```

INC CNT1
BNE NEXTDIG
    
```

Let us examine now what happens when no match has occurred. The digit (of the number to be guessed) which has just been read and is contained in the accumulator should be compared to every digit within the ENTRY table. Index register Y is used as a running pointer, and the contents of the accumulator are compared in turn to each of the digits in ENTRY:

```

ENTRYCMP LDY #0
ENTRYLP  CMP ENTRY0,Y
          BNE NEXTENT
    
```

If a match is found, memory location CNT is incremented and the next digit is examined:

```

INC CNT
BNE NEXTDIG
    
```

Otherwise, index register Y is incremented. If the end of the sequence is reached, exit occurs to NEXTDIG. Otherwise a branch back occurs to the beginning of the loop at location ENTRYLP:

```

NEXTENT  INY           Increment guess # pointer
          CPY DIGITS   All tested?
          BNE ENTRYLP  No: try next one
    
```

The next digit in table DIG must then be examined. The running pointer for DIG is contained in index register X. It is incremented and compared to its maximum value:

```

NEXTDIG  INX           Increment digit # pointer
          CPX DIGITS   All digits checked
    
```

If the limit has not been reached, a branch occurs back to the beginning of the outer loop at location DIGLP:

BNE DIGLP

At this point, we are ready to turn on the LEDs to display the results to the player.

*Displaying the Results to the Player*

The total number of LEDs which must be turned on is obtained by adding the contents of CNT to CNT1:

```
CLC           Get ready for add
LDA CNT
ADC CNT1
```

The total is contained in the accumulator and transferred into index register Y where it will be used by the LITE routine:

```
TAY
JSR LITE
```

The operation of the LITE routine will be described below. Its effect is to fill the accumulator with the appropriate number of ones in order to turn on the appropriate LEDs.

The pattern created by the LITE subroutine is then stored in the mask:

```
STA PORT1A
```

For the special case in which the result is 9, the carry bit will have been set. This case is explicitly tested:

```
BCC CC       If carry 0, don't light PB0.
```

and if the carry had been set to 1, Port B will be set appropriately so that LED #9 is turned on:

```
LDA #1       Turn PB0 on
STA PORT1B
```

Recall that once masks A and B have been set up, they will automatically be used by the interrupt handling routine which will

cause the appropriate LEDs to blink.

```
CC      LDY CNT1
        JSR LITE
        STA MASKA
        BCC TEST
        LDA #01
        STA MASKB
```

The program must now test for a win or lose situation.

*Testing for a Win or Lose Situation*

The number of correct digits in the right places is contained in CNT1. We will simply compare it to the length of the sequence to be guessed:

```
TEST    LDX CNT1
        CPX DIGITS
```

If these numbers are equal, the player has won:

```
BEQ WIN
```

Otherwise, a low tone will be sounded. The tone duration constant is set to "72," and its frequency value to "BE":

```
BAD     LDA #$72
        STA DUR
        LDA #$BE
```

The TONE subroutine is then used to generate the tone, as usual:

```
JSR TONE
```

Then a return occurs to the beginning of the program:

```
BEQ ENTER
```

If a win has occurred, a high-pitched tone will be generated. Its duration constant is set to "FF" and its pitch is controlled by setting the

## ADVANCED 6502 PROGRAMMING

frequency constant to “54”:

```
WIN      LDA #$FF
          STA DUR
          LDA #$54
```

As usual, the TONE subroutine is used to generate the tone:

```
JSR TONE
```

The game is then restarted:

```
JMP KEY1
```

### The Subroutines

Four routines are used by this program. They are: LITE, RANDOM, TONE, and INTERRUPT HANDLER. The RANDOM and TONE routines have been described in previous chapters and will not be described again here.

#### *LITE Subroutine*

When entering this subroutine, index register Y contains the number of LEDs which should blink. In order to make them blink it is necessary to load the appropriate pattern into the mask patterns called MASKA and MASKB. The appropriate number of 1's has to be set in these two locations. A test is first made for the value “0” in Y. If that value is found, the accumulator is cleared, as well as the carry bit (the carry bit will be used as an indicator for the fact that Y contained the value “9”):

```
LITE      BNE STRTSH      Test Y for zero
          LDA #0
          CLC
          RTS
```

Otherwise, the accumulator is initially cleared, and the appropriate number of 1's is shifted left into the accumulator through the carry bit. They are introduced one at a time by setting the carry bit, then performing a left shift into A. Each time, index register Y is decremented and the loop is executed again as long as Y is not “0”:

	LDA #0	
SHIFT	SEC	
	ROL A	Shift into position
	DEY	
	BNE SHIFT	Loop
	RTS	

Note that a rotation to the left is used rather than a shift. If Y did contain the value "9," the accumulator A would be filled with 1's and the carry bit would also contain the value "1" upon leaving the subroutine.

### *The Interrupt Handler*

This subroutine complements the LEDs each time an interrupt is received, i.e., every time timer 1 runs out. It is located at memory addresses "03EA" and following. Since the accumulator is used as a working register by the subroutine, it must be preserved upon entry and pushed into the stack:

PHA

The contents of Ports 1A and 1B will be read and then complemented. Recall that there is no complementation instruction on the 6502, so an exclusive OR will be used instead. MASKA and MASKB specify the bits to be complemented:

```
LDA PORT1A
EOR MASKA
STA PORT1A
LDA PORT1B
EOR MASKB
STA PORT1B
```

Also recall that the interrupt bit in the 6522 has to be cleared explicitly after every interrupt. This is done by reading the latch:

LDA TILL

Finally, the accumulator is restored, and a return occurs to the main program:



PLA  
RTI

SUMMARY

In this program, we have used two new hardware resources in the 6522 I/O chip: the interrupt control and the programmable interval timer. Interrupts have been used to implement simultaneous processing by blinking the LEDs while the program proceeds, testing for a win or lose situation.

**Exercise 9.1:** *Could you implement the same without using interrupts?*

```

;MINDBENDER PROGRAM
;PLAYS MINDBENDER GAME: USER SPECIFIES LENGTH OF NUMBER
;TO BE GUESSED, THEN GUESSES DIGITS, AND COMPUTER TELLS
;PLAYER HOW MANY OF THE DIGITS GUESSED WERE RIGHT, AND
;HOW MANY OF THOSE CORRECT DIGITS WERE IN THE CORRECT
;PLACE, UNTIL THE PLAYER CAN GUESS THE NUMBER. ON THE
;BOARD, BLINKING LEDES INDICATE CORRECT VALUE & CORRECT
;DIGIT, AND NONBLINKING LEDES SHOW CORRECT DIGIT VALUE,
;BUT WRONG PLACE.
;THE BOTTOM ROW OF LEDES IS USED TO SHOW THE MODE OF
;THE PROGRAM: IF THE LEFTMOST LED IS LIT, THE
;PROGRAM EXPECTS THE USER TO ENTER THE LENGTH
;OF THE NUMBER TO BE GUESSED. IF THE TWO LEFTMOST
;LEDES ARE LIT, THE PROGRAM EXPECTS A GUESS.
;THE PROGRAM REJECTS UNSUITABLE VALUES FOR A NUMBER
;LENGTH, WHICH CAN ONLY BE 1-9. A VALUE OTHER THAN
;0-9 FOR A GUESS RESTARTS THE GAME.
;A LOW TONE DENOTES A BAD GUESS, A HIGHT TONE, A WIN.
;AFTER A WIN, THE PROGRAM RESTARTS.
;AN INTERRUPT ROUTINE IS USED TO BLINK THE LEDES.
;
;
;.=200
GETKEY      = $100
ACCESS     = $BB86      ;ROUTINE TO UNPROTECT SYS MEM
DIGITS     = $00        ;NUMBER OF DIGITS TO BE GUESSED
DUR        = $01        ;TONE DURATION CONSTANT
XTEMP      = $02        ;TEMP STORAGE FOR X REG.
YTEMP      = $03        ;TEMP STORAGE FOR Y REG.
CNT        = $04        ;KEEPS TRACK OF # OF MATCHES
MASKA      = $05        ;CONTAINS PATTERN EOR'ED WITH LED
                    ;STATUS REGISTER A TO CAUSE BLINK
MASKB      = $06        ;LED PORT B BLINK MASK
FREQ       = $07        ;TEMP STORAGE FOR TONE FREQUENCY
CNT1       = $08        ;# OF CORRECT DIGITS IN RIGHT PLAC
RND        = $09        ;FIRST OF RANDOM # LOCATIONS
DIGO       = $0F        ;FIRST OF 9 DIGIT LOCATIONS
ENTRYO     = $18        ;FIRST OF 9 GUESS LOCATIONS
IRQVECL    = $A67E      ;INTERRUPT VECTOR LOW ORDER BYTE
IRQVECH    = $A67F      ;..AND HIGH ORDER
                    ;6522 VIA #1 REGISTERS:

```

Fig. 9.13: Mindbender Program

```

IER      =%A00E      ;INTERRUPT ENABLE REGISTER
ACR      =%A00B      ;AUXILIARY CONTROL REGISTER
TILL     =%A004      ;TIMER 1 LATCH LOW
T1CH     =%A005      ;TIMER 1 COUNTER HIGH
PORT1A   =%A001      ;VIA 1 PORT A IN/OUT REG
DDR1A    =%A003      ;VIA 1 PORT A DATA DIRECTION REG.
PORT1B   =%A000      ;VIA 1 PORT B IN/OUT REG
DDR1B    =%A002      ;VIA 1 PORT B DATA DIRECTION REG.
PORT3B   =%AC00      ;VIA 3 PORT B IN/OUT REG
DDR3B    =%AC02      ;VIA 3 PORT B DATA DIRECTION REG
;
;ROUTINE TO SET UP VARIABLES AND INTERRUPT TIMER FOR
;L.E.D. FLASHING
;
0200: 20 86 8B      JSR ACCESS      ;UNPROTECT SYSTEM MEMORY
0203: A9 EA        LDA #$EA        ;LOAD LOW INTERRUPT VECTOR
0205: 8D 7E A6     STA IRQVECL     ;...AND STORE AT VECTOR LOCATION
0208: A9 03        LDA #$03        ;LOAD INTERRUPT VECTOR...
020A: 8D 7F A6     STA IRQVECH     ;...AND STORE.
020D: A9 7F        LDA #$7F        ;CLEAR INTERRUPT ENABLE REGISTER
020F: 8D 0E A0     STA IER        ;
0212: A9 C0        LDA #$C0        ;ENABLE TIMER 1 INTERRUPT
0214: 8D 0E A0     STA IER        ;
0217: A9 40        LDA #$40        ;ENABLE TIMER 1 IN FREE-RUN MODE
0219: 8D 0B A0     STA ACR        ;
021C: A9 FF        LDA #$FF        ;
021E: 8D 04 A0     STA TILL       ;SET LOW LATCH ON TIMER 1
0221: 8D 05 A0     STA T1CH       ;SET LATCH HIGH & START COUNT
0224: 58           CLI           ;ENABLE INTERRUPTS
0225: 8D 03 A0     STA DDR1A      ;SET VIA 1 PORT A FOR OUTPUT
0228: 8D 02 A0     STA DDR1B      ;SET VIA 1 PORT B FOR OUTPUT
022B: 8D 02 AC     STA DDR3B      ;SET VIA 3 PORT B FOR OUTPUT
022E: A9 00        LDA #0          ;CLEAR LEDS
0230: 8D 01 A0     STA PORT1A     ;
0233: 8D 00 A0     STA PORT1B     ;
0236: 85 05        STA MASKA     ;CLEAR BLINK MASKS
0238: 85 06        STA MASKB     ;
;
;ROUTINE TO GET NUMBER OF DIGITS TO GUESS, THEN
;FILL THE DIGITS WITH RANDOM NUMBERS FROM 0-9
;
023A: A9 02        LDA #200000010 ;LIGHT LED TO SIGNAL USER TO
023C: 8D 00 A0     STA PORT1B     ;INPUT OF # OF DIGITS NEEDED.
023F: 20 00 01     JSR GETKEY    ;GET # OF DIGITS
0242: C9 0A        CMP #10       ;IF KEY# >9, RESTART GAME
0244: 10 E8        BPL KEY1
0246: C9 00        CMP #0        ;CHECK FOR 0 DIGITS TO GUESS
0248: F0 E4        BEQ KEY1     ;...0 DIGITS NOT ALLOWED
024A: 85 00        STA DIGITS    ;STORE VALID # OF DIGITS
024C: AD 04 A0     LDA TILL     ;GET RANDOM #
024F: 85 0A        STA RND+1    ;USE IT TO START RANDOM
0251: 85 0D        STA RND+4    ;NUMBER GENERATOR.
0253: 85 0E        STA RND+5
0255: A4 00        LDY DIGITS    ;GET # OF DIGITS TO BE GUESSED,
0257: 88           DEY           ;..AND COUNT TO 0, FILLING
;                           ;THEM WITH VALUES.
0258: 20 FF 02     RAND   JSR RANDOM    ;GET RANDOM VALUE FOR DIGIT
025B: F8           SED
025C: 69 00        ADC #00     ;DECIMAL ADJUST
025E: D8           CLD
025F: 29 0F        AND #200001111 ;KEEP DIGIT <10
0261: 99 0F 00     STA DIG0,Y    ;SAVE IT IN DIGIT TABLE.
0264: 88           DEY
0265: 10 F1        BPL RAND     ;FILL NEXT DIGIT
;

```

Fig. 9.13: Mindbender Program (Continued)

# ADVANCED 6502 PROGRAMMING

```

;ROUTINE TO FILL GUESS TABLE W/USERS'S GUESSES
;
0267: A9 00 ENTER LDA #0 ;CLEAR ENTRY TABLE POINTER
0269: B5 02 STA XTEMP
026B: A9 06 LDA #X00000110 ;LET USER KNOW THAT GUESSES
026D: 0D 00 A0 ORA PORT1B ;SHOULD BE INPUT...
0270: 8D 00 A0 STA PORT1B ;...WITHOUT CHANGING ARRAY
0273: 20 00 01 KEY2 JSR GETKEY ;GET GUESS
0276: C9 0A CMP #10 ;IS IT GREATER THAN 9?
0278: 10 B4 BPL KEY1 ;IF YES, RESTART GAME
027A: A6 02 LDX XTEMP ;GET POINTER FOR INDEXING
027C: 95 18 STA ENTRY0,X ;STORE GUESS IN TABLE
027E: E8 INX ;INCREMENT POINTER
027F: B6 02 STX XTEMP
0281: E4 00 CPX DIGITS ;CORRECT # OF GUESSES FETCHED?
0283: D0 EE BNE KEY2 ;IF NOT, GET ANOTHER
;
;THIS ROUTINE COMPARES USERS'S GUESSES WITH DIGITS
;OF NUMBER TO GUESS. FOR EACH CORRECT DIGIT IN THE
;CORRECT PLACE, A BLINKING LED IS LIT, AND FOR EACH
;CORRECT DIGIT IN THE WRONG PLACE, A NONBLINKING
;LED IS LIT.
;
0285: A2 00 LDX #0 ;CLEAR FOLLOWING STORAGES:
0287: 8E 01 A0 STX PORT1A ;LEDS
028A: 8E 00 A0 STX PORT1B
028D: B6 05 STX MASKA ;BLINK MASKS
028F: B6 06 STX MASKB
0291: B6 04 STX CNT ;COUNT OF MATCHES
0293: B6 08 STX CNT1 ;COUNT OF RIGHT DIGITS
0295: B5 0F DIGLP LDA DIG0,X ;LOAD 1ST DIGIT OF # FOR COMPARES
0297: D5 18 CMP ENTRY0,X ;RIGHT GUESS/RIGHT PLACE?
0299: D0 04 BNE ENTRYCMP ;NO: IS GUESS RIGHT DIGIT/
;WRONG PLACE?
029B: E6 08 INC CNT1 ;ONE MORE RIGHT GUESS/RIGHT PLACE
029D: D0 10 BNE NEXTDIG ;EXAMINE NEXT DIGIT OF NUMBER
029F: A0 00 ENTRYCMP LDY #0 ;RESET GUESS# PTR FOR COMPARES
02A1: D9 18 00 ENTRYLP CMP ENTRY0,Y ;RIGHT DIGIT/WRONG PLACE?
02A4: D0 04 BNE NEXTENT ;NO, SEE IF NEXT DIGIT IS.
02A6: E6 04 INC CNT ;ONE MORE RIGHT DIGIT/WRONG PLACE
02A8: D0 05 BNE NEXTDIG ;EXAMINE NEXT DIGIT OF NUMBER
02AA: C8 NEXTENT INY ;INCREMENT GUESS# PTR
02AB: C4 00 CPY DIGITS ;ALL GUESSES TESTED?
02AD: D0 F2 BNE ENTRYLP ;NO, TRY NEXT GUESS.
02AF: E8 NEXTDIG INX ;INCREMENT DIGIT# PTR
02B0: E4 00 CPX DIGITS ;ALL DIGITS EVALUATED?
02B2: D0 E1 BNE DIGLP ;NO, CHECK NEXT DIGIT.
02B4: 18 CLC ;GET READY FOR ADD....
02B5: A5 04 LDA CNT ;OF TOTAL MATCHES TO DETERMINE
02B7: 65 08 ADC CNT1 ;NUMBER OF LEDS TO LIGHT
02B9: A8 TAY ;XFER A TO Y FOR 'LIGHT' ROUTINE
02BA: 20 F1 02 JSR LITE ;GET PATTERN TO LIGHT LEDS
02BD: 8D 01 A0 STA PORT1A ;TURN LEDS ON
02C0: 90 05 BCC CC ;IF CARRY=0, DON'T LIGHT PBO
02C2: A9 01 LDA #1
02C4: 8D 00 A0 STA PORT1B ;TURN PBO ON.
02C7: A4 08 LDY CNT1 ;LOAD # OF LEDS TO BLINK
02C9: 20 F1 02 CC JSR LITE ;GET PATTERN
02CC: B5 05 STA MASKA ;START TO BLINK LEDS
02CE: 90 04 BCC TEST ;IF CARRY =0, PBO WON'T BLINK
02D0: A9 01 LDA #1
02D2: B5 06 STA MASKB
;
;ROUTINE TO TEST FOR WIN BY CHECKING IF # OF CORRECT

```

Fig. 9.13: Mindbender Program (Continued)

```

;DIGITS IN CORRECT PLACES = NUMBER OF DIGITS, IF WIN,
;A HIGH PITCHED SOUND IS GENERATED, AND IF ANY
;DIGIT IS WRONG, A LOW SOUND IS GENERATED.
;
02D4: A6 0B      TEST      LDX CNT1 LOAD NUMBER OF CORRECT DIGITS
02D6: E4 00      CPX DIGITS  ;ALL GUESSES CORRECT?
02D8: F0 0B      BEQ WIN    ;IF YES, PLAYER WINS
02DA: A9 72      BAD      LDA #$72
02DC: 85 01      STA DUR    ;SET UP LENGTH OF LOW TONE
02DE: A9 BE      LDA #$BE    ;TONE VALUE FOR LOW TONE
02E0: 20 12 03   JSR TONE   ;SIGNAL BAD GUESSES W/TONE
02E3: F0 82      BEQ ENTER  ;GET NEXT GUESSES
02E5: A9 FF      WIN      LDA #$FF    ;DURATION FOR HIGH TONE
02E7: 85 01      STA DUR
02E9: A9 54      LDA #$54    ;TONE VALUE FOR HIGH TONE
02EB: 20 12 03   JSR TONE   ;SIGNAL WIN
02EE: 4C 2E 02   JMP KEY1   ;RESTART GAME

;
;ROUTINE TO FILL ACCUMULATOR WITH '1' BITS, STARTING
;AT THE LOW ORDER END, UP TO AND INCLUDING THE
;BIT POSITION CORRESPONDING TO THE # OF LEDS TO
;BE LIT OR SET TO BLINKING.
;
02F1: D0 04      LITE     BNE STRTSH ;IF Y NOT ZERO, SHIFT ONES IN
02F3: A9 00      LDA #0     ;SPECIAL CASE: RESULT IS NO ONES.
02F5: 18        CLC
02F6: 60        RTS
02F7: A9 00      STRTSH   LDA #0     ;CLEAR A SO PATTERN WILL SHOW
02F9: 38        SHIFT   SEC       ;MAKE A BIT HIGH
02FA: 2A        ROL A    ;SHIFT IT TO CORRECT POSITION
02FB: 88        DEY      ;BY LOOPING TO # OF GUESS/DIGIT
                                ;MATCHES, AS PASSED IN Y
02FC: D0 FB      BNE SHIFT  ;LOOP 'TIL DONE
02FE: 60        RTS

;
;RANDOM NUMBER GENERATOR
;USES NUMBERS A,B,C,D,E,F STORED AS RND THROUGH
;RND+5: ADDS B+E+1 AND PLACES RESULT IN A, THEN
;SHIFTS A TO B, B TO C, ETC. THE NEW RANDOM NUMBER
;WHICH IS BETWEEN 0 AND 255 INCLUSIVE IS IN THE
;ACCUMULATOR ON EXIT
;
02FF: 38        RANDOM   SEC       ;CARRY ADDS VALUE 1
0300: A5 0A      LDA RND+1  ;ADD A,B,E AND CARRY
0302: 65 0D      ADC RND+4
0304: 65 0E      ADC RND+5
0306: 85 09      STA RND
0308: A2 04      LDX #4     ;SHIFT NUMBERS OVER
030A: B5 09      RPL      LDA RND,X
030C: 95 0A      STA RND+1,X
030E: CA        DEX
030F: 10 F9      BPL RPL
0311: 60        RTS

;
;TONE GENERATOR ROUTINE.
;DURATION OF TONE (NUMBER OF CYCLES TO CREATE)
;SHOULD BE IN 'DUR' ON ENTRY, AND THE NOTE VALUE
;(FREQUENCY) IN THE ACCUMULATOR.
;
0312: 85 07      TONE     STA FREQ
0314: A9 FF      LDA #$FF
0316: 8D 00 AC   STA PORT3B
0319: A9 00      LDA #$00
031B: A6 01      LDX DUR
031D: A4 07      FL2     LDY FREQ

```

Fig. 9.13: Mindbender Program (Continued)

# ADVANCED 6502 PROGRAMMING

```

031F: 88      FL1    DEY
0320: 18      CLC
0321: 90 00    BCC .+2
0323: D0 FA    BNE FL1
0325: 49 FF    EOR #$FF
0327: 8D 00 AC STA PORT3B
032A: CA      DEX
032B: D0 F0    BNE FL2
032D: 60      RTS

;
; INTERRUPT-HANDLING ROUTINE
; COMPLEMENTS LEDS AT EACH INTERRUPT
;
      = $3EA    ;LOCATE ROUTINE IN HIGH MEMORY
03EA: 48      PHA      ;SAVE ACCUMULATOR
03EB: AD 01 A0 LDA PORT1A ;GET PORT FOR COMPLEMENTING
03EE: 45 05    EOR MASKA ;COMPLEMENT NECESSARY BITS
03F0: 8D 01 A0 STA PORT1A ;STORE COMPLEMENTED CONTENTS
03F3: AD 00 A0 LDA PORT1B ;DO SAME WITH PORT1B
03F6: 45 06    EOR MASKB
03F8: 8D 00 A0 STA PORT1B
03FB: AD 04 A0 LDA TILL   ;CLEAR INTERRUPT BIT IN VIA
03FE: 68      PLA      ;RESTORE ACCUMULATOR
03FF: 40      RTI      ;DONE, RESUME PROGRAM

SYMBOL TABLE:
GETKEY    0100    ACCESS    8BB6    DIGITS    0000
DUR       0001    XTEMP    0002    YTEMP    0003
CNT       0004    MASKA    0005    MASKB    0006
FREQ      0007    CNT1     0008    RND      0009
DIG0      000F    ENTRY0   0018    IRQVECL  A67E
IRQVECH   A67F    IER      A00E    ACR      A00B
TILL      A004    T1CH     A005    PORT1A   A001
DDR1A     A003    PORT1B   A000    DDR1B    A002
PORT3B    AC00    DDR3B    AC02    KEY1     022E
RAND      0258    ENTER    0267    KEY2     0273
BIGLP     0295    ENTRYCMP 029F    ENTRYLP  02A1
NEXTENT   02AA    NEXTDIG  02AF    CC       02C7
TEST      02D4    BAD      02DA    WIN      02E5
LITE      02F1    STRTSH   02F7    SHIFT    02F9
RANDOM     02FF    RPL      030A    TONE     0312
FL2       031D    FL1      031F
DONE

```

**Fig. 9.13: Mindbender Program (Continued)**

## **10. Complex Evaluation Technique (Blackjack)**

### **INTRODUCTION**

This problem involves a complex evaluation in a simple input/output environment and a very small amount of memory. The program generates light and sound effects and operates in real time.

### **THE RULES**

The standard game of Blackjack or "21," is played in the following way. A player attempts to beat the dealer by acquiring cards which, when their face values are added together, total more points than those in the dealer's hand but not more than a maximum of 21 points. If at any time the total of 21 is achieved after only two cards are played, a win is automatically declared for the player; this is called a Blackjack (the name of the game). Card values range from 1 through 11. In the standard version of Blackjack the house rules require the dealer to "hit" (take a card) if his/her hand equals 16 or fewer points, but prohibits him/her from taking a "hit" when his or her hand totals 17 or more points.

The version of Blackjack played on the Games Board differs slightly from the standard game of Blackjack. The single "deck of cards" used here contains cards with values from 1 through 10 (rather than 1 through 11), and the number of points cannot exceed 13 (as opposed to 21). The dealer in this variation of the game is the computer.

At the beginning of each hand, one card is dealt to the dealer and one to the player. A steady LED on the Games Board represents the value of the card dealt to the dealer (the computer). A flashing LED represents the card dealt to the player. If the player wants to be "hit" (i.e., receive another card) he/she must press key "C." The player may hit several times. However, if the total of the player's cards ever exceeds 13, the player has lost the round ("busted") and he/she can no longer play. It is then the dealer's turn. Similarly, if the player decides to pass ("stay"), it becomes the dealer's turn. The dealer plays in the following manner: if the dealer's hand totals fewer than 10

points, the computer deals itself one more card. As long as the hand does not exceed 13, the computer will check to see if it needs another card. Like the situation with the player, once the total of the computer's cards exceeds 13, it loses. No provision has been made for a bonus or an automatic win, which occurs whenever the player or the dealer gets exactly 13 points with only two cards (a Blackjack). This is left as an exercise for the reader. Once the dealer finishes its turn, assuming that it does not bust, the values of both hands are compared. If the dealer's total is greater than the player's, the player loses. Otherwise, the player wins. At the beginning of each series the player is allocated 5 chips (5 points). Each loss decreases this total by one chip; each win increases it by one. The game is over when the player goes broke and loses, or reaches a score of 10 and wins. After each play the resulting score is displayed as a number between 0 and 10 on the appropriate LED. Each time a player wins a hand, the left-most three LEDs of the bottom row light up. If the dealer wins the hand, the right-most three LEDs light up. (See Figure 10.1.)

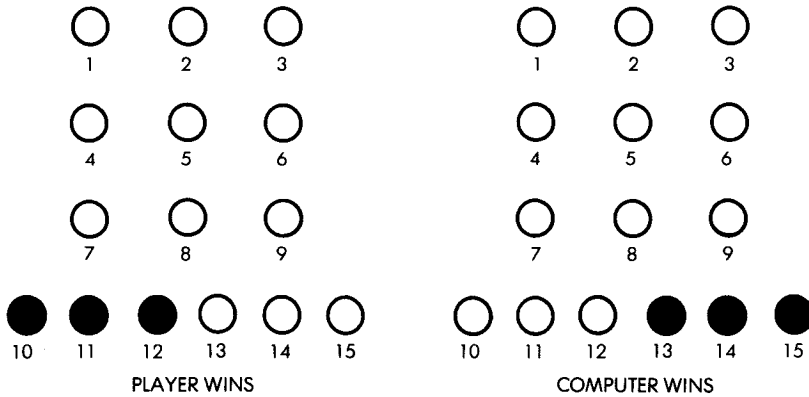


Fig. 10.1: Indicating the Winner

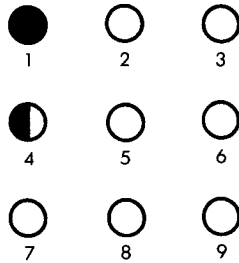
### A TYPICAL GAME

When playing a game against the dealer, the player will press key "A" to be "hit" (receive an additional card) until either a total of 13 is exceeded (a "bust"), or until the player decides that his or her total is close enough to 13 that he or she might beat the dealer. When the player makes this decision to stay, he or she must press key "C." This will start the dealer's turn, and all other keys will then be ignored.

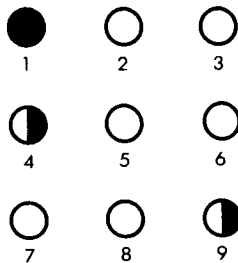
LEDs will light up in succession on the board as the computer deals itself additional cards until it goes over ten, reaches 13 exactly, or busts. Once the computer has stopped playing, any key may be pressed; the player's score will be displayed and the winner will be indicated through lit LEDs on the winner's side. The display will appear for approximately one second, then a new hand will be dealt.

Note that once the value of the computer's hand has reached a total greater than or equal to 10, it will do nothing further until a key is pressed. Let us follow this "typical game."

The initial display is shown in Figure 10.2. A steady LED is shown as a black dot, while a blinking LED is shown as a half dot. In the initial hand the computer has dealt itself a 1 and the player a 4. The player presses key "A" and receives an additional card. It is a 9. The situation is shown in Figure 10.3. It's a Blackjack and the player has won. The best the dealer can hope for at this point is to also reach 13.



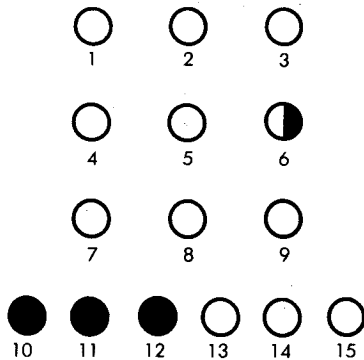
**Fig. 10.2: First Hand**



**Fig. 10.3: Player Receives A Second Card: Blackjack**



Let us examine its response. To do this we must pass by hitting "C." A moment later LED #3 lights up. The total of the computer's hand now is  $1 + 3 = 4$ . It will deal itself another card. A moment later, LED #7 lights up. The computer's total is now  $4 + 7 = 11$ . It stops. Having a lower total than the player, it has lost. Let us verify it. We press any key on the keyboard (for example, "0"). The result appears on the display: LEDs 10, 11 and 12 light up indicating a player win, and LED #6 lights up, indicating that the player's score has been increase from 5 to 6 points. This information is shown in Figure 10.4. The



**Fig. 10.4: End of Turn: Dealer Loses**

LED display then goes blank and a new hand is displayed. When there is a draw, none of the LEDs in the bottom row light up and the score is not changed. A new hand is dealt. (If the player busts, the dealer wins immediately and a computer win is displayed.)

Let us play one more game. At the beginning of this hand the computer has dealt itself a 5, and the player has a 6. The situation is shown in Figure 10.5. Let us ask for another card. We hit key "A" and are given a 7. This is almost unbelievable. We have thirteen again!! The situation is shown in Figure 10.6 It is now the computer's turn. Let us hit "C." LED #10 lights up. The computer has 15. It has busted. The situation is shown in Figure 10.7. Let us verify it. We press any key on the keyboard. The three left-most LEDs on the bottom row (LED 10, 11, and 12) light up and a score of 7 is displayed. This is shown in Figure 10.8. A moment later the display goes blank and a new hand is started.

COMPLEX EVALUATION TECHNIQUE

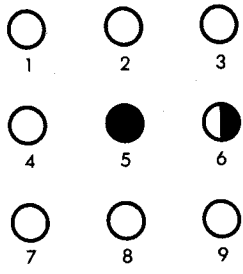


Fig. 10.5: Second Hand

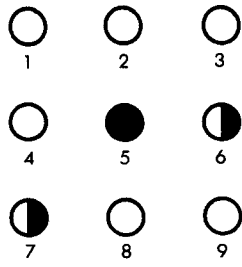


Fig. 10.6: Blackjack Again

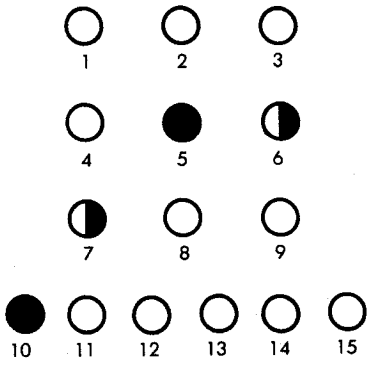
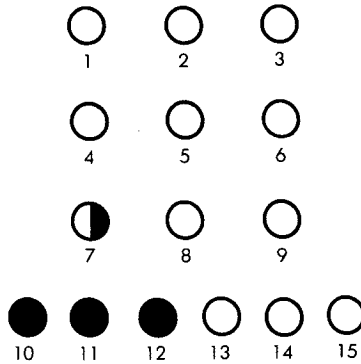


Fig. 10.7: Dealer Busts



**Fig. 10.8: Final Score Is 7**

**THE PROGRAM**

The detailed flowchart for the Blackjack program is shown in Figure 10.9, and the program is listed at the end of the chapter. As usual, a portion of page 0 has been reserved for the variables and flags which cannot be held in the internal registers of the 6502. This area is shown in Figure 10.10 as a “memory map.” These variables or flags are:

**DONE:** This flag is set to the value “0” at the beginning of the game. If the player goes broke, it will be set to the value “11111111.” If the player scores 10 (the maximum), it will be set to the value “1.” This flag will be tested at the end of the game by the ENDER routine which will display the final result of the game on the board and light up either a solid row of LEDs or a blinking square.

**CHIPS:** This variable is used to store the player’s score. It is initially set to the value “5.” Every time the player wins a hand it will be incremented by 1. Likewise, every time the player loses a hand, it will be decremented by 1. The game terminates whenever this variable reaches the value “0” or the value “10.”

**MASKA, MASKB:** These two variables are used to hold the masks or patterns used to blink the LEDs connected respectively to Port A and Port B on the Games Board.

**PHAND:** It holds the current hand total for the player. It is incremented every time the player hits (i.e., requests an additional card) card).

**CHAND:** This variable holds the current hand total for the computer (the dealer).

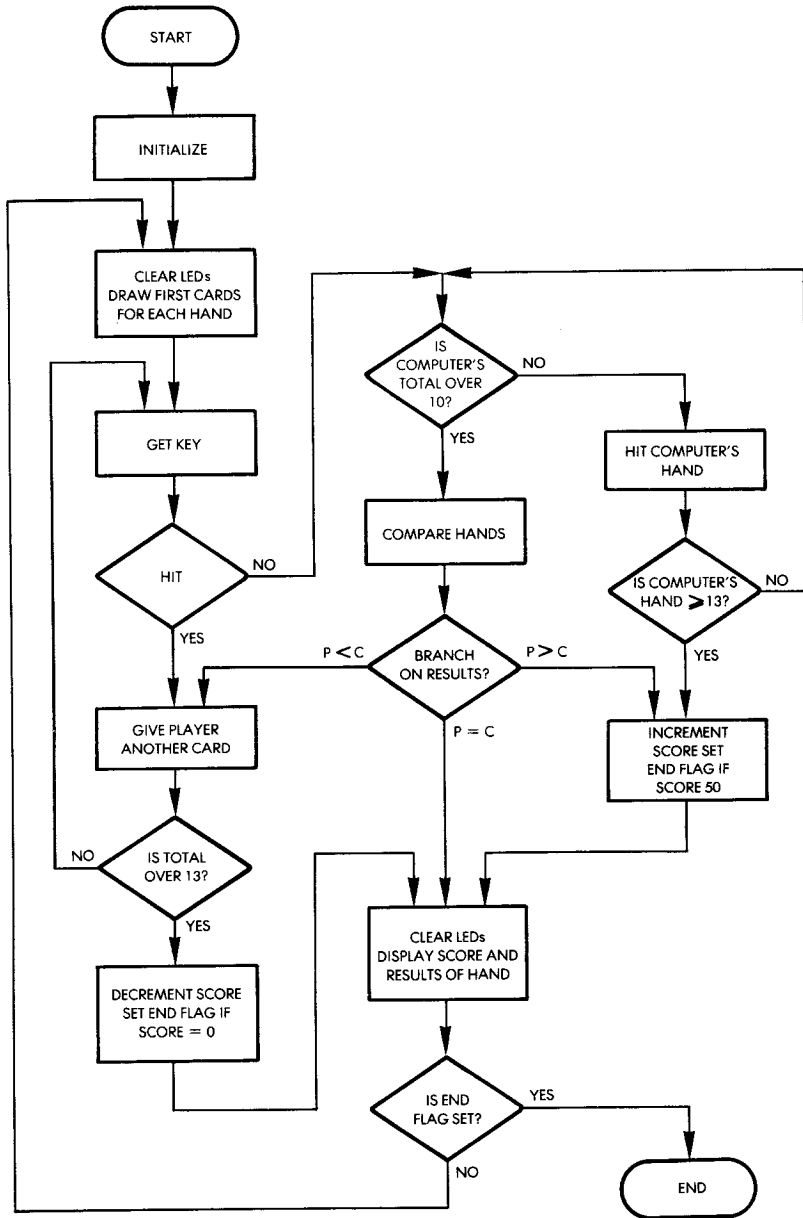


Fig. 10.9: Blackjack Flowchart

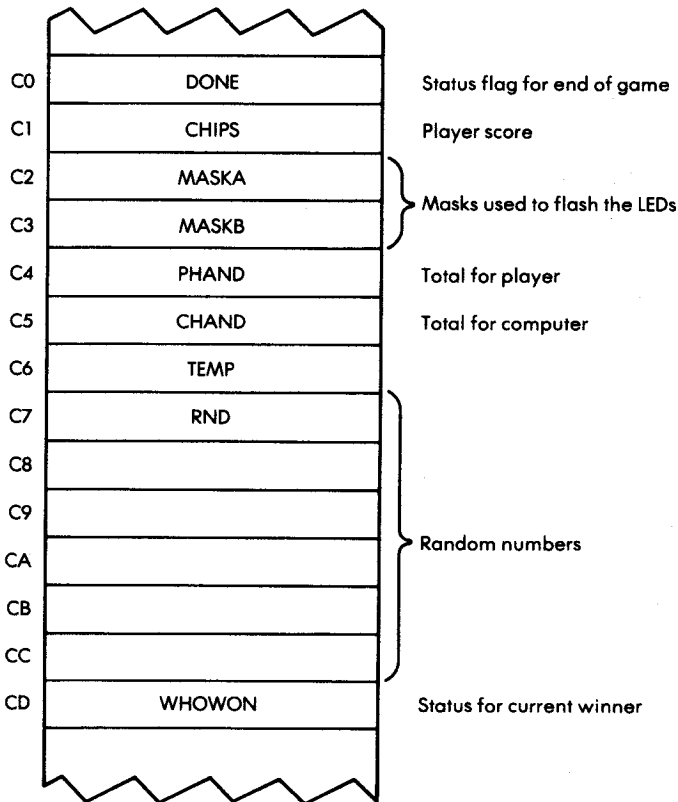
**TEMP:** This is a temporary variable used by the RANDOM routine to deal the next card to either player.

**RND through RND + 5:** These six locations are reserved for the random number generating routine called RANDER.

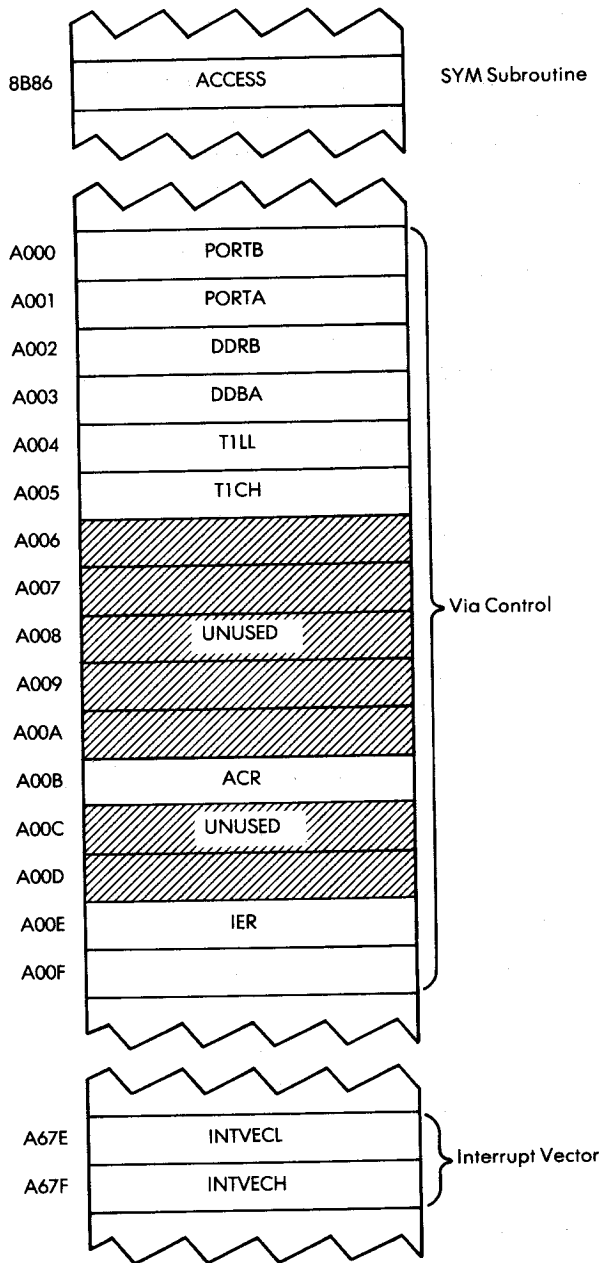
**WHOWON:** This status flag is used to indicate the current winner of the hand. It is initially set to "0," then decremented if the player loses or incremented if the player wins.

At the high end of memory the program uses VIA #1, the ACCESS subroutine provided by the SYM monitor, and the interrupt-vector at address A67E, as shown in Figure 10.11.

Let us now examine the program operation. For clarity it should be followed on the flowchart in Figure 10.9.



**Fig. 10.10: Low Memory Map**



**Fig. 10.11: High Memory Map**

**Program Initialization**

The timer on 6522 VIA #1 will be used to generate the interrupts which blink the LEDs. These interrupts will cause a branch to location 03EA where the interrupt-handling routine is located. The first step is, therefore, to load the new value into the interrupt vector, i.e., "03EA," at the appropriate memory location:

BLJACK	JSR ACCESS	Unprotect system memory
	LDA #\$EA	Load low interrupt vector
	STA INTVECL	
	LDA #\$03	High vector
	STA INTVECH	

As described previously, the interrupt-enable register is first loaded with the value "01111111," and then with the value "11000000" in order to enable the interrupt for timer 1:

LDA #\$7F	Clear timer interrupt-enable
STA IER	
LDA #\$C0	Enable timer 1 interrupt
STA IER	

Loading the value "7F" clears bits 0 through 6, thereby disabling all interrupts. Then, loading the value "C0" sets bit 6, which is the interrupt-bit corresponding to timer 1. (See Figure 9.10.) As in the previous chapter, timer 1 is put in the free-running mode. It will then automatically generate interrupts which will be used to blink the LEDs. In order to set it to the free-running mode, bit 6 of the ACR must be set to "1":

LDA #\$40	Put timer 1
STA ACR	In free run mode

The latches for timer 1 are initialized to the highest possible value, i.e., FFFF:

LDA #\$FF	
STA T1LL	Low latch of timer 1
STA T1CH	High latch and start timer

Finally, now that the timer has been correctly initialized, interrupts are enabled on the processor:

CLI                      Enable interrupts

LED Ports A and B configured as outputs (remember that the accumulator still contains the value "FF"):

STA DDRA  
STA DDRB

As a precaution, the decimal flag is cleared:

CLD

The player's score is initialized to the value 5:

LDA #5                      Set player's score to 5  
STA CHIPS

The DONE flag is initialized to the value "0":

LDA #0                      Clear done flag  
STA DONE

The LEDs on the board are cleared:

STA MASKA  
STA MASKB  
STA PORTA                      Clear LEDs  
STA PORTB

And the WHOWON flag is also initialized to "0":

STA WHOWON      Clear flag

### *Dealing the First Hand*

We are now ready to play. Let us deal one card to both the dealer and the player. The LIGHTR and the BLINKR subroutines will be used for that purpose. Each of these subroutines obtains a random



## ADVANCED 6502 PROGRAMMING

number and lights the corresponding LED. LIGHTR lights up a steady LED while BLINKR blinks the LED. These two subroutines will be described later. We set one LED blinking for the player:

```
JSR BLINKR      Set random blinking LED
```

and we save the first total for the current player's hand:

```
STA PHAND      Store player's hand
```

then we do the same for the computer:

```
JSR LIGHTR     Set random steady LED  
STA CHAND      Store computer's hand
```

### *Hit or Stay?*

We will now read the keyboard. If the player presses "A," this indicates a requested hit and one additional card must be dealt to the player. If "C" is pressed, the player "stays" (passes) and it becomes the computer's turn to play. All other keys are ignored. Let us first obtain the key closure from the keyboard:

```
ASK           JSR GETKEY
```

The key value must now be compared to "A" and to "C":

```
    CMP #$0A  
    BEQ HITPLR  
    CMP #$0C           Is it computer's turn?  
    BEQ DEALER
```

If any other key has been pressed, it will be ignored and a new key will be read:

```
JMP ASK           Invalid key, try again
```

At this point in the program, we will assume the situation warrants a "hit." One more card must be dealt to the player. Let us set one more LED blinking. Naturally, the BLINKR subroutine, as well as the LIGHTR subroutine, are careful not to deal a card that has already

been dealt. How this is achieved will be described later (this is the purpose of the SETBIT subroutine).

HITPLR      JSR BLINKR      Set random LED

As soon as a new card has been dealt to the player, we compute the player's new total for the current hand:

CLC  
ADC PHAND      Tally player's hand  
STA PHAND

The new total must be checked against the value "13." As long as the player has 13 or less, he or she may play again, i.e., either be hit or stay. However, if the player's score exceeds "13," he or she busts and loses the play. Let us check:

CMP #14      Check for 13  
BCC ASK      Ask if  $\leq$  13  
JMP LOSE      Busted

It is now the dealer's turn. Since the computer is much faster than the player in deciding whether it wants to hit or to stay, we will first slow it down to provide more suspense to the game:

DEALER      JSR DELAY

The delay subroutine also extends the period of time between the successive decisions made by the computer to make the computer appear more "human-like."

Before dealing another card to the computer (the dealer), let us examine its total. The house rule is that the dealer's total cannot exceed "10." (Naturally, other algorithms are available from Blackjack experts.) The computer hand is therefore checked against the value "10." If this value is exceeded, a branch occurs to location WINNER where the winner will be decided. Otherwise, a new card will be dealt to the computer:

LDA CHAND  
CMP #10      Check hand for limit  
BCS WINNER      Yes. Decide winner.

## ADVANCED 6502 PROGRAMMING

As long as the hand totals less than “10,” the dealer requests a hit. A new card is dealt to the dealer in exactly the same way that it was dealt previously to the player:

```
JSR LIGHTR      Set random LED
```

The dealer’s new total is computed:

```
CLC
ADC CHAND      Tally computer’s hand
STA CHAND
```

Just as in the case of the player before, it is compared against the value “13” to determine whether or not the dealer has busted:

```
CMP #14        Is hand ≤= 13?
BCC DEALER     Yes: another hit?
JMP WIN        Busted: player wins
```

If the computer has busted, a jump occurs to location WIN which indicates a “win” by the player. Otherwise, a branch back to location DEALER occurs, where the computer will determine whether or not it wants to receive an additional card. Let us now determine the winner. Both hands are compared:

```
WINNER LDA CHAND
        CMP PHAND      Compare hands
```

There are three possible cases: equal scores, player wins, and player loses.

```
BEQ SCORER
BCC WIN
```

In the case that both scores are equal, a jump occurs to location SCORER which will display the current status. If the player wins, a branch occurs to location WIN and the sequence will be described below. First, let us examine what happens when the player loses.

### *The Player Loses*

A special flag, called WHOWON, is used to store the status at the

end of each play. It is decremented to indicate a loss by the player:

LOSE            DEC WHOWON

The player's score is decremented:

DEC CHIPS

The player's score must be compared to the value "0." If the player's score has reached "0," he or she is broke and has lost the game. In this case, the DONE flag is set to "11111111;" otherwise, it is not changed. Finally a jump occurs to SCORER where the final score will be displayed:

BNE SCORER	Player broke?
DEC DONE	Yes: set lose flag
JMP SCORER	Finish game

*Player Has Won*

Similarly, when the player wins, the WHOWON flag is set to "1":

WIN            INC WHOWON

The score is incremented:

INC CHIPS

It is then compared to the value "10":

LDA CHIPS	
CMP #10	Chips = 10?

If the maximum score of "10" has been reached, the DONE flag is set.

BNE SCORER	
INC DONE	Set done flag

Displaying the final status is accomplished by the SCORER routine. Remember that the final status will be displayed only at the player's request — when any key is pressed on the keyboard. Let us wait for

## ADVANCED 6502 PROGRAMMING

this:

```
SCORER    JSR GETKEY
```

Before displaying the status, all LEDs on the board are turned off:

```
LDA #0  
STA MASKA  
STA MASKB  
STA PORTA  
STA PORTB
```

The player's score must now be displayed on the board. Let us read it:

```
LDX CHIPS  
BEQ ENDER
```

If the player has no more chips, a branch occurs to location ENDER and the game will be terminated. Otherwise, the score is displayed. Unfortunately, LEDs are numbered internally "0" through "7," even though they are labeled externally "1" through "8." In order to light up the proper LED, the score must therefore first be decremented:

```
DEX
```

then a special subroutine called SETMASK is used to display the appropriate LED. On entry to the SETMASK routine, it is assumed that the accumulator contains the number of the LED to be displayed.

```
TXA  
JSR SETMASK
```

Now that the proper mask has been created to display the score, we must indicate the winner. If the player won, the three left-most LEDs in the bottom row will be lit; if the computer won, the three right-most LEDs will be lit. If it was a tie, no LEDs will be lit on the bottom row. Let us see who won:

```
LDA WHOWON  
BEQ ENDER    Tie: do not change LEDs  
BMI SC
```

## COMPLEX EVALUATION TECHNIQUE

If the player lost, a branch occurs to address SC. If, on the other hand, the player won, the three left-most LEDs in the bottom row are lit:

```
                LDA #$0E           Player won: set left LEDs
                JMP SC0
```

If the player lost, the three right-most LEDs are lit:

```
SC              LDA #$B0           Player lost: set right LEDs
```

Contained in the accumulator is the appropriate pattern to light the bottom row of LEDs, and this is sent to the Games Board:

```
SC0             ORA PORTB
                STA PORTB
```

### *End of a Play*

The ENDER routine is used to terminate each play. If the score was neither "0" nor "10," a new hand will be dealt:

```
ENDER          JSR DELAY2
                LDA DONE
                BNE EN0
                JMP START
```

Otherwise, we check the DONE flag for either a player win or a player loss. If the player lost the game, the bottom row of LEDs is lit and the program ends:

```
EN0            BPL EN1             $01: Jump on win condition
                LDA #$BE           Solid row of LEDs
                STA PORTB
                RTS                 Return to monitor
```

In the case of a player win, a blinking square is displayed and the program is terminated:

```
EN1            LDA #$FF
                STA MASKA
```

```
LDA #$01
STA MASKB
RTS
```

## Subroutines

### *SETBIT Subroutine*

The purpose of this subroutine is to create the pattern required to light a given LED. Upon entering the subroutine, the accumulator contains a number between “0” and “9” which specifies which LED must be lit. Upon exiting the subroutine, the correct bit is positioned in the accumulator. If the logical LED number was greater than “7,” the carry bit is set to indicate that output should occur on Port B rather than on Port A. Additionally, Y will contain the external value of the LED to be lit (1 to 10).

Let us examine the subroutine in detail. The LED number is saved in index register Y:

```
SETBIT      TAY           Save logical number
```

It is then compared to the limit value “7.”

```
CMP #8
BCC SB0
```

If the value was greater than 7, we subtract 8 from it:

```
SBC #8           Subtract if >7
```

**Exercise 10-1:** *Recall that SBC requires the carry to be set. Is this the case?*

Now we can be assured that the number in the accumulator is between “0” and “7.” Let us save it in X:

```
SB0          TAX
```

A bit will now be shifted into the correct position of the accumulator. Let us first set the carry to “1”:

```
SEC          Prepare to roll
```

We clear the accumulator:

```
LDA #0
```

then we roll in the bit to the correct position:

```
SBLOOP    ROL A
           DEX
           BPL SBLOOP
```

Note that index register X is used as a bit-counter. The accumulator is now correctly conditioned. The external number of the LED to be lit is equal to the initial value which was stored in the accumulator plus one:

```
INY           Make Y the external #
```

If LEDs 9 or 10 must be lit, the carry bit must be set to indicate this fact. Port B will have to be used rather than Port A:

```
CPY #9       Set carry for Port B
RTS
```

**Exercise 10-2:** Compare this subroutine to the *LIGHT* subroutine in the previous chapter.

**Exercise 10-3:** How was the carry set for LED #9 at the end?

### ***LIGHTR Subroutine***

This subroutine deals the next card to the dealer (computer). It must obtain a random number, then make sure that this card has not already been dealt, i.e., that it does not correspond to a card which has already been displayed on the board. If it has not already been displayed, the random number can be used as the value of the next card to be dealt. A steady LED will then be lit on the board.

Let us first get a random number:

```
LIGHTR    JSR RANDOM
```

It will be shown below that the *RANDOM* routine does not just ob-



## ADVANCED 6502 PROGRAMMING

tain a random number but also makes sure that it does not correspond to a card already used. All we have to do then is position the correct bit in the accumulator and display it. Let us use the SETBIT routine we have just described in order to position the bit in the accumulator:

### JSR SETBIT

We must determine whether Port A or Port B must be used. This is done by testing the carry bit which has been conditioned by the SETBIT subroutine:

### BCS LLO

We will assume that Port A must be used. The new bit will be added to the display by ORing it into Port A:

```
ORA PORTA
STA PORTA
```

The value of the card must be restored into the accumulator. It had been saved in the Y register by the SETBIT routine:

```
TYA
RTS
```

In case Port B is used, the sequence is identical:

```
LLO      ORA PORTB
          STA PORTB
          TYA          Restore value
          RTS
```

### *BLINKER Subroutine*

This subroutine operates exactly like LIGHTR above except that it sets an LED flashing. Note that it contains the SETMASK subroutine which will set the proper LED flashing and exit with a numerical value of the LED in the accumulator:

```
BLINKR   JSR RANDOM   Get random number
SETMASK  JSR SETBIT
```

	BCS BLO	Branch if Port B
	ORA MASKA	
	STA MASKA	
	TYA	Restore value
	RTS	
BLO	ORA MASKB	
	STA MASKB	
	TYA	
	RTS	

***RANDOM Subroutine***

This subroutine will generate a random number between "0" and "9" which has not already been used, i.e., which does not correspond to the internal number of an LED that is already lit on the Games Board. The value of this number will be left in the accumulator upon exit. Let us obtain a random number:

RANDOM	JSR RANDB	Get 0-255 number
--------	-----------	------------------

The RANDB subroutine is the usual random number generator which has been described in previous chapters. As usual, we must retain only a number between "0" and "9." We will use a different strategy here by simply rejecting any number greater than "9" and asking for a new random number if this occurs:

```

AND #$0F
CMP #10
BCS RANDOM
    
```

**Exercise 10-4:** *Can you suggest an alternative method for obtaining a number between "0" and "9"? (Hint: such a method has been described in previous chapters.)*

A random number between "0" and "9" has now been obtained. Let us obtain the corresponding bit position which must be lit and save it in location TEMP:

JSR SETBIT	Set bit in position
STA TEMP	

We will now check to see if the corresponding bit is already lit on either

## ADVANCED 6502 PROGRAMMING

Port A or Port B. Let us first check to see if it is Port A or Port B:

```
BCS RN0          Determine Port A or B
```

Assuming that it is Port A, we must now find which LEDs in Port A are lit. This is done by combining the patterns for the blinking and steady LEDs, which are, respectively, in Mask A and Port A:

```
LDA MASKA
ORA PORTA        Combine Port and Mask
```

Then a check is made to see whether or not the bit we want to turn on is already on:

```
JMP RN1
```

If it is on, we must obtain a new random number between “0” and “9”:

```
RN1          AND TEMP
              BNE RANDOM
```

If the bit was not already on, we simply exit with the internal value of the LED in the accumulator:

```
DEY
TYA
RTS
```

Similarly, if an LED on Port B had to be turned on, the sequence is:

```
RN0          LDA MASKB
              ORA PORTB
              AND TEMP
              BNE RANDOM
              DEY
              TYA
              RTS
```

### *RANDER Subroutine*

This subroutine generates a random number between “0” and “255.” It has already been described in previous chapters.

***DELAY Subroutines***

Two delay loops are used by this program: DELAY, which provides approximately a half-second delay and DELAY2, which provides twice this delay or approximately one second. Index registers X and Y are each loaded with the value “FF.” A two-level nested loop is then implemented:

```

DELAY2    JSR DELAY
DELAY     LDA #$FF
          TAY
D0        TAX
D1        DEX
          LDA #$FF
          BNE D1
          DEY
          BNE D0
          RTS

```

**Exercise 10-5:** *Compute the exact duration of the DELAY subroutines.*

***Interrupt Handler***

The interrupt routine is used to blink LEDs on the board, using MASKA and MASKB, every time that the timer generates an interrupt. No registers are changed. The operation of this routine has been described in the preceding chapter:

```

          PHA
          LDA PORTA
          EOR MASKA
          STA PORTA
          LDA PORTB
          EOR MASKB
          STA PORTB
          LDA TILL
          PLA
          RTI

```

**SUMMARY**

This program was more complex than most, despite the simple strategy

## ADVANCED 6502 PROGRAMMING

used by the dealer. Most of the logical steps of the algorithm were accompanied by sound and light effects. Note how little memory is required to play an apparently complex game.

**Exercise 10-6:** Note that this program assumes that the contents of memory location *RND* are reasonably random at the beginning of the game. If you would like to have a more random value in *RND* at the beginning of the game, can you suggest an additional instruction to be placed in the initialization phase of this program? (Hint: this has been done in previous programs.)

**Exercise 10-7:** In the *ENDER* routine are the instructions “*BNE EN0*” and “*JMP START*” both needed? If they are not, under what conditions would they be needed?

**Exercise 10-8:** “*Recursion*” describes a routine which calls itself. Is *DELAY2* recursive?

```

; --- BLJACK PROGRAM ---
ACCESS = $BB86
INTVECL = $A67E
INTVECH = $A67F
IER = $A00E
ACR = $A00B
TILL = $A004
TICH = $A005
DDRA = $A003
DDRB = $A002
PORTA = $A001
PORTE = $A000
MASKA = $C2
MASKB = $C3
CHIPS = $C1
DONE = $C0
PHAND = $C4
CHAND = $C5
TEMP = $C6
RND = $C7
WHOWON = $CD
GETKEY = $100
. = $200

;
;BLACKJACK GAME: USES A 'DECK' OF 10 CARDS. CARDS DEALT
;TO THE PLAYER ARE FLASHING LED'S. ONES IN THE COM-
;PUTER'S HAND ARE STEADY. CARDS ARE DEALT BY A RANDOM
;NUMBER GENERATOR WHICH IS NON-REPETITIVE. NUMERICAL
;TOTALS ARE KEPT IN ZERO PAGE LOCATIONS 'PHAND' AND
;'CHAND'. PORTA AND PORTB ARE THE OUTPUT PORTS TO THE
;LED DISPLAY. MASKA AND MASKB ARE USED BY THE INTERRUPT
;ROUTINE TO FLASH SELECTED LED'S. 'DONE' AND
;'WHOWON' ARE STATUS FLAGS TO DETERMINE END OF GAME AND
;WHO WON THE CURRENT HAND.

```

**Fig. 10.12: Blackjack Program**

## COMPLEX EVALUATION TECHNIQUE

```

;
; PROGRAM STARTS BY INITIALIZING THE TIMER AND THE
; INTERRUPT VECTOR. THE OUTPUT PORTS ARE TURNED ON,
; AND THE STATUS FLAGS ARE CLEARED.
;
0200: 20 86 8B BLJACK JSR ACCESS ;UNPROTECT SYSTEM MEMORY
0203: A9 EA LDA #$EA ;LOAD LOW INTERRUPT VECTOR
0205: 8D 7E A6 STA INTVECL
0208: A9 03 LDA #$03 ;LOAD HIGH INTERRUPT VECTOR
020A: 8D 7F A6 STA INTVECH
020D: A9 7F LDA #$7F ;CLEAR TIMER INTERRUPT ENABLE
020F: 8D 0E A0 STA IER
0212: A9 C0 LDA #$C0 ;ENABLE TIMER 1 INTERRUPT
0214: 8D 0E A0 STA IER
0217: A9 40 LDA #$40 ;PUT TIMER 1 IN FREE RUN MODE
0219: 8D 0B A0 STA ACR
021C: A9 FF LDA #$FF
021E: 8D 04 A0 STA T1LL ;SET LOW LATCH ON TIMER 1
0221: 8D 05 A0 STA T1CH ;SET HIGH LATCH & START TIMER
0224: 58 CLI ;ENABLE PROCESSOR INTERRUPTS
0225: 8D 03 A0 STA DDRA ;SET LED PORTS TO OUTPUTS
0228: 8D 02 A0 STA DDRB
022B: D8 CLD
022C: A9 05 LDA #5 ;SET PLAYER'S SCORE TO 5
022E: 85 C1 STA CHIPS
0230: A9 00 LDA #0 ;CLEAR DONE FLAG
0232: 85 C0 STA DONE
;
;NEW HAND: DISPLAY IS CLEARED, BOTH HANDS ARE
;ARE SET WITH START VALUES, AND THE CORRESPONDING
;LED'S ARE SET.
;
0234: 85 C2 START STA MASKA ;CLEAR BLINKER MASKS; IT IS
0236: 85 C3 STA MASKB ;ASSUMED THAT ACC. CONTAINS ZERO
0238: 8D 01 A0 STA PORTA ;CLEAR LED'S
023B: 8D 00 A0 STA PORTB
023E: 85 CD STA WHOWON ;CLEAR FLAG FOR HAND
0240: 20 0F 03 JSR BLINKR ;SET RANDOM BLINKING LED
0243: 85 C4 STA PHAND ;STORE PLAYER'S HAND
0245: 20 F7 02 JSR LIGHTR ;SET A STEADY RANDOM LED
0248: 85 C5 STA CHAND ;STORE COMPUTER'S HAND
;
;KEY INPUT: 'A' IS A HIT, 'C' IS COMPUTER' TURN
;ALL OTHERS ARE IGNORED
;
024A: 20 00 01 ASK JSR GETKEY ;GET A KEY INPUT
024D: C9 0A CMP #$0A ;DOES PLAYER WANT A HIT?
024F: F0 07 BEQ HITPLR ;YES, BRANCH
0251: C9 0C CMP #$0C ;IS IT 'COMP TURN' KEY?
0253: F0 12 BEQ DEALER ;YES
0255: 4C 4A 02 JMP ASK ;BAD KEY, TRY AGAIN
;
0258: 20 0F 03 HITPLR JSR BLINKR ;SET A RANDOM LED
025B: 18 CLC
025C: 65 C4 ADC PHAND ;TALLY PLAYER'S HAND
025E: 85 C4 STA PHAND
0260: C9 0E CMP #14 ;CHECK HAND
0262: 90 E6 BCC ASK ;IS <=13, OK
0264: 4C 87 02 JMP LOSE ;BUSTED, GO TO LOSE ROUTINE
;
0267: 20 5D 03 DEALER JSR DELAY ;DELAY EXECUTION OF ROUTINE
026A: A5 C5 LDA CHAND ;IS COMP OVER HOUSE LIMIT?
026C: C9 0A CMP #10
026E: 80 0F BCS WINNER ;YES, FIGURE WINNER
0270: 20 F7 02 JSR LIGHTR ;NO,SET RANDOM LED
0273: 18 CLC

```

Fig. 10.12: Blackjack Program (Continued)

# ADVANCED 6502 PROGRAMMING

```

0274: 65 C5          ADC CHAND      ;TALLY COMPUTER'S HAND
0276: 85 C5          STA CHAND
0278: C9 0E          CMP #14        ;IS HAND <=13?
027A: 90 EB          BCC DEALER     ;YES, ANOTHER HIT?
027C: 4C 92 02       JMP WIN        ;BUSTED, PLAYER WINS
;
;FIGURE WINNER: 'WIN' AND 'LOSE' TALLY SCORE,
;AND DETERMINE IF THE PLAYER HAS WON OR LOST
;THE GAME. THE 'WHOWON' FLAG IS SET TO SHOW WHO
;WON THE PARTICULAR HAND. IF THE HANDS ARE EQUAL,
;NOTHING IS AFFECTED.
;
027F: A5 C5          WINNER LDA CHAND    ;COMPARE HANDS
0281: C5 C4          CMP PHAND
0283: F0 19          BEQ SCORER     ;ARE EQUAL, NO CHANGE
0285: 90 0B          BCC WIN        ;PLAYER'S HAND GREATER
0287: C6 CD          LOSE  DEC WHOWON ;LOSE ROUTINE
0289: C6 C1          DEC CHIPS      ;TALLY SCORE
028B: D0 11          BNE SCORER     ;IS PLAYER BROKE?
028D: C6 C0          DEC DONE       ;YES, SET END OF GAME FLAG: LOSE
028F: 4C 9E 02       JMP SCORER
0292: E6 CD          WIN  INC WHOWON  ;WIN ROUTINE
0294: E6 C1          INC CHIPS      ;TALLY SCORE
0296: A5 C1          LDA CHIPS      ;ADD WINNINGS
0298: C9 0A          CMP #10        ;IF CHIPS=10, SET END OF GAME FLAG
029A: D0 02          BNE SCORER
029C: E6 C0          INC DONE       ;SET END OF GAME FLAG: WIN
;
;DISPLAY SCORE BY LIGHTING 1 OF 10 LED'S. THE
;BOTTOM ROW OF LED'S IS SET TO SHOW WHETHER THE PLAYER
;FOR THE COMPUTER WON THE HAND. THE DISPLAY IS HELD
;THUS, THEN A TEST IS MADE FOR AN END OF GAME CONDITION
;IF SUCH A CONDITION EXISTS, THE LED'S ARE
;SET ACCORDINGLY, AND THE PROGRAM IS TERMINATED.
;IT IS ASSUMED THAT THE ADDRESS OF THE MONITOR IS
;ON THE STACK.
;
029E: 20 00 01       SCORER JSR GETKEY  ;HOLD LAST STANDINGS OF CARDS
02A1: A9 00          LDA #0         ;CLEAR LED'S
02A3: 85 C2          STA MASKA
02A5: 85 C3          STA MASKB
02A7: 8D 01 A0       STA PORTA
02AA: 8D 00 A0       STA PORTB
02AD: A6 C1          LDX CHIPS      ;DISPLAY NUMBER OF CHIPS
02AF: F0 18          BEQ ENDER      ;ADJUST SO SUBROUTINE SETS
02B1: CA            DEX           ;THE RIGHT LED
02B2: 8A            TXA
02B3: 20 12 03       JSR SETMASK
;
02B6: A5 CD          LDA WHOWON     ;SEE WHO WON HAND
02B8: F0 0F          BEQ ENDER      ;TIE-- DO NOT AFFECT LED'S
02BA: 30 05          BMI SC
02BC: A9 0E          LDA #0E        ;PLAYER WON-- SET THREE LEFT LED'S
02BE: 4C C3 02       JMP SCO
02C1: A9 B0          SC  LDA #B0     ;PLAYER LOST-- SET THREE RIGHT LED'S
02C3: 0D 00 A0       SCO ORA PORTB   ;SET LED PORT
02C6: 8D 00 A0       STA PORTB
02C9: 20 5A 03       ENDER JSR DELAY2  ;HOLD DISPLAY
;
02CC: A5 C0          LDA DONE       ;CHECK FOR END OF GAME CONDITION
02CE: D0 03          BNE ENO
02D0: 4C 34 02       JMP START      ;ZERO, START NEW HAND
02D3: 10 06          ENO BPL EN1     ;#01, WIN CONDITION
02D5: A9 BE          LDA #BE       ;SET SOLID ROW LEDS
02D7: 8D 00 A0       STA PORTB
02DA: 60            RTS           ;RETURN TO MONITOR

```

Fig. 10.12: Blackjack Program (Continued)

## COMPLEX EVALUATION TECHNIQUE

```

02DB: A9 FF      EN1    LDA  #$FF      ;SET BLINKING SQUARE
02DD: 85 C2      STA  MASKA
02DF: A9 01      LDA  #$01
02E1: 85 C3      STA  MASKB
02E3: 60                RTS          ;RETURN TO MONITOR
;
;      --SUBROUTINES--
;
;SET A BIT IN ACCUMULATOR; ENTER WITH A LOGICAL VALUE,
;I.E. 0-9, IN ACC.  EXITS WITH A NUMERICAL VALUE(1-10)
;IN Y, AND THE BIT POSITIONED IN ACC.  THE CARRY FLAG
;
02E4: A8      SETBIT  TAY          ;SAVE LOGICAL NUMBER
02E5: C9 08      CMP  #8          ;BRACKET 0-7 VALUE
02E7: 90 02      BCC  SBO
02E9: E9 08      SBC  #8          ;...SUBTRACT IF >7
02EB: AA      SBO    TAX          ;SET INDEX REG
02EC: 38      SEC          ;PREPARE BIT TO ROLL
02ED: A9 00      LDA  #0
02EF: 2A      SBLOOP  ROL  A      ;MOVE BIT TO POSITION
02F0: CA      DEX
02F1: 10 FC      BPL  SBLOOP
02F3: C8      INY          ;MAKE Y NUMERICAL, NOT LOGICAL
02F4: C0 09      CPY  #9          ;SET CARRY. FOR PORTB, C=1
02F6: 60                RTS
;
;LIGHTR: SETS A RANDOM STEADY LED THAT HAS NOT BEEN
;PREVIOUSLY SET.  IT GETS A RANDOM NUMBER, THEN SETS
;THE BIT IN THE PROPER PORT.  THE NUMERICAL VALUE OF
;BIT SET IS IN THE ACCUMULATOR ON EXIT.
;
02F7: 20 23 03  LIGHTR  JSR  RANDOM      ;GET RANDOM NUMBER
02FA: 20 E4 02  JSR  SETBIT      ;GET BIT POSITIONED IN ACC.
02FD: B0 08      BCS  LLO      ;BRANCH IF PORT B DESIGNATED
02FF: 0D 01 A0  ORA  PORTA      ;SET LED IN PORTA
0302: 8D 01 A0  STA  PORTA
0305: 98      TYA          ;RESTORE NUMERICAL VALUE
0306: 60                RTS
0307: 0D 00 A0  LLO    ORA  PORTB      ;SET LED IN PORTB
030A: 8D 00 A0  STA  PORTB
030D: 98      TYA          ;RESTORE NUMERICAL VALUE
030E: 60                RTS
;
;BLINKR: SETS A RANDOM FLASHING LED THAT HAS NOT BEEN
;PREVIOUSLY SET.  THE NUMERICAL VALUE OF THE LED IS IN
;THE ACCUMULATOR ON EXIT.  IT GETS A RANDOM NUMBER,
;THEN DROPS INTO THE SETMASK ROUTINE TO FLASH THE
;PROPER LED.
;
;SETMASK: ENTER WITH A LOGICAL VALUE, AND ROUTINE
;SETS THE PROPER FLASHING LED.  EXITS WITH NUMERICAL
;VALUE OF LED SET IN ACCUMULATOR
;
030F: 20 23 03  BLINKR  JSR  RANDOM      ;GET RANDOM NUMBER
0312: 20 E4 02  SETMASK  JSR  SETBIT
0315: B0 06      BCS  BLO      ;BRANCH IF PORTB DESIGNATED
0317: 05 C2      ORA  MASKA      ;SET MASKA
0319: 85 C2      STA  MASKA
031B: 98      TYA          ;RESTORE NUMERICAL VALUE
031C: 60                RTS
031D: 05 C3      BLO    ORA  MASKB      ;SET MASKB
031F: 85 C3      STA  MASKB

```

**Fig. 10.12: Blackjack Program (Continued)**



# ADVANCED 6502 PROGRAMMING

```

0321: 98          TYA
0322: 60          RTS

;
;GENERATES A RANDOM NUMBER FROM 0 TO 9 THAT IS NOT
;THE NUMBER OF AN LED ALREADY SET. RESULT IS IN ACC ON
;EXIT.
;
0323: 20 47 03  RANDOM JSR RANDEF ;GET 0-255 NUMBER
0326: 29 0F          AND #$0F ;MASK HIGH NIBBLE
0328: C9 0A          CMP #10 ;BRACKET 0-9
032A: B0 F7          BCS RANDOM
032C: 20 E4 02  JSR SETBIT ;SET BIT IN POSITION
032F: 85 C6          STA TEMP ;SAVE IT
0331: B0 08          BCS RNO ;DETERMINE PORT A OR B
0333: A5 C2          LDA MASKA ;COMBINE PORT AND MASK
0335: 0D 01 A0      ORA PORTA
0338: 4C 40 03      JMP RN1
033B: A5 C3          LDA MASKB ;COMBINE PORT AND MASK
033D: 0D 00 A0      ORA PORTB
0340: 25 C6          AND TEMP ;LOOK AT SPECIFIC BIT
0342: D0 DF          BNE RANDOM ;IF BIT SET ALREADY, TRY AGAIN
0344: 88          DEY ;MAKE Y LOGICAL
0345: 98          TYA ;EXIT WITH VALUE IN ACCUMULATOR
0346: 60          RTS

;
;GENERATES A RANDOM NUMBER FROM 0-255. USES NUMBERS
;A,B,C,D,E,F STORED AS RND THROUGH RND+5. ADDS B+E+F+1
;AND PUTS RESULT IN A, THEN SHIFTS A TO B, B TO C, ETC.
;RANDOM NUMBER IS IN ACCUMULATOR ON EXIT.
;
0347: 38          SEC ;CARRY ADDS 1
0348: A5 C8          LDA RND+1 ;ADD B,D,F
034A: 65 C8          ADC RND+4
034C: 65 CC          ADC RND+5
034E: 85 C7          STA RND
0350: A2 04          LDX #4 ;SHIFT NUMBERS DOWN
0352: B5 C7          RDLOOP LDA RND,X
0354: 95 C8          STA RND+1,X
0356: CA          DEX
0357: 10 F9          BPL RDLOOP
0359: 60          RTS

;
;DELAY LOOP: DELAY2 IS SIMPLY TWICE THE TIME DELAY
;OF DELAY. GIVEN LOOP IS APPROX. .5 SEC. DELAY.
;
035A: 20 5D 03  DELAY2 JSR DELAY
035D: A9 FF          DELAY LDA #$FF ;SET VALUE FOR LOOPS
035F: A8          TAY
0360: AA          D0 TAX
0361: CA          D1 DEX
0362: A9 FF          LDA #$FF
0364: D0 FB          BNE D1
0366: 88          DEY
0367: D0 F7          BNE D0
0369: 60          RTS

;
;
;INTERRUPT ROUTINE: EXCLUSIVE OR'S THE OUTPUT
;PORTS WITH THE CORRESPONDING BLINKER MASKS EVERY
;TIME THE TIMER TIMES OUT TO FLASH SELECTED LED'S.
;NO REGISTERS ARE CHANGED, AND THE INTERRUPT
;FLAG IS CLEARED BEFORE EXIT.
;
;
;=$03EA
03EA: 48          PHA ;SAVE ACCUMULATOR
03EB: AD 01 A0      LDA PORTA ;COMPLEMENT PORTS WITH MASKS

```

Fig. 10.12: Blackjack Program (Continued)

## COMPLEX EVALUATION TECHNIQUE

```

03EE: 45 C2          EOR MASKA
03F0: 8D 01 A0      STA PORTA
03F3: AD 00 A0      LDA PORTB
03F6: 45 C3          EOR MASKB
03F8: 8D 00 A0      STA PORTB
03FB: AD 04 A0      LDA TILL          ;CLEAR TIMER INTERRUPT BIT
03FE: 68             PLA              ;RESTORE ACCUMULATOR
03FF: 40             RTI

SYMBOL TABLE:
ACCESS      8B86          INTVECL      A67E          INTVECH      A67F
IER         A00E          ACR          A00B          TILL         A004
T1CH       A005          DDRA         A003          DDRB         A002
PORTA      A001          PORTB       A000          MASKA       00C2
MASKB      00C3          CHIPS       00C1          DONE        00C0
PHAND      00C4          CHAND       00C5          TEMP        00C6
RND        00C7          WHOWON     00CD          GETKEY      0100
BLJACK     0200          START      0234          ASK         024A
HITPLR     0258          DEALER     0267          WINNER      027F
LOSE       0287          WIN        0292          SCORER      029E
SC         02C1          SCO        02C3          ENDER       02C9
ENO        02D3          EN1        02DB          SETBIT      02E4
SB0        02EB          SBLOOP     02EF          LIGHTR      02F7
LLO        0307          BLINKR     030F          SETMASK     0312
BLO        031D          RANDOM     0323          RNO         033B
RN1        0340          RANDBR     0347          RDLOOP      0352
DELAY2     035A          DELAY      035D          D0          0360
D1         0361

%

```

**Fig. 10.12: Blackjack Program (Continued)**

# 11. Artificial Intelligence

## (Tic-Tac-Toe)

### INTRODUCTION

This chapter presents the complete design of a complex algorithm that solves the strategy and implementation problems of the Tic-Tac-Toe game. This is a long program using sophisticated evaluation techniques, table look-up algorithms, as well as complex data structures such as chained lists. It deserves a close examination and will bring you to a true competence level when programming the 6502.

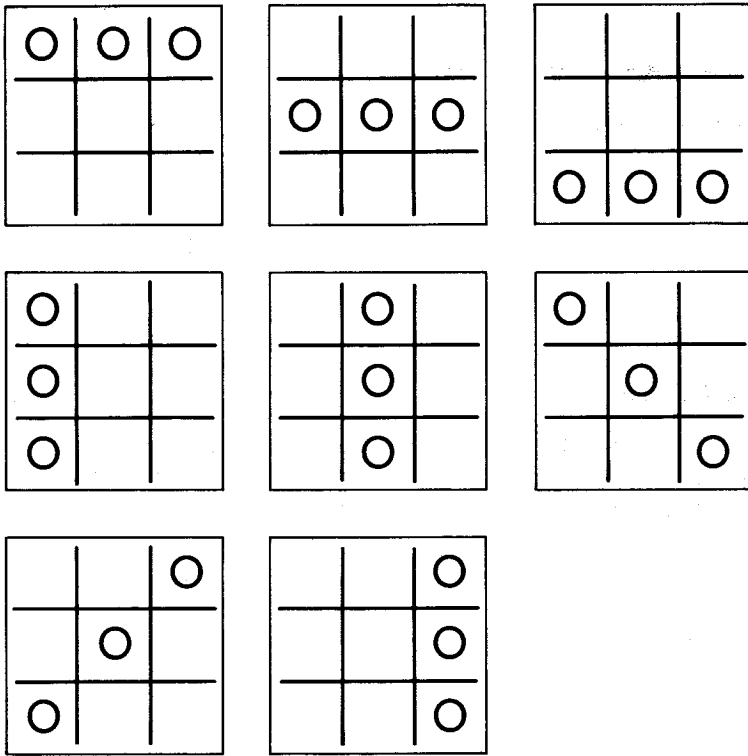
### THE RULES

Tic-Tac-Toe is played on a three-by-three sectioned square. An "O" symbol will be used to represent a move by the player and an "X" will be used to display a move by the computer. Each player moves in turn, and on every turn each player strategically places his or her symbol in a chosen section of the board. The first player to line up three symbols in a row (either horizontally, vertically or diagonally) is the winner. An example of the eight possible winning combinations is shown in Figure 11.1. Using our LED display, a continuously lit LED will be used to display an "X," i.e., a computer move. A blinking LED will be used to display an "O," i.e., the player's move.

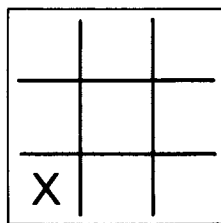
Either the player or the computer may make the first move. If the player decides to move first, he or she must press key "F." If the computer is to move first, any other key should be pressed and the computer will start the game. At the end of each game a new game will start automatically. The computer is equipped with a variable IQ (intelligence) level ranging from one to fifteen. Every time the computer wins, its IQ level is reduced one unit. Every time the player wins, the computer's IQ level is increased by one unit. This way, every player has a chance to win. A high tone is sounded every time the player wins and a low tone is sounded every time that the player loses.

### A TYPICAL GAME

The display is initially blank. We will let the computer start. We do this by pressing any key but the key "F." (If we press key "F," then the player must go first.) Let us begin by pressing "O." After a short pause the computer responds with a "chirp" and makes its move. (See Figure 11.2.)



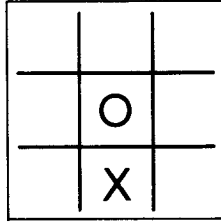
**Fig. 11.1: Tic-Tac-Toe Winning Combinations For a Player**



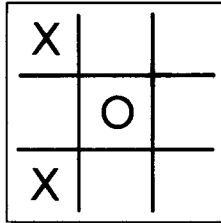
**Fig. 11.2: First Computer Move**

An "X" is used to denote the computer's moves. "O" will be used to denote our moves. Blank spaces are used to show unlit LEDs. Let

us move to the center and occupy position 5. (See Figure 11.3.) We press key "5." A moment later, LED #1 lights up and a chirp is heard that indicates it is our turn to play. The board is shown in Figure 11.4.

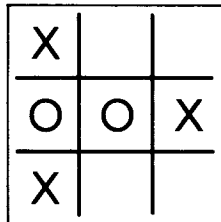


**Fig. 11.3: Our First Move**



**Fig. 11.4: Second Computer Move**

It is now our turn and we should block the computer to prevent it from completing a winning column: let us occupy position 4. We press key "4." A moment later, LED #6 lights up and a chirp is heard. The situation is shown in Figure 11.5.



**Fig. 11.5: After the Computer's Third Move**

We play in position 2. The computer reacts by playing in position 8. This is shown in Figure 11.6. We prevent the computer from completing a winning row by playing in position 9. The computer responds by occupying position 3. This is shown in Figure 11.7. This is a draw situation. Nobody wins, all the LEDs on the board blink for a moment, and then the board goes blank. We can start another game.

X	O	
O	O	X
X	X	

**Fig. 11.6: After the Computer's Fourth Move**

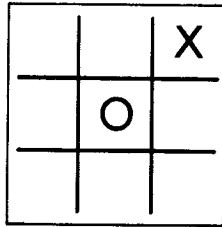
X	O	X
O	O	X
X	X	O

(DRAW)

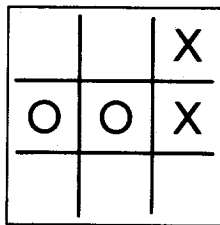
**Fig. 11.7: After the Computer's Fifth Move**

### Another Game

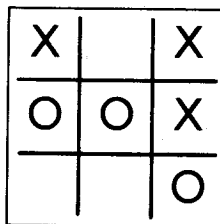
This time we are going to start and, hopefully, win! We press "F" to start the game. A chirp is heard, confirming that it is our turn to play. We play in position 5. The computer responds by occupying square 3. The chirp is heard, announcing that we can play again. The situation is shown in Figure 11.8. We play in position 4. The computer responds by occupying square 6. This is shown in Figure 11.9. This time we must block the computer from completing the column on the



**Fig. 11.8: Move 1**



**Fig. 11.9: Move 2**



**Fig. 11.10: Move 3**

right and we move into position 9. The computer responds by moving to square 1, thus preventing us from completing a diagonal. This situation is shown in Figure 11.10. We must prevent the computer from completing a winning row on top; therefore we occupy position 2. The computer responds by occupying position 8. This is shown in Figure 11.11. We make our final move to square 7 to finish the game. This is a draw: we did not beat the computer.

X	O	X
O	O	X
	X	O

**Fig. 11.11: Move 4**

Since the computer was “smart enough” to move into a diagonal position after we occupied the center position, we did not win. Note: if we keep trying, at some point the computer will play one of the side positions (2, 4, 6, or 8) rather than one of the corners and we will then have our chance to win. Here is an example.

We move to the center. The computer replies by moving into position 6. The situation is shown in Figure 11.12. We move to square 1; the computer moves to square 9. This is shown in Figure 11.13. We

	O	X

**Fig. 11.12: Move 1**

O		
	O	X
		X

**Fig. 11.13: Move 2**



move to square 3; the computer moves to square 7. This is shown in Figure 11.14. This time we make the winning move by playing into square 2. The situation is shown in Figure 11.15. Note that if we start playing and if we play well, the result will be either a draw or a win. With Tic-Tac-Toe, the player who starts the game cannot lose if he or she makes no mistakes.

O		O
	O	X
X		X

"MOVE 3"

**Fig. 11.14: Move 3**

O	O	O
	O	X
X		X

**Fig. 11.15: "We Win!"**

## THE ALGORITHM

The algorithm for the Tic-Tac-Toe program is the most complex of those we have had to devise so far. It belongs to the domain of so-called "artificial intelligence." This is a term used to denote the fact that the functions performed by the program duplicate the mental activity commonly called "intelligence." Designing a good algorithm for this game in a small amount of memory space is not a trivial problem. Historically, many algorithms have been proposed, and more can be found. Here, we will examine two strategies in detail, and then select and implement one of them. Additional exercises will suggest other possible strategies.

### Strategy to Decide the Next Move

A number of strategies may be used to determine the next move to be made by the computer. The most straightforward approach would be to store all possible patterns and, the best response in each case. This is the best method to use from a mathematical point of view as it guarantees that the best possible move will be made every time. It is also a practical approach because the number of combinations on a  $3 \times 3$  board is limited. However, since we have already learned to do table lookups for other games, such an approach would not teach us as much about programming. It might also not be considered "fair." We will, therefore, investigate other methods applicable to a wider number of games, or to a larger board.

Many strategies can be proposed. For example, it is possible to consider a *heuristic* strategy in which the computer *learns by doing*. In other words, the computer becomes a better player as it plays more games and learns from the mistakes it makes. With this strategy the moves made by the computer are random at the beginning of the game. However, provided that a sufficient amount of memory is available, the computer remembers every move that it has made. If it is led into a losing situation, the moves leading to it are thrown out by the computer as misjudged moves, and they will not be used again in that sequence. With time and a reasonable "learning" algorithm this approach will result in the construction of *decision tables*. However, this approach assumes that a very large amount of memory is available. This is not the case here. We want to design a program which will fit into 1K of memory. Let us look at another approach.

Another basic approach consists of *evaluating the board* after each move. The board should be examined from two standpoints: first, if there are two "O"s in a row, it is important to block them unless a win can be achieved with the current move. Also, the *win potential* of every board configuration should be examined each time: for example, if two "X"s are in a row, then the program must make a move in order to complete the row for a win. Naturally these two situations are easy to detect. The real problem lies in evaluating the potential of every square on the board in every situation.

### An Analytical Algorithm

At this point, we will show the process used to design an algorithm along very general guidelines. After that, as we discover the weaknesses of the algorithm, we will improve upon it. This will serve as an ex-

ample of a possible approach to problem-solving in a game of strategy.

### *General Concept*

The basic concept is to evaluate the potential of every square on the board from two standpoints: “win” and “threat.” The *win potential* corresponds to the expectation of winning by playing into a particular square. The *threat potential* is the win potential for the opponent.

We must first devise a way to assign a numerical value to the combinations of “O”s and “X”s on the board. This must be done so that we can compute the strategic value, or “potential,” of a given square.

### *Value Computation*

For each row (or column or diagonal), four possible configurations may occur — that is, if we exclude the case in which all three positions are already taken and we cannot play in a row. These configurations are shown in Figure 11.16. Situation “A” corresponds to the case in which all three squares are empty. Clearly, the situation has some possibilities and we will start by assigning the value “one” to each square in that case. The next case is shown in row “B” of Figure 11.16; it corresponds to the situation in which there is already an “X” in that row. If we were to place a second “X” in that row, we would be very close to a win. This is a desirable situation that has greater value than the preceding one. Let us add “one” to the value of each free square because of the presence of the “X”; the value of each square in that instance will be “two.”

Let us now consider case “C” in Figure 11.16, in which we have one “X” and one “O.” The configuration has no value since we will never be able to win in that particular row. The presence of an “O” brings the value of the remaining square down to “zero.”

Finally, let us examine the situation of row “D” in Figure 11.16, where there are already two “X”s. Clearly, this is a winning situation and it should have the highest value. Let us give it the value “three.”

The next concept is that each square on the board belongs to a row, a column, and possibly a diagonal. Each square should, therefore, be evaluated in two or three directions. We will do this and then we will total the potentials in every direction. For convenience, we will use an evaluation grid as shown in Figure 11.17. Every square in this grid has been divided into four smaller ones. These internal squares are used to display the potential of each square in each direction. The square

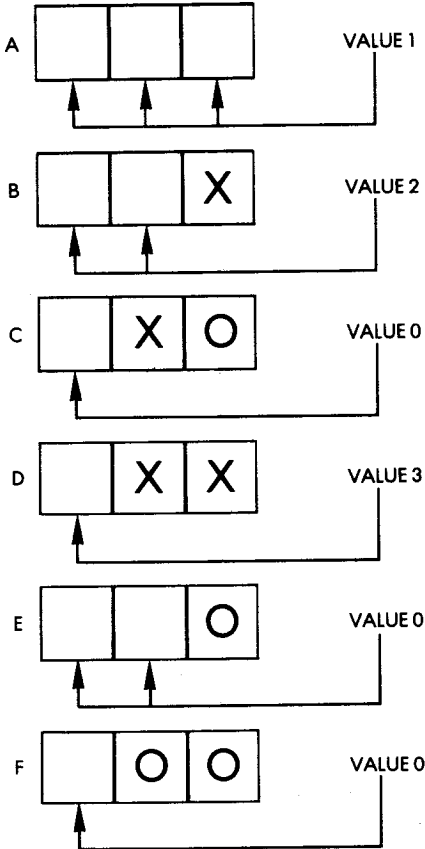


Fig. 11.16: The Six Combinations

H	V			
D	T			

Fig. 11.17: Evaluation Grid

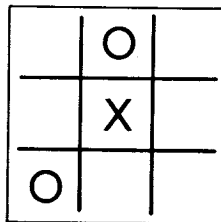
labeled "H" in Figure 11.17 will be used to evaluate the horizontal row potential. "V" will be used for the vertical column potential. "D" will be used for the diagonal potential. "T" will be used for the total of the previous three squares. Note that there is no diagonal value shown for four of the squares on the board. This is because they are not placed on diagonals. Also note that the center square has two diagonal values since it is at the intersection of two diagonals.

Once our algorithm has computed the total threat and win potentials for each square, it must then decide on the best square in which to move. The obvious solution is to move to the square having the highest win or threat potential.

Now we shall test the value of our algorithm on some real examples. We will look at some typical board configurations and evaluate them by using our algorithms to check if the moves it generates make sense.

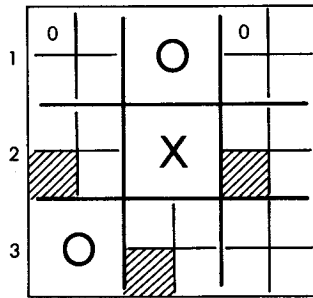
### *A Test of the Initial Algorithm*

Let us look at the situation in Figure 11.18. It is the player's turn ("O") to play. We will evaluate the board from two standpoints: potential for "X" and threat from "O." We will then select the square that has the highest total in each of the two grids generated and make our move there.

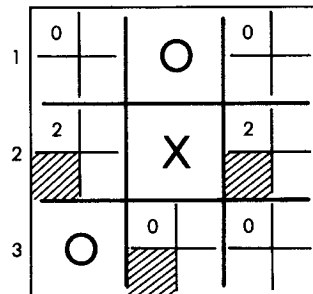


**Fig. 11.18: Test Case 1**

Let us first complete the evaluation grid for the first row. Since there is an "O" in the first row, the horizontal potential for the player is zero (refer to row C, Figure 11.16 and look up the value of this configuration). This is indicated in Figure 11.19. Let us now look at row 2: it contains two blank squares and an "X." Referring to line B of Figure 11.16, the corresponding value is "two." It is entered at the appropriate location in the grid, as shown in Figure 11.20. Finally, the



**Fig. 11.19: Evaluation Grid: Row 1 Potential**



**Fig. 11.20: Evaluating the Horizontal Potential**

third row is examined, and since there is an "O" in it, the row potential is "zero," as indicated in Figure 11.20. The process is then repeated for the three columns. The result is indicated in Figure 11.21.

The value of each square of column 1 is "zero," since there is an "O" at the bottom. Similarly, for column 2 the value is also "zero," and for column 3 it is "one" for each square, since all three squares are open (blank). (Refer to line A in Figure 11.16.)

The process is repeated for each of the two diagonals and the results are shown in Figure 11.22. Finally, the total is computed for each square. The results are shown in Figure 11.23. Remember that the total appears in the bottom right-hand corner of each square.

It can be seen that at this point, two squares (indicated by an arrow in Figure 11.23) have the highest total, "three." This indicates where

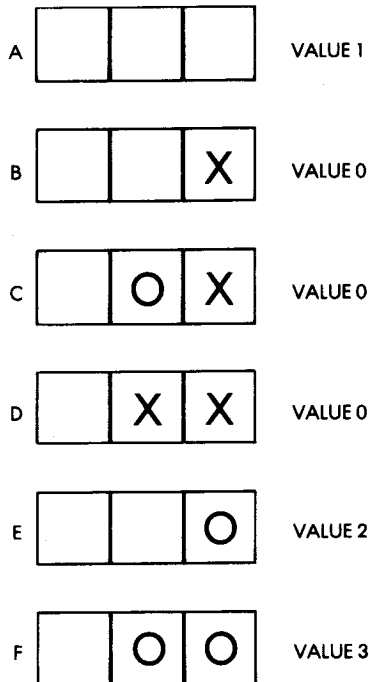


we should play. But wait! We have not yet examined the threat, i.e., the potential from our opponent "O."

We will now evaluate the threat posed by "O" by again computing the potential of each square on the board, but this time from "O's" standpoint. The position values for the six meaningful combinations are indicated in Figure 11.24. When we apply this strategy to our evaluation grid, we obtain the results shown in Figure 11.25. The square with the highest score is the one indicated by the arrow. It scores "four," which is higher than the two previous squares that were determined when we evaluated the potential for "X."

Using our algorithm, we decide that the move we should make is to play into square 1, as indicated in Figure 11.26.

Let us verify whether this was indeed the appropriate move, assuming that each player makes the best possible move. A continuation of the game is shown in Figure 11.27. It results in a draw.



**Fig. 11.24: Evaluation for "O"**



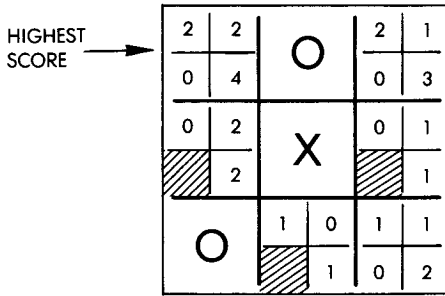


Fig. 11.25: Potential Evaluation

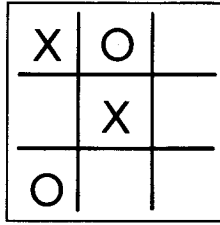


Fig. 11.26: Move for Highest Score

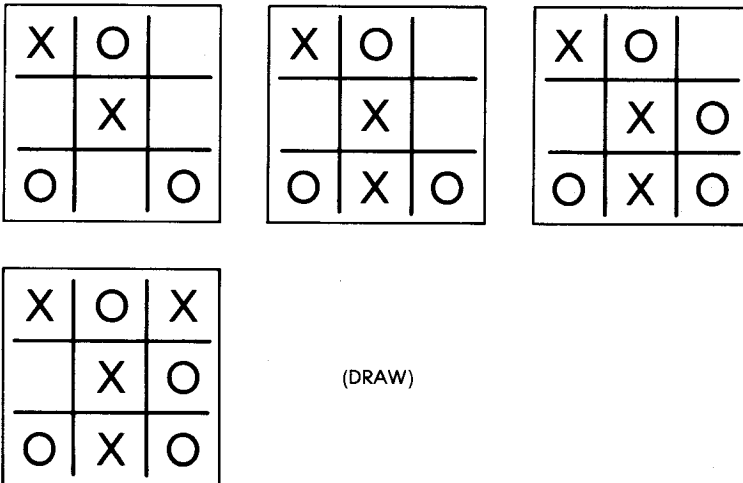
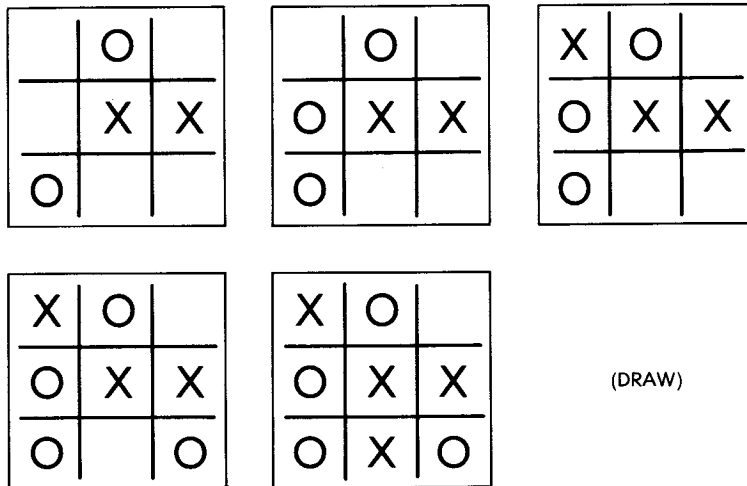


Fig. 11.27: Finishing the Game

Let us now examine what would have happened if we had not evaluated the threat and played only according to the highest potential for "X" as shown in Figure 11.23. This alternative ending for the game is shown in Figure 11.28. This game also results in a draw. In this instance, then, the square with the value "four" did not truly have a higher strategic value than the one with the value "three." However, our algorithm worked.

Let us now test our algorithm under more difficult circumstances.



**Fig. 11.28: An Alternative Ending for the Game**

### *Improving the Algorithm*

In order to test our algorithm, we should consider clear-cut situations in which there is one move that is best. To begin, we will assume that it is the player's turn. The first test situation, evaluated for "X," is illustrated in Figure 11.29, and the potential for "O" is shown in Figure 11.30. This time we have a problem. The highest overall potential is "four" for "X" in the lower right corner square. If the computer moved there, however, the player would win! At this point our algorithm should be refined.

We should note that whenever there are already two "X"s in a row the configuration should result in a very high potential for the third square. We should therefore assign it a value of "five" rather than

0	1	0	3	○
2	3		3	
2	1	X	2	0
	3			2
2	1	X	2	0
0	3		2	4

Fig. 11.29: Test #1 Evaluated for "X"

2	1	2	0	○
0	3		2	
0	1	X	0	1
	1			1
0	1	X	0	1
0	1		0	1

Fig. 11.30: Test #1 Evaluated for "O"

X		○		○	
2	2	X	2	0	
	4			2	
1	2	1	0	1	0
0	3		1	5	6

← PLAY THERE

Fig. 11.31: Test #2

“three” to ensure that we move there automatically. We have thereby identified and made our first improvement to the algorithm.

The second test situation is shown in Figure 11.31. Our algorithm assigns the value “six” to the lower right corner square (as indicated by an arrow in Figure 11.31). This is clearly the correct move. It works! Now, let us test the improvement we have made.

### *The First Move*

When the board is empty, our algorithm must decide which square should be occupied first. Let us examine what this algorithm does. (The results are shown in Figure 11.32.) The algorithm always chooses to move to the center. This is reasonable. It could be shown, however, that it is not indispensable in the game of Tic-Tac-Toe. In fact, having the computer always move to the center makes it appear “boring,” or simply “lacking imagination.” Something will need to be done about this. This will be shown in the final implementation.

1	1	1	1	1	1
1	3		2	1	3
1	1	1	1	1	1
	2	1   1	4		2
1	1	1	1	1	1
1	3		2	1	3

**Fig. 11.32: Moving to the Center**

### *Another Test*

Let us try one more simple situation. This situation is shown in Figure 11.33. Again, the recommended move is a reasonable one. The reverse situation is shown in Figure 11.34 and does, indeed, lead to a certain win. So far, our algorithm seems to work. Let us try a new trap.

### *A Trap*

The situation is shown in Figure 11.35. It is now “X’s” turn to play. Using our algorithm, we will move into one of the two squares having

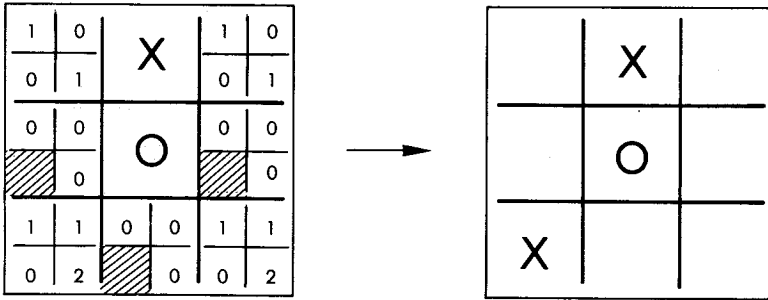


Fig. 11.33: A Simple Situation

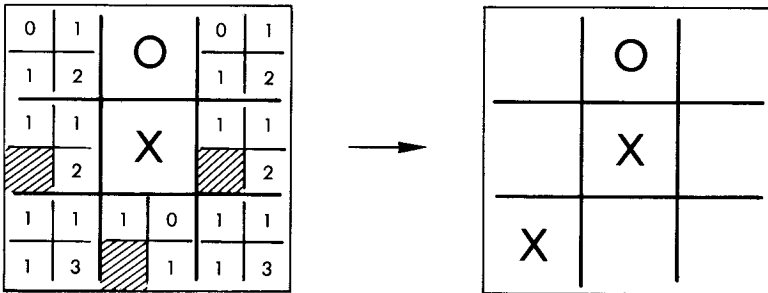


Fig. 11.34: A Reverse Situation

the total of "four." This time, however, such a move would be an error! Assuming such a move, the end of the game is shown in Figure 11.36. It can be seen that "O" wins. The move by "X" was an incorrect choice if there was a way to get at least a draw. The correct move that would lead to a draw is shown in Figure 11.37. This time, our algorithm has failed. Following is a simple analysis of the cause: it moved to a square position of value "four" corresponding to a high level of threat by "O," but left another square with an equal threat value unprotected (see Figure 11.35). Basically, this means that if "O" is left free to move in a square whose threat potential is equal to "four," it will probably win. In other words, whenever the threat posed by "O" reaches a certain threshold, the algorithm should consider alternative strategies. In this instance, the strategy should be to place an "X" in a square that is horizontally or vertically adjacent to

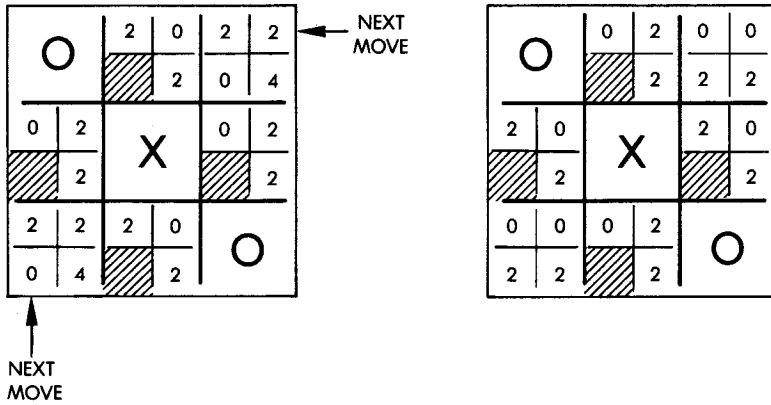


Fig. 11.35: Trap 3

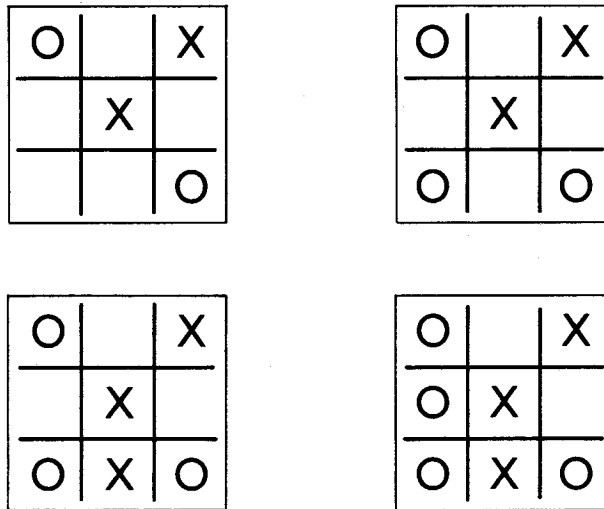
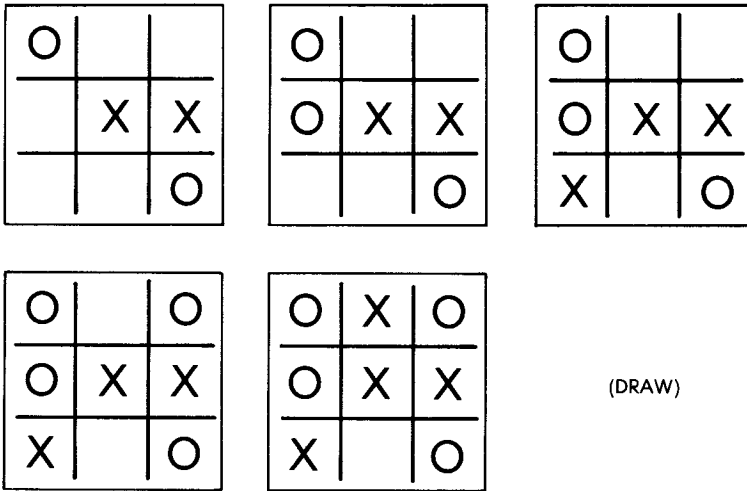


Fig. 11.36: End of Game

the first one in order to create an imminent “lose threat” for “O,” and thereby force “O” to play into the desired square. In short, this means that the algorithm should analyze the situation further or better still, analyze the situation one level deeper, i.e., one turn ahead. This is called two-ply analysis.



**Fig. 11.37: A Correct Move**

In conclusion, our algorithm is simple and generally satisfactory. However, in at least one instance, Trap 3 in Figure 11.35, it fails. We must therefore, include either a special consideration for this case, or we must analyze the situation one turn ahead every time and look at what would happen if we were to place an "X" or an "O" in every one of the available squares. The latter is actually the "cleanest" solution. Ideally, we should analyze all of the possible sequences until an end-of-game situation is obtained. The programming complexity, the storage required, and the time that would be needed to analyze the situations would, however, make this approach impractical. In a more complex game, such as chess or checkers, it would be necessary to use such a multi-ply analysis. For example, using only a two-ply analysis technique to design a simple chess game would not make it very interesting or very good. It would be necessary to use three-ply, four-ply or even more detailed analysis in order to make the game challenging.

If it is not possible to push the evaluation to a sufficient depth, the algorithm must be equipped with specific procedures that can detect special cases. This is the case with *ad hoc* programming, which can be considered "unclean" but actually results in a much shorter program and/or a lesser memory requirement. In other words, if the special situations in a game can be recognized in advance, then it is

possible to write a special-purpose program which will take these situations into account. The resulting program will usually be shorter than the completely general one. This type of program, however, can only be constructed if the programmer has an excellent initial understanding of the game.

In the game of Tic-Tac-Toe, the number of combinations is limited. This makes it possible to examine all possible combinations that can be played on the board and to devise a procedure that takes all of these cases into account. Since we are primarily limited here by the amount of available memory, we will construct an *ad hoc* algorithm that fits within 1K of memory. Alternative techniques will be proposed as exercises.

### The *Ad Hoc* Algorithm

This algorithm assigns a value to each square on the board depending on who has played there. Initially a value of "zero" is assigned to each square on the board. Every time the player occupies a square, however, the corresponding value of the square becomes "one." Every time the computer occupies a square, the value of that square becomes "four." This is illustrated in Figure 11.38. The value of "four" has been chosen so that it is possible to know the combination of moves in that row just by looking at the total of every row. For example, if a row consists of a move by the player and two empty squares, its "row-sum" is "one." If the player has played twice, its row-sum is "two." If the player has played three times, the row-sum is "three." Since "three" is the highest total that can be achieved in rows where only the player has played, the value of "four" has been assigned to a computer move. For example, if the value of a row is "five," we know that there is one computer move ("X"), one player move ("O"), and one empty square. The six possible patterns are shown in Figure 11.38. It can readily be seen that the row-sum values of "two" or "eight" are winning situations. A row-sum value of "five" is a blocked position, i.e., one that has no value for the player. If a win situation is not possible, then the best potentials are represented by either a value of "one" or a value of "four" depending on whose turn it is to play.

The algorithm is based on such observations. It will first look for a win by checking to see if there is a row-sum of value "eight." If this is the case, it will play there. If not, the algorithm will check for a so-called "trap" situation in which two intersecting rows each have a computer move in them and nothing else (the algorithm is always used



PATTERN	ROWSUM VALUE	
□ □ □	0	
○ □ □	1	
○ ○ □	2	(WIN)
X □ □	4	
X X □	8	(WIN)
○ X □	5	(BLOCKED)

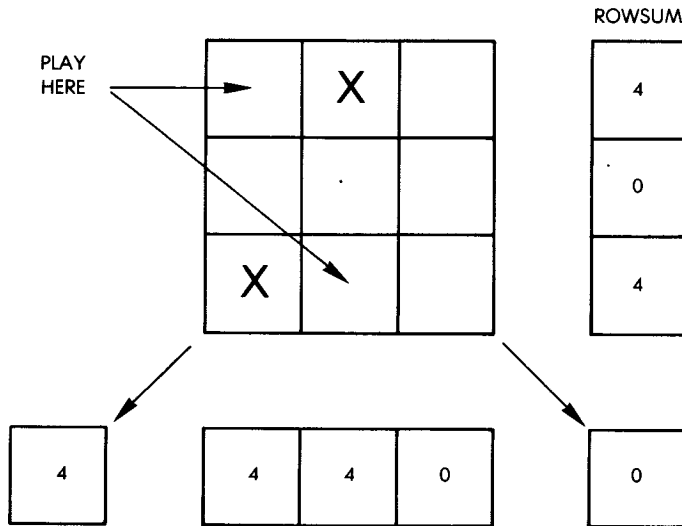
**Fig. 11.38: Row-sums**

for the computer's benefit). This is illustrated in Figure 11.39. By examining Figure 11.39, it becomes clear that each unoccupied square that belongs to two rows having a row-sum of "four" is a trap position where the algorithm should play. This is exactly what it does.

The complete flowchart for the board analysis is shown in Figure 11.40. Now, let us examine it in more detail. Remember that it is always the computer's turn when this algorithm is invoked.

First, it checks for a possible immediate win. In practice, we will examine all row-sums and look for one which has a total of "eight." This would correspond to a case where there are two computer moves in the same row with the last square being empty. (Refer to Figure 11.38.)

Next, we will check for a possible player win. If the player can win with the next move, the algorithm must block this move. To do so, it should scan the row-sums and look for one that has a total of "two,"



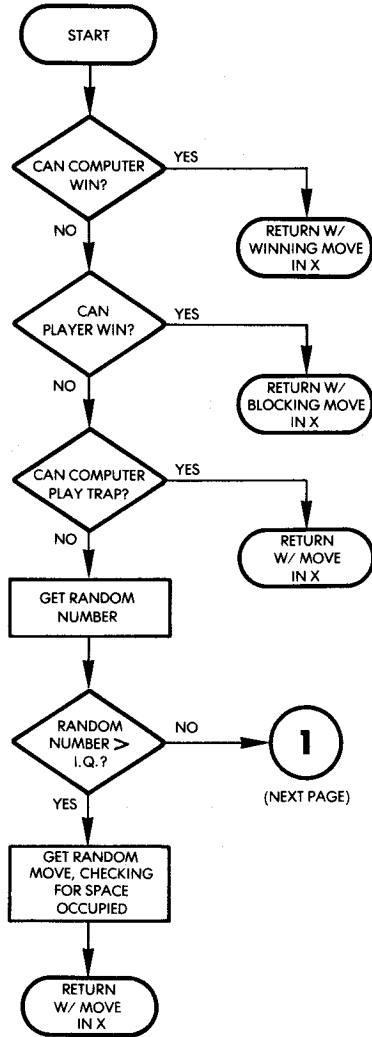
**Fig. 11.39: A Trap Pattern**

which would indicate a winning combination for the player. (Refer to Figure 11.38.)

At this point the algorithm should check to see if the computer can play into any of the trap positions defined above. (See Figure 11.39 for an example.)

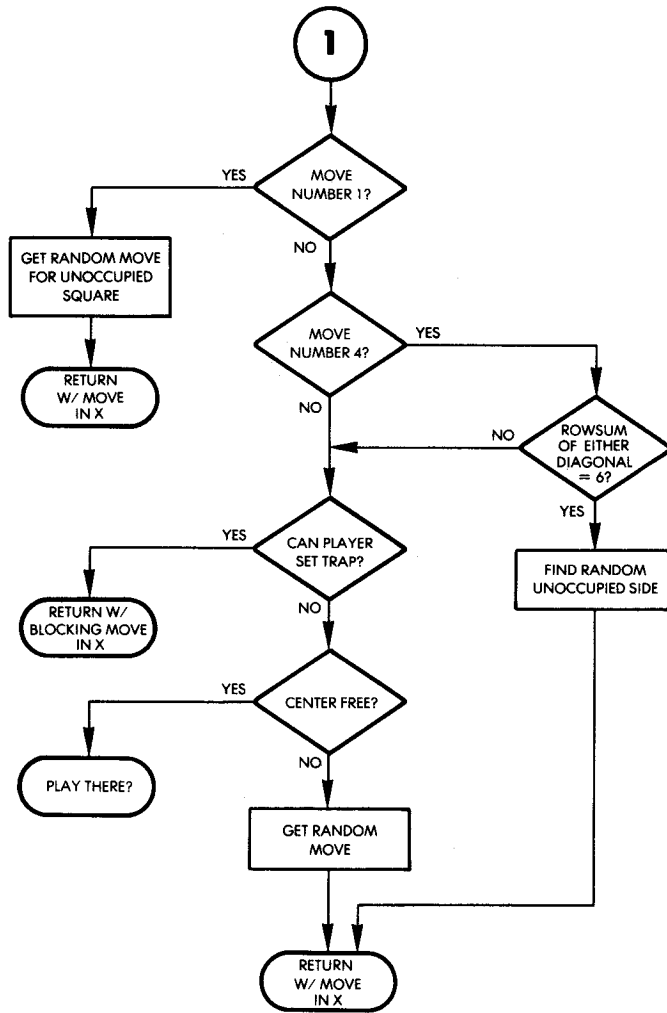
One more feature has been built into the algorithm: the computer is equipped with a variable IQ level, i.e., with a variable level of intelligence. The above moves are ones that any "reasonable computer" must make. From this point on, however, the algorithm can let the computer make a few random moves and even possible mistakes if its intelligence level is set to a low level. In order to provide some variety to the game, we will obtain a random number, compare it to the IQ, and vary our play depending upon the results. If the IQ is set to the maximum, the program will always execute the right branch of the flowchart; however, if the IQ is not set to the maximum, it will sometimes execute the left branch. Let us follow the right branch of the flowchart. At this point, we will check for two special situations that correspond to moves #1 and #4 in the game.

For the first situation, i.e., the first move in a game, the algorithm will occupy any position on the board. That way, its behavior will be different every time and, thus, appear "intelligent."



**Fig. 11.40: Board Analysis Flowchart**

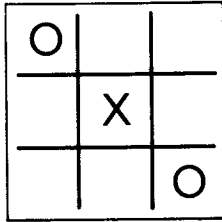
For the next situation we must look at move #4. It is the computer's turn. In other words, the player started the game (move #1), the computer responded (move #2), then the player made his or her second move (move #3), and it is now the computer's turn. In short, in the game thus far, the player has played twice and the computer has



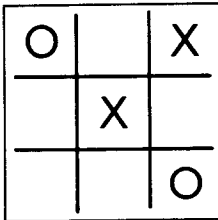
**Fig. 11.40: Board Analysis Flowchart (Continued)**

played once. At this point, we want to check to see if the first three moves have all been made along one of the diagonals. If so, since the player has made two moves and the computer has made one, the row-sum of one of the diagonals will be “six.” The algorithm must check explicitly for this. If the first 3 moves have all been made along a

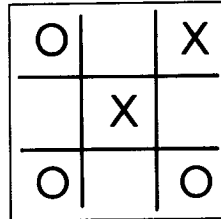
diagonal, the computer must move to a side position. This is a special situation which must be built into the algorithm, or it cannot be guaranteed that the computer (assuming the highest IQ level) will win every time. This situation is illustrated in Figure 11.41. Note that if straightforward logic was used, the algorithm would play into one of the free corners since a threat exists from the player that he or she might play there, and thereby set up a trap situation. The results of such an action are shown in Figure 11.42. By looking at this illustra-



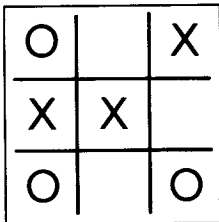
**Fig. 11.41: The Diagonal Trap**



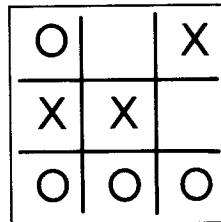
COMPUTER



PLAYER



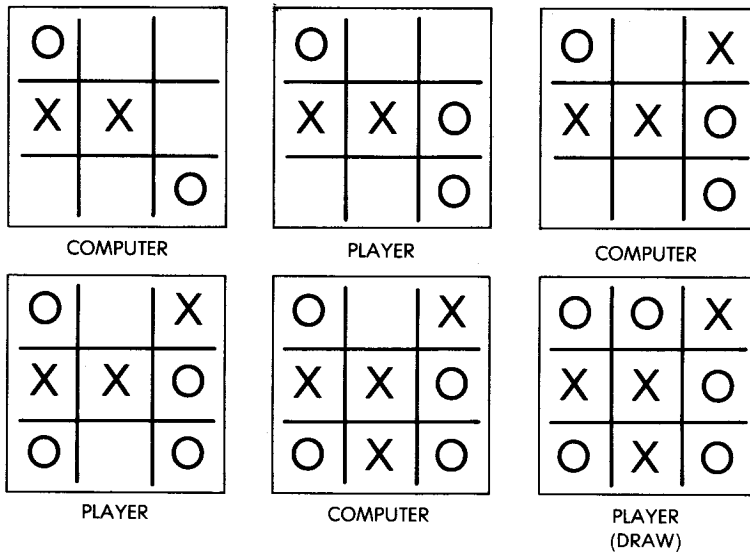
COMPUTER



PLAYER  
(WINS)

**Fig. 11.42: Falling Into the Diagonal Trap**

tion, it can be seen that such a move would result in a loss. However, let us examine what happens if we play on one of the sides. This situation is illustrated in Figure 11.43; it results in a draw. This is clearly the move that should be made. This is a relatively little-known trap in the game of Tic-Tac-Toe, and a provision must be built into the algorithm so that the computer will win.



**Fig. 11.43: Playing to the Side**

If it was not the fourth move, or if there was not a diagonal trap set, the next thing the computer should do is to check to see if the player can set a trap. (Refer to the flowchart in Figure 11.40.) If the player can set a trap, the computer plays in the appropriate square to block it. Otherwise, the computer moves to the center square, if available; if that is not possible, it moves randomly to any position.

Since this algorithm was built in an *ad hoc* fashion, it is difficult to prove that it wins or achieves a draw in all cases. It is suggested that you try it on a board or that you try out the actual program on the Games Board. You will discover that in all conditions under which it has been tested, the computer always wins or achieves a draw. If the computer keeps winning, however, its IQ level will drop, and eventually it will allow the player to win. As an example, some sequences obtained on the actual board are shown in Figure 11.44.

ADVANCED 6502 PROGRAMMING

COMPUTER	PLAYER	COMPUTER	PLAYER	COMPUTER	PLAYER
4	5		5		6
7	1	1	6	5	4
9	8	4	7	1	9
2	(DRAW)	3	2	3	7
8	5	8	9	2	(LOSS)
6	3	(DRAW)		5	6
7	9		5	8	4
1	4	3	4	9	2
(DRAW)		6	9	7	(LOSS)
2	5	1	2		6
9	1	8	7	1	5
7	8	(DRAW)		4	7
6	3		2	3	2
(DRAW)		5	1	8	9
8	5	3	7	(DRAW)	
1	7	4	6	9	5
3	2	9	8	3	6
6	9	(DRAW)		4	2
(DRAW)			1	8	7
6	5	5	3	(DRAW)	
4	8	2	8		
2	3	9	6		
7	1	7	4		
(DRAW)		(DRAW)			

Fig. 11.44: Actual Game Sequences

***Suggested Modifications***

**Exercise 11-1:** *Designate a special key on the Games Board that, when pressed will display the computer's IQ level.*

**Exercise 11-2:** *Modify the program so that the IQ level of the computer can be changed at the beginning of each game.*

***Credits***

The *ad hoc* algorithm which was described in this section is believed to be original. Eric Novikoff was the main contributor. "Scientific American" (selected issues from 1950 through 1978), as well as Dr. Harvard Holmes must also be credited with having provided several original ideas.

**Alternative Strategies**

Other strategies can also be considered. In particular, a short program can be designed by using tables of moves that correspond to various board patterns. The tables can be short because when symmetries and rotations are taken into account, the number of situations that can be represented is limited. This type of approach results in a shorter program, however, the program is somewhat less interesting to design.

**Exercise 11-3:** *Design a Tic-Tac-Toe program using this type of table.*

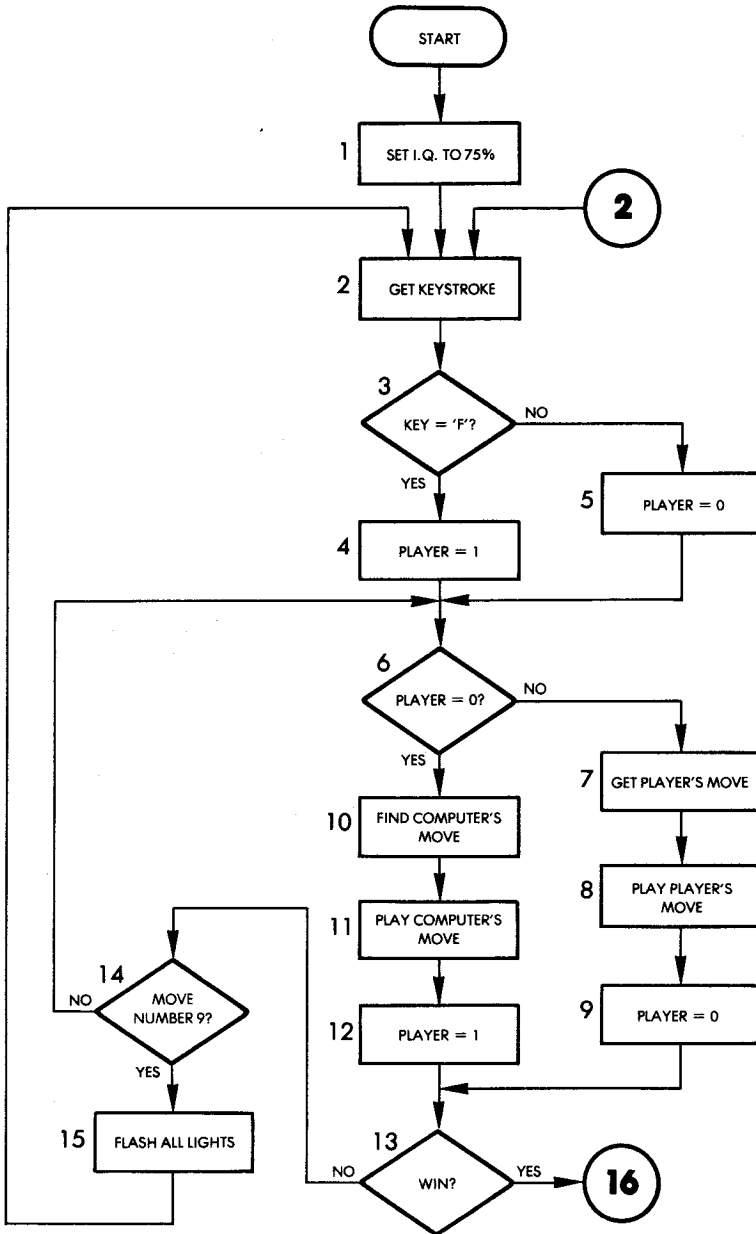
**THE PROGRAM**

The overall organization of the program is quite simple. It is shown in Figure 11.42. The most complex part is the algorithm that is used to determine the next move by the computer. This algorithm, called "FINDMOVE," was previously described.

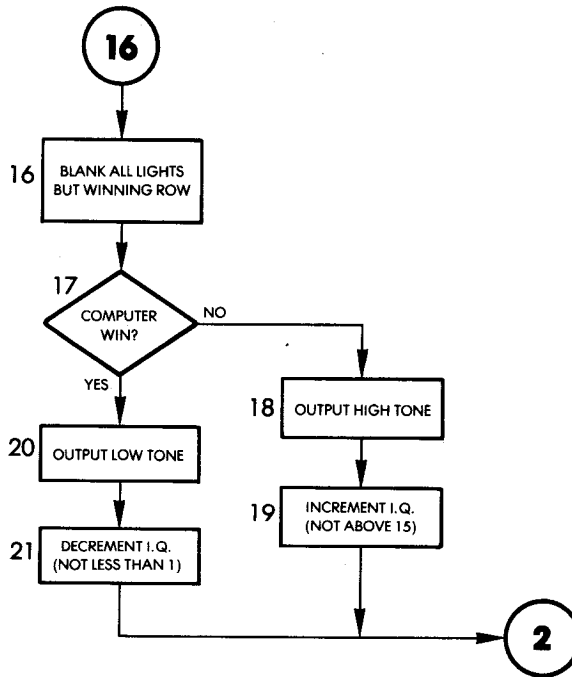
Let us now examine the overall program organization. The corresponding flowchart is shown in Figure 11.45.

1. The computer IQ level is set to 75 percent.
2. The user's keystroke is read.
3. The key is checked for the value "F." If it is an "F," the player starts; otherwise the computer starts. Depending on the value of the key pressed, the flowchart continues into boxes 4 or 5, then to 6.





**Fig. 11.45: Tic-Tac-Toe Flowchart**



**Fig. 11.45: Tic-Tac-Toe Flowchart (Continued)**

If the player starts (PLAYER is not equal to "0"), then we move to the left side of the flowchart.

7. The key, pressed by the player specifying his or her move, is read and the move is displayed on the board.
8. The corresponding LED is lit on the board. It then becomes the computer's turn to play and the variable PLAYER is set to "0" in box 9.

When exiting from box 6, if it is the computer's turn, we move to box 10.

11. The next move to be made by the computer must be computed at this time.

This is the complex algorithm we have described above.

11. Next, the computer's move is displayed.
12. PLAYER is reset to "one" to reflect the fact that it is now the player's turn.

After either party has moved, the board is checked for a winning se-

quence of lights in box 13. If there is not a winning sequence of lights, we move to the left on the flowchart.

14. We next check to see if all moves have been exhausted: we check for move #9. If the ninth LED is lit and a winning situation has not been detected, it is a draw, and all lights on the board must be flashed.
15. We flash all the LEDs on the board. Then, we return to box 6 and the next player plays.

When exiting from box 13, if there is a win situation, this fact must be displayed:

16. All of the lights are blanked except for the winning three LEDs. Next, it must be determined by the algorithm whether the player or the computer has won.
17. A determination is made as to whether it was the player or the computer who won. If the computer has won, we branch to the right on the flowchart.
18. A low frequency tone is sounded.
19. The computer's IQ is decremented (to a minimum of 0).

The situation for a player win, shown in boxes 20 and 21, is analogous.

The general program flow is straightforward. Now, we shall examine the complete information. The subroutine which analyzes the board situation is called "ANALYZE" and uses "UPDATE" as a subroutine to compute the values of various board positions.

### Data Structures

The main data structure used by this program is a linear table with three entry points that are used to store the eight possible square alignments on the board. When evaluating the board, the program will have to scan each possible alignment for three squares every time. In order to facilitate this process, all possible alignments have been listed explicitly, and the memory organization is shown in Figure 11.46.

The table is organized in three sections starting at RWPT1, RWPT2, and RWPT3 (RWPT stands for "row pointer"). For example, the first elements RWPT1, RWPT2, and RWPT3, for the first three-square sequence are looked at by the evaluation routine. The sequence is: "0, 3, 6," as indicated by the arrows in Figure 11.43. The next three-square sequence is obtained by looking at the second entry in each RWPT table. It is "1, 4, 7," which is, in fact, the second column on our LED matrix.

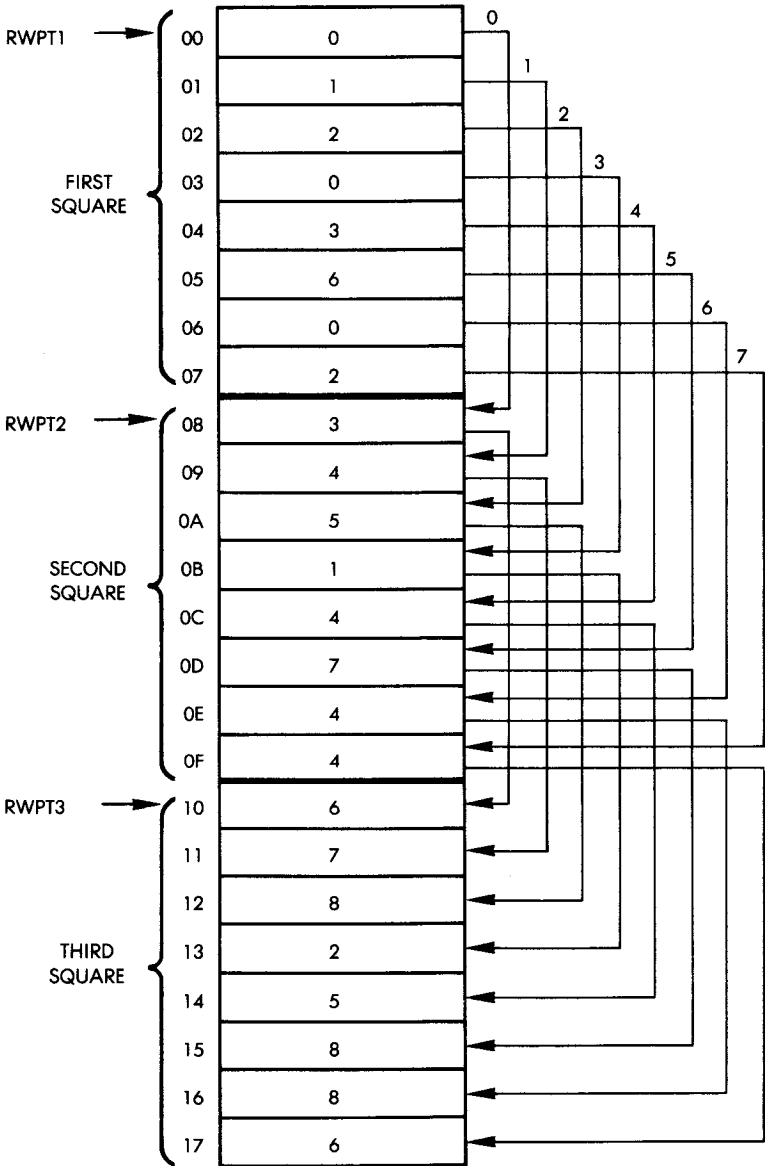


Fig. 11.46: Tic-Tac-Toe Row Sequences in Memory

The table has been organized in three sections in order to facilitate access. To be able to access all of the elements successfully, it will be necessary to keep a running pointer that can be used as an index for efficient table access. For example, if we number our generalized rows of sequences from 0 to 7, "row" 3 will be accessed by retrieving elements at addresses  $RWPT1 + 3$ ,  $RWPT2 + 3$ ,  $RWPT3 + 3$ . (It is the sequence "0, 1, 2," as seen in Figure 11.46.)

### Memory Organization

Page 0 contains the RWPT table which has just been described, as well as several other tables and variables. The rest of the low memory is shown in Figure 11.47.

The GMBRD table occupies nine locations and stores the status of the board at all times. A value of "one" is used to indicate a position occupied by the player, and a value of "four" indicates a position occupied by the computer.

The SQSTAT table also occupies nine words of memory and is used to compute the tactical status of the board.

The ROWSUM table occupies eight words and is used to compute the value of each of the eight generalized rows on the square.

The RNDSCR table occupies six words and is used by the random number generator.

The remaining locations are used by temporary variables, masks, and constants, as indicated in Figure 11.47. The role of each variable or constant will be explained as we describe each routine in the program.

### High Memory

High memory locations are essentially reserved for input/output devices. Ports 1 and 3 are used, as well as interrupts. The corresponding memory map is shown in Figure 11.48. The interrupt-vector resides at addresses A67E and A67F. It will be modified at the beginning of the program so that interrupts will be generated automatically by the interval timer. These interrupts will be used to blink the LEDs on the board.

### Detailed Program Description

At the beginning of each game, the intelligence level of the computer is set at 75 percent. Each time that the player wins, the IQ level

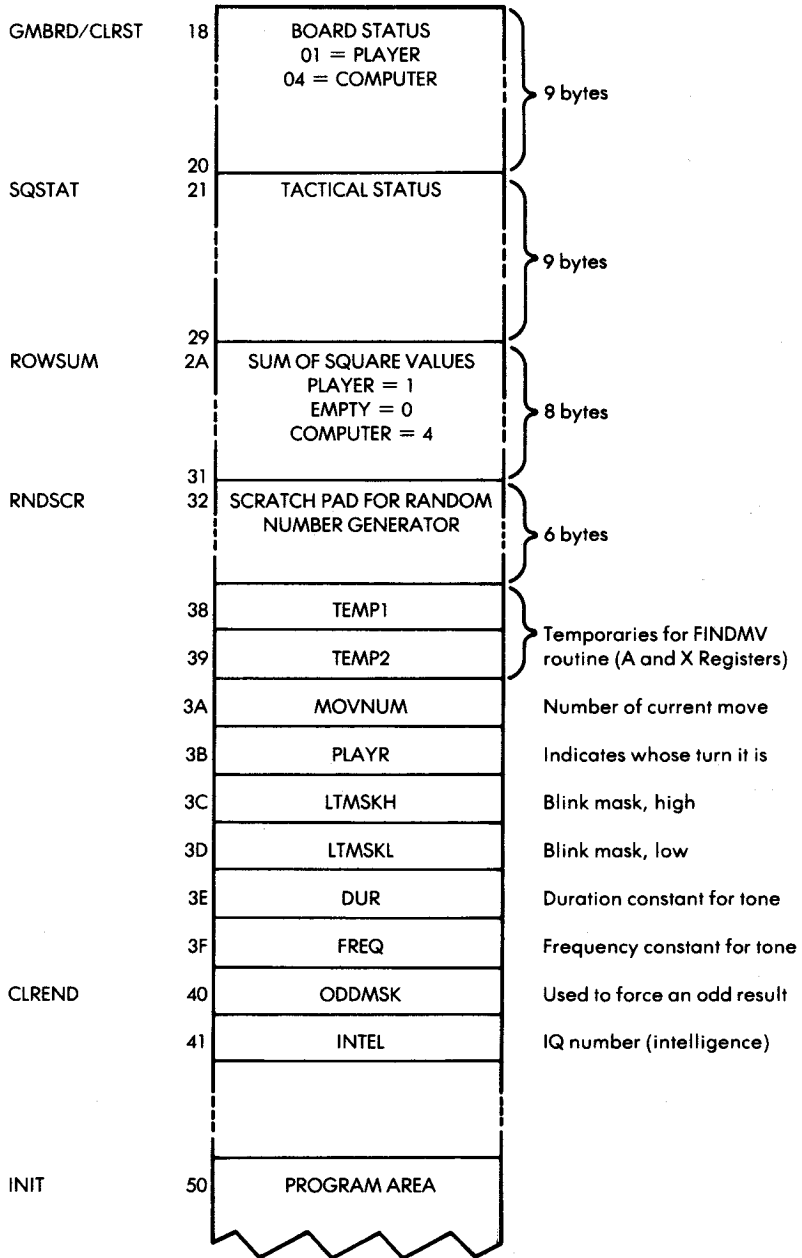


Fig. 11.47: Tic-Tac-Toe: Low Memory

ADVANCED 6502 PROGRAMMING

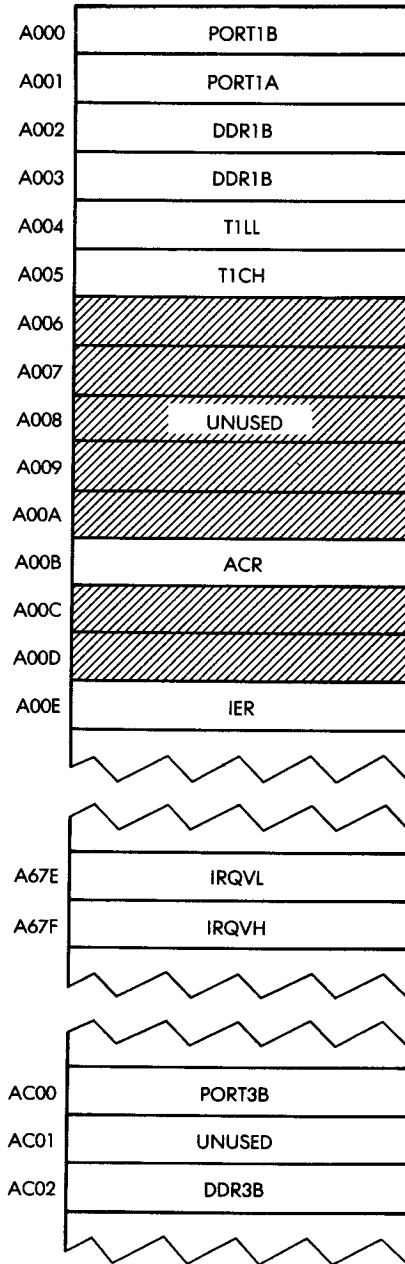


Fig. 11.48: Tic-Tac-Toe: High Memory

will be raised by one point. Each time that the player loses, it will be decremented by one point. It is initially set at the value 12 decimal:

```
START      LDA #12
           STA INTEL      Set IQ at 75%
```

Initialization occurs next:

```
RESTRT    JSR INIT
```

Let us examine the INIT subroutine which has just been called. It resides at address 0050 and appears on lines 0345 and following on the program listing. The first action of the initialization subroutine is to clear all low memory locations used by program variables. The locations to be cleared are those between CLRST and CLREND (see lines 41 and 57 of the program listing). Note that a seldom-used facility of the assembler — multiple labels for the same line — has been utilized to facilitate the clearing of the correct number of memory locations. Since it may be necessary to introduce more temporary variables in the course of program development, a specific label was assigned to the first location to be cleared, CLRST (memory location 18), and another to the last location to be cleared (CLREND). For example, memory location 18 corresponds both to CLRST and to GMBRD. The clearing operation should start at address CLRST and proceed forward forty locations (CLREND-CLRST). Thus, we first load the number of locations to be cleared into index register X, then we use a loop to clear all of the required locations:

```
INIT      LDA #0
           LDX #CLREND-CLRST
CLRALL    STA CLRST,X    Clear location
           DEX
           BPL CLRALL
```

After low memory has been cleared, the two starting locations for the random number generator must be seeded. As usual, the low-counter of timer 1 is used:

```
LDA TILL
STA RNDSCR + 1
STA RNDSCR + 4
```



## ADVANCED 6502 PROGRAMMING

Ports 1A, 1B, and 3B are then configured as outputs. The appropriate pattern is loaded into the data direction registers:

```
LDA #$FF
STA DDR1A
STA DDR1B
STA DDR3B
```

All LEDs on the board are turned off:

```
LDA #0
STA PORT1A
STA PORT1B
```

Next, the interrupt vector's address must be loaded with a new pointer. The address to be deposited there is the address of the interrupt handler, which has been designed to provide the regular blinking of the LEDs. (This process has already been explained in previous chapters.) The interrupt handler resides at address INTVEC. The high byte and the low byte of this address will be loaded in memory locations IRQVH and IRQVL, respectively. A special assembler symbol is used to denote the low byte of the interrupt vector: #<INTVEC. Conversely, the high byte is represented in assembly language by #>INTVEC. The new interrupt vector is loaded at the specified memory locations:

```
JSR ACCESS
LDA #<INTVEC
STA IRQVL           Low vector
LDA #>INTVEC
STA IRQVH           High vector
```

As usual, the interrupt-enable register must first be cleared, then the appropriate interrupt must be enabled:

```
LDA #$7F
STA IER             Clear register
LDA #$C0
STA IER             Enable interrupt
```

Timer 1 is set to the free-running mode:

```
LDA #$40
STA ACR
```

The latch for timer 1 is loaded with the highest possible count, "FFFF":

```
LDA #$FF
STA T1LL
STA T1CH
```

Finally, interrupts are enabled, the decimal mode is cleared as a precaution, and we terminate the initialization stage:

```
CLI
CLD
RTS
```

### **Back to the Main Program**

We are now at line 69 of the program listing. We read the next key closure on the keyboard:

```
JSR GETKEY
```

It is the first move. We must determine whether it is an "F" or not. If it is an "F," the player moves first; otherwise the computer moves first. Let us check it:

```
CMP #$F
BNE PLAYLP
```

It is the player's turn and this information is stored in the temporary variable PLAYR, shown in Figure 11.44:

```
LDA #01
STA PLAYR
```

It is time for a new move, and the move counter is incremented by one. Variable MOVNUM is stored in low memory. This is shown in Figure 11.44. It is now incremented:

```
PLAYLP    INC MOVNUM
```

## ADVANCED 6502 PROGRAMMING

At this point, PLAYR indicates whose turn it is to play. If it is set at "zero," it is the computer's turn. If it is set at "one," it is the player's turn. Let us check it:

```
LDA PLAYR  
BEQ CMPMU
```

We will assume here that it is the player's turn. PLAYR is reset to "zero" so that the computer will make its move next:

```
DEC PLAYR
```

The player's move is received by the PLRMV subroutine which will be described below. Let us allow the player to play:

```
JSR PLRMV
```

The move made by the player is specified at this point by the contents of the X register. Since it was the player's move, the corresponding code on the board's representation should be "01," which will be deposited in the accumulator:

```
LDA #01
```

We will now display the move on the board by blinking the proper LED. In addition, the corresponding ROWSUM will automatically be updated:

```
JSR UPDATE
```

The UPDATE routine will be described in detail below. Once the move has been made, we should check for a possible win. In the case of a win, the player has three blinking LEDs in a row, and the corresponding row total is automatically equal to "three." We will therefore simply check all eight rows for a ROWSUM of three:

```
LDA #03  
BNE WINTST
```

At address WINTST a test is performed for a winning configuration. Index register Y is loaded with "seven" and used as a loop

counter. All of the rows, 7 through 0, are checked for the value "three":

```

WINTST   LDY #7
TSTLP    CMP ROWSUM,4
          BEQ WIN
          DEY
          BPL TSTLP

```

Let us now continue with the player's move. We will examine the computer's move later. (The computer's move corresponds to lines 83-88 of the program listing, which have not been described yet.) A maximum of nine moves is possible in this game. Let us verify whether or not we have reached the end of the game by checking the value of MOVNUM, which contains the number of the current move:

```

LDA MOVNUM
CMP #9
BNE PLAYLP

```

This is the end of our main loop. At this point, a branch occurs back to location PLAYLP, and execution of the main program resumes.

If we had reached the end of the game at this point, the game would be a tie, since there has not been a winner yet. At this point all of the lights on the board would be set blinking and then the game would restart. Let us set the lights blinking:

```

LDA #$FF
STA LTMSKL
STA LTMSKH
BNE DLY

```

The delay is introduced to guarantee that the lights will be blinked for a short interval. Let us now examine the end-of-game sequence.

When a win situation is found, it is either the player's win or the computer's win. When the player wins, the row total is equal to "three." When the computer wins, the row total is equal to "twelve." (Recall that each computer move results in a value of "four" for the square. Three squares in a row will result in  $3 \times 4 = 12$ .) If the computer won, its IQ will be decremented:

## ADVANCED 6502 PROGRAMMING

```
WIN CMP#12
BEQ INTDN
```

At this point a jump would occur to INTDN, where the intelligence level will be decreased (intelligence lowered).

A losing tone will be generated to indicate to the player that he or she has lost. The corresponding frequency constant is "FF," and it is stored at address `FREQ`:

```
INTDN    LDA #$FF
          STA FREQ
```

The intelligence level will now be decreased unless it has already reached "zero" in which case it will remain at that value:

```
LDA INTEL
BEQ GTMSK
DEC INTEL
```

For a brief time the winning row will be illuminated on the board, and the end-of-game tone will be played. First, we clear all LEDs on the board:

```
GTMSK    LDA #0
          STA PORT1A
          STA PORT1B
```

At this point, the number of the winning row is contained in index register Y. The three squares corresponding to that row will simply be retrieved from the `RWPT` table. (See Figure 11.43.) Let us display the first square:

```
LDX RWPT1,Y
JSR LEDLTR
```

The `LEDLTR` routine will be described below. It lights up the square whose number is contained in register X. Let us now display the next square:

```
LDX RWPT2,Y
JSR LEDLTR
```

Then, the third one:

```
LDX RWPT3,Y
JSR LEDLTR
```

At this point, we should turn off all unnecessary blinking LEDs on the board. The new pattern to be blinked is the one with the winning row and we must, therefore, change the LTMSKL mask:

```
LDA PORT1A
AND LTMSKL
STA LTMSKL
```

We now do the same for Port 1B:

```
LDA PORT1B
AND LTMSKH
STA LTMSKH
```

**Exercise 11-4:** *Subroutine LEDLTR on line 125 of the program listing has just lit the third LED on the board for the winning row. Immediately after that, we start reading the contents of Port 1A, and then Port 1B.*

*There is, however, the theoretical possibility that an interrupt might occur immediately after LEDLTR, that might change the contents of Port 1A. Would this be a problem? If it would not be a problem, why not? If it would, modify the program to make it always work correctly.*

At this point, Ports A and B contain the appropriate pattern to light the winning row. If the player has won, the blink masks LTMSKL and LTMSKH contain the same pattern, and will blink the row. We are now ready to sound the win or lose tone. The duration is set at "FF":

```
LDA #$FF
STA DUR
```

The frequency, FREQ, was set above. We simply have to play it:

```
LDA FREQ
JSR TONE
```

## ADVANCED 6502 PROGRAMMING

A delay must be provided:

```
DLY          JSR DELAY
```

We are now ready to start a new game with the new intelligence level of the computer:

```
JMP RESTART
```

### *Back to WIN*

Let us now go back to line 103 of the program listing and examine the case in which the computer did not win (i.e., the player won). A different frequency constant is loaded at location `FREQ`:

```
LDA #30  
STA FREQ
```

Since the player won, the intelligence level of the computer will be raised this time. Before it is raised, however, it must be checked against the value “fifteen,” which is our legal maximum:

```
LDA INTEL  
CMP #$0F  
BEQ GTMSK  
INC INTEL
```

The sequence was exactly analogous to the one in which the computer wins, except for a different tone frequency, and for the fact that the intelligence level of the computer is increased rather than decreased.

### *The Computer Moves*

Let us now go back to line 83 of the program listing and describe what happens when the computer makes a move. Variable `PLAYR` is incremented, then a delay is provided to simulate “thinking time” for the computer:

```
COMPMV      INC PLAYR  
            JSR DELAY
```

The computer move is determined by the `ANALYZ` routine described

below:

### JSR ANALYZ

The computer's move is entered as a "four" at the appropriate location on the board:

```
LDA #04
JSR UPDATE
```

Next, we check all of the rows for the possibility of a computer win, i.e., for a total of "twelve":

```
WINTST LDA #12
LDY #7
```

and so on. We are now back in the main program described previously.

When the program segment outlined above is compared to the one that is used for the player's move, we find that the primary difference between the two is that the move was specified by the ANALYZ routine rather than being picked up from the keyboard. This routine is the key to the level of intelligence of the algorithm. Let us now examine it.

### Subroutines

#### *The ANALYZE Subroutine*

The ANALYZ subroutine begins at line 143 of the program listing. The corresponding conceptual flowchart is shown in Figure 11.40. In the ANALYZ subroutine the ODDMSK is first set to "zero."

```
ANALYZ LDA #0
STA ODDMSK
```

We now check for the possibility of a computer win during its next turn. If that possibility exists, we clearly must play into the winning square. This will end the game. A winning situation is characterized by a total of "eight" in the corresponding row; therefore let us deposit the total "eight" into the accumulator:



## ADVANCED 6502 PROGRAMMING

LDA #08

A winning situation will occur when the squares in rows 1, 2, or 3 all total "three" at the same time. Let us set our filter variable, X, for the number of rows that qualify, to "three":

LDX #03

We are now ready to use the FINDMV routine:

JSR FINDMV

The FINDMV routine will be described below. It must be called with the specified ROWSUM in A and with the number of times a match is found in X. It will systematically check all of the rows and squares. If a square is found, it exits with a specified square number in X and the Z flag is set to "0." Let us test it:

BNE DONE

If a winning move has been found, the ANALYZ routine exits. Unfortunately, this is not usually the case, and more analysis must be done.

The next special situation to be checked is to see if the player has a winning move. If so, it must be blocked. A winning situation for the player is indicated by a row total of "2." Let us load "2" into the accumulator and repeat the previous process:

```
LDA #02
LDA #03
JSR FINDMV
BNE DONE
```

If the player could make a winning move, this is the square where the computer should play and we exit to DONE; otherwise, the situation should be analyzed further.

We will now check to see if the computer can implement a trap. A trap corresponds to a situation in which a computer move has already been made in the same row. We would like to play at the intersection of two rows containing computer moves. This was explained above when the algorithm was described. This situation is characterized by  $A = 4$  and  $X = 2$ . Let us load the registers with the appropriate values

and call the FINDMV routine:

```
LDA #04
LDX #02
JSR FINDMV
BNE DONE
```

If we succeed, we exit to DONE; otherwise, we proceed down the flowchart diagrammed in Figure 11.40.

It is at this point that the computer can demonstrate either intelligent or ill-advised play. The behavior of the computer will be determined by its intelligence level. We will now obtain a random number and compare it to the computer's IQ. If the random number exceeds the computer's IQ, we will proceed to the left side of the flowchart in Figure 11.40 and make an ill-advised move (i.e., a random one). If the random number does not exceed the computer's IQ, we will make an intelligent move on the right side of the flowchart. Let us generate the random number:

```
JSR RANDOM
```

We truncate the random number to its right byte so that it does not exceed fifteen:

```
AND #$0F
```

and we compare it to the current IQ of the computer:

```
CMP INTEL
BEQ OK
BCS RNDMV
```

If the random number is higher than the IQ level stored in INTEL, we branch to RANDMV and play a random move. At this point, we will assume that the random number was not greater than the IQ level, and that the computer will play an intelligent move. We now proceed from line 162 (location "OK").

We will first check to see if this is move #1; then we check to see if this is move #4. Let us check for move #1:

```
OK          LPX MOVNUM
           CPX #1
```

## ADVANCED 6502 PROGRAMMING

If it is move #1, we occupy any square:

```
BEQ RNDMV
```

Let us now check for move #4:

```
CPX #4
```

If it is not move #4, we will check to see if the player can set a trap. This will be performed at location TRAPCK. Let us assume here that it is move #4.

```
BNE TRAPCK
```

This section will check both diagonals for the possibility of the sequence player-computer-player. If this sequence is found, we will play to the side. Otherwise, we will go back to the mainstream of this routine and check to see if the player can set a trap. The combination player-computer-player in a row is detected when the row totals "six." Therefore, we load the value "six" into the accumulator and check the corresponding diagonal. By coincidence, diagonals correspond to the sixth and seventh entries in our RWPT table. (See Figure 11.46.) Let us do it:

```
LDX #6  
TXA  
CMP ROWSUM,X  
REQ ODDRND
```

If a match is found, we branch to address ODDRND, where we will play to the side. This will be described below. If a match is not found we check the next diagonal:

```
INX  
CMP ROWSUM,X  
BEQ ODDRND
```

If, at that point, the test also fails for the second diagonal, we will check to see if the player can set a trap:

*Checking To See If the Player Can Set a Trap (TRAPCK)*

The possibility of a trap for the player is identified (as in the case of the computer), when two intersecting rows each contain only a player's move. This has been explained in the description of the algorithm above. The value of a row which is a candidate for a trap is thereby equal to "one" (one player's move). The parameters must, therefore, be set to  $A = 1$ , and  $X = 2$  before we can call the FINDMV routine:

```
TRAPCK    LDA #1
          LDX #2
          JSR FINDMV
          BNE DONE
```

If the proper location for a trap can be found, the next move is to play there. Otherwise, if possible, the computer moves to the center or, if the center is occupied, it makes a random move on the side.

```
          LDX GMBRD + 4
          BNE RNDMV
          LDX #5
          BNE DONE
```

*Playing a Random Move on the Side*

The four sides on the board are numbered externally 2,4,6 and 8, or internally 1,3,5, and 7. Any odd internal number specified for a move will result in our occupying a side position. If we want to occupy a side position, we simply load the value "one" in ODDMSK, and we guarantee that the random number generated will be one of the four corners. This is performed by entering at address ODDRND:

```
ODDRND    LDA #1
          STA ODDMSK
```

Generally, however, we may want to make a random move. This will be accomplished by generating and using any random number that is reasonable, i.e., by setting ODDMSK to "0" prior to entering at address RNDMV. Let us obtain a random number:

## ADVANCED 6502 PROGRAMMING

```
RNDMV      JSR RANDOM
```

Let us strip off the left byte:

```
AND #$0F
```

Then let us OR this random number with the pattern stored in ODDMSK. If the mask had been set to "0," it would have no effect on the random number. If the mask had been set to "1," however, it would result in our playing into one of the corners (the center is occupied here):

```
ORA ODDMSK
```

Since the random number which was generated was between "0" and "15," we must check to be sure that it does not exceed "9"; otherwise, it cannot be used:

```
CMP #9  
BCS RNDMV
```

We must now check to make sure that the space into which we want to move is not occupied. We load the square's number into index register X and verify the square's status by reading the appropriate entry of the GMBRD table (see the memory map in Figure 11.47):

```
TAX  
LDA GMBRD,X
```

If there is any entry other than "0" in this square, it means that it is occupied and we must generate another random number:

```
BNE RNDMV
```

We have selected a valid square and will now play into it. When we exit from this routine, the external LED number should be contained in X. It is obtained by adding "1" to the current contents of X, which happens to be the internal LED number:

```
INX  
DONE RTS
```

*FINDMV Subroutine*

This subroutine will evaluate the board until it finds a square which meets the specifications in the A and the X registers. The accumulator A contains a specified row-sum that a row must meet in order to qualify. Index register X specifies the number of times that a particular square must belong to a row whose row-sum is equal to the one specified by A.

The FINDMV subroutine starts with a square status of "0" for every square on the board. Every time it finds a square that meets the row-sum specification, it will increase its status by "1." Thus, at the end of the evaluation process, a square with a status of "1" is a square which meets the row-sum specifications once. A square with a status of "2" is one that meets the specification twice, etc.

The final selection is performed by FINDMV, which checks the value of each square in turn. As soon as it finds a square whose status matches the number contained in register X, it selects that square as one that meets the initial specification.

The complete flowchart for FINDMV is shown in Figure 11.49. Essentially, the subroutine operates in three steps. These steps are indicated in Figure 11.49. Step 1 is the initialization phase. Step 2 corresponds to the selection of all squares that meet the row-sum specifications contained in register A. The status of every empty square in a row that meets this specification is increased by one as all the rows are scanned. Step 3 is the final selection phase. In this phase, each square is looked at in turn until one is found whose status matches the value contained in X. As soon as one is found, the process stops. That square is the one that will be played by the computer. If a square is not found, the routine will exit, with the index X having decremented to "0," and this will be used as a failure flag for the calling routine.

Let us now examine the corresponding program. It starts at line 204 in the program listing.

*Step 1: Initialization*

Index registers X and A will be used in the body of this subroutine. Their initial contents must first be preserved in temporary memory locations. Addresses TEMP1 and TEMP2 are used for that purpose. (See Figure 11.47 for the memory map.)

Let us preserve X and A:

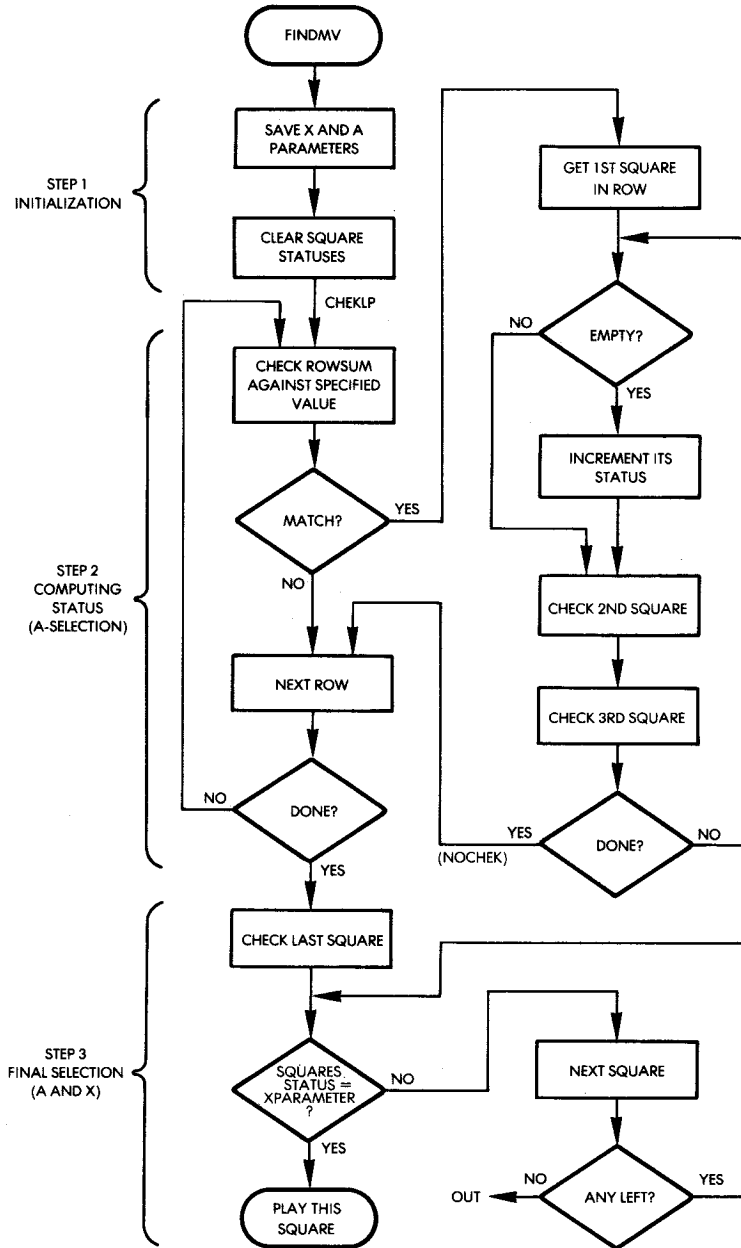


Fig. 11.49: FINDMV Flowchart

```

FINDMV      STX TEMP2
            STA TEMP1

```

The status of the board is then cleared. Each square's status must be set to "0." This is accomplished by loading the value "0" into the accumulator, then going through a nine cycle loop that will clear the status of each square in turn:

```

            LDA #0
            LDY #8
CLRLP      STA SQSTAT,4
            DEY
            BPL CLRLP

```

### *Step 2: Computing the Status of Each Square*

Each of the eight possible row-sums will now be examined in turn. If the row-sum matches the value specified in the accumulator on entry, each empty square within the specified row will have its status incremented by "1." If the row-sum value does not meet the minimum, the next one will be examined. Index register Y is used as a row pointer. The RWPT table described at the beginning of this program and shown in Figure 11.46 will be used to successively retrieve the three squares that form every row. Let us first initialize our counter:

```
LDY #7
```

Now, we will check the value of the corresponding row-sum:

```

CHEKLP     LDA TEMP1
            CMP ROWSUM,Y
            BNE NOCHEK

```

Let us assume at this point that the row-sum is indeed the correct one. We must now examine each of the three squares in the row. If the square is empty, we increment its status. The first step is to obtain the square's value by looking it up in the table, using index register Y as a displacement, and using addresses RWPT1, RWPT2, and RWPT3 successively as entry points into the row table. Let us try it for the first square:



```
LDX RWPT1,Y
```

Index register X now contains the square number. If the square is empty, a new subroutine, CNTSUB, is used to increment its status:

```
JSR CNTSUB
```

It will be described below.

Let us now do the same for the second and third squares:

```
LDX RWPT2,Y  
JSR CNTSUB  
LDX RWPT3,Y  
JSR CNTSUB
```

We have now completely scanned one row. Let us look to see if any more rows need to be checked:

```
NOCHEK    DEY  
          BPL CHECKLP
```

The process is repeated until all the rows have been checked. At this point, we enter into step 3 of FINDMV. (Refer to the flowchart in Figure 11.49.)

### *Step 3: Final Selection*

Index register X will be used as a square pointer. It will start with square #9 and continue to examine squares until one is found that meets the additional X register specifications, i.e., the number of times that the given square belongs to a row with the appropriate row-sum value. Let us initialize it:

```
LDX #9
```

Now, we compare the value of the square status with the value of the specified X parameter:

```
FNMTCH    LDA TEMP2  
          AND SQSTAT-1,X
```

If the square status matches the value of the parameter, we select this square:

```
BNE FOUND
```

Otherwise, we try the next one:

```

                DEX
                BNE FNMTCH
FOUND          RTS

```

**Exercise 11-5:** *Why are “AND” and “BNE” rather than “CMP” and “BEQ” used to find a matching square above? (Hint: decide what the difference in the program’s strategy would be.)*

#### *COUNTSUB Subroutine*

This subroutine is used exclusively by the FINDMV subroutine and increments the status of the square whose number is in register X, if the square is empty. First, it examines the status of the square by looking for its code in the GMBRD table:

```
CNTSUB        LDA GMBRD,X
                BNE NOCNT
```

If the square is occupied, an exit occurs. If it is not, the status value of the square is incremented:

```

                INC SQSTAT,X
NOCNT         RTS

```

#### *UPDATE Subroutine*

Every time a move is made, it must be displayed on the board. Then, the appropriate code must be stored in the board representation, i.e., in the table GMBRD. Finally, the new ROWSUMs must be computed and stored at the appropriate locations. These functions are accomplished by the UPDATE subroutine.

The player’s code is contained in the accumulator. The position into which the move is made is contained in register X. Since the number in index register X is the value of an external LED, it is first decremented in order to match the actual internal LED number:

UPDATE      DEX

The value must now be stored in the appropriate location of the GMBRD table which contains the internal representation of the board:

STA GMBRD,X

Note that the value of X is simply used as a displacement into the table. However, the accumulator happens to contain the appropriate code that is merely written at the specified location. At this point, UPDATE would like to display the move on the LEDs. It must first decide, however, whether to light a steady LED or make it blink. To do this, it must determine whether it is the player's move or the computer's move. It does this by examining the code contained in the accumulator. If the code is "four," it is the computer's move. If the code is "1," it is the player's move. Let us examine it:

CMP #04  
BEQ NOBLNK

If it is the computer's move, a branch will occur to address NOBLNK; otherwise, we proceed. Let us assume for the time being that it was the player's move:

JSR LIGHT

The LIGHT subroutine is used to set the bit blinking and will be described below. Upon exit from LIGHT, the accumulator contains the bit in the position that is required to set the LED blinking. At this point, the blink masks should be updated:

ORA LTMSKL  
STA LTMSKL

If the carry was "zero" upon completion of LIGHT, one of the bits zero through seven had been set and we are done:

BCC NOBLNK

Otherwise, if the carry had been set to 1, it would mean that LED #9 had to be set, i.e., that the high order part of the mask had to be

modified. Let us do it:

```
LDA #01
STA LTMSKH
```

At this point, the LED masks are properly configured and we can give the order to light the LEDs:

```
NOBLNK   JSR LEDLTR
```

The LEDLTR routine lights up the LED specified by register X. Note that if it was a computer move, this LED will remain steadily on. If it was a player's move, this LED will be turned off and on automatically as interrupts occur.

Next, we must update all row-sums. Index register X is used as a row pointer. We will look at all eight rows in turn. In anticipation of the addition, the carry bit is cleared:

```
ADDROW   LDX #7
          CLC
```

The first square of row eight is examined first:

```
LDY RWPT1,X
```

Note that index register Y will contain the internal square number following this instruction. This will immediately be used for another indexed operation. The contents of the square will be read so that the new row-sum may be computed. (The row-sum for that row may or may not be the same as before. No special provision has been made for restricting the search to the two or three rows affected.) All rows are examined in turn, and all row-sums are re-computed to keep the program simple.

Let us obtain the current square's value:

```
LDA GMBRD,Y
```

The GMBRD table is accessed using index register Y as a displacement. Note that the two instructions shown above implement a two-level indexing operation. This is a most efficient data retrieval technique. At this point, the accumulator contains the value of the first

## ADVANCED 6502 PROGRAMMING

square. It will be added to the value of the two following squares. The process will now be repeated:

```
LDY RWPT2,X
ADC GMBRD,Y
```

The number of the second square has been looked up by the LDY instruction and its value stored in Y. The addition instruction looks up the actual value of that square from GMBRD, and adds that value to the accumulator. This process is performed one more time for the third square:

```
LDY RWPT3,X
ADC GMBRD,Y
```

The final value contained in the accumulator is then stored in the ROWSUM table at the position specified by the value of index register X (the row index):

```
STA ROWSUM,X
```

The next row will now be scanned:

```
DEX
BPL ADDROW
```

If X becomes negative, we are done:

```
RTS
```

### *LED LIGHTER Subroutine*

This subroutine assumes upon entry that register X contains the internal LED number of the LED on the board which must be turned on. The subroutine will therefore turn that LED on using the LIGHT subroutine, which converts a number in register X into a bit pattern in the accumulator for the purpose of turning on the specified LED:

```
LEDLTR JSR LIGHT
```

At this point, either Port 1A or Port 1B must be updated. Let us

assume initially that it is Port 1A (if it is not Port 1A, which we can find out by examining the carry bit below, then the pattern contained in the accumulator is all zeroes and will not change the value of Port 1A):

```
ORA PORT1A
STA PORT1A
BCC LTRDN
```

The carry bit is tested. If it has been set to 1 by the LIGHT subroutine, then LED #9 must be turned on. This is accomplished by sending a "1" to Port 1B:

```
LDA #1
STA PORTB
RTS
```

#### *PLRMV Subroutine (Player's Move)*

This subroutine obtains one correct move from the player. It chirps to get his or her attention and waits for a keyboard input. If a key other than 1 through 9 is pressed, it will be ignored. Whenever the subroutine gets a move, it verifies that the square on the board is indeed empty. If the square is not empty, the subroutine will ignore the player's move. Let us first generate a chirp in order to get the player's attention:

```
PLRMV    LDA #$80
          STA DUR
          LDA #$10
          JSR TONE
```

Now, let us capture the key closure:

```
KEYIN    JSR GETKEY
```

We must now check to see that the key that is pressed is between 1 and 9. Let us first check to see that it is not greater than or equal to 10:

```
CMP #10
BCS KEYIN
```

Let us now verify that it is not equal to "zero":

```
TAX
BEQ KEYIN
```

Finally, let us verify that it does not correspond to a square that is already occupied:

```
LDA GMBRD-1,X
BNE KEYIN
RTS
```

**Exercise 11-6:** *Modify the PLRMV subroutine above so that a new chirp is generated every time a player makes an incorrect move. To tell the player that he or she has made an incorrect move, you should generate a sequence of two chirps, using a different tone than the one used previously.*

### ***LIGHT Subroutine***

This subroutine accepts an LED number in register X. It returns with the pattern to be output to the LEDs in the accumulator. If LED 9 is to be lit ( $X = 8$ ), the carry bit is set. This subroutine is straightforward and has been described previously:

```
LIGHT      STX TEMP1
            SEC
            ROL A
            DEX
            BPL SHIFT
            LDX TEMP1
            RTS
```

### ***DELAY Subroutine***

This is a classic delay subroutine that uses two nested loops that have a few extra instructions within the loop that are designed to waste time:

```
DELAY      LDY #$FF
DL1        LDX #$FF
DL2        ROL DUR
            ROR DUR
```

```

DEX
BNE DL2
DEY
BNE DL1
RTS

```

### *Interrupt Handling Routine*

Every time that an interrupt is received, the appropriate LEDs will be complemented (turned off if on, or on if off). The positions of the LEDs to be blinked are specified by the contents of the LTMSK masks. Two bytes are used in memory for the low and high halves, respectively. (See Figure 11.47 for the memory map.)

Turning the bits on or off is accomplished by an exclusive-OR instruction that is the equivalent of a logical complementation. Since this routine uses the accumulator, the contents of A must be preserved at the beginning of the routine. It is pushed onto the stack and restored upon exit. The subroutine is shown below:

```

INTVEC      PHA
             LDA PORT1A
             EOR LTMSKL
             STA PORT1A
             LDA PORT1B
             EOR LTMSKH
             STA PORT1B
             LDA TILL
             PLA
             RTI

```

**Exercise 11-7:** Notice the LDA TILL instruction above. The next instruction in this subroutine is PLA. It will overwrite the contents of the accumulator with the words pulled from the stack. The contents of the accumulator, as read from TILL, will therefore be immediately destroyed. Is this a programming error that was accidentally left in this program? If not, what purpose does it serve? (Hint: this situation has been encountered before. Refer to one of the earlier chapters.)

### *INITIALIZE Subroutine*

This subroutine was described in the body of the main program above.



*RANDOM and TONE Subroutines*

These two subroutines were described in previous programs.

**SUMMARY**

This program was the most complex we have developed. Several algorithms have been presented, and one complete implementation of an *ad hoc* algorithm has been studied in great detail. Readers interested in games of strategy and programming are encouraged to implement an alternative algorithm.

```

LINE # LOC   CODE      LINE
0002 0000      ; 'TICTAC'
0003 0000      ; PROGRAM TO PLAY TIC-TAC-TOE ON SYM-1
0004 0000      ; COMPUTER WITH 3X3 LED MATRIX AND HEX KYBD.
0005 0000      ; AT BEGINNING OF GAME, IF 'F' KEY IS
0006 0000      ; PRESSED, PLAYER GOES FIRST, ANY OTHER KEY,
0007 0000      ; COMPUTER GOES FIRST. THEREAFTER, TO MAKE
0008 0000      ; A MOVE, PRESS KEY CORRESPONDING TO NUMBER
0009 0000      ; OF SQUARE DESIRED.
0010 0000      ;
0011 0000      ; LINKAGES:
0012 0000      ;
0013 0000      GETKEY = $100
0014 0000      ACCESS = $B886
0015 0000      ;
0016 0000      ; I/O:
0017 0000      ;
0018 0000      PORT1A = $A001          ;** 6522 VIA #1....
0019 0000      DDR1A = $A003
0020 0000      PORT1B = $A000
0021 0000      DDR1B = $A002
0022 0000      IER = $A00E          ; INTERRUPT ENABLE REGISTER.
0023 0000      ACR = $A00B          ; AUXILIARY CONTROL REGISTER.
0024 0000      TILL = $A004          ; TIMER 1 LATCH LOW.
0025 0000      TICH = $A005          ; TIMER 1 LATCH HIGH.
0026 0000      PORT3B = $AC00          ;**6522 VIA #3....
0027 0000      DDR3B = $AC02
0028 0000      IRQVL = $A67E
0029 0000      IRQVH = $A67F
0030 0000      ;
0031 0000      ; TABLE OF SQUARES IN BOARD'S 8 ROWS.
0032 0000      ;
0033 0000      * = 0
0034 0000      ;
0035 0000 00      RWPT1 .BYTE 0,1,2,0,3,6,0,2
0035 0001 01
0035 0002 02
0035 0003 00
0035 0004 03
0035 0005 06
0035 0006 00
0035 0007 02
0036 0008 03      RWPT2 .BYTE 3,4,5,1,4,7,4,4
0036 0009 04
0036 000A 05
0036 000B 01
0036 000C 04
0036 000D 07
0036 000E 04
0036 000F 04
0037 0010 06      RWPT3 .BYTE 6,7,8,2,5,8,8,6
    
```

**Fig. 11.50: Tic-Tac-Toe Program**

```

0037 0011 07
0037 0012 08
0037 0013 02
0037 0014 05
0037 0015 08
0037 0016 08
0037 0017 06
0038 0018
0039 0018
0040 0018
0041 0018
0042 0018
0043 0021
0044 0021
0045 002A
0046 0032
0047 0032
0048 0032
0049 003B
0050 0039
0051 003A
0052 003B
0053 003C
0054 003D
0055 003E
0056 003F
0057 0040
0058 0040
0059 0041
0060 0041
0061 0042
0062 0042
0063 0042
0064 0042
0065 0200
0066 0200 A9 0C
0067 0202 B5 41
0068 0204 20 50 00
0069 0207 20 00 01
0070 020A C9 0F
0071 020C D0 04
0072 020E A9 01
0073 0210 B5 3B
0074 0212 E6 3A
0075 0214 A5 3B
0076 0216 F0 0E
0077 0218 C6 3B
0078 021A 20 80 03
0079 021D A9 01
0080 021F 20 40 03
0081 0222 A9 03
0082 0224 D0 0F
0083 0226 E6 3B
0084 0228 20 A4 03
0085 022B 20 9D 02
0086 022E A9 04
0087 0230 20 40 03
0088 0233 A9 0C
0089 0235 A0 07
0090 0237 D9 2A 00
0091 023A F0 11
0092 023C 88
0093 023D 10 F8
0094 023F A5 3A
0095 0241 C9 09
0096 0243 D0 CD
0097 0245 A9 FF
0098 0247 B5 3D
0099 0249 B5 3C
0100 024B D0 4A
0101 024D C9 0C
0102 024F F0 0E

;
;VARIABLE STORAGES:
;
CLRST * = * + 9 ;1ST LOC. TO BE CLEARED BY 'INIT'.
GMBRD * = * + 9 ;GAME BOARD: PLAYER'S POSITIONS ON
;BOARD AS $01=PLAYER, $04=COMPUTER.
SQSTAT * = * + 9 ;SQUARE'S TACTICAL STATUS.
ROWSUM * = * + 8 ;SUM OF VALUES OF SQUARES IN
;ROW, WHERE 1=PLAYER,
;4=COMPUTER, 0=EMPTY.
RNDSCR * = * + 6 ;RND # GEN. SCRATCHPAD.
TEMP1 * = * + 1
TEMP2 * = * + 1
MOVNUM * = * + 1 ;NUMBER OF CURRENT MOVE.
PLAYR * = * + 1 ;WHO'S TURN IT IS.
LTMSKH * = * + 1 ;HIGH ORDER BLINK MASK FOR LED'S
LTMSKL * = * + 1 ;LOW ORDER SAME.
DUR * = * + 1 ;DURATION FOR TONES.
FREQ * = * + 1 ;FREQUENCY OF TONES.
CLREND * = * + 1 ;LAST LOC TO BE CLEARED BY 'INIT'.
ODDMSK * = * + 1 ;MAKES PRODUCT OF RANDOM MOVE
;GENERATOR ODD TO PICK CORNER.
INTEL * = * + 1 ;INTELLIGENCE QUOTIENT.
;
; ***** MAIN PROGRAM *****
;
* = $200
;
START LDA #12
STA INTEL ;SET I.Q. AT 75%
RESTRT JSR INIT ;INITIALIZE PROGRAM.
JSR GETKEY ;GET FIRST MOVE DETERMINER.
CMP #FF ;IS IT 'F'?
BNE PLAYLP
LDA #01 ;YES, PLAYER FIRST.
STA PLAYR
PLAYLP INC MOVNUM ;COUNT THE MOVES.
LDA PLAYR ;WHO'S TURN?
BEQ COMPMV ;IF 0, COMPUTER'S MOVE.
DEC PLAYR ;PLAYER'S TURN, COMPUTER NEXT.
JSR PLRMV ;GET PLAYER'S MOVE.
LDA #01 ;STORE PLAYER'S PIECE.
JSR UPDATE ;PLAY IT, AND UPDATE ROWSUMS.
LDA #03 ;LOAD PATTERN FOR WIN SEARCH.
BNE WINTST ;CHECK FOR WIN.
COMPMV INC PLAYR ;COMPUTER'S TURN, PLAYER NEXT.
JSR DELAY ;TIME FOR COMPUTER TO 'THINK'.
JSR ANALYZ ;FIND COMPUTER'S MOVE.
LDA #04 ;STORE COMPUTER'S PIECE.
JSR UPDATE ;PLAY IT.
LDA #12 ;LOAD PATTERN FOR WIN SEARCH.
LDY #7 ;LOOP '7X TO CHECK ROWSUMS
TSTLP CMP ROWSUM,Y ;FOR WINNING PATTERN.
BEQ WIN ;WIN IF PATTERN FOUND.
DEY ;LOOP AND
BPL TSTLP ;TRY AGAIN.
LDA MOVNUM ;IF MOVE NUMBER = 9,
CMP #9 ;THEN GAME IS TIE.
BNE PLAYLP ;KEEP PLAYING IF NOT.
LDA #FFF ;SET ALL LIGHTS TO BLINKING.
STA LTMSKL
STA LTMSKH
BNE DLY ;KEEP THEM BLINKING A WHILE.
WIN CMP #12 ;COMPUTER WIN?
BEQ INTDN ;IF YES, I.Q. DOWN.

```

Fig. 11.50: Tic-Tac-Toe Program (Continued)

# ADVANCED 6502 PROGRAMMING

```

0103 0251 A9 1E      LDA #30          ;LOAD FREQ. CONST FOR WIN TONE.
0104 0253 85 3F      STA FREQ
0105 0255 A5 41      LDA INTEL
0106 0257 C9 0F      CMP #*0F        ;I.Q. AS HIGH AS POSSIBLE?
0107 0259 F0 0E      BEQ GTMSK      ;IF YES, DON'T CHANGE IT.
0108 025B E6 41      INC INTEL      ;RAISE I.Q.
0109 025D D0 0A      BNE GTMSK     ;GO FLASH ROW.
0110 025F A9 FF      INTDN LDA #*FF    ;LOAD FREQ. CONST. FOR LOSE TONE.
0111 0261 85 3F      STA FREQ
0112 0263 A5 41      LDA INTEL
0113 0265 F0 02      BEQ GTMSK     ;I.Q. = 0?
0114 0267 C6 41      DEC INTEL     ;IF YES, DON'T DECREMENT!
0115 0269 A9 00      GTMSK LDA #0    ;I.Q. DOWN.
0116 026B 8D 01 A0   ;CLEAR ALL LEDS.
0117 026E 8D 00 A0   STA PORT1A
0118 0271 B6 00      STA PORT1B
0119 0273              LDX RWPT1,Y    ;GET BIT IN ACCUM. TO LIGHT
0120 0273              ;LED CORRESPONDING TO 1ST SQUARE
0121 0273 20 6F 03   JSR LEDLTR    ;IN WINNING ROW.
0122 0276 B6 08      LDX RWPT2,Y   ;GET SECOND BIT.
0123 0278 20 6F 03   JSR LEDLTR
0124 027B B6 10      LDX RWPT3,Y   ;GET 3RD BIT.
0125 027D 20 6F 03   JSR LEDLTR
0126 0280 AD 01 A0   LDA PORT1A    ;MASK OUT UNNECESSARY BITS IN
0127 0283 25 3D      AND LTMSKL    ;BLINK MASKS.
0128 0285 85 3D      STA LTMSKL
0129 0287 AD 00 A0   LDA PORT1B
0130 028A 25 3C      AND LTMSKH
0131 028C 85 3C      STA LTMSKH
0132 028E A9 FF      LDA #*FF     ;SET WIN/LOSE TONE DURATION.
0133 0290 85 3E      STA DUR
0134 0292 A5 3F      LDA FREQ     ;GET FREQUENCY.
0135 0294 20 AD 00   JSR TONE     ;PLAY TONE.
0136 0297 20 A4 03   DLY JSR DELAY  ;DELAY TO SHOW WIN OR TIE.
0137 029A 4C 04 02   JMP RESTRT  ;START NEW GAME, DON'T CHNG. I.Q.
0138 029D              ;
0139 029D              ; ***** SUBROUTINE 'ANALYZE' *****
0140 029D              ; DOES A STATIC ANALYSIS OF GAME BOARD, AND
0141 029D              ; RETURNS WITH A MOVE IN REGISTER X.
0142 029D              ;
0143 029D A9 00      ANALYZ LDA #0 ;SET MASK THAT MAKES RANDOM MOVES
0144 029F 85 40      STA ODDMSK   ;BE SIDES TO 0.
0145 02A1 A9 08      LDA #08     ;CHECK FOR WINNING MOVE FOR
0146 02A3 A2 03      LDX #03     ;COMPUTER.
0147 02A5 20 04 03   JSR FINDMV
0148 02A8 D0 59      BNE DONE    ;IF FOUND, RETURN.
0149 02AA A9 02      LDA #02     ;CHECK FOR WINNING MOVE FOR
0150 02AC A2 03      LDX #03     ;PLAYER.
0151 02AE 20 04 03   JSR FINDMV
0152 02B1 D0 50      BNE DONE    ;IF FOUND, RETURN.
0153 02B3 A9 04      LDA #04     ;CAN COMPUTER SET A TRAP?
0154 02B5 A2 02      LDX #02
0155 02B7 20 04 03   JSR FINDMV
0156 02BA D0 47      BNE DONE    ;IF YES, PLAY IT.
0157 02BC 20 9A 00   JSR RANDOM  ;GET A RANDOM NUMBER...
0158 02BF 29 0F      AND #*0F    ;...AND MAKE IT 0-15...
0159 02C1 C5 41      CMP INTEL    ;FOR USE AS STUPID/SMART DETERMINER.
0160 02C3 F0 02      BEQ OK      ;IF BOTH ARE EQUAL, SKIP TEST
0161 02C5 B0 2B      BCS RNDMV   ;IF RND# > INTEL, PLAY A DUMB MOVE.
0162 02C7 A6 3A      OK LDX MOUNUM
0163 02C9 E0 01      CPX #1      ;1ST MOVE?
0164 02CB F0 25      BEQ RNDMV   ;IF YES, PLAY ANY SQUARE.
0165 02CD E0 04      CPX #4      ;4TH MOVE?
0166 02CF D0 0C      BNE TRAPCK ;IF NOT, CONTINUE.
0167 02D1 A2 06      LDX #6      ;LOAD INDEX TO 1ST DIAG. ROWSUM.
0168 02D3 BA      TXA        ;LOAD SUM OF ROW HAVING P-C-P.
0169 02D4 D5 2A      CMP ROWSUM,X ;CHECK IF 1ST DIAG. IS P-C-P
0170 02D6 F0 16      BEQ ORDRND ;IF YES, PLAY SIDE.
0171 02D8 E8      INX        ;CHECK NEXT DIAG. ROWSUM
0172 02D9 D5 2A      CMP ROWSUM,X
0173 02DB F0 11      BEQ ORDRND
0174 02DD A9 01      TRAPCK LDA #1 ;CAN PLAYER SET A TRAP?

```

Fig. 11.50: Tic-Tac-Toe Program (Continued)

```

0175 02DF A2 02          LDX #2
0176 02E1 20 04 03     JSR FINDMU
0177 02E4 D0 1D        BNE DONE
0178 02E6 A6 1C        LDX GMBRD+4
0179 02E8 D0 08        BNE RNDMU
0180 02EA A2 05        LDX #5
0181 02EC D0 15        BNE DONE
0182 02EE A9 01        ODDRND LDA #1
0183 02F0 85 40        STA ODDMSK
0184 02F2 20 9A 00     RNDMU JSR RANDOM
0185 02F5 29 0F        AND #*0F
0186 02F7 05 40        ORA ODDMSK
0187 02F9 C9 09        CMP #9
0188 02FB B0 F5        BCS RNDMU
0189 02FD AA          TAX
0190 02FE B5 18        LDA GMBRD,X
0191 0300 D0 F0        BNE RNDMU
0192 0302 EB          INX
0193 0303 60          DONE RTS
0194 0304              ;
0195 0304              ; ***** SUBROUTINE 'FIND MOVE' *****
0196 0304              ; FINDS A SQUARE MEETING SPECIFICATIONS
0197 0304              ; PASSED IN IN A AND X.
0198 0304              ; INDEX REGISTER X CONTAINS
0199 0304              ; MASK THAT, WHEN OR'ED WITH
0200 0304              ; NUMBER OF TIMES A SQUARE FITS ROWS WITH
0201 0304              ; ROWSUM IN ACCUM., MUST YIELD A ONE
0202 0304              ; FOR SQUARE TO QUALIFY.
0203 0304              ;
0204 0304 86 39        FINDMU STX TEMP2
0205 0306 85 38        STA TEMP1
0206 0308 A9 00        LDA #0
0207 030A A0 08        LDY #8
0208 030C 99 21 00     CLRLP STA SQSTAT,Y
0209 030F 88          DEY
0210 0310 10 FA        BPL CLRLP
0211 0312 A0 07        LDY #7
0212 0314 A5 38        CHEKLP LDA TEMP1
0213 0316 D9 2A 00     CMP ROWSUM,Y
0214 0319 D0 0F        BNE NOCHECK
0215 031B B6 00        LDX RWPT1,Y
0216 031D 20 39 03     JSR CNTSUB
0217 0320 B6 08        LDX RWPT2,Y
0218 0322 20 39 03     JSR CNTSUB
0219 0325 B6 10        LDX RWPT3,Y
0220 0327 20 39 03     JSR CNTSUB
0221 032A 88          NOCHECK DEY
0222 032B 10 E7        BPL CHEKLP
0223 032D A2 09        LDX #9
0224 032F A5 39        FNMTCH LDA TEMP2
0225 0331 35 20        AND SQSTAT-1,X
0226 0333 D0 03        BNE FOUND
0227 0335 CA          DEX
0228 0336 D0 F7        BNE FNMTCH
0229 0338 60          FOUND RTS
0230 0339              ;
0231 0339              ; ***** SUBROUTINE 'COUNTSUB' *****
0232 0339              ; INCREMENTS SQSTAT OF EMPTY SQUARES.
0233 0339              ;
0234 0339 B5 18        CNTSUB LDA GMBRD,X
0235 033B D0 02        BNE NOCNT
0236 033D F6 21        INC SQSTAT,X
0237 033F 60          NOCNT RTS
0238 0340              ;
0239 0340              ; ***** SUBROUTINE 'UPDATE' *****
0240 0340              ; PLAYS MOVE BY STORING CODE PASSED IN IN ACCUM.
0241 0340              ; AT SQUARE SPECIFIED BY X REG.
0242 0340              ; ALSO LIGHTS/SETS BLINKING PROPER LED,
0243 0340              ; AND COMPUTES ROWSUMS.
0244 0340              ;
0245 0340 CA          UPDATE DEX
0246 0341 95 18        STA GMBRD,X

```

Fig. 11.50: Tic-Tac-Toe Program (Continued)

# ADVANCED 6502 PROGRAMMING

```

0247 0343 C9 04      CMP  #$04      ;COMPUTER'S MOVE?
0248 0345 F0 0D      BEQ  NOBLNK    ;IF YES, DON'T SET LED BLINKING.
0249 0347 20 98 03   JSR  LIGHT     ;PLAYER'S MOVE! GET BIT CORRESPONDING
0250 034A             ;TO LED TO BE SET TO BLINKING.
0251 034A 05 3D      ORA  LTMSKL    ;PLACE BIT IN BLINK MASKS.
0252 034C 85 3D      STA  LTMSKL
0253 034E 90 04      RCC  NOBLNK    ;IF C=0, DON'T SET BIT 9.
0254 0350 A9 01      LDA  #01      ;SET BIT 9 TO BLINKING.
0255 0352 85 3C      STA  LTMSKH
0256 0354 20 6F 03   NOBLNK JSR  LEDLTR ;LIGHT LED.
0257 0357 A2 07      LDX  #7       ;LOOP TO COMPUTE ROWSUMS.
0258 0359 18         ADDROW CLC     ;PREPARE FOR ADDITION.
0259 035A B4 00      LDY  RWPT1,X  ;GET FIRST SQUARE ADDRESS.
0260 035C B9 18 00   LDA  GMBRD,Y  ;GET CONTENTS OF SQUARE.
0261 035F B4 08      LDY  RWPT2,X  ;ADD SECOND SQUARE IN ROW.
0262 0361 79 18 00   ADC  GMBRD,Y
0263 0364 B4 10      LDY  RWPT3,X  ;ADD FINAL SQUARE.
0264 0366 79 18 00   ADC  GMBRD,Y
0265 0369 95 2A      STA  ROWSUM,X ;SAVE ROWSUM
0266 036B CA        DEX
0267 036C 10 EB      BPL  ADDROW   ;GET NEXT ROWSUM.
0268 036E 60        RTS
0269 036F             ;
0270 036F             ; ***** SUBROUTINE 'LED LIGHTER' *****
0271 036F             ;GIVEN AN ARGUMENT IN X REG, LIGHTS
0272 036F             ;LED (0-B) CORRESPONDING TO THAT ARGUMENT.
0273 036F             ;
0274 036F 20 98 03   LEDLTR JSR  LIGHT ;GET BIT IN CORRECT POSITION.
0275 0372 0D 01 A0   ORA  PORT1A    ;LIGHT LED.
0276 0375 8D 01 A0   STA  PORT1A
0277 0378 90 05      BCC  LTRDN     ;IF LED #9 NOT TO BE LIT, SKIP.
0278 037A A9 01      LDA  #1
0279 037C 8D 00 A0   STA  PORT1B
0280 037F 60        LTRDN RTS         ;DONE.
0281 0380             ;
0282 0380             ; ***** SUBROUTINE 'PLAYER'S MOVE' *****
0283 0380             ;GETS PLAYER'S MOVE, CHECKS FOR ERRORS.
0284 0380             ;
0285 0380 A9 80      PLRMV LDA  #$80 ;MAKE SHORT BEEP TO SIGNAL
0286 0382 85 3E      STA  DUR      ;KEYBOARD INPUT NEEDED.
0287 0384 A9 10      LDA  #$10
0288 0386 20 AD 00   JSR  TONE
0289 0389 20 00 01   KEYIN JSR  GETKEY ;GET MOVE.
0290 038C C9 0A      CMP  #10      ;OUT OF BOUNDS?
0291 038E B0 F9      BCS  KEYIN    ;IF YES, GET ANOTHER.
0292 0390 AA        TAX
0293 0391 F0 F6      BEQ  KEYIN    ;IF MOVE = 0, GET ANOTHER.
0294 0393 B5 17      LDA  GMBRD-1,X ;SQUARE EMPTY?
0295 0395 D0 F2      BNE  KEYIN    ;IF NOT, TRY AGAIN.
0296 0397 60        RTS
0297 0398             ;
0298 0398             ; ***** SUBROUTINE 'LIGHT' *****
0299 0398             ;SHIFTS A ONE BIT LEFT IN ACCUMULATOR TO
0300 0398             ;A POSITION CORRESPONDING TO THE
0301 0398             ;ARGUMENT PASSED IN IN REG. X. IF X=0,
0302 0398             ;CARRY IS SET.
0303 0398             ;
0304 0398 86 38      LIGHT STX  TEMP1 ;SAVE X.
0305 039A A9 00      LDA  #0       ;CLEAR ACCUM. FOR SHIFT.
0306 039C 38        SEC         ;GET BIT TO BE SHIFTED.
0307 039D 2A        SHIFT ROL  A        ;SHIFT BIT LEFT.
0308 039E CA        DEX
0309 039F 10 FC      BPL  SHIFT    ;COUNT DOWN AND LOOP.
0310 03A1 A6 38      LDX  TEMP1    ;RESTORE X.
0311 03A3 60        RTS
0312 03A4             ;
0313 03A4             ; ***** SUBROUTINE 'DELAY' *****
0314 03A4             ;
0315 03A4 A0 FF      DELAY LDY  #$FF
0316 03A6 A2 FF      DL1  LDX  #$FF
0317 03AB 26 3E      DL2  ROL  DUR ;WASTE TIME.
0318 03AA 66 3E      ROR  DUR

```

Fig. 11.50: Tic-Tac-Toe Program (Continued)

```

0319 03AC CA          DEX
0320 03AD D0 F9      BNE DL2
0321 03AF 88         DEY
0322 03B0 D0 F4      BNE DL1
0323 03B2 60         RTS
0324 03B3           ;
0325 03B3           ; ***** INTERRUPT HANDLING ROUTINE *****
0326 03B3           ; AT EACH INTERRUPT, LEDS WHOSE POSITIONS IN
0327 03B3           ; THE BLINK MASKS HAVE ONES IN THEM ARE TURNED
0328 03B3           ; ON IF OFF, OFF IF ON.
0329 03B3 48         INTVEC PHA
0330 03B4 AD 01 A0    LDA PORT1A
0331 03B7 45 3D      EOR LTMSKL
0332 03B9 8D 01 A0    STA PORT1A
0333 03BC AD 00 A0    LDA PORT1B
0334 03BF 45 3C      EOR LTMSKH
0335 03C1 8D 00 A0    STA PORT1B
0336 03C4 AD 04 A0    LDA T1LL
0337 03C7 68         PLA
0338 03C8 40         RTI
0339 03C9           ;
0340 03C9           ; ***** SUBROUTINE 'INITIALIZE' *****
0341 03C9           ; INITIALIZES PROGRAM.
0342 03C9           ;
0343 03C9           ; * - $50
0344 0050           ;
0345 0050 A9 00      INIT LDA #0          ;CLEAR STORAGES.
0346 0052 A2 28      LDX #CLREND-CLRST
0347 0054 95 18      CLRALL STA CLRST,X
0348 0056 CA         DEX
0349 0057 10 FB      BPL CLRALL
0350 0059 AD 04 A0    LDA T1LL          ;GET RANDOM NUMBER GENERATOR SEED.
0351 005C 85 33      STA RNDSCR+1
0352 005E 85 36      STA RNDSCR+4
0353 0060 A9 FF      LDA #$FF
0354 0062 8D 03 A0    STA DDR1A        ;SET UP I/O
0355 0065 8D 02 A0    STA DDR1B
0356 0068 8D 02 AC    STA DDR3B
0357 006B A9 00      LDA #0          ;CLEAR LEDES
0358 006D 8D 01 A0    STA PORT1A
0359 0070 8D 00 A0    STA PORT1B
0360 0073           ;SET UP TIMER FOR INTERRUPTS WHICH
0361 0073           ;BLINK LEDES.
0362 0073 20 86 8B    JSR ACCESS      ;UNPROTECT SYM-1 SYSTEM MEMORY TO
0363 0076           ; SET UP INTERRUPT VECTORS.
0364 0076 A9 B3      LDA #<INTVEC    ;LOAD LOW BYTE INTERRUPT VECTOR.
0365 0078 8D 7E A6    STA IRQUL      ;STORE AT INTERRUPT VECTOR LOCATION.
0366 007B A9 03      LDA #>INTVEC    ;LOAD HI BYTE INTERRUPT VECTOR.
0367 007D 8D 7F A6    STA IRQVH     ;STORE.
0368 0080 A9 7F      LDA #$7F      ;CLEAR INTERRUPT ENABLE REGISTER.
0369 0082 8D 0E A0    STA IER
0370 0085 A9 C0      LDA #$C0      ;ENABLE TIMER1 INTERRUPT.
0371 0087 8D 0E A0    STA IER
0372 008A A9 40      LDA #$40      ;ENABLE TIMER1 IN FREE-RUN MODE.
0373 008C 8D 0B A0    STA ACR
0374 008F A9 FF      LDA #$FF
0375 0091 8D 04 A0    STA T1LL     ;SET LOW LATCH ON TIMER 1.
0376 0094 8D 05 A0    STA T1CH     ;SET HIGH LATCH & START INTERRUPT COUNT.
0377 0097 58         CLI          ;ENABLE INTERRUPTS.
0378 0098 D8         CLD
0379 0099 60         RTS
0380 009A           ;
0381 009A           ; ***** SUBROUTINE 'RANDOM' *****
0382 009A           ; RANDOM NUMBER GENERATOR: RETURNS NEW
0383 009A           ; RANDOM NUMBER IN ACCUMULATOR.
0384 009A           ;
0385 009A 38         RANDOM SEC
0386 009B A5 33      LDA RNDSCR+1
0387 009D 65 36      ADC RNDSCR+4
0388 009F 65 37      ADC RNDSCR+5
0389 00A1 85 32      STA RNDSCR
0390 00A3 A2 04      LDX #4

```

Fig. 11.50: Tic-Tac-Toe Program (Continued)

# ADVANCED 6502 PROGRAMMING

```

0391 00A5 B5 32      RNDLP LDA RNDSCR,X
0392 00A7 95 33      STA RNDSCR+1,X
0393 00A9 CA         DEX
0394 00AA 10 F9      BPL RNDLP
0395 00AC 60         RTS
0396 00AD           ;
0397 00AD           ; ***** SUBROUTINE 'TONE' *****
0398 00AD           ; GENERATES A TONE: NO. OF 1/2 CYCLES
0399 00AD           ; MUST BE IN DUR, AND
0400 00AD           ; WAVELENGTH CONST. IN ACCUMULATOR.
0401 00AD           ;
0402 00AD 85 3F      TONE STA FREQ
0403 00AF A9 FF      LDA #$FF
0404 00B1 8D 00 AC   STA PORT3B
0405 00B4 A9 00      LDA #00
0406 00B6 A6 3E      FL2 LDX DUR
0407 00BB A4 3F      FL2 LDY FREQ
0408 00BA 88        FL1 DEY
0409 00BB 18        CLC
0410 00BC 90 00     BCC #+2
0411 00BE D0 FA     BNE FL1
0412 00C0 49 FF     EOR #$FF
0413 00C2 8D 00 AC   STA PORT3B
0414 00C5 CA         DEX
0415 00C6 D0 F0     BNE FL2
0416 00C8 60         RTS
0417 00C9           .END

```

## SYMBOL TABLE

SYMBOL VALUE

ACCESS	BB86	ACR	A00B	ADDRESS	0359	ANALYZ	029D
CHEKLP	0314	CLRALL	0054	CLREND	0040	CLRLP	030C
CLRST	0018	CNTSUB	0339	COMPV	0226	DDR1A	A003
DDR1B	A002	DDR3B	AC02	DELAY	03A4	DL1	03A6
DL2	03A8	DLY	0297	DONE	0303	DUR	003E
FINDMV	0304	FL1	00BA	FL2	00B8	FNMTCH	032F
FOUND	0338	FREQ	003F	GETKEY	0100	GMRD	0018
GTMASK	0269	IER	A00E	INIT	0050	INTDN	025F
INTEL	0041	INTVEC	03B3	IRQVH	A67F	IRQVL	A67E
KEYIN	03B9	LEDLTR	036F	LIGHT	0398	LTMSKH	003C
LTMSKL	003D	LTRDN	037F	MOVNUM	003A	NOBLNK	0354
NOCHEK	032A	NOCNT	033F	ODDMASK	0040	ODDRND	02EE
OK	02C7	PLAYLP	0212	PLAYR	003E	PLRMV	0380
PORT1A	A001	PORT1B	A000	PORT3B	AC00	RANDOM	009A
RESTR	0204	RNDLP	00A5	RNDMV	02F2	RNDSCR	0032
ROWSUM	002A	RWPT1	0000	RWPT2	0008	RWPT3	0010
SHIFT	039D	SQSTAT	0021	START	0200	T1CH	A605
TILL	A004	TEMP1	0038	TEMP2	0039	TONE	00AD
TRAPCK	02DD	TSTLP	0237	UPDATE	0340	WIN	024D
WINTST	0235						

END OF ASSEMBLY

<

Fig. 11.50: Tic-Tac-Toe Program (Continued)

# Appendix A

## 6502 INSTRUCTIONS—ALPHABETIC

<b>ADC</b>	Add with carry	<b>JSR</b>	Jump to subroutine
<b>AND</b>	Logical AND	<b>LDA</b>	Load accumulator
<b>ASL</b>	Arithmetic shift left	<b>LDX</b>	Load X
<b>BCC</b>	Branch if carry clear	<b>LDY</b>	Load Y
<b>BCS</b>	Branch if carry set	<b>LSR</b>	Logical shift right
<b>BEQ</b>	Branch if result = 0	<b>NOP</b>	No operation
<b>BIT</b>	Test bit	<b>ORA</b>	Logical OR
<b>BMI</b>	Branch if minus	<b>PHA</b>	Push A
<b>BNE</b>	Branch if not equal to 0	<b>PHP</b>	Push P status
<b>BPL</b>	Branch if plus	<b>PLA</b>	Pull A
<b>BRK</b>	Break	<b>PLP</b>	Pull P status
<b>BVC</b>	Branch if overflow clear	<b>ROL</b>	Rotate left
<b>BVS</b>	Branch if overflow set	<b>ROR</b>	Rotate right
<b>CLC</b>	Clear carry	<b>RTI</b>	Return from interrupt
<b>CLD</b>	Clear decimal flag	<b>RTS</b>	Return from subroutine
<b>CLI</b>	Clear interrupt disable	<b>SBC</b>	Subtract with carry
<b>CLV</b>	Clear overflow	<b>SEC</b>	Set carry
<b>CMP</b>	Compare to accumulator	<b>SED</b>	Set decimal
<b>CPX</b>	Compare to X	<b>SEI</b>	Set interrupt disable
<b>CPY</b>	Compare to Y	<b>STA</b>	Store accumulator
<b>DEC</b>	Decrement memory	<b>STX</b>	Store X
<b>DEX</b>	Decrement X	<b>STY</b>	Store Y
<b>DEY</b>	Decrement Y	<b>TAX</b>	Transfer A to X
<b>EOR</b>	Exclusive OR	<b>TAY</b>	Transfer A to Y
<b>INC</b>	Increment memory	<b>TSX</b>	Transfer SP to X
<b>INX</b>	Increment X	<b>TXA</b>	Transfer X to A
<b>INY</b>	Increment Y	<b>TXS</b>	Transfer X to SP
<b>JMP</b>	Jump	<b>TYA</b>	Transfer Y to A



# Appendix B

## 6502 INSTRUCTION SET—HEX AND TIMING

MNEMONIC	IMPLIED			ACCUM.			ABSOLUTE			ZERO PAGE			IMMEDIATE			ABS. X			ABS. Y					
	OP	n	#	OP	n	#	OP	n	#	OP	n	#	OP	n	#	OP	n	#	OP	n	#			
ADC AND ASL BCC BCS	(1) (1)			OA	2	1	6D 2D OE	4 4 6	3 3 3	65 25 06	3 3 5	2 2 2	69 29	2 2	2 2	7D 3D 1E	4 4 7	3 3 3	79 39	4 4	3 3			
BEQ BIT BMI BNE BPL	(2) (2) (2) (2) (2)						2C	4	3	24	3	2												
BRK BVC BVS CLC CLD	(2) (2)	0D	7	1																				
CLI CLV CMP CPX CPY		18 DB	2	1						CD EC CC	4 4 4	3 3 3	C5 E4 C4	3 3 3	2 2 2	C9 E0 CO	2 2 2	2 2 2	DD	4	3	D9	4	3
DEC DEX DEY EOR INC	(1)	CA BB	2	1						CE	6	3	C6	5	2				DE	7	3			
										4D EE	4 6	3 3	45 E6	3 5	2 2	49	2	2	5D FE	4 7	3 3	59	4	3

INX INY JMP JSR LDA	(1)	E8 CB	2	1						4C 20 AD	3 6 4	3 3 3	A5	3	2	A9	2	2	BD	4	3	B9	4	3		
LDX LDY LSR NOP ORA	(1)				4A	2	1			AE AC 4E	4 4 6	3 3 3	A6 A4 46	3 3 5	2 2 2	A2 A0	2 2	2 2	BC 5E	4 7	3 3	BE	4	3		
PHA PHP PLA PLP ROL		48 08 68 28	3 3 4 4	1 1 1 1																						
ROR RTI RTS SBC SEC SED	(1)				2A	2	1			6A	2	1	2E 6E	6 6	3 3	26 66	5 5	2 2				3E 7E	7 7	3 3		
SEI STA STX STY TAX													8D 8E 8C	4 4 4	3 3 3	85 86 84	2 2 2				9D	5	3	99	5	3
TAY TSX TXA TXS TYA		AA	2	1																						
		AB BA 8A 9A 98	2 2 2 2 2	1 1 1 1 1																						

(1) Add 1 to n if crossing page boundary

# APPENDIX

(IND. X)			(IND) Y			Z. PAGE. X			RELATIVE			INDIRECT			Z. PAGE. Y			PROCESSOR STATUS CODES							
OP	n	#	OP	n	#	OP	n	#	OP	n	#	OP	n	#	OP	n	#	N	V	B	D	I	Z	C	MNEMONIC
61	6	2	71	5	2	75	4	2										•	•				•	•	ADC
21	6	2	31	5	2	35	4	2										•	•				•	•	AND
						16	6	2										•					•	•	ASL
																									BCC
																									BFS
																									BEQ
																		M	M				•		BIT
																									BMI
																									BNE
																									BPL
																					1	1			BRK
																									BVC
																									BVS
																							0		CLC
																									CLD
																					0	0			CLI
																									CLV
																									CMP
																									CPX
																									CPY
																									DEC
																									DEX
																									DEY
																									EOR
																									INC

																									INX
																									INY
																									JMP
																									JSR
																									LDA
																									LDX
																									LDY
																									LSR
																									NOP
																									ORA
																									PHA
																									PHP
																									PLA
																									PLP
																									ROL
																									ROR
																									RTI
																									RTS
																									SBC
																									SED
																									SEI
																									STA
																									STX
																									STY
																									TAX
																									TAY
																									TSX
																									TXA
																									TXS
																									TYA

(2) Add 2 to n if branch within page  
Add 3 to n if branch to another page

# Index

- ACCESS, 170
- Ad hoc algorithm, 239
- Ad hoc programming, 238
- Analytical algorithm, 225
- ANALYZE, 263
- Array, 122
- Artificial intelligence, 224
- Assembler, 47
- Assembly, 12
- Audio feedback, 163
- Auxiliary Control Register, 174
- BEO, 154
- Binary number, 41
- Blackjack, 189
- Blackjack Program, 212
- BLIN
- Blink masks, 175
- BLINKER, 208
- Blinking, 274
- Blinking LEDs, 261
- Blip counter, 92
- Board analysis flowchart, 242
- Bounce, 13
- Bracket-filtering, 150
- Carry, 206
- Cassette recorder, 4
- CLI, 174
- CNTSUB, 55
- Complement, 73
- Complementation Table, 80
- Computing the Status, 271
- Constant symbols, 47
- Counter, 65, 101
- COUNTSUB, 273
- Current limiters, 11
- Decimal mode, 151
- Decision tables, 225
- DELAY, 56, 132, 211, 278
- Delay constant, 103
- Diagonal trap, 244
- Diagonals, 266
- DISPLAY, 118
- DISPLY, 119
- Do-nothing, 55
- Draw, 222
- Dual Counter, 92
- Duration, 148
- DURTAB, 144
- ECHO, 137
- Echo, 35
- Echo Program, 145
- ESP Tester, 139
- EVAL, 118, 126, 153
- Evaluating the board, 225
- Extra Sensory Perception, 139
- FINDMV, 264, 269
- FINDMV flowchart, 270
- First move, 235
- Free run, 198
- Free-running, 198
- Free-running mode, 171, 256
- Frequencies, 25
- Frequency, 22, 261
- Frequency and duration constants, 161
- Games Board, 2, 7
- GETKEY, 13, 149
- GETKEY Program, 17
- GMBRD, 252
- Heuristic strategy, 225
- Hexadecimal, 41
- Hexguess Program, 63
- IER, 171

- IFR, 171
- Illegal key closure, 95
- Index, 159
- Indexed addressing, 37, 39, 122, 126
- Initialization, 198
- INITIALIZE, 279
- Intelligence level, 252, 260
- Interconnect, 4
- Interrupt, 198, 252, 261
- Interrupt Handler, 183, 211
- Interrupt handling, 198, 279
- Interrupt Registers, 174
- Interrupt-enable register, 256
- Interrupt-enabler, 171, 179, 256
- IQ level, 245, 265
- Jackpot, 100
- JMP, 154
- Key closure, 277
- Keyboard, 7
- Keyboard input routine, 13
- Labels, 47
- Latch, 65
- LED #9, 123
- LED Connection, 10
- LEDs, 8
- Levels of difficulty, 8
- LIGHT, 118, 132, 157, 274, 278
- LIGHTER, 276
- LIGHTR, 207
- LITE, 70, 182
- Loop counter, 92
- LOSE, 130
- Magic Square, 73
- MasterMind, 162
- Middle C, 23
- Mindbender, 162
- Mindbender Program, 184
- MOVE, 47
- Multiplication, 122
- Music Player, 20
- Music Program, 31
- Music theory, 23
- Nested loop delay, 39
- Nested loop design, 25
- NOTAB, 144
- Note duration, 159
- Note frequency, 159
- Note sequence, 139
- Parameters, 149
- Parts, 11
- Perfect square, 73
- PLAY, 48, 53
- PLAYEM, 37
- Playing to the side, 24
- PLAYIT, 30, 38
- PLAYNOTE, 30
- PLRMV, 277
- Potential, 225
- Power supply, 4
- Programmable bracket, 101
- Prompt, 42
- Protected, 170
- Protected area, 170
- Pulse, duration, 171
- RANDER, 210
- RANDOM, 57, 135, 150, 159, 209
- Random moves, 241
- Random number, 54, 65, 78, 118, 267
- Random number generator, 57, 118, 149
- Random pattern, 73
- Random move, 267
- Recursion, 211
- Repeat, 13
- Resistors, 11
- RNDSCR, 252
- Row sequences, 251
- Row-sum, 239, 271
- SBC, 206
- Scratch area, 57
- Score, 107, 128
- Score table, 107, 111, 112
- SCORTB, 127
- Seed, 118, 149
- 74154, 8
- 7416, 8
- Shifting loop, 158
- SHOW, 152
- Side, 267
- Simple tunes, 21
- Siren, 100
- Slot Machine, 99
- Slot Machine Program, 113
- Software filter, 175
- Special decimal mode, 150
- Spinner, 87
- Spinner Program, 93
- SQSTAT, 252

## ADVANCED 6502 PROGRAMMING

Square status, 269  
Square wave, 22  
Strategy, 225  
SYM, 4  
T1CL, 6, 83  
T1L-L, 65  
Threat potential, 226  
Tic-Tac-Toe, 218  
Tic-Tac-Toe Flowchart, 248  
Tic-Tac-Toe Program, 280  
TIMER, 65  
Timer, 65, 83, 198, 256  
Timer 1, 175  
TONE, 39, 70, 130, 135  
Translate, 41  
Translate Program, 49  
Trap, 235, 239, 264, 267  
Trap pattern, 241  
Two-level loop, 211  
Two-ply analysis, 237  
Unprotect system, 198  
UPDATE, 273  
Value computation, 226  
VIA, 8  
VIA memory map, 66  
Visual feedback, 163  
WAIT, 98  
Wheel pointer, 103, 120  
WIN, 128  
Win, 259  
Win potential, 225  
WINEND, 129