

THE C64 PLA DISSECTED

Thomas 'skoe' Giesel

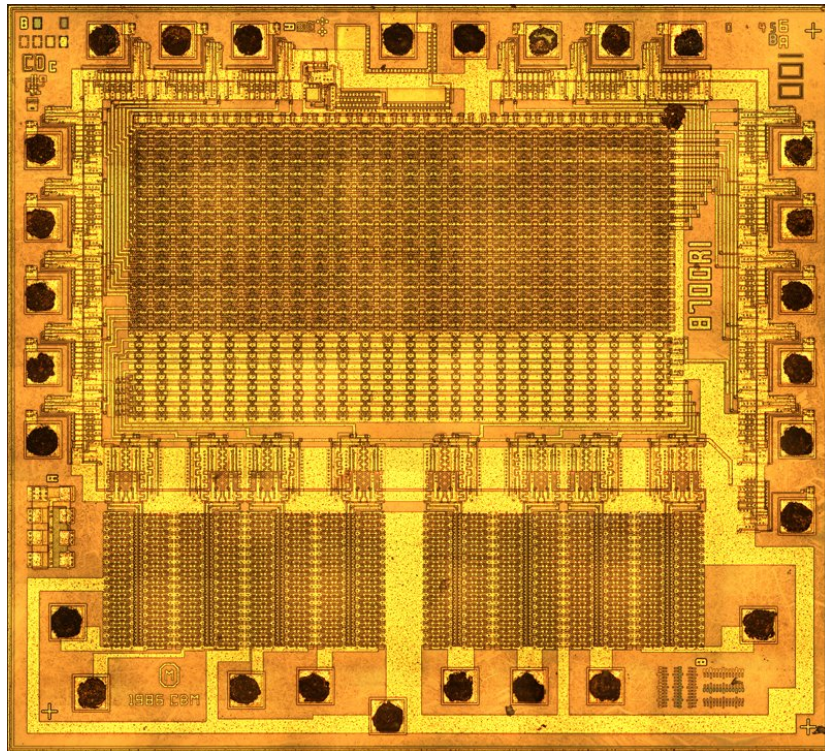

Revision 1.1, December 24, 2012



Contents

Contents	2
1 Introduction	3
1.1 Overview	3
1.2 About this Document	4
1.3 Acknowledgements	4
1.4 Document Revisions	5
2 The Logic in the PLA	6
2.1 The Development	6
2.2 Reverse Engineering History	6
2.3 PLA Logic Revisions	6
2.4 How the PLA is Connected in the C64	7
2.5 How to Extract the Logic from a 82S100	8
2.6 Full Logic Table	9
2.7 Original PLA Equations	9
3 Hardware	16
3.1 Types of PLAs Found in C64s	16
3.2 Package and Pin Assignment	17
3.3 Electrical Properties	17
4 The Inner Workings of a CSG PLA	25
4.1 The Original Designers	25
4.2 NMOS Process Generations	26
4.3 Reliability Failures	27
4.4 Block Diagram	29
4.5 Input Stage	31
4.6 Output Enable	33
4.7 Product Term Array	35
4.8 Sum Term Array	41
4.9 Output Stage	43
4.10 Back-Gate Bias Generator	47
4.11 List of Components	51
5 A PLA Replacement: realPLA	52
6 Conclusion	55
A C64 Memory Configurations Explained	57
Bibliography	65

Chapter 1

Introduction

1.1 Overview

The programmable logic array (PLA) in the Commodore 64 (C64) is used to create chip select signals from various other signals, e.g., from the current address. These signals control which chip is to be connected to the data bus. Therefore the PLA is responsible to implement the memory map of the C64.

If the PLA is broken, the CPU and the VIC-II¹ direct memory access (DMA) can not access the right memory and I/O devices anymore. In this case some chips can not be selected or more than one chip is active at the same time. A total or partial malfunction of the computer is the result. If a PLA is replaced with a part which does not meet certain timing or electrical constraints of the chips connected to it, the computer becomes unstable, possibly depending on temperature or hardware extensions used or may refuse to work at all.

The logic implemented in the PLA defines the memory map. The logic equations are described in chapter 2, among a short overview of previous reverse engineering work related to it. Also the meaning of all signals connected to the PLA for the working of the C64 is explained there. Appendix A contains the actual memory maps in a readable form as a reference.

A list of PLAs found in C64s and measurements on some of them are shown in chapter 3. This chapter also describes which parameters are important when a PLA is replaced with a different part. Most C64s shipped with a PLA made by Commodore Semiconductor Group (CSG), better known under their original name MOS Technology (MOS). A PLA of this type was opened, photographed through a microscope and completely reverse engineered for this article, down to the transistor level. Chapter 4 contains information about the inner workings of the PLA, a redrawn chip layout and schematics. That chapter also contains some background information by former Commodore/MOS engineers.

An actual implementation of a PLA replacement called *realPLA* is introduced in chapter 5 which can be built with parts being in production at the time of writing. This implementation aims at highest compatibility possible while using low-cost parts only. The design files for the realPLA are available under a Creative Commons license.

Finally, chapter 6 gives a conclusion about the findings in this document. It also evaluates the compatibility of different PLA replacements.

¹Video Interface Controller II

1.2 About this Document

Why is it necessary to write a document about the PLA in 2012? Information already documented is spread over many articles, buried in old dusty books, various forums and mailing lists, sometimes mixed with wrong statements. Even though the PLA contains combinatorial logic only, it plays an essential role in the C64 and other Commodore computers. “The PLA’s [...] were our last salvation to pull a problem out of the fire, and our chance to impart any coolness in logic,” recalls Bil Herd, a former Commodore engineer.

Understanding the logical function of the PLA is important for programmers, for hardware designers and for emulator developers. However, it is also important to have a closer look at the electrical properties of the original PLAs to implement a drop-in replacement for PLA chips. This document addresses both topics.

This document collects information already documented and adds new measurement and research results. The text and all figures are licenced under Creative Commons Attribution-ShareAlike 3.0 Unported (CC BY-SA 3.0).

1.3 Acknowledgements

I wish to thank the engineers of Commodore for the interesting memory maps achieved by using the PLA. Unfortunately you forgot a KERNAL cartridge ;)

Furthermore I would like to express respect to all persons who examined the PLA before and published their results, namely William Levak, Jens Schönfeld, Marko Mäkelä, Andreas Boose and Mark Smith.

All PLA logic incorporated in this document and used for the implementation is based on the JEDEC file by Raymond Jett of arcadecomponents.com. It was created by reading a C64 PLA with a TopMAX programmer and Max Loader software. The file is available at [\[AC12\]](#) and in the source code repository of the realPLA implementation [\[realPLA12\]](#).

Segher Boessenkool described in a mail to the cbm-hackers mailing list [\[Boess12\]](#) how the JEDEC file can be read directly. Thanks to his explanation I was able to implement a small tool which converted the JEDEC file to VHDL equations directly. Segher also helped me much with the first steps to learn to read NMOS die shots and also reviewed this document.

The micrographs for this document were made by Dr. Martin ‘enthusi’ Wendt (8700R1) and Philipp ‘Dexter’ Maier (7700R2). AREA51HD donated the chips we used for that.

Gerrit Heitsch, TheRyk and Björn ‘JMP\$FCE2’ Wieck sent some different PLAs for the investigations. Gerrit also gave some valuable hints for various topics and Björn made some additional measurements. Ingo Korb helped with proofreading.

Last but not least I also want to thank the former Commodore engineers Bil Herd, Bret Raymis, Dan Morris, Dave DiOrion, Dave Esposito and James Redfield for interesting background information and for clarifying some technical issues.

All quotes in this document which do not state a reference are taken from personal communications with the persons concerned.

Revision	Changes
1.0	Initial release
1.1	Minor changes after review comments; link to Jens Schönfeld's PLA tool added; SuperPLA V3 mentioned

Table 1.1: Document Revisions

1.4 Document Revisions

Please look out for new revisions of this document. If you have new or additional information relevant for this document or found mistakes, please contact me. The latest version of this document is available at <http://skoe.de/docs/c64-dissected/pla/>. Feel free to mirror these files.

Chapter 2

The Logic in the PLA

2.1 The Development

The logic needed to get the C64 running was programmed by Bob Yannes. “He just needed some glue logic to tie everything together,” recalls James Redfield. According to Bil Herd, “[The original PLA terms] appear on an 82S100 worksheet photocopied out of the Signetics databook.”

2.2 Reverse Engineering History

The memory maps in the Programmer’s Reference Guide [PRG83] show all possible configurations as they are seen by the CPU, including Ultimix mode. However, some details cannot be taken from that book, especially memory configurations for VIC-II accesses.

Probably the earliest full reverse engineering of the logic programmed to the PLA was written by William Levak in 1986. It was published in The Transactor magazine [Lev86]. He read out a PLA, put the binary dump onto a disk and used a computer program to extract the logic table from it. Using this way he avoided transcription errors. He double-checked the results against two other PLAs. Unfortunately the article in The Transactor has some typesetting mistakes in the memory maps, although the logic table is correct and nicely optimized.

Some years later, in 1994, Jens Schönfeld - apparently not aware of William’s work - captured the truth table again. He, Marko Mäkelä, Andreas Boose and others [PLA95] investigated that table and derived equations from it. Mark Smith took a programmer and read out an 82S100 in 1995. The results confirmed their work.

2.3 PLA Logic Revisions

Very early C64s contain a PLA which was labeled *REV2 7E17*. This version is said to have a different logic implemented. Unfortunately no binary or JEDEC dump was available for this document. The next version was *REV3 8411*. The four digit hex number is the checksum of the original JEDEC file most likely.

Different PLAs with different part numbers by different manufacturers found in C64s have been read out. The logic in all of them was identical with REV3, so this was the final revision.

2.4 How the PLA is Connected in the C64

To understand the logic in the PLA, first let's have a look how it is connected in the C64. All descriptions are based on the schematic #251138 from [Serv85], but apply for other C64 models too.

#CAS (I0)

The input line I0 is connected to the #CAS output of the VIC-II. In every Phi1 and Phi2 cycle this line is pulled down by the VIC-II to initiate a read or write access to DRAM. Depending on the other inputs, the PLA may propagate the #CAS pulse to the #CASRAM output or mask it out. Only if it is propagated to #CASRAM, DRAM is actually addressed by the memory access. When #CASRAM remains high in a cycle because it is disabled by the PLA logic, the DRAM access is rendered ineffective, or more precisely it turns to a RAS-only refresh cycle.

#LORAM, #HIRAM, #CHAREN (I1 to I3)

The lines #LORAM (I1), #HIRAM (I2) and #CHAREN (I3) are connected to the processor port of the CPU, better known as bits 0..2 of \$00/\$01 in the 6510/8500. After a reset these lines are all set to input mode by the CPU, which means that they are not driven. To make sure they have a sane value when the machine is started, they are pulled up by R43, R44 and R45. With all these values being 1, the C64 can start with KERNAL, I/O and BASIC banked in.

#VA14 (I4)

#VA14 (I4) is one of the additional video address lines for the VIC-II. The VIC-II has a 14 bit wide address bus to address 16 KiByte of memory, while the C64 has 64 KiByte of DRAM. To allow the VIC-II to address any of the four 16 KiByte chunks available in these 64 KiByte, two additional address lines called #VA14 and #VA15 are generated by programmable outputs of the CIA U2. They are fed to an extra address multiplexer U14. This is a 74LS258, which has inverted outputs.

The I/O ports are in input mode after the CIA has been reset. In this case these two lines are pulled high by internal pull-up devices in the CIA, which effectively selects bank 0 on startup. Note that these two video address bits do not appear on the global C64 address bus, they are only used for DRAM accesses. #VA14 is also connected to the PLA to influence the character set ROM mapping.

A15 to A12 (I5 to I8)

The address bus lines A15 to A12 (I5 to I8) are connected to the global address bus. They are driven by the CPU when AEC from the VIC-II and #DMA from the Expansion Port are both high. During VIC-II cycles, when AEC is low, they are pulled up by RP4. When they are pulled up by this resistor array only, it is possible to change them from the Expansion Port. These address lines are used by the PLA to control the memory mapping when AEC is high, i.e. during CPU cycles. However, they are also evaluated in the PLA in Ultimix mode when AEC is low, which makes an interesting trick possible, shown in section A.

BA (I9)

BA (I9) is set low by the VIC-II when it wants to halt the CPU to be able to use both half-cycles to get more memory bandwidth. When the VIC-II pulls down BA to take over the bus, there are three cycles left for the CPU. In these cycles up to three write accesses can take place, which is the maximum number of consecutive write accesses a 6510 does. However, the CPU stops its work before the first read access is started. Therefore there are up to three dummy read accesses on the bus until the VIC-II takes over control.

#AEC (I10)

#AEC (I10) is an inverted version of AEC. #AEC is high whenever the VIC-II is going to control the address bus. This is the case in every Phi1 cycle and in all full cycles when is BA low, after the CPU got three extra Phi2 cycles.

R/#W (I11)

The signal R/#W (I11) is high for read accesses and low for write accesses. Note that it is pulled up with resistor R51, because this line is not driven by the CPU when AEC or #DMA are low.

#EXROM, #GAME (I12, I13)

The two lines #EXROM and #GAME can be pulled down by cartridges to change the memory map of the C64, e.g., to map external ROM into the address space. When they are not pulled down from the cartridge port, resistors in RP4 pull them up.

VA13, VA12 (I14, I15)

The two address lines VA13 and VA12 are directly connected to the VIC-II. These lines are needed to address the 16k address space of the VIC-II. Note that #VA14 is from a completely different source, it is connected to a CIA output.

#CASRAM (F0)

The #CASRAM output is connected to the #CAS input of the DRAM chips. It is a gated version of the #CAS signal from the VIC-II. The VIC-II activates the #CAS signal in every half-cycle. Whenever a memory access has to address a different chip or port than the internal DRAM, the PLA disables the #CASRAM output, i.e. it remains high. This is also the case in the Ultimix memory configuration, where some address ranges simply have no memory selected at all.

The #CASRAM line requires the PLA to fulfill certain timing requirements, details can be found in section [3.3](#).

#BASIC, #KERNAL, #CHARROM (F1..F3)

The outputs #BASIC, #KERNAL, #CHARROM are connected to the chip select inputs of BASIC, KERNAL and character set ROMs. To address one of these chips, the appropriate line is pulled down.

2.5 How to Extract the Logic from a 82S100

The 82S100 PLA used in some early C64s can be read out to a JEDEC file with a programmer. This file contains a direct image of the fuse map programmed in the PLA.

This fuse map can be translated to product terms, which are AND combinations of inputs and inverted inputs. These product terms may be used in any of the eight sum terms, which are OR combinations. Finally, the fuse map describes which output shall be inverted. The meaning of the bits in the JEDEC file has been explained, e.g., in a mail by Segher Boessenkool [Boess12].

For this document a Python tool has been implemented, which converts the JEDEC file to a more readable logic table and to VHDL source code. The result is also used in the PLA replacement described in section 5.

2.6 Full Logic Table

The following table shows the AND and OR relations in the PLA in a very compact form. The symbol ‘*’ means *AND*, ‘/’ means *AND NOT* and ‘+’ means *OR*. Human readable equations are listed in subsequent sections, the resulting memory maps can be found in appendix A.

	p 000000000111111112222222233	
	01234567890123456789012345678901	
Inputs		
#CAS*/...../	
#LORAM	*...*.**. ...*.....	
#HIRAM	****.*...**. ...*.....	
#CHAREN	...//.*****	
#VA14**.....	
A15	*****.***.//**.*	
A14	/*****.**//**//**.*	
A13	**//.**//**//**//**.*	
A12	...**.*.**//**//**//**.*	
BA*.*.*.*.....	
#AEC	////**//**//**//**//**.*....	
R/#W	*****./**/**/**/**.**....	
#EXROM	..//..//..//**/**/**/**.**....	
#GAME	**/**/**.**/**/**/**/**/**.**....	
VA13//.....*	
VA12**.....*	
		Outputs
	+++++.+++++.+++++.+++++.+++++.+	#CASRAM
	+.....	NOT #BASIC
	.++......	NOT #KERNAL
	...++++.	NOT #CHARROM
+.	NOT #GRW
++++.	NOT #IO
++.	NOT #ROML
+++....	NOT #ROMH

2.7 Original PLA Equations

This chapter shows all equations as extracted directly from a 82S100 and explains their meaning.

Note that the value of VADDR refers to a VIC-II address as mapped to the 64k memory space: Address bits 15 and 14 are the inverted values of #VA15 and #VA14, generated by the CIA U2, the remaining bits are generated by the VIC-II itself.

Product Terms

These product terms are AND combinations of the input signals and inverted input signals. They can be used in sum terms to determine the final output signals.

Product Term for #BASIC

If p0 is true, BASIC ROM is selected.

```
-- #LORAM = 1, #HIRAM = 1,  
-- address $A000..$BFFF,  
-- no VIC access, read, cartridge: none or 8k  
p0 <= n_loram and n_hiram and  
      a15 and not a14 and a13 and  
      not n_aec and rd and n_game;
```

Product Terms for #KERNAL

If p1 or p2 are true, KERNAL ROM is selected.

```
-- #HIRAM = 1,  
-- address $E000..$FFFF  
-- no VIC access, read, cartridge: none or 8k  
p1 <= n_hiram and  
      a15 and a14 and a13 and  
      not n_aec and rd and n_game;  
  
-- #HIRAM = 1,  
-- address $E000..$FFFF  
-- no VIC access, read, cartridge: 16k  
p2 <= n_hiram and  
      a15 and a14 and a13 and not n_aec and  
      rd and not n_exrom and not n_game;
```

Product Terms for #CHARROM

If one or more of p3 to p7 are true, CHARACTER SET ROM is selected.

```
-- #HIRAM = 1, #CHAREN = 0,  
-- address $D000..$DFFF  
-- no VIC access, read, cartridge: none or 8k  
p3 <= n_hiram and not n_charen and  
      a15 and a14 and not a13 and a12 and  
      not n_aec and rd and n_game;  
  
-- #LORAM = 1, #CHAREN = 0,  
-- address $D000..$DFFF,  
-- no VIC access, read, cartridge: none or 8k  
p4 <= n_loram and not n_charen and  
      a15 and a14 and not a13 and a12 and  
      not n_aec and rd and n_game;  
  
-- #HIRAM = 1, #CHAREN = 0,
```

```

-- address $D000..$DFFF,
-- no VIC access, read, cartridge: 16k
p5 <= n_hiram and not n_charen and
      a15 and a14 and not a13 and a12 and
      not n_aec and rd and not n_exrom and not n_game;

-- VADDR $1000..$1FFF or $9000..$9FFF
-- VIC-II access, cartridge: none or 8k
p6 <= n_va14 and not va13 and va12 and
      n_aec and n_game;

-- VADDR $1000..$1FFF or $9000..$9FFF
-- VIC-II access, cartridge: 16k
p7 <= n_va14 and not va13 and va12 and
      n_aec and not n_exrom and not n_game;

```

Unused Product Term p8

The term p8 is not used at all. It may be a remainder of an earlier design stage of the C64 prototypes. Note that this is the same as p31 with CAS inverted.

```

p8 <= n_cas and
      a15 and a14 and not a13 and a12 and
      not n_aec and not rd;

```

Product Terms for #IO

If one or more of p9 to p18 are true, an I/O chip or port is selected.

```

-- #HIRAM = 1, #CHAREN = 1,
-- address $D000..$DFFF,
-- no VIC access bus available, read,
-- cartridge: none or 8k
p9 <= n_hiram and n_charen and
      a15 and a14 and not a13 and a12 and
      not n_aec and ba and rd and n_game;

-- #HIRAM = 1, #CHAREN = 1,
-- address $D000..$DFFF,
-- no VIC access, write, cartridge: none or 8k
p10 <= n_hiram and n_charen and
      a15 and a14 and not a13 and a12 and
      not n_aec and not rd and n_game;

-- #LORAM = 1, #CHAREN = 1,
-- address $D000..$DFFF,
-- no VIC access, bus available, read,
-- cartridge: none or 8k
p11 <= n_loram and n_charen and
      a15 and a14 and not a13 and a12 and
      not n_aec and ba and rd and n_game;

-- #LORAM = 1, #CHAREN = 1,
-- address $D000..$DFFF,
-- no VIC access, write, cartridge: none or 8k
p12 <= n_loram and n_charen and
      a15 and a14 and not a13 and a12 and

```

```

        not n_aec and not rd and n_game;

-- #HIRAM = 1, #CHAREN = 1,
-- address $D000..$DFFF,
-- no VIC access, bus available, read, cartridge: 16k
p13 <= n_hiram and n_charen and
        a15 and a14 and not a13 and a12 and
        not n_aec and ba and rd and
        not n_exrom and not n_game;

-- #HIRAM = 1, #CHAREN = 1,
-- address $D000..$DFFF,
-- no VIC access, write, cartridge: 16k
p14 <= n_hiram and n_charen and
        a15 and a14 and not a13 and a12 and
        not n_aec and not rd and
        not n_exrom and not n_game;

-- #LORAM = 1, #CHAREN = 1,
-- address $D000..$DFFF,
-- no VIC access, bus available, read, cartridge: 16k
p15 <= n_loram and n_charen and
        a15 and a14 and not a13 and a12 and
        not n_aec and ba and rd and
        not n_exrom and not n_game;

-- #LORAM = 1, #CHAREN = 1,
-- address $D000..$DFFF,
-- no VIC access, write, cartridge: 16k
p16 <= n_loram and n_charen and
        a15 and a14 and not a13 and a12 and
        not n_aec and not rd and
        not n_exrom and not n_game;

-- address $D000..$DFFF
-- no VIC access, bus available, read, cartridge: Ultimax
p17 <= a15 and a14 and not a13 and a12 and
        not n_aec and ba and rd and
        n_exrom and not n_game;

-- address $D000..$DFFF,
-- no VIC access, write, cartridge: Ultimax
p18 <= a15 and a14 and not a13 and a12 and
        not n_aec and not rd and n_exrom and not n_game;

```

Product Terms for #ROML

If p19 or p20 are true, the cartridge line ROML is selected.

```

-- #LORAM = 1, #HIRAM = 1,
-- address $8000..$9FFF
-- no VIC access, read, cartridge: 8k or 16k
p19 <= n_loram and n_hiram and
        a15 and not a14 and not a13 and
        not n_aec and rd and not n_exrom;

-- address $8000..$9FFF

```

```

-- no VIC access cartridge: Ultimix
p20 <= a15 and not a14 and not a13 and
      not n_aec and n_exrom and not n_game;

```

Product Terms for #ROMH

If one or more of p21 to p23 are true, the cartridge line ROMH is selected.

```

-- #HIRAM = 1,
-- address $A000..$BFFF,
-- no VIC access, read, cartridge: 16k
p21 <= n_hiram and
      a15 and not a14 and a13 and
      not n_aec and rd and not n_exrom and not n_game;

-- address $E000..$FFFF,
-- no VIC access cartridge: Ultimix
p22 <= a15 and a14 and a13 and
      not n_aec and n_exrom and not n_game;

-- VADDR $3000..$3FFF, $7000..$7FFF, $B000..$BFFF or
--      $E000..$EFFF,
-- VIC-II access, cartridge: Ultimix
p23 <= va13 and va12 and
      n_aec and n_exrom and not n_game;

```

Additional Product Terms for #CASRAM

The DRAM of the C64 must be disabled whenever another device is selected. Therefore all product terms above appear in the #CASRAM term. Exceptions are the unused terms and #GRW, which is not a chip select signal. However, in Ultimix mode most of the DRAM is hidden permanently to emulate the 4 KiByte contained in an original Commodore MAX Machine. To hide the remaining DRAM, the terms p24 to p28 are used.

```

-- address $1000..$1FFF, $3000..$3FFF,
-- cartridge: Ultimix
p24 <= not a15 and not a14 and a12 and
      n_exrom and not n_game;

-- address $2000..$3FFF,
-- cartridge: Ultimix
p25 <= not a15 and not a14 and a13 and
      n_exrom and not n_game;

-- address $4000..$7FFF,
-- cartridge: Ultimix
p26 <= not a15 and a14 and
      n_exrom and not n_game;

-- address $A000..$BFFF,
-- cartridge: Ultimix
p27 <= a15 and not a14 and a13 and
      n_exrom and not n_game;

-- address $C000..$CFFF,
-- cartridge: Ultimix

```

```
p28 <= a15 and a14 and not a13 and not a12 and
      n_exrom and not n_game;
```

Unused Product Term p29

Term p29 is unused. Note that this is the same as p30 with CAS inverted.

```
p29 <= not n_cas;
```

Product Term to Forward #CAS to #CASRAM

p30 is used to put #CASRAM always high when #CAS is high. This completes the gate mechanism for #CAS.

```
p30 <= n_cas;
```

Product Term for #GRW

The C64 makes use of static RAM for the color memory. Typical SRAM parts like the HM472114 ([Hita2114]) need their address lines to be set up for a certain time before they get their chip select and write enable signals. Because of the bus multiplex mechanism controlled by #AEC this is not the case in the C64.

When the color SRAM may be written, a special #GRW is generated for it. The term makes use of #CAS, because this input is only active when the address bus has a stable state. Note that also the I/O decoding has to match to enable an actual write access to the color RAM.

```
-- #CAS low,
-- address $D000..$DFFF,
-- no VIC access, write
p31 <= not n_cas
      and a15 and a14 and not a13 and a12 and
      not n_aec and not rd;
```

Sum Terms

```
-- No RAM whenever BASIC, KERNAL, CHARROM, IO,
-- ROML or ROMH are accessed or
-- any area with RAM disabled in Ultimix mode or
-- when there is no CAS signal from the VIC-II
n_casram <= p0 or p1 or p2 or
           p3 or p4 or p5 or p6 or p7 or
           p9 or p10 or p11 or p12 or p13 or
           p14 or p15 or p16 or p17 or p18 or
           p19 or p20 or p21 or p22 or p23 or
           p24 or p25 or p26 or p27 or p28 or p30;

-- Low for BASIC ROM read
n_basic <= not p0;

-- Low for KERNAL ROM read
n_kernal <= not (p1 or p2);

-- Low for CHARACTER SET ROM read
n_charrom <= not (p3 or p4 or p5 or p6 or p7);
```

```
-- Clean write pulse for color RAM
n_grw <= not p31;

-- Low for I/O chips or ports read or write
n_io <= not (p9 or p10 or p11 or p12 or p13 or p14 or
            p15 or p16 or p17 or p18);

-- Low for cartridge ROML read or write
n_roml <= not (p19 or p20);

-- Low for cartridge ROMH read or write
n_romh <= not (p21 or p22 or p23);
```

Chapter 3

Hardware

3.1 Types of PLAs Found in C64s

Signetics 82S100

The well known PLA type 82S100 by Signetics [Si75] can be found in many early C64s. Signetics was acquired by Philips and the part was renamed to PLS100 later, with a slightly revised specification [PLS100]. The 82S100 has been the first widely used field programmable logic chip. It was launched in 1975 [CHM09].

Fairchild 93459

A clone of the Signetics PLA made by Fairchild was named 93459. The oldest public reference to this IC found so far is a Fairchild catalog from 1977 [Fc77]. This PLA was also used in many early C64s.

MOS 7700/8700

Later Commodore MOS made their own chips labeled with MOS 906114-01. This was a mask programmable NMOS clone of the 82S100. “We reverse engineered the PLA from Signetics using a polaroid camera,” recalls Bil Herd. Dave DiOrio adds, “We may have looked at other circuits but the design was custom.”

To reverse engineer the CSG PLAs for this document several of them were decapped. It turned out that the actual silicon used has been a 7700R2 before around mid of 1984 and an 8700R1 later. There is no clear indication printed on the chip package, but after opening a few (broken) PLAs, it turned out that manufacturing dates in 1983 suggest a 7700 and 1985 and later suggest an 8700. ICs manufactured in 1984 could be either of them.

Beginning in 1986 another version of the 8700R2 has been made: The revision number didn't change, but the *MOS* logo was replaced with “[M] 1986 CBM”.

The CSG PLAs were also used in other Commodore computers and periphery. For example a 251641-02 from a C16/C116/Plus4 was decapped. It had an 8700R1 inside, with just a different mask programming.

The C64 schematics also reference different types for the PLA, this is summarized in table 3.1. Schematic #252278 contains a PLA type MB112A101, which to the authors best knowledge has not been found on a C64 board yet.

PCB Assy	Schematic	PLA types listed
326298	#326106	82S100
250407	#251138	7700
250425, 250441	#251469	7700, 8700
250446	#252278	8700, MB112A101

Table 3.1: PLAs on various C64 schematics

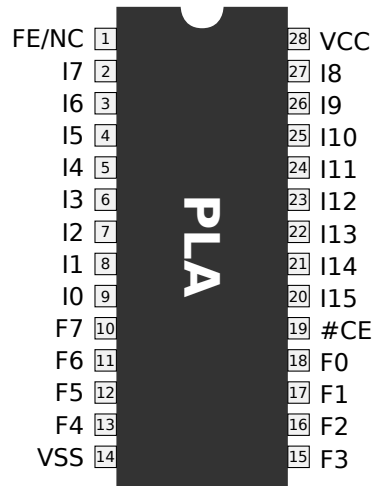

Figure 3.1: PLA pinout

3.2 Package and Pin Assignment

The PLAs used in the C64 are packaged in a 600 mil wide DIP with 28 pins, usually made of plastic. The pinout diagram is shown in figure 3.1. It has two supply pins, VCC (5 V) and VSS (0 V). There are 16 inputs to the logic functions and one output enable (#OE) to tristate or enable the outputs. The 8 outputs have push-pull drivers. The special pin FE/NE is used for programming field-programmable parts and not connected internally for mask programmable parts.

3.3 Electrical Properties

In this section the results of measurements of some electrical properties of original PLAs and different PLA replacements are shown. Their meaning for the inner workings of the C64 is discussed.

Devices Under Test

The measurements for this document were done with one sample of each of the two most frequently used bipolar PLAs, the Signetics 82S100 and the Fairchild 93459PC. Three samples of the 906114-01 with different date codes were also tested. Finally three PLA replacements were checked, the EPROM STMicroelectronics M27C512-90B6, which is

Package Label	Type	V_{OH} [V]	Technology
N82S100N S C64 K8303	Signetics 82S100	4.2	Bipolar
93459 PC F 8235	Fairchild 93459PC	3.9	Bipolar
906114-01 2683	MOS 7700R1	3.7	NMOS
906114-01 4885	MOS 8700R2	3.8	NMOS
906114-01 2488	MOS 8700R2	3.7	NMOS
M27C512-90B6	EPROM M27C512-90B6	4.9	CMOS
SuperPLA	SuperPLA V2	4.0	CMOS/NMOS ^a
realPLA	realPLA	5.0	CMOS

Table 3.2: PLA devices under test

said to be the EPROM ideally suited for this usage, the SuperPLA V2¹ from Individual Computers and the realPLA, which is introduced in this document.

Gerrit Heitsch found another PLA type in a C64 which seems to be manufactured by Fujitsu, according to its package shape and printing. This type has a much lower power consumption than other original PLAs. It was not examined for this document yet, but listed for the sake of completeness.

Table 3.2 lists all devices under test (DUTs). This table contains also the voltage of an output high level V_{OH} . This is a valuable indicator to the semiconductor technology used. However, the technology is listed in the datasheets for most of the parts.

As a rough guideline the bipolar parts have a V_{OH} of about $V_{CC} - 1.0V$. The NMOS parts have a V_{OH} of $V_{CC} - 1.3V$, where 1.3V is V_{th} of an N-channel FET used in the pad buffer totem pole. Details about the actual circuitry used there will be described in section 4. The CMOS parts have a V_{OH} of about V_{CC} . The SuperPLA is a special case, refer to section 3.3 for details.

Power Consumption

One of the most impressive properties of the PLA is: It gets quite hot for the little work it has to do. To get an impression about their static power dissipation, the devices were mounted on a breadboard. #OE was connected to GND. All inputs were pulled high, the outputs did not have a load. The current at V_{CC} was measured with a multimeter.

Additionally the temperature was captured with an infrared thermometer in the middle of the chip package's surface at an ambient temperature of 24 °C. Note that the temperature is a rough estimation only. In some cases the temperature is higher for a part which needs less power compared to another part. The reason may be different physical properties of the chip package² or simply inaccurate temperature measurements.

Table 3.3 shows the results of these measurements.

The 82S100 and the 93459 use bipolar technology, basically TTL or Schottky TTL. They have the highest power consumption.

Also the NMOS implementation has a quite high power dissipation, which is caused by the depletion load NMOS logic which needs relatively strong pull-up devices to get the same switching speed as the bipolar original.

¹While this document has been written, a revised Super PLA V3 has been released, it has similar characteristics as V2, it can replace PLAs in multiple Commodore devices

²All of them where plastic packages

DUT	I_{idle} [mA]	T [°C]
82S100	102	45
93459PC	98	57
7700R1 (2683)	92	52
8700R2 (4885)	90	53
8700R2 (2488)	86	39
M27C512-90B6	4	26
SuperPLA	68	42
realPLA	13	28

Table 3.3: PLA power consumption and package temperature

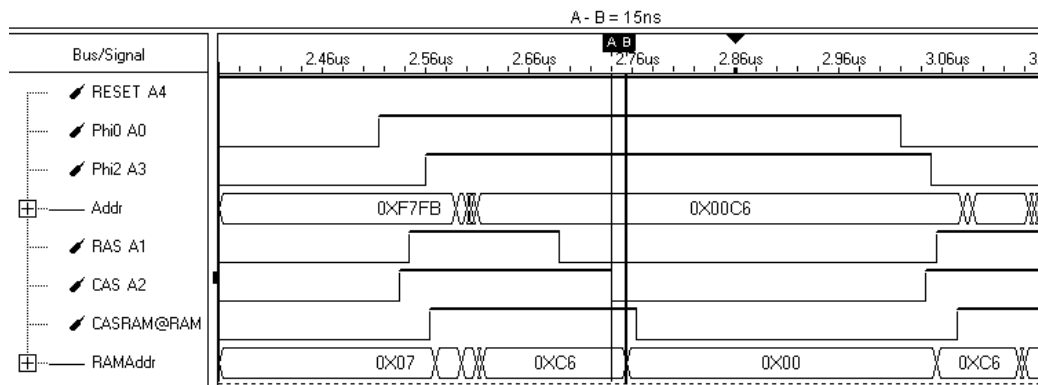

Figure 3.2: The #CAS race

The pure CMOS variants EPROM and realPLA have the lowest idle power consumption.

The PLD used in the SuperPLA uses CMOS technology according to its datasheet [Mach110]. But the relatively high static power consumption and its V_{OH} of only 4.0 V (refer to table 3.2) shows that it must use some kind of hybrid logic, e.g., pseudo NMOS logic. This is indirectly confirmed by some figures in that datasheet, e.g., the output driver uses an NMOS totem pole instead of a real CMOS totem pole, most likely for higher speed vs. chip area compared with PMOS FETs.

Propagation Delay

The propagation delay of the PLA is very important for the correct work of the C64. For example, the #CASRAM signal must be delayed by the PLA by at least a certain time. On the other hand, the propagation delay must not be too large, otherwise e.g., setup times of the chips which get their select signals too late may be violated.

The #CAS signal from the VIC-II is also used to multiplex the address bus for the DRAM address inputs. This is done with U13 and U25 (74LS257), which have a maximum propagation delay from their select input (#CASRAM) to their outputs of 24 ns [TI257]. Typical DRAM chips used in the C64 have an address setup time of at least 0 ns before #CAS, an example is the HM4864A ([Hita4846]). This means that the #CASRAM signal must be delayed by at least this time, otherwise the DRAMs would latch the wrong column address. This timing dependency could be called a design flaw in the C64. Figure 3.2 shows that the multiplexed address changes about 15 ns after #CAS and becomes stable just about 10 ns before #CASRAM gets active on this board.

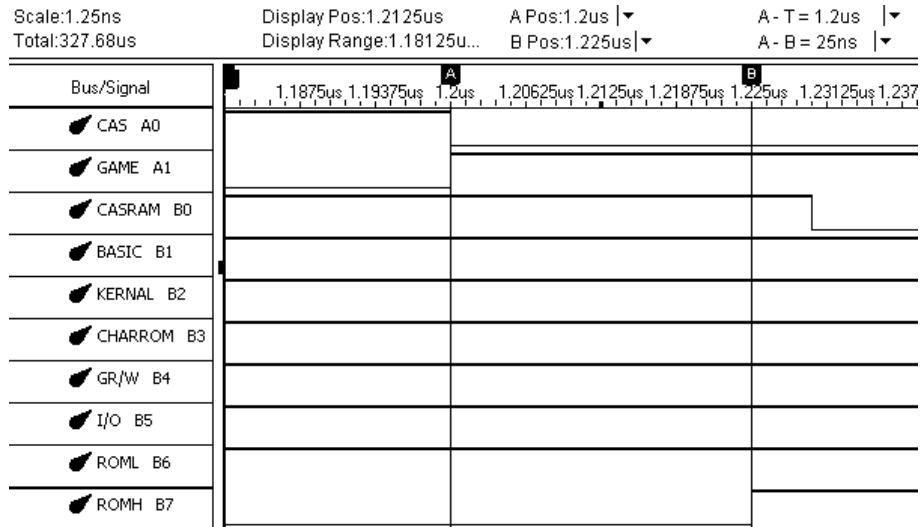

Figure 3.3: Example propagation delay measurement, DUT is 8700R2 (2488)

The measurements shown here were done with a 200 MHz logic analyzer, so the error is about ± 5 ns. The input signals $\#CAS$ and $\#GAME$ were connected to a binary counter. The output signals were sampled with a threshold voltage of 1.3 V, which is close to the threshold voltage of NMOS inputs. $\#CASRAM$ and $\#ROMH$ have been chosen as outputs because one of them has an inverted logic compared to the other one. This may cause these two to have different delays. Figure 3.3 shows the output of one of these measurements. Table 3.4 lists the results. There may be slightly different propagation delays for situations where several inputs change simultaneously, this has not been considered for the measurements.

The propagation delays of original PLAs are of the order of $25 \text{ ns} \pm 5 \text{ ns}$. Note that the 7700R1 is about 5 ns to 10 ns slower than the other types. The bipolar PLAs have a slightly slower effective delay for low to high transitions because their rising edges are very slow.

The EPROM M27C512-90B6 is a bit quicker than the original PLAs, but still in the same ballpark.

The SuperPLA has its CASRAM delay tuned to be in the right order, which is important for the DRAM control in the C64. But the delay of the other outputs is much lower than the values seen on original parts. This seems not to play a role usually, but there may be C64 boards and cartridges which may have problems with this difference. Note that the logic in the SuperPLA inhibits that other outputs to become low when $\#CASRAM$ is still low, which would lead to overlapping chip selects otherwise, due to the different delays.

The realPLA was designed to have an authentic delay and to have matched delays among all outputs. This measurement confirmed that this aim was reached.

Slew Rate

Some of the signals generated by the PLA are connected to long PCB traces and connected to the Expansion Port, which may be connected using a ribbon cable (as in the SX64) or may have a port expander or large PCB attached to it. Signals with very steep edges

DUT	#CASRAM		#ROMH	
	T_{pdLH}	T_{pdHL}	T_{pdLH}	T_{pdHL}
82S100	35	25	25	25
93459PC	35	20	35	20
7700R1 (2683)	30	35	40	30
8700R2 (4885)	30	25	25	30
8700R2 (2488)	20	30	25	25
M27C512-90B6	20	20	20	20
SuperPLA	25	30	10	10
realPLA	25	30	25	30

Table 3.4: Propagation delays [ns]

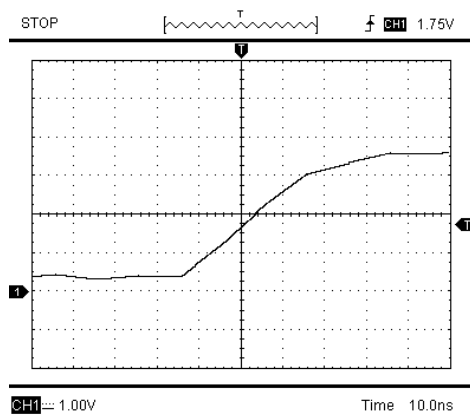

Figure 3.4: 82S100 - rising edge

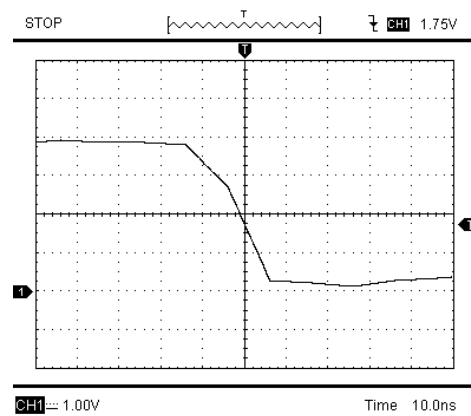

Figure 3.5: 82S100 - falling edge

could cause undesirable effects because of reflections on the PCB traces or result in strong switching noise.

To get an impression of the slew rate of all PLAs tested, they were connected to a test circuit. One of the inputs of each PLA was connected to a clock signal, one of the outputs was loaded with a capacitor (82 pF, which is a quite heavy load already) and captured with a digital scope. The scope I was using had a sample rate of 100 Msamples/s only, so the slew rates are a rough guess only.

A noticeable result of this measurement series is that bipolar and NMOS/CMOS PLAs have very different slew rates. The falling edge and the rising edge of the NMOS and CMOS PLAs are nearly symmetric, at least in the range between 1 V and 3 V.

However, the voltage of the bipolar PLAs raises very slowly over the whole voltage range but drops quite quickly. The reason is most likely an output stage similar to what is used in LS-TTL.

Overlapping Chip Selects

A potential problem with PLAs and PLA replacements is that they could activate multiple chip select signals at the same time. A reason for that can be slower high to low transition times than low to high or different propagation delays for different signal paths. Temporary bus contentions caused by these effects could lead to higher power dissipation and therefore higher heat generation in the chips involved.

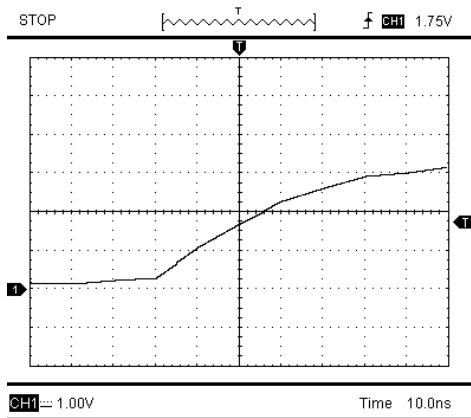

Figure 3.6: 93459PC - rising edge

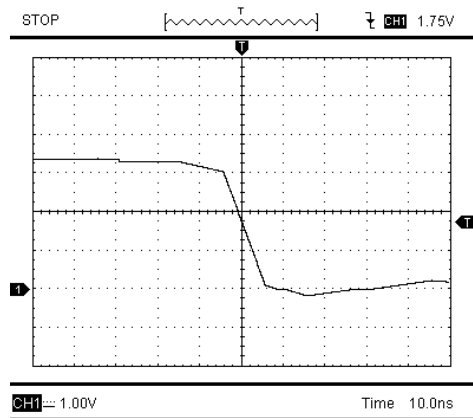

Figure 3.7: 93459PC - falling edge

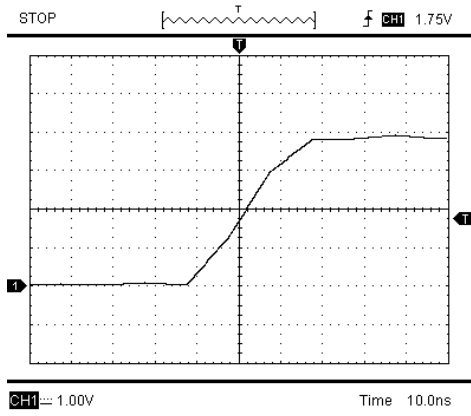

Figure 3.8: 7700R1 (2683) - rising edge

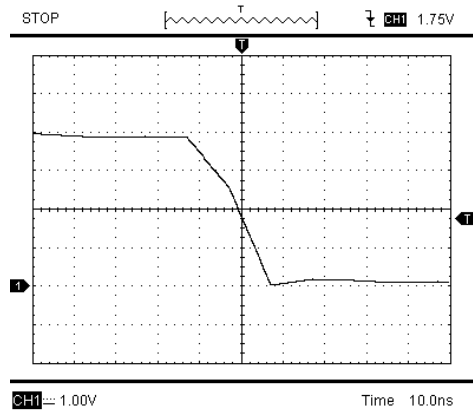

Figure 3.9: 7700R1 (2683) - falling edge

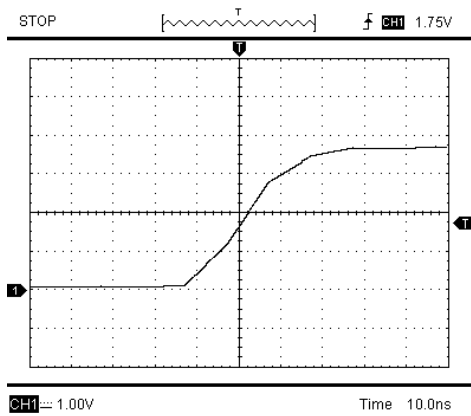

Figure 3.10: 8700R2 (4885) - rising edge

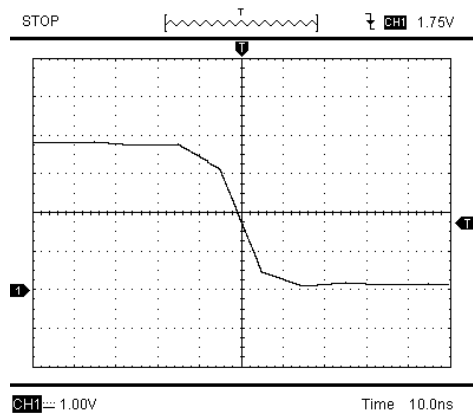

Figure 3.11: 8700R2 (4885) - falling edge

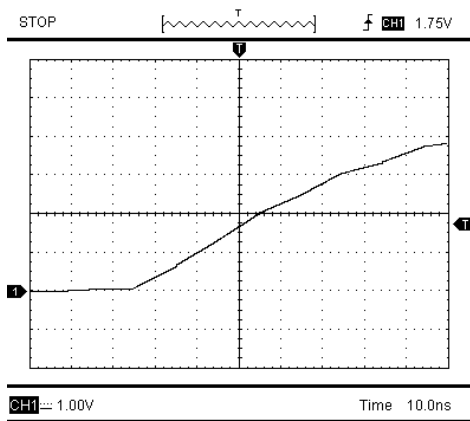

Figure 3.12: M27C512-90B6 - rising edge

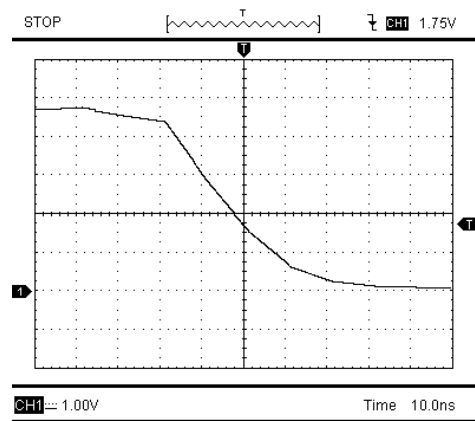

Figure 3.13: M27C512-90B6 - falling edge

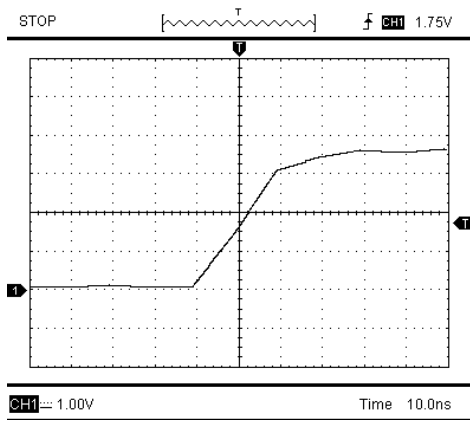

Figure 3.14: SuperPLA - rising edge

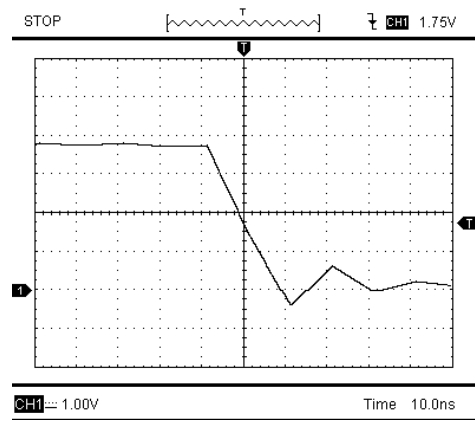

Figure 3.15: SuperPLA - falling edge

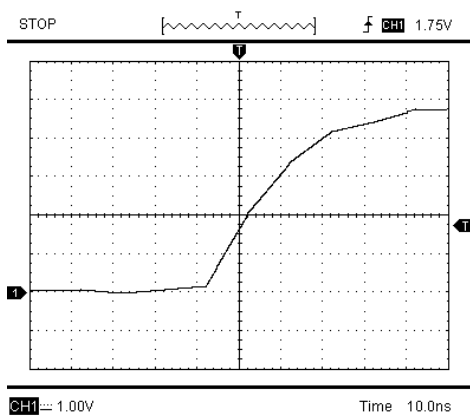

Figure 3.16: realPLA - rising edge

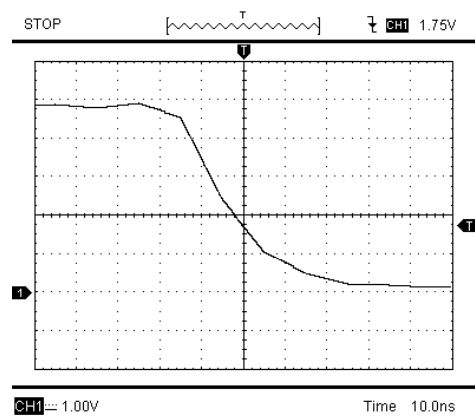

Figure 3.17: realPLA - falling edge

DUT	Overall I [mA]	PLA I [mA]	Board w/o PLA I [mA]
SuperPLA	695	59	636
8700R2 (2488)	720	82	638
8700R2 (4885)	721	82	639
M27C512-90B6	647	6	641
93459PC	736	86	650
Different Board, different PLAs:			
realPLA	782	15	767
M27C512-90B6	775	6	769
SuperPLA	837	68	769
82S100	875	105	770

Table 3.5: Board power consumption depending from PLA

After some investigations regarding this topic at [esl11], François Léveillé had the idea to measure the power consumption of a C64 with different PLAs attached. He did not elaborate this interesting experiment very much, so it was repeated for this document.

Two different C64s of revision 250407 were used. The 5V rail was cut at inductor L5 and the current was measured there. The supply current of such a C64 at the 5V line is about 50 mA higher when the computer is at room temperature than when it is warm. So in all cases the C64s have been left running with the BASIC screen shown until the current consumption was stable.

In a second experiment the plain V_{CC} current of the PLA was measured at the same state of the C64. This can be subtracted from the overall current to calculate the power consumption of the rest of the C64.

Table 3.5 shows the result of these measurements, sorted by board supply current at 5V without PLA supply current. Note that the first board had the KERNAL ROM replaced with a CMOS type, which is the reason for its lower overall power consumption.

The results show that the current differs, in addition to the different power consumptions of the PLAs themselves. The 93459PC causes the rest of the C64 to draw about 10 mA more, which confirms the theory by François Léveillé.

However, the additional 10 mA compared with the overall 800 mA are a bit more than 1%, distributed over at least two chips. This will not cause a noticeably increased heat generation nor reduced life time.

A closer look at the propagation delays and slew rates shown in section 3.3 reveals that the Fairchild 93459PC has very quick falling edges and very slow rising edges. This may lead to a bus contention with a duration of about 15 ns per transistion, which explains the slightly higher current.

Chapter 4

The Inner Workings of a CSG PLA

To investigate the actual implementation of the PLA in the part which was used most often in C64s, the MOS 7700R2/8700R1, they have been decapped and photographed under a microscope for this document.

To get rid off the package, the PLAs have been cooked in rosin two times for several hours. The abietic acid contained in rosin dissolved the plastic package. Finally the dies have been cleaned in isopropyl alcohol. Figure 4.1 et seq. show this procedure.

With these die shots the masks of the 8700R1 have been redrawn. The resulting chip layout was used to draw the schematics of the PLA.

4.1 The Original Designers

Even though the overall design of the PLA is not very complex, it may have been challenging to build the NMOS part with the same speed as the original bipolar part. It needs only approximately 25 ns for the whole row of gates comprising an input super buffer, another super buffer, a NOR array for the product term, another NOR array for the sum term, a super buffer and the pad push-pull buffer. It was designed by Dave DiOrio, he recalls, “It was a rather simple chip select circuitry.”

The PLA was produced over many years, but not all replacements for third party chips by Commodore had such a good fate. “At one time there was a shortage of some of the TTL components used on the platform so they even tried replacing those chips with an NMOS ‘equivalent’ that never really panned out due to speed problems,” recalls James Redfield.



Figure 4.1: The decapping procedure starts



Figure 4.2: The package starts to dissolve

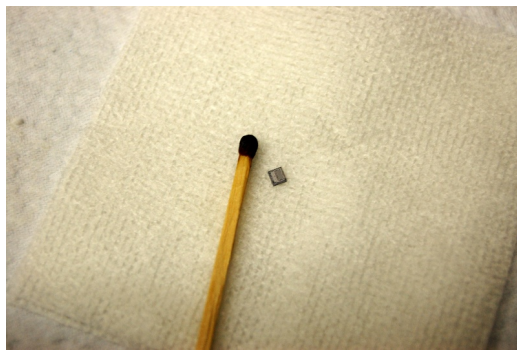

Figure 4.3: The die decapped and cleaned

The 7700R2 PLA has the initials “RD” and “JB” written on the metal layer. JB is the mask designer Joan Brenneke. She drew the polygons most likely, her colleague *RD*¹ digitized the layout into the Calma CAD system finally. Figure 4.4 shows their initials.

4.2 NMOS Process Generations

CSG evolved several generations of NMOS manufacturing. Before about 1983, the chips were numbered with a 6xxx scheme. Their manufacturing process was commonly referred to as NMOS and had a critical dimension (CD) of about² $8\ \mu\text{m}$ for the 6502, over the years they seem to have been reduced, The VIC-II (MOS 6567) was implemented with $6\ \mu\text{m}$ channel length³. The 7xxx chips appeared in about 1983. This process was called HMOS1. Only one year later, the next generation called HMOS2 was in use already, which was numbered 8xxx. The design rules had a CD of $5\ \mu\text{m}$ ⁴. The numbering scheme was not used consistently in all cases, for example the CIA was still called 6526(A) when it was manufactured using the HMOS2 process.

Dave DiOrio explains, “These dimensions were ‘drawn’ dimensions. Through the fabrication process there would be etching and effects that provided a different effective gate length.” This may be the reason that the PLA die shots look like they use a channel width of approximately $4\ \mu\text{m}$, although the nominal gate length were larger.

¹Name still unknown

²Measured on die shots

³According to James Redfield and Bret Raymis, this confirms measurements on die shots

⁴According to Bret Raymis

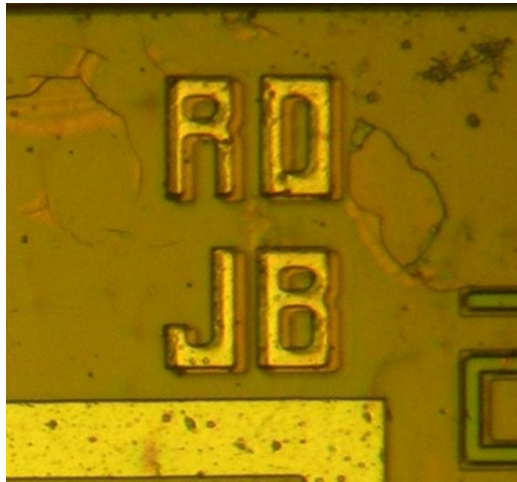

Figure 4.4: Initials found on the PLA 7700R2

There is no official definition for HMOS1 and HMOS2. Dan Morris recalls “All companies used similar naming conventions. [...] The photo process sets the classical shrink sequence. As photo equipment improves, smaller geometries can be resolved. Scaling through photo shrinkage allowed circuit designs to be reused without the need to redesign them. A 20% linear shrink would run [approximately] 40% faster at 40% lower power, and reduce production cost by 40% as well. So process engineering’s job was to develop a 20% shrink process about every 12 months. The number sequence identified each shrink step (HMOS1 to HMOS2) that process was running. When a process could no longer be shrunk a new process was developed and used the new design rules as its starting point. (NMOS to HMOS)”

Figure 4.5 shows the size of the two CSG PLAs. There is a noticeable 10% linear process shrink between these two revisions. Unfortunately the surface of the 7700R2 got damaged when it was decapped. Figure 4.6 shows (more or less) that the channel length was changed by the same factor, which confirms a photo shrink with changes in the metal layer for the labels only. When putting a die shot of the 7700R2 on top of a scaled die shot of the 8800R1, it can be seen that the match very well.

With the term *NMOS* this document refers to NMOS logic in general, no matter which process or structure size was used to manufacture it.

4.3 Reliability Failures

People who repair Commodore computers notice that the early PLAs fail quite often. Bil Herd recalls “By far the worst chip failure mode we had was the PLA around 1982-83 as it was suffering from poor passivation. It would get the ‘purple creeping crud’ which was corrosion under the protective layer.”

Dan Morris knows the reason for this issue: “The inter-layer glass (Low Temp Oxide or LTO) is doped with Boron and Phosphorus atoms. Boron and phosphorus are added to soften the glass and cause it to flow at lower temperatures. The flow smooths the surface of the circuit dramatically improving step coverage for the aluminum interconnections. Boron concentrations above 4% really accelerates the glass flow. Unfortunately raising the Boron concentration above 4% also sets up a strong but relatively slow corrosion reaction with aluminum. This is a reliability time bomb. As soon as the field failures demonstrated

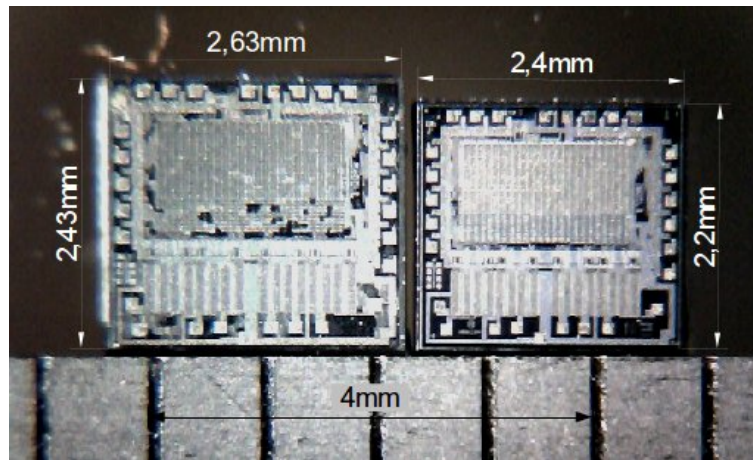

Figure 4.5: Sizes of MOS 7700R2 and MOS 8700R1 compared

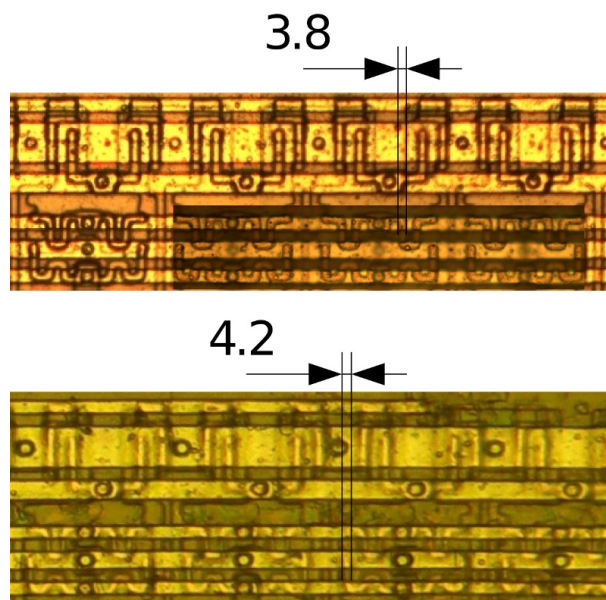

Figure 4.6: Approximate channel length of 7700R1 and 8700R1

a problem. The process was changed to reduce the Boron to less than 3%. Unfortunately, many, many computers shipped with this problem first.”

Dan Morris managed the manufacturing test and product engineering for the California semiconductor facility^a from September 1981 to 1985. His first task was to set up a silicon gate CMOS fab, this fab made metal gate CMOS up to then. “About three months into our production ramp up we got the word on a Friday night that we needed to stop all work and immediately convert the fab to run the NMOS process from Valley Forge. [...] The CMOS process we developed never went to production.”

“Our orders were ‘copy exactly’, no deviations allowed. That was a tall order, given different equipment and different process skills. We worked without sleep for 5 days. We took each process step and duplicated it on each piece of equipment and started the first fab lot on the 6th day. We ramped the fab to full production 4 weeks later after the first lot proved successful with yields better than the Valley Forge fab.” The California facility produced the majority of the integrated circuits for the VIC 20 and Commodore 64 computers.

Dan Morris also developed low cost test systems for wafer and final test of the audio and video chips.

^aFrontier Semiconductors, acquired by Commodore

The PLA seems to be more prone to failures than e.g., the 6510 or 8500 CPU. This may be caused by the fact that it was among the first chips made with the HMOS1 process. Another factor could be that it has a quite high power dissipation on a small die area compared to other chips. Its high temperature may speed up its aging, e.g., because of mechanical stress and by speeding up processes like electromigration [Hoffmann06]. Also the 7360 TED and the 7501 CPU are reported to fail quite often.

4.4 Block Diagram

Figure 4.7 shows the function blocks of the CSG PLA and their approximate position on the die. These function blocks will be described in the subsequent sections.

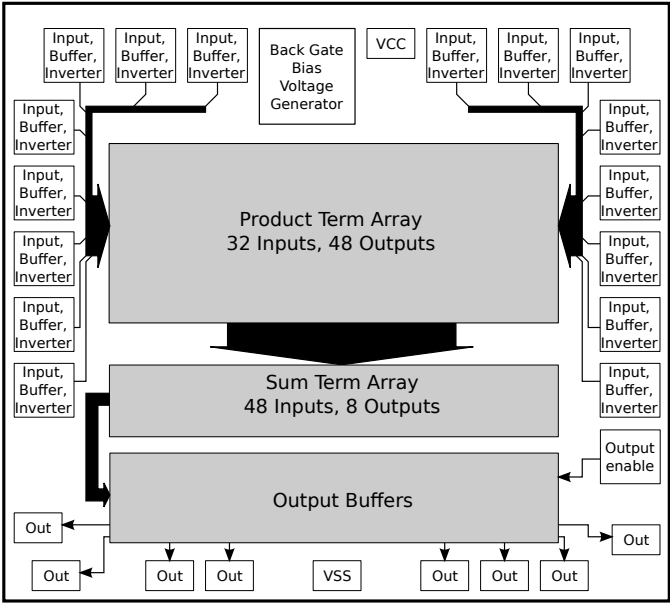

Figure 4.7: Block Diagram of the CSG PLA

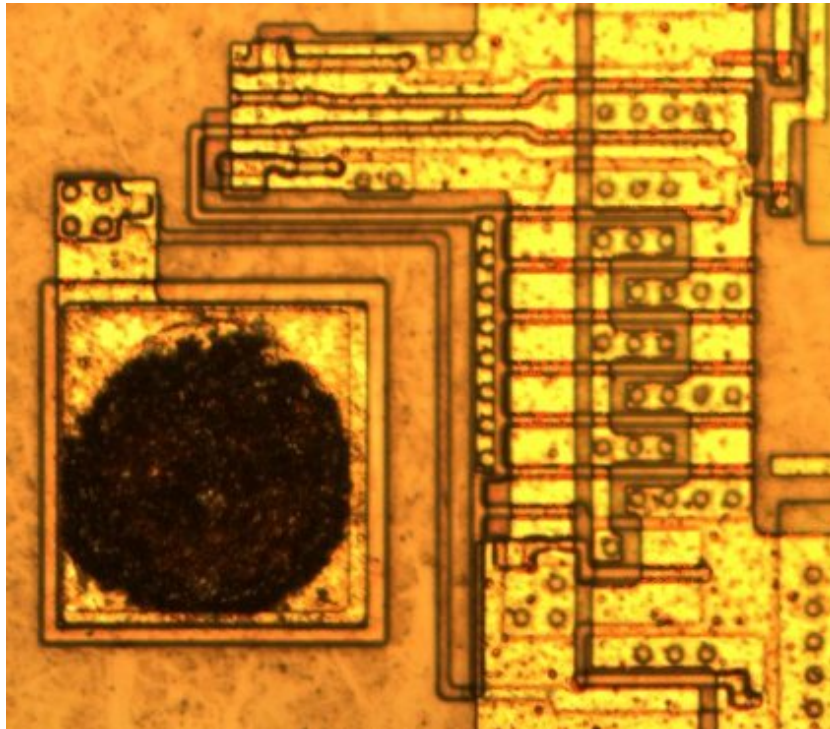

Figure 4.8: Die photograph of ESD protection, input buffer and inverter

4.5 Input Stage

All 16 function inputs of the PLA have the same input stage. An input contains a basic ESD protection made of a grounded gate FET T1 (GGNMOS). With a width of only $50\ \mu\text{m}$ this protection can only stand small ESD stress [Sem08]. The diffusion resistor R1 connects to the input pad I0. This resistor additionally limits current peaks, which supports the ESD protection mechanism.

The input signal is connected to a large inverting super buffer T2..T5 which creates an inverted signal #I0B. Additionally there are two inverting super buffers T6..T9 and T10..T13 to create a buffered signal I0B. These two output signals I0B and #I0B are connected to the rows of the AND array.

Note that the depletion mode pull-up devices of the final stages, T4 and T12 are very strong drivers, their width to length ratio (W/L) is about 35/6. They must be that strong to pull up all of the 48 small gates in the NOR array quickly enough.

Figure 4.8 shows a photo of an input stage, the redrawn layout is shown in figure 4.9 and the schematics in figure 4.10.

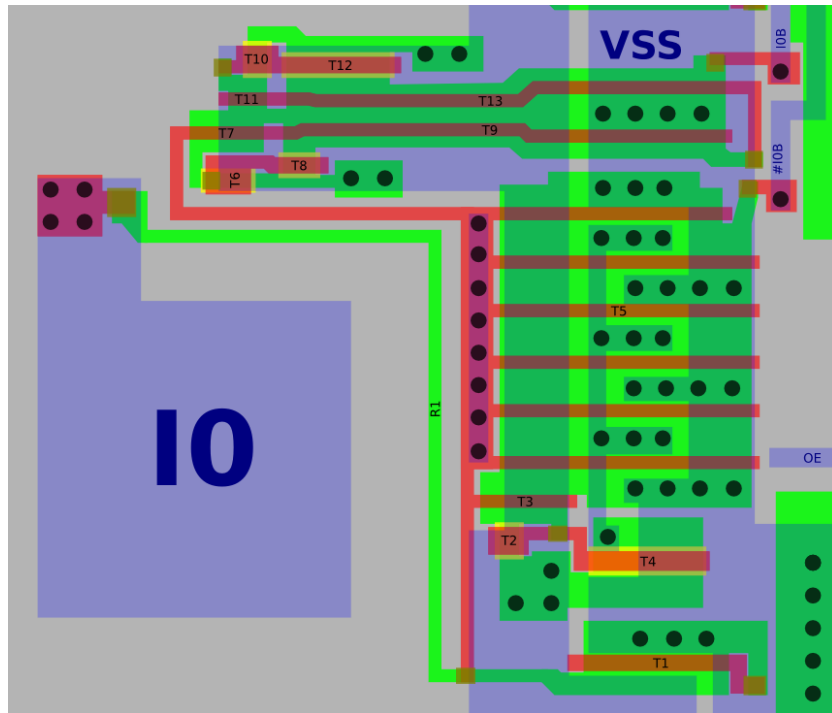

Figure 4.9: Layout of ESD protection, input buffer and inverter

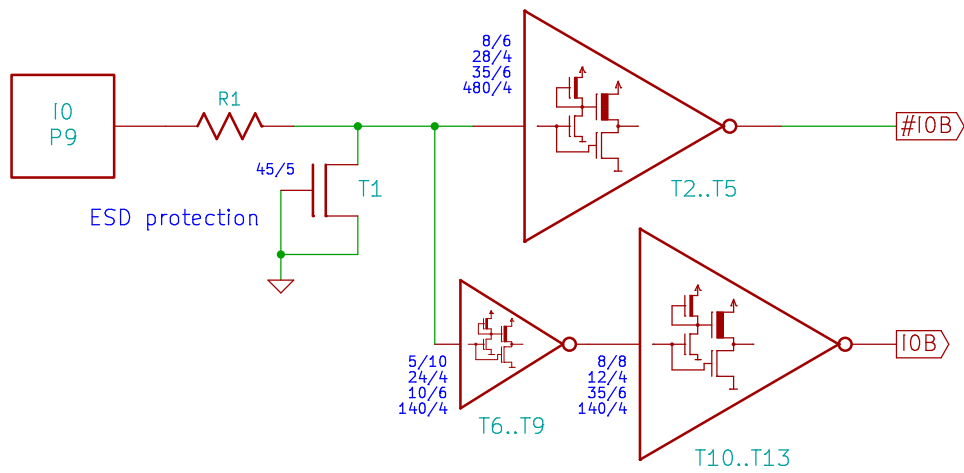

Figure 4.10: Schematic of ESD protection, input buffer and inverter

4.6 Output Enable

The output enable input contains the same ESD protection as the other inputs (R17, T209). An inverting super buffer T210..T213 is used to prepare the internal signal OE. Figures 4.11 to 4.13 show a photograph, layout and schematics of this circuit.

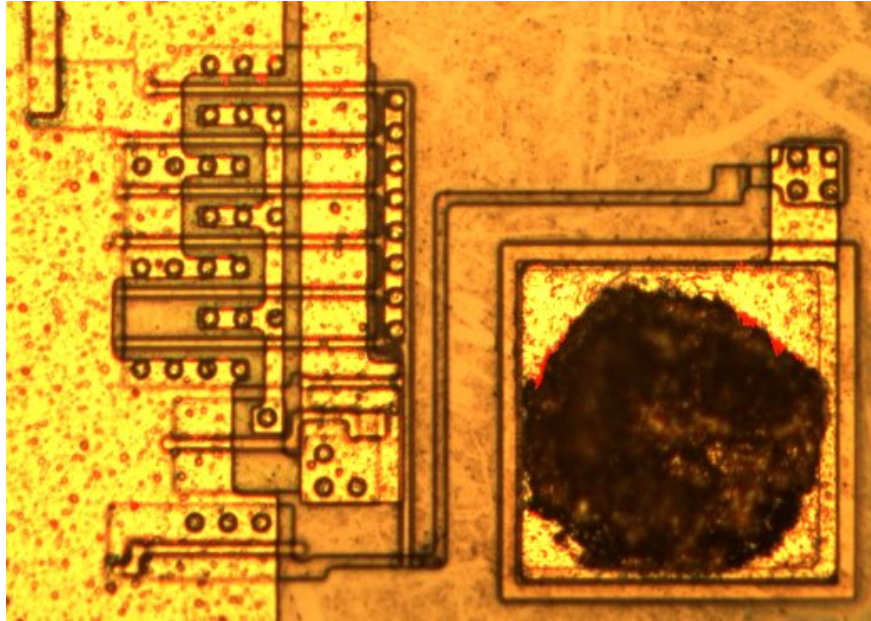

Figure 4.11: Die photograph of ESD protection and inverter for OE

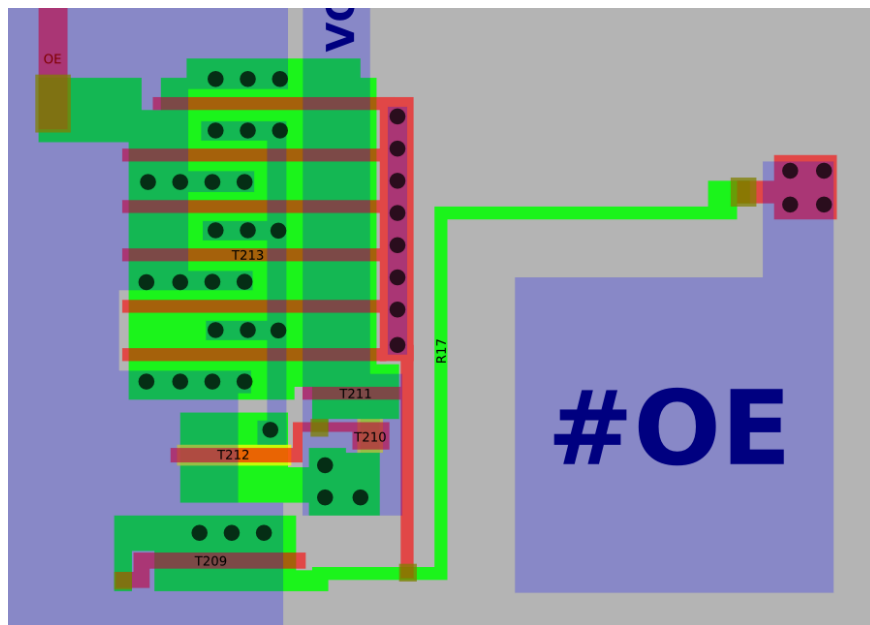

Figure 4.12: Layout of ESD protection and inverter for OE

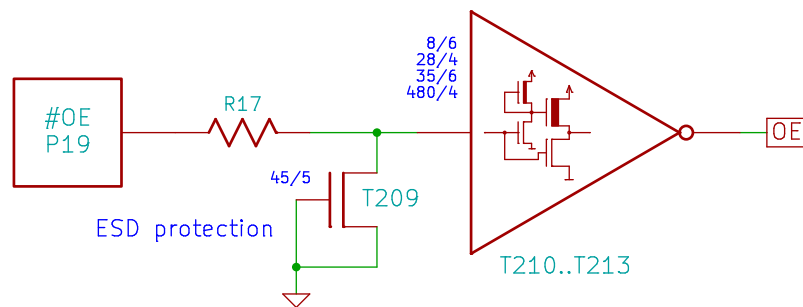

Figure 4.13: Schematic of ESD protection and inverter for OE

4.7 Product Term Array

A classical PLA contains a programmable AND array which has its outputs connected to a programmable OR array [Maini07]. The AND array is used for product terms and the OR array for sum terms.

The actual implementation of the AND array is realized with NOR gates with inverted inputs on the CSG PLAs, which has the same functionality according to De Morgan's laws. This implementation is also explained in [Mead79].

The product term array has 32 inputs, I0B, #I0B to I15B and #I15B and 48 outputs P0 to P47. Each of these 48 output columns can carry the result of a product term of the inputs.

Each input row is connected to 48 polysilicon tracks which can become gates for enhancement mode FETs. The field oxide mask, which also defines the diffusion layer, is used to program this array. Each of the $48 * 32$ array gates forms a FET only if it crosses a diffusion area. Otherwise it is just a piece of non-functional polysilicon.

Each output column has a pull up circuit to pull it high when no FET in the column is on. Any of the FETs in each column can pull the column down. This circuit is used to implement NOR functions.

The die photograph and layout 4.15 show two inactive nodes in the product term array and two nodes which were mask programmed to build FETs. The same parts are also shown in the schematic 4.16. To keep the numbering scheme simple, all gates have a transistor annotation 'T...', although only some of them are real transistors. The whole array is totally uniform, therefore only a part of it is shown here.

Figure 4.14 shows the encoding of the whole NOR array. The product terms are nearly in the same order as it was extracted from an 82S100. The unused terms p8 and p29 were removed (refer to section 2.7) and replaced with the terms initially numbered p31 and p30. So the numbering of the product terms is slightly different.

Figure 4.17 shows a high resolution detail of the pull-up circuit, even the contact through gate oxide can be seen there. The two images in figure 4.18 give a very good impression about the third dimension of the chip's surface. The microscope was focused on the active area at the first picture and on the poly or metal layer on the second one.

The graphics also show the pull up circuit mentioned before. Because of its relatively large width the pull up FET T426 is not a depletion mode FET but an enhancement mode device. Its gate is pulled up to V_{CC} with the depletion mode FET T424. This causes T426 to be switched on steadily.

The function of T425 could not be clarified. Its gate is tied to V_{SS} , therefore this FET is always off. One potential use of it could be bootstrapping. In this case the parasitic capacity C_{DS} of T425 would pull down or push up the gate voltage of T426 for a short moment, whenever the source voltage of this FET changes. This would increase its channel resistance on falling edges and decrease it on rising edges. Note that the drain-gate capacitance C_{DG} even has an opposite effect. SPICE simulations⁵ did not reveal a useful effect of this transistor. Also simulations with a zero-threshold device did not help. However, when a poly cap of a similar size, e.g., $20 \mu\text{m} \times 10 \mu\text{m}$ is put into the simulation, there is a much stronger bootstrap effect, which speeds up this gate by about 1 ns. Possibly the SPICE model parameters were not chosen correctly to simulate the intended effect. So it looks like the real reason for T425 is still unknown.

⁵MOSFET model level 3, various parasitic parameters defined with generic values, L, W, AS, AD, PS, PD measured and entered

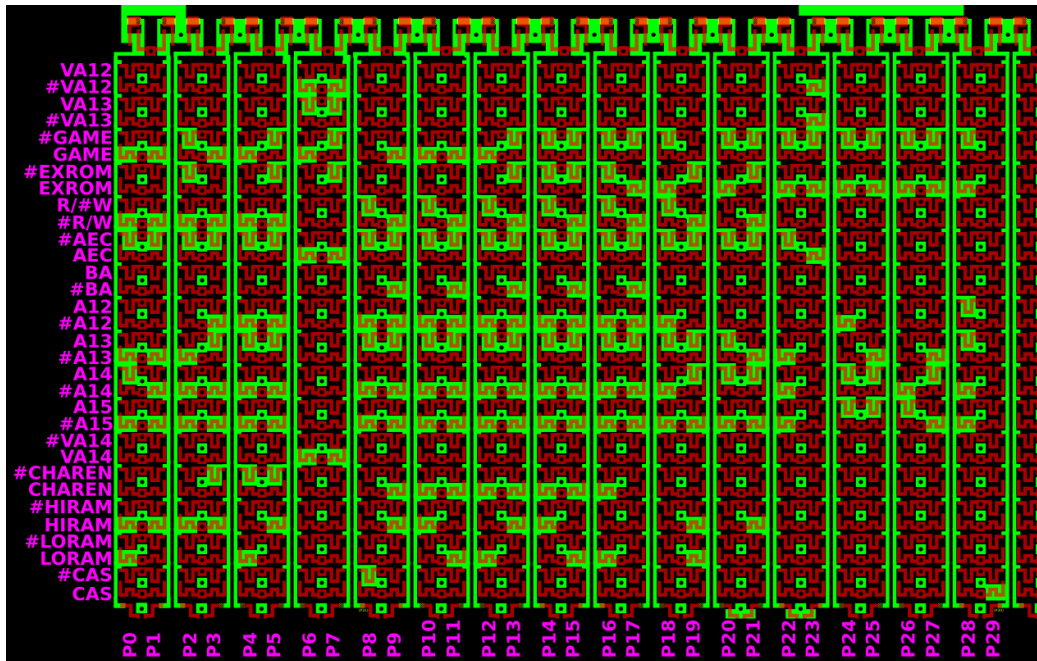
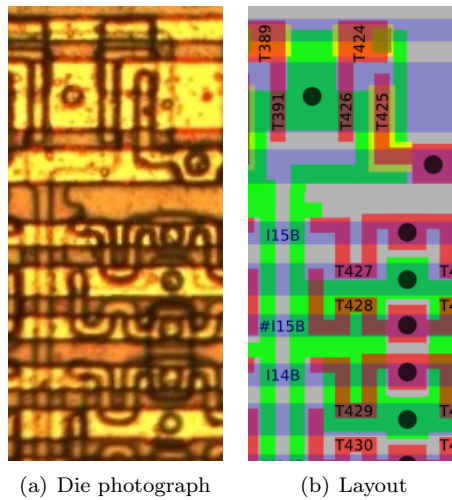

Figure 4.14: Product terms made readable in the layout



(a) Die photograph

(b) Layout

Figure 4.15: A part of the product term array

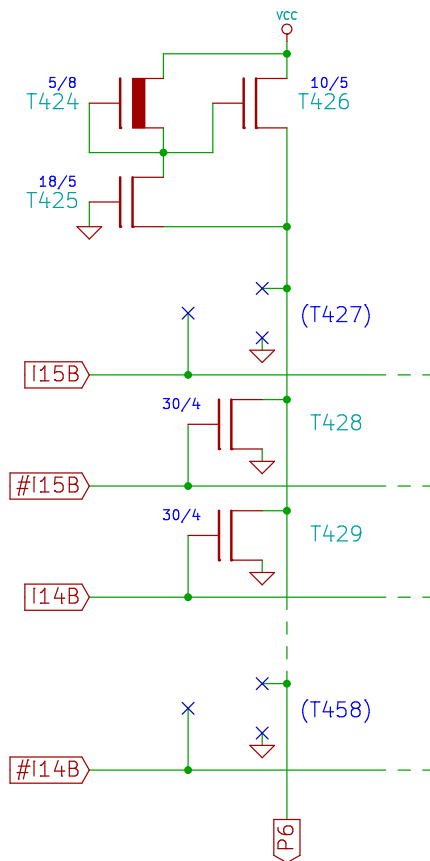

Figure 4.16: Schematic of a part of the product term array

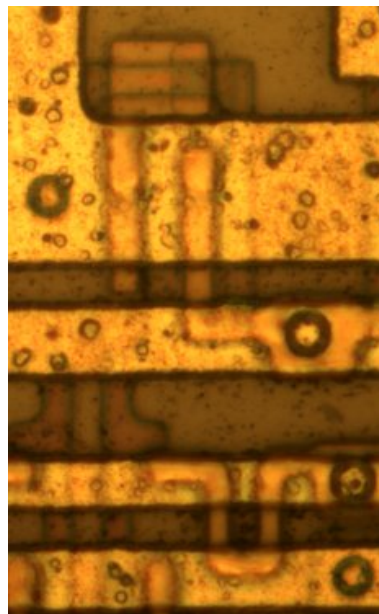

Figure 4.17: High resolution image of the pull-up part

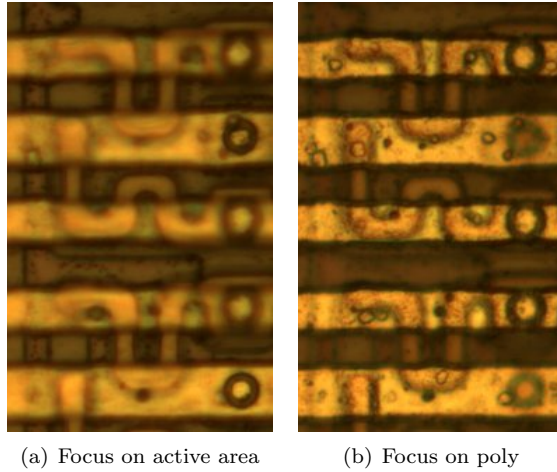

Figure 4.18: Different focal planes

The enhancement mode FET threshold voltage V_{th} in the CSG chips cannot be measured directly. However, it can be found by looking at the output pad buffers: They are implemented using a totem pole made of two NMOS FETs. When an output delivers a high level, the pull-up FET gets its gate voltage from a super buffer with a depletion mode pull-up, which delivers V_{CC} virtually. This NMOS pull-up can pull the output not higher than about $V_{CC} - V_{th}$. Measurements showed that the output voltage is about 3.7 V to 3.8 V, which means that V_{th} is approximately 1.3 V.

Note that V_{th} can not be measured on an input pad accurately, because the inputs are connected to a super buffer with depletion mode devices in its pull-up branches. A high level is only detected if the input voltage is higher than the inverter voltage V_{inv} , which is determined by the FET size ratios. However, given the large ratios seen on CSG chips, V_{inv} is not much higher than V_{th} .

Unfortunately it is not possible to accurately simulate or calculate the dynamic behaviour of these chips, because too few parameters are known. However, some things can be calculated, for example the output voltage of a product term V_O . It depends on how many pull-down FETs are switched on, the size of the FETs involved, V_{CC} and V_{th} .

As an example V_O for a single pull-down device being active is calculated here. The gate and source of a pull-up FET (e.g. T426) are at approximately V_{CC} (5 V). Its source is at output voltage V_O .

$$V_{GSu} = V_{DSu} = V_{CC} - V_O \quad (4.1)$$

The drain of a pull-down FET (e.g. T428) is also at V_O , its gate is at V_{CC} , due to the depletion mode super buffers, and the source at V_{SS} (0 V).

$$V_{GSd} = V_{CC} \quad (4.2)$$

$$V_{DSd} = V_O \quad (4.3)$$

The ratio between pull-up device and pull-down device will be called z :

$$z = \frac{\frac{W_d}{L_d}}{\frac{W_u}{L_u}} \quad (4.4)$$

Because of (4.1) $V_{GS} < V_{DS} + V_{th}$ is valid, the pull-up FET is saturated. So its drain current is calculated as follows:

$$I = K \frac{W}{L} (V_{GS} - V_{th})^2 \quad (4.5)$$

With K being a constant which describes some physical properties of the FETs. Refer to [Raj08] for details about K , (4.5) and (4.6).

Because the pull-up device is a depletion mode FET, it is known that $V_O < V_{CC} - V_{th}$, which means that $V_{GS} > V_{DS} + V_{th}$. Therefore the pull-down FET is not saturated. For this case (4.6) is used.

$$I = K \frac{W}{L} [2(V_{GS} - V_{th})V_{DS} - V_{DS}^2] \quad (4.6)$$

This equation can be written in a form which will be more handy later, the result is (4.7)⁶.

$$\begin{aligned} I &= K \frac{W}{L} [2(V_{GS} - V_{th})V_{DS} - V_{DS}^2] \\ &= K \frac{W}{L} [2V_{GS}V_{DS} - 2V_{DS}V_{th} - V_{DS}^2] \\ &= K \frac{W}{L} [V_{GS}^2 - 2V_{GS}V_{th} + V_{th}^2 \\ &\quad - V_{GS}^2 - V_{DS}^2 - V_{th}^2 + 2V_{GS}V_{DS} + 2V_{GS}V_{th} - 2V_{DS}V_{th}] \\ &= K \frac{W}{L} [(V_{GS} - V_{th})^2 - (V_{GS} - V_{DS} - V_{th})^2] \end{aligned} \quad (4.7)$$

The current flows through both FETs and there is no significant load current once the circuit reached a static state, therefore (4.5) and (4.7) can be used:

$$\begin{aligned} I_{Du} &= I_{Dd} \\ K \frac{Wu}{Lu} (V_{GSu} - V_{th})^2 &= K \frac{Wd}{Ld} [(V_{GSd} - V_{th})^2 - (V_{GSd} - V_{DSd} - V_{th})^2] \end{aligned}$$

With the values from (4.1) to (4.3):

$$\begin{aligned} (V_{CC} - V_O - V_{th})^2 &= z[(V_{CC} - V_{th})^2 - (V_{CC} - V_O - V_{th})^2] \\ (V_{CC} - V_O - V_{th})^2 &= z(V_{CC} - V_{th})^2 - z(V_{CC} - V_O - V_{th})^2 \\ (z + 1)(V_{CC} - V_O - V_{th})^2 &= z(V_{CC} - V_{th})^2 \end{aligned}$$

Both sides are positive:

$$\begin{aligned} \sqrt{z + 1}(V_{CC} - V_O - V_{th}) &= \sqrt{z}(V_{CC} - V_{th}) \\ \sqrt{z + 1}(V_{CC} - V_{th}) - \sqrt{z + 1}V_O &= \sqrt{z}(V_{CC} - V_{th}) \\ (\sqrt{z + 1} - \sqrt{z})(V_{CC} - V_{th}) &= \sqrt{z + 1}V_O \\ V_O &= \frac{\sqrt{z + 1} - \sqrt{z}}{\sqrt{z + 1}}(V_{CC} - V_{th}) \\ V_O &= (1 - \frac{\sqrt{z}}{\sqrt{z + 1}})(V_{CC} - V_{th}) \end{aligned} \quad (4.8)$$

⁶Thanks to Segher Boessenkool for pointing me to the transformed equation. However, deriving it from the equation found in most books needs a bit of magic.

Die shots show that $\frac{W_d}{L_d}$ is about $3\frac{W_u}{L_u}$, so $z = 3$. With $V_{CC} = 5\text{ V}$ to and $V_{th} = 1.3\text{ V}$ this results in:

$$V_O = \left(1 - \frac{\sqrt{3}}{\sqrt{3+1}}\right)(5\text{ V} - 1.3\text{ V}) \\ \sim 0.5\text{ V}$$

This gives a nice low level output. The voltage will be lower with more pull-down FETs turned on, which is equivalent with higher values for z .

James Redfield was hired by Al Charpentier specifically to work on the VIC-II chip. Al Charpentier, James Redfield and Dave DiOrio developed the VIC-II together. I asked James about the methodology taken to develop the design of the Commodore chips. “There were no logic simulations in those days,” he explains, “everything was manual expect for pure transistor simulations with SPICE [...]” A custom chip design is a very complex work. To give an impression of some of the steps needed to be done, James explains, “Before joining Commodore, one of the grad courses I had taken was a class in VLSI systems design. That class used a book that was the authority for NMOS circuit design at the time: ‘Introduction to VLSI Systems’ by Carver Mead and Lynn Conway [Mead79]. I would highly recommend that any serious student of early VLSI design methodology purchase a copy of this book if at all possible! [...] For example, chapter 1 walks the student through calculations necessary to derive the proper transistor dimensions that will establish logic switching thresholds that yield the greatest noise immunity. The inverter is the most basic element, it is analyzed to develop the optimal aspect ratio (the optimal NMOS switching device W/L dimensions to depletion device W/L dimensions). Once established this ratio can easily be extended to cover [other] logic elements. This optimal aspect ratio is always the same for any given process technology. Once it’s been derived the main consideration for sizing transistors is the load seen by each gate. To assist in sizing the transistors, my methodology was as follows. At the start of the project I would run a series of simulations to generate a table of load versus gate size delay information. The circuit in the simulation was a string of six inverters, each inverter connected to identical load capacitance and the sizes on each inverter all set the same. I would measure the delay time between nodes 3 and 5 in the inverter string and divide by two (to average out rise versus fall delay). I would then have a table of delay versus transistor size for a wide range of load capacitance that I would reference to size paths in the chip I was building. In logic devices, required timing for each path is dictated by the frequency of the clock used to clock the launching and sampling flip-flops. The period of the clock divided by the number of logic gates between each set of flops specified how fast each gate in the path needed to be. I would start with the sampling flop, estimate the input load of the flop and select the size for gate driving the input based on that load and the time budgeted for each gate in that path. That gate having been sized I could move back to the next gate and size that one. This provided a preliminary design that could then be simulated with spice [...].

Of course this is very simplified overview of the design process. Many factors could dictate other size choices for example die real-estate available and power requirement are two other considerations.”

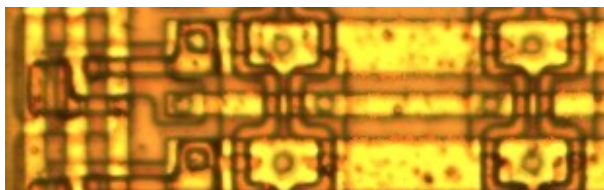

Figure 4.19: Die photograph of a part of the sum term array

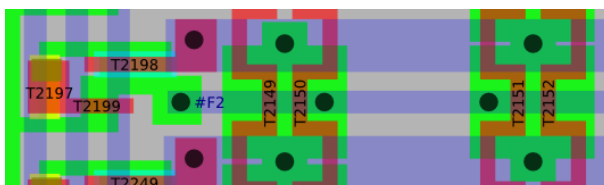

Figure 4.20: Layout of a part of the sum term array

4.8 Sum Term Array

The sum terms are also implemented using a NOR array. The output signals are inverted compared with a plain OR array, but this does not matter since the final output will still go through amplifiers and can be programmed to be inverted anyway.

Each output signal from the product term array is connected to a column of polysilicon. Eight metal rows cross these columns. These rows carry the sum terms #F0 to #F7. Each row has a pull-up circuit of the same kind as used in the product term array.

The field oxide mask is used to program FETs, like in the other array. Additionally contacts to metal are needed here. Obviously these contacts are not at every potential FET, but only at FETs actually implemented. This means that two masks had to be changed to program a PLA.

The ratio between pull-up FET and pull-down FETs is the same as in the product term array.

Figures 4.19 to 4.21 show a photograph, layout and schematics of this circuit.

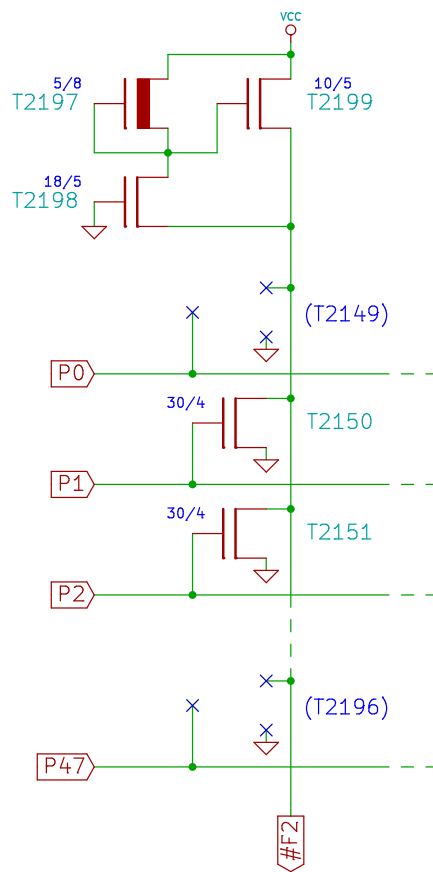

Figure 4.21: Schematic of a part of the sum term array

4.9 Output Stage

Each function result like #F0 is inverted with a quick inverting super buffer (T2302..T2305), which results in the complementary value F0. F0 and #F0 are combined with OE with a logical NAND function (T2306..T2310). The resulting intermediate signals are buffered with two larger super buffers to be able to drive the gates of the pad buffer quickly.

The push-pull totem poles for the output pads are really huge. These 16 FETs take about 25% of the chip area. Björn ‘JMP\$FCE2’ Wieck examined their drive strength. When an output is low, it can sink more than 80 mA while still being in the linear region⁷, i.e. the output is still below 1.3 V in this situation. When the output switched from low to high, the pull-up FET will deliver the same current as long as the source voltage is still very low, so also low to high transitions rise over the threshold voltage quickly. Due to the characteristics of an N-channel FET the drive strength decreases at higher output levels which result in lower V_{GS} .

Figure 4.22 to 4.24 show photo, layout and schematic diagram of the output stage.

Why did the initials disappear? People who worked on reverse engineering CSG chips noticed that older chips usually have the initials of their engineers written on it. Later revisions do not have these nice signatures anymore. A certain incident was the reason.

In about 1984 or 1985 several chips were redrawn for the HMOS2 process to reduce cost. Bret Raymis worked on a shrink of the SID chip from 6 to 5 micron. He recalls, “I almost got fired for putting my initials on the chip with it appearing in 3 spots across the die with ‘Dave’s^a Bar and Grill’. The SID had three identical large blocks with a hole in the middle.” Dave DiOrio confirms this story, “It actually got fab’ed and the mask shop went berserk.”

Bret’s intention was to make a joke, “But the president of Commodore did not think it was funny. Fortunately Mike [Angelina] took the heat and I did not get fired.” The chip in question was the 8580 R1 most likely. Unfortunately only later revisions have been seen up to now, which do not carry this Easter egg anymore.

James Redfield concludes, “And from that day on we were no longer permitted to include our initials on the chips.”

^areferring to Dave DiOrio

⁷Don’t try this at home, the PLA won’t survive this for long

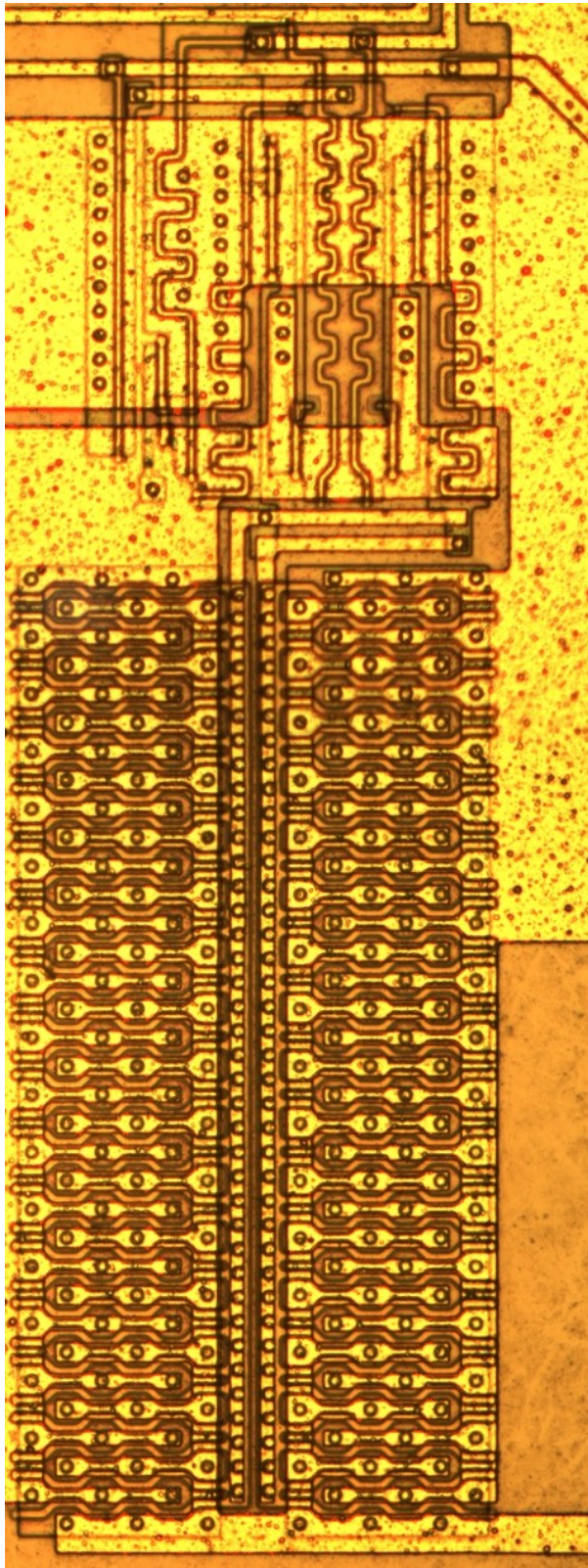

Figure 4.22: Die photograph of the output stage

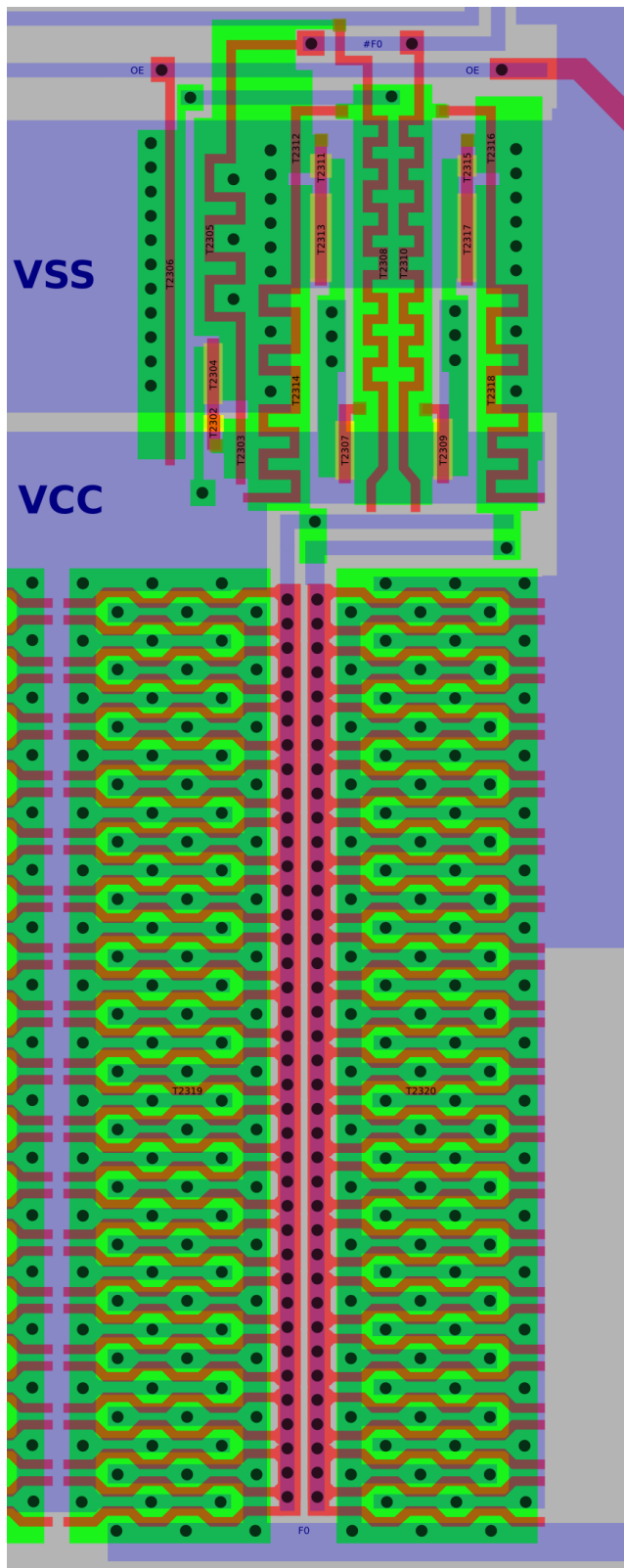

Figure 4.23: Layout of the output stage

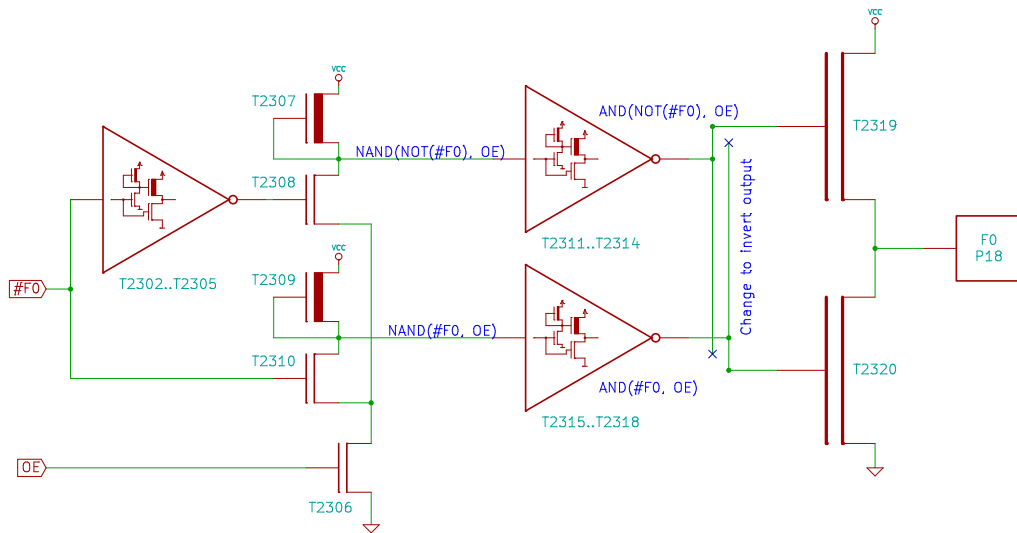

Figure 4.24: Schematic of the output stage

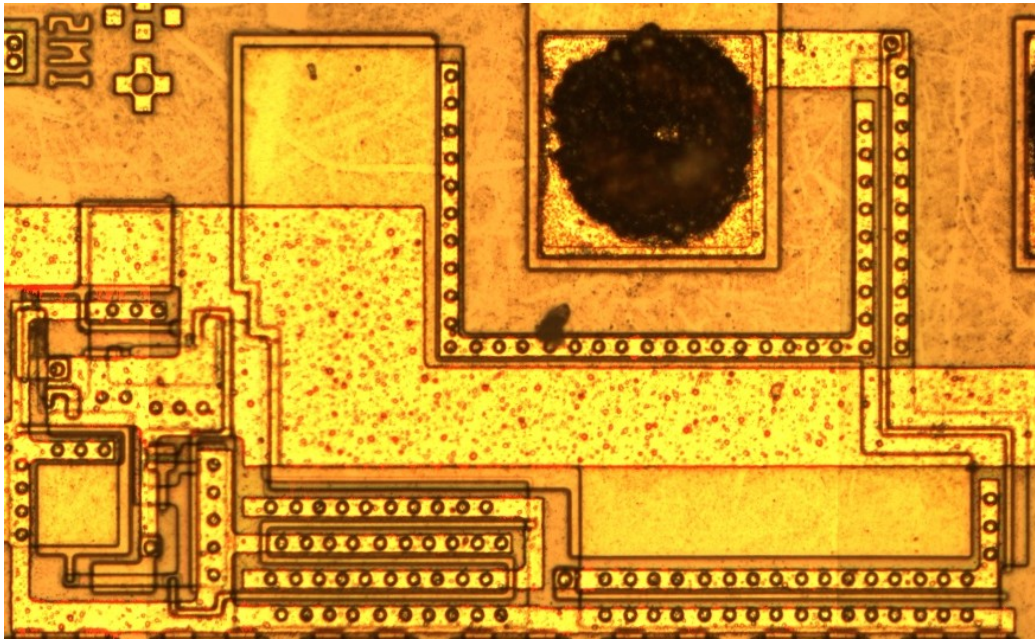

Figure 4.25: Die photograph of the back-gate bias generator

4.10 Back-Gate Bias Generator

The HMOS1 and HMOS2 processes used to make the PLAs use a back-gate bias generator to adjust the FET threshold voltage. Due to the body effect the threshold voltage of NMOS devices increases when the body voltage drops. The back-gate bias generator consists of an oscillator and a charge pump.

The circular oscillator consists of three inverters, T2462/T2463, T2458..T2461 and T2465/T2466. The oscillation frequency is limited by two RC low-pass filters, T2464/C3 and T2467/C2. The totem pole T2456, T2457 and C1 form the charge pump. The two FETs T2454 and T2455 function like diodes for the charge pump.

Figure 4.29 show a simulation of this circuit. The actual voltages and the oscillation frequency depend from the process parameters. As most of the parameters are not known, this simulation is only useful to show the working principle.

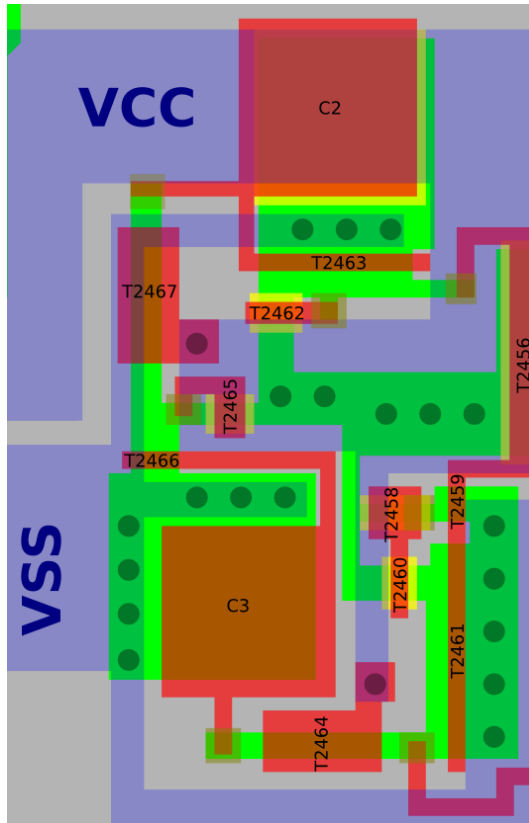

Figure 4.26: Layout of the back-gate bias generator (oscillator)

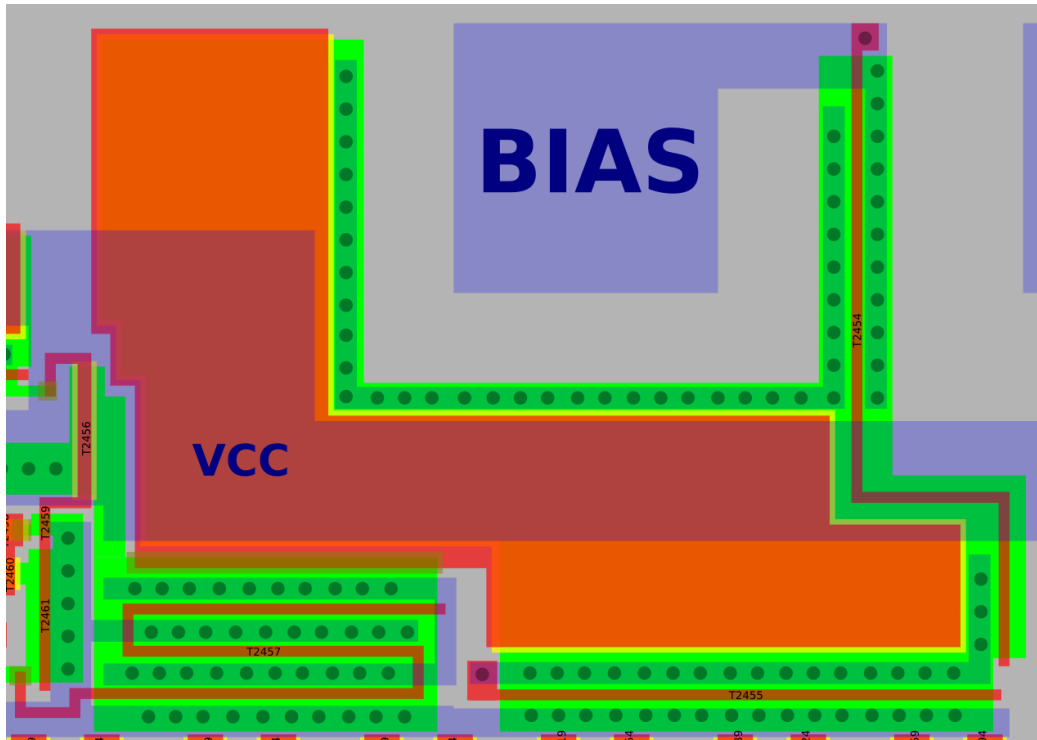

Figure 4.27: Layout of the back-gate bias generator (charge pump)

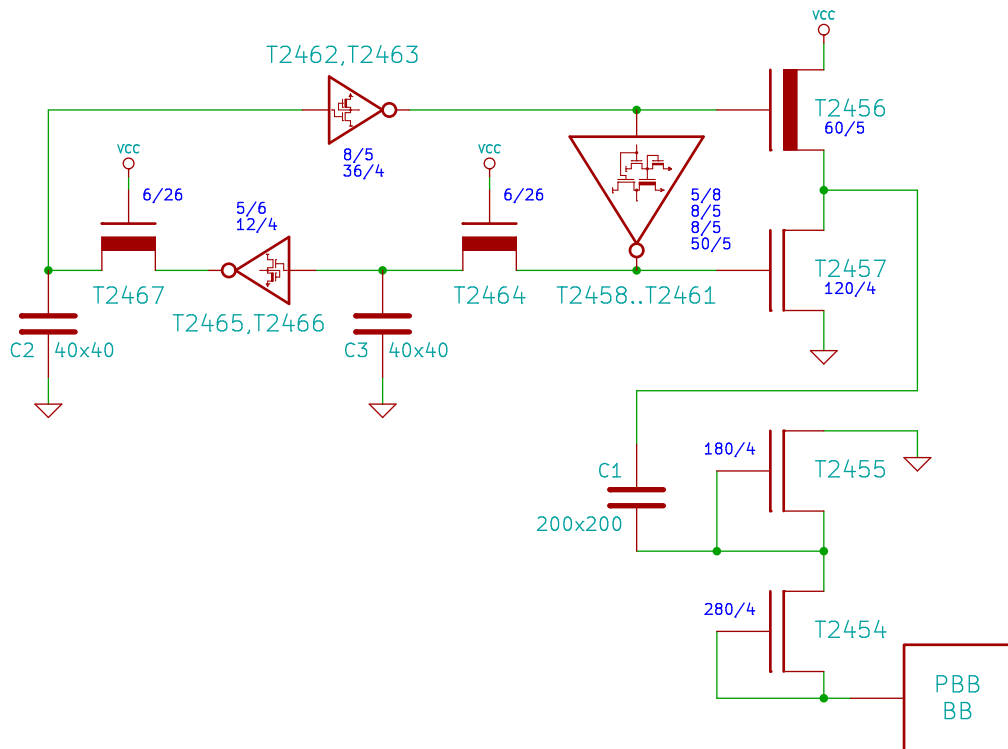

Figure 4.28: Schematic of the back-gate bias generator

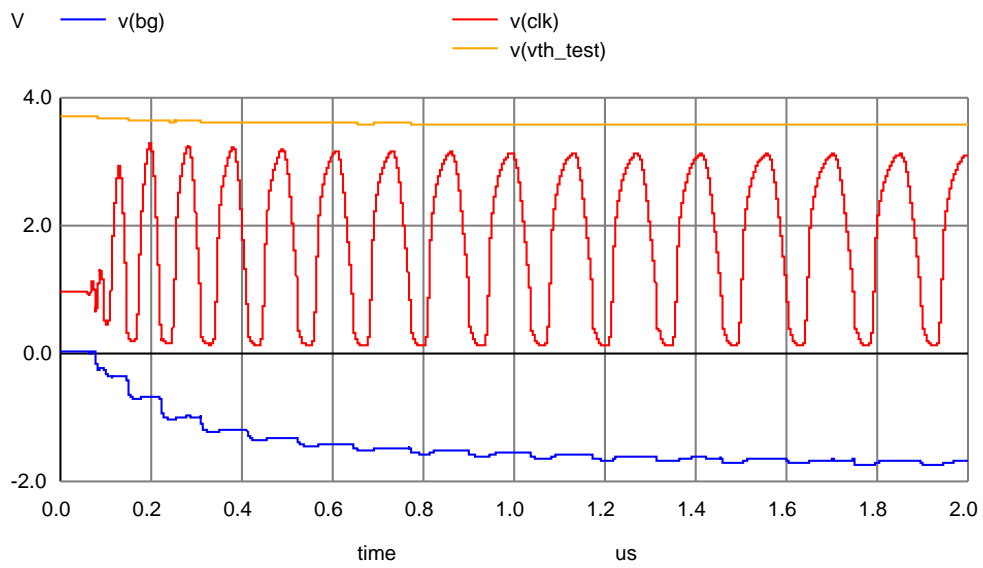

Figure 4.29: SPICE simulation of the backgate bias generator

4.11 List of Components

Table 4.1 shows the list of transistors, resistors and capacitors found on an MOS 8700R1 and their assignment to functional blocks described in this document.

Annotation	Part usage
R1..R16	Part of ESD protection for inputs I0..I15
T1..T208	ESD protection, input buffer and inverter for inputs I0..I15
R17	Part of ESD protection for OE input
T209..T213	ESD protection and input buffer for OE
T214..T1893	NOR array for product terms, only some transistors actually populated
T1894..T2301	NOR array for sum terms, only some transistors actually populated
T2302..T2453	Output stage and pad push-pull pad buffers
T2454..T2467, C1..C3	Back-gate bias generator

Table 4.1: List of components on 8700R2 chip

Chapter 5

A PLA Replacement: realPLA

The realPLA is a PLA replacement which I developed with the results of the investigations shown in this document. It was developed with the aim to work with all C64s which work with original PLAs too. It uses only parts which are still in production and available at low cost as the time of writing.

The logic functions are implemented in a Lattice LC4032V CPLD. Although it runs at 3.3 Volts, it is 5 Volt tolerant. Because of this property the CPLD inputs can be connected to the PLA inputs directly. They even have an input threshold voltage which is quite close to the one of the CSG PLAs.

The logic programmed to the CPLD has been converted from the JEDEC file converted from a 82S100 to VHDL with a small Python tool. The CASRAM equation does not fit into one macrocell of this CPLD, because it either has too many inputs or it needs to use feedback from other terms. To provide matching propagation delays for all input to output paths, all terms have been edited to use two levels of logic. A binary PLA dump has been used to execute a unit test for the logic part of this PLA implementation.

In addition to the logic functions of the PLA, also the dynamic characteristics have to be similar to the original parts, mainly propagation delay and slew rates.

It would have been possible to increase the propagation delay of the CPLD by using additional internal nodes. However, as the speed grade of the CPLD may vary and also depends on factors like temperature, this was not the way chosen. Instead an RC delay has been added for each channel, plus a Schmitt trigger to get well-defined edges again. The RC delay has been dimensioned to get an overall propagation delay as an average original PLA. Finally each output incorporates a serial resistor to limit its slew rate. The Schmitt trigger which also translates the voltage from 3.3 V to 5 V has the additional positive effect that high to low transitions are slightly more delayed than than low to high transitions, which completely inhibits any chip select overlap.

The PCB has been designed to have nearly the same size as an original DIP-28 PLA. This allows it to fit in all C64s, even if there is e.g., a heat sink attached to adjacent chips.

The design of the realPLA is licensed under Creative Commons Attribution-ShareAlike 3.0 Unported (CC BY-SA 3.0). The design files are available at <https://bitbucket.org/skoe/pla>. Figure 5.2 shows the schematic diagram of realPLA.

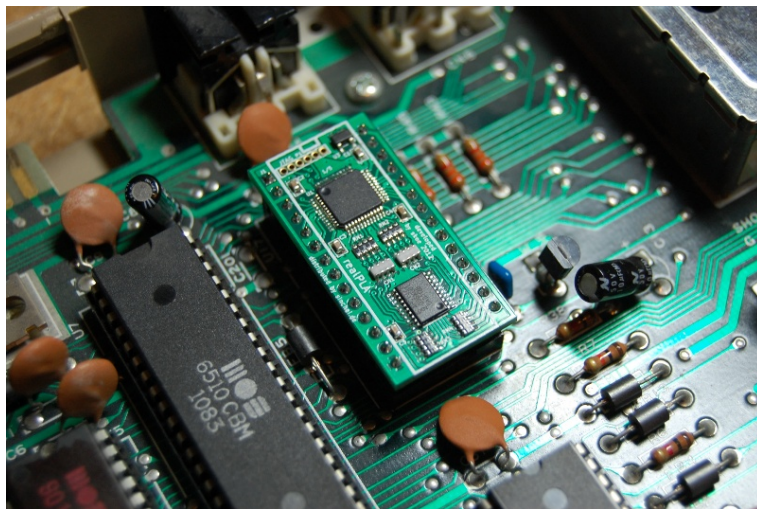

Figure 5.1: The realPLA

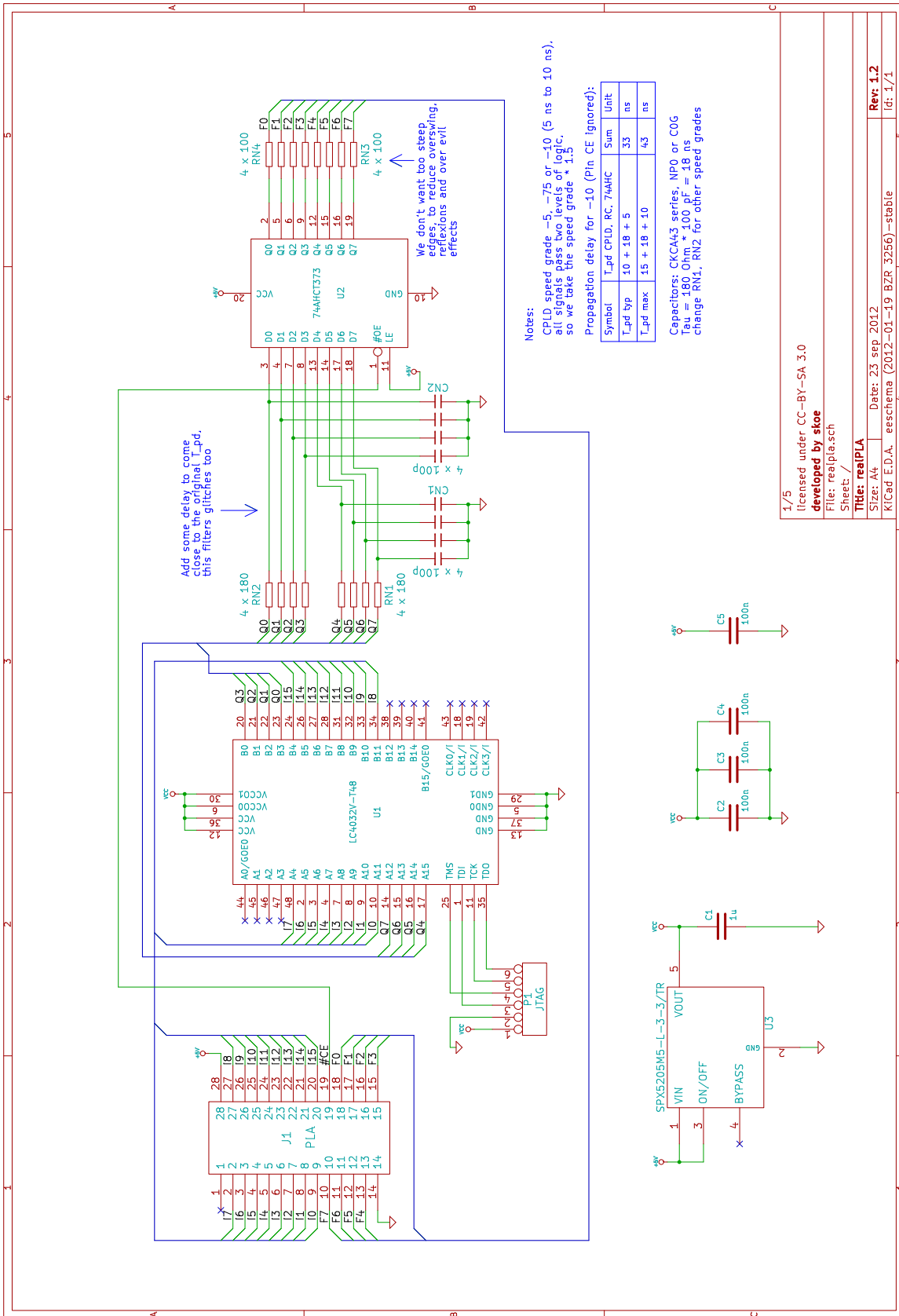

Figure 5.2: realPLA schematic diagram

Chapter 6

Conclusion

There have been numerous discussions about the PLA and its properties in the past. The reason may have been bad PLA replacements which did not work on all C64s or not with all hardware extensions. The full logic of the PLA was not officially documented by Commodore, which made it necessary to reverse engineer it to be able to implement advanced programs or hardware extensions. In contrast to the CPU, which was of interest for every assembler programmer, the PLA was only examined by a few people. This is another point which made the PLA look somewhat intransparent.

However, this document shows that there is no such obscurity and that most of its properties have been found years ago already. Others can be measured easily or can be derived from C64 schematics. The logic incorporated in the PLA is shown in different comprehensive ways. With the hardware facts presented in this document it is easy to see what the important requirements for a compatible PLA replacement are. It also helps to identify properties of PLA replacements which could make it incompatible to certain boards.

Programmable memory devices (PROMs, EPROMs) have frequently been used to replace PLAs. The idea to do this is reasonable, a PLA is a device with a programmable AND array followed from a programmable OR array, while a PROM is a device with a fixed AND array¹, and a programmable OR array. One must be aware that a PLA replacement has to comply with the requirements of a narrow timing window to work with all boards, no matter if it is made using programmable logic devices or programmable memory. Additionally, the timing printed on the chip is usually not the typical delay which counts here. Note that programmable logic devices usually have a very well defined and documented timing behavior, while PROMs may have different propagation delays for different address lines, caused by their internal geometry in rows and columns. So it is acceptable to use a PROM as PLA replacement, as long as the actual timing has been verified accurately.

The SuperPLA has been the first professional PLA replacement. It is known to work on nearly all boards. Yet, it happens to fail on a few C64 boards with a *KU* serial number. This board revision is infamous for its fragile timing. Reasons for the failures are hard to identify. It may be caused by the not fully authentic timing or by the fast slew rates which even caused undershoots in the measurements.

The EPROM PLA replacement M27C512-90B6 is one of the simplest PLA replacements. Recalling the bad experience some people had with the compatibility of other EPROM PLA replacements it was highly controversial. However, the sample tested in this document made a good impression. The only negative point seen was the slightly too fast propagation delay, which is most likely the reason that it also failed with a few *KU* boards.

¹The address decoder

The prototypes of the realPLA have been tested on about 20 C64 boards of different board revisions, including KU boards. The compatibility of the realPLA with different C64 expansions has been checked, for example EasyFlash 3 and Turbo Chameleon. The realPLA worked on all of these boards. However, there can never be a guarantee that a PLA or PLA replacement works on absolutely every board with any extension ever designed. The different lots and revisions of C64 computers with different VIC-II chips have different timing requirements, which was also known to Commodore: They defined different RC delays for different combinations.

The chapter which describes the reverse engineering and inner workings of a CSG PLA may be of less practical interest. It is more focused on understanding how this part was developed and how it works, for educational and historical purposes.

Hopefully this document can help other hardware projects, emulators and programmers to improve and prolong the experience with the definitely best computer of the world ;)

Appendix A

C64 Memory Configurations Explained

The Commodore 64 memory configurations are explained in various books and other documents. Some of these tables are incomplete or even flawed.

For the sake of completeness of an C64 PLA article they are listed here once more. All tables have been generated directly from the JEDEC file read out from a 82S100 PLA, so it is very unlikely that there are mistakes in them.

There is a mechanism implemented in the PLA logic which is not shown in the tables below. Section 2.4 explains how the VIC-II can halt the CPU when it wants to take over the bus. If write accesses by the CPU address the I/O area during this phase, the PLA selects the I/O chips accordingly. But to make sure that the (dummy) read cycles in this phase will never accidentally acknowledge an interrupt, the PLA redirects them to RAM. The signals BA and R/#W are used to identify this situation.

Jens Schönfeld's PLA analyzer is useful to explore the C64 memory maps interactively. It can be downloaded at http://icomp.de/products/SuperPLA/pla_analyzer.zip. It runs in a DOS box, also in the DOS emulator *dosbox* under Linux.

CPU Memory Configuration

#LORAM, #HIRAM, #GAME, #EXROM = 1111

Table A.1 shows the standard memory configuration (\$01 = #\$37). No cartridge is attached. BASIC, I/O and KERNAL are visible to the CPU. With #CHAREN = 0 (\$01 = #\$33), CHARROM (read) and RAM (write) are mapped instead of I/O.

Address	#CHAREN 1		#CHAREN 0	
	CPU R	CPU W	CPU R	CPU W
\$0000	ram	ram	ram	ram
\$1000	ram	ram	ram	ram
\$2000	ram	ram	ram	ram
\$3000	ram	ram	ram	ram
\$4000	ram	ram	ram	ram
\$5000	ram	ram	ram	ram
\$6000	ram	ram	ram	ram
\$7000	ram	ram	ram	ram
\$8000	ram	ram	ram	ram
\$9000	ram	ram	ram	ram
\$A000	BASIC	ram	BASIC	ram
\$B000	BASIC	ram	BASIC	ram
\$C000	ram	ram	ram	ram
\$D000	I/O	I/O	CHARROM	ram
\$E000	KERNAL	ram	KERNAL	ram
\$F000	KERNAL	ram	KERNAL	ram

Table A.1: C64 memory configurations with LHGX = 1111

#LORAM, #HIRAM, #GAME, #EXROM = 011x

Table A.2 shows the configuration with BASIC banked out (\$01 = #\$36). If an 8k cartridge is attached, it is also banked out. I/O and KERNAL are visible to the CPU. With #CHAREN = 0 (\$01 = #\$32), CHARROM (read) and RAM (write) are mapped instead of I/O.

Address	#CHAREN 1		#CHAREN 0	
	CPU R	CPU W	CPU R	CPU W
\$0000	ram	ram	ram	ram
\$1000	ram	ram	ram	ram
\$2000	ram	ram	ram	ram
\$3000	ram	ram	ram	ram
\$4000	ram	ram	ram	ram
\$5000	ram	ram	ram	ram
\$6000	ram	ram	ram	ram
\$7000	ram	ram	ram	ram
\$8000	ram	ram	ram	ram
\$9000	ram	ram	ram	ram
\$A000	ram	ram	ram	ram
\$B000	ram	ram	ram	ram
\$C000	ram	ram	ram	ram
\$D000	I/O	I/O	CHARROM	ram
\$E000	KERNAL	ram	KERNAL	ram
\$F000	KERNAL	ram	KERNAL	ram

Table A.2: C64 memory configurations with LHGX = 011x

#LORAM, #HIRAM, #GAME, #EXROM = 1000

Table A.3 shows the configuration with a 16k cartridge attached but banked out (\$01 = #\$35). I/O is visible to the CPU. #CHAREN = 0 (\$01 = \$31) can be used to hide the I/O space, but it does not bank in CHARROM.

Address	#CHAREN 1		#CHAREN 0	
	CPU R	CPU W	CPU R	CPU W
\$0000	ram	ram	ram	ram
\$1000	ram	ram	ram	ram
\$2000	ram	ram	ram	ram
\$3000	ram	ram	ram	ram
\$4000	ram	ram	ram	ram
\$5000	ram	ram	ram	ram
\$6000	ram	ram	ram	ram
\$7000	ram	ram	ram	ram
\$8000	ram	ram	ram	ram
\$9000	ram	ram	ram	ram
\$A000	ram	ram	ram	ram
\$B000	ram	ram	ram	ram
\$C000	ram	ram	ram	ram
\$D000	I/O	I/O	ram	ram
\$E000	ram	ram	ram	ram
\$F000	ram	ram	ram	ram

Table A.3: C64 memory configurations with LHGX = 1000

#LORAM, #HIRAM, #GAME, #EXROM = 101x

Table A.4 shows the configuration with BASIC and KERNAL banked out (\$01 = #\$35). If an 8k cartridge is attached, it is also banked out. I/O is visible to the CPU. With #CHAREN = 0 (\$01 = #\$32), CHARROM (read) and RAM (write) are mapped instead of I/O.

Address	#CHAREN 1		#CHAREN 0	
	CPU R	CPU W	CPU R	CPU W
\$0000	ram	ram	ram	ram
\$1000	ram	ram	ram	ram
\$2000	ram	ram	ram	ram
\$3000	ram	ram	ram	ram
\$4000	ram	ram	ram	ram
\$5000	ram	ram	ram	ram
\$6000	ram	ram	ram	ram
\$7000	ram	ram	ram	ram
\$8000	ram	ram	ram	ram
\$9000	ram	ram	ram	ram
\$A000	ram	ram	ram	ram
\$B000	ram	ram	ram	ram
\$C000	ram	ram	ram	ram
\$D000	I/O	I/O	CHARROM	ram
\$E000	ram	ram	ram	ram
\$F000	ram	ram	ram	ram

Table A.4: C64 memory configurations with LHGX = 101x

#LORAM, #HIRAM, #GAME, #EXROM = 001x or 00x0

The configurations shown in table A.5 have everything banked out (\$01 = #\$34 or \$01 = #\$30). No cartridge, an 8k or an 16k cartridge is attached. Only RAM is visible to the CPU. #CHAREN has no effect in this case.

Address	CPU R	CPU W
\$0000	ram	ram
\$1000	ram	ram
\$2000	ram	ram
\$3000	ram	ram
\$4000	ram	ram
\$5000	ram	ram
\$6000	ram	ram
\$7000	ram	ram
\$8000	ram	ram
\$9000	ram	ram
\$A000	ram	ram
\$B000	ram	ram
\$C000	ram	ram
\$D000	ram	ram
\$E000	ram	ram
\$F000	ram	ram

Table A.5: C64 memory configurations with LHGX = 001x or 00x0

#LORAM, #HIRAM, #GAME, #EXROM = 1100

Table A.6 shows the standard 16k cartridge configuration (\$01 = #\$37). A 16k cartridge is attached. ROML/ROMH, I/O and KERNAL are visible to the CPU. With #CHAREN = 0 (\$01 = #\$33), CHARROM (read) and RAM (write) are mapped instead of I/O.

Address	#CHAREN 1		#CHAREN 0	
	CPU R	CPU W	CPU R	CPU W
\$0000	ram	ram	ram	ram
\$1000	ram	ram	ram	ram
\$2000	ram	ram	ram	ram
\$3000	ram	ram	ram	ram
\$4000	ram	ram	ram	ram
\$5000	ram	ram	ram	ram
\$6000	ram	ram	ram	ram
\$7000	ram	ram	ram	ram
\$8000	ROML	ram	ROML	ram
\$9000	ROML	ram	ROML	ram
\$A000	ROMH	ram	ROMH	ram
\$B000	ROMH	ram	ROMH	ram
\$C000	ram	ram	ram	ram
\$D000	I/O	I/O	CHARROM	ram
\$E000	KERNAL	ram	KERNAL	ram
\$F000	KERNAL	ram	KERNAL	ram

Table A.6: C64 memory configurations with LHGX = 1100

#LORAM, #HIRAM, #GAME, #EXROM = 0100

The 16k cartridge configuration with ROML banked out (\$01 = #\$36) is shown in table A.7. A 16k cartridge is attached. ROMH, I/O and KERNAL are visible to the CPU. With #CHAREN = 0 (\$01 = #\$32), CHARROM (read) and RAM (write) are mapped instead of I/O.

Address	#CHAREN 1		#CHAREN 0	
	CPU R	CPU W	CPU R	CPU W
\$0000	ram	ram	ram	ram
\$1000	ram	ram	ram	ram
\$2000	ram	ram	ram	ram
\$3000	ram	ram	ram	ram
\$4000	ram	ram	ram	ram
\$5000	ram	ram	ram	ram
\$6000	ram	ram	ram	ram
\$7000	ram	ram	ram	ram
\$8000	ram	ram	ram	ram
\$9000	ram	ram	ram	ram
\$A000	ROMH	ram	ROMH	ram
\$B000	ROMH	ram	ROMH	ram
\$C000	ram	ram	ram	ram
\$D000	I/O	I/O	CHARROM	ram
\$E000	KERNAL	ram	KERNAL	ram
\$F000	KERNAL	ram	KERNAL	ram

Table A.7: C64 memory configurations with LHGX = 0100

#LORAM, #HIRAM, #GAME, #EXROM = 1110

Table A.8 shows the standard 8k cartridge configuration (\$01 = #\$37). An 8k cartridge is attached. ROML, BASIC, I/O and KERNAL are visible to the CPU. With #CHAREN = 0 (\$01 = #\$33), CHARROM (read) and RAM (write) are mapped instead of I/O.

Address	#CHAREN 1		#CHAREN 0	
	CPU R	CPU W	CPU R	CPU W
\$0000	ram	ram	ram	ram
\$1000	ram	ram	ram	ram
\$2000	ram	ram	ram	ram
\$3000	ram	ram	ram	ram
\$4000	ram	ram	ram	ram
\$5000	ram	ram	ram	ram
\$6000	ram	ram	ram	ram
\$7000	ram	ram	ram	ram
\$8000	ROML	ram	ROML	ram
\$9000	ROML	ram	ROML	ram
\$A000	BASIC	ram	BASIC	ram
\$B000	BASIC	ram	BASIC	ram
\$C000	ram	ram	ram	ram
\$D000	I/O	I/O	CHARROM	ram
\$E000	KERNAL	ram	KERNAL	ram
\$F000	KERNAL	ram	KERNAL	ram

Table A.8: C64 memory configurations with LHGX = 1110

#LORAM, #HIRAM, #GAME, #EXROM = xx01

The Ultimex configuration is shown in table A.9. An Ultimex cartridge is attached. Only 4k RAM, ROML, I/O and ROMH are visible to the CPU. Note that ROMH is mapped to \$E000. Memory areas marked with "-" are not mapped, i.e. read accesses to these areas result in values depending on the current state of the floating data bus. Write accesses to ROML or ROMH address space are forwarded to the cartridge, they have no effect on usual ROM based cartridges. \$01 does not change the memory configuration in this mode.

Address	CPU R	CPU W
\$0000	ram	ram
\$1000	-	-
\$2000	-	-
\$3000	-	-
\$4000	-	-
\$5000	-	-
\$6000	-	-
\$7000	-	-
\$8000	ROML	ROML
\$9000	ROML	ROML
\$A000	-	-
\$B000	-	-
\$C000	-	-
\$D000	I/O	I/O
\$E000	ROMH	ROMH
\$F000	ROMH	ROMH

Table A.9: C64 memory configurations with LHGX = xx01

VIC-II Memory Configuration

The VIC-II is able to address 16 kByte of memory, which requires 14 address bits. The C64 has 64 kByte of DRAM, there are 4 VIC-II banks possible in this memory space.

The two CIA lines #VA14 and #VA15 are used to map one of these four RAM areas to the VIC-II address space. They do not appear in the address column of the tables below, because they are no address lines controlled by the VIC-II.

#VA14 is used by the PLA to decide whether CHARROM has to be visible.

#GAME, #EXROM = 1x or 00

Table A.10 shows the memory map as seen by the VIC-II when not being in Ultimex mode.

VIC Addr	#VA14 = 0 VIC R	#VA14 = 1 VIC R
\$0000	ram	ram
\$1000	ram	CHARROM
\$2000	ram	ram
\$3000	ram	ram

Table A.10: VIC-II memory configurations with GX = 1x or 00

#GAME, #EXROM = 01

Table A.11 shows the memory map as seen by the VIC-II in Ultimix mode. The address lines A12 to A15 of the C64 address bus are pulled up by RP4 whenever the VIC-II has the bus, so they are %1111 usually.

Table A.12 shows an example where the address lines A12 to A15 are overridden to %0111 by an external cartridge. This shows that a cartridge can hide any internal memory from the VIC-II and provide data for it on the Expansion Port. This technique is used in the Turbo Chameleon by Individual Computers. Note that the internal color RAM is still read as usual.

VIC Addr	VIC R
\$0000	ram
\$1000	ram
\$2000	ram
\$3000	ROMH

Table A.11: VIC-II memory configuration with GX = 01

VIC Addr	VIC R
\$0000	-
\$1000	-
\$2000	-
\$3000	ROMH

Table A.12: VIC-II memory configuration with GX = 01, modified address bus

Bibliography

- [AC12] <http://www.arcadecomponents.com/downloads.html>.
- [Boess12] Mail by Segher Boessenkool to cbm-hackers mailing list, 2012, <http://www.softwolves.com/arkiv/cbm-hackers/17/17308.html>.
- [CHM09] Computer History Museum, 2009, *Signetics FPLF Oral History Panel*, http://archive.computerhistory.org/resources/access/text/Oral_History/102702200%20.05.01.acc.pdf
- [esl11] *eslapion*, 2011, posts in forum thread *The end of the ROM based PLA for the 64*, <http://sleepingelephant.com/ipw-web/bulletin/bb/viewtopic.php?t=5533>.
- [Fc77] Fairchild, 1977, part of *Fairchild Semiconductor - Full Line Condensed Catalogue 1977*, <http://www.datasheetarchive.com/93459-datasheet.html>.
- [Hita2114] Hitachi Semiconductor, datasheet *HM472114-3[...] 1024-word x 4-Bit Static Random Access Memory* <http://www.datasheetarchive.com/HM472114-3-datasheet.html>.
- [Hita4846] Hitachi Semiconductor, datasheet *HM4864A[...] 65536-word x 1-Bit Dynamic RAM* <http://www.datasheetarchive.com/HM4864AP-20-datasheet.html>
- [Hoffmann06] Kurt Hoffmann, 2006, *Systemintegration: Vom Transistor zur großintegrierten Schaltung*, Oldenbourg Wissenschaftsverlag.
- [Lev86] William Levak and Ann Arbor, 1986, Commodore 64 Memory Configurations, *The Transactor*, Volume 6, Issue 05, p. 51-55.
- [Mach110] AMD/Lattice, 1995, datasheet, *MACH110-12/15/20 High-Density EE CMOS Programmable Logic* <http://www.latticesemi.com/lit/docs/datasheets/cpld/14127.pdf>.
- [Maini07] Anil K. Maini, 2007, *Digital Electronics: Principles, Devices and Applications*, John Wiley & Sons.
- [Mead79] Carver Mead, Lynn Conway, 1979, *Introduction to VLSI Systems*, Addison Wesley, pre-publication drafts available at <http://ai.eecs.umich.edu/people/conway/VLSI/VLSIText/VLSIText.html>.
- [PLA95] <http://www.zimmers.net/anonftp/pub/cbm/firmware/computers/c64/pla.txt>.
- [PLS100] Phillips Semiconductors, 1993, product specification *Programmable logic arrays (16 x 48 x 8) PLS100/PLS101* <http://www.datasheetcatalog.org/datasheet/philips/PLS101A.pdf>.

- [PRG83] Commodore Computers, 1983, *Commodore 64 Programmer's Reference Guide*, Financial Times Prentice Hall.
- [Raj08] A. Albert Raj, T. Latha, 2008, *VLSI Design*, PHI Learning.
- [realPLA12] <https://bitbucket.org/skoe/realpla>.
- [Sem08] Oleg Semenov, Hossein Sarbishaei, Manoj Sachdev, 2008, *ESD Protection Device and Circuit Design for Advanced CMOS Technologies*, Springer.
- [Serv85] Commodore Business Machines, Inc., 1985, *Service Manual Model C64 Computer*, schematic #251138 at <http://www.zimmers.net/anonftp/pub/cbm/schematics/computers/c64/251138-1of2.gif> <http://www.zimmers.net/anonftp/pub/cbm/schematics/computers/c64/251138-2of2.gif>
- [Si75] Signetics, 1975, part of *Mos and Bipolar ROM / PROM 1975* <http://www.datasheetarchive.com/82S100-datasheet.html>.
- [TI257] Texas Instruments, 1976, revised 1988, datasheet *SN74LS257B [...] Quadruple 2-line to 1-line data selectors/multiplexers*, <http://www.ti.com/lit/gpn/sn74ls257b>.