

MEGA 65

USER'S GUIDE



MUSEUM OF ELECTRONIC GAMES & ART

MEGA65 TEAM

Dr. Paul Gardner-Stephen

(highlander)

Founder

Software and Virtual Hardware Architect

Spokesman and Lead Scientist

Martin Streit

(seriously)

Video and Photo Production

Tax and Organization

Social Media

Falk Rehwagen

(bluewaysw)

Jenkins Build Automation

GEOS, Hardware Quality Management

Dieter Penner

(doubleflash)

Host Hardware Review and Testing

File Hosting

Gábor Lénárt

(LGB)

Emulator

Farai Aschwanden

(Tayger)

File Base, Tools

Financial Advisory

Andrew Owen

(Cheveron)

Keyboard Advisory, Sinclair Support

Roman Standzikowski

(FeralChild)

Open Roms

Detlef Hastik

(deft)

Co-Founder

General Manager

Marketing & Sales

Anton Schneider-Michallek

(adtbm)

Hardware Pool Management

Soft-, Hard- and V-Hardware Testing

Forum Administration

Antti Lukats

(antti-brain)

Host Hardware Design and Production

Dr. Edilbert Kirk

(Bit Shifter)

Manual and Tools

ROM Enhancements

Mirko H.

(sy2002)

Additional Hardware and Platforms

Thomas Hertzler

(grumpyinja)

USA Spokesman

Artist Relations

Daniel England

(Mew Pokémon)

Additional Code and Tools

Hernán Di Pietro

(indiocolifa)

Additional Emulation

Reporting Errors and Omissions

This book is a work-in-progress produced by and for the MEGA65 community. The version of this edition is:

```
commit 6fb0c1661a71a238bf754e177a7c2a5354a2f577
date: Fri Oct 15 23:00:16 2021 +1100
```

We want this book to be the best that it possibly can. So if you see any errors, or find anything that is missing, or that you would like more information on, please report them using the MEGA65 User's Guide issue tracker:

<https://github.com/mega65/mega65-user-guide/issues>

You can also check there to see if anyone else has reported a similar problem, while you wait for this book to be updated.

Finally, you can always download the latest version of this book from:

<https://github.com/mega65/mega65-user-guide>

MEGA65 REFERENCE GUIDE

Published by
the MEGA Museum of Electronic Games & Art e.V., Germany.

WORK IN PROGRESS

Copyright ©2019 - 2021 by Paul Gardner-Stephen, the MEGA Museum of Electronic Games & Art e.V., and contributors.

This reference guide is made available under the GNU Free Documentation License v1.3, or later, if desired. This means that you are free to modify, reproduce and redistribute this reference guide, subject to certain conditions. The full text of the GNU Free Documentation License v1.3 can be found at <https://www.gnu.org/licenses/fdl-1.3.en.html>.

Implicit in this copyright license, is the permission to duplicate and/or redistribute this document in whole or in part for use in education environments. We want to support the education of future generations, so if you have any worries or concerns, please contact us.

October 15, 2021

Contents

I	PREFACE	xxxiii
1	Introduction	xxxv
	Welcome to the MEGA65!	xxxvii
	Other Books in this series	xxxviii
II	GETTING TO KNOW YOUR MEGA65	1-1
2	Setup	2-1
	Unpacking and connecting the MEGA65	2-3
	Rear Connections	2-4
	Side Connections	2-5
	MEGA65 screen and peripherals	2-6
	Optional Connections	2-7
	Operation	2-7
	Using the MEGA65	2-7
	THE CURSOR	2-8
3	Getting Started	3-1
	Keyboard	3-3

Command Keys	3-3
RETURN	3-3
SHIFT	3-3
SHIFT LOCK	3-3
CTRL	3-4
RUN STOP	3-4
RESTORE	3-4
THE CURSOR KEYS	3-5
INSeR/DELeTe	3-5
CLeaR/HOME	3-5
MEGA KEY	3-5
NO SCROLL	3-6
Function Keys	3-6
HELP	3-6
ALT	3-6
CAPS LOCK	3-6
The Screen Editor	3-7
Editor Functionality	3-9
4 Configuring your MEGA65	4-1
Important Note	4-3
Formatting SD cards	4-3
Installing ROM and Other Support Files	4-6
ROM File	4-7
Support Files	4-8
On-boarding	4-9
Configuration Utility	4-11
Input Devices	4-15
Chipset	4-16

Video	4-17
Audio	4-17
Network	4-18
5 Cores and Flashing	5-1
What are cores, and why do they matter?	5-3
Model types	5-3
Bitstream files	5-4
File types	5-4
Where to download	5-4
Selecting a core	5-5
Installing an upgrade core for the MEGA65	5-7
Installing other cores	5-9
Creating cores for the MEGA65	5-9
Replacing the factory core in slot 0	5-10
Understanding The Core Booting Process	5-10
6 Floppy Disks And D81 Images	6-1
Terminology	6-3
The Freezer	6-4
III FIRST STEPS IN CODING	6-7
7 How Computers Work	7-1
Computers are stupid. Really stupid	7-3
Making an Egg Cup Computer	7-3
8 Getting Started in BASIC	8-1
Your first BASIC programs	8-3
Exercises to try	8-12

First steps with text and numbers	8-13
Exercises to try	8-29
Making simple decisions	8-30
Exercises to try	8-43
Random numbers and chance	8-44
Exercises to try	8-48
9 Text Processing	9-1
Characters and Strings	9-3
String Literals	9-5
String Variables	9-5
String Statements	9-7
Simple Formatting	9-8
Suppressing New Lines	9-8
Automatic Tab Stops	9-8
Tabs Stops and Spacing	9-9
Sample Programs	9-9
Palindromes	9-9
Simple Ciphers	9-9
10 C64, C65 and MEGA65 Modes	10-1
Switching Modes from BASIC	10-3
From MEGA65/C65 to C64-mode	10-3
From C64 to MEGA65/C65-mode	10-4
Entering Machine Code Monitor Mode	10-4
The KEY Register	10-4
Exposing Extra C65 Registers	10-5
Disabling the C65/MEGA65 Extra Registers	10-6
Enabling MEGA65 Extra Registers	10-6

Traps to look out for	10-7
Accessing Memory from BASIC 65	10-7
The MAP Instruction	10-8
IV SOUND AND GRAPHICS	10-9
11 Graphics	11-1
V HARDWARE	11-9
12 Using Nexys4 boards as a MEGA65	12-1
Building your own MEGA65 Compatible Computer	12-3
Working Nexys4 Boards	12-4
The Nexys4 board	12-4
The Nexys4DDR board	12-4
The Nexys A7	12-5
Power, Jumpers, Switches and Buttons	12-6
Micro-USB Power	12-7
External Power Supply	12-7
Other Jumpers and Switches	12-8
Connections and Peripherals	12-9
Communicating with your PC	12-9
Onboard buttons	12-10
Keyboard	12-11
Some key mappings with a USB keyboard	12-12
Preparing microSDHC card	12-13
Preparation Steps	12-13
Loading the bitstream from QSPI	12-15
Preparation Steps	12-15

Useful Tips	12-15
-----------------------	-------

VI CROSS-PLATFORM DEVELOPMENT TOOLS 12-17

13 Emulators 13-1

Using The Xmega65 Emulator	13-3
Using the Live ISO image	13-3
Creating a Bootable USB stick or DVD	13-3
Getting Started	13-4
Other Features of the Live ISO	13-5

14 Data Transfer and Debugging Tools 14-1

m65 command line tool	14-3
Screenshots using m65 tool	14-3
Load and run a program on the MEGA65	14-4
Reconfigure the FPGA to run a different bitstream	14-4
Remote keyboard entry	14-4
Unit testing and logging support	14-5
Using unit tests with C	14-5
Using unit tests with BASIC 65	14-6
BASIC 65 example	14-7
M65Connect	14-8
mega65_ftp	14-9
TFTP Server	14-10
Converting a BASIC text file listing into a PRG file	14-10

15 Assemblers 15-1

16 C and C-Like Compilers 16-1

MEGA65 libc	16-3
-----------------------	------

Structure and Usage 17-3

conio.h 17-3

 conionit 17-3

 setscreenaddr 17-3

 getscreenaddr 17-4

 setcolramoffset 17-4

 getcolramoffset 17-4

 setcharsetaddr 17-4

 getcharsetaddr 17-5

 clrscr 17-5

 getscreensize 17-5

 setscreensize 17-5

 set16bitcharmode 17-6

 sethotregs 17-6

 setextendedattrib 17-6

 togglecase 17-6

 bordercolor 17-6

 bgcolor 17-7

 textcolor 17-7

 revers 17-7

 highlight 17-7

 blink 17-8

 underline 17-8

 altpal 17-8

 clearattr 17-8

 cellcolor 17-8

 setpalbank 17-9

setpalbanka	17-9
getpalbank	17-9
getpalbanka	17-9
setmapedpal	17-10
getmapedpal	17-10
setpalentry	17-10
fillrect	17-10
box	17-11
hline	17-11
vline	17-12
gohome	17-12
gotoxy	17-12
gotox	17-12
gotoy	17-13
moveup	17-13
movedown	17-13
moveleft	17-13
moveright	17-14
wherex	17-14
wherey	17-14
cputc	17-14
cputnc	17-14
cputhex	17-15
cputdec	17-15
cputs	17-15
cputsxy	17-16
cputcxy	17-16
cputncxy	17-16

cprintf	17-17
cgetc	17-17
kbhit	17-18
getkeymodstate	17-18
flushkeybuf	17-18
cinput	17-18
VIC_BASE	17-19

18 BASIC Tokenisers **18-1**

VII APPENDICES **18-5**

A Accessories **A-1**

B BASIC 65 Command Reference **B-1**

Commands, Functions and Operators	B-3
BASIC 65 constants	B-5
BASIC 65 variables	B-5
BASIC 65 arrays	B-5
Keywords And Tokens Part 1	B-7
Keywords And Tokens Part 2	B-8
Tokens And Keywords Part 1	B-9
Tokens And Keywords Part 2	B-10
BASIC command reference	B-11
ABS	B-12
AND	B-13
APPEND	B-14
ASC	B-15
ATN	B-16

AUTO	B-17
BACKGROUND	B-18
BACKUP	B-19
BANK	B-20
BEGIN	B-21
BEND	B-22
BLOAD	B-23
BOOT	B-25
BORDER	B-26
BOX	B-27
BSAVE	B-29
BUMP	B-31
BVERIFY	B-32
CATALOG	B-33
CHANGE	B-35
CHAR	B-36
CHR\$	B-38
CIRCLE	B-39
CLOSE	B-41
CLR	B-42
CMD	B-43
COLLECT	B-44
COLLISION	B-45
COLOR	B-46
CONCAT	B-47
CONT	B-48
COPY	B-49
COS	B-51

CURSOR	B-52
DATA	B-53
DCLEAR	B-54
DCLOSE	B-55
DEC	B-56
DEF FN	B-57
DELETE	B-58
DIM	B-59
DIR	B-60
DISK	B-61
DLOAD	B-62
DMA	B-63
DMODE	B-64
DO	B-65
DOPEN	B-66
DPAT	B-68
DS	B-69
DS\$	B-70
DSAVE	B-71
DT\$	B-72
DVERIFY	B-73
EDIT	B-74
EDMA	B-76
EL	B-77
ELLIPSE	B-78
ELSE	B-80
END	B-81
ENVELOPE	B-82

ERASE	B-83
ER	B-84
ERR\$	B-85
EXIT	B-86
EXP	B-87
FAST	B-88
FILTER	B-89
FIND	B-90
FN	B-91
FONT	B-92
FOR	B-93
FOREGROUND	B-94
FRE	B-95
FREAD	B-96
FWRITE	B-97
GET	B-98
GET#	B-99
GETKEY	B-100
GO64	B-101
GOSUB	B-102
GOTO	B-103
GRAPHIC	B-104
HEADER	B-105
HELP	B-106
HEX\$	B-107
HIGHLIGHT	B-108
IF	B-109
INPUT	B-110

INPUT#	B-111
INSTR	B-113
INT	B-114
JOY	B-115
KEY	B-116
LEFT\$	B-118
LEN	B-119
LET	B-120
LINE	B-121
LINE INPUT#	B-122
LIST	B-123
LOAD	B-124
LOADIFF	B-126
LOG	B-128
LOG10	B-129
LOOP	B-130
LPEN	B-131
MERGE	B-132
MID\$	B-133
MOD	B-134
MONITOR	B-135
MOUSE	B-136
MOVSPR	B-137
NEW	B-139
NEXT	B-140
NOT	B-141
OFF	B-142
ON	B-143

OPEN	B-145
OR	B-146
PAINT	B-147
PALETTE	B-148
PEEK	B-149
PEEKW	B-150
PEN	B-151
PIXEL	B-152
PLAY	B-153
POINTER	B-156
POKE	B-157
POKEW	B-158
POLYGON	B-159
POS	B-160
POT	B-161
PRINT	B-162
PRINT#	B-163
PRINT USING	B-164
RCOLOR	B-166
RCURSOR	B-167
READ	B-168
RECORD	B-169
REM	B-171
RENAME	B-172
RENUMBER	B-173
RESTORE	B-174
RESUME	B-175
RETURN	B-176

RGRAPHIC	B-177
RIGHT\$	B-178
RMOUSE	B-179
RND	B-180
RPALETTE	B-181
RPEN	B-182
RPLAY	B-183
RREG	B-184
RSPCOLOR	B-185
RSPEED	B-186
RSPPOS	B-187
RSPRITE	B-188
RUN	B-189
RWINDOW	B-190
SAVE	B-191
SCNCLR	B-192
SCRATCH	B-193
SCREEN	B-194
SET	B-197
SGN	B-198
SIN	B-199
SLEEP	B-200
SOUND	B-201
SPC	B-202
SPEED	B-203
SPRCOLOR	B-204
SPRITE	B-205
SPRSAV	B-206

SQR	B-207
ST	B-208
STEP	B-209
STOP	B-210
STR\$	B-211
SYS	B-212
TAB	B-214
TAN	B-215
TEMPO	B-216
THEN	B-217
TI	B-218
TI\$	B-219
TO	B-220
TRAP	B-221
TROFF	B-222
TRON	B-223
TYPE	B-224
UNTIL	B-225
USING	B-226
USR	B-228
VAL	B-229
VERIFY	B-230
VIEWPORT	B-231
VOL	B-232
WAIT	B-233
WHILE	B-234
WINDOW	B-235
XOR	B-236

C	Special Keyboard Controls and Sequences	C-1
	PETSCII Codes and CHR\$	C-3
	Control codes	C-5
	Shifted codes	C-8
	Escape Sequences	C-8
D	The MEGA65 Keyboard	D-1
	Hardware Accelerated Keyboard Scanning	D-3
	Latin-1 Keyboard Map	D-4
	Keyboard Theory of Operation	D-4
	C65 Keyboard Matrix	D-4
	Synthetic Key Events	D-5
	Keyboard LED Control	D-6
	Native Keyboard Matrix	D-7
E	Decimal, Binary and Hexadecimal	E-1
	Numbers	E-3
	Notations and Bases	E-4
	Decimal	E-6
	Binary	E-7
	Hexadecimal	E-9
	Operations	E-11
	Counting	E-11
	Arithmetic	E-13
	Logic Gates	E-15
	Signed and Unsigned Numbers	E-17
	Bit-wise Logical Operators	E-18
	Converting Numbers	E-20

F	System Memory Map	F-1
	Introduction	F-3
	MEGA65 Native Memory Map	F-4
	The First Sixteen 64KB Banks	F-4
	Colour RAM	F-5
	28-bit Address Space	F-6
	\$D000 - \$DFFF I/O Personalities	F-8
	CPU Memory Banking	F-10
	C64/C65 ROM Emulation	F-11
	C65 Compatibility ROM Layout	F-12
G	45GS02 Microprocessor	G-1
	Introduction	G-3
	Differences to the 6502	G-3
	Supervisor/Hypervisor Privileged Mode	G-3
	6502 Illegal Opcodes	G-4
	Read-Modify-Write Instruction Bug Compatibility	G-4
	Variable CPU Speed	G-5
	Slow (1MHz - 3.5MHz) Operation	G-5
	Full Speed (40MHz) Instruction Timing	G-6
	CPU Speed Fine-Tuning	G-6
	Direct Memory Access (DMA)	G-6
	Accessing memory between the 64KB and 1MB points	G-6
	C64-Style Memory Banking	G-7
	VIC-III "ROM" Banking	G-7
	VIC-III Display Address Translator	G-8
	The MAP instruction	G-8
	Direct Memory Access (DMA) Controller	G-10
	Flat Memory Access	G-10

Accessing memory beyond the 1MB point	G-11
Using the MAP instruction to access >1MB	G-11
Flat-Memory Access	G-13
Virtual 32-bit Register	G-14
C64 CPU Memory Mapped Registers	G-16
New CPU Memory Mapped Registers	G-17
MEGA65 CPU Maths Acceleration Registers	G-21
MEGA65 Hypervisor Mode	G-29
Reset	G-29
Entering / Exiting Hypervisor Mode	G-29
Hypervisor Memory Layout	G-30
Hypervisor Virtualisation Control Registers	G-33
Programming for Hypervisor Mode	G-36

H 45GS02 & 6502 Instruction Sets H-1

Addressing Modes	H-3
Implied	H-3
Accumulator	H-3
Q Pseudo Register	H-4
Immediate Mode	H-4
Immediate Word Mode	H-4
Base Page (Zero-Page) Mode	H-5
Base Page (Zero-Page) Quad Mode	H-5
Base Page (Zero-Page) X Indexed Mode	H-5
Base Page (Zero-Page) Quad X Indexed Mode	H-6
Base Page (Zero-Page) Y Indexed Mode	H-6
Base Page (Zero-Page) Base Y Indexed Mode	H-6
Base Page (Zero-Page) Z Indexed Mode	H-6
Base Page (Zero-Page) Quad Z Indexed Mode	H-7

Absolute Mode	H-7
Absolute Quad Mode	H-7
Absolute X Indexed Mode	H-7
Absolute Quad X Indexed Mode	H-8
Absolute Y Indexed Mode	H-8
Absolute Quad Y Indexed Mode	H-8
Absolute Z Indexed Mode	H-8
Absolute Quad Z Indexed Mode	H-8
Absolute Indirect Mode	H-9
Absolute Indirect X-Indexed Mode	H-9
Base Page Indirect X-Indexed Mode	H-9
Base Page Quad Indirect X-Indexed Mode	H-9
Base Page Indirect Y-Indexed Mode	H-10
Base Page Quad Indirect Y-Indexed Mode	H-10
Base Page Indirect Z-Indexed Mode	H-10
Base Page Quad Indirect Z-Indexed Mode	H-10
32-bit Base Page Indirect Z-Indexed Mode	H-11
32-bit Base Page Indirect Quad Z-Indexed Mode	H-11
32-bit Base Page Indirect Mode	H-11
32-bit Base Page Indirect Mode	H-12
Stack Relative Indirect, Indexed by Y	H-12
Relative Addressing Mode	H-12
Relative Word Addressing Mode	H-13
6502 Instruction Set	H-13
Opcode Map	H-14
Instruction Timing	H-14
Addressing Mode Table	H-16
Official And Unintended Instructions	H-16

4510 Instruction Set	H-57
Opcode Map	H-58
Instruction Timing	H-58
Addressing Mode Table	H-61
45GS02 Compound Instructions	H-116
I Developing System Programmes	I-1
Introduction	I-5
Flash Menu	I-5
Format/FDISK Utility	I-6
Keyboard Test Utility	I-7
MEGA65 Configuration Utility	I-7
Freeze Menu	I-7
Freeze Menu Helper Programmes	I-7
Hypervisor	I-8
OpenROM	I-8
J MEGA65 Hypervisor Services	J-1
General Services	J-3
\$00:\$00 - Get Hypervisor Version	J-3
\$00:\$38 - Get Current Error Code (geterrorcode)	J-3
\$00:\$3A - Setup Transfer Area for Other Calls (setup_transfer_area)	J-5
Disk/Storage Hypervisor Calls	J-5
\$00:\$02 - Get Default Drive (SD card Partition)	J-6
\$00:\$04 - Get Current Drive (SD card Partition)	J-6
\$00:\$06 - Select Drive (SD card Partition)	J-6
\$00:\$08 - <i>NOT IMPLEMENTED</i> Get Disk Size	J-6
\$00:\$0A - <i>NOT IMPLEMENTED</i> Get Current Working Directory	J-6
\$00:\$0C - Change Working Directory	J-7

\$00:\$0E - <i>NOT IMPLEMENTED</i> Create Directory	J-7
\$00:\$10 - <i>NOT IMPLEMENTED</i> Remove Directory	J-7
\$00:\$12 - Open Directory (opendir)	J-7
\$00:\$14 - Read Next Directory Entry (readdir)	J-8
\$00:\$16 - Close Directory (closedir)	J-8
\$00:\$18 - Open File (openfile)	J-8
\$00:\$1A - Read From a File (readfile)	J-8
\$00:\$1C - <i>NOT IMPLEMENTED</i> Write to a File (writefile)	J-8
\$00:\$1E - <i>NOT IMPLEMENTED</i> Create File (mkfile)	J-8
\$00:\$20 - Close a File (closefile)	J-8
\$00:\$22 - Close All Open Files (closeall)	J-8
\$00:\$24 - <i>NOT IMPLEMENTED</i> Seek to a Given Offset in a File (seekfile)	J-8
\$00:\$26 - <i>NOT IMPLEMENTED</i> Delete a File (rmfile)	J-9
\$00:\$28 - <i>NOT IMPLEMENTED</i> Get Information About a File (fstat)	J-9
\$00:\$2A - <i>NOT IMPLEMENTED</i> Rename a File (rename)	J-9
\$00:\$2C - <i>NOT IMPLEMENTED</i> Set time stamp of a file (filedate)	J-9
\$00:\$2E - Set the current filename (setname)	J-9
\$00:\$30 - Find first matching file (findfirst)	J-9
\$00:\$32 - Find subsequent matching file (findnext)	J-9
\$00:\$34 - Find matching file (one only) (findfile)	J-10
\$00:\$36 - Load a File into Main Memory (loadfile)	J-10
\$00:\$3C - Change Working Directory to Root Directory of Selected Partition	J-10
\$00:\$3E - Load a File into Attic Memory (loadfile_attic)	J-10
Disk Image Management	J-10
\$00:\$40 - Attach a D81 Disk Image to Drive 0	J-10
\$00:\$42 - Detach All D81 Disk Images	J-10
\$00:\$44 - Write Enable All Currently Attached D81 Disk Images	J-11
\$00:\$46 - Attach a D81 Disk Image to Drive 1	J-11

Task and Process Management	J-11
\$00:\$50 – <i>NOT IMPLEMENTED</i> Get Task List	J-11
\$00:\$52 – <i>NOT IMPLEMENTED</i> Send Message to Another Task	J-11
\$00:\$54 – <i>NOT IMPLEMENTED</i> Receive Messages From Other Tasks	J-11
\$00:\$56 – <i>NOT IMPLEMENTED</i> Write Into Memory of Another Task	J-11
\$00:\$58 – <i>NOT IMPLEMENTED</i> Read From Memory of Another Task	J-11
\$00:\$60 – <i>NOT IMPLEMENTED</i> Terminate Another Task	J-11
\$00:\$62 – <i>NOT IMPLEMENTED</i> Create a Native MEGA65 Task	J-12
\$00:\$64 – <i>NOT IMPLEMENTED</i> Load File Into Task	J-12
\$00:\$66 – <i>NOT IMPLEMENTED</i> Create a C64-Mode Task	J-12
\$00:\$68 – <i>NOT IMPLEMENTED</i> Create a C65-Mode Task	J-12
\$00:\$6A – <i>NOT IMPLEMENTED</i> Exit and Switch to Another Task	J-12
\$00:\$6C – <i>NOT IMPLEMENTED</i> Context-Switch to Another Task	J-12
\$00:\$6E – <i>NOT IMPLEMENTED</i> Exit This Task	J-12
\$00:\$70 – Toggle Write Protection of ROM Area	J-12
\$00:\$72 – Toggle 4510 vs 6502 Processor Mode	J-12
\$00:\$74 – Get current 4510 memory MAPping	J-13
\$00:\$76 – Set 4510 memory MAPping	J-13
\$00:\$7C – Write Character to Serial Monitor/Matrix Mode Interface	J-13
\$00:\$7E – Reset MEGA65	J-13
\$01:\$00 – Enable Write Protection of ROM Area	J-13
\$01:\$02 – Disable Write Protection of ROM Area	J-13
System Partition & Freezing	J-14
\$02:\$00 – Read System Config Sector Into Memory	J-14
\$02:\$02 – Write System Config Sector From Memory	J-14
\$02:\$04 – Apply System Config Sector Current Loaded Into Memory	J-14
\$02:\$06 – Set DMAgic Revision Based On Loaded ROM	J-14
\$02:\$10 – Locate First Sector of Freeze Slot	J-14

\$02:\$12 – Unfreeze From Freeze Slot	J-14
\$02:\$14 – Read Freeze Region List	J-14
\$02:\$16 – Get Number of Freeze Slots	J-14
\$03:\$XX – Write Character to Serial Monitor/Matrix Mode Interface	J-14
Secure Mode	J-14
\$11:\$XX – Request Enter Secure Mode	J-15
\$12:\$XX – Request Exit Secure Mode	J-15
\$32:\$XX – <i>DEPRECATED</i> Set Protected Hardware Configuration	J-15
\$3F:\$XX – Freeze Self	J-15

K Machine Language Monitor K-1

Introduction	K-3
C65 ROM Standard Machine Language Monitor	K-3
Table of C65 ROM Standard Monitor Commands	K-4
Calling the Monitor	K-4
addresses and numbers	K-5
D : DISASSEMBLE	K-5
M : MEMORY	K-6
Enhanced Machine Language Monitor	K-7
Table of MEGA65 Enhanced Monitor Commands	K-8
Calling the Monitor	K-9
addresses and numbers	K-9
Assembler	K-9
A : ASSEMBLE	K-10
B : BITMAPS	K-11
MEGA65 Matrix Mode Monitor Interface	K-12
Table of Matrix Mode Monitor Commands	K-14
Calling the Monitor	K-14
# : Hypervisor trap enable/disable	K-14

+ : Set Serial Interface UART Divisor	K-15
@ : CPUMEMORY	K-15
? or H : HELP	K-16
B : BREAKPOINT	K-16
D : DISASSEMBLE	K-16
E : FLAGWATCH	K-17
F : FILL	K-17
G : SETPC	K-17
I : INTERRUPTS	K-18
J : DEBUGMON	K-18
L : LOADMEMORY	K-18
M : MEMORY	K-18
R : REGISTERS	K-19
S : SETMEMORY	K-19
T : TRACE	K-19
W : WATCHPOINT	K-19
Z : CPUHISTORY	K-20

L F018-Compatible Direct Memory Access (DMA) Controller	L-1
F018A/B DMA Jobs	L-3
F018 DMA Job List Format	L-4
F018 11 byte DMA List Structure	L-5
F018B 12 byte DMA List Structure	L-5
Performing Simple DMA Operations	L-7
MEGA65 Enhanced DMA Jobs	L-12
Texture Scaling and Line Drawing	L-15
Audio DMA	L-17
Sample Address Management	L-18
Sample Playback frequency and Volume	L-18

Pure Sine Wave	L-19
Sample playback control	L-19
F018 “DMAgic” DMA Controller	L-19
MEGA65 DMA Controller Extensions	L-20
Unimplemented Functionality	L-24

M VIC-IV Video Interface Controller

M-1

Features	M-5
VIC-II/III/IV Register Access Control	M-6
Detecting VIC-II/III/IV	M-7
Video Output Formats, Timing and Compatibility	M-8
Integrated Marvellous Digital Hookup™(IMDH™) Digital Video Output	M-9
Connecting to Naughty Proprietary Digital Video Standards	M-9
Frame Timing	M-11
Physical and Logical Rasters	M-14
Bad Lines	M-14
Memory Interface	M-15
Relocating Screen Memory	M-15
Relocating Character Generator Data	M-16
Relocating Colour / Attribute RAM	M-16
Relocating Sprite Pointers and Images	M-17
Hot Registers	M-18
New Modes	M-18
Why the new VIC-IV modes are Character and Bitmap modes, not Bit-plane modes	M-18
Displaying more than 256 unique characters via “Super-Extended Attribute Mode”	M-19
Using Super-Extended Attribute Mode	M-23
Full-Colour (256 colours per character) Text Mode (FCM)	M-27
Nibble-colour (16 colours per character) Text Mode (NCM)	M-27

Alpha-Blending / Anti-Aliasing	M-28
Flipping Characters	M-28
Variable Width Fonts	M-28
Raster Re-write Buffer	M-29
Sprites	M-29
VIC-II/III Sprite Control	M-30
Extended Sprite Image Sets	M-30
Variable Sprite Size	M-30
Variable Sprite Resolution	M-31
Sprite Palette Bank	M-31
Full-Colour Sprite Mode	M-32
VIC-II / C64 Registers	M-35
VIC-III / C65 Registers	M-38
VIC-IV / MEGA65 Specific Registers	M-41
N 6526 Complex Interface Adaptor (CIA) Registers	N-1
CIA 6526 Registers	N-3
CIA 6526 Hypervisor Registers	N-6
O 4551 UART, GPIO and Utility Controller	O-1
C65 6551 UART Registers	O-3
4551 General Purpose I/O & Miscellaneous Interface Registers	O-4
P 45E100 Fast Ethernet Controller	P-1
Overview	P-3
Differences to the RR-NET and similar solutions	P-3
Theory of Operation: Receiving Frames	P-4
Accessing the Ethernet Frame Buffers	P-6
Theory of Operation: Sending Frames	P-7
Advanced Features	P-7

Broadcast and Multicast Traffic and Promiscuous Mode	P-8
Debugging and Diagnosis Features	P-8
Memory Mapped Registers	P-9
COMMAND register values	P-11
Example Programs	P-11

Q 45IO27 Multi-Function I/O Controller Q-1

Overview	Q-3
F011-compatible Floppy Controller	Q-3
Multiple Drive Support	Q-3
Buffered Sector Operations	Q-4
Reading Sectors from a Disk	Q-4
Track Auto-Tune Function Deprecated	Q-5
Sector Skew and Target Any Mode	Q-5
Disk Layout and 1581 Logical Sectors	Q-6
FD2000 Disks	Q-7
High-Density and Variable-Density Disks	Q-7
Track Information Blocks	Q-8
Formatting Disks	Q-9
Write Pre-Compensation	Q-10
Buffered Sector Writing	Q-10
F011 Floppy Controller Registers	Q-11
SD card Controller and F011 Virtualisation Functions	Q-13
SD card Based Disk Image Access	Q-14
F011 Virtualisation	Q-16
Dual-Bus SD card Controller	Q-16
Write Gate	Q-17
Fill Mode	Q-17
Selecting Among Multiple SD cards	Q-17

SD Controller Command Table	Q-18
Touch Panel Interface	Q-20
Audio Support Functions	Q-23
Miscellaneous I/O Functions	Q-25
R Reference Tables	R-1
Units of Storage	R-3
Base Conversion	R-4
S Flashing the FPGAs and CPLDs in the MEGA65	S-1
Suggested PC specifications	S-5
Warning	S-6
Installing Vivado	S-6
Installing the FTDI drivers	S-22
Linux drivers	S-23
Windows drivers	S-23
Flashing the main FPGA using Vivado	S-27
Flashing the CPLD in the MEGA65's Keyboard with Lattice Diamond	S-40
Flashing the MAX10 FPGA on the MEGA65's Mainboard with INTEL QUARTUS	S-47
T Trouble shooting	T-1
Hardware	T-3
No lights when powering on	T-3
Vivado	T-3
RAM requirements	T-3
mega65_ftp	T-3
Missing Library	T-4

U Model Specific Features	U-1
Detecting MEGA65 Models	U-3
MEGA65 Desktop Computer, Revision 3 onwards	U-3
MEGA65 Desktop Computer, Revision 2	U-4
MEGAphone Handheld, Revisions 1 and 2	U-5
Nexys4 DDR FPGA Board	U-6
V Schematics	V-1
MEGA65 R3 Schematics	V-3
MEGA65 R2 Schematics	V-28
W Supporters & Donors	W-1
Organisations	W-3
Contributors	W-4
Supporters	W-5
INDEX	Index-3

PART I

PREFACE

CHAPTER

1

Introduction

- **Welcome to the MEGA65!**
- **Other Books in this series**

WELCOME TO THE MEGA65!

Congratulations on your purchase of one of the most long-awaited computers in the history of computing. The MEGA65 is a community designed computer, based on the never-released Commodore® 65¹ computer; a computer designed in 1989 and intended for public release in 1990. Decades have passed, and the MEGA65 invokes an earlier time when computers were simple and friendly. They were not only simple to operate and understand how they work, but friendly and approachable for new users.

These 1980s computers inspired an entire generation of professionals to choose the exciting and rewarding technology careers they have today. Just imagine the joy of these individuals as they learned they could use their new computer to solve problems, write a letter, prepare taxes, invent new things, or even discover how the universe works. We want to re-create that level of excitement not found in modern computing, so we made the **MEGA65**.

The MEGA65 team believes that owning a computer is like owning a home. You don't just use a home; you change things big and small to make it your own custom living space. After a while, when you settle in, you may decide to renovate or expand your home to make it more comfortable or provide more utility. Think of the MEGA65 as a "computing home".

This guide will teach you how to do more than just hang pictures on a wall, it will show you how to build your dream home. While you read this user's guide, you will learn how to operate the MEGA65, write programs, add additional software, and extend hardware capabilities. What won't be immediately obvious is that along the journey, you will also learn about the history of computing as you explore BASIC version 65 and operating system commands.

Computer graphics and music make computing more fun; and we designed the MEGA65 for fun! In this user's guide, you will learn how to program using the MEGA65's built-in **graphics** and **sound** capabilities. But you don't need to be a programmer to have fun with the MEGA65. Because the MEGA65 includes a complete Commodore® 64^{TM2}, it can also run thousands of games, utilities, and business software packages from the past, as well as new programs being written today by Commodore computer enthusiasts. Excitement for the MEGA65 will grow as we discover what programmers create as they learn about the power and features of this modern Commodore computer recreation. Together, we will build a new "homebrew" community to create software and projects we didn't think were possible on the MEGA65.

¹Commodore is a trademark of C= Holdings

²Commodore 64 is a trademark of C= Holdings

We welcome you on this journey! Thank you for becoming a part of the **MEGA65** community of users, programmers, and enthusiasts! Get involved, learn more about your MEGA65, and join us online at:

OTHER BOOKS IN THIS SERIES

This is one of several MEGA65 documentation volumes. The series includes:

- The MEGA65 User's Guide - Provides an introduction to the MEGA65, and a condensed BASIC 65 command reference
- The MEGA65 BASIC 65 Reference Guide - Comprehensive documentation of all BASIC 65 commands, functions and operators
- The MEGA65 Chipset Reference - Detailed documentation about the MEGA65 and C65's custom chips
- The MEGA65 Developer Guide - Information for developers who wish to write programs for the MEGA65
- The MEGA65 Book - All volumes in a single huge PDF for easy searching. 1080 pages and growing!

PART II

**GETTING TO KNOW YOUR
MEGA65**

CHAPTER 2

Setup

- **Unpacking and connecting the MEGA65**
- **Rear Connections**
- **Side Connections**
- **MEGA65 screen and peripherals**
- **Optional Connections**
- **Operation**

UNPACKING AND CONNECTING THE MEGA65

Time to set up your MEGA65 home computer! The box contains the following:

- MEGA65 computer
- Power supply (black box with socket for mains supply)
- This book, the MEGA65 User's Guide

In addition, to be able to use your MEGA65 computer you may need:

- A television or computer monitor with a VGA or digital video input, that is capable of displaying an image at 480p or 576p (720x480 or 720x576 pixel resolution at 50Hz or 60Hz)
- A VGA video cable, or;
- A digital video cable

These items are not included with the MEGA65.

You may also like to use the following to get the most out of your MEGA65:

- 3.5mm mini-jack audio cable and suitable speakers or hifi system, so that you can enjoy the sound capabilities of your MEGA65.
- RJ45 Ethernet cable (regular network cable) and a network router or switch. This allows the usage of the high-speed networking capabilities of your MEGA65.

REAR CONNECTIONS

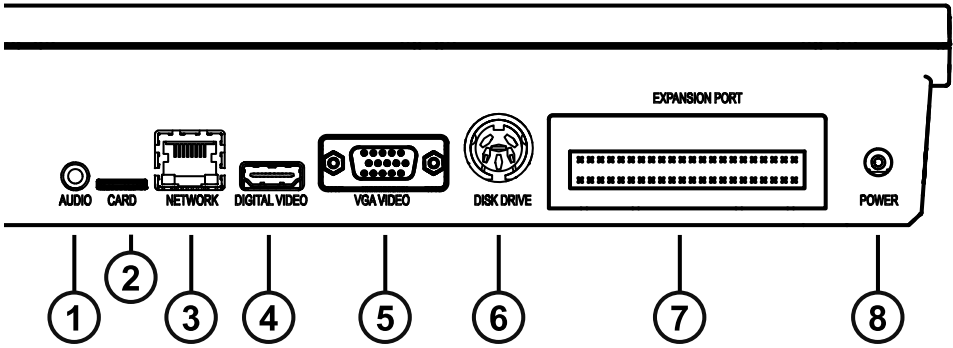

- | | |
|---|--------------------------------------|
| 1 | 3.5mm Audio Mini-Jack |
| 2 | External microSD Card Slot |
| 3 | Network LAN Port |
| 4 | Digital Video Connector |
| 5 | VGA Video Connector |
| 6 | External Floppy Disk Drive Connector |
| 7 | Cartridge Expansion Port |
| 8 | DC Power-In Socket |

SIDE CONNECTIONS

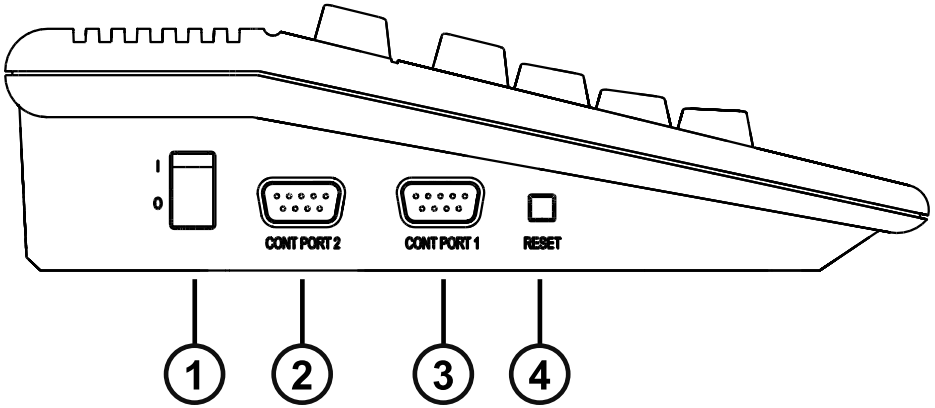

- | | |
|---|-------------------|
| 1 | Power Switch |
| 2 | Controller Port 2 |
| 3 | Controller Port 1 |
| 4 | Reset Button |

Various peripherals can be connected to Controller Ports 1 and 2 such as joysticks, paddles or mouses.

MEGA65 SCREEN AND PERIPHERALS

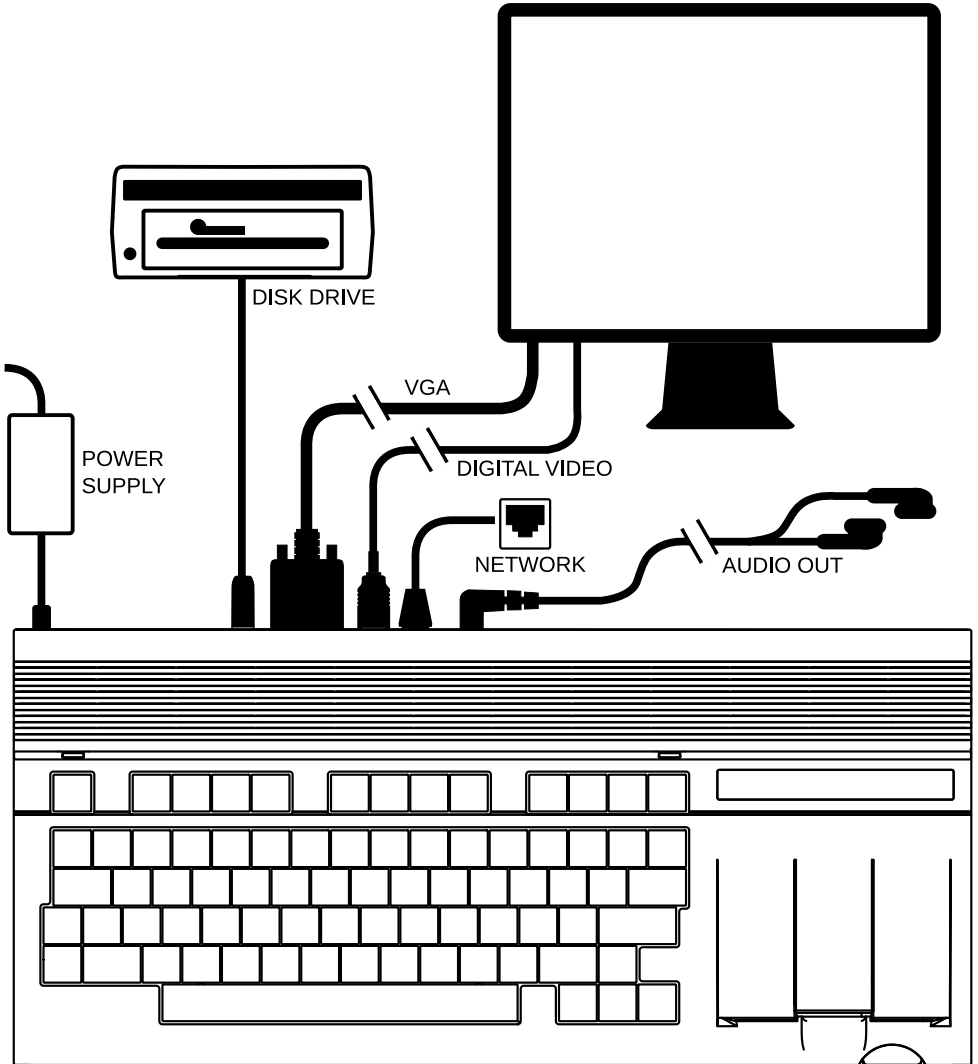

1. Connect the power supply to the Power Supply socket of the MEGA65.
2. If you have a VGA monitor and a VGA cable, connect one end to the VGA port of the MEGA65 and the other end into your VGA monitor.
3. If you have a TV or monitor with a compatible Digital Video connector, connect one end of your cable to the Digital Video port of the MEGA65, and the other into the Digital Video port of your monitor. If you own a monitor with a DVI socket, you can use a Digital Video to DVI adapter.

OPTIONAL CONNECTIONS

1. The MEGA65 includes an internal 3.5" floppy disk drive. You can also connect older Commodore® IEC serial floppy drives to the MEGA65, such as the Commodore® 1541, 1571 or 1581. To use these drives, connect one end of an IEC cable to the Commodore® floppy disk drive and the other end to the Disk Drive socket of the MEGA65. You can also connect SD2IEC devices and Pi1541's. It is also possible to daisy-chain additional floppy disk drives or Commodore® compatible printers.
2. You can connect your MEGA65 to an Ethernet network using a standard Ethernet cable.
3. For enjoying audio from your MEGA65, you can connect a 3.5mm stereo mini-jack cable to an audio amplifier or speaker system. If your system has RCA connectors you will need a 3.5mm mini-jack to twin RCA adapter cable. The MEGA65 also has a built-in amplifier to allow the use of headphones.
4. A microSD card (either SDHC or SDXC) can be inserted into the external microSD card slot at the rear of the MEGA65.
5. Underneath the MEGA65, you will find an opening/trapdoor that provides access to the internal SD card slot, and also two PMOD connectors that allow for future possible hardware expansions such as Tape adapters, Userport interfaces, extra memory, or even real SIDs.

OPERATION

Using the MEGA65

1. Switch on the MEGA65 by using the switch on the left-hand side.
2. After a moment, the following will be displayed on your TV or monitor:

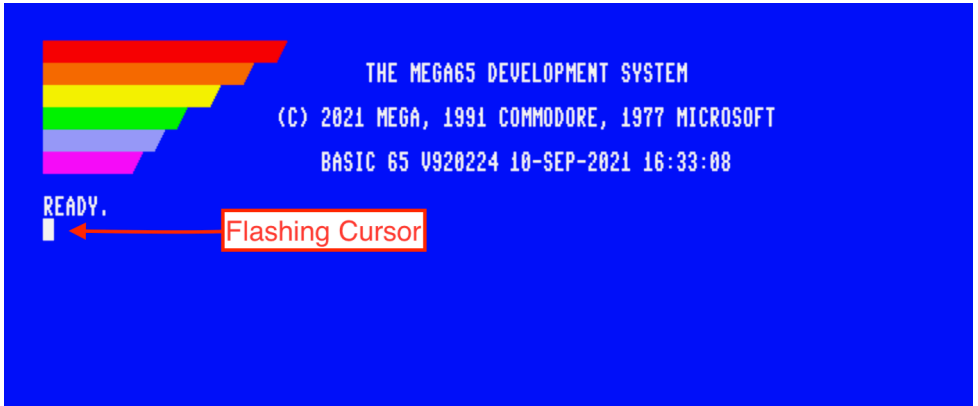

THE CURSOR

The flashing square underneath the READY prompt is called the cursor. The cursor indicates that the computer is ready to accept input. Pressing keys on the keyboard will print their respective characters onto the screen. The characters will be printed at the current cursor position, and the cursor will advance to the next position after every key press.

You can type commands, for example: tell the computer to load a program. You can even start entering program code.

CHAPTER

3

Getting Started

- **Keyboard**
- **The Screen Editor**
- **Editor Functionality**

KEYBOARD

Now that everything is connected, it's time to get familiar with the MEGA65 keyboard.

You may notice that the keyboard is a little different from the keyboards used on computers today. While most keys will be in familiar positions, there are some specialised keys, and some with special graphic symbols marked on the front.

Here's a brief description of how some of these special keys function.

Command Keys

The Command Keys are: , , , , and .

RETURN

Pressing  enters the information you have typed into the MEGA65's memory. The computer will either act on a command, store some information, or display an error message if you made a mistake.

SHIFT





The two  keys are located on the left and the right. They work very much like the Shift key on a regular keyboard, however they also perform some special functions as well.

In upper case mode, holding down  and pressing any key with two graphic symbols on the front produces the right-hand symbol on that key. For example,  and  prints the  character.

In lower case mode, pressing  and a letter key prints the upper case letter on that key.

Finally, holding  down and pressing a Function key accesses the function shown on the front of that key. For example:  and  activates **F2**.

SHIFT LOCK

In addition to  is . Press this key to lock down the Shift function. Now any key you press while  is illuminated prints the character to the screen as if you were holding down . This includes special graphic characters.

CTRL

CTRL is the Control key. Holding down **CTRL** and pressing another key allows you to perform Control Functions. For example, holding down **CTRL** and one of the number keys allows you to change text colours. The colour that is printed at the top row on the front of the number key will be used.

There are some examples of this in Chapter/Appendix 3 on page 3-7, and all of the Control Functions are listed in Chapter/Appendix C on page C-5.

If a program is being LISTed to the screen, holding down **CTRL** slows down the display of each line.

Holding **CTRL** and pressing ***** enters the Matrix Mode Debugger.

RUN STOP

Normally, pressing **RUN STOP** stops the execution of a program. Holding **SHIFT** while pressing **RUN STOP** loads the first program from disk.

Programs are able to disable **RUN STOP**.

You can boot your MEGA65 into the Machine Code Monitor by holding down **RUN STOP** and pressing reset on the left-hand side.

RESTORE

The computer screen can be restored to a clean state without clearing the memory by holding down **RUN STOP** and pressing **RESTORE**. This combination also resets operating system vectors and re-initialises the screen editor, which makes it a handy combination if the computer has become a little confused.

Programs are able to disable this key combination.

You can also enter the Freeze Menu by holding **RESTORE** down for more than one second. From there you can access the Machine Code Monitor.

THE CURSOR KEYS

At the bottom right-hand side of the keyboard are the cursor keys. These four directional keys allow you move the cursor to any position for on-screen editing.

The cursor moves in the direction indicated on the keys:    .

However, it is also possible to move the cursor up by using  and . In the same way you can move the cursor left by using  and .

You don't have to keep pressing a cursor key over and over. If you need to move the cursor a long way, you can keep the key pressed down. When you are finished, simply release the key.



INSerT/DELeTe

This is the INSERT / DELETE key. When pressing , the character to the left is deleted, and all characters to the right are shifted one position to the left.

To insert a character, hold  and press . All the characters to the right of the cursor are shifted to the right. This allows you to type a letter, number or any other character at the newly inserted space.



CLear/HOME

Pressing  places the cursor at the top left-most position of the screen.

Holding down  and pressing  clears the entire screen *and* places the cursor at the top left-most position of the screen.

MEGA KEY

 or the MEGA key provides a number of different functions and can be used to launch special utilities.

Holding  and pressing  switches between lower and uppercase character modes.

Holding  and pressing any key with two graphic symbols on the front prints the left-most graphic symbol to the screen.

Holding  and pressing any key that shows a single graphic symbol on the front prints that graphic symbol to the screen.

Holding  and pressing a number key switches to one of the colours in the second range, i.e., the colour that is printed at the bottom row on the front of the number key will be used.







Holding  and pressing  enters the Matrix Mode Debugger.

Switching on the MEGA65 or pressing the reset button on the left-hand side while holding down  switches the MEGA65 into C64-mode.

NO SCROLL

If a program is being LISTed to the screen, pressing  freezes the screen output. This feature is not available in C64-mode.



Function Keys

There are seven Function keys available for use by software applications,       and  can be used to perform specific functions with a single press.

Hold  to access  through to  as shown on the front of each Function key.

Only Function keys  to  are available in C64-mode.

HELP



 can be used by software and also acts as  / .

ALT

Holding  down while pressing other keys can be used by software to perform specific functions. Not available in C64-mode.

Holding  down while switching the MEGA65 on activates the Utility Menu. You can format an SD card, or enter the MEGA65 Configuration Utility to select the default video mode and change other settings, or to test your keyboard.

CAPS LOCK

 works similarly to  in C65 and MEGA65-modes, but only modifies the letter keys. Also, holding  down forces the processor to run at the maximum speed.

This can be used, for example, to speed up loading from the internal disk drive or SD card, or to greatly speed up the de-packing process after a program is run. This can reduce the loading and de-packing time from many seconds to as little as a fraction of a second.

THE SCREEN EDITOR

When you switch on your MEGA65 or reset it, the following screen will appear:

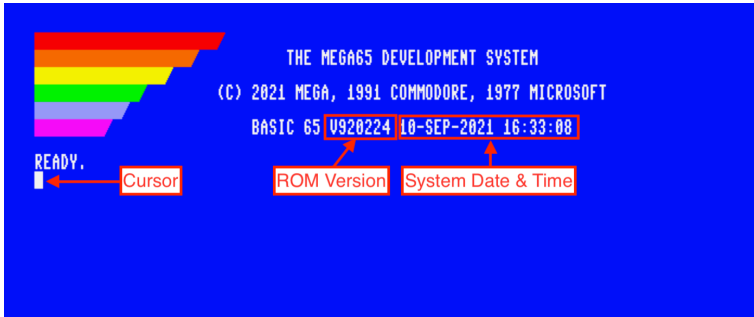

The colour bars in the top left-hand side of the screen can be used as a guide to help calibrate the colours of your display. The screen also displays the name of the system, the copyright notice, and the ROM version. The displayed date and time are taken from the internal RTC (Real-Time Clock), which can be set in the Configure Menu.

Finally, you will see the READY prompt and the flashing cursor.

You can begin typing keys on the keyboard and the characters will be printed at the cursor position. The cursor itself will advance after each key press.

You can also produce reverse text or colour bars by holding down **CTRL** and pressing **9**, or **R**. This enters reverse text mode. When this is enabled, you can press and hold the **SPACE BAR**. While doing so, a white bar will be drawn across the screen.

You can even change the current colour by holding **CTRL** down and pressing a number key (from **1** to **8**). For example, if you press and hold **CTRL** down and press **1**, the colour will change to black. Now, when you hold down the **SPACE BAR**, a black bar will be drawn. If you continue to change the colour and press the **SPACE BAR**, you will get an effect similar to the image below:

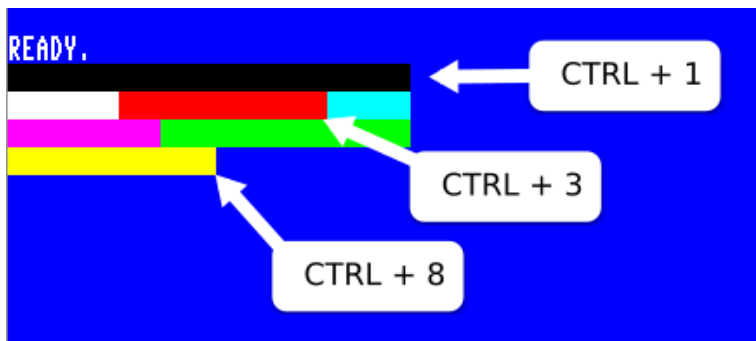

You can disable reverse text mode by holding **CTRL** and pressing **0**.

By pressing any key, characters will be printed to the screen in the chosen colour.

A further eight colours can be selected by holding down **M** and pressing a key from **1** to **8**. The colour that is printed at the bottom row on the front of the number key will be used. For example, if you held **M** down while pressing **4**, dark gray will be used. For even more colours, see Chapter/Appendix C.3 on page C-11.

You can create fun pictures just by using these colours and letters. Here's an example of what a year four student drew:



What will you draw?

Functions



Functions using **CTRL** are called **Control Codes**. Functions using **M** are called **Mega Codes**. There are also functions that are called by using **SHIFT**, which are called **Shifted Codes**.





Lastly, **ESC** enables the use of **Escape Sequences**.

You can read about all of these functions in detail in Chapter/Appendix C on page C-5, but some are shown in this section.

ESC Sequences



Escape sequences are performed a little differently than a Control function or a Shift function. Instead of holding the modifier key down, an Escape sequence is performed by pressing  and releasing it, followed by pressing the desired key code.







For example: to switch between 40/80 column mode, press and release , then press .







There are more modes available. You can create flashing text by holding  down and pressing . Any characters you type in will flash. Turn flash mode off by pressing , then .

EDITOR FUNCTIONALITY

The MEGA65 screen can allow you to do advanced tabbing, and quickly move around the screen in many ways to help you to be more productive.



For example, press  to go to the home position on the screen. Hold  down and press  several times. This is the **Word Advance function**, which jumps your cursor to the next word, or printable character.

You can set custom tab positions on the screen for your convenience. Press  and then  to the fourth column. Hold down  and press  to set a tab. Move another 16 positions to the right again, and press  and  again to set a second tab.

Press  to go back to the home position. Hold  down and press . This is the **Forward Tab function**. Your cursor will tab to the fourth position. Press  and  again. Your cursor will move to position 8. Why do you ask? By default, every 8th position is already set as a tabbed position. So the 4th and 20th positions have been added to the existing tab positions. You can continue to press  and  to advance to the 16th and 20th positions.

To find the complete set of Control codes, see Chapter/Appendix C on page C-5.



Creating a Window

You can set a window on the MEGA65 working screen. Move your cursor to the beginning of the "BASIC 65" text. Press , then press . Move the cursor 10 lines down and 15 to the right.



Press , then . Anything you type will be contained within this window.

To escape from the window back to the full screen, press  twice.

Extras

Long press on  to go into the Freeze Menu. Then press  to switch joystick ports without having to physically swap the joystick to the other port.

Go to **Fast mode** with POKE 0,65 or use the Freeze Menu.

 +  switches between uppercase and lowercase text for the entire display.

CHAPTER 4

Configuring your MEGA65

- **Important Note**
- **Formatting SD cards**
- **Installing ROM and Other Support Files**
- **On-boarding**
- **Configuration Utility**

IMPORTANT NOTE

For your convenience, your MEGA65 comes with an SD card with all of the essential files already on it, so you may prefer to skip this section and jump straight to the on-boarding section on page 4-9.

Alternatively, you're welcome to read this section and familiarise yourself on how your SD card was prepared.

Do not format the SD card that came with your MEGA65. If you want to create a new bootable SD card, please use another one, and keep the SD card that came with your MEGA65 as a safety backup.

FORMATTING SD CARDS

The MEGA65 has two SD card slots: A full-size SD card slot inside, under the trap-door, and a microSD size slot on the rear. The current version of the MEGA65 firmware only supports the use of one SD card at a time. If you have cards in both slots, the MEGA65 will default to the external slot. The exception to this is that the MEGA65's FDISK/FORMAT utility can access both, allowing you to select which SD card to format or repair.

Depending on the model, your MEGA65 may or may not have come with a pre-configured SD card. If it hasn't, or if you wish to use a different SD card, (e.g., with a larger capacity), you must format it for use in the MEGA65.

This must be done on the MEGA65, not on a PC or other computer.

Only use SDHC cards. Older SD cards (typically with a capacity of <4GB) will not work. Newer SDXC cards with capacities greater than 32GB may or may not work. We would appreciate hearing your experience with such cards. It is unimportant as to which file-system is currently on the card, as the MEGA65 FDISK/FORMAT utility will completely reformat the card.

There are several reasons for this: First, to fit the most features into the MEGA65's small operating system, it is particular about the FAT32 file system it uses. Second, only the MEGA65 FDISK/FORMAT utility can create a MEGA65 System Partition. The MEGA65 System Partition holds non-volatile configuration settings for your MEGA65, and also contains the freeze slots that make it easy to switch between MEGA65 programs and games.

Formatting an SD card on the MEGA65 is easy.

Switch the MEGA65 on while holding down the  key.

This will present the MEGA65 Utility Menu, which contains a selection of built-in utilities, similar to the following:



Note that Utility Menu is always accessible, even if no SD card is present in both the internal and external slots.

The exact set of utilities depends on the model of your MEGA65 and the version of the MEGA65 factory core which it is running. However, all versions include both the MEGA65 FDISK/FORMAT utility, and the MEGA65 Configure utility. Most models also include a keyboard test utility, that you can use to test that your keyboard is functioning correctly. This is the same utility used in the factory when testing brand new keyboards.

Select the number that corresponds to the FDISK/FORMAT utility. This will typically be 2. The FDISK utility will start, and attempt to detect the size of all SD cards you have installed. If you have both an internal and external SD card installed, it will allow you to choose which one you wish to format. The internal SD card is bus 0, and the external microSD card is bus 1. Note that the MEGA65 will always attempt to boot from the external microSD card if one is present.

For safety, when formatting we *strongly* recommend that you remove any SD card or microSD card that you do not intend to format, so that you do not accidentally destroy any data. This is because formatting an SD card on the MEGA65 cannot be undone, and all data currently on the SD card *will be lost*. If you have files or data on the SD card that you wish to retain, you should first back them up. The contents of the FAT32 partition can be easily backed up by inserting the SD card into another computer. The contents of the MEGA65 System Partition, including the contents of freeze slots requires the use of specialised software.

You should aim to back up valuable data from your MEGA65 on a regular basis, especially while the computer remains under development. While we take every care

to avoid data corruption or other mishaps, we cannot guarantee that the MEGA65 is free of bugs in this regard.

If you have only an internal SD card, you might see a display similar to the following:

```
Detecting SD card(s) (can take a while)
SD Card 0 (Internal SD slot):
Maximum readable sector is $01CD9FFE
14771 MiB SD CARD FOUND.
SD Card read speed = 1422 KB/sec

Current partition table:
0C : Start=0 /0 /0 or 00000000 / End=0 /0 /0 or 018D97FE
41 : Start=0 /0 /0 or 018D97FE / End=0 /0 /0 or 00400000
00 : Start=0 /0 /0 or 00000000 / End=0 /0 /0 or 00000000
00 : Start=0 /0 /0 or 00000000 / End=0 /0 /0 or 00000000

SD Card 1 (External microSD slot):
No card detected on bus 1

Please select SD card to modify: 0/1

MEGA65 FDISK/FORMAT V00.10 : (C) COPYRIGHT 2017-2020 PAUL GARDNER-STEPHEN ETC.
```

Once you have selected the bus, the FDISK/FORMAT utility will ask you to confirm that you wish to delete everything:

```
Please select SD card to modify: 0/1
Maximum readable sector is $01CD9FFE
14771 MiB SD CARD FOUND.
SD Card read speed = 1186 KB/sec

Current partition table:
0C : Start=0 /0 /0 or 00000000 / End=0 /0 /0 or 018D97FE
41 : Start=0 /0 /0 or 018D97FE / End=0 /0 /0 or 00400000
00 : Start=0 /0 /0 or 00000000 / End=0 /0 /0 or 00000000
00 : Start=0 /0 /0 or 00000000 / End=0 /0 /0 or 00000000

$00400000 Sectors available for MEGA65 System partition.
2046 Freeze and OS Service slots.
$018D97FE Sectors available for VFAT32 partition.

Format Card with new partition table and FAT32 file system?
12722 MiB VFAT32 Data Partition @ 00000000:
$003199ED Clusters, 25396 Sectors/FAT, 568 Reserved Sectors.
2048 MiB MEGA65 System Partition @ 018D97FE:

Type DELETE EVERYTHING to continue:
Or type FIX MBR to re-write MBR

MEGA65 FDISK/FORMAT V00.10 : (C) COPYRIGHT 2017-2020 PAUL GARDNER-STEPHEN ETC.
```

To avoid accidental loss of data, you must type **DELETE EVERYTHING** in capitals and press . Alternatively, switch the MEGA65 off and on to abort this process without causing damage to your data.

It is also possible to attempt a recovery from a lost Master Boot Record error (“Boot Sector”) by typing **FIX MBR** instead.

The aim here is to have a correctly formatted SD card with all of the essential files stored on it so the MEGA65 can properly boot. When switching on, the MEGA65 will search for, and boot using these files:

- FREEZER.M65 (Freeze Menu program)
- AUDIOMIX.M65 (Freeze Menu audio mixer utility)
- C64THUMB.M65 (C64 thumbnail image used in freezer)
- C65THUMB.M65 (C65 thumbnail image used in freezer)
- MEGA65.ROM (128KB ROM file)
- MEGA65.D81 (default disk image, automatically mounted)

Straight out of the box, the MEGA65 will only have one SD card installed, accessible via the trap-door under the case. This SD card contains all of the essential files needed to properly boot up. If an external microSD card is also detected during boot up, the MEGA65 will give it higher priority, and will try to boot from it instead. This means that the external microSD card needs to have the essential files on it, otherwise the MEGA65 will not boot up properly and will fall back to loading the OpenROM, which does not support all MEGA65 features. In general, if your MEGA65 cannot boot properly and falls back to OpenROM, your boot-up screen will look similar to this:



INSTALLING ROM AND OTHER SUPPORT FILES

The MEGA65 FDISK/FORMAT utility will add a copy of the Open ROMs project's C64-compatible ROM to your SD card, and will name it MEGA65.ROM.

For MEGA65 owners, we have replaced this file with the latest ROM from the 'Closed ROMs' project. It provides many improvements over the original/incomplete C65 ROMs. It contains the operating system, BASIC 65, CBDOS and the machine language monitor BSMON. This ROM is developed especially for the MEGA65 and can be identified by the version number 92xxxx.

However, you may have other ROMs that you wish to use on your MEGA65. You can copy as many of these as you wish onto the SD card, just make sure that they have the .ROM file extension. The default ROM should be called MEGA65.ROM. These files must be 128KB in size, and use the same internal format as the ROMs intended for the C65. This means that the C64-mode KERNAL must be placed at offset \$E000, a C65-mode BASIC at \$A000, and a suitable character set at \$D000.

You can optionally name your alternate ROMs as 'MEGA65x.ROM', replacing 'x' with a number from 0 to 9. This allows you to quickly boot-up to your alternate ROMs by holding down a number from **0** to **9** prior to switching on your MEGA65.

Other important support files include FREEZER.M65 and AUDIOMIX.M65, which allow you to use the MEGA65's integrated freezer. More details are provided in the 'Floppy Disks And D81 Images' chapter on page 6-3.

ROM File

Original C65 ROMs

You may want to source your own C65 ROM via other means. There were many different versions created during the development of the Commodore 65, and the MEGA65 can use any of them. However, they will not support the advanced features of the MEGA65, and are incomplete and buggy, as development on them ceased due to Commodore abandoning the C65 project.

MEGA65 Closed ROMs

There are also newer versions of the **MEGA65 Closed ROM** actively under development. These ROMs improve upon the original C65 ROMs and make better use of the extra hardware capabilities that the MEGA65 has over the original C65 hardware. These ROMs are available via the filehost (at <https://files.mega65.org>), but only to owners of the MEGA65, who will need to log into the filehost with their credentials in order to download it. It can be located by visiting the "**Files**" tab and searching for "**kernal rom**":

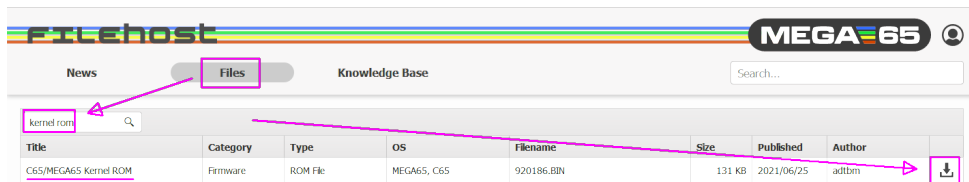

The screenshot shows the MEGA65 Filehost website interface. At the top, there is a navigation bar with 'News', 'Files', and 'Knowledge Base' tabs. A search bar is located to the right of the 'Files' tab. Below the navigation bar, a search box contains the text 'kernal rom'. A search result is displayed in a table format. The table has columns for Title, Category, Type, OS, Filename, Size, Published, and Author. The search result is 'C65/MEGA65 Kernel ROM', categorized as 'Firmware', with a type of 'ROM File', OS 'MEGA65, C65', filename '920186.BIN', size '131 KB', published on '2021/06/25', and author 'adtbn'. A download icon is visible in the bottom right corner of the search result row.

Title	Category	Type	OS	Filename	Size	Published	Author
C65/MEGA65 Kernel ROM	Firmware	ROM File	MEGA65, C65	920186.BIN	131 KB	2021/06/25	adtbn

MEGA65 ROM diff files

If you have sourced your own 911001.bin C65 ROM and would like to patch it to the latest MEGA65 closed ROM, we do provide patches, as the additional improvements we have made to the closed rom are open source. Those diff files are available here:

<http://mega65.org/rom-diffs>

MEGA65 Open ROMs

Another available option is to make use of **MEGA65 Open ROMs**. The latest version of this is always downloadable from either of the following urls:

- <http://mega65.org/open-roms>
- <https://github.com/MEGA65/open-roms/raw/master/bin/mega65.rom>

Support Files

For official owners of the MEGA65 (both the devkit and the final product), visit the following url and log in with the user credentials you have been provided. This will take you to the MEGA65 Filehost location where the "**MEGA65 SD card essentials**" download page is located. Then click the "**Download**" link to retrieve the latest "**SD essentials.rar**" file.

<http://mega65.org/sdcard-files>

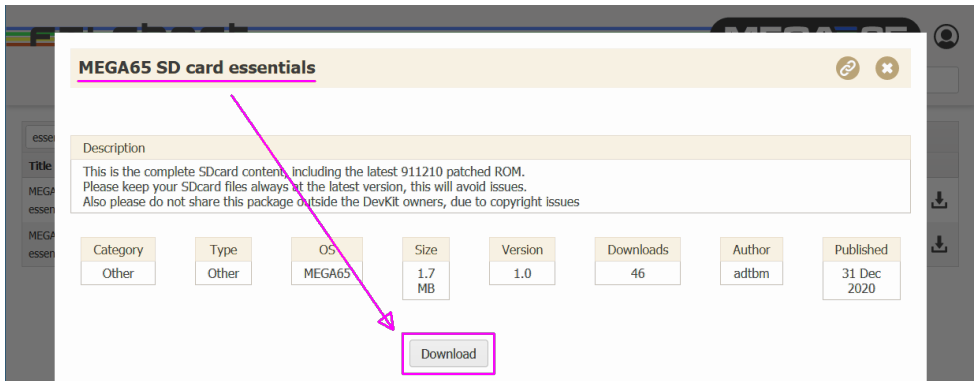

Note that this link is only available to official owners of the MEGA65 product, as the fileset also contains the licensed closed-source MEGA65.ROM file.

For Nexys board owners in search of a similar fileset (without the ROM), visit the following url instead:

<http://mega65.org/sdcard-norom>

This will take you to the MEGA65 Filehost location where the **"MEGA65 SD card essentials - No ROM"** download page is located. Click the **"Download"** link to retrieve the latest **"SD essentialsNoROM.rar"** file.

Note that while this fileset does not contain a ROM, there are future plans for it to include the freely available ROM from the Open ROMs project.

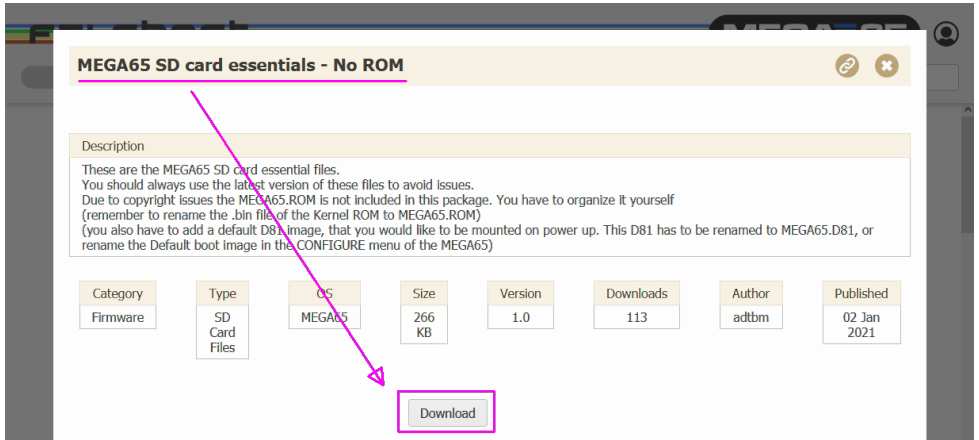

ON-BOARDING

On first launch of your MEGA65, you will see the on-boarding screen.

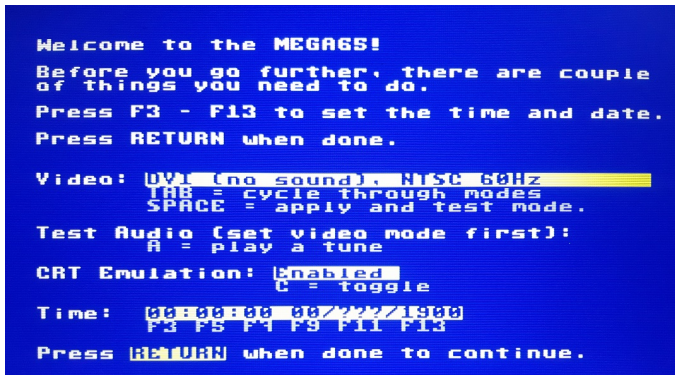

Here you can select and test you screen configuration.

For example, press **TAB** to switch to PAL 50HZ

```
Welcome to the MEGAB5!  
Before you go further, there are couple  
of things you need to do.  
Press F3 - F13 to set the time and date.  
Press RETURN when done.  
  
Video: IVA (no sound) > Pal 50Hz  
TAB = Cycle through modes  
SPACE = apply and test mode.  
  
Test Audio (set video mode first):  
A = play a tune  
  
CRT Emulation: enabled  
C = toggle  
  
Time: 00:00:00 00/00/1900  
F3 F5 F4 F9 F11 F13  
  
Press RETURN when done to continue.
```

Then press **RETURN**, followed by **Y** to test the new video mode.

```
Welcome to the MEGAB5!  
Before you go further, there are couple  
of things you need to do.  
Press F3 - F13 to set the time and date.  
Press Y  
Video Try video mode:  
PAL, Pure DVI  
(Will revert on fail after  
15 seconds.)  
Test (Y)es or (N)o?  
  
CRT Emulation: enabled  
C = toggle  
  
Time: 00:00:00 00/00/1900  
F3 F5 F4 F9 F11 F13  
  
Press RETURN when done to continue.
```

Press **K** to keep the new video mode.

```
Welcome to the MEGAB5!  
Before you go further, there are couple  
of things you need to do.  
Press F3 - F13 to set the time and date.  
Press K  
Video Press K to keep video mode.  
Timeout in 10 sec.  
Test  
  
CRT Emulation: enabled  
C = toggle  
  
Time: 00:00:00 00/00/1900  
F3 F5 F4 F9 F11 F13  
  
Press RETURN when done to continue.
```

Press **RETURN** to complete the configuration.

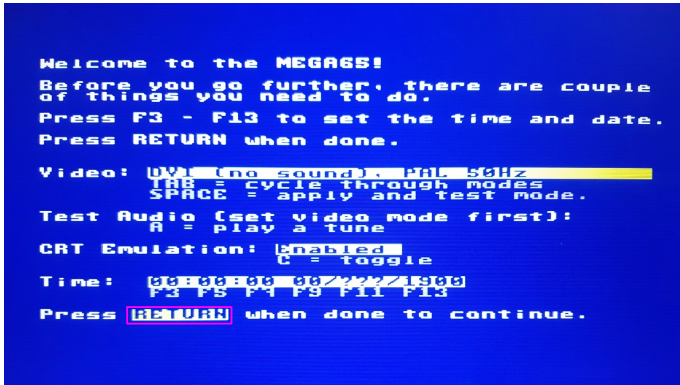

Note for Nexys4 board users:

At this very specific step, the board is supposed to reboot and display the main MEGA65 screen. If the board does not reboot and the screen remains black, then switch power to the board off then on again.

After the reboot you will get the main MEGA65 screen:



CONFIGURATION UTILITY

The configuration utility for the MEGA65 has a similar purpose to the BIOS on a PC, and allows you to control certain default behaviours of your MEGA65; however, rather than storing the configuration data in a battery-backed RAM, the MEGA65 stores this data on sector 1 of the SD card. If you switch SD cards, you will change the configuration data.

To enter the configuration utility, switch the MEGA65 on while holding  down. This will show the utility menu, similar to the following:



Now press the number corresponding to the Configure Menu. The MEGA65 Configuration Utility will launch, showing a display similar to the following:

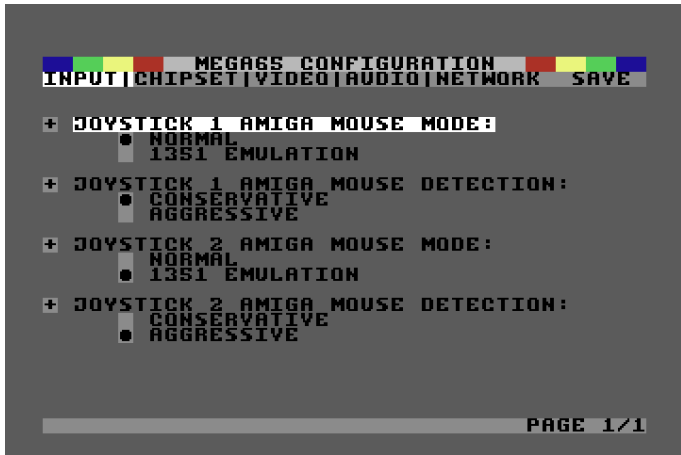

If your MEGA65's System Partition has become corrupt, you may be prompted to press **F14** to correct this, i.e., hold **SHIFT** and tap the **F13** key, with a display similar to the following:



To correct this error, press **F13**. Next, press **F7** to save the reset configuration, otherwise the reset data will not be saved to the MEGA65 System Partition.

Once you have dismissed that display, or if your MEGA65 System Partition was not corrupted, you can begin exploring and adjusting various settings. The program can be controlled using the keyboard, or optionally, an Amiga™ or C1351 mouse.

You can advance screens by pressing **F1**, or use **F2** to navigate in the opposite direction. Use the **←** and **→** keys to navigate between screens.

Use the **↑** and **↓** keys to select an item.

Press **RETURN** or **SPACE** to toggle a setting, or to change a text or numeric value. The black circle next to an option indicates the current selection.

When finished, you can press **F7** to see the option to save the changes. This will give you four options:

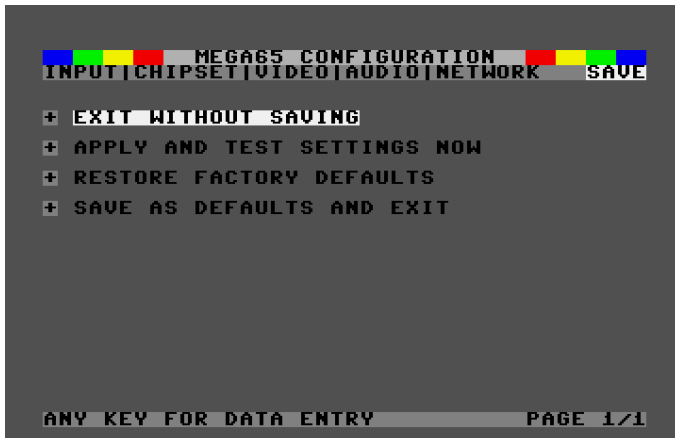

- *Exit Without Saving* abandons any changes made in the MEGA65 Configure utility and exits.
- *Apply and Test Settings Now* uses the current settings immediately but does not exit. This is helpful to test compatibility of your TV or monitor with PAL or NTSC video modes. If you still see your display after applying a change, it is safe to save those settings.
- *Restore Factory Defaults* resets the MEGA65 configuration settings to the factory defaults. It will randomly select a new MAC address for models that include an internal Ethernet adaptor. If you wish to commit these changes, you must still save them.
- *Save as Default and Exit* commits changes made to the SD card. These changes will be used when the MEGA65 is switched on.

Input Devices

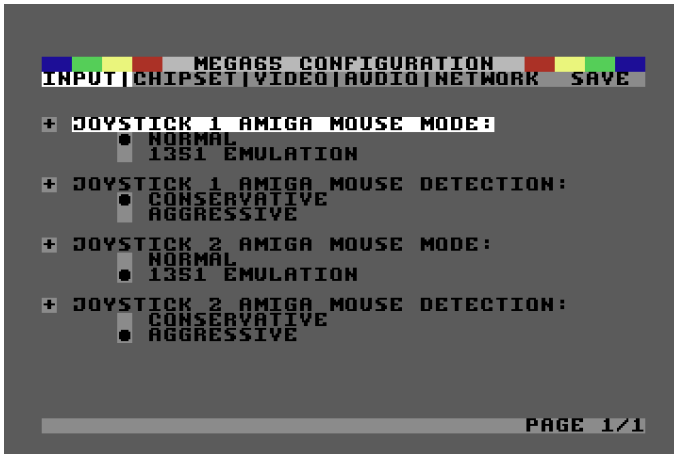

- *Joystick 1 Amiga Mouse Mode* allows either **normal** operation, where software will see it as an Amiga mouse or **1351 emulation** mode, where the MEGA65 translates the Amiga mouse's movements into 1351 compatible signals. This allows you to use an Amiga mouse with existing C64/C65 software compatible with a 1351 mouse.
- *Joystick 1 Amiga Mouse Detection* can be set to conservative or aggressive. If you use an Amiga mouse and it fails to move smoothly in all directions, you may set it to **aggressive**. Conversely, if you regularly use joysticks in the port, and have difficulties with the joystick input misbehaving, you may select the **conservative** option.
- *Joystick 2 Amiga Mouse Mode* is identical to the first option, but for the second joystick port. This allows you to have different settings for each port.
- *Joystick 2 Amiga Mouse Detection* similarly provides the ability to separately control the Amiga mouse detection algorithm for the second joystick port.

Chipset



- *Real-Time Clock* allows setting the MEGA65's Real-Time Clock for those models that include one. To set the clock or calendar, simply edit the field and press . The display does not change while viewing this page, but if you use the cursor left and right keys to select another page and return to this page, the values will update if a Real-Time Clock is fitted and functioning.
- *DMagic Revision* allows selecting the default mode of operation for the C65 DMagic DMA controller. This option is only required for ROMs not detected by the MEGA65's HYPP0 Hypervisor. If you see screen corruption in BASIC, try toggling this option.
- *F011 Disk Controller* This option allows you to select whether the internal 3.5" floppy drive functions using real diskettes, or whether it simply makes noises to add atmosphere when using D81 disk images from the SD card. This merely sets the default option, and you can change this setting, or select a different disk image for use as either or both of the C65 3.5" DOS based drives.
- *Default Disk Image* allows you to choose the D81 disk image used with the internal drive, if the F011 Disk Controller option above is set to use an SD card disk image.

Video

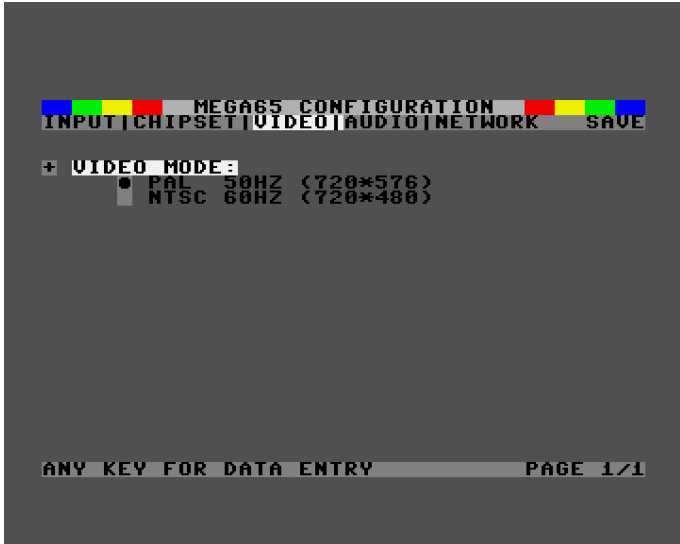

- *Video Mode* selects whether the MEGA65 starts in PAL or NTSC. The MEGA65 supports true 480p NTSC and 576p PAL double-scan modes, with exact 60Hz / 50Hz frame-rates. This setting sets the default value, and the system can be switched between PAL and NTSC via the Freeze Menu, or under software control by MEGA65-enabled programs.

Audio



- *Audio Output* selects whether the SIDs and digital audio channels are combined to provide a monaural signal or whether the left and right tagged audio sources are separated to provide a stereo signal. This setting can be changed in the Audio Mixer of the Freeze Menu, or under the control of MEGA65-enabled software.
- *Swap Stereo Channels* allows switching the left and right-hand sides of the stereo audio output. This is useful for software that expects left and right SIDs to be at swapped addresses compared with the MEGA65 defaults.
- *DAC Algorithm* allows selecting between two different digital to analog conversion algorithms. Both options sound good and the selection is a personal preference.
- *Audio Amplifier* allows enabling or disabling the audio amplifier contained in some models of the MEGA65. This option works for audio outputs, e.g., internal speaker or loud speaker.

Network

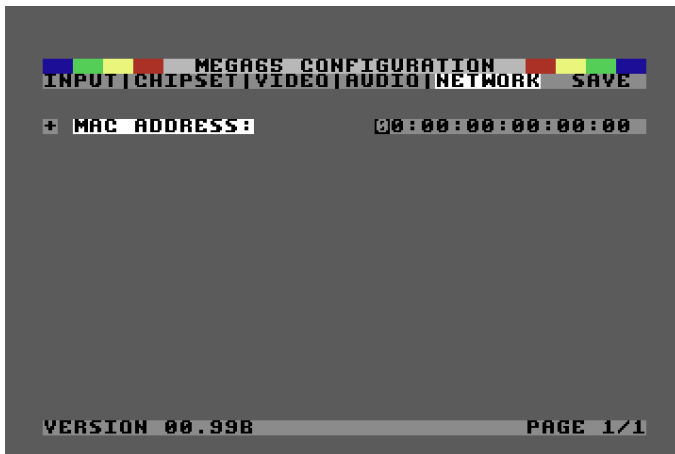

- *MAC Address* allows you to set the default MAC address of your MEGA65. This can be changed at run-time by MEGA65-enabled software.

CHAPTER 5

Cores and Flashing

- **What are cores, and why do they matter?**
- **Bitstream files**
- **Selecting a core**
- **Installing an upgrade core for the MEGA65**
- **Installing other cores**
- **Creating cores for the MEGA65**
- **Replacing the factory core in slot 0**
- **Understanding The Core Booting Process**

WHAT ARE CORES, AND WHY DO THEY MATTER?

The MEGA65 computer uses a versatile chip called an FPGA as its heart, which is an acronym for “Field Programmable Gate Array”. This is a fancy way of saying that FPGAs are chips that can be programmed *by you* to impersonate other chips. They do this by re-configuring their arrays of logic gates to reproduce the circuits of other chips. As a result, FPGAs are not an emulation, but a re-creation of other chips.

However, FPGAs forget what chip they are pretending to be whenever the power is turned off, or when they are re-programmed. This might sound annoying, but it’s actually very powerful. It means that you can tell the FPGA in the MEGA65 to impersonate not just the MEGA65 design as it currently stands, but to impersonate any improvements made to the design itself. In other words, you can upgrade the MEGA65 hardware just by providing a new set of instructions to the FPGA. These sets of instructions are called “cores”, or “bitstreams”. For the purpose of the MEGA65, these two terms are interchangeable.

FPGAs are so flexible that not only is it possible to teach the MEGA65 to be a better MEGA65, but it is also possible to teach the MEGA65 to be other interesting home computers. We believe that the FPGA is powerful enough to re-create a Commodore PET™, VIC-20™, Apple II™, Spectrum™, BBC Micro™, or even an Amiga™, or one of the 16-bit era game consoles. Unlike some previous FPGA-based retro-computers, the MEGA65, its FPGA instructions, board layout, and other information is all available for free under various open-source licenses. This means that anyone is free to create other cores for the MEGA65 hardware.

To top it all off, the MEGA65 has enough storage for 7 different sets of FPGA instructions, so that you can easily switch the MEGA65’s “personality” from being a MEGA65 to another system, and back again.

The remainder of this chapter describes how to select a core to run on the MEGA65, and how to store a core into one of the seven slots in the flash memory storage.

Model types

Retail models of the MEGA65 are referred to as the MEGA65R3A (revision 3A). Throughout the course of development of the MEGA65, there have been several other model variants used by developers, each with differing specifications and available core slots, so they will be listed here, just to raise awareness of them.

Model	FPGA type	QSPI size	#slots	slot size
MEGA65R3A	The retail/release version of the MEGA65			
	A200T	64MB	8	8MB
MEGA65R3	The DevKit model			
	A200T	32MB	4	8MB
MEGA65R2	An earlier MEGA65 model			
	A100T	32MB	8	4MB
Nexys4	FPGA development boards used early in the project			
	A100T	16MB	4	4MB

BITSTREAM FILES

Firstly, there are a variety of files related to the MEGA65's cores/bitstreams that you should be familiar with, in order to decide what file-types are needed for what occasion.

File types

File-type	Purpose
.cor	The MEGA65 project's custom bitstream file format, containing extra header information to help identify the bitstream and the specific MEGA65 target device it is intended for. The MEGA65's flashing utility makes use of this additional information to ensure you don't accidentally flash the bitstream of a different device.
.mcs	The bitstream file in a format needed when flashing it to your device's QSPI flash memory chip via Vivado®.
.prm	This file contains checksum information that can be used by Vivado to verify the .mcs file you have tried to flash. Optional.
.bit	A plain bitstream file that can be copied to your SD card.

Where to download

Visit the following url:

<https://files.mega65.org>

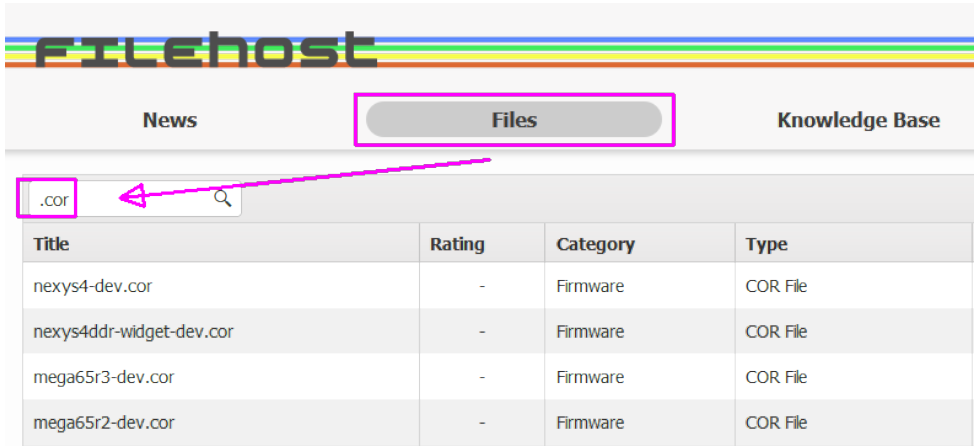

Click the 'Files' tab, and in the search-bar, type '.cor' and press Enter. For the purposes of this chapter on core-flashing, download the desired .cor file that suits your target device:

- **mega65r3-dev.cor** (for MEGA65R3 boards, both Release and DevKits)
- **mega65r2-dev.cor** (for MEGA65R2 boards)
- **nexys4ddr-widget-dev.cor** (for Nexys4 DDR boards)
- **nexys4-dev.cor** (for Nexys4 PSRAM boards)
- You can also find .bit, .mcs and .prm files located here too.

Alternatively, if you intend to flash the QSPI chip via Vivado, you would instead download the .mcs file for your target device (and optionally, the .prm files as well).

Another alternative for Nexys4 board users is to download .bit files and copy them to SD cards, which you can also download.

But once again, for the purposes of this chapter on core-flashing, you will only be interested in the .cor files.

SELECTING A CORE

To operate the MEGA65 with an alternate core, switch off the power to the MEGA65, and then hold **NO SCROLL** down while switching the power back on. This instructs the MEGA65 to enter the Flash and Core Menu, instead of booting normally. When booting like this, the following screen will appear:

```
(0) MEG65 FACTORY CORE
(1) EMPTY SLOT
(2) Pre-Series August 2019
    18
(3) MEG65 Unstable Branch
    20200303.19-UNSTAB-F37032F+dirt
(4) EMPTY SLOT
(5) HDMI Test Grid Display
    2000305.15-UNSTAB-SAG212F
(6) EMPTY SLOT
(7) EMPTY SLOT
0-9 = Launch Core. CTRL 1-9 = Edit Slot
```

To select a core and start it, use the cursor keys to highlight the desired core, and then press **RETURN**. If you select a flash slot that does not contain a valid core, it will be highlighted in red to indicate that it cannot be booted from:

```
(0) MEG65 FACTORY CORE
(1) EMPTY SLOT
(2) Pre-Series August 2019
    18
(3) MEG65 Unstable Branch
    20200303.19-UNSTAB-F37032F+dirt
(4) EMPTY SLOT
(5) HDMI Test Grid Display
    2000305.15-UNSTAB-SAG212F
(6) EMPTY SLOT
(7) EMPTY SLOT
0-9 = Launch Core. CTRL 1-9 = Edit Slot
```

Alternatively, you can press the number corresponding to the core you would like to use. The MEGA65 immediately reconfigures the FPGA, and launches the core. If for some reason the core is faulty, the MEGA65 may instead restart normally after a few seconds, and depending on the circumstances, take you back into the menu automatically.

The MEGA65 will keep running the new core until you physically power it off. Pressing the reset button will not reset which core is being run.

INSTALLING AN UPGRADE CORE FOR THE MEGA65

Installing and upgrading the core (from a .cor file) for the MEGA65 can be done in a few easy steps.

First, copy the core onto the MEGA65's SD card. You can do this by removing the SD card and copying a previously downloaded core file to it from another computer. Alternatively, you can insert an SD card that already contains the upgrade core. Finally, you can use the MEGA65 TFTP Server program and the MEGA65's Ethernet port to upload the core upgrade file onto the SD card from another computer on your local network.

The Flash Menu will use the external microSD slot over the internal SD card, so if you have both a microSD card and SD card inserted in your MEGA65, the Flash Menu will ignore the internal SD card. To avoid this, simply copy the core(s) from the internal SD card to the external microSD card, or temporarily remove the external microSD card from the rear of your MEGA65, so that the Flash Menu will be able to find the core files. Also note that the Flash Menu currently only supports DOS-style 8.3 character filenames in UPPERCASE. If your core files have a longer name, you will need to rename them when copying them onto your microSD or SD card.

Next, once you have the upgrade core on the MEGA65's SD card, enter the Flash and Core Menu as above, i.e., switch off the power, and hold **NO SCROLL** down while switching the power on again. When the Flash and Core Menu appears, hold **CTRL** down and press **1** (or **CTRL** and a different number, if you wish to replace the contents of a different flash slot). The MEGA65 will present you with a list of core files that are on the SD card:

```
-erase slot-
mega65r2.cor
hdmigrd.cor
preserie.cor

select flash file, then press return
or press run/stop to abort
```

Select the upgrade core file you wish to install using the cursor keys, and then press . The MEGA65 will then erase the flash slot, before writing the upgraded core. You will see a progress bar while the MEGA65 erases the flash slot:

```
Erasing flash slot...
sector at $00436000 erased.
```



The progress bar will then reset, and the MEGA65 will write the new core into the slot. This process can take up to 15 minutes, depending on the size of the core file. If you simply wish to erase a flash slot, you can select the “- erase slot -” option instead of a file name. This will then perform only the erasure part of the process.

It is important to not switch the power off during this process. If you do, the core file will be only partially installed, and the MEGA65 may not start properly. While inconvenient, it won't damage your MEGA65 or leave it in an unusable state: It will simply fall back to using the factory supplied core. If this happens, enter the Flash and Core Menu as described above, and follow the instructions again.

When the flashing process has completed, you will see a message indicating that the process is complete:

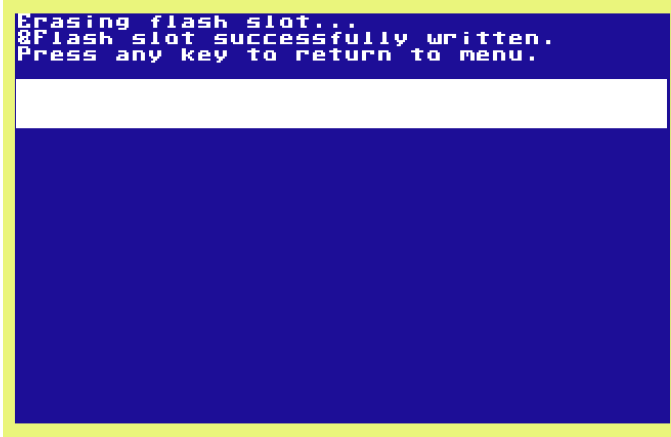
A screenshot of a terminal window with a dark blue background and white text. The text reads: "Erasing flash slot...
Flash slot successfully written.
Press any key to return to menu." Below the text is a white horizontal bar, and the rest of the terminal area is dark blue.

```
Erasing flash slot...
Flash slot successfully written.
Press any key to return to menu.
```

When this happens, simply switch off the power to the MEGA65 and switch it back on again for it to start using the upgraded core. This is because the MEGA65 will always try to start the core in slot 1 when it is powered on.

INSTALLING OTHER CORES

Installing other cores works very similarly to installing upgrade cores. The only difference is that you press **CTRL** and **2** to **7** from the Flash and Core Menu, so that the core gets installed to another slot.

Of course, there is nothing stopping you from installing a different core in slot 1, so that the MEGA65 behaves as a different type of computer when you switch it on. If you do this, you can always choose to run the MEGA65 core by entering the Flash and Core Menu, and selecting the MEGA65 core.

CREATING CORES FOR THE MEGA65

If you would like to create your own cores for the MEGA65, or help contribute to the MEGA65 core, then you may also wish to take a look at Chapter/Appendix S on page S-5, which explains how to use the FPGA development tools to flash the MEGA65.

REPLACING THE FACTORY CORE IN SLOT 0

Replacing the core in slot 0 is not recommended, because if it ever gets corrupted, it will “brick” the machine. This will require you to connect a TE-0790 JTAG programmer, by opening your MEGA65 case, installing the module, going through some rather convoluted software preparation steps (similar to if you were creating your own bistream/-core) and then restoring a working bitstream into the slot.

The MEGA65 is an open system though, so it’s possible for you to do all of this, but it’s very hard. There is a secret key-press combination in the Flash Menu that will then challenge you with a series of questions with increasing difficulty to ensure that you know what you are doing. Only after you have correctly answered these questions will you be given the option to erase and/or replace the contents of slot 0. Details of the questions asked are purposely not documented.

There really should be no reason for using this method to replace the contents of slot 0: If you want to make your own bitstreams/cores, you can either write them to other slots and use the Flash Menu to activate them, or you can simply use a TE-0790 JTAG programmer, and then use Vivado or other FPGA development tool to write to the flash directly. This method is also somewhat faster than flashing through the Flash Menu.

You have been warned!

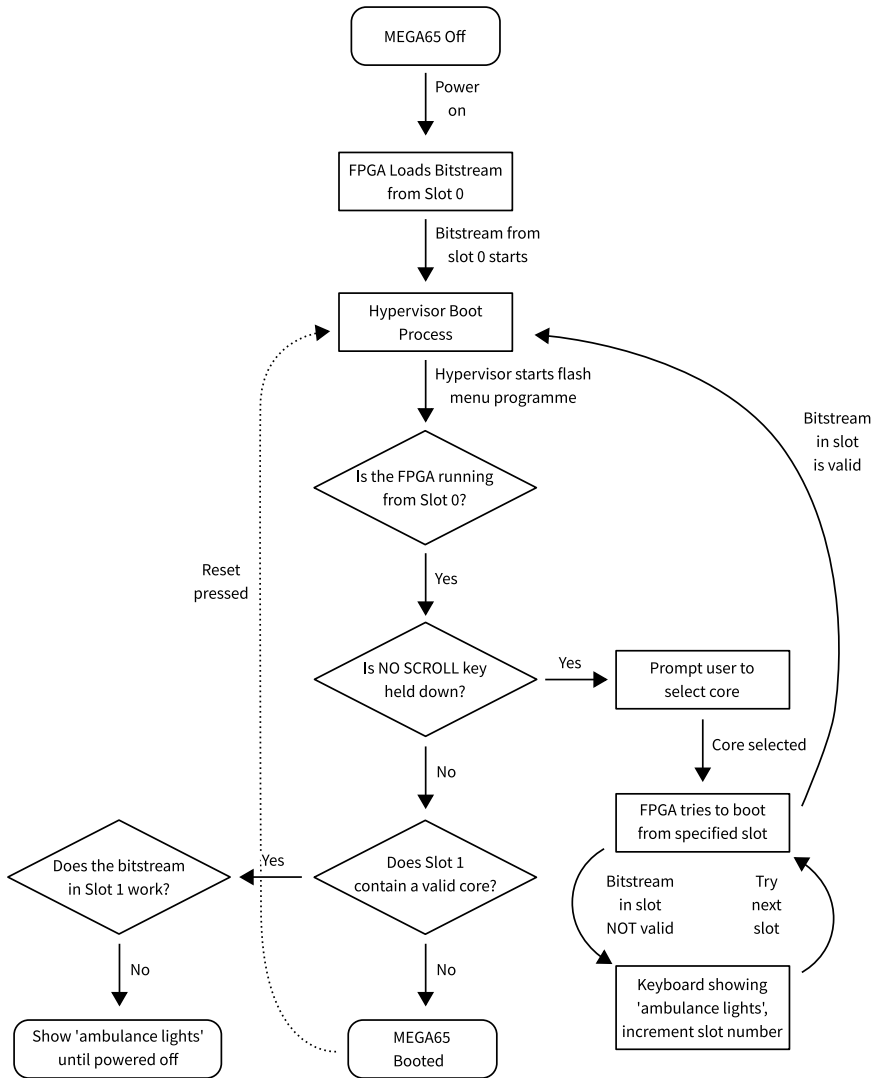

UNDERSTANDING THE CORE BOOTING PROCESS

This section summarises how the MEGA65 selects which core to start with when it is powered on. The process is shown in the following figure:



When the MEGA65 is powered on, it does the following:

- Starts the bitstream stored in slot 0 of flash memory. If that is the MEGA65 Factory Core, the MEGA65 HYPPO Hypervisor starts.

- If it is the first boot since power-on, HYPPO starts the Flash Menu program – but note that the Flash Menu in this mode may not show anything on the screen to indicate that it is running!
- The Flash Menu then checks if the system is booting from Flash Slot 0.
- If Flash Slot 0 is being used, it then checks if  is being held.
- If it is, the Flash Menu program shows its display, allowing you to select or re-flash a core.
- If  is not being pressed, the Flash Menu program checks if Flash Slot 1 contains a valid core.
- If it does, then the Flash Menu program attempts to start that core.
- If it succeeds, then the system reconfigures itself for that core, after which the behaviour of the system is according to that core.
- If it fails, the keyboard will go into “ambulance mode”, showing flashing blue lights to indicate that some first-aid is required. Note that in ambulance mode the reset button has no effect: You must switch the MEGA65 off and on again.

If you have selected a different core in the Flash Menu, the process is similar, except that the ambulance lights will appear for only a limited time, as the FPGA will automatically search through the flash memory until it finds a valid core. If it gets to the end of the flash memory, it will start the MEGA65 Factory Core from slot 0 again.

CHAPTER

6

Floppy Disks And D8 1 Images

- **Terminology**
- **The Freezer**



TERMINOLOGY

BASIC and **CBDOS** use following terminology:

UNIT is a device number in the range 0-31. The numbers from 0 to 11 are reserved for following device types:

unit #	device	comment
0	KEYBOARD	input
1	unused	was TAPE on C64
2	unused	was RS232 on C64
3	SCREEN	input/output
4-5	IEC PRINTER	output
6-7	IEC PLOTTER	output
8-9	CBDOS drives	floppy drive or disk image
10-11	IEC drives	1541, 1571, 1581, FD-2000

DRIVE is the drive number inside a **UNIT**.

device	drive numbers	comment
1581 IEC	0	single drive
1571 IEC	0	single drive
1541 IEC	0	single drive
FD-2000 IEC	0	single drive (CMD)
FD-4000 IEC	0	single drive (CMD)
SD2IEC	0	drive images

For all single drives the drive number is always 0. These are all known drives with an IEC interface, for example the CBM drives 1541, 1571, 1581 and the CMD drives FD-2000 and FD-4000. Also SD2IEC devices, which emulate a CBM drive using disk images on SD-card.

Dual disk drives like 4040, 8050, 8250 which use drive numbers 0 and 1 are equipped with the IEEE-488 interface and need an IEEE-488 to IEC converter to be used on the MEGA65.

The internal floppy controller of the MEGA65 can control two floppy drives (one internal and one external, both attached to the same ribbon cable). The **FREEZER** can be used to assign D81 images from the SD-card to the drive numbers 0 and/or 1, instead of physical floppy drives.

BASIC commands, that address files or disks, use therefore **U** for UNIT and **D** for drive. The default settings are **UNIT = 8** and **DRIVE = 0**.

THE FREEZER



The **freezer** is a tool for changing system parameters at any time regardless of the currently running program. The **freezer** is invoked by pressing  for approximately half to one second. The current status of the computer is frozen and the freezer menu, similar to the picture above, is displayed. Most options are self explaining or will be covered in detail in the online documentation. This chapter describes, how to assign disk images and the internal floppy disk drive.

The bottom/right region of the freezer screen shows the current assignments. The internal CBDOS (Computer Based Disk Operating System) can handle two 3.5" floppydrives or D81 images. Drive 0 can be either the internal floppy disk drive or a D81 disk image. Drive 1 can be either an external floppy disk drive (connected with the same ribbon cable as the internal drive) or a D81 disk image.

The typical configurations will probably be:

Drive 0 :internal floppy disk drive, drive 1: disk image

Drive 0 :disk image, drive 1: disk image

The assignment, and the mounting of disk images can be done by pressing  for drive 0 or  for drive 1.

The drive numbers are used internally by the CBDOS. BASIC and Kernal however address the storage devices by **UNIT** numbers. The CBDOS fakes two single drives for the operating system, by assigning separate unit numbers to drive 0 and drive 1. The default assignment is:

UNIT 8, DRIVE 0 :internal drive 0 (internal floppy or disk image)

UNIT 9, DRIVE 0 :internal drive 1 (external floppy or disk image)

Sometimes one wants to change this unit assignment, if for example a floppy drive 1541 is plugged in as unit 8 to the IEC port. Then the internal drive assignment can be switched to an alternative unit number, to avoid conflict.

8 toggles the unit assignment of drive 0 between 8 and 10.

9 toggles the unit assignment of drive 1 between 9 and 11.

After setting the preferences, the **freezer** can be exited with **F3**. The **freezer** restores the screen and returns to the interrupted program.

The drive and unit assignments are temporary and will be reset to default after power down or reset. For permanent settings use the **CONFIGURE** menu.

PART III

FIRST STEPS IN CODING

CHAPTER 7

How Computers Work

- **Computers are stupid. Really stupid**

Did you know that many computer experts and programmers learned how to use computers when they were still small children? Home computers only became common in the early 1980s. They were so new, that people would often write programs to do what they wanted to do, because no software existed to do the job for them.

It was also quite common for people working in all sorts of office jobs to learn how to program the computers they used for their jobs. For example, the people processing payroll for a company would often learn how to program the computer to calculate the everyone's pay!

Things have changed a lot since then, though. Now most people choose existing programs or apps to do what they need, and think that programming is a specialised skill that only some people have the ability to learn. But this isn't true. Of course, like every other field of pursuit everyone will be better at some things than others, whether it be sports, knitting, maths or writing. But almost everyone is able to learn enough to help them in their life.

We created the MEGA65, because we believe that YOU can learn to program, so that computers can be more useful to you, and as with learning any new skill, that you can have the satisfaction and enjoyment and new adventures that this brings!

COMPUTERS ARE STUPID. REALLY STUPID

How can this be so? Computers are able to do so many different things, often thousands of times faster than a person can. So how can we say that computers are stupid? The answer is that no computer can do anything that it hasn't been instructed by a person to do. Even the latest Artificial Intelligence systems were instructed how to learn (or how to learn, how to learn). To understand why this is so, it is helpful to understand how computers really work.

Making an Egg Cup Computer

The heart of a computer is its Central Processing Unit, or CPU for short. Many modern computers have more than one CPU, but let's keep things simple to begin with. The CPU has a set of simple instructions that it understands, like, "get the thing from cup #21," "put this thing into cup #403," "add these things together," or "do the following instruction, but only if the thing in cup #712 is the number 3."

But what do we mean with all of these "things" and "cups"? Let's start by thinking about how we could pretend to be a computer using just an empty egg carton, some small pieces of paper and a pencil or pen. Start by writing numbers, beginning with one, in

each of the little egg cups in the egg carton. Then write the number zero on a little scrap of paper and put it in the first cup. Do the same for the other cups. You should now have an egg carton with numbered cups, and with every cup having a scrap of paper with the number zero written on it. Now we just need to decide on a few simple rules that will explain how our egg-cup computer will work:

- First, each cup is allowed to hold exactly one thing at a time. Never more. Never less. This so that when we ask the question “what is in box such-and-such,” that there is a single clear answer. It’s also how computer memory works: Each piece of memory can hold only one thing at a time.
- Second, we need a way for the computer to know what to do next. On most computers this is called the Program Counter, or PC, for short (not to be confused with PC when people are talking about a Personal Computer). The PC is just the number of the next of the next memory location (or in our case, egg-cup), that the computer will examine, when deciding what to do next. You might like to have another piece of paper that you can use to write the PC number on as you go along.
- Third, we need to have a list of things that the egg-cup computer will do, based on what number is in the egg-cup indicated by the PC.

So let’s come up with the set of things that the computer can do, based on the number in the egg-cup indicated by the PC. We’ll keep things simple with just the following:

Number in the egg-cup	Action
0	i) Add one to the PC, and do nothing else.
1	i) Add one to the PC. ii) Set the PC to be the number stored in that egg-cup.
2	i) Add one to the PC. ii) Add the number in the egg-cup indicated by the PC to the number in the egg-cup indicated by the number in the egg-cup following that. iii) Put the answer in the egg-cup indicated by the egg-cup following that. iv) Finally, add two more to the PC, to skip over the egg-cups that we made use of.

Don’t worry if that sounds a bit confusing for now, specially that last one – we will go through it in detail very soon! The best way to explain it, is to go through some examples.

CHAPTER

8

Getting Started in BASIC

- **Your first BASIC programs**
- **First steps with text and numbers**
- **Making simple decisions**
- **Random numbers and chance**

It is possible to code on the MEGA65 in many languages, however most people start with BASIC. That makes sense, because BASIC stands for Beginner's All-purpose Symbolic Instruction Code: It was made for people like you to get started with in the world of coding!

A few short words before we dive in: BASIC is a programming language, and like spoken language it has conventions, grammar and vocabulary. Fortunately, it is much quicker and easier to learn than our complex human languages. But if you pay attention, you might notice some of these structures, and that can help you along your path in the world of coding.

If you haven't already read Chapter/Appendix 3 on page 3-3, it might be a good idea to do so. This will help you be able to more confidently interact with the MEGA65 computer.

It's also great to remember that if you really confuse the MEGA65, you can always get back to the READY. prompt by just pressing the reset button on the left-hand side of the keyboard, or if that doesn't help, then by turning it off and on again using the power switch on the left-hand side of the keyboard. You don't have to worry about shutting the computer down properly or any of that nonsense. The only thing to remember is that if you had any unsaved work, it will be lost when you switch the computer off and on again or press the reset button.

Finally, if you don't understand all of the descriptions and information with an example – don't worry! We have provided as much information as we can, so that it is there in case you have questions, encounter problems are just curious to discover more. Feel free to skip ahead to the examples and try things out, and then you can go back and re-read it when you are motivated to find something out, or help you work through a problem. And if you don't find the answer to your problem, send us a message! There are support forums for the MEGA65 at <https://mega65.net>, and you can report problems with this guide at:

<https://github.com/mega65/mega65-user-guide>

We hope you have as much fun learning to program the MEGA65 as we have had making it!

YOUR FIRST BASIC PROGRAMS

The MEGA65 was designed to be programmed! When you switch it on, it takes a couple of seconds to get its house in order, and then it quickly shows you a "READY." prompt and flashing block called the cursor. When the cursor is blinking, it tells you that the computer is waiting for input. The "READY." message tells you that the BASIC

programming language is running and ready for you to start programming. You don't even need to load any programs - you can just get started.

Try typing the following into the computer and see what happens:

```
HELLO COMPUTER
```

To do this, just type the letters as you see them above. The computer will already be in uppercase mode, so you don't need to hold **SHIFT** or **CAPS LOCK** down. When you have typed "HELLO COMPUTER", press **RETURN**. This tells the computer you want it to accept the line of input you have typed. When you do this, you should see a message something like the following:

```
THE COMMODORE C65 DEVELOPMENT SYSTEM
COPYRIGHT 1991 COMMODORE ELECTRONICS, LTD.
COPYRIGHT 1977 MICROSOFT
BASIC 10.0  V0.9B.911001  ALL RIGHTS RESERVED

ENGLISH KEYBOARD
NO EXPANSION RAM
C1565 DRIVE
ROM CHECKSUM $4BCF

READY.
HELLO COMPUTER
?SYNTAX ERROR
READY.
```

If you saw a **SYNTAX ERROR** message something like that one, then congratulations: You have succeeded in communicating with the computer! Error messages sound much nastier than they are. The MEGA65 uses them, especially the syntax error to tell you when it is having trouble understanding what you have typed, or what you have put in a program. They are nothing to be afraid of, and experienced programmers get them all the time.

In this case, the computer was confused because it doesn't understand the word "hello" or the word "computer". That is, it didn't know what you wanted it to do. In this regard, computers are quite stupid. They know only a few words, and aren't particularly imaginative about how they interpret them.

So let's try that again in a way that the computer will understand. Try typing the following in. You can just type it right away. It doesn't matter that the syntax error message can still be seen on the screen. The computer has already forgotten about that by the time it told you **READY**. again.

```
PRINT "HELLO COMPUTER"
```

Again, make sure you don't use shift or shift-lock while typing it in. The symbols around the words **HELLO COMPUTER** are double-quotes. If you are used to an Australian or American keyboard, you might discover that they double-quote key is in a rather different place to where you are used to: Double-quotes can be typed on the MEGA65 by holding down **SHIFT**, and then pressing **2**. Don't forget to press **RETURN** when you are done, so that the computer knows you want it to do something with your input.

If you make a mistake while typing, you can use **INST DEL** to rub out the mistake and fix it up. You can also use the cursor keys to move back and forth on the line while you edit the line you are typing, but there is a bit of a trick if you have already typed a double-quote: If you try to use the cursor keys, it will print a funny reversed symbol instead of moving the cursor. This is because the computer thinks you want to record moving the cursor in the text itself, which can be really useful and fun, and which you can read more about in Chapter/Appendix 3 on page 3-3. But for now, if you make a mistake just press **RETURN** and type the messed up line again.

Hopefully now you will see something like the following:

```
THE COMMODORE C65 DEVELOPMENT SYSTEM
COPYRIGHT 1991 COMMODORE ELECTRONICS, LTD.
COPYRIGHT 1977 MICROSOFT
BASIC 10.0  V0.9B.911001  ALL RIGHTS RESERVED

ENGLISH KEYBOARD
NO EXPANSION RAM
C1565 DRIVE
ROM CHECKSUM $4BCF

READY.
HELLO COMPUTER

SYNTAX ERROR
READY.
PRINT"HELLO COMPUTER"
HELLO COMPUTER

READY.
```

This time no new **SYNTAX ERROR** message should appear. But if some kind of error message has appeared, just try typing in the command again, after taking a close look to work out where the mistake might be.

Instead of an error, we should see **HELLO COMPUTER** repeated underneath the line you typed in. The reason this happened is that the computer does understand the word **PRINT**. It knows that whatever comes after the word **PRINT** should be printed to the screen. We had to put **HELLO COMPUTER** inside double-quotes to tell the computer that we want it to be printed literally.

If we hadn't put the double-quotes in, the computer would have thought that **HELLO COMPUTER** was the name of a stored piece of information. But because we haven't stored any piece of information in such a place, the computer will have zero there, so the computer will print the number zero. If the computer prints zero or some other number when you expected a message of some sort, this can be the reason.

You can try it, if you like, and you should see something like the following:

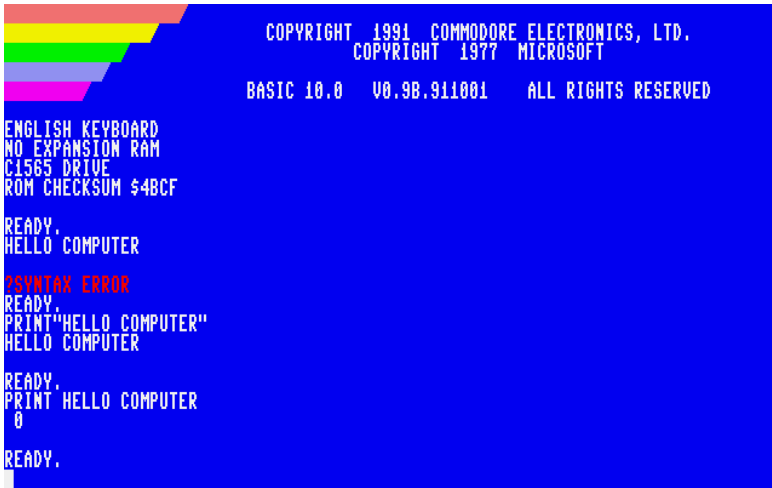

```
COPYRIGHT 1991 COMMODORE ELECTRONICS, LTD.  
COPYRIGHT 1977 MICROSOFT  
BASIC 10.0 V0.9B.911001 ALL RIGHTS RESERVED  
ENGLISH KEYBOARD  
NO EXPANSION RAM  
C1565 DRIVE  
ROM CHECKSUM $4BCF  
READY.  
HELLO COMPUTER  
?SYNTAX ERROR  
READY.  
PRINT"HELLO COMPUTER"  
HELLO COMPUTER  
READY.  
PRINT HELLO COMPUTER  
0  
READY.
```

In the above examples we typed commands in directly, and the computer executed them immediately after you pressed . This is why typing commands in this way is often called *direct mode* or *immediate mode*.

But we can also tell the computer to remember a list of commands to execute one after the other. This is done using the rather unimaginatively named *non-direct mode*. To use non-direct mode, we just put a number between 0 and 63999 at the start of the command. The computer will then remember that command. Unlike when we executed a direct-mode command, the computer doesn't print **READY.** again. Instead the cursor just reappears on the next line, ready for us to type in more commands.

Let's try that out with a simple little program. Type in the following three lines of input:

```
1 FOR I = 1 TO 10 STEP 1  
2 PRINT I  
3 NEXT I
```

When you have done this, the screen should show something like this:

```
THE COMMODORE C65 DEVELOPMENT SYSTEM
COPYRIGHT 1991 COMMODORE ELECTRONICS, LTD.
COPYRIGHT 1977 MICROSOFT
BASIC 10.0 V0.9B.911001 ALL RIGHTS RESERVED

ENGLISH KEYBOARD
NO EXPANSION RAM
C1565 DRIVE
ROM CHECKSUM $4BCF

READY,
1 FOR I = 1 TO 10 STEP 1
2 PRINT I
3 NEXT I
```

If it doesn't you can try again. Don't forget, if you feel that the computer is getting all muddled up, you can just press the reset button or flip the power switch off and on, at the left-hand side of the computer to reboot it. This only takes a couple of seconds, and doesn't hurt the MEGA65 in anyway.

We have told the computer to remember three commands, that is, **FOR I = 1 TO 10 STEP 1**, **PRINT I** and **NEXT I**. We have also told the computer which order we would like to run them in: The computer will start with the command with the lowest number, and execute each command that has the next higher number in turn, until it reaches the end of the list. So it's a bit like a reminder list for the computer. This is what we call a program, a bit like the program at a concert or the theatre, it tells us what is coming up, and in what order. So let's tell the computer to execute this program.

But first, let's try to guess what will happen. Let's start with the middle command, **PRINT I**. We've seen the **PRINT** command, and we know it tells the computer to print things to the screen. The thing it will try to print is **I**. Just like before, because there are no double-quotes around the **I**, it will try to print a piece of stored information. The piece of information it will try to print will be the piece associated with the thing **I**.

When we give a piece of information like this a name, we call it a *variable*. They are called variables because they can vary. That is, we can replace the piece of information associated with the variable called **I** with another piece of information. The old piece will be forgotten as a result. So if we gave a command like **LET I = 3**, this would replace whatever was stored in the variable called **I** with the number 3.

Back to our program, we now know that the 2nd command will try to print the piece of information stored in the variable **I**. So let's look at the first command: **FOR I = 1 TO 10 STEP 1**. Although we haven't seen the **FOR** command before, we can take a bit of a guess at how it works. It looks like it is going to put something into the variable **I**. That something seems to have something to do with the range of number 1 through 10, and a step or interval of 1. What do you think it will do?

If you guessed that it will put the values 1, 2, 3, 4, 5, 6, 7, 8, 9 and then 10 into the variable **I**, then you can give yourself a pat on the back, because that's exactly what it does. It also helps us to understand the 3rd command, **NEXT I**: That command tells the computer to put the next value into the variable **I**. And here is a little bit of magic: When the computer does that, it goes back up the list of commands, and continues again from the command after the **FOR** command.

So let's pull that together: When the computer executes the first command, it discovers that it has to put 10 different values into the variable **I**. It starts by putting the first value in there, which in this case will be the number 1. The computer then continues to the second command, which tells the computer to print the piece of information that is currently stored in the variable called **I**. That will be the number 1, since that was the last thing the computer was told to put there. Then the computer proceeds to the third command, which tells it that it is time to put the next value into the variable **I**. So the computer will throw away the number 1 that is currently in the variable **I**, and put the number 2 in there, since that is the next number in the list. It will then continue from the 2nd command, which will cause the computer to print out the contents of the variable **I** again. Except that this time **I** has had the number 2 stored in it most recently, so the computer will print the number 2. This process will repeat, until the computer has printed all ten values that the **FOR** command indicated it to do.

To see this in action, we need to tell the computer to execute the program of commands we typed in. We do this by using the **RUN** command. Because we want it to run the program immediately, we should use immediate mode (remember, this is another name for direct mode). So just type in the word **RUN** and press . You should then see a display that looks something like the following:

```
BASIC 10.0  00.98.911001  ALL RIGHTS RESERVED
ENGLISH KEYBOARD
NO EXPANSION RAM
C1565 DRIVE
ROM CHECKSUM $4BCF

READY.
1 FOR I = 1 TO 10 STEP 1
2 PRINT I
3 NEXT I
RUN
1
2
3
4
5
6
7
8
9
10
READY.
```

You might notice a couple of things here:

First, the computer has told us it is **READY.** again as soon as it finished running the program. This just makes it easier for us to know when we can start giving commands to the computer again.

Second, when the computer got to the bottom of the screen it automatically scrolled the display up to make space. This is quite normal. What is important to remember, is that the computer forgets everything that scrolls off the top. The only exception is if you have told the computer to remember a command by putting a number in front of it. So our program is quite safe for now. We can see that this is the case by typing the **RUN** command a couple more times: The program listing will have scrolled off the top of the screen, but we can still RUN the program, because the computer has remembered it. Give it a try! Did it work?

If you wish to see the program of remembered commands, you can use the **LIST** command. This commands causes the computer to display the remembered program of commands to the screen, like in the display here. If you would like to replace any of the commands in the program, you can type a new line that has the same number as the one you wish to change.

```
9
10
READY.
RUN
1
2
3
4
5
6
7
8
9
10
READY.
LIST
1 FOR I = 1 TO 10 STEP 1
2 PRINT I
3 NEXT I
READY.
```

For example, to print the results all on one line, we could modify the second line of the program to **PRINT I;** by typing the following line of input and pressing :

```
2 PRINT I;
```

You can make sure that the change has been remembered by running the **LIST** command again, as we can see here. You can then use the **RUN** command to run the modified program, like this:

```
7
8
9
10
READY.
LIST
1 FOR I = 1 TO 10 STEP 1
2 PRINT I
3 NEXT I
READY.
2 PRINT I;
LIST
1 FOR I = 1 TO 10 STEP 1
2 PRINT I;
3 NEXT I
READY.
RUN
1 2 3 4 5 6 7 8 9 10
READY.
```

It is quite easy to modify your programs in this way. As you become more comfortable with the process, there are two additional helpful tricks:

First, you can give the **LIST** command the number of a command, or line as they are referred to, and it will display only that line of the program. Alternatively, you can give a range separated by a minus sign to display only a section of the program, e.g., **LIST 1 - 2** to list the first two lines of our program.

Second, you can use the cursor keys to move the cursor to a line which has already been remembered and is displayed on the screen. If you modify what you see on the screen, and then press **RETURN** while the cursor is on that line, the BASIC interpreter will read in the modified line and replace the old version of it. It is important to note that if you modify multiple lines of the program at the same time, you must press **RETURN** on each line that has been modified. It is good practice to check that the program has been correctly modified. Use the **LIST** command again to achieve this.

Exercises to try

1. Can you make it count to a higher or lower number?

At the moment it counts from 1 to 10. Can you change it to count to 20 instead? Or to count from 3 to 17? Or how about from 14.5 to 21.5? What do you think you would need to reverse the order in which it counts?

Clue: You will need to modify the **FOR** command.

2. Can you change the counting step?

At the moment it counts by ones, i.e., each number is one more than the last. Can you change it to count by twos instead? Or by halves, so that it counts 1, 1.5, 2, 2.5, 3, ...?

Clue: You will need to modify the **STEP** clause of the **FOR** command.

3. Can you make it print out one of the times tables?

At the moment it prints the answers to the 1 times tables, because it counts by ones. Can you make it count by threes, and show the three times tables?

Clue: You will need to modify the **FOR** command.

4. Can you make it print out the times tables from 1×1 to 10×10 ?

Clue: You might like to use ; on the end of **PRINT** command, so that you can have more than one entry per line on the screen.

Clue: The **PRINT** command without any argument will just advance to the start of the next line.

Clue: You might need to have multiple **FOR** loops, one inside the other.

FIRST STEPS WITH TEXT AND NUMBERS

In the last section we started to use both numbers and text. Text on computers is made by stringing individual letters and other symbols together. For this reason they are called *strings*. We also call the individual letters and symbols *characters*. The name character comes from the printing industry where each of the symbols that can be printed on a page. For computers, it has much the same meaning, and the set of characters that a computer can display is rather unimaginatively called a *character set*.

When the MEGA65 expects some form of input, it is typically looking for one of four things:

1. a *keyword* like **PRINT** or **STEP**, which are words that have a special meaning to the computer;
2. a *variable name* like **I** or **A\$** that it will then use to either store or retrieve a piece of information;
3. a *number* like **42** or **-30.3137**; or
4. a *string* like **"HELLO COMPUTER"** or **"23 KILOMETRES"**.

Sometimes you have a choice of which sort of thing you can provide, while other times you have less choice. What sort of thing the computer will accept depends on what you are doing at the time. For example, in the previous section we discovered that when the computer tells us that it is **READY**, that we can give it a keyword or a number. Do you think that the computer will accept all four kinds of thing when it says **READY**.? We already know that keywords and numbers and keywords can be entered, but what about variable names or strings? Let's try typing in a variable name, say **N**, and pressing , and see what happens. And then lets try with a string, say **"THIS IS A STRING"**.



```
THE COMMODORE 65 DEVELOPMENT SYSTEM
COPYRIGHT 1991 COMMODORE ELECTRONICS, LTD.
COPYRIGHT 1977 MICROSOFT
BASIC 10.0  V0.9B.911001  ALL RIGHTS RESERVED

ENGLISH KEYBOARD
NO EXPANSION RAM
C1565 DRIVE
ROM CHECKSUM $4BCF

READY.
N

SYNTAX ERROR
READY.
"THIS IS A STRING"

SYNTAX ERROR
READY.

```

You should get a syntax error each time, telling you that the computer doesn't understand the input you have given it. Let's start with when you typed the variable: If you just tell the computer the name of a stored piece of information, it doesn't have the foggiest idea what you are wanting it to do. It's the same when you give it a piece of information, like a string, without telling the computer what to do with it.

But as we discovered in the last section, we can tell the computer that we want to see the piece of information that is stored in a variable using the **PRINT** command. So we could instead type in **PRINT N**, and the computer would know what to do, and will print the piece of information stored in the variable called **N**.

In fact, using the **PRINT** command is so common, that programmers got annoying having to type in the **PRINT** command all the time, that they made a short cut: If you type a question mark character, i.e., a **?**, the computer knows that you mean **PRINT**. So for example if you type **? N**, it will do the same as typing **PRINT N**. Of course, you have to press  after each command to tell the computer you want it to process what you typed. From here on, we will assume that you can remember to do that, without being reminded.

The `?` shortcut also works if you are telling the computer to remember a command as part of a program. So if you type `1 ? N`, and then `LIST`, you will see `1 PRINT N`, as we can see in the following screen-shot:

```
READY.  
N  
  
SYNTAX ERROR  
READY.  
"THIS IS A STRING"  
  
SYNTAX ERROR  
READY.  
PRINT N  
0  
  
READY.  
? N  
0  
  
READY.  
1 ? N  
LIST  
  
1 PRINT N  
READY.
```

Like we saw in the last section, the variable `N` has not had a value stored in it, so when the computer looks for what is there, it finds nothing. Because `N` is a *numeric variable*, when there is nothing there, this means zero. If it was a *string variable*, then it would have found literally nothing. We can try that, but first we have to explain how we tell the computer we are talking about a string variable. We do that by putting a dollar sign character, i.e., a `$`, on the end of the variable name. So if we put a `$` on the end of the variable name `N`, it will refer to a string variable called `N$`.

We can experiment with these variables by using the hopefully now familiar `PRINT` command (or the `?` shortcut) to see what is in the variables. But we need a convenient way to put values into them. Fortunately we aren't the first people to want to put values into variables, and so the `LET` exists. The `LET` command is used to put a value into a variable. For example, we can tell the computer:

```
LET N = 5.3
```

This tells the computer to put the value 5.3 into the variable **N**. We can then use the **PRINT** command to check that it worked. Similarly, we can put a value into the variable **N\$** with something like:

```
LET N$ = "THE KING OF THE POTATO PEOPLE"
```

If we try those, we will see something like the following:

```
? N
0
READY.
1 ? N
LIST
1 PRINT N
READY.
LET N = 5.3
READY.
? N
5.3
READY.
LET N$ = "THE KING OF THE POTATO PEOPLE"
READY.
? N$
THE KING OF THE POTATO PEOPLE
READY.
```

We mentioned just before that **N** is a numeric variable and that **N\$** is a string variable. This means that we can only put numbers into **N** and strings into **N\$**. If we try to put the wrong kind of information into a variable, the computer will tell us that we have mis-matched the kind of information with the place we are trying to put it by giving us a **TYPE MISMATCH ERROR** like this:

```
READY.  
LET N = 5.3  
  
READY.  
? N  
5.3  
  
READY.  
LET N$ = "THE KING OF THE POTATO PEOPLE"  
  
READY.  
? N$  
THE KING OF THE POTATO PEOPLE  
  
READY.  
LET N = "MR FLIBBLE"  
  
TYPE MISMATCH ERROR  
READY.  
LET N$ = 42  
  
TYPE MISMATCH ERROR  
READY.
```

This leads us to a rather important point: **N** and **N\$** are separate variables, even though they have similar names. This applies to all possible variable names: If the variable name has a **\$** character on the end, it means it is a string variable quite separate from the similarly named numeric variable. To use a bit of jargon, this means that each *type* of variable has their own separate *name spaces*.

(There are also four other variable name spaces that we haven't talked about yet: integer variables, identified by having a **%** character at the end of their name, e.g., **N%**, and arrays of numeric, string or integer variables. But don't worry about those for now. We'll talk about those a bit later on.)

So far we have only given values to variables in direct mode, or by using constructions like **FOR** loops. But we haven't seen how we can get information from the user when a program is running. One way that we can do this, is with the **INPUT** command.

INPUT is quite easy to use: We just have to say which variable we would like the input to go into. For example, to tell the computer to ask for the user to provide something to put into the variable **A\$**, we could use something like **INPUT A\$**. The only trick with the **INPUT** command is that it cannot be used in direct mode. If you try it, the computer will tell you **ILLEGAL DIRECT ERROR**. Try it, and you should see something like the following



This means that the **INPUT** command can only be used as part of a program. So we can instead do something like the following:

```
1 INPUT A$
2 PRINT "YOU TYPED "; A$
RUN
```

What do you think that this will do? The first line will ask the computer for something to put into the variable **A\$**, and the second line will print the string **"YOU TYPED"**, followed by what the **INPUT** command read from the user. Let's try it out:

```
THE COMMODORE C65 DEVELOPMENT SYSTEM
COPYRIGHT 1991 COMMODORE ELECTRONICS, LTD.
COPYRIGHT 1977 MICROSOFT
BASIC 10.0 V0.9B.911001 ALL RIGHTS RESERVED

ENGLISH KEYBOARD
NO EXPANSION RAM
C1565 DRIVE
ROM CHECKSUM $4BCF

READY,
INPUT A$

ILLEGAL DIRECT ERROR
READY,
1 INPUT A$
2 PRINT "YOU TYPED "; A$
RUN
? █
```

Did you expect that to happen? What is this question mark doing there? The **?** here is the computer's way of telling you that a program is waiting for some input from you. This means that the computer uses the same symbol, **?**, to mean two different things: If you type it as part of a program or in direct mode, then it is a short-cut for the **PRINT** command. That's when you type it. But if the computer shows it to you, it has this other meaning, that the computer is waiting for you to type something in. There is also a third way that the computer uses the **?** character. Have you noticed what it is? It is to indicate the start of an error message. For example, a Syntax Error is indicated by **?SYNTAX ERROR**. When a character or something has different meanings in different situations or contexts, we say that it is *context dependent*.

But returning to our example, if we now type something in, and press  to tell the computer that you are done, the program will continue, like this:

```
THE COMMODORE C65 DEVELOPMENT SYSTEM
COPYRIGHT 1991 COMMODORE ELECTRONICS, LTD.
COPYRIGHT 1977 MICROSOFT
BASIC 10.0  V0.9B.911001  ALL RIGHTS RESERVED

ENGLISH KEYBOARD
NO EXPANSION RAM
C1565 DRIVE
ROM CHECKSUM $4BCF

READY.
INPUT A$

ILLEGAL DIRECT ERROR
READY.
1 INPUT A$
2 PRINT "YOU TYPED "; A$
RUN
? LIGHT SABRE
YOU TYPED LIGHT SABRE

READY.
```

Of course, we didn't really know what to type in, because the program didn't give any hints to the user as to what the programmer wanted them to do. So we should try to provide some instructions. For example, if we wanted the user to type their name, we could print a message asking them to type their name, like this:

```
1 PRINT "WHAT IS YOUR NAME"
2 INPUT A$
3 PRINT "HELLO "; A$
```

Now if we run this program, the user will get a clue as to what we expect them to do, and the whole experience will make a lot more sense for them:

```
ROM CHECKSUM $48CF
READY.
INPUT A$
? ILLEGAL DIRECT ERROR
READY.
1 INPUT A$
2 PRINT "YOU TYPED "; A$
RUN
? LIGHT SABRE
YOU TYPED LIGHT SABRE

READY.
1 PRINT "WHAT IS YOUR NAME"
2 INPUT A$
3 PRINT "HELLO "; A$
RUN
WHAT IS YOUR NAME
? LISTER
HELLO LISTER

READY.
```

When we run the program, we first see the **WHAT IS YOUR NAME** message from line 1. The computer doesn't print the double-quote symbols, because they only told the computer that the piece of information between them is a string. The string itself is only the part in between.

After this we see the **?** character again and the blinking cursor telling us that the computer is waiting for some input from us. The rest of the programmed is *blocked* from continuing until it we type the piece of information. Once we type the piece of input, the computer stores it into the variable **A\$**, and can continue. Thus when it reaches line 3 of the program, it has everything it needs, and prints out both the **HELLO** message, as well as the information stored in the variable called **A\$**.

Notice that the word **LISTER** doesn't appear anywhere in the program. It exists only in the variable. This ability to process information that is not part of a program is one of the things that makes computer programs so powerful and able to be used for so many purposes. All we have to do is to change the input, and we can get different output.

For example, with our program we run it again and again, and give it different input each time, and the program will adapt its output to what we type. Pretty nifty, right? Let's have the rest of the crew try it out:

```
WHAT IS YOUR NAME
? LISTER
HELLO LISTER

READY.
RUN
WHAT IS YOUR NAME
? HOLLY
HELLO HOLLY

READY.
RUN
WHAT IS YOUR NAME
? KRYTON
HELLO KRYTON

READY.
RUN
WHAT IS YOUR NAME
? RIMMER, BSC
?EXTRA IGNORED
HELLO RIMMER

READY.
```

We can see that each time the program prints out the message customised with the input that you typed in...Until we get to **RIMMER, BSC**. As always, Mr. Rimmer is causing trouble. In this case, he couldn't resist putting his Bronze Swimming Certificate qualification on the end of his name.

We see that the computer has given us a kind of error message, **?EXTRA IGNORED**. The error is not written in red, and doesn't have the word **ERROR** on the end. This means that it is a warning, rather than an error. Because it is only a warning, the program continues. But something has happened: The computer has ignored Mr. Rimmer's **BSC**, that is, it has ignored the extra input. This is because the **INPUT** command doesn't really read a whole line of input. Rather, it reads *one piece of information*. The **INPUT** command thinks that a piece of information ends at the end of a line of input, or when it encounters a comma (,) or colon (:) character.

If you want to include one of those symbols, you need to surround the whole piece of information in double-quotes. So, if Mr. Rimmer had read this guide instead of obsessing over the Space Core Directives, he would have known to type **"RIMMER, BSC"** (complete with the double-quotes), to have the program run correctly. It is important that the quotes go around the whole piece of information, as otherwise the computer will think that the first quote marks the start of a new piece of information. We can see the difference it makes below:

```
LIST
1 PRINT "WHAT IS YOUR NAME"
2 INPUT A$
3 PRINT "HELLO "; A$

READY.
RUN
WHAT IS YOUR NAME
? "RIMMER, BSC"
HELLO RIMMER, BSC

READY.
RUN
WHAT IS YOUR NAME
? RIMMER" " BSC
?EXTRA IGNORED
HELLO RIMMER"

READY.
```

While this can all be a bit annoying at times, it has a purpose: The **INPUT** command can be used to read more than one piece of information. We do this by putting more than one variable after the **INPUT** command, each separated by a comma. The **INPUT** command will then expect multiple pieces of information. For example, we could ask for someone's name and age, with a program like this:

```
1 PRINT "WHAT IS YOUR NAME AND AGE"
2 INPUT A$, A
3 PRINT "HELLO "; A$
4 PRINT "YOU ARE"; A; " YEARS OLD."
```

If we run this program, we can provide the two pieces of information on the one line when the computer presents us with the ? prompt, for example **LISTER, 3000000**. Note the comma that separates the two pieces of information, **LISTER** and **3000000**. It's also worth noticing that we haven't put any thousands separators into the number 3,000,000. If we did, the computer would think we meant three separate pieces of information, **3, 000** and **000**, which is not what we meant. So let's see what it looks like when we give **LISTER, 3000000** as input to the program:

```
READY.  
RUN  
WHAT IS YOUR NAME  
? RIMMER, " BSC  
?EXTRA IGNORED  
HELLO RIMMER"  
  
READY.  
LIST  
  
1 PRINT "WHAT IS YOUR NAME AND AGE"  
2 INPUT A$,A  
3 PRINT "HELLO "; A$  
4 PRINT "YOU ARE"; A; " YEARS OLD."  
READY.  
  
RUN  
WHAT IS YOUR NAME AND AGE  
? LISTER, 3000000  
HELLO LISTER  
YOU ARE 3000000 YEARS OLD.  
  
READY.
```

In this case, the **INPUT** command reads the two pieces of information, and places the first into the variable **A\$**, and the second into the variable **A**. When the program reaches line 3 it prints **HELLO** followed by the first piece of information. Then when it gets to line 4, it prints the string **YOU ARE**, followed by the contents of the variable **A**, which is the number 3,000,000, and finally the string **YEARS OLD**.

It's also possible to just give one piece of information at a time. In that case, the **INPUT** command will ask for the second piece of information with a double question-mark prompt, i.e., **??**. Once it has the second piece of information. (If we had more than two variables on the **INPUT** command, it will still present the same **??** prompt, rather than printing more and more question-marks.)

So if we try this with our program, we can see this ? and ?? prompts, and how the first piece of information ends up in **A\$** because it is the first variable in the **INPUT** command. The second piece of information ends up in **A** because **A** is the second variable after the **INPUT** command. Here's how it looks if we give this input to our program:

```
READY.  
LIST  
1 PRINT "WHAT IS YOUR NAME AND AGE"  
2 INPUT A$,A  
3 PRINT "HELLO "; A$  
4 PRINT "YOU ARE"; A; " YEARS OLD."  
READY.  
  
RUN  
WHAT IS YOUR NAME AND AGE  
? LISTER, 3000000  
HELLO LISTER  
YOU ARE 3000000 YEARS OLD.  
  
READY.  
RUN  
WHAT IS YOUR NAME AND AGE  
? LISTER  
?? 3000000  
HELLO LISTER  
YOU ARE 3000000 YEARS OLD.  
  
READY.
```

Until now we have been asking the user to input information by using a **PRINT** command to display the message, and then an **INPUT** command to tell the computer which variables we would like to have some information input into. But, like with the **PRINT** command, this is something that happens often enough, that there is a shortcut for it. It also has the advantage that it looks nicer when running, and makes the program a little shorter. The short cut is to put the message to show after the **INPUT** command, but before the first variable.

We can change our program to use this approach. First, we can change line 3 to include the prompt after the **INPUT** command. We can do this one of two ways: First, we could just type in a new line 3. The computer will automatically replace the old line 3 with the new one.

But, as we have mentioned a few times now, programmers are lazy beasts, and so there is a short-cut: If you can see the line on the screen that you want to change, you can use the cursor keys to navigate to that line, edit it on the screen, and then press

 to tell the computer to accept the new version of the line.

Either way, you can check that the changes succeeded by typing the **LIST** command on any line of the screen that is blank. This will show the revised version of the program. For example:

```
LIST
1 PRINT "WHAT IS YOUR NAME AND AGE"
2 INPUT A$,A,B
3 PRINT "HELLO "; A$
4 PRINT "YOU ARE"; A; " YEARS OLD."

READY.
2 INPUT "WHAT IS YOUR NAME AND AGE",A$,A
LIST

1 PRINT "WHAT IS YOUR NAME AND AGE"
2 INPUT "WHAT IS YOUR NAME AND AGE",A$,A
3 PRINT "HELLO "; A$
4 PRINT "YOU ARE"; A; " YEARS OLD."

READY.
```

We still have a little problem, though: Line 1 will print the message **WHAT IS YOUR NAME AND AGE**, and then Line 2 will print it again! We only want the message to appear once. Thus we would like to change line 1 so that it doesn't do this any more. Because there is no other command on line 1 that we want to keep, that line can just become empty. So we can type in something like this:

```
1
```

We can confirm that the contents of the line have been deleted by running the **LIST** command again, like this:

```
1 PRINT "WHAT IS YOUR NAME AND AGE"
2 INPUT A$,A,B
3 PRINT "HELLO "; A$
4 PRINT "YOU ARE"; A; " YEARS OLD."

READY.
2 INPUT "WHAT IS YOUR NAME AND AGE",A$,A
LIST

1 PRINT "WHAT IS YOUR NAME AND AGE"
2 INPUT "WHAT IS YOUR NAME AND AGE",A$,A
3 PRINT "HELLO "; A$
4 PRINT "YOU ARE"; A; " YEARS OLD."

READY.
1
LIST

2 INPUT "WHAT IS YOUR NAME AND AGE",A$,A
3 PRINT "HELLO "; A$
4 PRINT "YOU ARE"; A; " YEARS OLD."

READY.
```

Did you notice something interesting? When we told the computer to make line 1 of the program empty, it deleted it completely! That's because the computer thinks that an empty line is of no use. It also makes sure that your programs don't get all cluttered up with empty lines if you make lots of changes to your programs.

It is also possible to DELETE a range of lines. For example (but don't do this now), you could delete lines 3-4 with:

```
DELETE 3-4
```

You can read more about the DELETE command in the BASIC 65 Command Reference.

With that out the way, let's run our program and see what happens. As usual, just type in the **RUN** command and press . You should see something like this:

```
1 PRINT "WHAT IS YOUR NAME AND AGE"
2 INPUT A$,A,B
3 PRINT "HELLO "; A$
4 PRINT "YOU ARE"; A; " YEARS OLD."

READY.
2 INPUT "WHAT IS YOUR NAME AND AGE",A$,A
LIST

1 PRINT "WHAT IS YOUR NAME AND AGE"
2 INPUT "WHAT IS YOUR NAME AND AGE",A$,A
3 PRINT "HELLO "; A$
4 PRINT "YOU ARE"; A; " YEARS OLD."

READY.
1
LIST

2 INPUT "WHAT IS YOUR NAME AND AGE",A$,A
3 PRINT "HELLO "; A$
4 PRINT "YOU ARE"; A; " YEARS OLD."

READY.
RUN
WHAT IS YOUR NAME AND AGE
```

We can see our prompt of **WHAT IS YOUR NAME AND AGE** there, but now the cursor is appearing without any ? character. This is because we put a comma (,) after the message in the **INPUT** command. To get the question mark, we have to instead put a semi-colon (;) after the message, like this:

```
INPUT "WHAT IS YOU NAME AND AGE"; A$, A
```

Now if we run the program, we should see what we are looking for:

```
LIST
2 INPUT "WHAT IS YOUR NAME AND AGE";A$,A
3 PRINT "HELLO ", A$
4 PRINT "YOU ARE"; A; " YEARS OLD."

READY.
RUN
WHAT IS YOUR NAME AND AGE? LISTER,3000000
HELLO LISTER
YOU ARE 3000000 YEARS OLD.

READY.
█
```

Exercises to try

1. Can you make the program ask someone for their name, and then for their favourite colour?

At the moment it asks for their name and age. Can you change the program so that it reports on their favourite colour instead of their age?

Clue: What type of information is age? Is it numeric or a string? Is it the same type of information as the name of a colour?

2. Can you write a program that asks someone for their name, prints the hello message, and then asks for their age and prints out that response?

At the moment, the program expects both pieces of information at the same time. This means the program can't print a message about the first message until after it has both pieces of information. Change the program so that you can have an interaction like the following instead:

```
WHAT IS YOUR NAME? DEEP THOUGHT
HELLO DEEP THOUGHT
WHAT IS THE ANSWER? 42
YOU SAID THE ANSWER IS 42
```

Clue: You will need more lines in your program, so that you can have more than one **INPUT** and **PRINT** command.

3. Can you write a program that asks several questions, and then prints out the list of answers given?

Think of several questions you would like to be able to ask someone, and then write a program that asks them, and remembers the answers and prints them out with an appropriate message. For example, running your program could look like this:

```
WHAT IS YOUR NAME? FRODO
HOW OLD ARE YOU? 33
WHAT IS YOUR FAVOURITE FOOD? EVERYTHING!
THANK YOU FOR ANSWERING.
YOUR NAME IS FRODO
YOU ARE 33 YEARS OLD
YOU FAVOURITE FOOD IS EVERYTHING!
```

Clue: You will need more lines in your program, to have the various **INPUT** and **PRINT** commands.

Clue: You will need to think carefully about which variable names you will use.

MAKING SIMPLE DECISIONS

In the previous section we have learnt how to input text and numeric data, and how to display it. However, the programs have just followed the lines of instruction in order, without any way to decide what to do, based on what has been input.

In this section we will see how we can take simple decisions using the **IF** and **THEN** commands. The **IF** command checks if something is true or false, and if it is true, causes the computer to execute the command that comes after the **THEN** command.

The way the computer decides whether something is true or false is that it operates on the supplied information using one of several symbols. These symbols are thus called *operators*. Also, because they compare two things, they depend on the relationship of the things. For this reason they are called *relational* operators. They include the following:

- Equals (=). For example, $3 = 3$ would be true, while $3 = 2$ would be false.
- Less than (<). For example, $1 < 3$ would be true, while both $3 < 3$ and $1 < 3$ would be false.
- Greater than (>). For example, $3 > 1$ would be true, while both $3 > 3$ and $1 > 3$ would be false.

As it is common to want to consider when something might be equal or greater than, or equal or less than, there are short cuts for this. Similarly, if you wish to test if something is not equal to something else, there is a relational operator for this, too:

- Unequal, which we normally say as *not equal* (\neq). This is different to the mathematical symbol for not equal, \neq , because the MEGA65's character set does not include a character that looks like that. So the programmers who created BASIC for the MEGA65 used the greater than and less than signs together to mean either less than or greater than, that is, not equal to. For example, $1 \neq 3$ would be true, while $3 \neq 3$ would be false.
- Less than or equal to (\leq). For example, $1 \leq 3$ and $3 \leq 3$ would be true, while both $4 \leq 3$ would be false.
- Greater than or equal to (\geq). For example, $3 \geq 1$ and $3 \geq 3$ would be true, while both $1 \geq 3$ would be false.

A good trick if you have trouble remembering which way the (\leq) and (\geq) signs go, the side with more ends of lines is the one that needs to have more. For example, the (\leq) symbol has one point on the left, but two ends of lines on the right-hand side. So for something to be true with (\leq), the number on the left-hand side needs to be less than the number on the right-hand side. This trick even works for the equals sign, ($=$), because it has the same number of ends on both sides, so you can remember that the numbers on both sides need to be equal. It also works when you have two symbols together, like (\geq), it is true if the condition is true for any of the symbols in it. So in this case the (\geq) symbol has more ends on the left than the right, so if the number on the left is bigger than the number on the right, it will be true. But also because the ($=$) symbol has two ends on each side, it will be true if the two numbers are the same.

Using these relational operators, we can write a line that will do something, but only if something is true or false. Let's try this out, with a few examples:

```
IF -2 < 0 THEN PRINT "-2 IS A NEGATIVE NUMBER"  
IF 2 < 0 THEN PRINT "2 IS A NEGATIVE NUMBER"  
IF 0 < -2 THEN PRINT "-2 IS A POSITIVE NUMBER"  
IF 0 < 2 THEN PRINT "2 IS A POSITIVE NUMBER"
```

These commands work fine in direct mode, so you can just type them directly into the computer to see what they will do. This can be handy for testing whether you have the logic correct when planning an **IF - THEN** command. If you type in those commands, you should see something like the following:

```
                                COPYRIGHT 1977 MICROSOFT
                                BASIC 10.0   V0.9B.911001   ALL RIGHTS RESERVED

ENGLISH KEYBOARD
NO EXPANSION RAM
C1565 DRIVE
ROM CHECKSUM $4BCF

READY.
IF -2 < 0 THEN PRINT "-2 IS A NEGATIVE NUMBER"
-2 IS A NEGATIVE NUMBER

READY.
IF 2 < 0 THEN PRINT "2 IS A NEGATIVE NUMBER"

READY.
IF 0 < -2 THEN PRINT "-2 IS A POSITIVE NUMBER"

READY.
IF 0 < 2 THEN PRINT "2 IS A POSITIVE NUMBER"
2 IS A POSITIVE NUMBER

READY.
```

We can see that only the **PRINT** commands that followed an **IF** command that has a true value were executed. The rest were silently ignored by the computer. But we can of course include these into a program. So let's make a little program that will ask for two numbers, and say whether they are equal, or if one is greater or less than the other. Before you have a look at the program, have a think about how you might do it, and see if you can figure it out. The clue I will give you, is that the **IF** command also accepts the name of a variables, not just numbers. So you can do something like **IF A > B THEN PRINT "SOMETHING"**. The program will be on the next page, to stop you peeking before you have a think about it!

Did you have a go? There are lots of different ways it could be done, but here is what I came up with:

```
1 INPUT "WHAT IS THE FIRST NUMBER"; A
2 INPUT "WHAT IS THE SECOND NUMBER"; B
3 IF A = B THEN PRINT "THE NUMBERS ARE EQUAL"
4 IF A > B THEN PRINT "THE FIRST NUMBER IS BIGGER"
5 IF B > A THEN PRINT "THE SECOND NUMBER IS BIGGER"
```

We can then run the program as often as we like, and the computer can tell us which of the two numbers we give it is biggest, or if they are equal:

```
1 INPUT "WHAT IS THE FIRST NUMBER";A
2 INPUT "WHAT IS THE SECOND NUMBER";B
3 IF A = B THEN PRINT "THE NUMBERS ARE EQUAL"
4 IF A > B THEN PRINT "THE FIRST NUMBER IS BIGGER"
5 IF B > A THEN PRINT "THE SECOND NUMBER IS BIGGER"

RUN
WHAT IS THE FIRST NUMBER? 2
WHAT IS THE SECOND NUMBER? 2
THE NUMBERS ARE EQUAL

READY.
RUN
WHAT IS THE FIRST NUMBER? 3
WHAT IS THE SECOND NUMBER? 4
THE SECOND NUMBER IS BIGGER

READY.
RUN
WHAT IS THE FIRST NUMBER? 10
WHAT IS THE SECOND NUMBER? 2
THE FIRST NUMBER IS BIGGER

READY.
```

Notice how in this program, we didn't use fixed numbers in the **IF** command, but instead gave variable names instead. This is one of the very powerful things in computer programming, together with being able to make decision based on data. By being able to refer to data by name, regardless of its current value or how it got there, lets the programmer create very flexible programs.

Let's think about a bit of a more interesting example: a "guess the number" game. For this, we need to have a number that someone has to guess, and then we need to accept guesses, and indicate whether the guess was correct or not. If the guess is incorrect, we should tell the user if the correct number is higher or lower.

We have already learned most the ingredients to make such a program: We can use **LET** to set a variable to the secret number, **INPUT** to prompt the user for their guess, and then **IF**, **THEN** and **PRINT** to tell the user whether their guess was correct or not. So let's make something. Again, if you like, stop and think and experiment for a few minutes to see if you can make such a program yourself.

Here is how I have done it. But don't worry if you have done it in a quite different way: There are often many ways to write a program to perform a particular task.

```
1 SN=23
2 PRINT "GUESS THE NUMBER BETWEEN 1 AND 100"
3 INPUT "WHAT IS YOUR GUESS"; G
4 IF G<SN THEN PRINT "MY NUMBER IS BIGGER"
5 IF G>SN THEN PRINT "MY NUMBER IS SMALLER"
6 IF G=SN THEN PRINT "CONGRATULATIONS! YOU GUESSED MY NUMBER!"
```

The first line puts our secret number into the variable **SN**. The second line prints a message telling the user what they are supposed to do. The third line asks the user for their guess, and puts it into the variable **G**. The fourth, fifth and sixth lines then check whether the guess is correct or not, and if not, which message it should print. This is done by using the **IF** command and an appropriate relative operator to make each decision. This works well, to a point. For example:

```
LIST
1 SN=23
2 PRINT "GUESS THE NUMBER BETWEEN 1 AND 100"
3 INPUT "WHAT IS YOUR GUESS";G
4 IF G<SN THEN PRINT "MY NUMBER IS BIGGER"
5 IF G>SN THEN PRINT "MY NUMBER IS SMALLER"
6 IF G=SN THEN PRINT "CONGRATULATIONS! YOU GUESSED MY NUMBER!"

READY.
RUN
GUESS THE NUMBER BETWEEN 1 AND 100
WHAT IS YOUR GUESS? 10
MY NUMBER IS BIGGER

READY.
RUN
GUESS THE NUMBER BETWEEN 1 AND 100
WHAT IS YOUR GUESS? 23
CONGRATULATIONS! YOU GUESSED MY NUMBER!

READY.
```

We can see that it prints the message, and it asks for a guess, and responds appropriately. But if we want to guess again, we have to use the **RUN** command again for each extra guess. That's a bit poor from the user's perspective. However that is unlikely to be a problem for long, because the user can see the secret number in the listing on the screen!

So we would like to fix these problems. Let's start with hiding the listing. We previously mentioned that when the screen scrolls, anything that was at the top of the screen disappears. So we could just make sure the screen scrolls enough, that any listing that

was visible is no longer visible. We could do this using **PRINT** and a **FOR** loop. The screen is 25 lines, so we could do something like:

```
FOR I = 1 to 25
PRINT
NEXT I
```

But there are better ways. If you hold down **SHIFT**, and then press **CLR HOME**, it clears the screen. This is much simpler and more convenient. But how can we do something like that in our program? It turns out to be very simple: You can type it while entering a string! This is because the keyboard works differently based on whether you are in *quote mode*.

Quote mode is just a fancy way of describing what happens when you type a double-quote character into the computer: Until you type another double-quote or press the **RETURN**. You might remember we mentioned the problem of funny symbols coming up when using the cursor keys. I didn't want to distract you at the time, but that is a symptom of being in quote mode: In quote mode many special keys show a symbol that represents them, rather than taking their normal action. For example, if you press the cursor left key while in quote mode, a **⏪** symbol appears. If you press the cursor right key, a **⏩**, up **⏴**, down **⏵** and the **CLR HOME** a **⏴**, and if you are holding down **SHIFT** and press **CLR HOME** a **⏴**.

So let's use this to make the second line clear the screen when it prints the **GUESS THE NUMBER BETWEEN 1 AND 100** message. The first time you try it is a bit confusing, but once you get the hang of it, it is quite easy. What we want in the end is a line that looks like this:

```
2 PRINT "␣GUESS THE NUMBER BETWEEN 1 AND 100"
```

To do this, start by typing **2 PRINT "**. Then hold the **SHIFT** key down, and press **CLR HOME**. Your line should now look like **2 PRINT"␣**. If so, you have succeeded! You can now finish typing the line as normal. When you have done that, you can use the **LIST** command as usual, to make sure that you have successfully modified the program. You should see your modified line with the **␣** symbol in it.

```
LIST
1 SN=23
2 PRINT "␣GUESS THE NUMBER BETWEEN 1 AND 100"
3 INPUT "WHAT IS YOUR GUESS";G
4 IF G<SN THEN PRINT "MY NUMBER IS BIGGER"
5 IF G>SN THEN PRINT "MY NUMBER IS SMALLER"
6 IF G=SN THEN PRINT "CONGRATULATIONS! YOU GUESSED MY NUMBER!"

READY.
2 PRINT"␣GUESS THE NUMBER BETWEEN 1 AND 100"
LIST

1 SN=23
2 PRINT"␣GUESS THE NUMBER BETWEEN 1 AND 100"
3 INPUT "WHAT IS YOUR GUESS";G
4 IF G<SN THEN PRINT "MY NUMBER IS BIGGER"
5 IF G>SN THEN PRINT "MY NUMBER IS SMALLER"
6 IF G=SN THEN PRINT "CONGRATULATIONS! YOU GUESSED MY NUMBER!"

READY.
```

If you now run the program by typing in **RUN** and pressing  as usual, the 2nd line tells the computer to clear the screen before printing the rest of the message, like this:

```
GUESS THE NUMBER BETWEEN 1 AND 100  
WHAT IS YOUR GUESS? █
```

This hides the listing from the user, so that they can't immediately see what our secret number is. We can type our guess in, the same as before, but just like before, after one guess it returns to the **READY.** prompt. We really would like people to be able to make more than one guess, without needing to know that they need to run the program again.

There are a few ways we could do this. We already saw the **FOR - NEXT** pattern. With that, we could make the program give the user a certain number of guesses. If we followed the **NEXT** command with another program line, we could even tell the user when they have taken too many guesses. So let's have a look at our program and see how we might do that. Here is our current listing again:

```
1 SN=23  
2 PRINT CL"GUESS THE NUMBER BETWEEN 1 AND 100"  
3 INPUT"WHAT IS YOUR GUESS"; G  
4 IF G<SN THEN PRINT "MY NUMBER IS BIGGER"  
5 IF G>SN THEN PRINT "MY NUMBER IS SMALLER"  
6 IF G=SN THEN PRINT "CONGRATULATIONS! YOU GUESSED MY NUMBER!"
```

If we want the user to have multiple guesses, we need to have lines 2 through 6 run multiple times. This makes our life a bit tricky, because it means we need to insert a line between line 1 and 2. But unless you are a mathematician, there are no whole numbers between 1 and 2, and the MEGA65 doesn't understand line numbers like 1.5.

Fortunately, the MEGA65 has the **RENUMBER** command. This command can be typed only in direct mode. When executed, it changes the line numbers in the program, while keeping them in the same order. The new numbers are normally multiples of 10, so that you have lots of spare numbers in between to add extra lines. For example, if we use it on our program, it will renumber the lines to 10, 20, ..., 60. We can see that this has happened by using the **LIST** command:

```
READY.  
LIST  
1 SN=23  
2 PRINT "GUESS THE NUMBER BETWEEN 1 AND 100"  
3 INPUT"WHAT IS YOUR GUESS";G  
4 IF G<SN THEN PRINT "MY NUMBER IS BIGGER"  
5 IF G>SN THEN PRINT "MY NUMBER IS SMALLER"  
6 IF G=SN THEN PRINT "CONGRATULATIONS! YOU GUESSED MY NUMBER!"  
  
READY.  
RENUMBER  
  
READY.  
LIST  
  
10 SN=23  
20 PRINT "GUESS THE NUMBER BETWEEN 1 AND 100"  
30 INPUT"WHAT IS YOUR GUESS";G  
40 IF G<SN THEN PRINT "MY NUMBER IS BIGGER"  
50 IF G>SN THEN PRINT "MY NUMBER IS SMALLER"  
60 IF G=SN THEN PRINT "CONGRATULATIONS! YOU GUESSED MY NUMBER!"  
  
READY.
```

Now our life is much easier: We can choose any number that is between 10 and 20 to put our **FOR** command into. It's a common choice to use the middle number, so that if you think of other things you want to add in later, you have the space to do it. So let's add a **FOR** command to give the user 10 chances to guess the number. We can use any variable name we like for this, except for **G** and **SN**, because we are using those. It would be very confusing if we mixed those up! So let's add a line like this:

```
15 FOR I = 1 TO 10 STEP 1
```

Now we need a matching **NEXT I** after line 60. Let's keep the nice pattern of adding 10 to work out the next line number, and put it as line 70:

```
70 NEXT I
```

We can type those lines in, and then use **LIST** command to make sure the result is correct:

```
LIST
10 SN=23
20 PRINT "GUESS THE NUMBER BETWEEN 1 AND 100"
30 INPUT"WHAT IS YOUR GUESS";G
40 IF G<SN THEN PRINT "MY NUMBER IS BIGGER"
50 IF G>SN THEN PRINT "MY NUMBER IS SMALLER"
60 IF G=SN THEN PRINT "CONGRATULATIONS! YOU GUESSED MY NUMBER!"

READY.
15 FOR I = 1 TO 10 STEP 1
70 NEXT I
LIST

10 SN=23
15 FOR I = 1 TO 10 STEP 1
20 PRINT "GUESS THE NUMBER BETWEEN 1 AND 100"
30 INPUT"WHAT IS YOUR GUESS";G
40 IF G<SN THEN PRINT "MY NUMBER IS BIGGER"
50 IF G>SN THEN PRINT "MY NUMBER IS SMALLER"
60 IF G=SN THEN PRINT "CONGRATULATIONS! YOU GUESSED MY NUMBER!"
70 NEXT I

READY.
```

That's looking pretty good. But there are a couple of little problems still. Can you work out what they might be? What will happen now after the user makes a guess? What will happen if they run out of guesses?

If you worked out that making a guess that the screen will be immediately cleared, you can give yourself a pat on the back! The user will hardly have time to see the message. Worse, if they guess the number correctly, they won't know, and the program will keep going. We'd really like the program to stop or end, once the user makes a correct guess.

We can do this using either the **STOP** or **END** commands. These two commands are quite similar. The main difference is that if you **STOP** a program, the computer tells you where it has stopped, and you have the chance to continue the program using the **CONT** command. The **END** command, on the other hand, tells the computer that the program has reached its end, and it should go back to being **READY**. The **END** command makes more sense for our program, because after the user has guessed the number, there isn't any reason to continue.

Now we need a way to be able tell the computer to do two different things when the user makes a correct guess. We could just add an extra **IF** command after line 60 which prints the congratulations message, e.g., **65 IF G=SN THEN END**.

But we can be a bit more elegant than that: There is a way to have multiple commands on a single line. If you remember back to when we were learning about the **INPUT** command, you might remember that there were two different characters that separate pieces of information: **,** and **:**. The second one, **:**, is called a colon, and can also be

used to separate BASIC commands on a single line. So if we want to change line 60 to **PRINT** the message of congratulations and then **END** the program, we can just add : **END** to the end of the line. The line should look like this:

```
60 IF G=SN THEN PRINT "CONGRATULATIONS! YOU GUESSED MY NUMBER!": END
```

That solves that problem. But it would also be nice to not clear the screen after every guess, so that the user can see what their last guess was, and whether it was bigger or smaller than the number. To do this, we can remove the clear-screen code from line 20, and add a new print command to a lower line number, so that it clears the screen once at the start of the program, before the user gets to start guessing.

For example, we could put it in line 5, so that it happens as the absolute first action of the program. As we mentioned earlier, the line numbers themselves aren't important: All that is important is to remember that the computer starts at the lowest line number, and runs the lines in order. Anyway, let's make those changes to our program:

```
20 PRINT "GUESS THE NUMBER BETWEEN 1 AND 100"  
5 PRINT "␣"
```

If you type those lines in, and **LIST** the program again, you should see something like the following:

```
40 IF G<SN THEN PRINT "MY NUMBER IS BIGGER"  
50 IF G>SN THEN PRINT "MY NUMBER IS SMALLER"  
60 IF G=SN THEN PRINT "CONGRATULATIONS! YOU GUESSED MY NUMBER!"  
70 NEXT I  
  
READY.  
  
20 PRINT "GUESS THE NUMBER BETWEEN 1 AND 100"  
5 PRINT "␣"  
LIST  
  
5 PRINT "␣"  
10 SN=23  
15 FOR I = 1 TO 10 STEP 1  
20 PRINT "GUESS THE NUMBER BETWEEN 1 AND 100"  
30 INPUT"WHAT IS YOUR GUESS";G  
40 IF G<SN THEN PRINT "MY NUMBER IS BIGGER"  
50 IF G>SN THEN PRINT "MY NUMBER IS SMALLER"  
60 IF G=SN THEN PRINT "CONGRATULATIONS! YOU GUESSED MY NUMBER!"  
70 NEXT I  
  
READY.
```

We can now **RUN** the program, and see whether it worked. Let's try it!



```
GUESS THE NUMBER BETWEEN 1 AND 100
WHAT IS YOUR GUESS? █
```

The screen still clears, which is good. Can you notice one little difference already, though? There is a blank line above the first message. This is because our **PRINT** command in line 5 goes to the next row on the screen after it has printed the clear-screen character. We can fix this by putting a ; (semi-colon) character at the end of the **PRINT** command. This tells the **PRINT** command that it shouldn't go to the start of the next row on the screen when it has done everything. So if we change line 5 to **5 PRINT "Q";** this will make the empty space at the top the screen disappear.

But back to our program, we can now make guesses, and the program will tell us whether each guess is more or less than the correct number. And after 10 guesses, it stops asking for guesses, and goes back to the **READY.** prompt, like this:

```
MY NUMBER IS SMALLER
GUESS THE NUMBER BETWEEN 1 AND 100
WHAT IS YOUR GUESS? 60
MY NUMBER IS SMALLER
GUESS THE NUMBER BETWEEN 1 AND 100
WHAT IS YOUR GUESS? 50
MY NUMBER IS SMALLER
GUESS THE NUMBER BETWEEN 1 AND 100
WHAT IS YOUR GUESS? 40
MY NUMBER IS SMALLER
GUESS THE NUMBER BETWEEN 1 AND 100
WHAT IS YOUR GUESS? 30
MY NUMBER IS SMALLER
GUESS THE NUMBER BETWEEN 1 AND 100
WHAT IS YOUR GUESS? 20
MY NUMBER IS BIGGER
GUESS THE NUMBER BETWEEN 1 AND 100
WHAT IS YOUR GUESS? 28
MY NUMBER IS SMALLER
GUESS THE NUMBER BETWEEN 1 AND 100
WHAT IS YOUR GUESS? 27
MY NUMBER IS SMALLER
READY.
```

It would be nice to tell the user if they have run out of guesses. We need to add this message after the **NEXT** command. We should also be nice and tell them what the secret number was, instead of leaving them wondering. So let's add the line to the end of our program as line 80:

```
80 PRINT "SORRY! YOU RAN OUT OF GUESSES. MY NUMBER WAS"; SN
```

Now if the user doesn't guess the number, they will get a useful message, like this:

```
GUESS THE NUMBER BETWEEN 1 AND 100
WHAT IS YOUR GUESS? 97
MY NUMBER IS SMALLER
GUESS THE NUMBER BETWEEN 1 AND 100
WHAT IS YOUR GUESS? 96
MY NUMBER IS SMALLER
GUESS THE NUMBER BETWEEN 1 AND 100
WHAT IS YOUR GUESS? 95
MY NUMBER IS SMALLER
GUESS THE NUMBER BETWEEN 1 AND 100
WHAT IS YOUR GUESS? 94
MY NUMBER IS SMALLER
GUESS THE NUMBER BETWEEN 1 AND 100
WHAT IS YOUR GUESS? 93
MY NUMBER IS SMALLER
GUESS THE NUMBER BETWEEN 1 AND 100
WHAT IS YOUR GUESS? 92
MY NUMBER IS SMALLER
GUESS THE NUMBER BETWEEN 1 AND 100
WHAT IS YOUR GUESS? 91
MY NUMBER IS SMALLER
SORRY! YOU RAN OUT OF GUESSES, MY NUMBER WAS 23
READY.
```

Exercises to try

1. Can you make the program ask at the start for the secret number?

At the moment the program sets the secret number to 23 every time. To make the game more interesting it would be great to ask the first user for the secret number, and then start the rest of the game, so that someone else can try to guess the number.

Clue: You will need change the line that sets the **SN** variable so that it can be read from the first user. You might find the **INPUT** statement useful.

2. Can you make the program ask for the user's name and give personalised responses?

At the moment, the program displays very simple messages. It would be nice to ask the user their name, and then use their name to produce personalised messages, like **SORRY DAVE, BUT THAT NUMBER IS TOO SMALL**.

Clue: You will need to add a line early in the program to ask the user their name.

Clue: You might like to review how we used the **PRINT** command, including with **;** to print more than one thing on a line.

3. Can you improve the appearance of the messages with colours and better spacing?

We haven't really made the program particularly pretty. It would be great to use colours.

*Clue: You might like to add more **PRINT** commands to improve the spacing and layout of the messages.*

*Clue: You might like to use either the colour codes in the messages you **PRINT***

*Clue: You might also like to use the **FOREGROUND**, **BACKGROUND** and **BORDER** commands to set the colour of the text, screen background and border.*

4. Can you make the program say if a guess is “warmer” or “colder” than the previous guess?

At the moment the program just tells you if the guess is higher or lower than the secret number. It would be great if it could tell you if a guess is getting closer or further away with each guess: When they get closer, it should tell the user that they are getting “warmer”, and “colder” when they get further away.

This is quite a bit more involved than the previous exercises, and requires you to work out some new things.

*Clue: You will need to remember the previous guess in a different variable, and then compare it with the last one: Is it nearer or further away. You might need to have **IF** commands that have another **IF** after the first one, or to learn how to use the **AND** operator.*

RANDOM NUMBERS AND CHANCE

We'll come back to the Guess The Number game shortly, but let's take a detour first. Through a maze. Let's hope we can get back out before the end of the lesson! Let's look at a simple way to make a maze. This program has been known for a long time. It works by choosing at random whether to display a or a symbol. These symbols are obtained by holding down  and tapping either the N or M keys. You can see the symbols on the front of those keys. While they are shown on the keys with a box around them, the box does not appear, only the diagonal line. It turns out that printing either of these two characters at random draws a decent looking maze.

Let's give it a try. To be able to do this, we need a way to generate randomness. The MEGA65 has the **RND(1)** function to do this. This function works like a variable, but each time you try to use it, it gives a different result. Let's see how that works. Type in the following:

```
PRINT RND(1)
```

Each time you type this, it will give a different answer, as you can see here:



```
BASIC 10.0 00.98.911001 ALL RIGHTS RESERVED
ENGLISH KEYBOARD
NO EXPANSION RAM
C1565 DRIVE
ROM CHECKSUM $4BCF
READY.
PRINT RND(1)
1.07870447E-03
READY.
PRINT RND(1)
.793262171
READY.
PRINT RND(1)
.44889513
READY.
PRINT RND(1)
.697215893
READY.
```

We can see that this gives us several different results: **1.07870447E-03**, **.793262171**, **.44889513**, **.697215893**. Each of these is a number between 0 and 1, even the first one. The first one is written in *scientific notation*. The **E-03** means that the value is $1.07870447 \times 10^{-3} = 0.000107870447$. That is, the **E-03** means to move the decimal place three places to the left. If there is a **+** after **E**, then it means to move the decimal place to the right. For example, **1.23456E+3** represents the number 1234.56.

Now, I promised a maze, so I better give you one. We can use this **RND(1)** to pick between these two symbols. The first one has a character code of 205, and the second one conveniently 206. This means that if we add the result of **RND(1)** to 205.5, we will get a number between 205.5 and 206.5. Half the time it will be 205.*something*, and the other half of the time it will be 206.*something*. We can use this to print one or the other characters by using the **CHR\$()** function that returns the character corresponding to the number we put between the brackets. This means we can do something like:

```
LET C = 205.5+RND(1)
PRINT CHR$(C);
```

This will print one or the other of these symbols each time. We could use this already to print the maze by doing this over and over, making a loop. We could use **FOR** and **NEXT**. But in this case, we want it to go forever, that is, each time the program gets to the end, we want it to go to the start again. The people who created BASIC really weren't very creative, so the command to do this is called **GOTO**. You put the number of the line that you want to be executed next after it, e.g., **GOTO 1**. We can use this to write our little maze program so that it will run continuously:

```
10 LET C = 205.5+RND(1)
20 PRINT CHR$(C);
30 GOTO 10
```

If you **RUN** this program, it will start drawing a maze forever, that looks like the screen shot below. You can stop it at any time by pressing **RUN STOP**, or you can pause it by pressing **NO SCROLL**, and unpause it by pressing **NO SCROLL** again. If you press **RUN STOP**, the computer will tell you where it was up to at the time. In the case of the screenshot below, it was working on line 10:

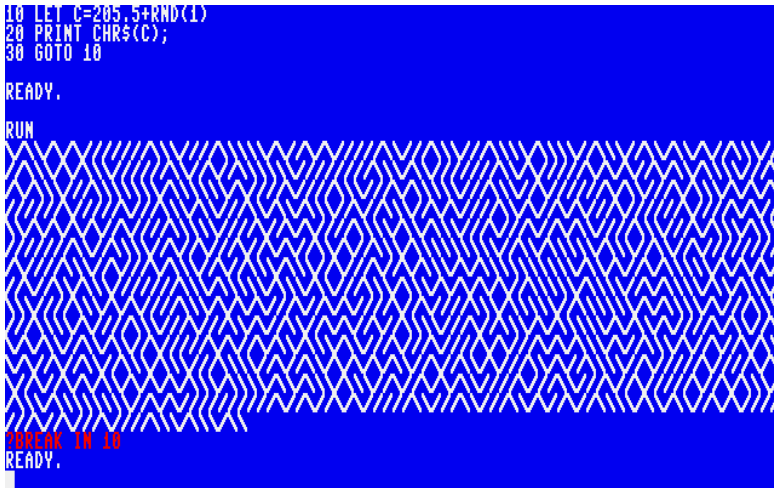

That works nicely, and draws a very famous maze [1]. We can, however, make the program smaller. We don't need to put the result of the calculation of which symbol to display on a separate line. We can put the calculation directly into brackets for the **CHR\$()** function:

```
10 PRINT CHR$(205.5+RND(1));  
20 GOTO 10
```

And we can use what we learnt about the **:** (colon) symbol, and put the **GOTO** command onto the same line as the **PRINT** command:

```
10 PRINT CHR$(205.5+RND(1));: GOTO 10
```

Can you see how there are often many ways to get the same effect from a program? This is quite normal. For complex programs, there are many, many ways to get the same function. This is one of the areas in computer programming where you can be very creative.

But back to the topic of randomness. It's all well and good using these random numbers between 0 and 1 for drawing a maze, but it's a bit tricky to ask people to get a really long decimal. If we want a number in the range 1 to 100, we can multiply what we get

from **RND(1)** by 100. If we do that, it gets a bit better, but we will still get numbers like **55.0304651**, **30.3140154**, **60.2505497** and **.759229916**.

That's closer, but we really want to get rid of those fractional parts. That is, we want whole numbers or *integers*. BASIC has the **INT()** function that works like the **RND(1)** function, except that whatever number you put in the brackets, it will return just the whole part of that. So for example **INT(2.18787)** will return the value **2**. As I said just now, it chops off the fractional part, that is, it always rounds down. So even if we do **INT(2.9999999)** the result will still be **2**, not **3**. This means that if we multiply the result of **RND(1)** by 100, we will get a number in the range of 0 - 99, not 1 - 100. This is nice and easy to fix: We can just add 1 to the result. So to generate an integer, that is a whole number, that is between 1 and 100 inclusive, we can do something like:

```
PRINT INT(RND(1)*100) + 1
```

That looks much better. So lets type in our "guess the number" program again. But this time, lets replace the place where we set our secret number to the number 23, to instead set it to a random integer between 1 and 100. Don't peek at the solution just yet. Have a think about how we can use the above to set **SN** to a random integer between 1 and 100. Once you have your guess ready, have a look what I came up with below. You might have made a different program that can do the same job. That's quite fine, too!

```
10 SN=INT(RND(1)*100)+1
20 PRINT " "
30 FOR I = 1 TO 10 STEP 1
40 PRINT "GUESS THE NUMBER BETWEEN 1 AND 100"
50 INPUT "WHAT IS YOUR GUESS"; G
60 IF G<SN THEN PRINT "MY NUMBER IS BIGGER"
70 IF G>SN THEN PRINT "MY NUMBER IS SMALLER"
80 IF G=SN THEN PRINT "CONGRATULATIONS! YOU GUESSED MY NUMBER!": END
90 NEXT I
100 PRINT "SORRY, YOU HAVE RUN OUT OF GUESSES"
```

Now we don't have to worry about someone guessing the number, and we don't need someone else to pick the number for us. This makes the program much more fun to play. Can you beat it?

Exercises to try

1. Can you make the maze program make different mazes?

The maze program currently displays equal numbers of `█` and `▣`. Can you change the program to print twice as many of one than the other? How does the maze look then?

Clue: We used `205.5` so that when we add a random number between 0 and 1, we end up with 205 something half the time and 206 something the other half of the the time. If you reduce `205.5` towards `205`, or increase it towards `206` you will change the relative proportion of each character that appears.

2. Can you modify the “guess my number” program to choose a number between 1 and 10?

At the moment, the program picks a number between 1 and 100. Modify the program so that it picks a number from a different range. Don't forget to update the message printed to the user. Do they still need 10 guesses? Change the maximum number of guesses they get before losing to a more suitable amount.

Clue: You will need to modify the line that sets `SN`, as well as the `PRINT` message that gives instruction to the user.

3. Set the screen, border and text colour to random colours

Modify either the maze or “guess my number” program to use random colours. How might you make sure that the text is always visible?

Clue: Use the `FOREGROUND`, `BACKGROUND` and `BORDER` commands to set the colours. Use colour numbers between 0 and 15, inclusive. You can put a calculation at the end of these commands in place of a simple number.

Clue: To make sure you don't set the text colour to the same as the background, you might like to calculate which background colour you wish to use and keep it in one variable, and then calculate the text colour to use and store it in a different variable. If the two variables have the same number, then you need to change one of them.

4. Make the “guess my number” program randomly choose between two different greeting messages when it starts.

The “guess my number” program currently always prints the same message every time it starts. Modify it so that it prints one of two possible messages each time.

Clue: Use `RND(1)` to obtain a random number. If that number is less than some threshold, print the first message, else print the second message.

Clue: It might be easier, if you store the random number in a variable, so that you can use two `IF` statements to decide whether to print each message.

Clue: If you use `<` (less than) as the relational operator in one of the `IF` statements, you will need to use the opposite in the other one. The opposite of less than is greater than or equal to.

CHAPTER

9

Text Processing

- **Characters and Strings**
- **String Literals**
- **String Variables**
- **String Statements**
- **Simple Formatting**
- **Sample Programs**

CHARACTERS AND STRINGS

Representing textual information in the form of printable letters, numbers and symbols is a common requirement of many computer programs. The need for text arises in word processing applications and word games. It is also required in natural language processing and text-based adventure games, both of which need to understand the input. Understanding text input is called *parsing*. In short, text processing is used everywhere. In order to input, output and manipulate such information, we must introduce two key concepts: characters and strings.

Characters can be printable or non-printable. A character most often represents a single, primitive element of printable text which may be displayed on the screen via the statement **PRINT**. It is most common and most natural to think of a character as representing a letter of an alphabet. A character might, for example, be any of the uppercase letters 'A' to 'Z', or any of the lowercase letters 'a' to 'z'. However, characters can also represent commonly used symbols such as punctuation marks or currency symbols. Indeed, characters can also represent the decimal digits, '0' to '9'. It is worth noting that this refers to the text-based representation of the numerals 0 to 9 as printable symbols as opposed to their numeric counterparts. In addition, the MEGA65 provides an extensive range of special symbols that can be used together for games, for drawing fancy borders or art. Besides displaying information, such symbols can create simple yet intriguing visual patterns. For convenience, these special symbols appear on the front sides of the MEGA65's keys.

A character can also be non-printable. Using such characters (in a **PRINT** statement) can activate certain behaviors or cause certain modes to become active, such as the switching of all text on the screen to lowercase or setting the foreground color to orange. Other non-printable characters might represent a carriage return or clear the screen.

For a complete catalog of available characters, refer to Chapter/Appendix C on page C-3. The table lists the characters that correspond to a given code number. The code number must be supplied as an argument to the statement **CHR\$** which, when combined with the **PRINT** statement, outputs the respective characters to the screen.

Here's an example of printing the exclamation mark using a character code:

```
PRINT CHR$(33)  
!
```

Note that the '!' is actually visible on the display because it is a printable character.

Here's an example of changing the foreground color to white using character codes:

```
PRINT CHR$(5)
```

Although no character is output, all subsequent printable characters displayed will be colored white.

Sometimes it can be useful to do the conversion in reverse: from a character to its code number. To do this, a single character must be supplied as an argument to the statement **ASC** within quotation marks which, when combined with the **PRINT** statement, outputs the respective code number to the screen in decimal.

Here's an example of obtaining the code number for the exclamation mark.

```
PRINT ASC("!")  
33
```

And here's an example of obtaining the code number for the exclamation mark and storing it in an integer variable:

```
A% = ASC("!")
```

Although we could output individual characters repeatedly by using **CHR\$** it would be tedious to do this all the time.

The concept of a string is needed because it embodies the idea of a contiguous block of text. Thus, a string can contain multiple printable and/or multiple non-printable characters in any combination. A string can potentially be empty and contain no characters at all. To write a string we enclose the characters inside quotation marks. So "HELLO WORLD!" is an example of a string literal.

```
PRINT "HELLO WORLD!"  
HELLO WORLD!
```

All strings have a property called length which is how many printable and non-printable characters there are present in that string. The length can be as low as 0 (the empty string) or as high as 255. Attempting to create a string with a length in excess of 255 characters results in a **?STRING TOO LONG ERROR**.

```
PRINT LEN("HELLO WORLD!")  
12
```

```
PRINT LEN("")  
0
```

It is possible to create variables specifically for strings. All such string variables have names that begin with a leading alphabetic character, have an optional second character that is alphanumeric, and end with a \$ sign. Once given a value, they can be used with **PRINT**.

```
AB$ = "HELLO WORLD!": PRINT AB$  
HELLO WORLD!
```

```
A1$ = "HELLO WORLD!": PRINT LEN(A1$)  
12
```

STRING LITERALS

String literals can be joined with one or more other such string literals to form a compound string. This process is called *concatenation*. To concatenate two or more string literals, use the + operator to chain them together.

Here are some examples:

```
PRINT ("SECOND" + "HAND")  
SECONDHAND
```

```
PRINT ("COUNTER" + "CLOCK" + "WISE")  
COUNTERCLOCKWISE
```

Sometimes punctuation or spaces may be required to make the final output appear correctly formatted, as in the following example.

```
PRINT ("FRUIT: " + "APPLE, " + "PEAR AND " + "RASPBERRY.")  
FRUIT: APPLE, PEAR AND RASPBERRY.
```

STRING VARIABLES

Concatenation is more commonly used with string variables combined with string literals. For example, in a text-based adventure game you might want to list some exits such as north or south. Because these exits will vary depending on the location you are currently at it would make sense to use variables for the exits themselves and use

concatenation with literals such as commas, spaces and full stops to format the output appropriately.

```
A$ = "PEA": B$ = "NUT": PRINT (A$ + B$ + "BUTTER")
PEANUTBUTTER
```

It is also possible to use strings as the parameters of **DATA** statements, to be read later, using the **READ** statement. The following example also demonstrates that arrays can hold strings too.

```
10 DIM A$(6)
20 PRINT "RAINBOW COLORS: ";
30 FOR I = 0 TO 5
40 : READ A$(I): PRINT (A$(I) + ", ");
50 NEXT I
60 READ A$(I): PRINT ("AND " + A$(I) + ",")
70 DATA "RED", "ORANGE", "YELLOW", "GREEN", "BLUE", "INDIGO", "VIOLET"
```

It is common for string data or single-character data to come directly from user input. When the user types some text, that text will often need to be parsed or printed back to the screen. In general, there are three main ways that this can be done: via the **GET** statement, via the **GETKEY** statement or via the **INPUT** statement.

All three statements have different behaviours, and it's important to understand how each one operates by contrasting and comparing them.

The **GET** statement is useful for storing the current keypress in a variable. The program does not wait for a keypress: it continues executing the next statement immediately. For this reason it is sometimes important to place the **GET** statement inside some kind of loop—the loop is to be exited only when a valid keypress is detected. If the variable to **GET** is a string variable and no keypress is detected, then that string variable is set to equal an empty string.

```
10 GET A$: REM DO NOT WAIT FOR A KEYPRESS--READ ANY KEYPRESS INTO THE VARIABLE
20 PRINT A$: IF (A$ = "Y" OR A$ = "N") THEN END
30 GOTO 10
```

The **GETKEY** statement is also useful for storing the current keypress in a variable. In contrast to the **GET** statement, the **GETKEY** statement, when executed, does wait for a single keypress before it continues executing the next statement.



```
10 GETKEY A$: REM WAIT FOR A KEYPRESS--PAUSE AND READ IT INTO THE VARIABLE
20 PRINT A$: IF (A$ = "Y" OR A$ = "N") THEN END
30 GOTO 10
```

While **GET** and **GETKEY** are fine for reading single characters, the **INPUT** statement is useful for reading in entire strings—that is, zero or more characters at a time.

When the **INPUT** statement is used with a comma and a variable, the prompt string is displayed normally with a cursor that permits the user to type in some text. When the **INPUT** statement is used with a semicolon and a variable, the prompt string is displayed with a question mark appended and a cursor that permits the user to type in some text.

```
10 INPUT "ENTER YOUR NAME", A$: REM NOT A QUESTION
20 PRINT ("HELLO " + A$)
```

```
10 INPUT "WHAT IS YOUR NAME"; A$: REM A QUESTION
20 PRINT ("HELLO " + A$)
```

In either case, pressing  will complete the text entry—the text entered will be stored in the given variable. Note that if the string variable is already equal to some string and  is pressed without entering in new data, then the old string value currently stored in the variable is retained.

STRING STATEMENTS

There are three commonly-used string manipulation commands: **MID\$**, **LEFT\$** and **RIGHT\$**. These are good for isolating substrings, including individual characters.

The following program asks for an input string and then prints all left substrings.

```
10 INPUT "ENTER A WORD:", A$
20 PRINT "ALL LEFT SUBSTRINGS ARE:"
30 FOR I = 0 TO LEN(A$)
40 : PRINT LEFT$(A$, I)
50 NEXT I
```

The following program asks for an input string and then prints all right substrings.

```

10 INPUT "ENTER A WORD:", A$
20 PRINT "ALL RIGHT SUBSTRINGS ARE:"
30 FOR I = 0 TO LEN(A$)
40 : PRINT RIGHT$(A$, I)
50 NEXT I

```

The following program ask for an input string consisting of a first name following by a space followed by a last name. It then outputs the initial letters of both names.

```

10 INPUT "ENTER A FIRST NAME, A SPACE AND A LAST NAME:", A$
20 N = -1
30 FOR I = 1 TO LEN(A$)
40 : IF (MID$(A$, I, 1) = " ") THEN N = I: GOTO 60
50 NEXT I
60 IF (N = -1) THEN GOTO 10
70 PRINT "INITIALS ARE: "; MID$(A$, 1, 1)+". "+MID$(A$, N + 1, 1)+"."

```

SIMPLE FORMATTING

Suppressing New Lines

When using the **PRINT** statement in a program, the default behaviour is to output the string and then move to the next line. To stop the behaviour of automatically moving to the next line, simply append a ; (semicolon) after the end of the string. Contrast lines 10, 20 and 30 in the following program.

```

10 PRINT "THIS A SINGLE LINE OF TEXT": REM A NEW LINE IS ADDED AT THE END
20 PRINT "THE SECOND LINE"; : REM A NEW LINE IS SUPPRESSED
30 PRINT " USES A SEMICOLON" : REM A NEW LINE IS ADDED AT THE END

```

Automatic Tab Stops

Sometimes is can be convenient to use the **PRINT** statement to output information neatly into columns. This can be done by appending a , (comma) after the end of the string. Consider the following example program.

```

10 PRINT "TEXT 1", "TEXT 2", "TEXT 3", "TEXT 4"

```

Note that each tab stop is 10 characters apart. So TEXT 1 begins at column 0, TEXT 2 begins at column 10, TEXT 3 begins at column 20, and TEXT 4 begins at column 30.

Tabs Stops and Spacing

When printing text on the screen, it is often necessary to format text by using spaces and tabs. Two commands come in handy here: **SPC** and **TAB**.

The command **SPC(5)**, for example, moves five characters to the right. Any intervening characters that lie between the current cursor position and the position five characters to the right are left unchanged.

The command **TAB(20)**, for example, moves to column 20 by subtracting the cursor's current position away from twenty and then moving that number of characters to the right. If the cursor's initial position is to the right of column 20 then the command does nothing. This command can often be used to make text line up neatly into columns.

SAMPLE PROGRAMS

We conclude with some examples.

Palindromes

A *palindrome* is a word or phrase or number that reads the same forwards as it does backwards. Some examples are: CIVIC, LEVEL, RADAR, MADAM and 1234321. The following program reverses the input text and then determines whether the original phrase is equal to the reversed phrase.

```
10 REM *** PALINDROMES ***
20 INPUT "ENTER SOME TEXT: ", A$
30 B$ = ""
40 FOR I = 1 TO LEN(A$)
50 : B$ = MID$(A$, I, 1) + B$
60 NEXT I
70 IF (A$ = B$) THEN PRINT (A$ + " IS A PALINDROME"): ELSE PRINT (A$ + " IS NOT A PALINDROME")
80 GOTO 20
```

Simple Ciphers

We now look at three simple examples of scrambling and unscrambling English language text messages. This scrambling and unscrambling process is the study of *cryptography* and is used to keep information secure so that it can't be read by others except for those privileged to know the cipher's method and secret key.

The process of scrambling a given message is called *encryption*. The ordinary, readable unscrambled text is called *plaintext*. Encrypting plaintext results in a scrambled message. This scrambled text is called *ciphertext*. The process of unscrambling the ciphertext is called *decryption*. Decrypting the ciphertext results in an unscrambled message—the plaintext.

Suppose that we were to encrypt some plaintext and then send the resulting ciphertext to a friend. Provided that the friend knows the method and secret key used to scramble the message, they could then decrypt the ciphertext and would be able to recover and read our original plaintext message.

If someone else attempts to read the ciphertext using the wrong method and/or the wrong secret key, the resulting text will be unintelligible.

The cryptographic systems we describe here are very simple. Obviously, they shouldn't be used today because they are easily broken by techniques of cryptanalysis. Nevertheless, they illustrate some basic techniques and show how we might structure a sample program.

We investigate three ciphers. These are the ROT 13 cipher, the Caesar Cipher and the Atbash Cipher. These are part of a group of ciphers known as *affine ciphers*.

Mathematically, it is useful to think of the letters of the English alphabet as numbered. A is 0, B is 1 and so, with Z being equal to 25.

Letter	A	B	C	D	E	F	G	H	I	J	K	L	M	N	O	P	Q	R	S	T	U	V	W	X	Y	Z
Value	0	1	2	3	4	5	6	7	8	9	10	11	12	13	14	15	16	17	18	19	20	21	22	23	24	25

A key mathematical component of a cryptographic system is *modular arithmetic*, sometimes casually referred to as "clock arithmetic" because the numbers begin at zero and increase until they reach an upper limit, at which point they wrap around back to zero again, much like a circle. In our case, since there are 26 letters in the English alphabet, we use modulo 26 arithmetic—our letters are numbered from 0 to 25.

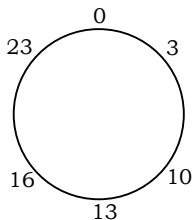

To reduce a given number using modulo 26 we can use the following function:

$$f(x) = x - \left\lfloor \frac{x}{26} \right\rfloor \times 26$$

This says that to obtain the value of a number x using modulo 26 we first divide x by 26 and round down, which gives us the number of times we went around the circle. We then multiply this result by 26 again and subtract this from x . The final result is the remainder left over and will always be a value between 0 and 25.

As an example, the number 28 in modulo 26 is equal to 2:

$$f(28) = 28 - \left\lfloor \frac{28}{26} \right\rfloor \times 26 = 28 - 1 \times 26 = 2$$

The program at the end of this chapter makes use of this formula by defining a corresponding function at line 30:

```
DEF FN F(X)=X-INT(X/26)*26
```

ROT13: When we encrypt each plaintext letter we move forward 13 places. So the plaintext letter A becomes the ciphertext letter N, B becomes O, with latter letters "wrapping around" back to the beginning of the alphabet. Thus, the plaintext letter Z becomes the ciphertext letter M. This covers encryption. To decrypt each ciphertext letter we simply repeat the process by moving forward 13 places again, which brings us full circle, back to where we started. Thus, a ciphertext letter N becomes the plaintext letter A.

We can see this visually as a mapping in the form of a table:

English Plaintext	A	B	C	D	E	F	G	H	I	J	K	L	M
ROT13 Ciphertext	N	O	P	Q	R	S	T	U	V	W	X	Y	Z

English Plaintext	N	O	P	Q	R	S	T	U	V	W	X	Y	Z
ROT13 Ciphertext	A	B	C	D	E	F	G	H	I	J	K	L	M

To encrypt using ROT13, find the plaintext letter in the top row and move down to the bottom row to find the corresponding ciphertext letter. To decrypt using ROT13, find the ciphertext letter in the bottom row and move up to the top row to find the corresponding plaintext letter.

If we consider the ROT13 cipher from a mathematical standpoint, we can see that to both encrypt and decrypt we simply add 13 to the numerical value of a plaintext or ciphertext letter and reduce it using modulo 26. This gives us a new number between 0 and 25 which corresponds to the encrypted or decrypted letter. Function E_{ROT13} is the encryption function. It accepts the value of a plaintext letter x as an argument and returns the value of the ciphertext letter as a result. Function D_{ROT13} is the decryption

function. It accepts the value of a ciphertext letter x as an argument and returns the value of the plaintext letter as a result.

$$E_{ROT13}(x) = (x + 13) \bmod 26$$

$$D_{ROT13}(x) = (x + 13) \bmod 26$$

Notice that the definitions of both the encryption and decryption functions are, in this case, exactly the same.

Atbash: Atbash is an ancient technique used to encrypt the 22-letter Hebrew alphabet, but we can apply the same logic to encrypt the 26-letter English alphabet. To encrypt a letter using Atbash we need to consider the English alphabet written backwards. So encrypting the plaintext letter A becomes the ciphertext letter Z, B becomes Y, C becomes X and so on. Decrypting the ciphertext works the same way: the ciphertext letter A becomes the plaintext letter Z, B becomes Y, C becomes X and so on.

We can see this visually as a mapping in the form of a table:

English Plaintext	A	B	C	D	E	F	G	H	I	J	K	L	M
Atbash Ciphertext	Z	Y	X	W	V	U	T	S	R	Q	P	O	N

English Plaintext	N	O	P	Q	R	S	T	U	V	W	X	Y	Z
Atbash Ciphertext	M	L	K	J	I	H	G	F	E	D	C	B	A

To encrypt using Atbash, find the plaintext letter in the top row and move down to the bottom row to find the corresponding ciphertext letter. To decrypt using Atbash, find the ciphertext letter in the bottom row and move up to the top row to find the corresponding plaintext letter.

If we consider the Atbash cipher from a mathematical standpoint, we can see that to encrypt and decrypt, we need to multiply by 25 and then add 25 to the numerical value of the plaintext or ciphertext and reduce it using modulo 26. This gives us a new number between 0 and 25 which corresponds to the encrypted or decrypted letter. Function E_{Atbash} is the encryption function. It accepts the value of a plaintext letter x as an argument and returns the value of the ciphertext letter as a result. Function D_{Atbash} is the decryption function. It accepts the value of a ciphertext letter x as an argument and returns the value of the plaintext letter as a result.

$$E_{Atbash}(x) = (25 \times x + 25) \bmod 26$$

$$D_{Atbash}(x) = (25 \times x + 25) \bmod 26$$

Notice that the definitions of both the encryption and decryption functions are, in this case, exactly the same.

Caesar: The Caesar cipher is also an ancient technique used to encrypt and decrypt messages. To encrypt a letter using the Caesar cipher we move three positions forward. So encrypting the plaintext letter A becomes the ciphertext letter D, B becomes E, C becomes F and so on. Decrypting the ciphertext works the opposite way. Instead of moving forward, we move three positions backward. The ciphertext letter A becomes the plaintext letter X, B becomes Y, C becomes Z and so on.

We can see this visually as a mapping in the form of a table:

English Plaintext	A	B	C	D	E	F	G	H	I	J	K	L	M
Caesar Ciphertext	D	E	F	G	H	I	J	K	L	M	N	O	P

English Plaintext	N	O	P	Q	R	S	T	U	V	W	X	Y	Z
Caesar Ciphertext	Q	R	S	T	U	V	W	X	Y	Z	A	B	C

To encrypt using the Caesar cipher, find the plaintext letter in the top row and move down to the bottom row to find the corresponding ciphertext letter. To decrypt using the Caesar cipher, find the ciphertext letter in the bottom row and move up to the top row to find the corresponding plaintext letter.

If we consider the Caesar cipher from a mathematical standpoint, we can see that to encrypt, we need to add 3 to the numerical value of the plaintext and reduce it using modulo 26. This gives us a new number between 0 and 25 which corresponds to the encrypted letter. To decrypt, we need to subtract 3 from the numerical value of the ciphertext and reduce it modulo 26. This gives us a new number between 0 and 25 which corresponds to the decrypted letter.

Function E_{Caesar} is the encryption function. It accepts the value of a plaintext letter x as an argument and returns the value of the ciphertext letter as a result. Function D_{Caesar} is the decryption function. It accepts the value of a ciphertext letter x as an argument and returns the value of the plaintext letter as a result.

$$E_{Caesar}(x) = (x + 3) \bmod 26$$

$$D_{Caesar}(x) = (x - 3) \bmod 26$$

Notice that the definitions of both the encryption and decryption functions are, in this case, different.

We can generalise all three of the above methods by stating that they use the following encryption and decryption functions:

$$E(x) = (A_1x + B_1) \bmod 26$$

$$D(x) = (A_2x + B_2) \bmod 26$$

Here, A_1 , A_2 , B_1 and B_2 are constants and put together they comprise the *encryption key* for an affine cipher.

Running the following program displays a text menu. The user can choose to encrypt or decrypt a string, or quit the program. You can practice typing in a plaintext phrase to encrypt and then decrypt the ciphertext phrase to retrieve the original plaintext.

A good sample text string for testing a cipher is:

THE QUICK BROWN FOX JUMPS OVER THE LAZY DOG

This text string, which is 43 characters long, contains 8 spaces and 35 alphabetic characters. Every character of the alphabet occurs at least once in this string, so encrypting and decrypting with it checks that every letter is transformed as expected.

Encrypting the above text string using the ROT13 cipher yields:

GUR DHVPX OEBJA SBK WHZCF BIRE GUR YNML QBT

Encrypting the above text string using the Atbash cipher yields:

GSV JFRXP YILDM ULC QFNKH LEVI GSV OZAB WLT

Encrypting the above text string using the Caesar cipher yields:

WKH TXLFN EURZQ IRA MXPSV RYHU WKH ODCB GRJ

```

10 REM *** CRYPTOGRAPHY ***
20 POKE 0,65: PRINT CHR$(142): PRINT CHR$(147)
30 DEF FN F(X)=X-INT(X/26)*26
40 C$="": P$=""
50 PRINT "SELECT AN OPTION (E, D OR Q):": PRINT
60 PRINT "(SPACE*3)[E] ENCRYPT PLAINTEXT": PRINT
70 PRINT "(SPACE*3)[D] DECRYPT CIPHERTEXT": PRINT
80 PRINT "(SPACE*3)[Q] QUIT": PRINT
90 GET $$
100 IF ($$="Q") THEN END
110 IF ($$="E") THEN GOSUB 150: GOTO 40
120 IF ($$="D") THEN GOSUB 270: GOTO 40
130 GOTO 90
140 REM ENCRYPT
150 INPUT "ENTER PLAINTEXT MESSAGE TO ENCRYPT: ", P$
160 IF P$="" THEN GOTO 150
170 M$=P$: GOSUB 390
180 IF (V=0) THEN GOSUB 460: GOTO 150
190 A=1: B=3
200 FOR I=1 TO LEN(P$)
210 :   L$ = MID$(P$,I,1)
220 :   IF (L$=" ") THEN C$=C$+" ": ELSE C$=C$+CHR$(65+(FN F(A*(ASC(L$)-65)+B)))
230 NEXT I
240 PRINT: PRINT "{REVERSE ON}ENCRYPTED CIPHERTEXT:{REVERSE OFF}", C$: PRINT
250 RETURN
260 REM DECRYPT
270 INPUT "ENTER CIPHERTEXT MESSAGE TO DECRYPT: ", C$
280 IF C$="" THEN GOTO 270
290 M$=C$: GOSUB 390
300 IF (V=0) THEN GOSUB 460: GOTO 270
310 A=1: B=-3
320 FOR I=1 TO LEN(C$)
330 :   L$ = MID$(C$,I,1)
340 :   IF (L$=" ") THEN P$=P$+" ": ELSE P$=P$+CHR$(65+(FN F(A*(ASC(L$)-65)+B)))
350 NEXT I
360 PRINT: PRINT "{REVERSE ON}DECRYPTED PLAINTEXT:{REVERSE OFF}", P$: PRINT
370 RETURN
380 REM VALIDATE
390 V = 1
400 FOR I=1 TO LEN(M$)
410 :   L$ = MID$(M$,I,1)
420 :   IF NOT (((L$ )= "A") AND (L$ (<= "Z")) OR (L$=" ")) THEN V = 0
430 NEXT I
440 RETURN
450 REM ERROR MESSAGE
460 PRINT: PRINT "USE LETTERS AND SPACES ONLY": PRINT
470 RETURN

```

If you wish to use the ROT13 cipher ensure that the following lines are changed:

```
190 A=1: B=13  
310 A=1: B=13
```

If you wish to use the Atbash cipher ensure that the following lines are changed:

```
190 A=25: B=25  
310 A=25: B=25
```

If you wish to use the Caesar cipher ensure that the following lines are changed:

```
190 A=1: B=3  
310 A=1: B=-3
```

The program listing, as written, uses the Caesar cipher by default.

CHAPTER 10

C64, C65 and MEGA65 Modes

- **Switching Modes from BASIC**
- **The KEY Register**
- **Accessing Memory from BASIC 65**
- **The MAP Instruction**

The MEGA65, like the C65 and the C128, has multiple operating modes. However, there are important differences between the MEGA65 and both of these earlier computers.

By default, the **MEGA65.ROM** file boots to MEGA65-mode (including BASIC 65), and provides a method to switch to C64-mode via the **GO 64** command. However, it is also possible to use an original C65 ROM (version 91xxxx.BIN) named as **MEGA65.ROM**, making the MEGA65 start in C65-mode with BASIC 10. This also provides the same functionality to switch to C64-mode.

Therefore, dependent on your boot ROM choice, you have:

Boot Mode	ROM version	BASIC	C64-mode
MEGA65	92xxxx	BASIC 65	GO 64
C65	91xxxx	BASIC 10	GO 64

For readers familiar with the C128, the most important difference is that all of the MEGA65's new features can be accessed from every mode, and that you can even switch back and forth between the different modes. It's also possible to create hybrid modes that combine different features from the different modes - all you need is the **MAP** instruction and the KEY register address, which is 53295 (\$D02F).

This chapter explains the different modes, the **MAP** instruction, and the KEY register, which allows you to change the mode of operation of the MEGA65. This chapter also explains how to use BASIC commands to switch from one mode to another.

SWITCHING MODES FROM BASIC

The MEGA65 is used in either C64-mode (running BASIC 2), C65-mode (running BASIC 10) for ROM versions 91xxxx, or MEGA65-mode (running BASIC 65) for ROM versions 92xxxx.

However, various MEGA65 features can be accessed from all modes, and all MEGA65 features are available to programs written in assembly language / machine code. More information on how to write such programs can be found in the various appendices.

From MEGA65/C65 to C64-mode

To switch from MEGA65/C65 to C64-mode, use the familiar **GO 64** command, which is identical to switching to C64 mode on a C128:

```
GO 64
ARE YOU SURE? Y
```

Note that any programs in memory will be lost in the process of switching modes. This is the same as the C128.



Alternatively, you can hold  down while pressing the reset button or switching the MEGA65 on. Again, this is the same as the C128.

From C64 to MEGA65/C65-mode

To switch from C64 to MEGA65/C65-mode, use the following command. **Note that this command does not ask you for confirmation!**

```
SYS 58552
```

Alternatively, you can switch back to MEGA65/C65-mode by pressing the reset button on the left-hand side of the MEGA65, or by switching the MEGA65 off and on again.

Another option is to long-press , and then press  from the Freeze Menu. This simulates pressing the reset button.

Note that any programs in memory will be lost in the process of switching modes. This is the same as the C128.

Entering Machine Code Monitor Mode

The Machine Code Monitor can be entered by typing either the **MONITOR** command from BASIC 65/10, or by holding  down, and then pressing the reset button on the left-hand side of the MEGA65.

THE KEY REGISTER

The MEGA65 has a VIC-IV video controller chip instead of the C64's VIC-II or the C65's VIC-III. Just as the VIC-III has extra registers compared to the VIC-II, the VIC-IV has even more registers. If these were visible all the time, software that was made for the C64 and VIC-II may inadvertently use these new registers, resulting in unexpected behaviour. Therefore, the creators of the C65 created a way to hide the extra VIC-III registers from old C64 programs. Enabling and disabling the extra registers is done via the KEY register. For more information about which registers are disabled and enabled

in each of the VIC-II, VIC-III and VIC-IV I/O modes, refer to Chapter/Appendix F on page F-8.

The KEY register is an unused register of the VIC-II, which you can **POKE** to and **PEEK** from, similar to other registers. But the KEY register has a special function: If you write two certain values to it in quick succession, you can tell the VIC-IV to stop hiding the VIC-III or VIC-IV registers from the rest of the MEGA65.

Exposing Extra C65 Registers

For example, to enable the VIC-III's new registers when in C64-mode, you must **POKE** the values 165 and 150 into the KEY register. The easiest way to do this is to switch your MEGA65 off and on again, and type GO 64 and answer Y to enter C64-mode.

If you do this while already in C65-mode, the MEGA65 may not function correctly.

Once you are in C64-mode, try typing the following commands:

```
POKE 53295,165: POKE 53295,150
```

When you enter these commands, the MEGA65 returns a **READY.** prompt, and seemingly nothing else has happened. This is expected, because the MEGA65 has only enabled the VIC-III's new registers (and some other C65-mode features). The C64 BASIC and KERNAL will still function as normal, and it may appear that nothing has changed... But things *have* changed.

For example, you can do something that the C64 and its VIC-II can't do: smoothly change one colour to another. The VIC-III has registers that allow you to change the red, green and blue components of the colours. Now that the VIC-III registers are enabled, it's possible to change the colour of the background progressively from blue to purple, by increasing the red component of the colour that is normally blue on the C64. The red component value registers are at 53504 - 53759 (\$D100 - \$D1FF). Blue is colour 6, so a change to register 53510 (53504 + 6, or \$D106) is required. An example BASIC listing below includes a **FOR** loop to change the colour:

```
FOR I = 0 TO 15 STEP 0.2 : POKE 53510,I : NEXT
```

Once the program has been entered, type **RUN** on a new line. This will make the background of the screen fade from blue to purple. If you would like to make the effect progress faster, increase the 0.2 to a larger number such as 0.5. To make it slower, change it to a smaller number such as 0.02. You can also change the red component by **POKE**ing a different number to 53504 - 53759 (\$D100 - \$D1FF), the green component at 53760 - 54015 (\$D200 - \$D2FF), or the blue component at

54016 - 54271 (\$D300 - \$D3FF). For example, to have the border and text (since they are both normally "light blue") fade from blue to green, you can try:

```
POKE 53518,0 : FOR I = 0 TO 15 STEP 0.1 : POKE 53774,I : POKE 54030,15-I : NEXT
```

Disabling the C65/MEGA65 Extra Registers

You can also disable the VIC-III registers again by **POKE**ing any number into the KEY register, e.g.:

```
POKE 53295,0
```

If you **RUN** the examples above again, the colours won't change because the registers are disabled. Instead, writing to those addresses changes some of the VIC-II's registers, as on a C64 they appear several times over. Fortunately for the above example, the registers used have no obvious side-effects. This is because the modified registers in the examples above on a standard VIC-II are used to change the sprite positions. Since there are no sprites on the screen, you won't see anything change.

Enabling MEGA65 Extra Registers

The MEGA65 has *even more* registers than the C65. To enable these in C64-mode, it's required to **POKE** another two values into the KEY register:



```
POKE 53295,71: POKE 53295,83
```



Again, you won't see any immediate difference, which is similar to when enabling the VIC-III registers. However, now the MEGA65 can access not only the VIC-II and VIC-III registers, but also the VIC-IV registers. If you like, you can try the examples from earlier in this chapter to see that the VIC-III registers are accessible again. But now you can also do MEGA65 specific things. For example, if you wanted to move the start of the top border higher on the screen, you can try something such as:

```
POKE 53320,60
```

Alternatively, you can have some fun and animate the screen borders, by having them move closer and further apart:

```
FOR I = 255 TO 0 STEP -1 : POKE 53320,I : POKE 53322, 255 - I : NEXT
```

The above example has the loop count backwards (from 255 to 0), so that you don't end up with only a tiny sliver of the text visible. You can make it go forwards if you like. If you do get stuck with only a sliver of the screen, you can press  and .

You might be wondering: Why does  and  work when these are VIC-IV registers that the C64-mode BASIC and KERNAL don't know about? The reason is the VIC-IV has a feature called "hot registers", where certain C64 and C65 registers cause some MEGA65 registers to be reset to the C64 or C65-mode defaults. In this particular case, it is the KERNAL resetting the VIC-II screen using 53265 (\$D011), which adjusts the vertical border size in C64/C65-mode, and is thus a "hot register" for the MEGA65's vertical border position registers.

See if you can instead make the screen shake around by changing the TEXTXPOS and TEXTYPOS registers of the VIC-IV. You can find out the POKE codes for those, and lots of other interesting new registers by looking through Chapter/Appendix M on page M-5.

Traps to look out for

In all modes, the DOS for the internal 3.5" disk drive (including when you use D81 disk images from an SD card) resets the KEY register to VIC-II mode whenever it is accessed. This means if you perform actions such as check the drive status, or **LOAD** or **SAVE** a file, the KEY register will be reset, and only the VIC-II registers will be enabled. You can of course enable the C65 or MEGA65 registers by **POKE**ing the correct values to the KEY register again.

ACCESSING MEMORY FROM BASIC 65

BASIC 65 contains powerful memory banking and Direct Memory Access (DMA) commands that can be used to read, fill, copy, and write areas of memory beyond the C65's 128KB of RAM. The MEGA65 has 384KB of main memory, split into 6 banks of 64KB each. They are:

- BANK 0 and BANK 1 - acts as the C65's normal 128KB RAM.
- BANK 2 and BANK 3 - normally write-protected, and contains the C65's ROM image.
- BANK 4 and BANK 5 - used for all graphic routines in BASIC 65 for high resolution bitplane graphics. BASIC 10 doesn't use banks 4 and 5.

Using the **BANK**, **PEEK** and **POKE** commands, this region of memory can be easily accessed, for example:

```
BANK 4: POKE0,123: REM PUT 123 IN LOCATION $40000  
BANK 4: PRINT PEEK(0): REM SHOW CONTENTS OF LOCATION $40000
```

Or, by using the **DMA** command, you can copy the current contents of the screen and colour RAM into BANK 4 with:

```
DMA 0, 2000, 2048, 0, 0, 4 : REM SCREEN TEXT TO BANK 4  
DMA 0, 2000, DEC("F800"), 1, 2000, 4 : REM COPY COLOUR RAM TO BANK 4
```

You can then put something else on the screen, and copy it back with:

```
DMA 0, 2000, 0, 4, 2048, 0 : REM SCREEN TEXT FROM BANK 4  
DMA 0, 2000, 2000, 4, DEC("F800"), 1 : REM COPY COLOUR RAM FROM BANK 4
```

THE MAP INSTRUCTION

The above methods can be used from BASIC. In contrast, the **MAP** instruction is an assembly language instruction that can be used to rearrange the memory that the MEGA65 uses. It is used by the C65 ROM and BASIC 65 to manage what memory it can use at any particular point in time. For further explanation of the **MAP** instruction, refer to the relevant section of Chapter/Appendix G on page G-8.

PART IV

SOUND AND GRAPHICS

colortbl adjustbox

CHAPTER

11

Graphics

Let's have some fun with graphics! In this part of the book, we want to examine the MEGA65's graphics modes by walking through example code in machine language to get to know the various options of the MEGA65 in the area of graphics. First of all, it is important to know that the MEGA65 supports three different basic graphics modes:

- Bitmap graphics
- Graphics based on character sets
- Bitplanes

BITMAP GRAPHICS

In bitmap graphics every pixel of a graphic is stored separately. The way the pixels are held in memory varies from system to system and in most cases depends on the performance of the hardware. If memory would be unlimited, the easiest way to remember a pixel is to save its RGB-values in three separate bytes. Example: 0xFFFFFF for white would result in three values to be stored: \$FF, \$FF and \$FF. To be honest, this is too simple and not really efficient. Let's think about another way. Why not defining a color table (or color palette) and store the RGB values once and finally only reference the color by its index in the table? This will save us a lot of memory! Let's imagine we would create a colorful 8x8 bitmap to represent an "A" on the screen. Colourful means, we want it in some brownish colors. The color table for it may look like this:

Index	Color
	Black
9	Brown
8	Orange
A	Light Red
F	Light Grey
7	Yellow

The color values, by the way, are exact the same as the color values from the standard C64 color palette. Next we design the "A". Each pixel references a value from the color table above.

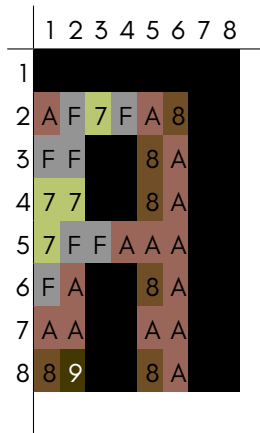

But how much memory does this little graphic use XXX?

If we create an one-dimensional array, we will get an array with 64 elements, because our graphic consists of 8x8 pixels = 64 color values that have to be saved. If we transfer that to the memory of the MEGA65, it means that we have 64 bytes to store in memory. However, full-screen graphics are made up of far more pixels. On the C64 and of course also on the MEGA65, 320x200 pixels are required to generate a graphic that fills the entire screen. If we transfer this to our array, we would have a total of 64,000 entries. Converted to the memory of the MEGA65, that is 64,000 bytes or nearly 64 kilobytes of data! If we now also consider that the good old C64 only had 64K of RAM available, we recognize the Drama! That's just too much data! We need strategies to reduce our bitmap data. On the C64 we had to two types of bitmap graphics and both come with its own concepts to use as less memory as possible.

- Hires
- Multicolor (MCM)

Hires

First, a bitmap is divided into blocks of 8x8 pixels each. In order to achieve the full resolution of 320x200 pixels, 40 of such blocks next to each other builds up a line. If we now build up 25 lines, we arrive at a graphic that fills the complete screen.

width=center

	1	2	3	4	5	6	7	8	9	10	11	12	13	14	15	16	17	18	19	20	21	22	23	24	25	26	27	28	29	30	31	32	33	34	
1																																			
2																																			
3																																			
4																																			
5																																			
6																																			
7																																			
8																																			
9																																			
10																																			
11																																			
12																																			
13																																			
14																																			
15																																			
16																																			
17																																			
18																																			
19																																			
20																																			
21																																			
22																																			
23																																			
24																																			
25																																			

Splitting into blocks makes sense because this gives us the chance to reduce the data drastically. Each line of a 8x8 block are 8 bits, so why not forget the color indexes and just say each pixel set represents a "1" in the line and each pixel not set corresponds to "0".

	1	2	3	4	5	6	7	8	
1									= 0 → \$00
2		1	1	1	1				= 120 → \$78
3	1	1					1	1	= 204 → \$CC
4	1	1					1	1	= 204 → \$CC
5	1	1	1	1	1	1	1	1	= 252 → \$FC
6	1	1					1	1	= 204 → \$CC
7	1	1					1	1	= 204 → \$CC
8	1	1					1	1	= 204 → \$CC

As shown above now you can easily convert the bits of each line to its hex value and you finally get 8 bytes of data. This is the central idea in hires graphics and with this concept you save a lot of memory. Here in this example it's 8 Bytes versus 64 Bytes if you have to manage all the color references. Let's count it up for a full screen picture: We have 40x25 Blocks, that is 1000 blocks in total. Each block is 8 Bytes or 1 Kilobyte, so we'll result in "only" 10K for a full screen picture.

This is a brilliant solution, but now have a problem: We lost the colors!

If you look at the first figure, it was very colorful. But do we really need so many colors? This is the second important concept in hires bitmap graphics: Less colors means less memory. In fact hires mode limits you to **two colors** per 8x8 pixel block. This information is stored in the Screen-RAM, not in the Color-RAM as one might assume. And again the idea why is really clever: In Screen-RAM you can hold values between \$00 and \$FF whereas in the Color-RAM it makes only sense to store values between \$0 and \$0F to reference one specific color from the C64 color palette which consists of 16 colors (\$0-\$F). On the MEGA65 you can have even more colors and you are able to tweak the default colors, but this will be explained later.

Back to the Screen-RAM. Here you store **two colors** for each 8x8 block. If you split the byte into its Hi-Byte and Low-Byte you have the chance to put a background and a foreground color into it! The value \$0a for example can be seen as \$0 and \$a. This way we'll get a black background and light red for the pixels in the block. In the end this means, a fullscreen hires bitmap will consume not 10 but 20 Kilobytes. 10K for the raw bitmap data as mentioned earlier and another 10K for the colors inside the Screen-RAM.

Programming simple Hires Bitmaps

Let's code!

PART V

HARDWARE

CHAPTER 12

Using Nexys4 boards as a MEGA65

- **Building your own MEGA65 Compatible Computer**
- **Working Nexys4 Boards**
- **Power, Jumpers, Switches and Buttons**
- **Keyboard**
- **Preparing microSDHC card**
- **Loading the bitstream from QSPI**
- **Useful Tips**

BUILDING YOUR OWN MEGA65 COMPATIBLE COMPUTER

You can build your own MEGA65-compatible computer by using either a Nexys4DDR (aka. Nexys A7) or the older Nexys4 (Non-DDR) FPGA development boards. This appendix describes the process to set up a Nexys4DDR (Nexys A7) board for this purpose (which is the newer, preferred board). The older non-DDR Nexys4 board is also supported, and the instructions are the same, except that you must use a bitstream designed for that board. Using a Nexys4DDR bitstream on a non-DDR Nexys4 board, or vice versa, may cause irreparable damage to your board, so make sure you have the correct bitstream to suit your board.

DISCLAIMER: M.E.G.A cannot take any responsibility for any damage that may occur to your Nexys4DDR/NexysA7/Nexys4 boards.

WORKING NEXYS4 BOARDS

There are currently 3 Nexys FPGA boards which can be setup as a MEGA65:

The Nexys4 board

No longer manufactured but still available for sale on some websites with old stock.



Documentation:

- <https://reference.digilentinc.com/reference/programmable-logic/nexys-4/reference-manual>
- https://reference.digilentinc.com/_media/reference/programmable-logic/nexys-4/nexys4_rm.pdf

The Nexys4DDR board

No longer manufactured but still available for sale on some websites with old stock.



Documentation:

- <https://reference.digilentinc.com/reference/programmable-logic/nexys-4-ddr/reference-manual>
- https://reference.digilentinc.com/_media/reference/programmable-logic/nexys-4-ddr/nexys4ddr_rm.pdf

The Nexys A7

This is the re-branded version of the above Nexys4 DDR board:



Documentation:

- <https://reference.digilentinc.com/reference/programmable-logic/nexys-a7/reference-manual>
- https://reference.digilentinc.com/_media/reference/programmable-logic/nexys-a7/nexys-a7_rm.pdf

POWER, JUMPERS, SWITCHES AND BUTTONS

This top-down picture highlights the key jumper positions of interest on the Nexys4 board:

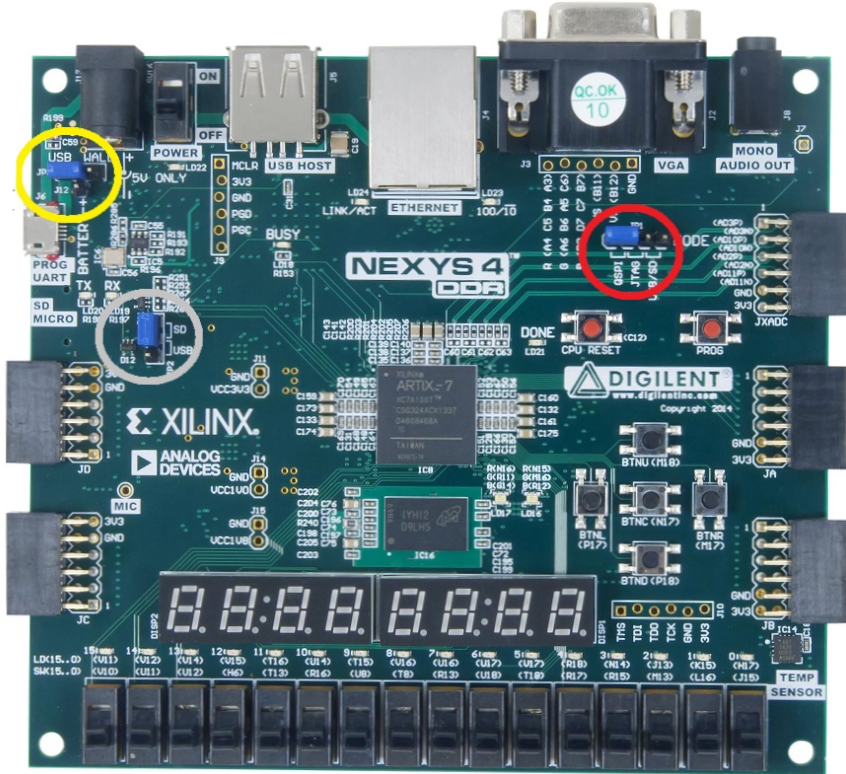

The Nexys4 boards can be powered in two ways: using an external power supply, or from a standard USB port.

Micro-USB Power

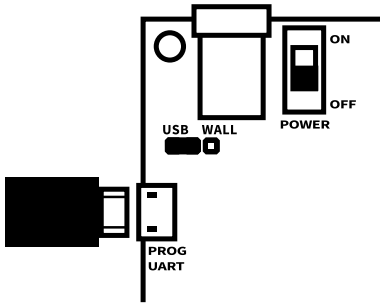

Connect your micro-usb cable to a USB port on a USB charger or PC to provide power. Connect the other end to the Nexys4's micro-usb connector. Place the JP3 jumper on pins 1 and 2 to select USB power. Use the switch to power up the Nexys4.

External Power Supply

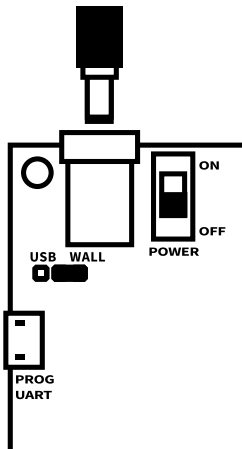

The MEGA65 core can consume a lot of power, and a standard USB port could potentially be too little for the Nexys4 board. In particular, writing to the SD card might hang or perform odd behaviour. Therefore you should consider a 5V power supply.

Digilent sell a power supply for the Nexys4 board, and we recommend you use this to ensure you avoid the risk of damage to your Nexys4 board. The chosen power supply should be center positive, 2.1mm internal diameter plug, and should deliver 4.5VDC to 5.5VDC rated at least 1 Amp.

Connect the power supply cable to the supply plug of the Nexys4. Place the JP3 jumper on pins 2 and 3 to select WALL power. Use the switch to power up the Nexys4.

Other Jumpers and Switches

For your initial set up, we'd suggest you set the following jumpers on your Nexys4 board to these positions:

- JP1 - USB/SD
- JP2 - SD



This will assure that the bitstream files will get loaded from your SD card on start-up.

At some later stage, you may prefer to load the bitstream from the on-board QSPI flash, and at that point, you can revisit your JP1 jumper setting and adjust it to the QSPI position.

All 16 switches on the lower edge of the board must be set to the off position.

Connections and Peripherals

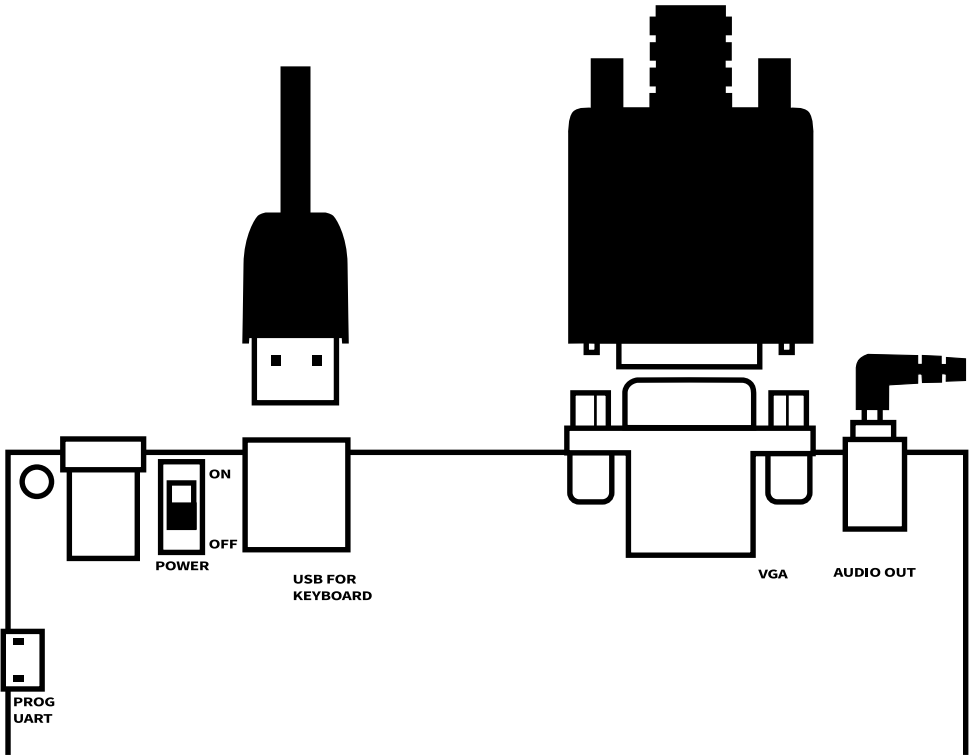

A USB keyboard can be connected to the USB port. Only a keyboard that lacks a USB hub will work with the Nexys4 board. Generally, extremely cheap keyboards will work, while more expensive keyboards tend to have a USB hub integrated, and will not work. You may need to try several keyboards before you find one that works.

You can connect a VGA monitor to the VGA port.

The mono audio-out jack can be connected to the line-in of an amplifier.

Communicating with your PC

There may be occasions where you wish to communicate with your Nexys4 board from your PC, in order to perform activities such as:

- Flash your QSPI flash chip via Vivado
- Upload bitstream files directly from your PC (via m65 tool)

- Make use of support tools such as M65Connect, m65, mega65_ftp, m65dbg, etc

On such occasions, you will need to connect your micro-usb cable up to your PC.

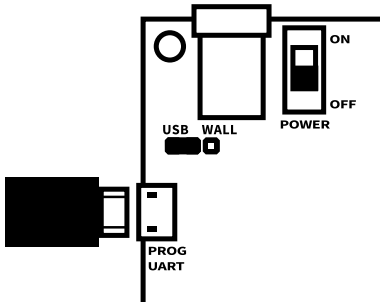

Onboard buttons



The “CPU RESET” button will reset the MEGA65 when pressed, while the “PROG” button will cause the FPGA itself to reload the MEGA65 core. The main difference between the two is that CPU RESET is faster, and does not clear the contents of memory, while the FPGA button is slower, and does reset the contents of memory.

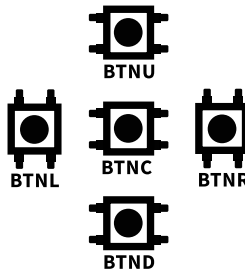

Two of the five buttons in the cross arrangement can also be used: BTND acts as though you have pressed , while BTNC will trigger an IRQ, as though the IRQ line had been pulled to ground.

KEYBOARD



The keyboard layout is positional rather than logical. This means that keys in similar positions to the keys on a C65 keyboard will have similar function. This relationship assumes that your USB keyboard uses a US keyboard layout.

To help you locate what the various MEGA65 keys are mapped to, the MEGA65 has a built-in virtual keyboard test feature. This can be accessed in two ways.

The easiest way is to keep  held down in while switching on the Nexys4, or resetting the Nexys4 with the "PROG" button. The configure menu will be presented and by pressing 3, the virtual keyboard will be presented on a black background.

RUN STOP		ESC	ALT	ASC DIN	NO SCRL		F1 F2	F3 F4	F5 F6	F7 F8		F9 F10	F11 F12	F13 F14	HELP
~ _	! 1	" 2	# 3	\$ 4	% 5	& 6	' 7	(8) 9	` 0	+	-	GBP	CLR HOME	INST DEL
TAB		Q	W	E	R	T	Y	U	I	O	P	@	*	PI ~^	RESTORE
CTRL	SHFT LOCK	A	S	D	F	G	H	J	K	L	[{] ;	=	RETURN	
M=	SHIFT	Z	X	C	V	B	N	M	<	>	? /	SHIFT	UP		
SPACE												LEFT	DOWN	RIGHT	

Pressing a key on the USB keyboard will show the highlighted key on the virtual keyboard to help you identify the key mapping.

The other way to access the virtual keyboard is from within the MEGA65. Hold  and press  to access the Matrix Mode Debugger. From here, enter the following:

```
s ffd3615 ff
```

This will open a semi-transparent virtual keyboard at the top of the screen. Alternatively:

```
s ffd3615 ff ff
```

This will open a semi-transparent virtual keyboard in the centre of the screen.

Hold  and press  to exit Matrix Mode Debugger and return to the MEGA65.

Some key mappings with a USB keyboard

RESTORE is mapped to the PAGE UP key.

**RUN
STOP** is mapped to **ESC**.

PREPARING MICROSDHC CARD

The MEGA65 requires an SDHC card of between 4GB and 64GB capacity. Some SDXC cards may work, however, this is not officially supported.

Preparation steps for the Nexys4 board's SD card share much in common with the steps needed for real MEGA65 hardware, and as such, it is worth having a look over the Configuring your MEGA65 chapter if you ever need details.

So in this section, we'll provide more details on the distinctive steps, and be more brief on the common steps.

One point of distinction between the Nexys board and the real MEGA65 hardware is that the latter already has a default bitstream/core provided, which permits you to format your SD card in the specific style required by the MEGA65.

For Nexys4 board owners however, you have no such default bitstream, so see Bitstream files for more details on where the appropriate "nexys4.bit" or "nexys4ddr-widget.bit" files for your device can be downloaded from.

Preparation Steps

The steps are:

- Format the SD card in a convenient computer using the FAT32 file-system. The MEGA65 and Nexys4 boards do not understand other file systems, especially the exFAT file system.
- Copy your bitstream file (with name ending in ".bit") onto the SD card.
- Insert the SD card into the SD card slot on the under-side of the Nexys4 board.
- Switch on the Nexys4 board.
- Enter the Utility Menu by holding  down on the USB keyboard you have connected to the Nexys4 board.
- Enter the FDISK/FORMAT tool by pressing 2 when the option appears on the MEGA65 boot screen.
- Follow the prompts in the FDISK/FORMAT program to again format the SD card for use by the MEGA65.

The FDISK tool will partition your SD card into two partitions and format them.

- One is type \$41 = MEGA65 System Partition, where the save slots, configuration data and other files live.
(This partition is invisible in i.e. Win PCs).
- The other partition with type \$0C = VFAT32, where KERNAL, support files, games, and so on, will be copied to later.
(This partition is visible on i.e. Win PCs).
- Once formatting is complete, switch off the Nexys4 board and remove the microSDHC card from the Nexys board and put it back into your PC
- This time, copy the following items onto the SD card:
 - The bitstream file
 - The extracted files from within either the "**SD essentials.rar**" or "**SD essentialsNoROM.rar**" file that you downloaded from the MEGA65 filehost.
(See Installing ROM and Other Support Files for more details).
 - If you have sourced your own preferred ROM file (e.g. "**911001.BIN**"), copy it onto the SD card also, and rename it to "**MEGA65.ROM**" (uppercase is essential).
 - Any .D81 disk image files you wish to make use of.
 - * Note that if a file named MEGA65.D81 is added to the SD card, it will be mounted automatically on startup.
 - * Make sure that all .D81 files have names that fit the old DOS 8.3 character limit, and are upper case. This restriction will be removed in a future release.
- Remove the SD card and reinsert it into your Nexys4 board.
- Power the Nexys4 board back on. The MEGA65 should boot within 15 seconds.
- On first start up, you will find yourself at the on-boarding screen, of which more details can be found in the Configuring your MEGA65 chapter.

Congratulations. Your MEGA65 has been set up and is ready to use.

Please note that the above method of copying the bitstream file to the SD card means that the bitstream is loaded into the Nexys FPGA each time on boot - which takes around 13 seconds for the system to start. The bitstream can also be flashed using Vivado software into the QSPI flash to deliver a boot up time of 0.3 seconds.

For more detailed information on preparing and configuring your MEGA65, please refer to the Configuring your MEGA65 chapter.

LOADING THE BITSTREAM FROM QSPI

While loading the bitstream from the SD card is the suggested (and well-trodden) path this document has chosen, of late, more nexys4 users have been exploring the alternative pathway of loading the bitstream from the QSPI flash. Some potential reasons they have chosen this pathway are:

- Faster loading times (0.3 seconds versus 13 seconds)
- Some people were interested in the possibility of flashing multiple cores onto their QSPI (via steps described in the Cores and Flashing Chapter)
- Some people have experienced niggling issues with the SD card pathway, such as:
 - System unable to reboot from on-boarding screen
 - System unable to reboot from freeze-menu after switching between PAL/NTSC

In time, if this proves to be a more popular pathway, we can revise our documentation here to suit it. Here are some steps in brief.

Preparation Steps

For users that want to try this pathway, you will need to adjust the JP1 jumper setting to use QSPI and then follow the steps in the Flashing the FPGAs and CPLDs in the MEGA65 chapter in relation to Installing Vivado and Flashing the main FPGA using Vivado.

Be forewarned that the installation of Vivado is a lengthy process (both in terms of download time, and installation time).

Once you have flashed Slot0 of your QSPI chip via Vivado, you can then follow the steps described in Configuring your MEGA65 to perform the custom SD card formatting, installing of ROM and support files and on-boarding.

USEFUL TIPS

The following are some useful tips for getting familiar with the MEGA65:

- Press & hold  (or the Commodore key if using a Commodore 64 or 65 keyboard) during boot to start up in C64-mode instead of C65-mode

- Press & hold **RUN STOP** during boot to enter the machine language monitor, instead of starting BASIC.
- Press **RESTORE** for approximately 1/2 - 1 second to enter the MEGA65 Freeze Menu. From this menu you have convenient tools to change the CPU speed, switch between PAL & NTSC video mode, change Audio settings, manage freeze-states, select D81 disk images, examine and modify memory of the frozen program, among other features. This is in many ways the heart of the MEGA65, so it is well worth exploring and getting familiar with.
- Type **POKE0,65** in C64-mode to switch the CPU to full speed (40MHz). Some software may behave incorrectly in this mode, while other software will work very well, and run many times faster than on a C64.
- Type **POKE0,64** in C64-mode to switch the CPU to 1MHz.
- Type **\$YS58552** in C64-mode to switch to C65-mode.
- Type **GO64** in C65-mode and confirm, by pressing **Y**, to switch to C64-mode, which is the same as on a C128.
- The C65 ROM makes device 8 the default, so you can normally leave off the **,8** from the end of **LOAD** and **SAVE** commands.
- Pressing **SHIFT** + **RUN STOP** from either C64 or C65-mode will attempt to boot from disk.

Have fun! The MEGA65 has been lovingly crafted over many years for your enjoyment. We hope you have as much fun using it as we have had creating it!

The MEGA Museum of Electronic Games & Art welcomes your feedback, suggestions and contributions to this open-source digital heritage preservation project.

PART VI

**CROSS-PLATFORM
DEVELOPMENT TOOLS**

CHAPTER

13

Emulators

- **Using The Xmega65 Emulator**
- **Using the Live ISO image**

At the time of writing, there is only one emulator for the MEGA65, **xmega65**; LGB's Xemu emulator suite. The LGB developers work hard to keep up with the development of the MEGA65; however, some MEGA65 emulation may not be accurate but should be sufficient for software development on the MEGA65.

During development, frequently test software on real hardware, such as a MEGA65 or FPGA board capable of running a MEGA65 core.

Download the MEGA65 emulator source code from <https://github.com/lgb1gblgb/xemu>.

Download pre-compiled versions from <https://github.lgb.hu/xemu/>.

A live ISO image containing the emulator, documentation, and other tools is available from Forum64.de at <https://www.forum64.de/index.php?thread/104698-xemu-live-system-iso-file/&postID=1549927#post1549936>.

USING THE XMEGA65 EMULATOR

USING THE LIVE ISO IMAGE

The Live ISO image is the product of a volunteer community; not the MEGA65 team. We include it for your convenience.

Creating a Bootable USB stick or DVD

There are many ways to create a live ISO image. The method you choose depends on your operating system and whether you wish to install to a USB drive or burn it to a DVD. Burning to a DVD is straightforward, assuming you own a computer that has a DVD writer. If you wish to create a faster bootable USB drive, try one of the methods below:

If you are using Windows, consider a tool like <http://www.isotousb.com/>.

On Linux, you can use the instructions at <https://fossbytes.com/create-bootable-usb-media-from-iso-ubuntu/>.

For Apple Macs, consider these instructions at <https://ubuntu.com/tutorials/create-a-usb-stick-on-macos#1-overview>.

Similar instructions are available for other popular computers, such as Amigas (<https://forum.hyperion-entertainment.com/viewtopic.php?t=3857>), or Sun UltraSPARC workstations (<https://forums.servethehome.com/index.php?threads/how-to-create-a-bootable-solaris-11-usb.1998/>).

Finally, the popular, easy-to-use, and free cross-platform balenaEtcher is available at <https://www.balena.io/etcher/>.

Getting Started

To avoid potential copyright issues, the bootable ISO image does not include proprietary ROMs for the MEGA65; such as legacy C65 ROMs. It does include an open-source replacement ROM from our OpenROMs project. This ROM will boot into a BASIC 2 environment that you can use to load and execute many C64 programs as shown in the image below:

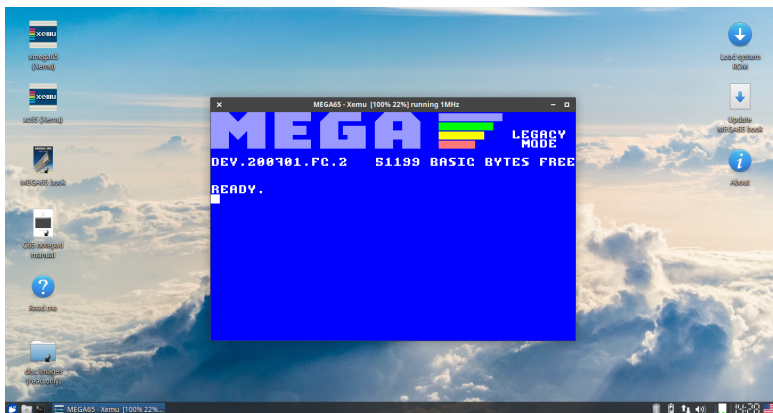

If you wish to use a C65 ROM that includes BASIC 10, download the appropriate ROM file and place it on another USB stick named **MEGA65.ROM**. On start-up, the MEGA65 will ask if a ROM has been downloaded; as shown in the image below:

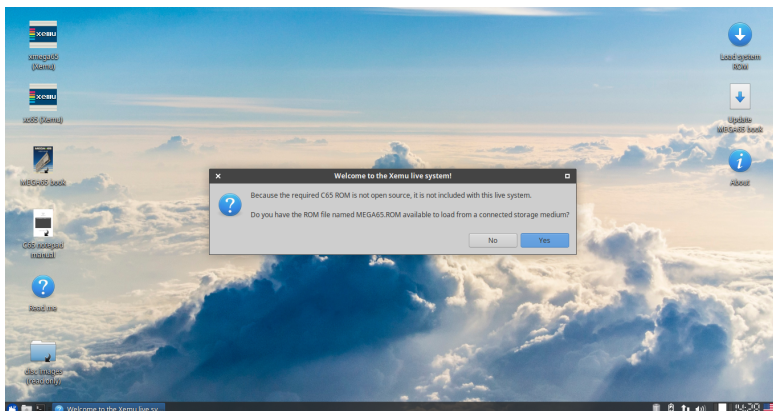

If the Live ISO cannot find a ROM, it will prompt you to download a ROM; as shown below:

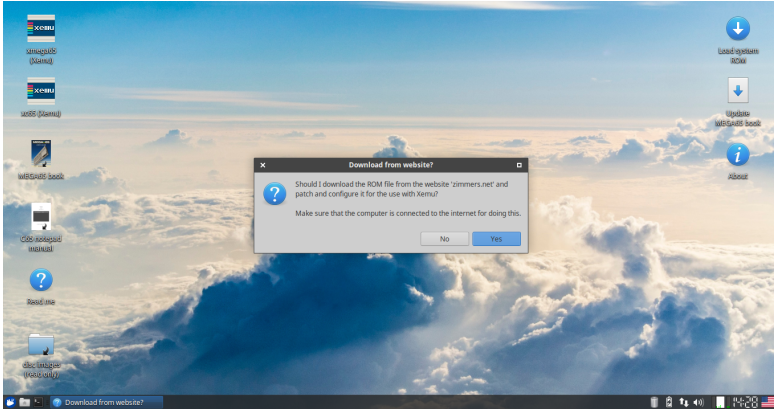

Other Features of the Live ISO

As the previous screen-shots show, the Live ISO provides various and convenient desktop shortcuts. On the left-hand side, there are shortcuts for launching the MEGA65 emulator and the C65 emulator so you can test that programs will run on both platforms. As previously mentioned, both emulators are a work in progress and may not be 100% compatible.

Another link provides access to the MEGA65 Book. This all-in-one volume, of approximately 800 pages, contains the official MEGA65 documentation. The majority of this developer's guide is also present in the MEGA65 Book.

This ISO also includes documentation for the C65 Notepad; a program for the C65 and MEGA65 written by Snoopy (the developer of the Live ISO image). A "read me" file contains further information about the Live ISO.

Finally, on the right-hand side, there are links to download a C65 ROM and to update the MEGA65 Book to the latest version. This will ensure you don't need to create a new bootable image each time a frequent update is made to the MEGA65 Book.

To access all contents of the Live ISO image, use the file explorer.

CHAPTER

14

Data Transfer and Debugging Tools

- **m65 command line tool**
- **M65Connect**
- **mega65_ftp**
- **TFTP Server**
- **Converting a BASIC text file listing into
a PRG file**

The key to effective cross-platform development is having quick and easy means to deploy and test software on the MEGA65. This is especially true while the MEGA65 emulator continues to be developed. In fact, even once the MEGA65 emulator is complete, it is unlikely that it will be able to offer full compatibility at full speed, because the MEGA65 is much more demanding to emulate than the C64.

There are a variety of tools that can be used for data transfer and debugging. These typically function using either the MEGA65's serial monitor interface, or via the MEGA65's fast ethernet adapter. The serial monitor interface is available via the UART lines on the JB1 header.

If you do not have access to the serial monitor interface, there are tools being developed for the fast ethernet port that provide some, but not all, of the capabilities of the serial monitor interface. These will be documented as they become available. The remainder of this chapter focusses on methods that access the serial monitor interface.

You can either connect a 3.3V UART adaptor to the appropriate lines, or more conveniently, connect a TE-0790-03 JTAG debug module onto this connector. This gives you a USB connection that can be used for injecting software, remote debugging and memory inspection, as well as activating or flashing bitstreams. With this connection, there are the following tools:

M65 COMMAND LINE TOOL

The <https://github.com/mega65/mega65-tools> repository contains a number of tools, utilities and example programs. These tools are mainly for Linux but can be used on Windows with Cygwin. One of those is the **m65** command line tool. This is rather a swiss-army knife collection of utilities in one. Common useful functions include:

Screenshots using m65 tool

To take a screenshot of the MEGA65 use:

```
m65 -s
```

This will create a file called **mega65-screen-000000.png**, or if that file already exists, the first non-used number will be used in place of **000000**.

Note that this screenshot function works by having **m65** emulate the function of the VIC-IV. Thus while it produces excellent looking digital screenshots, it may not exactly match the real display of the MEGA65. At the time of writing it does not render sprites or bitplanes, only text and bitmap-based video modes.

Load and run a program on the MEGA65

To load and run a program on the MEGA65, you can use a command like:

```
m65 -F -4 -r foo.prg
```

The `-F` option tells `m65` to reset the MEGA65 before loading the program.

The `-4` option tells `m65` to switch the MEGA65 to C64-mode before loading the program. If this is left off, then it will attempt to load the program in C65-mode.

The `-r` option tells `m65` to run the program immediately after loading.

Note that this command works using the normal BASIC LOAD command, and is thus limited to loading programs into the lower 64KB of RAM

Reconfigure the FPGA to run a different bitstream

To try out a different MEGA65 bitstream, a command like the following can be used:

```
m65 -b bitstream.bit
```

This will cause the named bitstream to be sent to the FPGA. As the FPGA will be re-configured by this action, and program currently running will not merely be stopped, but also main memory will be cleared. For models of the MEGA65 that are fitted with 8MB or 16MB of expansion memory, those expansion memories are implemented in external chips, and so the contents of them will not be erased.



For non-MEGA65 bitstreams (such as `zxomega65` and `gbc4mega65`), use the `'-q'` argument instead:

```
m65 -q bitstream.bit
```

Remote keyboard entry

The MEGA65's keyboard interface logic supports the injection of synthetic key events using the registers \$D615 - \$D617. The `m65` utility uses this to allow remote typing on the MEGA65 in a way that is transparent to software. There are three ways to use this:

```
m65 -t sometext
```

This form types the supplied text, in this case *sometext*, but does not simulate pressing . If you wish to simulate the pressing of , use `-T` instead of `-t`, e.g.:

```
m65 -T list
```

This would cause the LIST command to be typed and executed.

Finally, it is possible to begin general remote keyboard control via:

```
m65 -t -
```

In this mode, any key pressed on the keyboard of the computer where **m65** is running will be relayed to the MEGA65. Note that not all special keys are supported, and that there is some latency, so using key repeat can cause unexpected results. But for general remote control, it is a very helpful facility.

Unit testing and logging support

The **m65** tool includes support to facilitate remote unit testing directly on MEGA65 hardware. When *unit testing mode* is active, **m65** waits for the MEGA65 to send certain byte sequences over the serial interface which signal the current state (started, passed, failed) of a given test. Additionally, it is possible to send log messages from the MEGA65 to the host computer.

Unit testing mode is entered by calling **m65** with the **-u** flag. To run a remote BASIC program in C65-mode and simultaneously put **m65** into *unit testing mode*, the following command can be used:

```
m65 -Fur attic-ram.prg -w tests.log
```

The **-F** and **-r** options tell **m65** to reset the MEGA65 before loading the program "attic-ram.prg" and then automatically run it. The **-u** option then tells **m65** go into *unit testing mode* instead of exiting after launching the program. The optional **-w** option makes **m65** append the test results to the file "test.log" (creating the file if it doesn't exist).

Please note that **m65** automatically exits from *unit testing mode* if no test state signals were received for over 10 seconds.

Support is provided for sending unit test signals to the host computer from C and BASIC 65 programs:

Using unit tests with C

The MEGA65 libc contains support for unit testing via functions defined in **tests.h** and **tests.c**.

To signal the start of a test, include **tests.h** and use

```
unit_test_setup("testName",issueNumber);
```

where *testName* is a human-readable name of the test (e.g. "VIC-II") and *issueNumber* a reference to the corresponding bug issue (for example, the issue number from github).

After starting a test, it's possible to signal passed tests with the `unit_test_ok()` function:

```
unit_test_ok();
```

A failed test is signalled with `unit_test_fail()`:

```
unit_test_fail("fail message");
```

Each time the `unit_test_ok()` or `unit_test_fail()` functions are called, the *sub issue* of the test (reported on the host computer) is incremented. This makes it easier to combine and identify multiple tests in one file.

You can send arbitrary log messages via `unit_test_log()`:

```
unit_test_log("hello world from mega65!");
```

...and finally, when all is done, the end of unit testing is signalled by the use of

```
unit_test_done();
```

Using unit tests with BASIC 65

b65support.bin is a machine language module providing support for unit testing from BASIC 65, available in the **bin65** folder of the mega65-tools repository. This module works by redirecting the USR vector to perform the functions needed to communicate with the testing host.

In an automated test scenario, you may want to inject the **b65support.bin** binary into MEGA65 RAM by using **m65**:

```
m65 -c mega65-tools/bin65/b65support.bin@15fe
```

Of course it's also possible to load **b65support.bin** directly from the MEGA65 by mounting the **M65UTILS.D81** image from the freezer and issuing

```
BLOAD "B65SUPPORT.BIN"
```

After loading, **b65support.bin** is initialized with

```
SYS $1600
```

Once initialized, the following functions are provided by **b65support.bin**:

```
A=USR(<issueNum>)
```

prepares a new test with number <issueNum> and resets subissue number to 0

```
A=USR("<testName>")
```

sets test name and sends test start signal; for example: **A=USR("VIC-III")** sets the test name to 'VIC-III' and signals the host computer that the test has started.

```
A=USR("/<logMessage>")
```

sends a log message to the host computer

```
A=USR("P")
```

sends the 'passed' signal to the host computer and increases the sub issue number

```
A=USR("F")
```

sends the 'test failed' signal to the host computer and increases the sub issue number

```
A=USR("D")
```

sends the 'test done' signal to the host computer

All calls return the current sub issue number or **?ILLEGAL QUANTITY ERROR** in case of calling an invalid command.

BASIC 65 example

The following is a complete BASIC 65 example showing how to use **m65's** unit testing features:

```

100 rem attic ram cache test
110 poke $bffffff2,$e0      : rem enable attic ram cache
120 sys $1600               : rem init test module
130 a=usr(379)              : rem set issue number
140 a=usr(="attic-ram-cache") : rem set test name
150 bank128:poke0,65        : rem just to be sure
160 b0=$8000000 : b1=$8000100 : rem attic ram areas to be tested
170 for r=0 to $ff
180   poke b0+r,0           : rem fill area 1 with 0
190   poke b1+r,$ff        : rem fill area 2 with $ff
200 next r
210 for t=1 to 10           : rem 10 tries
220   poke b0,32            : rem write to b0
230   for x=0 to $ff:t1=b1+x
240     a=peek(b0)          : rem read from b0
250     b=peek(t1):b=peek(t1) : rem read twice from t1
260     ifb(>)255 thenf=t:t=t11:x=256 : rem this shouldn't happen
270   next x
280 next t
290 if f=0 then begin
300   print "no faults detected after";t;"tries."
310   a=usr("p")            : rem signal 'test passed' to host
320 bend : else begin
330   a=usr("f")            : rem signal 'test failed' to host
340   print "hyper ram fault detected after";f;"tries."
350   print "peek($";hex$(t1);") [t1] is";b;"but should be 255"
360 bend
370 a=usr("d")              : rem test done

```

M65CONNECT

This is a cross-platform graphical tool available for Windows, Linux and MacOSX, which allows access to most of the functions of the **m65** command-line tool, without needing to use a command line, or being able to compile the tool for your preferred operating system.

The repository for M65Connect is: <https://github.com/MEGA65/m65connect>

The latest binary version is available from <https://files.mega65.org>.

With the MEGA65 or Nexys FPGA switched off, connect a USB cable from your computer to the MEGA65 or Nexys FPGA board. Run the *M65Connect* executable and follow the prompts to connect. The program will help you identify which USB Serial Port to communicate over.

With this tool you can easily transfer PRG programs and a variety of other files. M65Connect can handle the transfer, switching to C64-mode, and execution of programs.

MEGA65_FTP

The `mega65_ftp` utility from the <https://github.com/mega65/mega65-tools> repository is a little misleadingly named: While it is a File Transfer Program, it does not use the File Transfer Protocol (FTP). Rather, it uses the serial monitor interface to take remote control of a MEGA65, and directly access its SD card to enable copying of files between the MEGA65 and the host computer.

Note that it does not perfectly restore the MEGA65's state on exit, and thus should only be used when the MEGA65 is at the READY prompt, so that any running software doesn't go haywire. In particular, you should avoid using it when a sensitive program is running, such as the Freeze Menu, MEGA65 Configuration Utility, or the MEGA65 Format/FDISK utility. (This problem could be solved with a little effort, if someone has the time and interest to fix it).

When run, it provides an FTP-like interface that supports the `get`, `put`, `rename` and `dir` commands. Note that when putting a file, you should make sure that it is given a name that is all capitals and has a DOS-compatible 8.3 character file name. This is due to limitations in both `mega65_ftp` and the MEGA65's Hypervisor's VFAT32 file system code. Again, these problems could be fixed with a modest amount of effort on the part of a motivated member of the community.

Finally, the `mega65_ftp` program is very slow to push new files to the MEGA65, typically yielding speeds of around 5KB/sec. This is partly because the serial monitor interface is capable of transferring data at only 40KB/sec (when set to 4,000,000 bits per second), and partly because the remote control process results in a lot of round-trips where helper routines are executed on the MEGA65 to read, write and verify sectors on the SD card. It would be quite feasible to improve this to reach close to 40KB/sec, and potentially faster using either some combination of data compression, de-duplication of identical sectors (especially when uploading disk images) and other techniques. Again, this would be a very welcome contribution that someone in the community could contribute to everyone's benefit.

TFTP SERVER

Work on a true TFTP server for the MEGA65 that supports fast TFTP transfers over the 100mbit ethernet has begun, and can be used to very quickly read files from the MEGA65. Speeds of close to 1MB/sec are possible, depending on SD card performance. Rather than using DHCP, this utility will respond to *any* IP address that ends in .65. It always uses the MAC address 40:40:40:40:40:40. True DHCP support as well as using the MEGA65's configured ethernet MAC address may be added in the future.

More importantly, support for writing files to the SD card is not yet complete, and is blocked by the need for the implementation of the necessary functions in the MEGA65's Hypervisor for creating and growing files. A particular challenge is enabling the creation of files with contiguous clusters as is required for D81 disk images: If a D81 file is fragmented, then it cannot be mounted, because the mounting mechanism requires a pointer to the contiguous block of the SD card containing the disk image. In the interim, **mega65_ftp** can be used as a substitute.

CONVERTING A BASIC TEXT FILE LISTING INTO A PRG FILE

If you have a untokenised BASIC program in plain text format sourced from somewhere like an internet post, and you wish to try it on the MEGA65 without typing it in, it is possible to convert it to a PRG.

C64List is a Windows-based command-line tool that will allow you to make the conversion. Once you have a *.PRG* file, you can use a tool like M65Connect to upload it to the MEGA65 or Nexys FPGA.

C64List is available for download from <http://www.commodoreserver.com/Downloads.asp>

Ensure you have a program listing saved to a file on your local computer (for example, *program.txt*) encoded as ANSI or UTF8.

Use *C64List* to convert the file to a PRG file using:

```
C64List program.txt -prg
```

Now you can upload your newly converted program to the MEGA65 with M65Connect or one of the other tools described previously.

It is worth noting that this method will not be 100% effective on listings with special PETSCII characters. Programs with PETSCII will require some editing on the MEGA65 itself before saving to disk.

CHAPTER 15

Assemblers

The table below shows an overview of assemblers known to work with MEGA65. For general use we recommend **ACME** as it has good support for the 45GS02 instruction set; is open source; and finally written in C. The latter means that it may be ported to run natively on the MEGA65 in the future.

Name	45GS02	Source	Reference
ACME	yes	C	https://sourceforge.net/projects/acme-crossass
KickAss	yes	Java	
Ophis	yes	Python	https://github.com/michaelcmartin/Ophis
BSA	yes	C	https://github.com/Edilbert/BSA
CA65	no ¹	C	https://github.com/mega65/cc65

The **BSA** assembler is currently used to build the **MEGA65.ROM**. Most of this source code is written in the syntax of the ancient **BSO** assembler (Boston Systems Office), which was used in the years 1989 - 1991 by software developers, working on the C65. The **BSA** Assembler has a compatibility mode, which makes it possible to assemble these old source codes with minor or none modifications. The **BSA** Assembler has currently only a description of commands embedded in the C-source of the assembler.

¹ Our fork of CA65 (part of CC65) correctly detects the MEGA65's CPU, but has no explicit support for the processor's features

CHAPTER 16

C and C-Like Compilers

- MEGA65 libc

Short answer: CC65 and KickC both work on the MEGA65.

Both CC65 and KickC are known to work on the MEGA65. However, both by default have only a C64 memory model, and use only 6502 opcodes. It would be super for someone to create a C65 memory configuration for CC65, and should not be too hard to do.

CC65 supports overlays, which could be powerfully used with the MEGA65's extra memory to allow programs larger than 64KB. However, this would require writing a suitable loader for such programs, which also does not yet exist.

Similarly, modifying the code generator of CC65 to use 45GS02 features would not be particularly difficult to do, and would help to overcome the otherwise horribly slow and bloated code that CC65 produces. Also adding first-class support for the 45GS02 CPU features in CA65 (or perhaps even better, making CC65 produce ACME compatible assembly output) would be of tremendous advantage, and not particularly hard to do. These would all be great tasks to tackle while you wait for your MEGA65 DevKit to arrive!

An example template for a C program that can be compiled using CC65 and executed on the MEGA65 can be found in the repository <https://github.com/MEGA65/hello-world>. This repository will even download and compile CC65, if you don't already have it installed on your system. This repository should work on Linux and Mac, and on Windows under the Windows Subsystem for Linux (WSL).

MEGA65 LIBC

A C library is being developed for the MEGA65, and which already includes a number of useful features. This library is available from <http://github.com/mega65/mega65-libc>. The procedures, functions and definitions it provides are documented in a separate chapter.

The MEGA65 libc is currently available only for CC65, although we would welcome someone maintaining a KickC port of it.

CHAPTER

17

MEGA65 Standard C Library

- **Structure and Usage**
- **conio.h**

A C library is being developed for the MEGA65, and which already includes a number of useful features. This library is available from <http://github.com/mega65/mega65-libc>. The procedures, functions and definitions it provides are documented in a separate chapter.

The MEGA65 libc is currently available only for CC65, although we would welcome someone maintaining a KickC port of it.

STRUCTURE AND USAGE

The MEGA65 libc is purposely provided in source-form only, and with groups of functions in separate files, and with separate header files for including. The idea is that you include only the header files that you require, and add only the source files required to the list of source files of the program you are compiling. This avoids the risk of the compiler including functions in your compiled program that are never used, and thus wasting precious memory space.

Note that some library source files are written in C, and thus are present as files with a `.c` extension, while others are written in assembly language either for efficiency or out of necessity, and have a `.s` extension.

Typical usage is to either have the `mega65-libc` source code checked out in an adjacent directory, or within the source directory of your own project. In the latter case, this can be done using the `git` submodule facility.

The following sections document each of the header files and the corresponding functions that they provide.

CONIO.H

conionit

Description: Initialises the library internal state

Syntax: `void conioinit(void)`

Notes: This must be called before using any conio library function.

setscreenaddr

Description: Sets the screen RAM start address

Syntax: `void setscreenaddr(long addr);`
Parameters: **addr:** The address to set as start of screen RAM
Notes: No bounds check is performed on the selected address

getscreenaddr

Description: Returns the screen RAM start address
Syntax: `long getscreenaddr(void);`
Return Value: The current screen RAM address start address.

setcolramoffset

Description: Sets the color RAM start offset value
Syntax: `void setcolramoffset(long offset);`
Parameters: **addr:** The offset from the beginning of the color RAM address (\$FF80000)
Notes: No bounds check is performed on the resulting address. Do not exceed the available Color RAM size

getcolramoffset

Description: Returns the color RAM start offset value
Syntax: `long getscreenaddr(void);`
Return Value: The current color RAM start offset value.

setcharsetaddr

Description: Sets the character set start address
Syntax: `void setcharsetaddr(long addr);`
Parameters: **addr:** The address to set as start of character set
Notes: No bounds check is performed on the selected address

getcharsetaddr

Description: Returns the current character set start address

Syntax: `long getscreenaddr(void);`

Return Value: The current character set start address.

clrscr

Description: Clear the text screen.

Syntax: `void clrscr(void)`

Notes: Color RAM will be cleared with current text color

getscreenize

Description: Returns the dimensions of the text screen

Syntax: `void getscreenize(unsigned char* width, unsigned char* height)`

Parameters: **width:** Pointer to location where width will be returned
height: Pointer to location where height will be returned

setscreensize

Description: Sets the dimensions of the text screen

Syntax: `void setscreensize(unsigned char width, unsigned char height)`

Parameters: **width:** The width in columns (40 or 80)
height: The height in rows (25 or 50)

Notes: Currently only 40/80 and 25/50 are accepted. Other values are ignored.

set16bitcharmde

Description: Sets or clear the 16-bit character mode

Syntax: `void set16bitcharmde(unsigned char f)`

Parameters: **f:** Set true to set the 16-bit character mode

Notes: This will trigger a video parameter reset if HOTREG is ENABLED. See sethotregs function.

sethotregs

Description: Sets or clear the hot-register behavior of the VIC-IV chip.

Syntax: `void set16bitcharmde(unsigned char f)`

Parameters: **f:** Set true to enable the hotreg behavior

Notes: When this mode is ENABLED a video mode reset will be triggered when touching \$D011, \$D016, \$D018, \$D031 or the VIC-II bank bits of \$DD00.

setextendedattrib

Description: Sets or clear the VIC-III extended attributes mode to support blink, underline, bold and highlight.

Syntax: `void setextendedattrib(unsigned char f)`

Parameters: **f:** Set true to set the extended attributes mode

togglecase

Description: Toggle the current character set case

Syntax: `void togglecase(void)`

bordercolor

Description: Sets the current border color

Syntax: `void bordercolor(unsigned char c)`

Parameters: `c`: The color to set

bgcolor

Description: Sets the current screen (background) color

Syntax: `void bgcolor(unsigned char c)`

Parameters: `c`: The color to set

textcolor

Description: Sets the current text color

Syntax: `void textcolor(unsigned char c)`

Parameters: `c`: The color to set

Notes: This function preserves attributes in the upper 4-bits if extended attributes are enabled. See `setextendedattrib`.

revers

Description: Enable the reverse attribute

Syntax: `void revers(unsigned char c)`

Parameters: **enable:** 0 to disable, 1 to enable

Notes: Extended attributes mode must be active. See `setextendedattrib`.

highlight

Description: Enable the highlight attribute

Syntax: `void highlight(unsigned char c)`

Parameters: **enable:** 0 to disable, 1 to enable

Notes: Extended attributes mode must be active. See `setextendedattrib`.

blink

Description: Enable the blink attribute

Syntax: `void blink(unsigned char c)`

Parameters: **enable:** 0 to disable, 1 to enable

Notes: Extended attributes mode must be active. See `setextendedattrib`.

underline

Description: Enable the underline attribute

Syntax: `void underline(unsigned char c)`

Parameters: **enable:** 0 to disable, 1 to enable

Notes: Extended attributes mode must be active. See `setextendedattrib`.

altpal

Description: Enable the alternate-palette attribute

Syntax: `void altpal(unsigned char c)`

Parameters: **enable:** 0 to disable, 1 to enable

Notes: Extended attributes mode must be active. See `setextendedattrib`.

clearattr

Description: Clear all text attributes

Syntax: `void clearattr()`

Notes: Extended attributes mode must be active. See `setextendedattrib`.

cellcolor

Description: Sets the color of a character cell

Syntax: `void cellcolor(unsigned char x, unsigned char y, unsigned char c)`

Parameters: **x:** The cell X-coordinate

y: The cell Y-coordinate

c: The color to set

Notes: No screen bounds checks are performed; out of screen behavior is undefined

setpalbank

Description: Set current text/bitmap palette bank (BTPALSEL).

Syntax: `void setpalbank(unsigned char bank)`

Parameters: **bank:** The palette bank to set. Valid values are 0, 1, 2 or 3.

Notes: Use setpalbanka to set alternate text/bitmap palette

setpalbanka

Description: Set alternate text/bitmap palette bank.

Syntax: `void setpalbanka(unsigned char bank)`

Parameters: **bank:** The palette bank to set. Valid values are 0, 1, 2 or 3.

Notes: Use setpalbank to set main text/bitmap palette

getpalbank

Description: Get selected text/bitmap palette bank.

Syntax: `unsigned char getpalbank(void)`

Notes: Use getpalbanka to get alternate text/bitmap selected palette

Return Value: The current selected main text/bitmap palette bank.

getpalbanka

Description: Get selected alternate text/bitmap palette bank.

Syntax: `unsigned char getpalbanka(void)`

Notes: Use `getpalbank` to get main text/bitmap selected palette

Return Value: The current selected alternate text/bitmap palette bank.

setmappedpal

Description: Set mapped-in palette bank at \$D100-\$D3FF.

Syntax: `void setmappedpal(unsigned char bank)`

Parameters: **bank:** The palette bank to map-in. Valid values are 0, 1, 2 or 3.

getmappedpal

Description: Get mapped-in palette bank at \$D100-\$D3FF.

Syntax: `unsigned char getmappedpal(void)`

setpalentry

Description: Set color entry for the mapped-in palette

Syntax: `void setpalentry(unsigned char c, unsigned char r, unsigned char g, unsigned char b)`

Parameters: **c:** The palette entry index (0-255)

r: The red component value

g: The green component value

b: The blue component value

Notes: Use `setmappedpal` to bank-in the palette to modify

fillrect

Description: Fill a rectangular area with character and color value

Syntax: `void fillrect(const RECT *rc, unsigned char ch, unsigned char col)`

Parameters: **rc:** A RECT structure specifying the box coordinates

ch: A char code to fill the rectangle

col: The color to fill

Notes: No screen bounds checks are performed; out of screen behavior is undefined

box

Description: Draws a box with graphic characters

Syntax: `void box(const RECT *rc, unsigned char color, unsigned char style, unsigned char clear, unsigned char shadow)`

Parameters: **rc:** A RECT structure specifying the box coordinates

color: The color to use for the graphic characters

style: The style for the box borders. Can be set to BOX_STYLE_NONE, BOX_STYLE_ROUNDED, BOX_STYLE_INNER, BOX_STYLE_OUTER, BOX_STYLE_MID

clear: Set to 1 to clear the box interior with the selected color

shadow: Set to 1 to draw a drop shadow

Notes: No screen bounds checks are performed; out of screen behavior is undefined

hline

Description: Draws an horizontal line.

Syntax: `void hline(unsigned char x, unsigned char y, unsigned char len, unsigned char style)`

Parameters: **x:** The line start X-coordinate

y: The line start Y-coordinate

len: The line length

style: The style for the line. See HLINE_ constants for available styles.

Notes: No screen bounds checks are performed; out of screen behavior is undefined

vline

Description: Draws a vertical line.

Syntax: `void vline(unsigned char x, unsigned char y, unsigned char len, unsigned char style)`

Parameters: **x:** The line start X-coordinate

y: The line start Y-coordinate

len: The line length

style: The style for the line. See VLINE_ constants for available styles.

Notes: No screen bounds checks are performed; out of screen behavior is undefined

gohome

Description: Set the current position at home (0,0 coordinate)

Syntax: `void gohome(void)`

gotoxy

Description: Set the current position at X,Y coordinates

Syntax: `void gotoxy(unsigned char x, unsigned char y)`

Parameters: **x:** The new X-coordinate

y: The new Y-coordinate

Notes: No screen bounds checks are performed; out of screen behavior is undefined

gotox

Description: Set the current position X-coordinate

Syntax: `void gotox(unsigned char x)`

Parameters: **x:** The new X-coordinate

Notes: No screen bounds checks are performed; out of screen behavior is undefined

gotoy

Description: Set the current position Y-coordinate

Syntax: `void gotoy(unsigned char y)`

Parameters: **y:** The new Y-coordinate

Notes: No screen bounds checks are performed; out of screen behavior is undefined

moveup

Description: Move current position up

Syntax: `void moveup(unsigned char count)`

Parameters: **count:** The number of positions to move

Notes: No screen bounds checks are performed; out of screen behavior is undefined

movedown

Description: Move current position down

Syntax: `void movedown(unsigned char count)`

Parameters: **count:** The number of positions to move

Notes: No screen bounds checks are performed; out of screen behavior is undefined

moveleft

Description: Move current position left

Syntax: `void moveleft(unsigned char count)`

Parameters: **count:** The number of positions to move

Notes: No screen bounds checks are performed; out of screen behavior is undefined

moveright

Description: Move current position right

Syntax: `void moveright(unsigned char count)`

Parameters: **count:** The number of positions to move

Notes: No screen bounds checks are performed; out of screen behavior is undefined

wherex

Description: Return the current position X coordinate

Syntax: `unsigned char wherex(void)`

Return Value: The current position X coordinate

wherey

Description: Return the current position Y coordinate

Syntax: `unsigned char wherey(void)`

Return Value: The current position Y coordinate

cputc

Description: Output a single character to screen at current position

Syntax: `void cputc(unsigned char c)`

Parameters: **c:** The character to output

cputnc

Description: Output N copies of a character at current position

Syntax: `void cputnc(unsigned char count, unsigned char c)`

Parameters: **c:** The character to output

count: The count of characters to print

cputhex

Description: Output an hex-formatted number at current position

Syntax: `void cputhex(long n, unsigned char prec)`

Parameters: **n:** The number to write

prec: The precision of the hex number, in digits. Leading zeros will be printed accordingly

Notes: The \$ symbol will be automatically added at beginning of string

cputdec

Description: Output a decimal number at current position

Syntax: `void cputdec(long n, unsigned char padding, unsigned char leadingZ)`

Parameters: **n:** The number to write

padding: The padding space to add before number

leadingZ: The leading zeros to print

cputs

Description: Output a string at current position

Syntax: `void cputs(const unsigned char* s)`

Parameters: **s:** The string to print

Notes: No pointer check is performed. If s is null or invalid, behavior is undefined

cputsxy

Description: Output a string at X,Y coordinates

Syntax: `void cputsxy (unsigned char x, unsigned char y, const unsigned char* s)`

Parameters: **x:** The X coordinate where string will be printed

y: The Y coordinate where string will be printed

s: The string to print

Notes: No pointer check is performed. If s is null or invalid, behavior is undefined

cputcxy

Description: Output a single character at X,Y coordinates

Syntax: `void cputcxy (unsigned char x, unsigned char y, unsigned char c)`

Parameters: **x:** The X coordinate where character will be printed

y: The Y coordinate where character will be printed

c: The character to print

cputncxy

Description: Output N copies of a single character at X,Y coordinates

Syntax: `void cputncxy (unsigned char x, unsigned char y, unsigned char count, unsigned char c)`

Parameters: **x:** The X coordinate where character will be printed

y: The Y coordinate where character will be printed

count: The number of characters to output

c: The character to print

cprintf

Description: Prints formatted output. Escape strings can be used to modify attributes, move cursor, etc similar to PRINT in CBM BASIC.

Syntax: `unsigned char cprintf (const unsigned char* format, ...)`

Parameters: **format:** The string to output. The available escape codes are:

Cursor positioning

`\t` Go to next tab position (multiple of 8s)
`\r` Carriage Return
`\n` New line

`{clr}` Clear screen `{home}` Move cursor to home (top-left)
`{d}` Move cursor down `{u}` Move cursor up
`{r}` Move cursor right `{l}` Move cursor left

Attributes

`{rvson}` Reverse attribute ON `{rvsoff}` Reverse attribute OFF
`{blon}` Blink attribute ON `{bloff}` Blink attribute OFF
`{ulon}` Underline attribute ON `{uloff}` Underline attribute OFF

Colors (default palette)

`{blk}` `{wht}` `{red}` `{cyan}`
`{pur}` `{grn}` `{blu}` `{yel}`
`{ora}` `{brn}` `{pink}` `{gray1}`
`{gray2}` `{lblu}` `{lgrn}` `{gray3}`

Notes: Currently no argument replacement is done with the variable arguments.

cgetc

Description: Waits until a character is in the keyboard buffer and returns it

Syntax: `unsigned char cgetc (void);`

Return Value: The last character in the keyboard buffer

Notes: Returned values are ASCII character codes

kbhit

Description: Returns the character in the keyboard buffer

Syntax: `unsigned char kbhit (void);`

Return Value: The character code in the keyboard buffer, 0 otherwise.

Notes: Returned values are ASCII character codes

getkeymodstate

Description: Return the key modifiers state.

Syntax: `unsigned char getkeymodstate(void)`

Return Value: A byte with the key modifier state bits, where bits:

Bit	Meaning	Constant
0	Right SHIFT State	KEYMOD_RSHIFT
1	Left SHIFT state	KEYMOD_LSHIFT
2	CTRL state	KEYMOD_CTRL
3	MEGA state	KEYMOD_MEGA
4	ALT state	KEYMOD_ALT
5	NOSCRL state	KEYMOD_NOSCRL
6	CAPSLOCK state	KEYMOD_CAPSLOCK
7	Reserved	-

flushkeybuf

Description: Flush the keyboard buffer

Syntax: `void flushkeybuf(void)`

cinput

Description: Get input from keyboard, printing incoming characters at current position.

Syntax: `unsigned char cinput(char* buffer, unsigned char buflen, unsigned char flags)`

Parameters: **buffer:** Target character buffer preallocated by caller

buflen: Target buffer length in characters, including the null character terminator

flags: Flags for input: (default is accept all printable characters)

CINPUT_ACCEPT_NUMERIC

Accepts numeric characters.

CINPUT_ACCEPT_LETTER

Accepts letters.

CINPUT_ACCEPT_SYM

Accepts symbols.

CINPUT_ACCEPT_ALL

Accepts all. Equals to CINPUT_ACCEPT_NUMERIC
| CINPUT_ACCEPT_LETTER | CINPUT_ACCEPT_SYM

CINPUT_ACCEPT_ALPHA

Accepts alphanumeric characters. Equals to
CINPUT_ACCEPT_NUMERIC | CINPUT_ACCEPT_LETTER

CINPUT_NO_AUTOTRANSLATE

Disables the feature that makes cinput to autodisplay uppercase characters when standard lowercase character set is selected and the user enters letters without the SHIFT key, that would display graphic characters instead of alphabetic ones.

Return Value: Count of successfully read characters in buffer

VIC_BASE

VIC_BASE is a pre-processor macro that provides the base address of the VIC-IV chip, i.e., \$D000.

IS_H640 is a pre-processor macro that returns 0 if the current VIC-III/IV video mode is set to 320 pixels across (40 column mode), and non-zero if it is set to 640 pixels across (80 column mode).

CHAPTER 18

BASIC Tokenisers

Various tokenisers for C64 BASIC exist, e.g., <https://github.com/catseye/hatoucan>, <https://www.c64-wiki.com/wiki/C64list>, or the **petcat** utility that is part of VICE. If you are using Ubuntu Linux, you can install **petcat** by using the following command:

```
sudo apt-get install vice
```

We recommend **petcat**, because it supports both C64 BASIC 2 and C65 BASIC 10.

PART

VII

APPENDICES

APPENDICES

APPENDIX A

Accessories

APPENDIX

B

BASIC 65 Command Reference

- **Commands, Functions and Operators**
- **BASIC 65 constants**
- **BASIC 65 variables**
- **BASIC 65 arrays**
- **BASIC command reference**

COMMANDS, FUNCTIONS AND OPERATORS

This appendix describes each of the commands, functions and other callable elements of BASIC 65, an enhanced version of BASIC 10. Some of these can take one or more arguments, which are pieces of input that you provide as part of the command or function call. Some also require that you use special keywords. Here is an example of how commands, functions and operators will be described in this appendix:

KEY <numeric expression>,<string expression>

In this case, KEY is what we call a **keyword**. That just means a special word that BASIC understands. Keywords are always written in CAPITALS, so that you can easily recognise them.

The < and > signs mean that whatever is between them must be there for the command, function or operator to work. In this case, it tells us that we need to have a **numeric expression** in one place, and a **string expression** in another place. We'll explain what they are a bit more in a few moments.

You might also see square brackets around something. For example, [**numeric expression**]. This means that whatever appears between the square brackets is optional, that is, you can include it if you need to, but that the command, function or operator will work just fine without it. For example, the CIRCLE command has an optional numeric argument to indicate if the circle should be filled when being drawn.

The comma, and some other symbols and punctuation marks just represent themselves. In this case, it means that there must be a comma between the **numeric expression** and the **string expression**. This is what we call syntax: If you miss something out, or put the wrong thing in the wrong place, it is called a syntax error, and the computer will tell you if you have a syntax error by giving a ?SYNTAX ERROR message.

There is nothing to worry about if you get an error from the computer. Instead, it is just the computer's way of telling you that something isn't quite right, so that you can more easily find and fix the problem. Error messages such as this won't hurt the computer or cause any damage to your program, so there is nothing to worry about. For example, if we accidentally left the comma out, or replaced it with a full stop, the computer will respond with a SYNTAX ERROR, similar to what's shown below:

```
KEY 8"FISH"
```

```
?SYNTAX ERROR
```

```
KEY 8."FISH"
```

```
?SYNTAX ERROR
```

It is very common for commands, functions and operators to use one or more “**expressions**”. An expression is just a fancy name for something that has a value. This could be a string (“HELLO”), a number (23.7), or a calculation that might include one or more functions or operators (LEN(“HELLO”) * (3 XOR 7)). Generally speaking, expressions can result in either a string or a numeric result. In this case we call the expressions either string expressions or numeric expressions. For example, “HELLO” is a **string expression**, while 23.7 is a **numeric expression**.

It is important to use the correct type of expression when writing your programs. If you accidentally use the wrong type, the computer will give you a ?TYPE MISMATCH ERROR, to say that the type of expression you gave doesn’t match what it expected. For example, we will get a ?TYPE MISMATCH ERROR if we type the following command, because “POTATO” is a string expression instead of a numeric expression:

```
KEY "POTATO", "SOUP"
```

If you wish, you can try typing this in yourself.

Commands are statements that you can use directly from the **READY.** prompt, or from within a program, for example:

```
PRINT "HELLO"  
HELLO
```

```
10 PRINT "HELLO"  
RUN  
HELLO
```

BASIC 65 CONSTANTS

type	example	example
decimal integer	32000	-55
decimal fixed point	3.14	-7654.321
decimal floating point	1.5E03	7.7E-02
hex	\$D020	\$FF
string	"X"	"TEXT"

BASIC 65 VARIABLES

Each scalar variable consumes 8 bytes of storage in memory. The reserved area in bank 0 from \$F700-\$FEFF can store 256 variables. Variables don't need to be declared, the type is determined by an appended character. All variables without an appended character are regarded as REAL by default. The storage is claimed at their first usage and they are initialised to zero, string variables are initialised as an empty string "".

type	appended character	range	example
byte	&	0 .. 255	BY& = 23
integer	%	-32768 .. 32767	I% = 5
real	none	-1E37 .. 1E37	XY = 1/3
string	\$	length = 0 .. 255	AB\$ = "TEXT"

BASIC 65 ARRAYS

Each array consumes the number of elements multiplied by the item size plus the size of the header (6 + 2 * dimensions) in memory. For example the array

```
100 DIM X(0,2,3) :REM (0..8, 0..2, 0..3)
```

has 3 dimensions and $9 \times 3 \times 4 = 108$ items. The size for real items is 5, so the data of that array occupies 540 bytes. The header size is $6 + 2 * 3 = 12$ bytes. So the total length in memory is 552 bytes.

Arrays are stored in bank 1 starting at address \$2000 and expand upwards. They share the available memory (\$2000 .. \$F6FF) with the string area, which starts in bank 1 at address \$F6FF and expand downwards. Each of the above scalar variable types can be used as an array by declaring them with a DIM statement. The arrays

are initialised to zero for all elements on declaration. If an undeclared array element is used, an automatic implicit declaration is done, which sets the upper boundary for each dimension to 10. For example, the usage of an undeclared element AB(3,5) would automatically perform a "DIM AB(10,10)". The lower boundary for each dimension is always 0 (zero), so an array initialised with DIM AB(10) consists of 11 elements and accepts indexes from 0 to 10.

String arrays are, more precisely expressed, arrays of string descriptors. Each item consists of three bytes, which hold the values: length of the string and the address (low/high byte) of the assigned string in string memory. The usage of the BASIC function POINTER with a string or string array element as the argument, returns the address of the descriptor, not the string itself.

type & item size		appended character	range	example
byte array	1	&	0 .. 255	BY&(5,6) = 23
integer array	2	%	-32768 .. 32767	I%(0,10) = 5
real array	5	none	-1E37 .. 1E37	XY(I%) = 1/3
string array	3	\$	length = 0 .. 255	AB\$(X) = "TEXT"

Keywords And Tokens Part 1

*	AC	COLOR	E7	FAST	FE25
+	AA	CONCAT	FE13	FGOSUB	FE48
-	AB	CONT	9A	FGOTO	FE47
/	AD	COPY	F4	FILTER	FE03
<	B3	COS	BE	FIND	FE2B
=	B2	CURSOR	FE41	FN	A5
>	B1	CUT	E4	FONT	FE46
ABS	B6	DATA	83	FOR	81
AND	AF	DCLEAR	FE15	FOREGROUND	FE39
APPEND	FE0E	DCLOSE	FE0F	FORMAT	FE37
ASC	C6	DEC	D1	FRE	B8
ATN	C1	DEF	96	FREAD#	FE1C
AUTO	DC	DELETE	F7	FWRITE#	FE1E
BACKGROUND	FE3B	DIM	86	GCOPY	FE32
BACKUP	F6	DIR	EE	GENLOCK	FE38
BANK	FE02	DISK	FE40	GET	A1
BEGIN	FE18	DLOAD	F0	GO	CB
BEND	FE19	DMA	FE1F	GOSUB	8D
BLOAD	FE11	DMODE	FE35	GOTO	89
BOOT	FE1B	DO	EB	GRAPHIC	DE
BORDER	FE3C	DOPEN	FE0D	HEADER	F1
BOX	E1	DPAT	FE36	HELP	EA
BSAVE	FE10	DSAVE	EF	HEX\$	D2
BUMP	CE03	DVERIFY	FE14	HIGHLIGHT	FE3D
BVERIFY	FE28	ECTORY	FE29	IF	8B
CATALOG	FE0C	EDIT	FE45	INPUT	85
CHANGE	FE2C	EDMA	FE21	INPUT#	84
CHAR	E0	ELLIPSE	FE30	INSTR	D4
CHR\$	C7	ELSE	D5	INT	B5
CIRCLE	E2	END	80	JOY	CF
CLOSE	A0	ENVELOPE	FE0A	KEY	F9
CLR	9C	ERASE	FE2A	LEFT\$	C8
CMD	9D	ERR\$	D3	LEN	C3
COLLECT	F3	EXIT	ED	LET	88
COLLISION	FE17	EXP	BD	LINE	E5

Keywords And Tokens Part 2

LIST	9B	PRINT#	98	SLEEP	FE0B
LOAD	93	PUDEF	DD	SOUND	DA
LOADIFF	FE43	RCOLOR	CD	SPC(A6
LOG	BC	RCURSOR	FE42	SPEED	FE26
LOG10	CE08	READ	87	SPRCOLOR	FE08
LOOP	EC	RECORD	FE12	SPRDEF	FE1D
LPEN	CE04	REM	8F	SPRITE	FE07
MEM	FE23	RENAME	F5	SPRSAV	FE16
MERGE	E6	RENUMBER	F8	SQR	BA
MID\$	CA	RESTORE	8C	STEP	A9
MOD	CE0B	RESUME	D6	STOP	90
MONITOR	FA	RETURN	8E	STR\$	C4
MOUSE	FE3E	RGRAPHIC	CC	SYS	9E
MOVSPR	FE06	RIGHT\$	C9	TAB(A3
NEW	A2	RMOUSE	FE3F	TAN	C0
NEXT	82	RND	BB	TEMPO	FE05
NOT	A8	RPALETTE	CE0D	THEN	A7
OFF	FE24	RPEN	D0	TO	A4
ON	91	RPLAY	CE0F	TRAP	D7
OPEN	9F	RREG	FE09	TROFF	D9
OR	B0	RSPCOLOR	CE07	TRON	D8
PAINT	DF	RSPEED	CE0E	TYPE	FE27
PALETTE	FE34	RSPPPOS	CE05	UNTIL	FC
PASTE	E3	RSPRITE	CE06	USING	FB
PEEK	C2	RUN	8A	USR	B7
PEN	FE33	RWINDOW	CE09	VAL	C5
PIXEL	CE0C	SAVE	94	VERIFY	95
PLAY	FE04	SAVEIFF	FE44	VIEWPORT	FE31
POINTER	CE0A	SCNCLR	E8	VOL	DB
POKE	97	SCRATCH	F2	WAIT	92
POLYGON	FE2F	SCREEN	FE2E	WHILE	FD
POS	B9	SET	FE2D	WINDOW	FE1A
POT	CE02	SGN	B4	XOR	E9
PRINT	99	SIN	BF	~	AE

Tokens And Keywords Part 1

80 END	A3 TAB(C6 ASC
81 FOR	A4 TO	C7 CHR\$
82 NEXT	A5 FN	C8 LEFT\$
83 DATA	A6 SPC(C9 RIGHT\$
84 INPUT#	A7 THEN	CA MID\$
85 INPUT	A8 NOT	CB GO
86 DIM	A9 STEP	CC RGRAPHIC
87 READ	AA +	CD RCOLOR
88 LET	AB -	CF JOY
89 GOTO	AC *	DO RPEN
8A RUN	AD /	D1 DEC
8B IF	AE ^	D2 HEX\$
8C RESTORE	AF AND	D3 ERR\$
8D GOSUB	B0 OR	D4 INSTR
8E RETURN	B1 >	D5 ELSE
8F REM	B2 =	D6 RESUME
90 STOP	B3 <	D7 TRAP
91 ON	B4 SGN	D8 TRON
92 WAIT	B5 INT	D9 TROFF
93 LOAD	B6 ABS	DA SOUND
94 SAVE	B7 USR	DB VOL
95 VERIFY	B8 FRE	DC AUTO
96 DEF	B9 POS	DD PUDEF
97 POKE	BA SQR	DE GRAPHIC
98 PRINT#	BB RND	DF PAINT
99 PRINT	BC LOG	E0 CHAR
9A CONT	BD EXP	E1 BOX
9B LIST	BE COS	E2 CIRCLE
9C CLR	BF SIN	E3 PASTE
9D CMD	C0 TAN	E4 CUT
9E SYS	C1 ATN	E5 LINE
9F OPEN	C2 PEEK	E6 MERGE
A0 CLOSE	C3 LEN	E7 COLOR
A1 GET	C4 STR\$	E8 SCNCLR
A2 NEW	C5 VAL	E9 XOR

Tokens And Keywords Part 2

EA HELP	FE02 BANK	FE26 SPEED
EB DO	FE03 FILTER	FE27 TYPE
EC LOOP	FE04 PLAY	FE28 BVERIFY
ED EXIT	FE05 TEMPO	FE29 ECTORY
EE DIR	FE06 MOVSPR	FE2A ERASE
EF DSAVE	FE07 SPRITE	FE2B FIND
F0 DLOAD	FE08 SPRCOLOR	FE2C CHANGE
F1 HEADER	FE09 RREG	FE2D SET
F2 SCRATCH	FE0A ENVELOPE	FE2E SCREEN
F3 COLLECT	FE0B SLEEP	FE2F POLYGON
F4 COPY	FE0C CATALOG	FE30 ELLIPSE
F5 RENAME	FE0D DOPEN	FE31 VIEWPORT
F6 BACKUP	FE0E APPEND	FE32 GCOPY
F7 DELETE	FE0F DCLOSE	FE33 PEN
F8 RENUMBER	FE10 BSAVE	FE34 PALETTE
F9 KEY	FE11 BLOAD	FE35 DMODE
FA MONITOR	FE12 RECORD	FE36 DPAT
FB USING	FE13 CONCAT	FE37 FORMAT
FC UNTIL	FE14 DVERIFY	FE38 GENLOCK
FD WHILE	FE15 DCLEAR	FE39 FOREGROUND
CE02 POT	FE16 SPRSAV	FE3B BACKGROUND
CE03 BUMP	FE17 COLLISION	FE3C BORDER
CE04 LPEN	FE18 BEGIN	FE3D HIGHLIGHT
CE05 RSPPOS	FE19 BEND	FE3E MOUSE
CE06 RSPRITE	FE1A WINDOW	FE3F RMOUSE
CE07 RSPCOLOR	FE1B BOOT	FE40 DISK
CE08 LOG10	FE1C FREAD#	FE41 CURSOR
CE09 RWINDOW	FE1D SPRDEF	FE42 RCURSOR
CE0A POINTER	FE1E FWRITE#	FE43 LOADIFF
CE0B MOD	FE1F DMA	FE44 SAVEIFF
CE0C PIXEL	FE21 EDMA	FE45 EDIT
CE0D RPALETTE	FE23 MEM	FE46 FONT
CE0E RSPEED	FE24 OFF	FE47 FGOTO
CE0F RPLAY	FE25 FAST	FE48 FGOSUB

BASIC COMMAND REFERENCE

ABS

Token: \$B6

Format: **ABS(x)**

Usage: The numeric function **ABS(x)** returns the absolute value of the numeric argument **x**.

x numeric argument (integer or real expression).

Remarks: The result is of type real.

Example: Using **ABS**

```
PRINT ABS(-123)
123
PRINT ABS(4.5)
4.5
PRINT ABS(-4.5)
4.5
```

AND

Token: \$AF

Format: operand **AND** operand

Usage: **AND** performs a bit-wise logical AND operation on two 16-bit values. Integer operands are used as they are. Real operands are converted to a signed 16-bit integer (losing precision). Logical operands are converted to 16-bit integer using \$FFFF, decimal -1 for TRUE and \$0000, decimal 0, for FALSE.

```
0 AND 0 -> 0
0 AND 1 -> 0
1 AND 0 -> 0
1 AND 1 -> 1
```

Remarks: The result is of type integer. If the result is used in a logical context, the value of 0 is regarded as FALSE, and all other non-zero values are regarded as TRUE.

Examples: Using **AND**

```
PRINT 1 AND 3
1
PRINT 128 AND 64
0
```

In most cases, **AND** is used in **IF** statements.

```
IF (C >= 0 AND C < 256) THEN PRINT "BYTE VALUE"
```

APPEND

Token: \$FE \$OE

Format: APPEND# channel, filename [,D drive] [,U unit]

Usage: Opens an existing sequential file of type **SEQ** or **USR** for writing, and positions the write pointer at the end of the file.

channel number, where:

- **1** <= **channel** <= **127** line terminator is CR.
- **128** <= **channel** <= **255** line terminator is CR LF.

filename is either a quoted string, e.g. "**data**" or a string expression in brackets, e.g. (**FI\$**).

drive drive # in dual drive disk units.

The drive # defaults to **0** and can be omitted on single drive units such as the 1541, 1571, or 1581.

unit device number on the IEC bus. Typically in the range from 8 to 11 for disk units. If a variable is used, it must be placed in brackets. The unit # defaults to **8**.

Remarks: APPEND# works similarly to DOPEN#... ,W, except that the file must exist already. The content of the file is retained, and all printed text is appended to the end. Trying to **APPEND** to a non existing file reports a DOS error.

Examples: Open existing file in append mode:

```
APPEND#5,"DATA",U9
APPEND#130,(DD$),U(UNX)
APPEND#3,"USER FILE,U"
APPEND#2,"DATA BASE"
```

ASC

Token: \$C6

Format: **ASC(string)**

Usage: Takes the first character of the string argument and returns its numeric code value. The name was apparently chosen to be a mnemonic to ASCII, but the returned value is in fact the so-called PETSCII code.

Remarks: **ASC** returns zero for an empty string, whose behaviour is different to BASIC 2, where `ASC("")` gave an error. The inverse function to **ASC** is **CHR\$**. Refer to the **CHR\$** command on page B-38 for more information.

Examples: Using **ASC**

```
PRINT ASC("MEGA")
77
PRINT ASC("")
0
```

ATN

Token: \$C1

Format: **ATN(numeric expression)**

Usage: Returns the arc tangent of the argument. The result is in the range $(-\pi/2$ to $\pi/2)$

Remarks: A multiplication of the result with $180/\pi$ converts the value to the unit "degrees". **ATN** is the inverse function to **TAN**.

Examples: Using **ATN**

```
PRINT ATN(0.5)
.463647609
PRINT ATN(0.5) * 180 / pi
26.5650512
```

AUTO

Token: \$DC

Format: **AUTO [step]**

Usage: Enables faster typing of BASIC programs. After submitting a new program line to the BASIC editor with , the AUTO function generates a new BASIC line number for the entry of the next line. The new number is computed by adding **step** to the current line number.

step line number increment

Typing **AUTO** with no argument switches this function off.

Examples: Using **AUTO**

```
AUTO 10 : USE AUTO WITH INCREMENT 10
AUTO    : SWITCH AUTO OFF
```

BACKGROUND

Token: \$FE \$3B

Format: **BACKGROUND** colour

Usage: Sets the background colour of the screen to the argument, which must be in the range of 0 to 15. (See colour table).

Colours: **Index and RGB values of colour palette**

index	red	green	blue	colour
0	0	0	0	black
1	15	15	15	white
2	15	0	0	red
3	0	15	15	cyan
4	15	0	15	purple
5	0	15	0	green
6	0	0	15	blue
7	15	15	0	yellow
8	15	6	0	orange
9	10	4	0	brown
10	15	7	7	pink
11	5	5	5	dark grey
12	8	8	8	medium grey
13	9	15	9	light green
14	9	9	15	light blue
15	11	11	11	light grey

Example: Using **BACKGROUND**

```
BACKGROUND 3 : REM SELECT BACKGROUND COLOUR CYAN
```

BACKUP

Token: \$F6

Format: **BACKUP U source TO U target**
BACKUP D source TO D target [,U unit]

Usage: The first form of **BACKUP**, specifying units for source and target can only be used for the drives connected to the internal FDC (Floppy Disk Controller). Units 8 and 9 are reserved for this controller. These can be either the internal floppy drive (unit 8) and another floppy drive (unit 9), attached to the same ribbon cable or mounted D81 disk images. Therefore, **BACKUP** can be used to copy from floppy to floppy, floppy to image, image to floppy and image to image, depending on image mounts and the existence of a second physical floppy drive.

The second form of **BACKUP**, specifying drives for source and target, is meant to be used for dual drives units connected to the IEC bus. For example: CBM 4040, 8050, 8250 via IEEE-488 to IEC adapter. The backup is then done by the disk unit internally.

source unit or drive # of source disk.

target unit or drive # of target disk.

Remarks: The target disk will be formatted and an identical copy of the source disk will be written.

BACKUP cannot be used to backup from internal devices to IEC devices or vice versa.

Examples: Using **BACKUP**

```
BACKUP U8 TO U9      : REM BACKUP INTERNAL DRIVE 8 TO DRIVE 9
BACKUP U9 TO U8      : REM BACKUP DRIVE 9 TO INTERNAL DRIVE 8
BACKUP D0 TO D1, U10 : REM BACKUP ON DUAL DRIVE CONNECTED VIA IEC
```

BANK

Token: \$FE \$02

Format: **BANK** bank-number

Usage: Selects the memory configuration for BASIC commands that use 16-bit addresses. These are **LOAD**, **LOADIFF**, **PEEK**, **POKE**, **SAVE**, **SYS**, and **WAIT**. Refer to the system memory map in Chapter/Appendix F on page F-3 for more information.

Remarks: A value > 127 selects memory mapped I/O. The default value for the bank number is 128. This configuration has RAM from \$0000 to \$1FFF and BASIC ROM's, KERNAL ROM's and I/O from \$2000 to \$FFFF.

Example: Using **BANK**

```
BANK 1 :REM SELECT MEMORY CONFIGURATION 1
```

BEGIN

Token: \$FE \$18

Format: **BEGIN ... BEND**

Usage: **BEGIN** and **BEND** act as a pair of braces around a compound statement to be executed after **THEN** or **ELSE**. This overcomes the single line limitation of the standard **IF ... THEN ... ELSE** clause.

Remarks: Do not jump with **GOTO** or **GOSUB** into a compound statement. It may lead to unexpected results.

Example: Using **BEGIN** and **BEND**

```
10 GET A$
20 IF A$="A" AND A$<="Z" THEN BEGIN
30 PWS=PWS+A$
40 IF LEN(PWS)>7 THEN 90
50 BEND :REM IGNORE ALL EXCEPT (A-Z)
60 IF A$<>CHR$(13) GOTO 10
90 PRINT "PW=";PWS
```

BEND

Token: \$FE \$19

Format: **BEGIN ... BEND**

Usage: **BEGIN** and **BEND** act as a pair of braces around a compound statement to be executed after **THEN** or **ELSE**. This overcomes the single line limitation of the standard **IF ... THEN ... ELSE** clause.

Remarks: The example below shows a quirk in the implementation of the compound statement. If the condition evaluates to **FALSE**, execution does not resume right after **BEND** as it should, but at the beginning of next line. Test this behaviour with the following program:

Example: Using **BEGIN** and **BEND**

```
10 IF Z > 1 THEN BEGIN:A$="ONE"  
20 B$="TWO"  
30 PRINT A$;" ";B$;BEND:PRINT " QUIRK"  
40 REM EXECUTION RESUMES HERE FOR Z <= 1
```

BLOAD

Token: \$FE \$11

Format: **BLOAD filename [,B bank] [,P address] [,R] [,D drive] [,U unit]**

Usage: "Binary BLOAD" loads a file of type **PRG** into RAM at address P.

BLOAD has two modes: The flat memory address mode can be used to load a program to any address in the 28-bit (256MB) address range where RAM is installed. This includes the standard RAM banks 0 to 5, but also the 8MB so called "attic RAM" at address \$8000000.

This mode is triggered by specifying an address at parameter P, that is larger than \$FFFF. The bank parameter is ignored in this mode.

For compatibility reasons with older BASIC versions, **BLOAD** accepts the syntax with a 16-bit address at P and a bank number at B as well. The attic RAM is out of range for this compatibility mode.

The optional parameter **R** (RAW MODE) does not interpret or use the first two bytes of the program file as the load address, which is otherwise the default behaviour. In RAW MODE every byte is read as data.

filename is either a quoted string, e.g. "**data**" or a string expression in brackets, e.g. (**FI\$**).

bank specifies the RAM bank to be used. If not specified, the current bank, as set with the last **BANK** statement, will be used.

address can be used to override the load address, that is stored in the first two bytes of the **PRG** file.

drive drive # in dual drive disk units.

The drive # defaults to **0** and can be omitted on single drive units such as the 1541, 1571, or 1581.

unit device number on the IEC bus. Typically in the range from 8 to 11 for disk units. If a variable is used, it must be placed in brackets. The unit # defaults to **8**.

Remarks: The **BLOAD** cannot cross bank boundaries.

BLOAD uses the load address from the file, if no P parameter is given.

Examples: Using **BLOAD**

```
BLOAD "ML DATA", B0, U9  
BLOAD "SPRITES"  
BLOAD "ML ROUTINES", B1, P32768  
BLOAD (FIS), B(BA%), P(PA), U(UN%)  
BLOAD "CHUNK", P($8000000) :REM LOAD TO ATTIC RAM
```

BOOT

Token: \$FE \$1B

Format: **BOOT filename** [**B bank**] [**P address**] [**D drive**] [**U unit**]
BOOT SYS
BOOT

Usage: **BOOT filename** loads a file of type **PRG** into RAM at address P and bank B, and starts executing the code at the load address.

BOOT SYS loads the boot sector from sector 0, track 1 and unit 8 to address \$0400 in bank 0, and performs a JSR \$0400 afterwards (Jump To Subroutine).

BOOT with no parameters attempts to load and execute a file named AUTOBOOT.C65 from the default unit 8. It's short for **RUN "AUTO-BOOT.C65"**.

filename is either a quoted string, e.g. "**data**" or a string expression in brackets, e.g. (**FI\$**).

bank specifies the RAM bank to be used. If not specified, the current bank, as set with the last **BANK** statement, will be used.

address can be used to override the load address, that is stored in the first two bytes of the **PRG** file.

drive drive # in dual drive disk units.

The drive # defaults to **0** and can be omitted on single drive units such as the 1541, 1571, or 1581.

unit device number on the IEC bus. Typically in the range from 8 to 11 for disk units. If a variable is used, it must be placed in brackets. The unit # defaults to **8**.

Remarks: **BOOT SYS** copies the contents of one physical sector (two logical sectors) = 512 bytes from disk to RAM, filling RAM from \$0400 to \$05ff.

Examples: Using **BOOT**

```
BOOT SYS
BOOT (FI$), B(BA%), P(PA), U(UN%)
BOOT
```

BORDER

Token: \$FE \$3C

Format: **BORDER** colour

Usage: Sets the border colour of the screen to the argument, which must be in the range of 0 to 15. Refer to the colour table under **BACKGROUND** on page B-18 for the **colour** values and their corresponding colours.

Example: Using **BORDER**

```
10 BORDER 4 : REM SELECT BORDER COLOUR PURPLE
```

BOX

Token: \$E 1

Format: **BOX X0,Y0, X2,Y2 [,SOLID]**
BOX X0,Y0, X1,Y1, X2,Y2, X3,Y3 [,SOLID]

Usage: The first form of **BOX** with two coordinate pairs and an optional **SOLID** parameter draws a simple rectangle, assuming that the coordinate pairs declare two diagonally opposite corners.

The second form with four coordinate pairs declares a path of four points, which will be connected by lines. The path is closed by connecting the last point with the first one.

The quadrangle is drawn using the current drawing context set with **SCREEN**, **PALETTE** and **PEN**. The quadrangle is filled if the parameter **SOLID** is not 0.

Remarks: **BOX** can be used with four coordinate pairs to draw any shape that can be defined with four points, not only rectangles. For example rhomboids, kites, trapezoids and parallelograms. It is also possible to draw bow tie shapes.

Examples: Using **BOX**

```
BOX 0,0, 160,0, 160,80, 0,80
```



```
BOX 0,0, 160,80, 160,0, 0,80
```

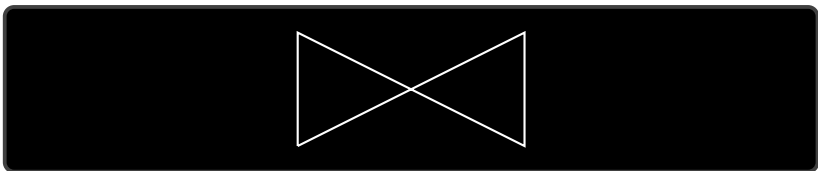

BOX 20,0, 140,0, 160,80, 0,80



BSAVE

Token: \$FE \$10

Format: **BSAVE filename ,P start TO P end [,B bank] [,D drive] [,U unit]**

Usage: "Binary SAVE" saves a memory range to a file of type **PRG**.

BSAVE has two modes: The flat memory address mode can be used to save a memory block in the 28-bit (256MB) address range where RAM is installed. This includes the standard RAM banks 0 to 5, but also the 8MB so called "attic RAM" at address \$8000000.

This mode is triggered by specifying addresses for the start and end parameter P, that are larger than \$FFFF. The bank parameter is ignored in this mode. This flat memory mode allows saving ranges greater than 64K.

For compatibility reasons with older BASIC versions, **BSAVE** accepts the syntax with 16-bit addresses at P and a bank number at B as well. The attic RAM is out of range for this compatibility mode. This mode cannot cross bank boundaries, start and end address are supposed to refer to the same bank.

filename is either a quoted string, e.g. "**data**" or a string expression in brackets, e.g. (**FI\$**). If the first character of the filename is an at sign 'e', it is interpreted as a "save and replace" operation. It is not recommended to use this option on 1541 and 1571 drives, as they contain a "save and replace bug" in their DOS.

start is the first address, where the saving begins. It also becomes the load address, which is stored in the first two bytes of the **PRG** file.

end address where the saving ends. **end-1** is the last address to be used for saving.

bank specifies the RAM bank to be used. If not specified, the current bank, as set with the last **BANK** statement, will be used.

drive drive # in dual drive disk units.

The drive # defaults to **0** and can be omitted on single drive units such as the 1541, 1571, or 1581.

unit device number on the IEC bus. Typically in the range from 8 to 11 for disk units. If a variable is used, it must be placed in brackets. The unit # defaults to **8**.

Remarks: The length of the file is **end - start + 2**.

If the number after an argument letter is not a decimal number, it must be set in parenthesis, as shown in the third and fourth line of the examples.

The **PRG** file format, that is used by **BSAVE** requires the load address to be written to the first two bytes. If the saving is done with a bank number, that is not zero or a start address higher than \$FFFF, this information does not fit. For compatibility reasons, only the the two low order bytes are written. Loading the file with the **BLOAD** command requires then the full specification of the load address as parameter.

Examples: Using **BSAVE**

```
BSAVE "ML DATA", P 32768 TO P 33792, B0, U9  
BSAVE "SPRITES", P 1536 TO P 2058  
BSAVE "ML ROUTINES", B1, P($9000) TO P($A000)  
BSAVE (FI$), B(BA%), P(PA) TO P(PE), U(CUN%)
```

BUMP

Token: \$CE \$03

Format: **b** = **BUMP**(type)

Usage: Used to detect sprite-sprite (type=1) or sprite-data (type=2) collisions. the return value **b** is an 8-bit mask with one bit per sprite. The bit position corresponds to the sprite number. Each bit set in the return value indicates that the sprite for its position was involved in a collision since the last call of **BUMP**. Calling **BUMP** resets the collision mask, so you always get a summary of collisions encountered since the last call of **BUMP**.

Remarks: It's possible to detect multiple collisions, but you will need to evaluate the sprite coordinates to detect which sprites have collided.

Example: Using **BUMP**

```
10 S% = BUMP(1) : REM SPRITE-SPRITE COLLISION
20 IF (S% AND 6) = 6 THEN PRINT "SPRITE 1 & 2 COLLISION"
30 REM ---
40 S% = BUMP(2) : REM SPRITE-DATA COLLISION
50 IF (S% <> 0) THEN PRINT "SOME SPRITE HIT DATA REGION"
```

sprite	return	mask
0	1	0000 0001
1	2	0000 0010
2	4	0000 0100
3	8	0000 1000
4	16	0001 0000
5	32	0010 0000
6	64	0100 0000
7	128	1000 0000

BVERIFY

Token: \$FE \$28

Format: **BVERIFY filename [,P address] [,B bank] [,D drive] [,U unit]**

Usage: "Binary VERIFY" compares a memory range to a file of type **PRG**.

filename is either a quoted string, e.g. "**data**" or a string expression in brackets, e.g. (**FI\$**).

bank specifies the RAM bank to be used. If not specified, the current bank, as set with the last **BANK** statement, will be used.

address is the address where the comparison begins. If the parameter P is omitted, it is the load address that is stored in the first two bytes of the **PRG** file that will be used.

drive drive # in dual drive disk units.

The drive # defaults to **0** and can be omitted on single drive units such as the 1541, 1571, or 1581.

unit device number on the IEC bus. Typically in the range from 8 to 11 for disk units. If a variable is used, it must be placed in brackets. The unit # defaults to **8**.

Remarks: **BVERIFY** can only test for equality. It gives no information about the number, or position of different valued bytes. In direct mode **BVERIFY** exits either with the message **OK** or with **VERIFY ERROR**. In program mode, a **VERIFY ERROR** either stops execution or enters the **TRAP** error handler, if active.

Examples: Using **BVERIFY**

```
BVERIFY "ML DATA", P 32768, B0, U9
BVERIFY "SPRITES", P 1536
BVERIFY "ML ROUTINES", B1, P(DEC("9000"))
BVERIFY (FI$), B(BA%), P(PA), U(UN%)
```

CATALOG

Token: \$FE \$0C

Format: **CATALOG** [**filepattern**] [,W] [,R] [,D **drive**] [,U **unit**] \$ [**filepattern**] [,W] [,R] [,D **drive**] [,U **unit**]

Usage: Prints a file catalog/directory of the specified disk.

The **W** (Wide) parameter lists the directory three columns wide on the screen and pauses after the screen has been filled with a page (63 directory entries). Pressing any key displays the next page.

The **R** (Recoverable) parameter includes files in the directory which are flagged as deleted but still recoverable.

filepattern is either a quoted string, for example: "**da***" or a string expression in brackets, e.g. (**DIS**)

drive drive # in dual drive disk units.

The drive # defaults to **0** and can be omitted on single drive units such as the 1541, 1571, or 1581.

unit device number on the IEC bus. Typically in the range from 8 to 11 for disk units. If a variable is used, it must be placed in brackets. The unit # defaults to **8**.

Remarks: **CATALOG** is a synonym for **DIRECTORY** or **DIR** and produces the same listing. The **filepattern** can be used to filter the listing. The wildcard characters ***** and **?** may be used. Adding **,T=** to the pattern string, with **T** specifying a filetype of **P**, **S**, **U** or **R** (for **PRG**, **SEQ**, **USR**, **REL**) filters the output to that filetype.

The shortcut symbol **\$** can only be used in direct mode.

Examples: Using **CATALOG**

```
CATALOG
0 "BLACK SMURF" " BS 2A
508 "STORY PHOBOS" SEQ
27 "C8096" PRG
25 "C128" PRG
104 BLOCKS FREE.
```

```

CATALOG *,T=S"
0 "BLACK SMURF " BS 2A
508 "STORY PHOBOS" SEQ
104 BLOCKS FREE.

```

Below is an example showing how a directory looks with the **w**ide parameter:

```

DIR W
0 "BASIC EXAMPLES "
1 "BEGIN" P 1 "FREAD" P 2 "PAINT.COR" P
1 "BEND" P 1 "FRE" P 3 "PALETTE.COR" P
1 "BUMP" P 2 "GET#" P 1 "PEEK" P
1 "CHAR" P 1 "GETKEY" P 3 "PEN" P
1 "CHR$" P 1 "GET" P 1 "PLAY" P
4 "CIRCLE" P 2 "GOSUB" P 2 "POINTER" P
1 "CLOSE" P 2 "GOTO.COR" P 1 "POKE" P
1 "CLR" P 2 "GRAPHIC" P 1 "POS" P
2 "COLLISION" P 1 "HELP" P 1 "POT" P
1 "CURSOR" P 1 "IF" P 1 "PRINT#" P
0 "DATA BASE" R 2 "INPUT#" P 1 "PRINT" P
1 "DATA" P 2 "INPUT" P 1 "RCOLOR.COR" P
1 "DEF FN" P 2 "JOY" P 1 "READ" P
1 "DIM" P 1 "LINE INPUT#" P 1 "RECORD" P
1 "DO" P 3 "LINE" P 1 "REM" P
5 "ELLIPSE" P 1 "LOOP" P 1 "RESTORE" P
1 "ELSE" P 1 "MID$" P 1 "RESUME" P
1 "EL" P 1 "MOD" P 1 "RETURN" P
1 "ENVELOPE" P 1 "MOVSPR" P 1 "REVERS" S
2 "EXIT" P 1 "NEXT" P 3 "RGRAPHIC" P
1 "FOR" P 2 "ON" P 1 "RMOUSE" P

```

CHANGE

Token: \$FE \$2C

Format: **CHANGE** "findstring" TO "replacestring" [,from-to]

Usage: **CHANGE** performs a **find and replace** of the BASIC program that is currently in memory. An optional line range **from-to** limits the search to this range, otherwise the whole BASIC program is searched. At each occurrence of the **findstring**, the line is listed and the user is prompted for an action:

- **Y** **RETURN** perform the replace and find the next string
- **N** **RETURN** do **not** perform the replace and find the next string
- ***** **RETURN** replace the current and all following matches
- **RETURN** exit the command, and don't replace the current match

Remarks: Any character may be used except the double quote (") character in the the findstring and replacestring. Using the double quote character (") finds text strings that are not tokenised, and therefore not part of a keyword.

For example, **CHANGE "LOOP" TO "OOPS"** will not find the BASIC keyword **LOOP**, because the keyword is stored as a token and not as text. However **CHANGE &LOOP& TO &OOPS&** will find and replace it (possibly causing SYNTAX ERRORS).

Can only be used in direct mode.

Examples: Using **CHANGE**

```
CHANGE "XX$" TO "UU$", 2000-2700
CHANGE &IN& TO &OUT&
```

CHAR

Token: \$E0

Format: **CHAR column, row, height, width, direction, string [, address of character set]**

Usage: Displays text on a graphic screen. It can be used in all resolutions.

column (in units of character positions) is the start position of the output in horizontally. As each column unit is 8 pixels wide, a screen width of 320 has a column range of 0-39, while a screen width of 640 has a column range of 0-79.

row (in pixel units) is the start position of the output in vertically. In contrast to the column parameter, its unit are in pixels (not character positions), with the top row having the value 0.

height is a factor applied to the vertical size of the characters, where 1 is normal size (8 pixels) 2 is double size (16 pixels), and so on.

width is a factor applied to the horizontal size of the characters, where 1 is normal size (8 pixels) 2 is double size (16 pixels), and so on.

direction controls the printing direction:

- 1: up
- 2: right
- 4: down
- 8: left

The optional **address of character set** can be used to select a character set, different to the default character set at \$29800, which includes upper and lower case characters.

Three character sets (see also **FONT**) are available:

- \$29000 Font A (ASCII)
- \$3D000 Font B (Bold)
- \$2D000 Font C (CBM)

The first part of the font (upper case / graphics) is stored at \$xx000 - \$xx7FF.

The second part of the font (lower case / upper case) is stored at \$xx800 - \$xxFFF.

string is a string constant or expression which will be printed. This string may optionally contain one or more of the following control characters:

CHR\$(6)	CTRL+F	flip character
CHR\$(18)	RVSON	reverse
CHR\$(146)	RVSOFF	reverse off
CHR\$(21)	CTRL+U	underline
CHR\$(25)+"-"	CTRL+Y + "-"	rotate left
CHR\$(25)+"+"	CTRL+Y + "+"	rotate right
CHR\$(26)	CTRL+Z	mirror

Remarks: Regular text mode control characters, such as cursor movement codes, will be ignored (neither printed nor interpreted).

Notice that the start position of the string has different units in the horizontal and vertical directions. Horizontal is in columns and vertical is in pixels.

Refer to the **CHR\$** command on page B-38 for more information.

Example: Using **CHAR**

```
10 SCREEN 640,400,2
20 CHAR 28,180,4,4,2,"MEGA65",529000
30 GETKEY A$
40 SCREEN CLOSE
```

Will print the text "MEGA65" at the centre of a 640 x 400 graphic screen.

CHR\$

Token: \$C1

Format: CHR\$(numeric expression)

Usage: Returns a string containing one character, whose PETSCII value is equal to the argument.

Remarks: The argument range is from 0 - 255, so this function may also be used to insert control codes into strings. Even the NULL character, with code 0, is allowed.

CHR\$ is the inverse function to **ASC**. The complete table of characters (and their PETSCII codes) is on page C-3.

Example: Using **CHR\$**

```
10 QUOTE$ = CHR$(34)
20 ESCAPE$ = CHR$(27)
30 PRINT QUOTE$;"MEGAB$";QUOTE$ : REM PRINT "MEGAB$"
40 PRINT ESCAPE$;"Q"; : REM CLEAR TO END OF LINE
```

CIRCLE

Token: \$E2

Format: **CIRCLE** *xcentre, ycentre, radius, [,solid]*

Usage: A special case of **ELLIPSE**, using the same value for horizontal and vertical radius.

xcentre x coordinate of the centre in pixels

ycentre y coordinate of the centre in pixels

radius radius of the circle in pixels

solid fills the circle, if not zero

Remarks: **CIRCLE** is used to draw circles on screens with an aspect ratio of 1:1 (for example: 320 x 200 or 640 x 400). Whilst using other resolutions (such as 640 x 200), the shape will instead be an ellipse.

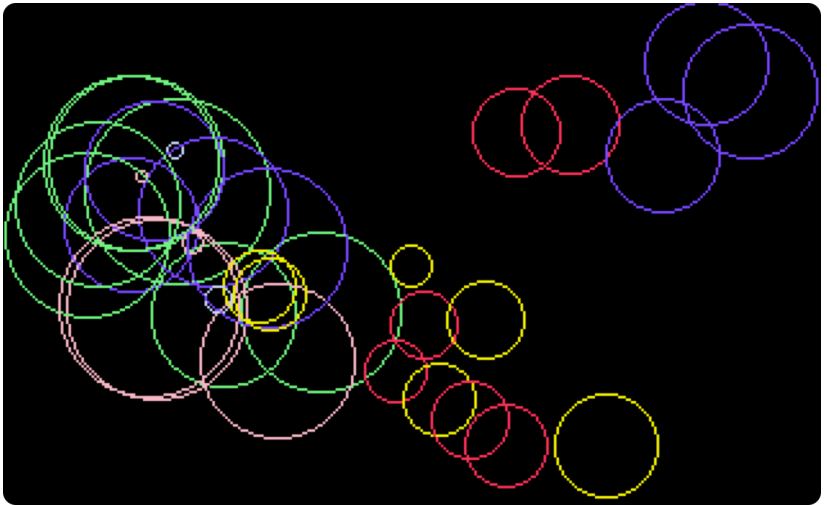

Example: Using **CIRCLE**

```
100 REM CIRCLE (AFTER F.BOWEN)
110 BORDER 0 :REM BLACK
120 SCREEN 320,200,4 :REM SIMPLE SCREEN SETUP
130 PALETTE 0,0,0,0,0 :REM BLACK
140 PALETTE 0,1,RND(.*16,RND(.*16),15 :REM RANDOM COLOURS
150 PALETTE 0,2,RND(.*16,15,RND(.*16
160 PALETTE 0,3,15,RND(.*16,RND(.*16
170 PALETTE 0,4,RND(.*16,RND(.*16,15
180 PALETTE 0,5,RND(.*16,15,RND(.*16
190 PALETTE 0,6,15,RND(.*16,RND(.*16
200 SCNCLR 0 :REM CLEAR
210 FORI=0TO32 :REM CIRCLE LOOP
220 PEN 0,RND(.*6+1 :REM RANDOM PEN
230 R=RND(.*36+1 :REM RADIUS
240 XC=R+RND(.*320:IF(XC+R)>319THEN240:REM X CENTRE
250 YC=R+RND(.*200:IF(YC+R)>199THEN250:REM Y CENTRE
260 XC=XC+WT*320:YC=YC+HT*200
270 CIRCLE XC,YC,R, :REM DRAW
280 NEXT
290 GETKEY A$: :REM WAIT FOR KEY
300 SCREEN CLOSE: BORDER 6
```

CLOSE

Token: \$A0

Format: **CLOSE channel**

Usage: Closes an input or output channel.

channel number, which was given to a previous call of commands such as **APPEND**, **DOPEN**, or **OPEN**.

Remarks: Closing files that have previously been opened before a program has completed is very important, especially for output files. **CLOSE** flushes output buffers and updates the directory information on disks. Failing to **CLOSE** can corrupt files and disks. BASIC does NOT automatically close channels nor files when a program stops.

Example: Using **CLOSE**

```
10 OPEN 2,8,2,"TEST,S,W"  
20 PRINT#2,"TESTSTRING"  
30 CLOSE 2 : REM OMITTING CLOSE GENERATES A SPLAT FILE
```

CLR

Token: \$9C

Format: CLR

CLR V Used for management of BASIC variables, arrays and strings. The run-time stack pointers, and the table of open channels is reset After executing a **CLR** all variables and arrays will be undeclared. **RUN** performs **CLR** automatically.

CLR V clears (zeroes) the variable V. V can be a numeric variable or a string variable, but not an array.

Remarks: **CLR** should not be used inside loops or subroutines, as it destroys the return address. After a **CLR**, all variables are unknown and will be initialised when they are next used.

Example: Using **CLR**

```
10 A=5: P$="MEGAB5"  
20 CLR  
30 PRINT A;P$  
RUN  
  
0
```

CMD

Token: \$9D

Format: **CMD channel [,string]**

Usage: Redirects the standard output from screen to a channel. This enables you to print listings and directories to other output channels. It is also possible to redirect this output to a disk file, or a modem.

channel number, which was given to a previous call of commands such as **APPEND**, **DOPEN**, or **OPEN**.

The optional **string** is sent to the channel before the redirection begins and can be used, for example, for printer or modem setup escape sequences.

Remarks: The **CMD** mode is stopped by a **PRINT#**, or by closing the channel with **CLOSE**. It is recommended to use **PRINT#** before closing, to make sure that the output buffer has been flushed.

Example: Using **CMD** to print a program listing:

```
OPEN 1,4 :REM OPEN CHANNEL #1 TO PRINTER AT UNIT 4
CMD 1
LIST
PRINT#1
CLOSE 1
```

COLLECT

Token: \$F3

Format: **COLLECT** [**D drive**] [**U unit**]

Usage: Rebuilds the **BAM** (Block Availability Map) of a disk, deleting splat files (files which have been opened, but not properly closed) and marking unused blocks as free.

drive drive # in dual drive disk units.

The drive # defaults to **0** and can be omitted on single drive units such as the 1541, 1571, or 1581.

unit device number on the IEC bus. Typically in the range from 8 to 11 for disk units. If a variable is used, it must be placed in brackets. The unit # defaults to **8**.

Remarks: While this command is useful for cleaning a disk from splat files, it is dangerous for disks with boot blocks or random access files. These blocks are not associated with standard disk files and will therefore be marked as free and may be overwritten by further disk write operations.

Examples: Using **COLLECT**

```
COLLECT
COLLECT U9
COLLECT D0, U9
```

COLLISION

Token: \$FE \$17

Format: **COLLISION** type [,linenumber]

Usage: Enables or disables a user-programmed interrupt handler. A call without the linenumber argument disables the handler, while a call with linenumber enables it. After the execution of **COLLISION** with linenumber, a sprite collision of the same type, (as specified in the **COLLISION** call) interrupts the BASIC program and performs a **GOSUB** to **linenumber**, which is expected to contain the user code for handling sprite collisions. This handler must give control back with a **RETURN**.

type specifies the collision type for this interrupt handler:

- 1 | sprite - sprite collision
- 2 | sprite - data - collision
- 3 | light pen

linenumber must point to a subroutine which has code for handling sprite collision and ends with a **RETURN**.

Remarks: It is possible to enable the interrupt handler for all types, but only one can execute at any time. An interrupt handler cannot be interrupted by another interrupt handler. Functions such as **BUMP**, **RSPPOS** and **LPEN** may be used for evaluation of the sprites which are involved, and their positions.

Example: Using **COLLISION**

```
10 COLLISION 1,70 : REM ENABLE
20 SPRITE 1,1 : MOVSPR 1,120, 0 : MOVSPR 1,0H5
30 SPRITE 2,1 : MOVSPR 2,120,100 : MOVSPR 2,180H5
40 FOR I=1 TO 50000:NEXT
50 COLLISION 1 : REM DISABLE
60 END
70 REM SPRITE (->) SPRITE INTERRUPT HANDLER
80 PRINT "BUMP RETURNS";BUMP(1)
90 RETURN: REM RETURN FROM INTERRUPT
```

COLOR

Token: \$E7

Format: **COLOR** <ON|OFF>

Usage: Enables or disables handling of character attributes on screen. If **COLOR** is **ON**, the screen routines take care of both character RAM and attribute RAM (or colour RAM). For example, if the screen is scrolling text, the attributes are also scrolled, so each character keeps its attribute. If **COLOR** is **OFF**, the attribute is fixed and only character movement is performed for screen characters. This speeds up screen handling, which could be useful when moving characters with different colours is not intended.

Example: **COLOR ON** - with colour/attribute handling
COLOR OFF - no colour/attribute handling

CONCAT

Token: \$FE \$13

Format: **CONCAT** **appendfile** [,D drive] **TO** **targetfile** [,D drive] [,U unit]

Usage: **CONCAT** (concatenation) appends the contents of **appendfile** to the **targetfile**. Afterwards, **targetfile** contains the contents of both files, while **appendfile** remains unchanged.

appendfile is either a quoted string, for example: **"data"** or a string expression in brackets, for example: **(FI\$)**

targetfile is either a quoted string, for example: **"safe"** or a string expression in brackets, for example: **(F\$S)**

If the disk unit has dual drives, it is possible to apply **CONCAT** to files which are stored on different disks. In this case, it is necessary to specify the drive# for both files. This is also necessary if both files are stored on drive#1.

drive drive # in dual drive disk units.

The drive # defaults to **0** and can be omitted on single drive units such as the 1541, 1571, or 1581.

unit device number on the IEC bus. Typically in the range from 8 to 11 for disk units. If a variable is used, it must be placed in brackets. The unit # defaults to **8**.

Remarks: **CONCAT** is executed in the DOS of the disk drive. Both files must exist and no pattern matching is allowed. Only files of type **SEQ** may be concatenated.

Examples: Using **CONCAT**

```
CONCAT "NEW DATA" TO "ARCHIVE" ,U9  
CONCAT "ADDRESS",D0 TO "ADDRESS BOOK",D1
```

CONT

Token: \$9A

Format: CONT

Usage: Used to resume program execution after a break or stop caused by an **END** or **STOP** statement, or by pressing . This is a useful debugging tool. The BASIC program may be stopped and variables can be examined, and even changed. The **CONT** statement resumes execution.

Remarks: **CONT** cannot be used, if a program has stopped because of an error. Also ,any editing of a program inhibits continuation. Stopping and continuation can spoil the screen output, and can also interfere with input/output operations.

Example: Using **CONT**

```
10 I=I+1:GOTO 10
RUN

BREAK IN 10
READY.
PRINT I
947
CONT
```

COPY

Token: \$F4

Format: **COPY** source [,D drive] [,U unit] **TO** [target] [,D drive] [,U unit]

Usage: Copies the contents of **source** to **target**. It is used to copy either single files or, by using wildcard characters, multiple files.

source is either a quoted string, e.g. "**data**" or a string expression in brackets, e.g. (**FI**\$).

target is either a quoted string, e.g. "**backup**" or a string expression in brackets, e.g. (**FSS**).

drive drive # in dual drive disk units.

The drive # defaults to **0** and can be omitted on single drive units such as the 1541, 1571, or 1581.

unit device number on the IEC bus. Typically in the range from 8 to 11 for disk units. If a variable is used, it must be placed in brackets. The unit # defaults to **8**.

If none or one unit number is given, or the unit numbers before and after the **TO** token are equal, **COPY** is executed on the disk drive itself, and the source and target files will be on the same disk.

If the source unit (before **TO**) is different to the target unit (after **TO**), **COPY** is executed in MEGA65 BASIC by reading the source files into a RAM buffer and writing to the target unit. In this case, the target file name cannot be chosen, it will be the same as the source filename. The extended unit-to-unit copy mode allows the copying of single files, pattern matching files or all files of a disk. Any combination of units is allowed, internal floppy, SD card images, IEC floppy drives such as the 1541, 1571, 1581, or CMD floppy and hard drives.

Remarks: The file types **PRG**, **SEQ** and **USR** can be copied. If source and target are on the same disk, the target filename must be different from the source file name.

COPY cannot copy **DEL** files, that are commonly used as titles or separators in disk directories. These do not conform to Commodore DOS rules and cannot be accessed by standard **OPEN** routines.

REL files cannot be copied from unit to unit.

Examples: Using **COPY**

```
COPY U8 TO U9      :REM COPY ALL FILES
COPY "CODES" TO "BACKUP" :REM COPY SINGLE FILE
COPY "*.TXT",U8 TO U9 :REM PATTERN COPY
COPY "M*",U9 TO U11 :REM PATTERN COPY
```

COS

Token: \$BE

Format: **COS**(numeric expression)

Usage: Returns the cosine of the argument. The argument is expected in units of **radians**. The result is in the range (-1.0 to +1.0)

Remarks: An argument in units of **degrees** can be converted to **radians** by multiplying it with $\pi/180$.

Examples: Using **COS**

```
PRINT COS(0.7)
0.76484219

X=60:PRINT COS(X *  $\pi$  / 180)
0.5
```

CURSOR

Format: **CURSOR** [<ON/OFF>] [,column] [,row] [,style]

Usage: Moves the text cursor to the specified position on the current text screen.

ON or **OFF** displays or hides the cursor.

column and **row** specify the new position.

style defines a solid (1) or flashing (0) cursor.

Example: Using **CURSOR**

```
10 CURSOR ON,1,2,1 :REM SET SOLID CURSOR AT COLUMN 1, ROW 2
```

DATA

Token: \$83

Format: DATA [list of constants]

Usage: Used to define constants which can be read by **READ** statements in a program. Numbers and strings are allowed, but expressions are not. Items are separated by commas. Strings containing commas, colons or spaces must be placed in quotes.

RUN initialises the data pointer to the first item of the first **DATA** statement and advances it for every read item. It is the programmer's responsibility that the type of the constant and the variable in the **READ** statement match. Empty items with no constant between commas are allowed and will be interpreted as zero for numeric variables and an empty string for string variables.

RESTORE may be used to set the data pointer to a specific line for subsequent reads.

Remarks: It is good programming practice to put large amounts of **DATA** statements at the end of the program, so they don't slow down the search for line numbers after **GOTO**, and other statements with line number targets.

Example: Using **DATA**

```
1 REM DATA
10 READ NA$, VE
20 READ NX : FOR I=2 TO NX : READ GL(I) : NEXT I
30 PRINT "PROGRAM:";NA$;" VERSION:";VE
40 PRINT "N-POINT GAUSSLEGENDRE FACTORS E1":
50 FOR I=2 TO NX:PRINT I;GL(I):NEXT I
60 END
80 DATA "MEGAB5",1.1
90 DATA 5,0.5120,0.3573,0.2760,0.2252

RUN
PROGRAM:MEGAB5 VERSION: 1.1
N-POINT GAUSSLEGENDRE FACTORS E1
2 0.512
3 0.3573
4 0.276
5 0.2252
```

DCLEAR

Token: \$FE \$15

Format: **DCLEAR** [**D drive**] [**U unit**]

Usage: Sends an initialise command to the specified unit and drive.

drive drive # in dual drive disk units.

The drive # defaults to **0** and can be omitted on single drive units such as the 1541, 1571, or 1581.

unit device number on the IEC bus. Typically in the range from 8 to 11 for disk units. If a variable is used, it must be placed in brackets. The unit # defaults to **8**.

The DOS of the disk drive will close all open files, clear all channels, free buffers and re-read the BAM. All open channels on the computer will also be closed.

Examples: Using **DCLEAR**

```
DCLEAR
DCLEAR U9
DCLEAR D0, U9
```

DCLOSE

Token: \$FE \$OF

Format: **DCLOSE** [# channel] [,U unit]

Usage: Closes a single file or all files for the specified unit.

channel number, which was given to a previous call to commands such as **APPEND**, **DOPEN**, or **OPEN**.

unit device number on the IEC bus. Typically in the range from 8 to 11 for disk units. If a variable is used, it must be placed in brackets. The unit # defaults to **8**.

DCLOSE is used either with a channel argument or a unit number, but never both.

Remarks: It is important to close all open files before a program ends. Otherwise buffers will not be freed and even worse, open files that have been written to may be incomplete (commonly called splat files), and no longer usable.

Examples: Using **DCLOSE**

```
DCLOSE#2 :REM CLOSE FILE ASSIGNED TO CHANNEL 2
DCLOSE U9:REM CLOSE ALL FILES OPEN ON UNIT 9
```

DEC

Token: \$D1

Format: **DEC(string expression)**

Usage: Returns the decimal value of the argument, that is written as a hex string. The argument range is "0000" to "FFFF" (0 to 65535 in decimal). The argument must have 1-4 hex digits.

Remarks: Allowed digits in uppercase/graphics mode are:
0 123456789ABCDEF and in lowercase/uppercase mode:
0 123456789abcdef.

Example: Using **DEC**

```
PRINT DEC("D000")
53248
POKE DEC("600"),255
```

DEF FN

Token: \$96

Format: DEF FN name(real variable)

Usage: Defines a single statement user function with one argument of type real, returning a real value. The definition must be executed before the function can be used in expressions. The argument is a dummy variable, which will be replaced by the argument when the function is used.

Remarks: The value of the dummy variable will not change and the variable may be used in other contexts without side effects.

Example: Using DEF FN

```
10 PD = pi / 180
20 DEF FN CD(X)= COS(X*PD): REM COS FOR DEGREES
30 DEF FN SD(X)= SIN(X*PD): REM SIN FOR DEGREES
40 FOR D=0 TO 360 STEP 90
50 PRINT USING "###";D
60 PRINT USING "###.###";FNCD(D);
70 PRINT USING "###.###";FNSD(D)
80 NEXT D
RUN
 0 1.00 0.00
 90 0.00 1.00
180 -1.00 0.00
270 0.00 -1.00
360 1.00 0.00
```

DELETE

Token: \$F7

Format: **DELETE** [**line range**]
DELETE **filename** [**D drive**] [**U unit**] [**R**]

Usage: Used to either delete a range of lines from the BASIC program or to delete file from disk.

line range consists of the first and last line to delete, or a single line number. If the first number is omitted, the first BASIC line is assumed. The second number in the range specifier defaults to the last BASIC line.

filename is either a quoted string, for example: **"safe"** or a string expression in brackets, for example: **(FSS)**

drive drive # in dual drive disk units.

The drive # defaults to **0** and can be omitted on single drive units such as the 1541, 1571, or 1581.

unit device number on the IEC bus. Typically in the range from 8 to 11 for disk units. If a variable is used, it must be placed in brackets. The unit # defaults to **8**.

R Recover a previously deleted file. This will only work if there were no write operations between deletion and recovery, which may have altered the contents of the file.

Remarks: **DELETE filename** works similar to **SCRATCH filename**.

Examples: Using **DELETE**

```
DELETE 100      :REM DELETE LINE 100
DELETE 240-350  :REM DELETE ALL LINES FROM 240 TO 350
DELETE 500-     :REM DELETE FROM 500 TO END
DELETE -70     :REM DELETE FROM START TO 70

DELETE "DRM",U9 :REM DELETE FILE DRM ON UNIT 9
```

DIM

Token: \$86

Format: **DIM name(limits) [,name(limits)]...**

Usage: Declares the shape, the bounds and the type of a BASIC array. As a declaration statement, it must be executed only once and before any usage of the declared arrays. An array can have one or more dimensions. One dimensional arrays are often called vectors while two or more dimensions define a matrix. The lower bound of a dimension is always zero, while the upper bound is declared. The rules for variable names apply for array names as well. There are integer arrays, real arrays and string arrays. It is legal to use the same identifier for scalar variables and array variables. The left parenthesis after the name identifies array names.

Remarks: Integer arrays consume two bytes per element, real arrays five bytes and string arrays three bytes for the string descriptor plus the length of the string itself.

If an array identifier is used without being previously declared, an implicit declaration of an one dimensional array with limit of 10 is performed.

Example: Using **DIM**

```
1 REM DIM
10 DIM A%(8) : REM ARRAY OF 9 ELEMENTS
20 DIM XX(2,3) : REM ARRAY OF 3X4 = 12 ELEMENTS
30 FOR I=0 TO 8 : A%(I)=PEEK(256+I) : PRINT A%(I);: NEXT:PRINT
40 FOR I=0 TO 2 : FOR J=0 TO 3 : READ XX(I,J):PRINT XX(I,J);: NEXT J,I
50 END
60 DATA 1,-2,3,-4,5,-6,7,-8,9,-10,11,-12

RUN
45 52 50 0 0 0 0 0 0
1 -2 3 -4 5 -6 7 -8 9 -10 11 -12
```

DIR

Token: \$EE (DIR) \$FE \$29 (ECTORY)

Format: **DIR** [**filepattern**] [**W**] [**R**] [**D drive**] [**U unit**] **DIRECTORY** [**filepattern**] [**W**] [**R**] [**D drive**] [**U unit**] \$ [**filepattern**] [**W**] [**R**] [**D drive**] [**U unit**]

Usage: Prints a file directory/catalog of the specified disk.

The **W** (Wide) parameter lists the directory three columns wide on the screen and pauses after the screen has been filled with a page (63 directory entries). Pressing any key displays the next page.

The **R** (Recoverable) parameter includes files in the directory, which are flagged as deleted but are still recoverable.

filepattern is either a quoted string, for example: "**da***" or a string expression in brackets, e.g. (**DIS**)

drive drive # in dual drive disk units.

The drive # defaults to **0** and can be omitted on single drive units such as the 1541, 1571, or 1581.

unit device number on the IEC bus. Typically in the range from 8 to 11 for disk units. If a variable is used, it must be placed in brackets. The unit # defaults to **8**.

Remarks: **DIR** is a synonym for **CATALOG** or **DIRECTORY**, and produces the same listing. The **filepattern** can be used to filter the listing. The wildcard characters ***** and **?** may be used. Adding **,T=** to the pattern string, with **T** specifying a filetype of **P**, **S**, **U** or **R** (for **PRG**, **SEQ**, **USR**, **REL**) filters the output to that filetype.

The shortcut symbol **\$** can only be used in direct mode.

Examples: Using **DIR**

```
DIR
0 "BLACK SMURF" "BS 2A"
508 "STORY PHOBOS" SEQ
27 "C8096" PRG
25 "C128" PRG
104 BLOCKS FREE.
```

For a **DIR** listing with the **w**ide parameter, please refer to the example under **CATALOG** on page B-34.

DISK

Token: \$FE \$40

Format: **DISK command** [,U unit] @ **command** [,U unit]

Usage: Sends a command string to the specified disk unit.

unit device number on the IEC bus. Typically in the range from 8 to 11 for disk units. If a variable is used, it must be placed in brackets. The unit # defaults to **8**.

command is a string expression.

Remarks: The command string is interpreted by the disk unit and must be compatible to the used DOS version. Read the disk drive manual for possible commands.

Using **DISK** with no parameters prints the disk status.

The shortcut symbol @ can only be used in direct mode.

Examples: Using **DISK**

```
DISK "I0" :REM INITIALISE DISK IN DRIVE 0  
DISK "U0>9" :REM CHANGE UNIT# TO 9
```

DLOAD

Token: \$F0

Format: **DLOAD filename [,D drive] [,U unit]**

Usage: "Disk **DLOAD**" loads a file of type **PRG** into memory reserved for BASIC programs.

filename is either a quoted string, e.g. "**data**" or a string expression in brackets, e.g. (**FI\$**).

drive drive # in dual drive disk units.

The drive # defaults to **0** and can be omitted on single drive units such as the 1541, 1571, or 1581.

unit device number on the IEC bus. Typically in the range from 8 to 11 for disk units. If a variable is used, it must be placed in brackets. The unit # defaults to **8**.

Remarks: The load address, which is stored in the first two bytes of the file is ignored. The program is loaded into BASIC memory. This enables loading of BASIC programs that were saved on other computers with different memory configurations. After loading, the program is re-linked and ready to be run or edited. It is possible to use **DLOAD** in a running program. This is called overlaying, or chaining. If you do this, then the newly loaded program replaces the current one, and the execution starts automatically on the first line of the new program. Variables, arrays and strings from the current run are preserved and can also be used by the newly loaded program.

Examples: Using **DLOAD**

```
DLOAD "APOCALYPSE"  
DLOAD "MEGA TOOLS",U9  
DLOAD (FI$),U(CUNX)
```

DMA

Token: \$FE \$1F

Format: **DMA command** [,length, source address, source bank, target address, target bank, sub]

Usage: **DMA** ("Direct Memory Access") is obsolete, and has been replaced by **EDMA**.

command 0 = copy, 1 = mix, 2 = swap, 3 = fill

length number of bytes

source address = 16-bit address of read area or fill byte

source bank bank number for source (ignored for fill mode)

target = 16-bit address of write area

target bank bank number for target

sub sub command

Remarks: **DMA** has access to the lower 1MB address range organised in 16 banks of 64 K. To avoid this limitation, use **EDMA**, which has access to the full 256MB address range.

Examples: A sequence of **DMA** calls to demonstrate fast screen drawing operations

```
DMA 0, 80*25, 2048, 0, 0, 4 :REM SAVE SCREEN TO $00000 BANK 4
DMA 3, 80*25, 32, 0, 2048, 0 :REM FILL SCREEN WITH BLANKS
DMA 0, 80*25, 0, 4, 2048, 0 :REM RESTORE SCREEN FROM $00000 BANK 4
DMA 2, 80, 2048, 0, 2048+80, 0 :REM SWAP CONTENTS OF LINE 1 & 2 OF SCREEN
```

DMODE

Token: \$FE \$35

Format: **DMODE jam,complement,inverse,stamp,style,thick**

Usage: "Display MODE" sets several parameters of the graphics context, which is used by drawing commands.

jam	0 - 1
complement	0 - 1
inverse	0 - 1
stamp	0 - 1
style	0 - 3
thick	1 - 8

DO

Token: \$EB

Format: **DO** ... **LOOP**
DO [<**UNTIL** | **WHILE**> <logical expression>]
... statements [**EXIT**]
LOOP [<**UNTIL** | **WHILE**> <logical expression>]

Usage: **DO** and **LOOP** define the start of a BASIC loop. Using **DO** and **LOOP** alone without any modifiers creates an infinite loop, which can only be exited by the **EXIT** statement. The loop can be controlled by adding **UNTIL** or **WHILE** after the **DO** or **LOOP**.

Remarks: **DO** loops may be nested. An **EXIT** statement only exits the current loop.

Examples: Using **DO** and **LOOP**

```
10 PW$="":DO
20 GET A$:PW$=PW$+A$
30 LOOP UNTIL LEN(PW$)>7 OR A$=CHR$(13)

10 DO : REM WAIT FOR USER DECISION
20 GET A$
30 LOOP UNTIL A$="Y" OR A$="N" OR A$="y" OR A$="n"

10 DO WHILE ABS(EPS) > 0.001
20 GOSUB 2000 : REM ITERATION SUBROUTINE
30 LOOP

10 I%=0 : REM INTEGER LOOP 1-100
20 DO I%=I%+1
30 LOOP WHILE I% < 101
```

DOPEN

Token: \$FE \$OD

Format: **DOPEN# channel, filename** [,L[reclen]] [,W] [,D drive] [,U unit]

Usage: Opens a file for reading or writing.

channel number, where:

- **1** <= **channel** <= **127** line terminator is CR.
- **128** <= **channel** <= **255** line terminator is CR LF.

L indicates, that the file is a relative file, which is opened for read/write, as well as random access. The reclength is mandatory for creating relative files. For existing relative files, the **reclen** is used as a safety check, if given.

W opens a file for write access. The file must not exist.

filename is either a quoted string, e.g. "**data**" or a string expression in brackets, e.g. (**FI\$**).

drive drive # in dual drive disk units.

The drive # defaults to **0** and can be omitted on single drive units such as the 1541, 1571, or 1581.

unit device number on the IEC bus. Typically in the range from 8 to 11 for disk units. If a variable is used, it must be placed in brackets. The unit # defaults to **8**.

Remarks: **DOPEN#** may be used to open all file types. The sequential file type **SEQ** is default. The relative file type **REL** is chosen by using the **L** parameter. Other file types must be specified in the filename, e.g. by adding ",P" to the filename for **PRG** files or ",U" for **USR** files.

If the first character of the filename is an at sign '@', it is interpreted as a "save and replace" operation. It is not recommended to use this option on 1541 and 1571 drives, as they contain a "save and replace bug" in their DOS.

Examples: Using **DOPEN**

```
DOPEN#5,"DATA",U9  
DOPEN#130,(DD$),U(UNZ)  
DOPEN#3,"USER FILE,U"  
DOPEN#2,"DATA BASE",L240  
DOPEN#4,"MYPRG,P" : REM OPEN PRG FILE
```

DPAT

Token: \$FE \$36

Format: DPAT **type** [,**number**, **pattern**, ...]

Usage: "Drawing PATtern" sets the pattern of the graphics context for drawing commands.

type	0-63
number	1-4
pattern	0-255

DS

Format: **DS** is a reserved system variable.

Usage: **DS** holds the status of the last disk operation. It is a volatile variable. Each use triggers the reading of the disk status from the current disk device in usage. **DS** is coupled to the string variable **DSS** which is updated at the same time. Reading the disk status from a disk device automatically clears any error status on that device, so subsequent reads will return 0, if no other activity was in between.

Example: Using **DS**

```
100 DOPEN#1,"DATA"  
110 IF DS<>0 THEN PRINT"COULD NOT OPEN FILE DATA":STOP
```

DS\$

Format: DS\$

Usage: DS\$ holds the status of the last disk operation in text form of the format: Code,Message,Track,Sector.

DS\$ is coupled to the numeric variable DS. It is updated when DS is used. DS\$ is set to "00,OK,00,00", if there was no error, otherwise it is set to a DOS error message (listed in the disk manuals).

Remarks: DS\$ is a reserved system variable.

Example: Using DS\$

```
100 OPEN#1,"DATA"  
110 IF DS<>0 THEN PRINT DS$:STOP
```

DSAVE

Token: \$EF

Format: **DSAVE filename** [,D drive] [,U unit]

Usage: "Disk SAVE" saves the BASIC program to a file of type **PRG**.

filename is either a quoted string, e.g. "**data**" or a string expression in brackets, e.g. (**FI\$**). The maximum length of the filename is 16 characters. If the first character of the filename is an at sign '@' it is interpreted as a "save and replace" operation. It is not recommended to use this option on 1541 and 1571 drives, as they contain a "save and replace bug" in their DOS.

drive drive # in dual drive disk units.

The drive # defaults to **0** and can be omitted on single drive units such as the 1541, 1571, or 1581.

unit device number on the IEC bus. Typically in the range from 8 to 11 for disk units. If a variable is used, it must be placed in brackets. The unit # defaults to **8**.

Remarks: The **DVERIFY** can be used after **DSAVE** to check, if the saved program on disk is identical to the program in memory.

Example: Using **DSAVE**

```
DSAVE "ADVENTURE"  
DSAVE "ZORK-1",U9  
DSAVE "DUNGEON",D1,U10
```

DT\$

Format: DT\$

Usage: DT\$ holds the current date and is updated before each usage from the RTC (Real-Time Clock). The RTC can be set in the Configure Menu. The string DT\$ is formatted as: "DD-MON-YYYY", for example: "04-APR-2021".

Remarks: DT\$ is a reserved system variable.

Example: Using DT\$

```
100 PRINT "TODAY IS: ";DT$
```

DVERIFY

Token: \$FE \$14

Format: **DVERIFY filename [,D drive] [,U unit]**

Usage: "Disk VERIFY" compares the BASIC program in memory with a disk file of type **PRG**.

filename is either a quoted string, e.g. "**data**" or a string expression in brackets, e.g. (**FI\$**).

drive drive # in dual drive disk units.

The drive # defaults to **0** and can be omitted on single drive units such as the 1541, 1571, or 1581.

unit device number on the IEC bus. Typically in the range from 8 to 11 for disk units. If a variable is used, it must be placed in brackets. The unit # defaults to **8**.

Remarks: **DVERIFY** can only test for equality. It gives no information about the number or position of different valued bytes. **DVERIFY** exits either with the message **OK** or with **VERIFY ERROR**.

Example: Using **DVERIFY**

```
DVERIFY "ADVENTURE"  
DVERIFY "ZORK-I",U9  
DVERIFY "DUNGEON",D1,U10
```

EDIT

Format: **EDIT <ON | OFF>**

Usage: **EDIT** switches the builtin editor either to text mode **EDIT ON** or BASIC program editor **EDIT OFF**.

After power up or reset, the editor is initialised as BASIC program editor.

After setting the editor to text mode with **EDIT ON**, the differences to program mode are:

The editor does no tokenising/parsing. All text entered after a linenumber remains pure text, BASIC keywords such as **FOR** and **GOTO** are not converted to BASIC tokens, as they are whilst in program mode.

The line numbers are only used for text organisation, sorting, deleting, listing etc. When the text is saved to file with **DSAVE**, a sequential file (type **SEQ**) is written, not a program (**PRG**) file, which is what happens whilst in program mode. Line numbers are not written to the file.

DLOAD in text mode can load only sequential files. Line numbers are automatically generated for editing purposes.

The mode of the editor can be recognised by looking at the prompt: In program mode, the prompt is: **READY.**, whilst in text mode the prompt is: **OK**.

The text mode affects entered lines with leading number only, lines with no linenumber are executed as BASIC commands, as usual.

Sequential files, created with the text editor, can be displayed (without loading them) on the screen by using **TYPE <filename>**.

Example: Using **EDIT**

```
ready.  
edit on  
  
ok.  
100 This is a simple text editor.  
dsave "example"  
  
ok.  
new  
  
ok.  
catalog  
  
0 "demoempty" " 00 3d  
1 "example" seq  
3159 blocks free  
  
ok.  
type "example"  
This is a simple text editor.  
  
ok.  
dload "example"  
  
loading  
  
ok.  
list  
  
1000 This is a simple text editor.  
  
ok.
```

EDMA

Token: \$FE \$2 1

Format: **EDMA command ,length, source, target [, sub , mod]**

Usage: **EDMA** ("Extended Direct Memory Access") is the fastest method to manipulate memory areas using the DMA controller.

command 0 = copy, 1 = mix, 2 = swap, 3 = fill.

length number of bytes (maximum = 65535).

source 28-bit address of read area or fill byte.

target 28-bit address of write area.

sub sub command (see chapter on DMA controller).

mod modifier (see chapter on DMA controller).

Remarks: **EDMA** can access the entire 256MB address range, using up to 28 bits for the addresses of the source and target.

Examples: Using **EDMA**

```
EDMA 0, $800, $F700, $8000000 :REM COPY SCALAR VARIABLES TO ATTIC RAM
EDMA 3, 80*25, 32, 2048       :REM FILL SCREEN WITH BLANKS
EDMA 0, 80*25, 2048, $8000800 :REM COPY SCREEN TO ATTIC RAM
```

EL

Format: EL

Usage: EL has the value of the line where the most recent BASIC error occurred, or the value -1 if there was no error.

Remarks: EL is a reserved system variable.

This variable is typically used in a TRAP routine, where the error line is taken from EL.

Example: Using EL

```
10 TRAP 100
20 PRINT SQR(-1) :REM PROVOKE ERROR
30 PRINT "AT LINE 30":REM HERE TO RESUME
40 END
100 IF ER>0 THEN PRINT ERR$(ER);" ERROR"
110 PRINT " IN LINE";EL
120 RESUME NEXT :REM RESUME AFTER ERROR
```

ELLIPSE

Token: \$FE \$30

Format: **ELLIPSE** *xcentre, ycentre, xradius, yradius, [,solid]*

Usage: Draws an ellipse.

xcentre x coordinate of centre in pixels.

ycentre y coordinate of centre in pixels.

xradius x radius of the ellipse in pixels.

yradius y radius of the ellipse in pixels.

solid fills the ellipse, if not zero.

Remarks: **ELLIPSE** is used to draw ellipses on screens at various resolutions. It can also be used to draw circles.

Example: Using **ELLIPSE**

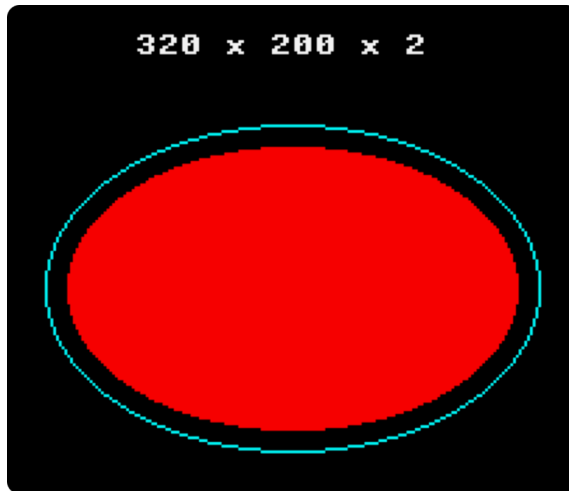

```

100 REM ELLIPSE
110 W=320:H=200:B%=2           :REM WIDTH, HEIGHT, DEPTH
120 X0=W/2:Y0=H/2:X0=W/4:Y0=H/4 :REM CENTRE AND HALF AXIS
130 BORDER 0                   :REM BLACK
140 BACKGROUND 0               :REM BLACK
150 FOREGROUND 5               :REM GREEN
160 SCREEN 320,200,B%         :REM SET PARAMETERS
170 PEN 2                       :REM DRAW PEN RED
180 ELLIPSE X0,Y0,X0,Y0,1      :REM DRAW SOLID ELLIPSE
190 PEN 3                       :REM DRAW PEN CYAN
200 ELLIPSE X0,Y0,X0+8,Y0+8,0  :REM DRAW OUTLINED ELLIPSE
210 A$=STR$(W)+" X"+STR$(H)+" X"+STR$(B%)
220 PEN 1                       :REM DRAW PEN WHITE
230 CHAR 12,10,1,1,2,A$       :REM DRAW TEXT
240 GETKEY A$                  :REM WAIT FOR KEYPRESS
250 SCREEN CLOSE               :REM CLOSE GRAPHICS

```

ELSE

Token: \$D5

Format: **IF expression THEN <true clause> ELSE <>false clause>**

Usage: **ELSE** is part of an **IF** statement.

expression a logical or numeric expression. A numeric expression is evaluated as **FALSE** if the value is zero and **TRUE** for any non-zero value.

true clause one or more statements starting directly after **THEN** on the same line. A line number after **THEN** performs a **GOTO** to that line instead.

false clause one or more statements starting directly after **ELSE** on the same line. A line number after **ELSE** performs a **GOTO** to that line instead.

Remarks: The standard **IF ... THEN ... ELSE** structure is restricted to a single line. But the **true clause** or **false clause** may be expanded to several lines using a compound statement surrounded with **BEGIN** and **BEND**.

Example: Using **ELSE**

```
100 REM ELSE
110 RED$=CHR$(28):BLACK$=CHR$(144):WHITE$=CHR$(5)
120 INPUT "ENTER A NUMBER";V
130 IF V<0 THENPRINT RED$;ELSEPRINT BLACK$;
140 PRINT V : REM PRINT NEGATIVE NUMBERS IN RED
150 PRINT WHITE$
160 INPUT "END PROGRAM:(Y/N)";A$
170 IF A$="Y" THENEND
180 IF A$="N" THEN120:ELSE160
```

END

Token: \$80

Format: END

Usage: Ends the execution of the BASIC program. The **READY.** prompt appears and the computer goes into direct mode waiting for keyboard input.

Remarks: **END** does **not** clear channels nor close files. Also, variable definitions are still valid after **END**. The program may be continued with the **CONT** statement. After executing the last line of a program, **END** is automatically executed.

Example: Using **END**

```
10 IF V < 0 THEN END : REM NEGATIVE NUMBERS END THE PROGRAM
20 PRINT V
```

ENVELOPE

Token: \$FE \$0A

Format: ENVELOPE n, [attack, decay, sustain, release, waveform, pw]

Usage: Used to define the parameters for the synthesis of a musical instrument.

n envelope slot (0-9).

attack attack rate (0-15).

decay decay rate (0-15).

sustain sustain rate (0-15).

release release rate (0-15).

waveform 0:triangle, 1:sawtooth, 2:square/pulse, 3:noise, 4:ring modulation.

pw pulse width (0-4095) for waveform.

There are 10 slots for storing instrument parameters, preset with following values:

n	A	D	S	R	WF	PW	Instrument
0	0	9	0	0	2	1536	piano
1	12	0	12	0	1		accordion
2	0	0	15	0	0		calliope
3	0	5	5	0	3		drum
4	9	4	4	0	0		flute
5	0	9	2	1	1		guitar
6	0	9	0	0	2	512	harpsichord
7	0	9	9	0	2	2048	organ
8	8	9	4	1	2	512	trumpet
9	0	9	0	0	0		xylophone

Example: Using **ENVELOPE**

```
10 ENVELOPE 9,10,5,10,5,2,4000
20 VOL 9
30 TEMPO 30
40 PLAY "T904Q CDEF6AB U3T8 CDEF6AB L","T503Q H CGEQG T7 HCGEQG L"
```

ERASE

Token: \$FE \$2A

Format: **ERASE filename** [**D drive**] [**U unit**] [**R**]

Usage: Used to erase a disk file.

filename is either a quoted string, e.g. **"data"** or a string expression in brackets, e.g. **(FI\$)**.

drive drive # in dual drive disk units.

The drive # defaults to **0** and can be omitted on single drive units such as the 1541, 1571, or 1581.

unit device number on the IEC bus. Typically in the range from 8 to 11 for disk units. If a variable is used, it must be placed in brackets. The unit # defaults to **8**.

R Recover a previously erased file. This will only work if there were no write operations between erasing and recovery, which may have altered the contents of the file.

Remarks: **ERASE filename** works similarly to **SCRATCH filename**.

The success and the number of erased files can be examined by printing or using the system variable **DS\$**. The second to last number from **DS\$** contains the number of successfully erased files, (normally the second to last number in **DS\$** contains the track number in case of a disk error).

Examples: Using **ERASE**

```
ERASE "DRM",U9 :REM ERASE FILE DRM ON UNIT 9
PRINT DS$
01, FILES SCRATCHED,01,00
ERASE "OLD*" :REM ERASE ALL FILES BEGINNING WITH "OLD"
PRINT DS$
01, FILES SCRATCHED,04,00
```

ER

Format: ER.

Usage: ER has the value of the most recent BASIC error that has occurred, or -1 if there was no error.

Remarks: ER is a reserved system variable.

This variable is typically used in a TRAP routine, where the error number is taken from ER.

Example: Using ER

```
10 TRAP 100
20 PRINT SQR(-1) :REM PROVOKE ERROR
30 PRINT "AT LINE 30":REM HERE TO RESUME
40 END
100 IF ER>0 THEN PRINT ERR$(ER);" ERROR"
110 PRINT " IN LINE";EL
120 RESUME NEXT :REM RESUME AFTER ERROR
```

ERR\$

Token: \$D3

Format: ERR\$(number)

Usage: Used to convert an error number to an error string.

number is a BASIC error number (1-41).

This function is typically used in a TRAP routine, where the error number is taken from the reserved variable **ER**.

Remarks: Arguments out of range (1-41) will produce an ILLEGAL QUANTITY error.

Example: Using ERR\$

```
10 TRAP 100
20 PRINT SQR(-1) :REM PROVOKE ERROR
30 PRINT "AT LINE 30":REM HERE TO RESUME
40 END
100 IF ER>0 THEN PRINT ERR$(ER);" ERROR"
110 PRINT " IN LINE";EL
120 RESUME NEXT :REM RESUME AFTER ERROR
```

EXIT

Token: \$FD

Format: EXIT

Usage: Exits the current **DO .. LOOP** and continues execution at the first statement after **LOOP**.

Remarks: In nested loops, **EXIT** exits only the current loop, and continues execution in an outer loop (if there is one).

Example: Using **EXIT**

```
1 REM EXIT
10 OPEN 2,8,0,"$" : REM OPEN CATALOG
15 IF DS THEN PRINT DS$: STOP: REM CANT READ
20 GET#2,D$,D$ : REM DISCARD LOAD ADDRESS
25 DO : REM LINE LOOP
30 GET#2,D$,D$ : REM DISCARD LINE LINK
35 IF ST THEN EXIT : REM END-OF-FILE
40 GET#2,LO,HI : REM FILE SIZE BYTES
45 S=LO + 256 * HI : REM FILE SIZE
50 LINE INPUT#2, F$ : REM FILE NAME
55 PRINT S;F$ : REM PRINT FILE ENTRY
60 LOOP
65 CLOSE 2
```

EXP

Token: \$BD

Format: **EXP(numeric expression)**

Usage: The **EXP** (EXponential function) computes the value of the mathematical constant Euler's number (**2.71828183**) raised to the power of the argument.

Remarks: An argument greater than 88 produces an OVERFLOW ERROR:

Examples: Using **EXP**

```
PRINT EXP(1)
2.71828183

PRINT EXP(0)
1

PRINT EXP(LOG(2))
2
```

FAST

Token: \$FE \$25

Format: **FAST** [**speed**]

Usage: Set CPU clock to 1MHz, 3.5MHz or 40MHz.

speed CPU clock speed where:

- **1** sets CPU to 1MHz.
- **3** sets CPU to 3MHz.
- Anything other than **1** or **3** sets the CPU to 40MHz.

Remarks: Although it's possible to call **FAST** with any real number, the precision part (the decimal point and any digits after it), will be ignored.

FAST is a synonym of **SPEED**.

FAST has no effect if **POKE 0,65** has previously been used to set the CPU to 40MHz.

Example: Using **FAST**

```
10 FAST      :REM SET SPEED TO MAXIMUM (40 MHZ)
20 FAST 1    :REM SET SPEED TO 1 MHZ
30 FAST 3    :REM SET SPEED TO 3.5 MHZ
40 FAST 3.5  :REM SET SPEED TO 3.5 MHZ
```

FILTER

Token: \$FE \$03

Format: **FILTER** sid [,freq, lp, bp, hp, res]

Usage: Sets the parameters for a SID sound filter.

sid 1 : right SID, 2 : left SID

freq filter cut off frequency (0 -> 2047)

lp low pass filter (0:off, 1:on)

bp band pass filter (0:off, 1:on)

hp high pass filter (0:off, 1:on)

resonance resonance (0 -> 15)

Remarks: Missing parameters keep their current value. The effective filter is the sum of of all filter settings. This enables band reject and notch effects.

Example: Using **FILTER**

```
10 PLAY "T7X103P9C"
15 SLEEP 0.02
20 PRINT "LOW PASS SWEEP" :L=1:B=0:H=0:GOSUB 100
30 PRINT "BAND PASS SWEEP":L=0:B=1:H=0:GOSUB 100
40 PRINT "HIGH PASS SWEEP":L=0:B=0:H=1:GOSUB 100
50 GOTO 20
100 REM *** SWEEP ***
110 FOR F = 50 TO 1950 STEP 50
120 IF F >= 1000 THEN FF = 2000-F : ELSE FF = F
130 FILTER 1,FF,L,B,H,15
140 PLAY "X1"
150 SLEEP 0.02
160 NEXT F
170 RETURN
```

FIND

Token: \$FE \$2B

Format: **FIND** delimiter string delimiter [,from-to]

Usage: **FIND** is an editor command that can only be used in direct mode. It searches a given line range (if specified), otherwise the entire BASIC program is searched. At each occurrence of the "find string" the line is listed with the string highlighted.  can be used to pause the output.

Remarks: Any un-shifted character that is not part of the string can be used as delimiter.

However, using double quotes " as a delimiter has a special effect: The search text is not tokenised. **FIND "FOR"** will search for the three letters F, O, and R, not the BASIC keyword **FOR**. Therefore, it can find the word **FOR** in string constants or REM statements, but not in program code.

On the other hand, **FIND /FOR/** will find all occurrences of the BASIC keyword, but not the text "FOR" in strings.

Partial keywords cannot be searched. For example, **FIND /LOO/** will not find the keyword **LOOP**,

Example: Using **FIND**

```
READY.
LIST
10 REM PARROT COLOUR SCHEME
20 FONT B      :REM SERIF
30 FOREGROUND 5 :REM GREEN
40 BACKGROUND 0 :REM BLACK
50 HIGHLIGHT 4,0 :REM SYSTEM  PURPLE
60 HIGHLIGHT14,1 :REM REM      BLUE
70 HIGHLIGHT 7,2 :REM KEYWORD  YELLOW

READY.
FIND /OLO/

10 REM PARROT COLOUR SCHEME

READY.
FIND /HIGHLIGHT/

50 HIGHLIGHT 4,0 :REM SYSTEM  PURPLE
60 HIGHLIGHT14,1 :REM REM      BLUE
70 HIGHLIGHT 7,2 :REM KEYWORD  YELLOW

READY.
█
```

FN

Token: \$A5

Format: **FN name(numeric expression)**

Usage: **FN** functions are user-defined functions, that accept a numeric expression as an argument and return a real value. They must first be defined with **DEF FN** before being used.

Example: Using **FN**

```
10 PD = pi / 180
20 DEF FN CD(X)= COS(X*PD): REM COS FOR DEGREES
30 DEF FN SD(X)= SIN(X*PD): REM SIN FOR DEGREES
40 FOR D=0 TO 360 STEP 90
50 PRINT USING "###";D
60 PRINT USING " ###.##";FNCD(D);
70 PRINT USING " ###.##";FNSD(D)
80 NEXT D
RUN
 0 1.00 0.00
 90 0.00 1.00
180 -1.00 0.00
270 0.00 -1.00
360 1.00 0.00
```

FONT

Token: \$FE \$46

Format: FONT [A|B|C]

Usage: FONT is used to switch between fonts, and the code pages PETSCII, and enhanced PETSCII. The enhanced PETSCII includes all ASCII symbols that are missing in the PETSCII code page, although the order is still PETSCII. The ASCII symbols are typed by holding the  together with the desired key. The codes for uppercase and lowercase are swapped compared to ASCII. The uppercase/graphics code page is not changed.

code	key	PETSCII	ASCII
\$5C	pound	£	\
\$5E	up arrow	↑	^
\$5F	back arrow	←	_
\$7B	colon	†	{
\$7C	dot	‡	
\$7D	semicolon	‡	}
\$7E	comma	†	~

Examples: Using FONT

```
FONT A :REM ASCII - ENABLE {|}_~^
FONT B :REM LIKE A, WITH A SERIF FONT
FONT C :REM COMMODORE FONT (DEFAULT)
```

FOR

Token: \$81

Format: **FOR index=start TO end [STEP step] ... NEXT [index]**

Usage: **FOR** statements start the definition of a BASIC loop with an index variable.

index may be incremented or decremented by a constant value on each iteration. The default is to increment the variable by 1. The index variable must be a real variable.

start is used to initialise the index.

end is checked at the end of an iteration, and determines whether another iteration will be performed, or if the loop will exit.

step defines the change applied to the index variable at the end of an iteration. Positive step values increment it, while negative values decrement it. It defaults to 1.0 if not specified.

Remarks: For positive increments **end** must be greater than or equal to **start**, whereas for negative increments **end** must be less than or equal to **start**.

It is bad programming practice to change the value of the **index** variable inside the loop or to jump into or out of a loop body with **GOTO**.

Examples: Using **FOR**

```
10 FOR D=0 TO 360 STEP 30
20 R = D * π / 180
30 PRINT D;R;SIN(R);COS(R);TAN(R)
40 NEXT D

10 DIM M(20,20)
20 FOR I=0 TO 20
30 FOR J=I TO 20
40 M(I,J) = I + 100 * J
50 NEXT J,I
```

FOREGROUND

Token: \$FE \$39

Format: **FOREGROUND** colour

Usage: Sets the foreground colour (text colour) of the screen to the argument, which must be in the range of 0 to 15. Refer to the colour table under **BACKGROUND** on page B-18 for the **colour** values and their corresponding colours.

Example: Using **FOREGROUND**

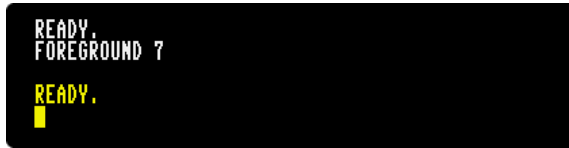

FRE

Token: \$B8

Format: **FRE(bank)**

Usage: Returns the number of free bytes for banks 0 or 1, or the ROM version if the argument is negative.

FRE(0) returns the number of free bytes in bank 0, which is used for BASIC program source.

FRE(1) returns the number of free bytes in bank 1, which is the bank for BASIC variables, arrays and strings. **FRE(1)** also triggers "garbage collection", which is a process that collects used strings at the top of the bank, thereby defragmenting string memory.

FRE(-1) returns the ROM version, a six-digit number of the form 92xxxx.

Example: Using **FRE**:

```
10 PM = FRE(0)
20 VM = FRE(1)
30 RV = FRE(-1)
40 PRINT PM;" FREE FOR PROGRAM"
50 PRINT VM;" FREE FOR VARIABLES"
60 PRINT RV;" ROM VERSION"
```

FREAD

Token: \$FE \$1C

Format: FREAD# channel, pointer, size

Usage: Reads **size** bytes from **channel** to memory starting at the 32-bit address **pointer**.

channel number, which was given to a previous call to commands such as **DOPEN**, or **OPEN**.

Care must be taken not to overwrite memory that is used by the system or the interpreter.

It is recommended to use the **POINTER** statement for the pointer argument, and to compute the size parameter by multiplying the number of elements with the item size.

type	item size
byte array	1
integer array	2
real array	5

Keep in mind that the **POINTER** function with a string argument does NOT return the string address, but the string descriptor. It is not recommended to use **FREAD** for strings or string arrays unless you are fully aware on how to handle the string storage internals.

Also, ensure that you always specify an index if you use an array. The start address of array XY() is **POINTER(XY(0))**. **POINTER(XY)** returns the address of the scalar variable XY.

Example: Using **FREAD**:

```
100 N=23
110 DIM B&(N),C&(N)
120 DOPEN#2,"TEXT"
130 FREAD#2,POINTER(B&(0)),N
140 DCLOSE#2
150 FOR I=0TO N-1:PRINTCHR$(B&(I));:NEXT
160 FOR I=0TO N-1:C&(I)=B&(N-1-I):NEXT
170 DOPEN#2,"REVERS",W
180 FWRITE#2,POINTER(C&(0)),N
190 DCLOSE#2
```

FWRITE

Token: \$FE \$1E

Format: FWRITE# channel, pointer, size

Usage: Writes **size** bytes to **channel** from memory starting at the 32-bit address **pointer**.

channel number, which was given to a previous call to commands such as **APPEND**, **DOPEN**, or **OPEN**.

It is recommended to use the **POINTER** statement for the pointer argument and compute the size parameter by multiplying the number of elements with the item size.

Refer to the **FREAD** item size table on page B-96 for the item sizes.

Keep in mind that the **POINTER** function with a string argument does NOT return the string address, but the string descriptor. It is not recommended to use **FWRITE** for strings or string arrays unless you are fully aware on how to handle the string storage internals.

Also ensure that you always specify an index if you use an array. The start address of array XY() is POINTER(XY(0)). POINTER(XY) returns the address of the scalar variable XY.

Example: Using **FWRITE**:

```
100 N=23
110 DIM B$(N),C$(N)
120 DOPEN#2,"TEXT"
130 FREAD#2,POINTER(B$(0)),N
140 DCLOSE#2
150 FOR I=0TO N-1:PRINTCHR$(B$(I));:NEXT
160 FOR I=0TO N-1:C$(I)=B$(N-1-I):NEXT
170 DOPEN#2,"REVERS",W
180 FWRITE#2,POINTER(C$(0)),N
190 DCLOSE#2
```

GET

Token: \$A1

Format: **GET** variable

Usage: Gets the next character (or byte value of the next character) from the keyboard queue. If the variable being set to the character is of type string and the queue is empty, an empty string is assigned to it, otherwise a one character string is created and assigned instead. If the variable is of type numeric, the byte value of the key is assigned to it, otherwise zero will be assigned if the queue is empty. **GET** does not wait for keyboard input, so it's useful to check for key presses at regular intervals or in loops.

Remarks: **GETKEY** is similar, but waits until a key has been pressed.

Example: Using **GET**:

```
10 DO: GET A$: LOOP UNTIL A$ <> ""
40 IF A$ = "W" THEN 1000 :REM GO NORTH
50 IF A$ = "A" THEN 2000 :REM GO WEST
60 IF A$ = "S" THEN 3000 :REM GO EAST
70 IF A$ = "Z" THEN 4000 :REM GO SOUTH
80 IF A$ = CHR$(13) THEN 5000 :REM RETURN
90 GOTO 10
```

GET#

Token: \$A1 '#'

Format: **GET# channel, list of variables**

Usage: Reads as many bytes as necessary from the channel argument and assigns strings of length one to string variables, or an 8-bit binary value to numeric variables. This is useful for reading characters (or bytes) from an input stream one byte at a time.

channel number, which was given to a previous call to commands such as **DOPEN**, or **OPEN**.

Remarks: All values from 0 to 255 are valid, so **GET** can also be used to read binary data.

Example: Using **GET#** to read a disk directory:

```
1 REM GET#
10 OPEN 2,8,0,"$" : REM OPEN CATALOG
15 IF DS THEN PRINT DS$: STOP: REM CANT READ
20 GET#2,D$,D$ : REM DISCARD LOAD ADDRESS
25 DO : REM LINE LOOP
30 GET#2,D$,D$ : REM DISCARD LINE LINK
35 IF ST THEN EXIT : REM END-OF-FILE
40 GET#2,LO,HI : REM FILE SIZE BYTES
45 $=LO + 256 * HI : REM FILE SIZE
50 LINE INPUT#2, F$ : REM FILE NAME
55 PRINT $;F$ : REM PRINT FILE ENTRY
60 LOOP
65 CLOSE 2
```

GETKEY

Token: \$A1 \$F9 (GET token and KEY token)

Format: **GETKEY** variable

Usage: Gets the next character (or byte value of the next character) from the keyboard queue. If the queue is empty, the program will wait until a key has been pressed. After a key has been pressed the variable will be set and program execution will continue. When used with a string variable, a one character string is created and assigned. Otherwise if the variable is of type numeric, the byte value is assigned.

Example: Using **GETKEY**:

```
10 GETKEY A$ :REM WAIT AND GET CHARACTER
40 IF A$ = "W" THEN 1000 :REM GO NORTH
50 IF A$ = "A" THEN 2000 :REM GO WEST
60 IF A$ = "S" THEN 3000 :REM GO EAST
70 IF A$ = "Z" THEN 4000 :REM GO SOUTH
80 IF A$ = CHR$(13) THEN 5000 :REM RETURN
90 GOTO 10
```

GO64

Token: \$CB \$36 \$34 (GO token and 64)

Format: **GO64**

Usage: Switches the MEGA65 to C64-compatible mode. If you're in direct mode, a security prompt **ARE YOU SURE?** is displayed, which must be responded with **Y** to continue. **\$Y\$58552** can be used to switch back to C65-mode.

Example: Using **GO64**:

```
GO64
ARE YOU SURE?
```

GOSUB

Token: \$8D

Format: GOSUB line

Usage: **GOSUB** (GOto SUBroutine) continues program execution at the given BASIC line number, saving the current BASIC program counter and line number on the run-time stack. This enables the resumption of execution after the **GOSUB** statement, once a **RETURN** statement in the called subroutine is executed. Calls to subroutines via **GOSUB** may be nested, but the subroutines must always end with **RETURN**, otherwise a stack overflow may occur.

Remarks: Unlike other programming languages, BASIC65 does not support arguments or local variables for subroutines. Programs can be optimised by grouping subroutines at the beginning of the program source. The **GOSUB** calls will then have low line numbers with fewer digits to decode. The subroutines will also be found faster, since the search for subroutines often starts at the beginning of the program.

Example: Using **GOSUB**:

```
10 GOTO 100 :REM TO MAIN PROGRAM
20 REM *** SUBROUTINE DISK STATUS CHECK ***
30 DD=DS:IF DD THEN PRINT "DISK ERROR";DS$
40 RETURN
50 REM *** SUBROUTINE PROMPT Y/N ***
60 DO:INPUT "CONTINUE (Y/N)";A$
70 LOOP UNTIL A$="Y" OR A$="N"
80 RETURN
90 REM *** MAIN PROGRAM ***
100 DOPE#2,"BIG DATA"
110 GOSUB 30: IF DD THEN DCLOSE#2:GOSUB 60:REM ASK
120 IF A$="N" THEN STOP
130 GOTO 100: REM RETRY
```

GOTO

Token: \$89 (GOTO) or \$CB \$A4 (GO TO)

Format: **GOTO line**
GO TO line

Usage: Continues program execution at the given BASIC line number.

Remarks: If the target **line** number is higher than the current line number, the search starts from the current line, proceeding to higher line numbers. If the target **line** number is lower, the search starts at the first **line** number of the program. It is possible to optimise the run-time speed of the program by grouping often used targets at the start (with lower line numbers).

GOTO (written as a single word) executes faster than **GO TO**.

Example: Using **GOTO**:

```
10 GOTO 100 :REM TO MAIN PROGRAM
20 REM *** SUBROUTINE DISK STATUS CHECK ***
30 DD=DS:IF DD THEN PRINT "DISK ERROR";DS$
40 RETURN
50 REM *** SUBROUTINE PROMPT Y/N ***
60 DO:INPUT "CONTINUE (Y/N)";A$
70 LOOP UNTIL A$="Y" OR A$="N"
80 RETURN
90 *** MAIN PROGRAM ***
100 DOPEN#2,"BIG DATA"
110 GOSUB 30: IF DD THEN DCLOSE#2:GOTO 60:REM ASK
120 IF A$="N" THEN STOP
130 GOTO 100: REM RETRY
```

GRAPHIC

Token: \$DE

Format: GRAPHIC CLR

Usage: Initialises the BASIC graphic system. It clears the graphics memory and screen, and sets all parameters of the graphics context to their default values.

Once the graphics system has been cleared, commands such as **LINE**, **PALETTE**, **PEN**, **SCNCLR**, and **SCREEN** can be used to set graphic system parameters again.

Example: Using **GRAPHIC**:

```
100 REM GRAPHIC
110 GRAPHIC CLR      : REM INITIALISE
120 SCREEN DEF 1,1,1,2 : REM 640 X 400 X 2
130 SCREEN OPEN 1   : REM OPEN IT
140 SCREEN SET 1,1   : REM VIEW IT
150 PALETTE 1,0,0, 0,0 : REM BLACK
160 PALETTE 1,1,0,15,0 : REM GREEN
170 SCNCLR 0        : REM FILL SCREEN WITH BLACK
180 PEN 0,1         : REM SELECT PEN
190 LINE 50,50,590,350 : REM DRAW LINE
200 GETKEY AS       : REM WAIT FOR KEYPRESS
210 SCREEN CLOSE 1  : REM CLOSE SCREEN AND RESTORE PALETTE
```

HEADER

Token: \$F1

Format: **HEADER** **diskname** [,**lid**] [,**D drive**] [,**U unit**]

Usage: Used to format (or clear) a disk.

diskname is either a quoted string, e.g. "**data**" or a string expression in brackets, e.g. (**DNS**). The maximum length of **diskname** is 16 characters.

drive drive # in dual drive disk units.

The drive # defaults to **0** and can be omitted on single drive units such as the 1541, 1571, or 1581.

unit device number on the IEC bus. Typically in the range from 8 to 11 for disk units. If a variable is used, it must be placed in brackets. The unit # defaults to **8**.

Remarks: For new disks which have not already been formatted, it is necessary to specify the disk ID with the **lid** parameter. This switches the format command to full format, which writes sector IDs and erases all contents. This takes some time, as every block on the disk will be written.

If the **lid** parameter is omitted, a quick format will be performed. This is only possible if the disk has already been formatted. A quick format writes the new disk name and clears the block allocation map, marking all blocks as free. The disk ID is not changed, and blocks are not overwritten, so contents may be recovered with **ERASE R**. You can read more about **ERASE** on page B-83.

Examples: Using **HEADER**

```
HEADER "ADVENTURE",IDK : FORMAT DISK WITH NAME ADVENTURE AND ID DK
HEADER "ZORK-I",U9      : FORMAT DISK IN UNIT 9 WITH NAME ZORK-I
HEADER "DUNGEON",D1,U10: FORMAT DISK IN DRIVE 1 UNIT 10 WITH NAME DUNGEON
```

HELP

Token: \$EA

Format: **HELP**

Usage: When the BASIC program stops due to an error, **HELP** can be used to gain further information. The interpreted line is listed, with the erroneous statement highlighted or underlined.

Remarks: Displays BASIC errors. For errors related to disk I/O, the disk status variable **DS** or the disk status string **DSS** should be used instead.

Example: Using **HELP**

```
10 A=1,E20
20 B=A+A:C=EXP(A):PRINT A,B,C
RUN

?OVERFLOW ERROR IN 20
READY.
HELP

20 B=A+A:C=EXP(A):PRINT A,B,C
```

HEX\$

Token: \$D2

Format: HEX\$(numeric expression)

Usage: Returns a four character hexadecimal representation of the argument. The argument must be in the range of 0-65535, corresponding to the hex numbers \$0000-\$FFFF.

Remarks: If real numbers are used as arguments, the fractional part will be ignored. In other words, real numbers will not be rounded.

Example: Using HEX\$:

```
PRINT HEX$(10),HEX$(100),HEX$(1000.9)
000A    0064    03E8
```

HIGHLIGHT

Token: \$FE \$3D

Format: **HIGHLIGHT** colour [,mode]

Usage: Sets the colour to be used for the "highlight" text attribute. The colour value must be in the range of 0 to 15. Refer to the colour table under **BACKGROUND** on page B-18 for the **colour** values and their corresponding colours.

The optional parameter **mode** defines how BASIC listings are highlighted when listed:

- **mode 0** no syntax highlighting
- **mode 1** highlight REM statements
- **mode 2** highlight BASIC keywords

Remarks: The highlight text attribute is used to highlight text in listings generated by the **CHANGE, FIND, LIST, and HELP** commands.

Example: Using **HIGHLIGHT**

```
LIST
10 REM *** THIS IS HELLO WORLD ***
20 PRINT "HELLO WORLD"

READY.
HIGHLIGHT 8,2

READY.
LIST

10 REM *** THIS IS HELLO WORLD ***
20 PRINT "HELLO WORLD"

READY.
█
```

IF

Token: \$8B

Format: **IF expression THEN <true clause> ELSE <>false clause>**

Usage: Starts a conditional execution statement.

expression a logical or numeric expression. A numeric expression is evaluated as **FALSE** if the value is zero and **TRUE** for any non-zero value.

true clause one or more statements starting directly after **THEN** on the same line. A line number after **THEN** performs a **GOTO** to that line instead.

false clause one or more statements starting directly after **ELSE** on the same line. A line number after **ELSE** performs a **GOTO** to that line instead.

Remarks: The standard **IF ... THEN ... ELSE** structure is restricted to a single line. But the **true clause** or **false clause** may be expanded to several lines using a compound statement surrounded with **BEGIN** and **BEND**.

Example: Using **IF**

```
1 REM IF
10 RED$=CHR$(28) : BLACK$=CHR$(144) : WHITE$=CHR$(5)
20 INPUT "ENTER A NUMBER";V
30 IF V<0 THEN PRINT RED$; : ELSE PRINT BLACK$;
40 PRINT V : REM PRINT NEGATIVE NUMBERS IN RED
50 PRINT WHITE$
60 INPUT "END PROGRAM: (Y/N)"; A$
70 IF A$="Y" THEN END
80 IF A$="N" THEN 20 : ELSE 60
```

INPUT

Token: \$85

Format: INPUT [prompt <,|;>] variable list

Usage: Prints an optional prompt string and question mark to the screen, flashes the cursor and waits for user input from the keyboard.

prompt optional string expression to be printed as the prompt. If the separator between **prompt** and **variable list** is a comma, the cursor is placed directly after the prompt. If the separator is a semicolon, a question mark and a space is added to the prompt instead.

variable list list of one or more variables that receive the input.

The input will be processed after the user presses .

Remarks: The user must take care to enter the correct type of input, so it matches the **variable list** types. Also, the number of input items must match the number of variables. A surplus of input items will be ignored, too few input items trigger another request for input with the prompt ???. Typing non numeric characters for integer or real variables will produce a TYPE MISMATCH ERROR. Strings for string variables must be in double quotes (") if they contain spaces or commas. Many programs that need a safe input routine use **LINE INPUT** and a custom parser, in order to avoid program errors by wrong user input.

Example: Using **INPUT**:

```
10 DIM N$(100),A%(100),S$(100):
20 DO
30 INPUT "NAME, AGE, GENDER";NA$,AG%,SE$
40 IF NA$="" THEN 30
50 IF NA$="END" THEN EXIT
60 IF AG% < 18 OR AG% > 100 THEN PRINT "AGE?":GOTO 30
70 IF SE$ (<) "M" AND SE$ (<) "F" THEN PRINT "GENDER?":GOTO 30
80 REM CHECK OK: ENTER INTO ARRAY
90 N$(N)=NA$:A%(N)=AG%:S$(N)=SE$:N=N+1
100 LOOP UNTIL N=100
110 PRINT "RECEIVED";N;" NAMES"
```

INPUT#

Token: \$84

Format: **INPUT# channel, variable list**

Usage: Reads a record from an input device, e.g. a disk file and assigns the data to the variables in the list.

channel number, which was given to a previous call to commands such as **DOPEN**, or **OPEN**.

variable list list of one or more variables, that receive the input.

The input record must be terminated by a RETURN character and must be not longer than the input buffer (160 characters).

Remarks: The type and number of data in a record must match the variable list. Reading non numeric characters for integer or real variables will produce a FILE DATA ERROR. Strings for string variables have to be put in quotes if they contain spaces or commas.

LINE INPUT# may be used to read a whole record into a single string variable.

Sequential files, that can be read by **INPUT#** can be generated by programs with **PRINT#** or with the editor of the MEGA65. For example:

```
EDIT ON

10 "CHUCK PEDDLE",1937,"ENGINEER OF THE 6502"
20 "JACK TRAMIEL",1928,"FOUNDER OF CBM"
30 "BILL MENSCH",1945,"HARDWARE"

DSAVE "CBM-PEOPLE"
EDIT OFF
```

Example: Using **INPUT#**:

```
10 DIM N$(100),B%(100),S$(100):
20 DOPEN#2,"CBM-PEOPLE":REM OPEN SEQ FILE
25 IF DS THEN PRINT DS$:STOP:REM OPEN ERROR
30 FOR I=0 TO 100
40 INPUT#2,N$(I),B%(I),S$(I)
50 IF ST AND 64 THEN 80:REM END OF FILE
60 IF DS THEN PRINT DS$:GOTO 80:REM DISK ERROR
70 NEXT I
80 DCLOSE#2
110 PRINT "READ";I;" RECORDS"
120 FOR J=0 TO I:PRINT N$(I):NEXT J
```

```
RUN
CHUCK PEDDLE
JACK TRAMIEL
BILL MENSCH
```

```
TYPE "CBM-PEOPLE"
"CHUCK PEDDLE",1937,"ENGINEER OF THE 6502"
"JACK TRAMIEL",1928,"FOUNDER OF CBM"
"BILL MENSCH",1945,"HARDWARE"
```

INSTR

Token: \$D4

Format: **INSTR**(haystack, needle [,start])

Usage: Locates the position of the string expression **needle** in the string expression **haystack**, and returns the index of the first occurrence, or zero if there is no match.

The string expression **haystack** is searched for the occurrence of the string expression **needle**.

An enhanced version of string search using pattern matching is used if the first character of the search string is a pound sign '£'. The pound sign is not part of the search but enables the use of the '.' (dot) as a wildcard character, which matches any character. The second special pattern character is the '*' (asterisk). The asterisk in the search string indicates that the character preceding the asterisk may never occur in order to be considered as a match.

The optional argument **start** is an integer expression, which defines the starting position for the search in **haystack**. If not present, it defaults to one.

Remarks: If either string is empty or there is no match the function returns zero.

Examples: Using **INSTR**:

```
I = INSTR("ABCDEF","CD")      : REM I = 3
I = INSTR("ABCDEF","XY")      : REM I = 0
I = INSTR("RAIIN","£A*IN")    : REM I = 2
I = INSTR("ABCDEF","£C.E")    : REM I = 3
I = INSTR(A$+B$,C$)
```

INT

Token: \$B5

Format: **INT(numeric expression)**

Usage: Searches for the highest integer value that is less than or equal to the argument, and returns this value as a real number. This function is **NOT** limited to the typical 16-bit integer range (-32768 to 32767), as it uses real arithmetic. The allowed range is therefore determined by the size of the real mantissa which is 32-bits wide (-2147483648 to 2147483647).

Remarks: It is not necessary to use the **INT** function for assigning real values to integer variables, as this conversion will be done implicitly, but only for the 16-bit range.

Examples: Using **INT**:

```
X = INT(1.9)      :REM X = 1
X = INT(-3.1)     :REM X = -4
X = INT(100000.5) :REM X = 100000
M% = INT(100000.5) :REM ?ILLEGAL QUANTITY ERROR
```

JOY

Token: \$CF

Format: JOY(port)

Usage: Returns the state of the joystick for the selected port (1 or 2). Bit 7 contains the state of the fire button. The stick can be moved in eight directions, which are numbered clockwise starting at the upper position.

	left	centre	right
up	8	1	2
centre	7	0	3
down	6	5	4

Example: Using JOY:

```
10 N = JOY(1)
20 IF N AND 128 THEN PRINT "FIRE! ";
30 REM          N NE E SE S SW W NW
40 ON N AND 15 GOSUB 100,200,300,400,500,600,700,800
50 GOTO 10
100 PRINT "GO NORTH" :RETURN
200 PRINT "GO NORTHEAST":RETURN
300 PRINT "GO EAST" :RETURN
400 PRINT "GO SOUTHEAST":RETURN
500 PRINT "GO SOUTH" :RETURN
600 PRINT "GO SOUTHWEST":RETURN
700 PRINT "GO WEST" :RETURN
800 PRINT "GO NORTHWEST":RETURN
```

KEY

Token: \$F9

Format: **KEY [ON | OFF | LOAD | SAVE | number, string]**

Usage: Reads the state of the function keys. The function keys can either send their key code when pressed, or a string assigned to the key. After power up or reset this feature is activated and the keys have their default assignments.

KEY OFF switch off function key strings. The keys will send their character code if pressed.

KEY ON switch on function key strings. The keys will send assigned strings if pressed.

KEY LOAD loads key definitions from file.

KEY SAVE saves key definitions to file.

KEY list current assignments.

KEY number, string assigns the string to the key with the given number.

Default assignments:

```
KEY
KEY 1,CHR$(27)+"X"
KEY 2,CHR$(27)+"B"
KEY 3,"DIR"+CHR$(13)
KEY 4,"DIR "+CHR$(34)+"*=PRG"+CHR$(34)+CHR$(13)
KEY 5,"U"
KEY 6,"KEY6"+CHR$(141)
KEY 7,"L"
KEY 8,"MONITOR"+CHR$(13)
KEY 9,"d"
KEY 10,"KEY10"+CHR$(141)
KEY 11,"U"
KEY 12,"KEY12"+CHR$(141)
KEY 13,CHR$(27)+"0"
KEY 14,"I"+CHR$(27)+"0"
KEY 15,"HELP"+CHR$(13)
KEY 16,"RUN "+CHR$(34)+"*"+CHR$(34)+CHR$(13)
```

Remarks: The sum of the lengths of all assigned strings must not exceed 240 characters. Special characters such as RETURN or QUOTE are entered using their codes with the CHR\$(code) function. Refer to **CHR\$** on page B-38 for more information.

Examples: Using **KEY**:

```
KEY ON           :REM ENABLE FUNCTION KEYS
KEY OFF          :REM DISABLE FUNCTION KEYS
KEY              :REM LIST ASSIGNMENTS
KEY 2,"PRINT d"+CHR$(14) :REM ASSIGN PRINT PI TO F2
KEY SAVE "MY KEY SET" :REM SAVE CURRENT DEFINITIONS TO FILE
KEY LOAD "ELEVEM-SET" :REM LOAD DEFINITIONS FROM FILE
```

LEFT\$

Token: \$C8

Format: LEFT\$(string, n)

Usage: Returns a string containing the first **n** characters from the argument **string**. If the length of **string** is equal to or less than **n**, the resulting string will be identical to the argument string.

string a string expression.

n a numeric expression (0-255).

Remarks: Empty strings and zero lengths are legal values.

Example: Using LEFT\$:

```
PRINT LEFT$("MEGA-65", 4)
MEGA
```

LEN

Token: \$C3

Format: **LEN(string)**

Usage: Returns the length of a string.

string a string expression.

Remarks: There is no terminating character, as opposed to other programming languages such as C, which uses the NULL character. The length of the string is internally stored in an extra byte of the string descriptor.

Example: Using **LEN**:

```
PRINT LEN("MEGA-85"+CHR$(13))
8
```

LET

Token: \$88

Format: **LET variable = expression**

Usage: Assigns values (or results of expressions) to variables.

Remarks: The **LET** statement is obsolete and not required. Assignment to variables can be done without using **LET**, but it has been left in BASIC 65 for backwards compatibility.

Examples: Using **LET**:

```
LET A=5 :REM LONGER AND SLOWER  
A=5 :REM SHORTER AND FASTER
```

LINE

Token: \$E5

Format: **LINE** *xbeg,ybeg* [[*,xnext1,ynext1*], [...]]

Usage: Draws a pixel at (*xbeg/ymbeg*), if only one coordinate pair is given.

If more than one pair is defined, a line is drawn on the current graphics screen from the coordinate (*xbeg/ymbeg*) to the next coordinate pair(s).

All currently defined modes and values of the graphics context are used.

Example: Using **LINE**:

```
1 REM SCREEN EXAMPLE 1
10 SCREEN 320,200,2 :REM SCREEN #0 320 X 200 X 2
20 PEN 1 :REM DRAWING PEN COLOR 1 (WHITE)
30 LINE 25,25,295,175 :REM DRAW LINE
40 GETKEY AS :REM WAIT FOR KEYPRESS
50 SCREEN CLOSE :REM CLOSE SCREEN AND RESTORE PALETTE
```

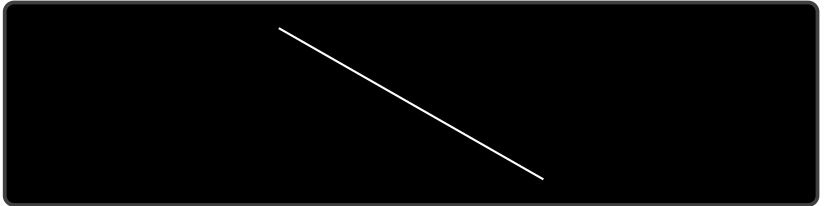

LINE INPUT#

Token: \$E5 \$B4

Format: **LINE INPUT# channel, variable list**

Usage: Reads one record per variable from an input device, (such as a disk drive) and assigns the read data to the variable. The records must be terminated by a **RETURN** character, which will not be copied to the string variable. Therefore, an empty line consisting of only the **RETURN** character will result in an empty string being assigned.

channel number, which was given to a previous call to commands such as **DOPEN**, or **OPEN**.

variable list list of one or more variables, that receive the input.

Remarks: Only string variables or string array elements can be used in the variable list. Unlike other INPUT commands, LINE INPUT# does not interpret or remove quote characters in the input. They are accepted as data, as all other characters.

Records must not be longer than the input buffer, which is 160 characters.

Example: Using **LINE INPUT#**:

```
10 DIM N$(100)
20 DOPEN#2,"DATA"
30 FOR I=0 TO 100
40 LINE INPUT#2,N$(I)
50 IF ST=64 THEN 80:REM END OF FILE
60 IF DS THEN PRINT DS$:GOTO 80:REM DISK ERROR
70 NEXT I
80 DCLOSE#2
110 PRINT "READ";I;" RECORDS"
```

LIST

Token: \$9B

Format: LIST [P] [line range]

Usage: Used to list a range of lines from the BASIC program.

line range consists of the first and/or last line to list, or a single line number. If the first number is omitted, the first BASIC line is assumed. If the second number is omitted, the last BASIC line is assumed.

Format: LIST [P] filename [,U unit]

Used to list a BASIC program directly from **unit**, which by default is 8.

Remarks: The optional parameter **P** enables page mode. After listing 24 lines, the listing will stop and display the prompt **[MORE]** at the bottom of the screen. Pressing **Q** quits page mode, while any other key triggers the listing of the next page.

LIST output can be redirected to other devices via **CMD**.

The keys **F9** and **F11**, or **Ctrl P** and **Ctrl V** scroll a BASIC listing on screen up or down.

Examples: Using **LIST**

```
LIST 100      :REM LIST LINE 100
LIST 240-350  :REM LIST ALL LINES FROM 240 TO 350
LIST 500-     :REM LIST FROM 500 TO END
LIST -70     :REM LIST FROM START TO 70
LIST "DEMO"  :REM LIST FILE "DEMO"
LIST P       :REM LIST PROGRAM IN PAGE MODE
LIST P "MURX":REM LIST FILE "MURX" IN PAGE MODE
```

LOAD

Token: \$93

Format: **LOAD filename [unit [,flag]] / filename [unit [,flag]]**

Usage: A common use of the shortcut symbol / is to quickly load **PRG** files. To do this:

1. Print a disk directory using either **DIR**, or **CATALOG**.
2. Move the cursor to the desired line.
3. type / in the first column of the line, and press .

After pressing , the listed file on the line with the leading / will be loaded. Characters before and after the file name double quotes (") will be ignored. This applies to **PRG** files only.

filename is either a quoted string, e.g. "**prog**", or a string expression.

The unit number is optional. If not present, the default disk device is assumed.

If **flag** has a non-zero value, the file is loaded to the address which is read from the first two bytes of the file. Otherwise, it is loaded to the start of BASIC memory and the load address in the file is ignored.

Remarks: **LOAD** loads files of type **PRG** into RAM bank 0, which is also used for BASIC program source.

LOAD "*" can be used to load the first **PRG** from the given **unit**.

LOAD "\$" can be used to load the list of files from the given **unit**. When using **LOAD "\$"**, **LIST** can be used to print the listing to screen.

LOAD is implemented in BASIC 65 to keep it backwards compatible with BASIC V2.

The shortcut symbol / can only be used in direct mode.

By default the C64 uses **unit** 1, which is assigned to datasette tape recorders connected to the cassette port. However the MEGA65 uses **unit** 8 by default, which is assigned to the internal disk drive. This means you don't need to add ,8 to **LOAD** commands that use it.

Examples: Using **LOAD**

```
LOAD "APOCALYPSE" :REM LOAD A FILE CALLED APOCALYPSE TO BASIC MEMORY  
LOAD "MEGA TOOLS",9 :REM LOAD A FILE CALLED "MEGA TOOLS" FROM UNIT 9 TO BASIC MEMORY  
LOAD "*",8,1 :LOAD THE FIRST FILE ON UNIT 8 TO RAM AS SPECIFIED IN THE FILE
```

LOADIFF

Token: \$FE \$43

Format: **LOADIFF filename [unit]**

Usage: Loads an IFF file into graphics memory. The IFF (Interchange File Format) is supported by many different applications and operating systems. **LOADIFF** assumes that files contain bitplane graphics which fit into the MEGA65 graphics memory. Supported resolutions are:

Width	Height	Bitplanes	Colours	Memory
320	200	max. 8	max. 256	max. 64 K
640	200	max. 8	max. 256	max. 128 K
320	400	max. 8	max. 256	max. 128 K
640	400	max. 4	max. 16	max. 128 K

filename is either a quoted string, e.g. "**picture.iff**" or a string expression.

The unit number is optional. If not present, the default disk device is assumed.

Remarks: Tools are available to convert popular image formats to IFF. These tools are available on several operating systems, such as AMIGA OS, macOS, Linux, and Windows. For example, **ImageMagick** is a free graphics package that includes a tool called **convert**, which can be used to create IFF files in conjunction with the **ppmtoilbm** tool from the **Netbpm** package.

To use **convert** and **ppmtoilbm** for converting a JPG file to an IFF file on Linux:

```
convert <myImage.jpg> <myImage.ppm>
ppmtoilbm -aga <myImage.pbm> > <myImage.iff>
```

Example: Using **LOADIFF**

```
100 BANK128:SCNCLR
110 REM DISPLAY PICTURES IN 320 X 200 X 7 RESOLUTION
120 GRAPHIC CLR:SCREEN DEF 0,0,0,7:SCREEN OPEN 0:SCREEN SET 0,0
130 FORI=1T07: READF$
140 LOADIFF(F$+".IFF"):SLEEP 4:NEXT
150 DATA ALIEN,BEAKER,JOKER,PICARD,PULP,TROOPER,RIPLEY
160 SCREEN CLOSE 0
170 PALETTE RESTORE
```

LOG

Token: \$BC

Format: LOG(numeric expression)

Usage: Computes the value of the natural logarithm of the argument. The natural logarithm uses Euler's number (**2.71828183**) as base, not 10 which is typically used in log functions on a pocket calculator.

Remarks: The log function with base 10 can be computed by dividing the result by $\log(10)$.

Example: Using LOG

```
PRINT LOG(1)
0

PRINT LOG(0)
?ILLEGAL QUANTITY ERROR

PRINT LOG(4)
1.38629436

PRINT LOG(100) / LOG(10)
2
```

LOG10

Token: \$CE \$08

Format: **LOG10**(numeric expression)

Usage: Computes the value of the decimal logarithm of the argument. The decimal logarithm uses 10 as base.

Example: Using **LOG10**

```
PRINT LOG10(1)
0

PRINT LOG10(0)
?ILLEGAL QUANTITY ERROR

PRINT LOG10(5)
0.69897

PRINT LOG10(100);LOG(10);LOG(0.1);LOG(0.01)
2 1 -1 -2
```

LOOP

Token: \$EC

Format: **DO ... LOOP**
DO [**<UNTIL | WHILE>** <logical expression>]
... statements [**EXIT**]
LOOP [**<UNTIL | WHILE>** <logical expression>]

Usage: **DO** and **LOOP** define the start of a BASIC loop. Using **DO** and **LOOP** alone without any modifiers creates an infinite loop, which can only be exited by the **EXIT** statement. The loop can be controlled by adding **UNTIL** or **WHILE** after the **DO** or **LOOP**.

Remarks: **DO** loops may be nested. An **EXIT** statement only exits the current loop.

Examples: Using **DO** and **LOOP**

```
10 PW$="":DO
20 GET A$:PW$=PW$+A$
30 LOOP UNTIL LEN(PW$)>7 OR A$=CHR$(13)

10 DO : REM WAIT FOR USER DECISION
20 GET A$
30 LOOP UNTIL A$="Y" OR A$="N" OR A$="y" OR A$="n"

10 DO WHILE ABS(EPS) > 0.001
20 GOSUB 2000 : REM ITERATION SUBROUTINE
30 LOOP

10 I%=0 : REM INTEGER LOOP 1-100
20 DO I%=I%+1
30 LOOP WHILE I% < 101
```

LPEN

Token: \$CE \$04

Format: LPEN(**coordinate**)

Usage: This function requires the use of a CRT monitor (or TV), and a light pen. It will not work with an LCD or LED screen. The light pen must be connected to port 1.

LPEN(0) returns the X position of the light pen, the range is 60-320.

LPEN(1) returns the Y position of the light pen, the range is 50-250.

Remarks: The X resolution is two pixels, therefore **LPEN(0)** only returns even numbers. A bright background colour is needed to trigger the light pen. The **COLLISION** statement may be used to enable an interrupt handler.

Example: Using LPEN

```
PRINT LPEN(0),LPEN(1) :REM PRINT LIGHT PEN COORDINATES
```

MERGE

Token: \$E6

Format: **MERGE filename** [**D drive**] [**,U unit**]

Usage: **MERGE** loads a BASIC program file from disk and appends it to the program in memory.

filename is either a quoted string, e.g. **"data"** or a string expression in brackets, e.g. **(FI\$)**.

drive drive # in dual drive disk units.

The drive # defaults to **0** and can be omitted on single drive units such as the 1541, 1571, or 1581.

unit device number on the IEC bus. Typically in the range from 8 to 11 for disk units. If a variable is used, it must be placed in brackets. The unit # defaults to **8**.

Remarks: The load address, stored in the first two bytes of the file is ignored. The loaded program does not replace a program in memory (which is what **DLOAD** does), but is appended to a program in memory. After loading the program is re-linked and ready to run or edit.

It is the user's responsibility to ensure that there are no line number conflicts among the program in memory and the merged program. The first line number of the merged program must be greater than the last line number of the program in memory.

Example: Using **MERGE**

```
DLOAD "MAIN PROGRAM"  
MERGE "LIBRARY"
```

MID\$

Token: \$CA

Format: **variable\$ = MID\$(string, index, n)**
MID\$(string, index, n) = string expression

Usage: **MID\$** can be used either as a function which returns a string, or as a statement for inserting sub-strings into an existing string.

string a string expression.

index start index (0-255).

n length of sub-string (0-255).

Remarks: Empty strings and zero lengths are legal values.

Example: Using **MID\$**:

```
10 A$ = "MEGA-65"  
20 PRINT MID$(A$,3,4)  
30 MID$(A$,5,1) = "+"  
40 PRINT A$  
RUN  
GA-6  
MEGA+65
```

MOD

Token: \$NN

Format: **MOD**(dividend,divisor)

Usage: The **MOD** function returns the remainder of the division.

Remarks: In other programming languages such C, this function is implemented as an operator (%). In BASIC 65 it is implemented as a function.

Example: Using **MOD**:

```
FOR I = 0 TO 8: PRINT MOD(I,4);: NEXT I
0 1 2 3 0 1 2 3 0
```

MONITOR

Token: \$FA

Format: **MONITOR**

Usage: Calls the machine language monitor program, which is mainly used for debugging.

Remarks: Using the **MONITOR** requires knowledge of the CSG4510 / 6502 / 6510 CPU, the assembly language they use, and their architectures. More information on the **MONITOR** is available in Chapter/Appendix K on page K-7.

To exit the monitor press **X**.

Help text can be displayed with either **?** or **H**.

Example: Using **MONITOR**

MONITOR

```
BS MONITOR COMMANDS: ABCDEFGHIJKLMNOPQRSTUVWXYZ
PC SR AC AN IA ZN BF SP NVEBDIZC
: 00FAE 00 00 00 00 00 01F8 -----
ASSEMBLE - A ADDRESS MNEMONIC OPERAND
BITNARS - B [FROM]
COMPARE - C FROM TO WITH
DISASSEMBLE - D [FROM] [TO]
FILL - F FROM TO FILLBYTE
GO - G [ADDRESS]
HUNT - H FROM TO (STRING OR BYTES)
JSR - J ADDRESS
LOAD - L FILENAME [UNIT [ADDRESS]]
MEMORY - M [FROM] [TO]
REGISTERS - R
SAVE - S FILENAME UNIT FROM TO
TRANSFER - T FROM TO TARGET
VERIFY - V FILENAME [UNIT [ADDRESS]]
EXIT - X
(.DOT) - . ADDRESS MNEMONIC OPERAND
> (GREATER) - > ADDRESS BYTE SEQUENCE
; (SEMICOLON) - ; REGISTER CONTENTS
@DOS - @ [DOS COMMAND]
?HELP - ?
```

MOUSE

Token: \$FE \$3E

Format: **MOUSE ON** [,port [,sprite [,pos]]]
MOUSE OFF

Usage: Enables the mouse driver and connects the mouse at the specified port with the mouse pointer sprite.

port mouse port 1, 2 (default) or 3 (both).

sprite sprite number for mouse pointer (default 0).

pos initial mouse position (x,y).

MOUSE OFF disables the mouse driver and frees the associated sprite.

Remarks: The "hot spot" of the mouse pointer is the upper left pixel of the sprite.

Examples: Using **MOUSE**:

```
REM LOAD DATA INTO SPRITE #0 BEFORE USING IT
MOUSE ON, 1      :REM ENABLE  MOUSE WITH SPRITE #0
MOUSE OFF       :REM DISABLE MOUSE
```

MOVSPR

Token: \$FE \$06

Format: **MOVSPR number, position**

Usage: Moves a sprite on screen. Each **position** argument consists of two 16-bit values, which specify either an absolute coordinate, a relative coordinate, an angle, or a speed. The value type is determined by a prefix:

- **+value** relative coordinate: positive offset.
- **-value** relative coordinate: negative offset.
- **#value** speed.

If no prefix is given, the absolute coordinate or angle is used.

Therefore, the position argument can be used to either:

- set the sprite to an absolute position on screen.
- specify a displacement relative from the current position.
- trigger a relative movement from a specified position.
- describe movement with an angle and speed starting from the current position.

MOVSPR number, position is used to set the sprite immediately to the position or, in the case of an angle#speed argument, describe its further movement.

Format: **MOVSPR number, start-position TO end-position, speed**

Usage: Places the sprite at the start position, defines the destination position, and the speed of movement. The sprite is placed at the start position, and will move in a straight line to the destination at the given speed. Coordinates must be absolute or relative. The movement is controlled by the BASIC interrupt handler and happens concurrently with the program execution.

number sprite number (0-7).

position *x,y* | *xrel,y* | *x,yrel* | *xrel,yrel* | *angle#speed*.

x absolute screen coordinate pixel.

y absolute screen coordinate pixel.

xrel relative screen coordinate pixel.

yrel relative screen coordinate pixel.

angle compass direction for sprite movement [degrees]. 0 = up, 90 = right, 180 = down, 270 = left, 45 upper right, etc.

speed speed of movement, configured as a floating point number in the range of 0.0-127.0, in pixels per frame. PAL has 50 frames per second whereas NTSC has 60 frames per second. A speed value of 1.0 will move the sprite 50 pixels per second in PAL mode.

Remarks: The "hot spot" is the upper left pixel of the sprite.

Example: Using **MOVSPR**:

```
100 CLR:SCNCLR:SPRITECLR
110 BLOAD "DEMOSPRITES1",80,P1536
130 FORI=0T07: C=I+1:SP=0.07*(I+1)
140 MOVSPRI, 160,120
145 MOVSPRI,45*IHSP
150 SPRITEI,1,C,,0,0
160 NEXT
170 SLEEP 3
180 FORI=0T07:MOVSPR I,0#0:NEXT
```

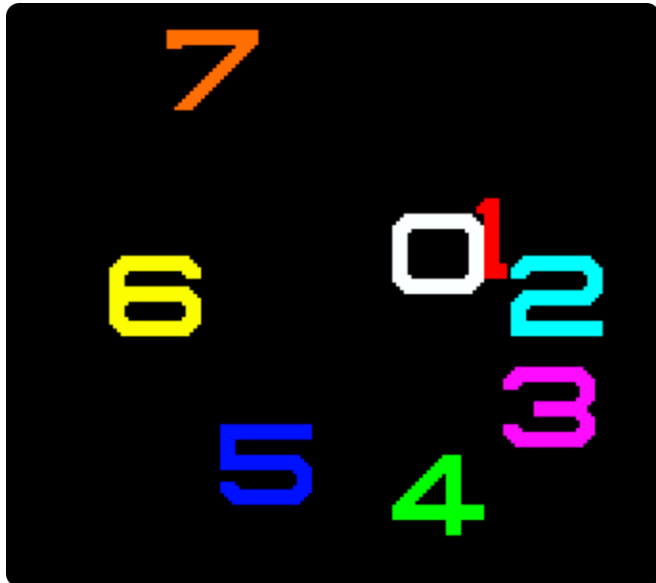

NEW

Token: \$A2

Format: **NEW NEW RESTORE**

Usage: Resets all BASIC parameters to their default values. Since **NEW** resets parameters and pointers, (but does not overwrite the address range of a BASIC program that was in memory), it is possible to recover the program. If there were no **LOAD** operations, or editing performed after **NEW**, the program can be restored with the **NEW RESTORE**.

Examples: Using **NEW**:

```
NEW          :REM RESET BASIC
NEW RESTORE :REM TRY TO RECOVER NEW'ED PROGRAM
```

NEXT

Token: \$82

Format: **FOR index=start TO end [STEP step] ... NEXT [index]**

Usage: Terminates the definition of a BASIC loop with an index variable.

The **index** variable may be incremented or decremented by a constant value **step** on each iteration. The default is to increment the variable by 1. The index variable must be a real variable.

start value to initialise the index with.

end is checked at the end of an iteration, and determines whether another iteration will be performed, or if the loop will exit.

step defines the change applied to the index variable at the end of every iteration. Positive step values increment it, while negative values decrement it. It defaults to 1.0 if not specified.

Remarks: The **index** variable after **NEXT** is optional. If it is omitted, the variable for the current loop is assumed. Several consecutive **NEXT** statements may be combined by specifying the indexes in a comma separated list. The statements **NEXT I:NEXT J:NEXT K** and **NEXT I,J,K** are equivalent.

Example: Using **NEXT**

```
10 FOR D=0 TO 360 STEP 30
20 R = D * π / 180
30 PRINT D;R;SIN(R);COS(R);TAN(R)
40 NEXT D

10 DIM M(20,20)
20 FOR I=0 TO 20
30 FOR J=I TO 20
40 M(I,J) = I + 100 * J
50 NEXT J,I
```

NOT

Token: \$A8

Format: **NOT** operand

Usage: Performs a bit-wise logical NOT operation on a 16-bit value. Integer operands are used as they are, whereas real operands are converted to a signed 16-bit integer (losing precision). Logical operands are converted to a 16-bit integer, using \$FFFF (decimal -1) for TRUE, and \$0000 (decimal 0) for FALSE.

expression	result
NOT 0	1
NOT 1	0

Remarks: The result is of type integer.

Examples: Using **NOT**

```
PRINT NOT 3
-4
PRINT NOT 64
-65
```

In most cases, **NOT** is used in **IF** statements.

```
OK = C < 256 AND C >= 0
IF (NOT OK) THEN PRINT "NOT A BYTE VALUE"
```

OFF

Token: \$FE \$24

Format: keyword **OFF**

Usage: **OFF** is a secondary keyword used in combination with primary keywords, such as **COLOR**, **KEY**, and **MOUSE**.

Remarks: **OFF** cannot be used on its own.

Examples: Using **OFF**

```
COLOR OFF :REM DISABLE SCREEN COLOUR  
KEY OFF  :REM DISABLE FUNCTION KEY STRINGS  
MOUSE OFF :REM DISABLE MOUSE DRIVER
```

ON

Token: \$9 1

Format: **ON expression GOSUB line list**
ON expression GOTO line list
keyword ON

Usage: **ON** calls either a computed **GOSUB** or **GOTO** statement. Depending on the result of the expression, the target for **GOSUB** and **GOTO** is chosen from the table of line addresses at the end of the statement.

When used as a secondary keyword, **ON** is used in combination with primary keywords, such as **COLOR**, **KEY**, and **MOUSE**.

expression is a positive numeric value. Real values are converted to integer (losing precision). Logical operands are converted to a 16-bit integer, using \$FFFF (decimal -1) for TRUE, and \$0000 (decimal 0) for FALSE.

line list is a comma separated list of valid line numbers.

Remarks: Negative values for **expression** will stop the program with an error message. The **line list** specifies the targets for values of 1, 2, 3, etc. An expression result of zero, or a result that is greater than the number of target lines will not do anything, and the program will continue execution with the next statement.

Example: Using **ON**

```
10 COLOR ON :REM ENABLE SCREEN COLOUR
20 KEY ON :REM ENABLE FUNCTION KEY STRINGS
30 MOUSE ON :REM ENABLE MOUSE DRIVER
40 N = JOY(1):IF N AND 128 THEN PRINT "FIRE! ";
60 REM          N NE E SE S SW W NW
70 ON N AND 15 GOSUB 100,200,300,400,500,600,700,800
80 GOTO 40
100 PRINT "GO NORTH" :RETURN
200 PRINT "GO NORTHEAST":RETURN
300 PRINT "GO EAST" :RETURN
400 PRINT "GO SOUTHEAST":RETURN
500 PRINT "GO SOUTH" :RETURN
600 PRINT "GO SOUTHWEST":RETURN
700 PRINT "GO WEST" :RETURN
800 PRINT "GO NORTHWEST":RETURN
```

OPEN

Token: \$9F

Format: **OPEN channel, first address [,secondary address [,filename]]**

Usage: Opens an input/output channel for a device.

channel number, where:

- **1 <= channel <= 127** line terminator is CR.
- **128 <= channel <= 255** line terminator is CR LF.

first address device number. For IEC devices the unit number is the primary address. Following primary address values are possible:

unit	device
0	Keyboard
1	System default
2	RS232 serial connection
3	Screen
4-7	IEC printer and plotter
8-31	IEC disk drives

The **secondary address** has some reserved values for IEC disk units, 0:load, 1:save, 15:command channel. The values 2-14 may be used for disk files.

filename is either a quoted string, e.g. "**data**" or a string expression. The syntax is different to **DOPEN#**, since the **filename** for **OPEN** includes all file attributes, for example "0:data,s,w".

Remarks: For IEC disk units the usage of **DOPEN#** is recommended.

If the first character of the filename is an at sign '@', it is interpreted as a "save and replace" operation. It is not recommended to use this option on 1541 and 1571 drives, as they contain a "save and replace bug" in their DOS.

Example: Using **OPEN**

```
OPEN 4,4 :REM OPEN PRINTER
CMD 4 :REM REDIRECT STANDARD OUTPUT TO 4
LIST :REM PRINT LISTING ON PRINTER DEVICE 4
OPEN 3,8,3,"@:USER FILE,U"
OPEN 2,9,2,"@:DATA,S,W"
```

OR

Token: \$B0

Format: operand **OR** operand

Usage: Performs a bit-wise logical OR operation on two 16-bit values. Integer operands are used as they are. Real operands are converted to a signed 16-bit integer (losing precision). Logical operands are converted to a 16-bit integer using \$FFFF (decimal -1) for TRUE and \$0000 (decimal 0), for FALSE.

expression	result
0 OR 0	0
0 OR 1	1
1 OR 0	1
1 OR 1	1

Remarks: The result is of type integer. If the result is used in a logical context, the value of 0 is regarded as FALSE, and all other non-zero values are regarded as TRUE.

Example: Using **OR**

```
PRINT 1 OR 3
3
PRINT 128 OR 64
192
```

In most cases, **OR** is used in **IF** statements.

```
IF (C < 0 OR C > 255) THEN PRINT "NOT A BYTE VALUE"
```

PAINT

Token: \$DF

Format: **PAINT** *x, y, mode* [*,colour*]

Usage: Performs a flood fill of an enclosed graphics area.

x, y is a coordinate pair, which must lie inside the area to be filled.

mode specifies the fill mode:

- **0** use the **colour** to fill the area.
- **1** use the colour of pixel (*x,y*) to fill the area.

Example: Using **PAINT**

```
10 GRAPHIC CLR      :REM INITIALISE
20 SCREEN DEF 1,0,0,2 :REM 320 X 200
30 SCREEN OPEN 1    :REM OPEN
40 SCREEN SET 1,1    :REM MAKE SCREEN ACTIVE
50 PALETTE 1,1,10,15,10 :REM COLOUR 1 TO LIGHT GREEN
60 PEN 1             :REM SET DRAWING PEN (PEN 0) TO LIGHT GREEN (1)
70 LINE 160,0,240,100 :REM 1ST. LINE
80 LINE 240,100,80,100 :REM 2ND. LINE
90 LINE 80,100,160,0  :REM 3RD. LINE
100 PAINT 160,10,0,1  :REM FILL TRIANGLE WITH COLOUR 1
110 GETKEY K$        :REM WAIT FOR KEY
120 SCREEN CLOSE 1   :REM END GRAPHICS
```

PALETTE

Token: \$FE \$34

Format: PALETTE [screen]COLOR], colour, red, green, blue
PALETTE RESTORE

Usage: PALETTE can be used to change an entry of the system colour palette, or the palette of a screen.
PALETTE RESTORE resets the system palette to the default values.

screen screen number (0-3).

COLOR keyword for changing system palette.

colour index to palette (0-255).

red red intensity (0-15).

green green intensity (0-15).

blue blue intensity (0-15).

Example: Using PALETTE

```
10 GRAPHIC CLR :REM INITIALISE
20 SCREEN DEF 1,0,0,2 :REM 320 X 200
30 SCREEN OPEN 1 :REM OPEN
40 SCREEN SET 1,1 :REM MAKE SCREEN ACTIVE
50 PALETTE 1,0, 0, 0, 0 :REM 0 = BLACK
60 PALETTE 1,1, 15, 0, 0 :REM 1 = RED
70 PALETTE 1,2, 0, 0,15 :REM 2 = BLUE
80 PALETTE 1,3, 0,15, 0 :REM 3 = GREEN
90 PEN 2 :REM SET DRAWING PEN (PEN 0) TO BLUE (2)
100 LINE 160,0,240,100 :REM 1ST. LINE
110 LINE 240,100,80,100 :REM 2ND. LINE
120 LINE 80,100,160,0 :REM 3RD. LINE
130 PAINT 160,10,0,2 :REM FILL TRIANGLE WITH BLUE (2)
140 GETKEY K$ :REM WAIT FOR KEY
150 SCREEN CLOSE 1 :REM END GRAPHICS
```

PEEK

Token: \$C2

Format: PEEK(address)

Usage: Returns an unsigned 8-bit value (byte) from **address**.

If the address is in the range of \$0000 to \$FFFF (0-65535), the memory bank set by **BANK** is used.

Addresses greater than or equal to \$10000 (decimal 65536) are assumed to be flat memory addresses and used as such, ignoring the **BANK** setting.

Remarks: Banks 0-127 give access to RAM or ROM banks. Banks greater than 127 are used to access I/O, and the underlying SYSTEM hardware such as the VIC, SID, FDC, etc.

Example: Using PEEK

```
10 BANK 128           :REM SELECT SYSTEM BANK
20 L = PEEK($02F8)    :REM USR JUMP TARGET LOW
30 H = PEEK($02F9)    :REM USR JUMP TARGET HIGH
40 T = L + 256 * H    :REM 16-BIT JUMP ADDRESS
50 PRINT "USR FUNCTION CALLS ADDRESS";T
```

PEEKW

Token: \$C2 'W'

Format: **PEEKW(address)**

Usage: Returns an unsigned 16-bit value (word) read from **address** (low byte) and **address+1** (high byte).

If the address is in the range of \$0000 to \$FFFF (0-65535), the memory bank set by **BANK** is used.

Addresses greater than or equal to \$10000 (decimal 65536) are assumed to be flat memory addresses and used as such, ignoring the **BANK** setting.

Remarks: Banks 0-127 give access to RAM or ROM banks. Banks greater than 127 are used to access I/O, and the underlying SYSTEM hardware such as the VIC, SID, FDC, etc.

Example: Using **PEEKW**

```
20 UA = PEEKW($02F8) :REM USR JUMP TARGET
50 PRINT "USR FUNCTION CALL ADDRESS";UA
```

PEN

Token: \$FE \$33

Format: PEN [**pen**,] **colour**

Usage: Sets the colour of the graphic pen.

pen pen number (0-2):

- **0** drawing pen (default, if only single parameter provided).
- **1** off bits in jam2 mode.
- **2** currently unused.

colour palette index.

Remarks: The colour selected by **PEN** will be used by all graphic/drawing commands that follow it. If you intend to set the drawing **pen** 0 to a colour, you can omit the first parameter, and only provide the **colour** parameter.

Example: Using **PEN**

```
10 GRAPHIC CLR :REM INITIALISE
20 SCREEN DEF 1,0,0,2 :REM 320 X 200
30 SCREEN OPEN 1 :REM OPEN
40 SCREEN SET 1,1 :REM MAKE SCREEN ACTIVE
50 PALETTE 1,0, 0, 0, 0 :REM 0 = BLACK
60 PALETTE 1,1, 15, 0, 0 :REM 1 = RED
70 PALETTE 1,2, 0, 0,15 :REM 2 = BLUE
80 PALETTE 1,3, 0,15, 0 :REM 3 = GREEN
90 PEN 1 :REM SET DRAWING PEN (PEN 0) TO RED (1)
100 LINE 160,0,240,100 :REM DRAW RED LINE
110 PEN 2 :REM SET DRAWING PEN (PEN 0) TO BLUE (2)
120 LINE 240,100,80,100 :REM DRAW BLUE LINE
130 PEN 3 :REM SET DRAWING PEN (PEN 0) TO BLUE (3)
140 LINE 80,100,160,0 :REM DRAW GREEN LINE
150 GETKEY K$ :REM WAIT FOR KEY
160 SCREEN CLOSE 1 :REM END GRAPHICS
```

PIXEL

Token: \$CE \$0C

Format: **PIXEL(x,y)**

Usage: Returns the colour of a pixel at the given position.

x absolute screen coordinate.

y absolute screen coordinate.

PLAY

Token: \$FE \$04

Format: **PLAY** [**string1** [,**string2** [,**string3** [,**string4** [,**string5** [,**string6**]]]]]]]

Usage: **PLAY** without any arguments will cause all voices to be silenced, and all of BASIC's music-system variables to be reset (E.g. **TEMPO**).

PLAY can be followed by up to six comma-separated string arguments, where each argument provides the sequence of notes and directives to be played on a specific voice on the two available SID chips, allowing for up to 6-channel polyphony.

A musical note is a character (A, B, C, D, E, F, or G), which may be preceded by an optional modifier.

Possible modifiers are:

char	effect
#	sharp
\$	flat
.	dotted
H	half note
I	eighth note
Q	quarter note
R	pause (rest)
S	sixteenth note
W	whole note

Embedded directives consist of a letter, followed by a digit:

char	directive	argument range
0	octave	0 - 6
T	instrument envelope	0 - 9
U	volume	0 - 9
X	filter	0 - 1
M	modulation	0 - 9
P	portamento	0 - 9
L	loop	N/A

The modulation directive will modulate your note by the magnitude you specify (1-9), or use 0 to turn this feature off.

Similarly, the portamento directive will gently slide between consecutive notes at the speed you specify (1-9), or use 0 to turn this feature off.

Note that the gate-off behaviour of notes is disabled while portamento is enabled, and to re-enable it, you must turn off portamento (P0).

Add an **L** directive (no argument needed) at the end of your string if you would like it to loop back to the beginning of your string upon completion.

You have a lot of flexibility on which voice channels you choose to play your melodies on. For instance, you may decide to use only voice 1 and voice 4 for your melody, and spare the other channels for sound effects generated by **SOUND**. Just skip the voices you're not using with **PLAY**, by leaving those arguments empty:

```
PLAY "04EDCDEEERL",,, "02CGEGCGEGL"
```

You can even call **PLAY** again to use the aforementioned unused channels, to play another melody alongside your first melody. For example, using voice2 and voice5 this time:

```
PLAY , "05T2T6AGFEDCEG06.QCL",,, "03T2.Q6.B 04TC03GE.QCL"
```

If you wish to assess whether a melody is playing on a voice channel, you can find out by checking the value returned from **RPLAY(voice)**, where the voice parameter is a value from 1 to 6 indicating the voice channel. It will return either 1 (playing), or 0 (not playing).

One caveat to be aware of is that BASIC strings have a maximum length of 255 bytes. If your melody needs to exceed this length, consider breaking up your melody into several strings, then use **RPLAY(voice)** to assess when your first string has finished and then play the next string.

Instrument envelope slots may be modified by using the **ENVELOPE** statement. The default settings for the envelopes are on page B-82.

Remarks: The **PLAY** statement makes use of an interrupt driven routine that starts parsing the string and playing the melody. Program execution continues with the next statement, and will not block until the melody has finished.

Example: Using **PLAY**

```
5 REM *** SIMPLE LOOPING EXAMPLE ***
10 ENVELOPE 9,10,5,10,5,0,300
20 VOL 8
30 TEMPO 30
40 PLAY "05T9HCIDCDEHCG IGAGFEFDEWCL", "02T0QC6EGC6EG DB6B C6EGL"
```

```
5 REM *** MODULATION + PORTAMENTO EXAMPLE ***
10 TEMPO 20
20 M$ = "M5 T205P0QD P5FP0RP5Q6 .A1HAQA HGQE.C IDQE HFQD .DIHCQD HEQHCQ04HA"
30 M$ = M$ + "05QDHFQ6.A1HAQA HGQE.C IDQEFEDHC04B05HC D04AFD P0R L"
40 B$ = "T0QR02H.D.F.CO1.A.HA.G.A QAI02AGFE H.D.F.CO1.A.HA.A02 .D DL"
50 PLAY M$,B$
```

POINTER

Token: \$CE \$OA

Format: **POINTER(variable)**

Usage: Returns the current address of a variable or an array element as a 32-bit pointer. For string variables, it is the address of the string descriptor, not the string itself. The string descriptor consists of three bytes (length, string address low, string address high).

Remarks: The address values of arrays and their elements are constant while the program is executing. However, the addresses of strings (not their descriptors) may change at any time due to "garbage collection".

Example: Using **POINTER**

```
10 BANK 0           :REM SCALARS ARE IN BANK 0
20 H$="HELLO"       :REM ASSIGN STRING TO H$
30 P=POINTER(H$)    :REM GET DESCRIPTOR ADDRESS
40 PRINT "DESCRIPTOR AT: $";HEX$(P)
50 L=PEEK(P):SP=PEEK(P+1) :REM LENGTH & STRING POINTER
60 PRINT "LENGTH = ";L :REM PRINT LENGTH
70 BANK 1           :REM STRINGS ARE IN BANK 1
80 FOR I%=0 TO L-1:PRINT PEEK(SP+I%);:NEXT:PRINT
90 FOR I%=0 TO L-1:PRINT CHR$(PEEK(SP+I%));:NEXT:PRINT

RUN
DESCRIPTOR AT: $F743
LENGTH = 5
 72 69 76 76 79
HELLO
```

POKE

Token: \$97

Format: **POKE address, byte [,byte ...]**

Usage: Writes one or more bytes into memory or memory mapped I/O, starting at **address**.

If the address is in the range of \$0000 to \$FFFF (0-65535), the memory bank set by **BANK** is used.

Addresses greater than or equal to \$10000 (decimal 65536) are assumed to be flat memory addresses and used as such, ignoring the **BANK** setting.

byte a value in the range of 0-255.

Remarks: The address is incremented for each data byte, so a memory range can be written to with a single **POKE**.

Banks greater than 127 are used to access I/O, and the underlying SYSTEM hardware such as the VIC, SID, FDC, etc.

Example: Using **POKE**

```
10 BANK 128 :REM SELECT SYSTEM BANK
20 POKE $02F8,0,24 :REM SET USR VECTOR TO $1800
```

POKEW

Token: \$97 'W'

Format: **POKEW** address, word [,word ...]

Usage: Writes one or more words into memory or memory mapped I/O, starting at **address**.

If the address is in the range of \$0000 to \$FFFF (0-65535), the memory bank set by **BANK** is used.

Addresses greater than or equal to \$10000 (decimal 65536) are assumed to be flat memory addresses and used as such, ignoring the **BANK** setting.

word a value from 0-65535. The first word is stored at address (low byte) and address+1 (high byte). The second word is stored at address+2 (low byte) and address+3 (high byte), etc.

Remarks: The address is increased by two for each data word, so a memory range can be written to with a single **POKEW**.

Banks greater than 127 are used to access I/O, and the underlying SYSTEM hardware such as the VIC, SID, FDC, etc.

Example: Using **POKEW**

```
10 BANK 128           :REM SELECT SYSTEM BANK
20 POKEW $02F8,$1800 :REM SET USR VECTOR TO $1800
```

POLYGON

Token: \$FE \$2F

Format: **POLYGON** *x, y, xrad, yrad, sides* [,drawsides [,subtend [,angle [,solid]]]]

Usage: Draws a regular **n**-sided polygon. The polygon is drawn using the current drawing context set with **SCREEN**, **PALETTE**, and **PEN**.

x,y centre coordinates.

xrad,yrad radius in x- and y-direction.

sides number of polygon sides.

drawsides sides to draw.

subtend draw line from centre to start (1).

angle start angle.

solid fill (1) or outline (0).

Remarks: A regular polygon is both isogonal and isotoxal, meaning all sides and angles are alike.

Example: Using **POLYGON**

```
100 SCREEN 320,200,1      :REM OPEN 320 x 200 SCREEN
110 POLYGON 160,100,40,40,6 :REM DRAW HONEYCOMB
120 GETKEY A$             :REM WAIT FOR KEY
130 SCREEN CLOSE          :REM CLOSE GRAPHICS SCREEN
```

Results in:

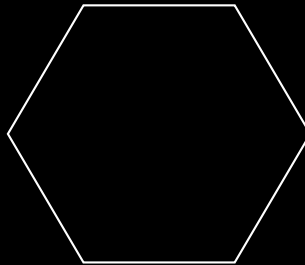

POS

Token: \$B9

Format: POS(dummy)

Usage: Returns the cursor column relative to the currently used window.
dummy a numeric value, which is ignored.

Remarks: **POS** gives the column position for the screen cursor. It will not work for redirected output.

Example: Using **POS**

```
10 IF POS(0) > 72 THEN PRINT :REM INSERT RETURN
```

POT

Token: \$CE \$02

Format: POT(**paddle**)

Usage: Returns the position of a paddle.

paddle paddle number (1-4).

The low byte of the return value is the paddle value, with 0 at the clockwise limit and 255 at the anticlockwise limit.

A value greater than 255 indicates that the fire button is also being pressed.

Remarks: Analogue paddles are noisy and inexact. The range may be less than 0-255 and there could be some jitter in the values returned from **POT**.

Example: Using **POT**

```
10 X = POT(1)      : REM READ PADDLE #1
20 B = X > 255     : REM TRUE (-1) IF FIRE BUTTON IS PRESSED
30 V = X AND 255   : PADDLE #1 VALUE
```

PRINT

Token: \$99

Format: **PRINT arguments**

Usage: Evaluates the argument list, and prints the values formatted to the current screen window. Standard formatting is used, depending on the argument type. For user controlled formatting, see **PRINT USING**.

The following argument types are evaluated:

- **numeric** the printout starts with a space for positive and zero values, or a minus sign for negative values. Integer values are printed with the necessary number of digits. Real values are printed in either fixed point form (typically 9 digits), or scientific form if the value is outside the range of 0.01 to 9999999999.
- **string** the string may consist of printable characters and control codes. Printable characters are printed at the cursor position, while control codes are executed.
- **","** a comma acts as a tabulator.
- **";"** a semicolon acts as a separator between arguments of the list. Other than the comma character, it does not insert any additional characters. A semicolon at the end of the argument list suppresses the automatic return (carriage return) character.

Remarks: The **SPC** and **TAB** functions may be used in the argument list for positioning. **CMD** can be used for redirection.

Example: Using **PRINT**

```
10 FOR I=1 TO 10 : REM START LOOP
20 PRINT I,I*I,SQR(I)
30 NEXT
```

PRINT#

Token: \$98

Format: **PRINT# channel, arguments**

Usage: Evaluates the argument list, and prints the formatted values to the device assigned to **channel**. Standard formatting is used, depending on the argument type. For user controlled formatting, see **PRINT# USING**.

channel number, which was given to a previous call to commands such as **APPEND**, **DOPEN**, or **OPEN**.

The following argument types are evaluated:

- **numeric** the printout starts with a space for positive and zero values, or a minus sign for negative values. Integer values are printed with the necessary number of digits. Real values are printed in either fixed point form (typically 9 digits), or scientific form if the value is outside the range of 0.01 to 9999999999.
- **string** may consist of printable characters and control codes. Printable characters are printed at the cursor position, while control codes are executed.
- **","** a comma acts as a tabulator.
- **";"** a semicolon acts as a separator between arguments of the list. Other than the comma character, it does not insert any additional characters. A semicolon at the end of the argument list suppresses the automatic return (carriage return) character.

Remarks: The **SPC** and **TAB** functions are not suitable for devices other than the screen.

Example: Using **PRINT#** to write a file to drive 8:

```
10 DOPEN#2,"TABLE",M,U8
20 FOR I=1 TO 10 : REM START LOOP
30 PRINT#2,I,I*I,SQR(I)
40 NEXT
50 DCLOSE#2
```

You can confirm that the file **'TABLE'** has been written by typing **DIR "TA*"**, and then view the contents of the file by typing **TYPE "TABLE"**.

PRINT USING

Token: \$98 \$FB or \$99 \$FB

Format: **PRINT** [# channel,] **USING** format;argument

Usage: Parses the **format** string and evaluates the argument. The argument can be either a string or a numeric value. The format of the resulting output is directed by the **format** string.

channel number, which was given to a previous call to commands such as **APPEND**, **DOPEN**, or **OPEN**. If no channel is specified, the output goes to the screen.

format string variable or a string constant which defines the rules for formatting. When using a number as the **argument**, formatting can be done in either CBM style, providing a pattern such as ###.## or in C style using a <width.precision> specifier, such as %3D %7.2F %4X .

argument the number to be formatted. If the argument does not fit into the format e.g. trying to print a 4 digit variable into ### a series of asterisks will replace the format character.

argument may consist of printable characters and control codes. Printable characters are printed to the cursor position, while control codes are executed. The number of # characters sets the width of the output. If the first character of the format string is an equals '=' sign, the argument string is centered. If the first character of the format string is a greater than '>' sign, the argument string is right justified.

Remarks: The format string is applied for one argument only, but it is possible to append more **USING format;argument** sequences.

Examples: Using **PRINT# USING**

```
PRINT USING "###.###";a, USING " [%6.4F] ";SQR(2)
3.14 [1.4142]
```

```
PRINT USING "< # # # > ";12*31
< 3 7 2 >
```

```
PRINT USING "####"; "ABCDE"
ABC
```

```
PRINT USING ">####"; "ABCDE"
CDE
```

```
PRINT USING "ADDRESS:%4X";65000
ADDRESS:$FDE8
```

```
A$="###,###,###.#":PRINT USING A$;1E8/3
33,333,333.3
```

RCOLOR

Token: \$CD

Format: **RCOLOR**(colour source)

Usage: Returns the current colour index for the selected colour source.

Colour sources are:

- **0** background colour (VIC \$D021).
- **1** text colour (\$F1).
- **2** highlight colour (\$2D8).
- **3** border colour (VIC \$D020).

Example: Using **RCOLOR**

```
10 C = RCOLOR(3) : REM C = colour index of border colour
```

RCURSOR

Token: \$FE \$42

Format: **RCURSOR** [*colvar*],[*rowvar*]

Usage: Returns the current cursor column and row.

Remarks: The row and column values start at zero, where the left-most column is zero, and the top row is zero.

Example: Using **RCURSOR**

```
100 CURSOR ON,20,10
110 PRINT "[HERE]";
120 RCURSOR X,Y
130 PRINT " COL:";X;" ROW:";Y
```

```
RUN
```

```
[HERE] COL: 26 ROW: 10
```

READ

Token: \$87

Format: **READ variable list**

Usage: Reads values from program source into variables.

variable list Any legal variables.

All types of constants (integer, real, and strings) can be read, but not expressions. Items are separated by commas. Strings containing commas, colons or spaces must be put in quotes.

RUN initialises the data pointer to the first item of the first **DATA** statement and advances it for every read item. It is the programmer's responsibility that the type of the constant and the variable in the **READ** statement match. Empty items with no constant between commas are allowed and will be interpreted as zero for numeric variables and an empty string for string variables.

RESTORE may be used to set the data pointer to a specific line for subsequent readings.

Remarks: It is good programming practice to put large amounts of **DATA** statements at the end of the program, so they don't slow down the search for line numbers after **GOTO**, and other statements with line number targets.

Example: Using **READ**

```
10 READ NA$, VE
20 READ NX:FOR I=2 TO NX:READ GL(I):NEXT I
30 PRINT "PROGRAM: ";NA$;" VERSION: ";VE
40 PRINT "N-POINT GAUSS-LEGENDRE FACTORS E1":
50 FOR I=2 TO NX:PRINT I;GL(I):NEXT I
30 STOP
80 DATA "MEG65",1.1
90 DATA 5,0.5120,0.3573,0.2760,0.2252
```

RECORD

Token: \$FE \$12

Format: **RECORD# channel, record, [,byte]**

Usage: Positions the read/write pointer of a relative file.

channel number, which was given to a previous call of commands such as **DOPEN**, or **OPEN**.

record target record (1-65535).

byte byte position in record.

RECORD can only be used for files of type **REL**, which are relative files capable of direct access.

RECORD positions the file pointer to the specified record number. If this record number does not exist and there is enough space on the disk which **RECORD** is writing to, the file is expanded to the requested record count by adding empty records. When this occurs, the disk status will give the message **RECORD NOT PRESENT**, but this is not an error!

after a call of **INPUT#** or **PRINT#**, the file pointer will proceed to the next record position.

Remarks: The Commodore disk drives have a bug in their DOS, which can destroy data by using relative files. A recommended workaround is to use the command **RECORD** twice, before and after the I/O operation.

Example: Using **RECORD**

```
100 DOPEN#2,"DATA BASE",L240 :REM OPEN OR CREATE
110 FOR I%=1 TO 20 :REM WRITE LOOP
120 PRINT#2,"RECORD #";I% :REM WRITE RECORD
130 NEXT I% :REM END LOOP
140 DCLOSE#2 :REM CLOSE FILE
150 :REM NOW TESTING
160 DOPEN#2,"DATA BASE",L240 :REM REOPEN
170 FOR I%=20 TO 2 STEP -2 :REM READ FILE BACKWARDS
180 RECORD#2,I% :REM POSITION TO RECORD
190 INPUT#2,A$ :REM READ RECORD
200 PRINT A$;-IF I% AND 2 THEN PRINT
210 NEXT I% :REM LOOP
220 DCLOSE#2 :REM CLOSE FILE
```

RUN

```
RECORD # 20 RECORD # 18
RECORD # 16 RECORD # 14
RECORD # 12 RECORD # 10
RECORD # 8 RECORD # 6
RECORD # 4 RECORD # 2
```

REM

Token: \$8F

Format: **REM**

Usage: Marks any characters after **REM** on the same line as a comment. Characters after **REM** are never executed, they're ignored by BASIC.

Example: Using **REM**

```
10 REM *** PROGRAM TITLE ***  
20 N=1000 :REM NUMBER OF ITEMS  
30 DIM NA$(N)
```

RENAME

Token: \$F5

Format: **RENAME** old **TO** new [,D drive] [,U unit]

Usage: Renames a disk file.

old is either a quoted string, e.g. **"data"** or a string expression in brackets, e.g. **(FI\$)**.

new is either a quoted string, e.g. **"backup"** or a string expression in brackets, e.g. **(FSS)**

drive drive # in dual drive disk units.

The drive # defaults to **0** and can be omitted on single drive units such as the 1541, 1571, or 1581.

unit device number on the IEC bus. Typically in the range from 8 to 11 for disk units. If a variable is used, it must be placed in brackets. The unit # defaults to **8**.

Remarks: **RENAME** is executed in the DOS of the disk drive. It can rename all regular file types (**PRG**, **SEQ**, **USR**, **REL**). The old file must exist, and the new file must not exist. Only single files can be renamed, wildcard characters such as **'*** and **'?'** are not allowed. The file type cannot be changed.

Example: Using **RENAME**

```
RENAME "CODES" TO "BACKUP" :REM RENAME SINGLE FILE
```

RENUMBER

Token: \$F8

Format: **RENUMBER** [**new** [,**inc** [**range**]]]

Usage: Used to renumber all, or a range of lines of a BASIC program.

new new starting line of the line range to renumber. The default value is 10.

inc increment to be used. The default value is 10.

range line range to renumber. The default values are from first to last line.

RENUMBER changes all line numbers in the chosen range and also changes all references in statements that use **GOSUB**, **GOTO**, **RESTORE**, **RUN**, **TRAP**, etc.

RENUMBER can only be executed in direct mode. If it detects a problem such as memory overflow, unresolved references or line number overflow (more than than 64000 lines), it will stop with an error message and leave the program unchanged.

RENUMBER may be called with 0-3 parameters. Unspecified parameters use their default values.

Remarks: **RENUMBER** may need several minutes to execute for large programs.

Examples: Using **RENUMBER**

```
RENUMBER           :REM NUMBERS WILL BE 10,20,30,...
RENUMBER 100,5     :REM NUMBERS WILL BE 100,105,110,115,...
RENUMBER 601,1,500 :REM RENUMBER STARTING AT 500 TO 601,602,...
RENUMBER 100,5,120-180 :REM RENUMBER LINES 120-180 TO 100,105,...
```

RESTORE

Token: \$8C

Format: **RESTORE** [**line**]

Usage: Set, or reset the internal pointer for **READ** from **DATA** statements.

line new position for the pointer. The default is the first program line.

Remarks: The new pointer target **line** does not need to contain **DATA** statements. Every **READ** will advance the pointer to the next **DATA** statement automatically.

Example: Using **RESTORE**

```
10 DATA 3,1,4,1,5,9,2,6
20 DATA "MEGAB5"
30 DATA 2,7,1,8,2,8,9,5
40 FOR I=1 TO 8:READ P:PRINT P:NEXT
50 RESTORE 30
60 FOR I=1 TO 8:READ P:PRINT P:NEXT
70 RESTORE 20
80 READ A$:PRINT A$
```

RESUME

Token: \$D6

Format: **RESUME** [**line** | **NEXT**]

Usage: Used in a **TRAP** routine to resume normal program execution after handling an exception.

RESUME with no parameters attempts to re-execute the statement that caused the error. The **TRAP** routine should have examined and corrected the issue that cause the exception in this case.

line line number to resume program execution at.

NEXT resumes execution following the statement that caused the error. This could be the next statement on the same line (separated with a colon ':'), or the statement on the next line.

Remarks: **RESUME** cannot be used in direct mode.

Example: Using **RESUME**

```
10 TRAP 100
20 FOR I=1 TO 100
30 PRINT EXP(I)
40 NEXT
50 PRINT "STOPPED FOR I =" ; I
60 END
100 PRINT ERR$(ER): RESUME 50
```

RETURN

Token: \$8E

Format: RETURN

Usage: Returns control from a subroutine, which was called with **GOSUB** or an event handler declared with **COLLISION**.

The execution continues at the statement following the **GOSUB** call.

In the case of the **COLLISION** handler, the execution continues at the statement where it left to call the handler.

Example: Using **RETURN**

```
10 SCNCLR      :REM CLEAR SCREEN
20 FOR I=1 TO 20 :REM DEFINE LOOP
30 GOSUB 100   :REM CALL SUBROUTINE
40 NEXT I      :REM LOOP
50 END         :REM END OF PROGRAM
100 CURSOR ON,I,I,0 :REM ACTIVATE AND POSITION CURSOR
110 PRINT "X";  :REM PRINT X
120 SLEEP 0.5  :REM WAIT 0.5 SECONDS
130 CURSOR OFF :REM SWITCH BLINKING CURSOR OFF
140 RETURN     :REM RETURN TO CALLER
```

RGRAPHIC

Token: \$CC

Format: **RGRAPHIC(screen,parameter)**

Usage: Return graphic screen status and parameters

param	description
0	open (1), closed (0), or invalid (>1)
1	width (0=320, 1=640)
2	height (0=200, 1=400)
3	depth (1-8 bitplanes)
4	bitplanes used (bitmask)
5	bank 4 blocks used (bitmask)
6	bank 5 blocks used (bitmask)
7	drawscreen # (0-3)
8	viewscreen # (0-3)
9	drawmodes (bitmask)
10	pattern type (bitmask)

Example: Using **RGRAPHIC**

```
10 GRAPHIC CLR       :REM INITIALISE
20 SCREEN DEF 0,1,0,4 :REM SCREEN 0:640 X 200 X 4
30 SCREEN OPEN 0     :REM OPEN
40 SCREEN SET 0,0    :REM DRAW = VIEW = 0
50 SCNCLR 0         :REM CLEAR
60 PEN 0,1          :REM SELECT COLOUR
70 LINE 0,0,639,199 :REM DRAW LINE
80 FOR I=0 TO 10:A(I)=RGRAPHIC(0,I):NEXT
90 SCREEN CLOSE 0
100 FOR I=0 TO 6:PRINT I;A(I):NEXT:REM PRINT INFO
```

```
RUN
0 1
1 1
2 0
3 4
4 15
5 15
6 15
```

RIGHT\$

Token: \$C9

Format: RIGHT\$(string, n)

Usage: Returns a string containing the last **n** characters from **string**. If the length of **string** is equal or less than **n**, the result string will be identical to the argument string.

string a string expression.

n a numeric expression (0-255).

Remarks: Empty strings and zero lengths are legal values.

Example: Using RIGHT\$:

```
PRINT RIGHT$("MEGA-65",2)
65
```

RMOUSE

Token: \$FE \$3F

Format: **RMOUSE** *xvar*, *yvar*, *butvar*

Usage: Reads mouse position and button status.

xvar numeric variable where the x-position will be stored.

yvar numeric variable where the y-position will be stored.

butvar numeric variable receiving button status.
left button sets bit 7, while right button sets bit 0.

value	status
0	no button
1	right button
128	left button
129	both buttons

RMOUSE places -1 into all variables if the mouse is not connected or disabled.

Remarks: Active mice on both ports merge the results.

Example: Using **RMOUSE**:

```
10 MOUSE ON, 1, 1      :REM MOUSE ON PORT 1 WITH SPRITE 1
20 RMOUSE XP, YP, BU   :REM READ MOUSE STATUS
30 IF XP < 0 THEN PRINT "NO MOUSE ON PORT 1":STOP
40 PRINT "MOUSE: ";XP;YP;BU
50 MOUSE OFF          :REM DISABLE MOUSE
```

RND

Token: \$BB

Format: RND(**type**)

Usage: Returns a pseudo random number.

This is called a "pseudo" random number, as the numbers are not *really* random. They are derived from another number called a "seed" that generates reproducible sequences. **type** determines which seed is used:

- **type = 0** use system clock.
- **type < 0** use the value of **type** as seed.
- **type > 0** derive a new random number from previous one.

Remarks: Seeded random number sequences produce the same sequence for identical seeds.

Example: Using **RND**:

```
10 DEF FNDI(X) = INT(RND(0)*6)+1 :REM DICE FUNCTION
20 FOR I=1 TO 10 :REM THROW 10 TIMES
30 PRINT I;FNDI(0) :REM PRINT DICE POINTS
40 NEXT
```

RPALETTE

Token: \$CE \$0D

Format: RPALETTE(screen, index, rgb)

Usage: Returns the red, green or blue value of a palette colour index.

screen screen number (0-3).

index palette colour index.

rgb (red=0, green=1, blue=2).

Example: Using RPALETTE

```
10 SCREEN 320,200,4 :REM DEFINE AND OPEN SCREEN
20 R = RPALETTE(0,3,0) :REM GET RED
30 G = RPALETTE(0,3,1) :REM GET GREEN
40 B = RPALETTE(0,3,2) :REM GET BLUE
50 SCREEN CLOSE :REM CLOSE SCREEN
60 PRINT "PALETTE INDEX 3 RGB =" ;R;G;B
```

RUN

PALETTE INDEX 3 RGB = 0 15 15

RPEN

Token: \$D0

Format: RPEN(n)

Usage: Returns the colour index of pen n.

n pen number (0-2), where:

- 0 draw pen.
- 1 erase pen.
- 2 outline pen.

Example: Using **RPEN**

```
10 GRAPHIC CLR :REM INITIALISE
20 SCREEN DEF 0,1,0,4 :REM SCREEN 0:640 X 200 X 4
30 SCREEN OPEN 0 :REM OPEN
40 SCREEN SET 0,0 :REM DRAW = VIEW = 0
50 SCNCLR 0 :REM CLEAR
60 PEN 0,1 :REM SELECT COLOUR
70 X = RPEN(0)
80 Y = RPEN(1)
90 C = RPEN(2)
100 SCREEN CLOSE 0
110 PRINT "DRAW PEN COLOUR = ";X
RUN
DRAW PEN COLOUR = 1
```

RPLAY

Token: \$FE \$OF

Format: RPLAY(voice)

Usage: Returns a value of 1 or 0, to indicate whether a melody is playing on the given voice channel or not.

voice the voice channel to assess, ranging from 1 to 6.

Example: Using RPLAY:

```
10 PLAY "04ICDEF6AB05CR","02QCGEGC01GCR"  
30 IF RPLAY(1) OR RPLAY(2) THEN GOTO 30: REM WAIT FOR END OF SONG
```

RREG

Token: \$FE \$09

Format: **RREG** **areg**, **xreg**, **yreg**, **zreg**, **sreg**

Usage: Reads the values that were in the CPU registers after a **SYS** call, into the specified variables.

areg gets accumulator value.

xreg gets X register value.

yreg gets Y register value.

zreg gets Z register value.

sreg gets status register value.

Remarks: The register values after a **SYS** call are stored in system memory. This is how **RREG** is able to retrieve them.

Example: Using **RREG**:

```
10 BANK 128
20 BLOAD "ML PROG",8192
30 SYS 8192
40 RREG A,X,V,Z,S
50 PRINT "REGISTER:";A;X;V;Z;S
```

RSPCOLOR

Token: \$CE \$07

Format: RSPCOLOR(n)

Usage: Returns multi-colour sprite colours.

n sprite multi-colour number:

- **1** get multi-colour # 1.
- **2** get multi-colour # 2.

Remarks: Refer to **SPRITE**, and **SPRCOLOR** for more information.

Example: Using **RSPCOLOR**:

```
10 SPRITE 1,1      :REM TURN SPRITE 1 ON
20 C1% = RSPCOLOR(1) :REM READ COLOUR #1
30 C2% = RSPCOLOR(2) :REM READ COLOUR #2
```

RSPEED

Token: \$CE \$OE

Format: **RSPEED(n)**

Usage: Returns the current CPU clock in MHz.

n numeric dummy argument, which is ignored.

Remarks: **RSPEED(n)** will not return the correct value if **POKE 0,65** has previously been used to enable the highest speed (40MHz).

Refer to the **SPEED** command for more information.

Example: Using **RSPEED**:

```
10 X=RSPEED(0) :REM GET CLOCK
20 IF X=1 THEN PRINT "1 MHZ" :GOTO 50
30 IF X=3 THEN PRINT "3,5 MHZ" :GOTO 50
40 IF X=40 THEN PRINT "40 MHZ"
50 END
```

RSPPOS

Token: \$CE \$05

Format: RSPPOS(sprite,n)

Usage: Returns a sprite's position and speed

sprite sprite number.

n sprite parameter to retrieve:

- **0** X position.
- **1** Y position.
- **2** speed.

Remarks: Refer to the **MOVSPR** and **SPRITE** commands for more information.

Example: Using **RSPPOS**:

```
10 SPRITE 1,1 :REM TURN SPRITE 1 ON
20 XP = RSPPOS(1,0) :REM GET X OF SPRITE 1
30 YP = RSPPOS(1,1) :REM GET Y OF SPRITE 1
30 SP = RSPPOS(1,2) :REM GET SPEED OF SPRITE 1
```

RSPRITE

Token: \$CE \$06

Format: RSPRITE(sprite,n)

Usage: Returns a sprite's parameter.

sprite sprite number (0-7).

n the sprite parameter to return (0-5):

- **0** turned on (0 or 1) A 0 means the sprite is off.
- **1** foreground colour (0-15).
- **2** background priority (0 or 1).
- **3** x-expanded (0 or 1). 0 means it's not expanded.
- **4** y-expanded (0 or 1). 0 means it's not expanded.
- **5** multi-colour (0 or 1). 0 means it's not multi-colour.

Remarks: Refer to the **MOVSPR** and **SPRITE** commands for more information.

Example: Using **RSPRITE**:

```
10 SPRITE 1,1 :REM TURN SPRITE 1 ON
20 EN = RSPRITE(1,0) :REM SPRITE 1 ENABLED ?
30 FG = RSPRITE(1,1) :REM SPRITE 1 FOREGROUND COLOUR INDEX
40 BP = RSPRITE(1,2) :REM SPRITE 1 BACKGROUND PRIORITY
50 XE = RSPRITE(1,3) :REM SPRITE 1 X EXPANDED ?
60 YE = RSPRITE(1,4) :REM SPRITE 1 Y EXPANDED ?
70 MC = RSPRITE(1,5) :REM SPRITE 1 MULTI-COLOUR ?
```

RUN

Token: \$8A

Format: **RUN** [**line number**]
RUN filename [**D drive**] [**,U unit**]

Usage: Run a BASIC program.

If a filename is given, the program file is loaded into memory and run, otherwise the program that is currently in memory will be used instead.

line number an existing line number of the program in memory to run from.

filename either a quoted string, e.g. **"prog"** or a string expression in brackets, e.g. **(PR\$)**. The filetype must be **PRG**.

drive drive # in dual drive disk units.

The drive # defaults to **0** and can be omitted on single drive units such as the 1541, 1571, or 1581.

unit device number on the IEC bus. Typically in the range from 8 to 11 for disk units. If a variable is used, it must be placed in brackets. The unit # defaults to **8**.

RUN first resets all internal pointers to their default values. Therefore, there will be no variables, arrays or strings defined. The run-time stack is also reset, and the table of open files is cleared.

Remarks: To start or continue program execution without resetting everything, use **GOTO** instead.

Examples: Using **RUN**

```
RUN "FLIGHTSIM" :REM LOAD AND RUN PROGRAM FLIGHTSIM
RUN 1000      :REM RUN PROGRAM IN MEMORY, START AT LINE# 1000
RUN          :REM RUN PROGRAM IN MEMORY
```

RWINDOW

Token: \$CE \$09

Format: **RWINDOW**(n)

Usage: Returns information regarding the current text window.

n the screen parameter to retrieve:

- **0** width of current text window.
- **1** height of current text window.
- **2** number of columns on screen (40 or 80).

Remarks: Older versions of **RWINDOW** reported the width - 1 and the height - 1 for arguments 0 and 1.

Refer to the **WINDOW** command for more information.

Example: Using **RWINDOW**:

```
10 W = RWINDOW(2)      :REM GET SCREEN WIDTH
20 IF W=80 THEN BEGIN  :REM IS 80 COLUMNS MODE ACTIVE?
30   PRINT CHR$(27)+"X"; :REM YES, SWITCH TO 40COLUMNS
40 BEND
```

SAVE

Token: \$94

Format: **SAVE filename [,unit]** ← **filename [,unit]**

Usage: Saves a BASIC program to a file of type **PRG**.

filename is either a quoted string, e.g. **"data"** or a string expression in brackets, e.g. **(FI\$)**.

The maximum length of the filename is 16 characters, not counting the optional save and replace character 'e' and the in-file drive definition. If the first character of the filename is an at sign '@', it is interpreted as a "save and replace" operation. It is not recommended to use this option on 1541 and 1571 drives, as they contain a "save and replace bug" in their DOS. The filename may be preceded by the drive number definition "0:" or "1:", which is only relevant for dual drive disk units.

unit device number on the IEC bus. Typically in the range from 8 to 11 for disk units. If a variable is used, it must be placed in brackets. The unit # defaults to **8**.

Remarks: **SAVE** is obsolete, implemented only for backwards compatibility. **DSAVE** should be used instead. The shortcut symbol ← (next to **1**). Can only be used in direct mode.

Examples: Using **SAVE**

```
SAVE "ADVENTURE"  
SAVE "ZORK-I",8  
SAVE "1:DUNGEON",9
```

SCNCLR

Token: \$E8

Format: **SCNCLR** [colour]

Usage: Clears a text window or screen.

SCNCLR (with no arguments) clears the current text window. The default window occupies the whole screen.

SCNCLR colour clears the graphic screen by filling it with the given **colour**.

Example: Using **SCNCLR**:

```
1 REM SCREEN EXAMPLE 2
10 GRAPHIC CLR :REM INITIALIZE
20 SCREEN DEF 1,0,0,2 :REM SCREEN #1 320 X 200 X 2
30 SCREEN OPEN 1 :REM OPEN SCREEN 1
40 SCREEN SET 1,1 :REM USE SCREEN 1 FOR RENDERING AND VIEWING
50 SCREEN CLR 0 :REM CLEAR SCREEN
60 PALETTE 1,1,15,15,15 :REM DEFINE COLOUR 1 AS WHITE
70 PEN 0,1 :REM DRAWING PEN
80 LINE 25,25,295,175 :REM DRAW LINE
90 SLEEP 10 :REM WAIT FOR 10 SECONDS
100 SCREEN CLOSE 1 :REM CLOSE SCREEN AND RESTORE PALETTE
```

SCRATCH

Token: \$F2

Format: **SCRATCH filename** [,D drive] [,U unit] [,R]

Usage: Used to erase a disk file.

filename is either a quoted string, e.g. "**data**" or a string expression in brackets, e.g. (**FI**\$).

drive drive # in dual drive disk units.

The drive # defaults to **0** and can be omitted on single drive units such as the 1541, 1571, or 1581.

unit device number on the IEC bus. Typically in the range from 8 to 11 for disk units. If a variable is used, it must be placed in brackets. The unit # defaults to **8**.

R Recover a previously erased file. This will only work, if there were no write operations between erasure and recovery, which may have altered the contents of the file.

Remarks: **SCRATCH filename** works similarly to **ERASE filename**.

The success and the number of erased files can be examined by printing or using the system variable **DSS**. The second last number, which normally reports the track number in case of a disk error, instead reports the number of successfully erased files.

Examples: Using **SCRATCH**

```
SCRATCH "DRM",U9 :REM SCRATCH FILE DRM ON UNIT 9
PRINT DS$
01, FILES SCRATCHED,01,00
```

```
SCRATCH "OLD*" :REM SCRATCH ALL FILES BEGINNING WITH "OLD"
PRINT DS$
01, FILES SCRATCHED,04,00
```

SCREEN

Token: \$FE \$2E

Format: **SCREEN** [**screen**,] **width**, **height**, **depth**
SCREEN CLR **colour**
SCREEN DEF **width flag**, **height flag**, **depth**
SCREEN SET **drawscreen**, **viewscreen**
SCREEN OPEN [**screen**]
SCREEN CLOSE [**screen**]

Usage: There are two approaches available when preparing the screen for the drawing of graphics: a simplified approach, and a detailed approach.

Simplified approach:

The first version of **SCREEN** (which has pixel units for width and height) is the easiest way to start a graphics screen, and is the preferred method if only a single screen is needed (i.e., a second screen isn't needed for double buffering). This does all of the preparatory work for you, and will call commands such as **GRAPHIC CLR**, **SCREEN CLR**, **SCREEN DEF**, **SCREEN OPEN** and, **SCREEN SET** on your behalf. It takes the following parameters:

SCREEN [**screen**,] **width**, **height**, **depth**

- **screen** the screen number (0-3) is optional. If no screen number is given, screen 0 is used. To keep this approach as simple as possible, it is suggested to use the default screen 0.
- **width** 320 or 640 (default 320)
- **height** 200 or 400 (default = 200)
- **depth** 1..8 (default = 8), colours = 2 ^depth.

The argument parser is error tolerant and uses default values for width (320) and height (200) if the parsed argument is not valid.

This version of **SCREEN** starts with a predefined palette and sets the background to black, and the pen to white, so drawing can start immediately using the default values.

On the other hand, the detailed approach will require the setting of palette colours and pen colour before any drawing can be done.

The **colour** value must be in the range of 0 to 15. Refer to the colour table under **BACKGROUND** on page B-18 for the **colour** values and their corresponding colours.

When you are finished with your graphics screen, simply call **SCREEN CLOSE [screen]** to return to the text screen.

Detailed approach:

The other versions of **SCREEN** perform special actions, used for advanced graphics programs, that open multiple screens or require double buffering. If you have chosen the simplified approach, you will not require any of these versions below, apart from **SCREEN CLOSE**.

SCREEN CLR colour (or SCNCLR colour)

Clears the active graphics screen by filling it with **colour**.

SCREEN DEF screen, width flag, height flag, depth

Defines resolution parameters for the chosen screen. The width flag and height flag indicate whether high resolution (1) or low resolution (0) is chosen.

- **screen** screen number 0-3
- **width flag** 0-1 (0:320, 1:640 pixel)
- **height flag** 0-1 (0:200, 1:400 pixel)
- **depth** 1-8 (2 - 256 colours)

Note that the width and height values here are **flags**, and **not pixel units**.

SCREEN SET drawscreen, viewscreen

Sets screen numbers (0-3) for the drawing and the viewing screen, i.e., while one screen is being viewed, you can draw on a separate screen and then later flip between them. This is what's known as "double buffering".

SCREEN OPEN screen

Allocates resources and initialises the graphics context for the selected **screen** (0-3). An optional variable name as a further argument, gets the result of the command that can be tested afterwards for success.

SCREEN CLOSE [screen]

Closes **screen** (0-3) and frees resources. If no value is given, it will default to 0. Also note that upon closing screen 0, **PALETTE RESTORE** is automatically performed for you.

Examples: Using **SCREEN**:

```
5 REM *** SIMPLIFIED APPROACH ***
10 SCREEN 320,200,2 :REM SCREEN #0: 320 X 200 X 2
20 PEN 1 :REM DRAWING PEN COLOUR = 1 (WHITE)
30 LINE 25,25,295,175 :REM DRAW LINE
40 GETKEY A$ :REM WAIT KEYPRESS
50 SCREEN CLOSE :REM CLOSE SCREEN 0
```

```
5 REM *** DETAILED APPROACH ***
10 GRAPHIC CLR :REM INITIALISE
20 SCREEN DEF 1,0,0,2 :REM SCREEN #1: 320 X 200 X 2
30 SCREEN OPEN 1 :REM OPEN SCREEN 1
40 SCREEN SET 1,1 :REM USE SCREEN 1 FOR RENDERING AND VIEWING
50 SCREEN CLR 0 :REM CLEAR SCREEN
60 PALETTE 1,1,15,15,15 :REM DEFINE COLOUR 1 AS WHITE
70 PEN 0,1 :REM DRAWING PEN
80 LINE 25,25,295,175 :REM DRAW LINE
90 SLEEP 10 :REM WAIT 10 SECONDS
100 SCREEN CLOSE 1 :REM CLOSE SCREEN 1
110 PALETTE RESTORE :REM BACK TO TEXT PALETTE
```

SET

Token: \$FE \$2D

Format: **SET DEF unit**
SET DISK old to new
SET VERIFY ON|OFF

Usage: **SET DEF unit** redefines the default unit for disk access, which is initialised to 8 by the DOS. Commands that do not explicitly specify a unit, will use this default unit.

SET DISK old to new is used to change the unit number of a disk drive temporarily.

SET VERIFY ON|OFF enables or disables the DOS verify-after-write mode for 3.5 drives.

Remarks: These settings are valid until a reset or shutdown.

Examples: Using **SET**:

```
DIR          :REM SHOW DIRECTORY OF UNIT 8
SET DEF 11   :REM UNIT 11 BECOMES DEFAULT
DIR          :REM SHOW DIRECTORY OF UNIT 11
DLOAD "*"    :REM LOAD FIRST FILE FROM UNIT 11
SET DISK 8 TO 9 :REM CHANGE UNIT# OF DISK DRIVE 8 TO 9
DIR U9       :REM SHOW DIRECTORY OF UNIT 9 (FORMER 8)
SET VERIFY ON :REM ACTIVATE VERIFY-AFTER-WRITE MODE
```

SGN

Token: \$B4

Format: **SGN**(numeric expression)

Usage: Extracts the sign from the argument and returns it as a number:

- **-1** negative argument.
- **-0** zero.
- **1** positive, non-zero argument.

Example: Using **SGN**

```
10 ON SGN(X)+2 GOTO 100,200,300 :REM TARGETS FOR MINUS,ZERO,PLUS
20 Z = SGN(X) * ABS(Y) : REM COMBINE SIGN OF X WITH VALUE OF Y
```

SIN

Token: \$BF

Format: **SIN(numeric expression)**

Usage: Returns the sine of the **numeric expression**. The argument is expected in units of radians. The result is in the range (-1.0 to +1.0)

Remarks: An argument in units of degrees can be converted to radians by multiplying it with $\pi/180$.

Examples: Using **SIN**

```
PRINT SIN(0.7)
.644217687

X=30:PRINT SIN(X *  $\pi$  / 180)
.5
```

SLEEP

Token: \$FE \$0B

Format: SLEEP seconds

Usage: Pauses execution for the given duration. The argument is a positive floating point number. The precision is 1 microsecond.

Remarks: Pressing  interrupts the sleep.

Example: Using SLEEP

```
20 SLEEP 10 :REM WAIT 10 SECONDS
40 SLEEP 0.0005 :REM SLEEP 500 MICRO SECONDS
50 SLEEP 0.01 :REM SLEEP 10 MILLI SECONDS
60 SLEEP DD :REM TAKE SLEEP TIME FROM VARIABLE DD
70 SLEEP 600 :REM SLEEP 10 MINUTES
```

SOUND

Token: \$DA

Format: **SOUND** voice, freq, dur [,dir ,min, sweep, wave, pulse]

Usage: Plays a sound effect.

voice voice number (1-6).

freq frequency (0-65535).

dur duration (0-32767) .

dir direction (0:up, 1:down, 2:oscillate).

min minimum frequency (0-65535).

sweep sweep range (0-65535).

wave waveform (0:triangle, 1:sawtooth, 2:square, 3:noise).

pulse pulse width (0-5095).

Remarks: **SOUND** starts playing the sound effect and immediately continues with the execution of the next BASIC statement, while the sound effect is played. This enables the showing of graphics or text and playing sounds simultaneously.

Examples: Using **SOUND**

```
SOUND 1, 7382, 60 :REM PLAY SQUARE WAVE ON VOICE 1 FOR 1 SECOND
SOUND 2, 800, 3600 :REM PLAY SQUARE WAVE ON VOICE 2 FOR 1 MINUTE
SOUND 3, 4000, 120, 2, 2000, 400, 1
REM PLAY SWEEPING SAWTOOTH WAVE AT VOICE 3
```

SPC

Token: \$A6

Format: **SPC**(columns)

Usage: Skips **columns**.

The effect is similar to pressing  **<column>** times.

Remarks: The name of this function is derived from **SPACES**, which is misleading. The function prints **cursor right characters**, not spaces. The contents of those character cells that are skipped, will not be changed.

Example: Using **SPC**

```
10 FOR I=8 TO 12
20 PRINT SPC(-(I<10));I :REM TRUE = -1, FALSE = 0
30 NEXT I
RUN
 8
 9
10
11
12
```

SPEED

Token: \$FE \$26

Format: **SPEED** [speed]

Usage: Set CPU clock to 1MHz, 3.5MHz or 40MHz.

speed CPU clock speed where:

- **1** sets CPU to 1MHz.
- **3** sets CPU to 3MHz.
- Anything other than **1** or **3** sets the CPU to 40MHz.

Remarks: Although it's possible to call **SPEED** with any real number, the precision part (the decimal point and any digits after it), will be ignored.

SPEED is a synonym of **FAST**.

SPEED has no effect if **POKE 0,65** has previously been used to set the CPU to 40MHz.

Example: Using **SPEED**

```
10 SPEED      :REM SET SPEED TO MAXIMUM (40 MHZ)
20 SPEED 1    :REM SET SPEED TO 1 MHZ
30 SPEED 3    :REM SET SPEED TO 3.5 MHZ
40 SPEED 3.5  :REM SET SPEED TO 3.5 MHZ
```

SPRCOLOR

Token: \$FE \$08

Format: **SPRCOLOR** [**mc1**] [,**mc2**]

Usage: Sets multi-colour sprite colours.

SPRITE, which sets the attributes of a sprite, only sets the foreground colour. For the setting the additional two colours of multi-colour sprites, use **SPRCOLOR** instead.

Remarks: The colours used with **SPRCOLOR** will affect all sprites. Refer to the **SPRITE** command for more information.

Example: Using **SPRCOLOR**:

```
10 SPRITE 1,1,2,,,1 :REM TURN SPRITE 1 ON (FG = 2)
20 SPRCOLOR 4,5      :REM MC1 = 4, MC2 = 5
```

SPRITE

Token: \$FE \$07

Format: **SPRITE CLR**
SPRITE LOAD filename [,D drive] [,U unit]
SPRITE SAVE filename [,D drive] [,U unit]
SPRITE num [switch, colour, prio, expx, expy, mode]

Usage: **SPRITE CLR** clears all sprite data and sets all pointers and attributes to their default values.

SPRITE LOAD loads sprite data from **filename** to sprite memory.

SPRITE SAVE saves sprite data from sprite memory to **filename**.

filename is either a quoted string, e.g. **"data"** or a string expression in brackets, e.g. **(FIS)**.

The last form switches a sprite on or off and sets its attributes:

num sprite number

switch 1:on, 0:off

colour sprite foreground colour

prio sprite (1) or screen (0) priority

expx 1:sprite X expansion

expy 1:sprite Y expansion

mode 1:multi-colour sprite

Remarks: **SPRCOLOR** must be used to set additional colours for multi-colour sprites (mode = 1).

Example: Using **SPRITE**:

```
2290 CLR:SCNCLR:SPRITE CLR
2300 SPRITE LOAD "DEMOSPRITES1"
2320 FORI=0TO7: C=I: IFC=6THENC=8
2330 MOVSPR I, 60+30*I,0 TO 60+30*I,65+20*I, 3:SPRITE I,1,C,,1,1:NEXT: SLEEP3
2340 FORI=0TO7: SPRITE I,,,0,0 :NEXT: SLEEP3: SPRITE CLR
2350 FORI=0TO7: MOVSPR I,45*1#5 :NEXT: FORI=0TO7: SPRITE I,1: NEXT
2360 FORI=0TO7:X=60+30*I:Y=65+20*I:DO
2370 LOOPUNTIL(X=RSPP0S(I,,)AND(Y=RSPP0S(I,1)):MOVSPRI,.#:NEXT
```

SPRS AV

Token: \$FE \$16

Format: **SPRS AV** *source, destination*

Usage: Copies sprite data.

source sprite number or string variable.

destination sprite number or string variable.

Remarks: Source and destination can either be a sprite number or a string variable, but both cannot be a string variable at the same time. A simple string assignment can be used for such cases.

SPRS AV can be used with the basic form of sprites (C64 compatible) only. These sprites have a size of 64 bytes, and the amount of memory they consume is 67 bytes.

The extended sprites and the variable height sprites cannot be used with **SPRS AV**.

Example: Using **SPRS AV**:

```
10 BLOAD "SPRITEDATA",P1600 :REM LOAD DATA FOR SPRITE 1
20 SPRITE 1,1 :REM TURN SPRITE 1 ON
30 SPRSAV 1,2 :REM COPY SPRITE 1 DATA TO 2
40 SPRITE 2,1 :REM TURN SPRITE 2 ON
50 SPRSAV 1,A$ :REM SAVE SPRITE 1 DATA IN STRING
```

SQR

Token: \$BA

Format: **SQR(numeric expression)**

Usage: Returns the square root of the numeric expression.

Remarks: The argument must not be negative.

Example: Using **SQR**

```
PRINT SQR(2)  
1.41421356
```

ST

Format: **ST** is a reserved system variable.

Usage: **ST** holds the status of the last I/O operation. If **ST** is zero, there was no error, otherwise it is set to a device dependent error code.

Example: Using **ST**

```
100 MX=100:DIM T$(MX)      :REM DATA ARRAY
110 DOPEN#1,"DATA"         :REM OPEN FILE
120 IF DS THEN PRINT"COULD NOT OPEN":STOP
130 LINE INPUT#1,T$(N):N=N+1 :REM READ ONE RECORD
140 IF N>MX THEN PRINT "TOO MANY DATA":GOTO 160
150 IF ST=0 THEN 130        :REM ST = 64 FOR END-OF-FILE
160 DCLOSE#1
170 PRINT "READ";N;" RECORDS"
```

STEP

Token: \$A9

Format: **FOR** **index=**start **TO** end [**STEP** step] ... **NEXT** [index]

Usage: **STEP** is an optional part of a **FOR** loop.

The **index** variable may be incremented or decremented by a constant value after each iteration. The default is to increment the variable by 1. The index variable must be a real variable.

start initial value of the index.

end is checked at the end of an iteration, and determines whether another iteration will be performed, or if the loop will exit.

step defines the change applied to to the **index** at the end of a loop iteration. Positive step values increment it, while negative values decrement it. It defaults to 1.0 if not specified.

Remarks: For positive increments, **end** must be greater than or equal to **start**. For negative increments, **end** must be less than or equal to **start**.

It is bad programming practice to change the value of the **index** variable inside the loop or to jump into or out of a loop body with **GOTO**.

Example: Using **STEP**

```
10 FOR D=0 TO 360 STEP 30
20 R = D * π / 180
30 PRINT D;R;SIN(R);COS(R);TAN(R)
40 NEXT D
```

STOP

Token: \$90

Format: **STOP**

Usage: Stops the execution of the BASIC program. A message will be displayed showing the line number where the program stopped. The **READY** prompt appears and the computer goes into direct mode, waiting for keyboard input.

Remarks: All variable definitions are still valid after **STOP**. They may be inspected or altered, and the program may be continued with **CONT**. However, any editing of the program source will disallow any further continuation.

Program execution can be resumed with **CONT**.

Example: Using **STOP**

```
10 IF V < 0 THEN STOP : REM NEGATIVE NUMBERS STOP THE PROGRAM
20 PRINT SQR(V)      : REM PRINT SQUARE ROOT
```

STR\$

Token: \$C4

Format: STR\$(numeric expression)

Usage: Returns a string containing the formatted value of the argument, as if it were **PRINT**ed to the string.

Example: Using **STR\$**:

```
A$ = "THE VALUE OF PI IS " + STR$(PI)
PRINT A$
THE VALUE OF PI IS 3.14159265
```

SYS

Token: \$9E

Format: **SYS** address [, areg, xreg, yreg, zreg, sreg]

Usage: Calls a machine language subroutine. This can be a ROM-resident kernal routine, a BASIC subroutine, or any other routine which has previously been loaded or **POKE**d to RAM.

The CPU registers are loaded with the arguments (if they're specified), then a subroutine call (**JSR** address) is performed. **JSR** is an assembly language instruction that is short for **J**ump to **S**ub**R**outine. The called routine should exit with an **RTS** instruction. **RTS** is another assembly language instruction that is short for **R**eturn from **S**ub**R**outine. After the subroutine has returned, the register contents will be saved, and the execution of the BASIC program will continue.

address start address of the subroutine.

areg CPU accumulator value.

xreg CPU X register value.

yreg CPU Y register value.

zreg CPU Z register value.

sreg Status register value.

Remarks: The register values after a **SYS** call are stored in system memory. **RREG** can be used to retrieve these values.

SYS uses the current bank, which has been set with **BANK**.

The **SYS** instruction on the MEGA65 is completely different to the well known **SYS** command on the C64. It is not possible to jump to an address after the BASIC program text in bank 0 (and execute a machine language subroutine there), as bank 0 is 64K of RAM with no I/O or kernal mapped in.

Using **SYS** properly (i.e. without corrupting BASIC RAM, and having access to kernal routines and I/O) requires some technical skill, which is out of scope of the User's Guide. However, if you would like to learn more, there is a lot more information and examples in the MEGA65 Developer Guide.

Example: Using **SYS**:

```
10 BANK 128  
20 BLOAD "ML PROG",8192  
30 SYS 8192  
40 RREG A,X,Y,Z,S  
50 PRINT "REGISTER:";A;X;Y;Z;S
```

TAB

Token: \$A3

Format: TAB(column)

Usage: Positions the cursor at **column**.

This is only done if the target column is *right* of the current cursor column, otherwise the cursor will not move. The column count starts with 0 being the left-most column.

Remarks: This function shouldn't be confused with AB, which advances the cursor to the next tab-stop.

Example: Using TAB

```
10 FOR I=1 TO 5
20 READ A$
30 PRINT "*" A$ TAB(10) "*"
40 NEXT I
50 END
60 DATA ONE,TWO,THREE,FOUR,FIVE
```

```
RUN
* ONE      *
* TWO      *
* THREE    *
* FOUR     *
* FIVE     *
```

TAN

Token: \$C0

Format: TAN(numeric expression)

Usage: Returns the tangent of the argument. The argument is expected in units of **[radians]**. The result is in the range (-1.0 to +1.0)

Remarks: An argument in units of degrees can be converted to radians by multiplying it with $\pi/180$.

Example: Using TAN

```
PRINT TAN(0.7)
.84228838

X=45:PRINT TAN(X *  $\pi$  / 180)
.999999999
```

TEMPO

Token: \$FE \$05

Format: TEMPO speed

Usage: Sets the playback speed for **PLAY**.

speed 1-255.

The duration (in seconds) of a whole note is computed with $duration = 24/speed$.

Example: Using **TEMPO**

```
10 VOL 8
20 FOR T = 24 TO 18 STEP -2
30 TEMPO T
40 PLAY "T0M3040G6GFED","T204M5P0H.DP5GB","T503IGAGAGAABABAB"
50 IF RPLAY(1) THEN GOTO 50
60 NEXT T
70 PLAY "T005QC046EH.C","T205IEFEDEDCEG06P8CP0R","T503ICDCDEFEDC04C"
```

THEN

Token: \$A7

Format: **IF expression THEN <true clause> ELSE <>false clause>**

Usage: **THEN** is part of an **IF** statement.

expression is a logical or numeric expression. A numeric expression is evaluated as **FALSE** if the value is zero and **TRUE** for any non-zero value.

true clause one or more statements starting directly after **THEN** on the same line. A line number after **THEN** performs a **GOTO** to that line instead.

false clause one or more statements starting directly after **ELSE** on the same line. A line number after **ELSE** performs a **GOTO** to that line instead.

Remarks: The standard **IF ... THEN ... ELSE** structure is restricted to a single line. But the **true clause** or **false clause** may be expanded to several lines using a compound statement surrounded with **BEGIN** and **BEND**.

Example: Using **THEN**

```
1 REM THEN
10 RED$=CHR$(28) : BLACK$=CHR$(144) : WHITE$=CHR$(5)
20 INPUT "ENTER A NUMBER";V
30 IF V<0 THEN PRINT RED$; : ELSE PRINT BLACK$;
40 PRINT V : REM PRINT NEGATIVE NUMBERS IN RED
50 PRINT WHITE$
60 INPUT "END PROGRAM: (Y/N)"; A$
70 IF A$="Y" THEN END
80 IF A$="N" THEN 20 : ELSE 60
```

TI

Format: TI

Usage: TI is a high precision timer with a resolution of 1 micro second.

It is started or reset with **CLR TI**, and can be accessed in the same way as any other variable in expressions.

Remarks: TI is a reserved system variable. The value in TI is the number of seconds (to 6 decimal places) since it was last cleared or started.

Example: Using TI

```
100 CLR TI           :REM START TIMER
110 FOR I%=1 TO 10000:NEXT :REM DO SOMETHING
120 ET = TI         :REM STORE ELAPSED TIME IN ET
130 PRINT "EXECUTION TIME:";ET;" SECONDS"
```

TI\$

Format: TI\$

Usage: TI\$ stores the time information of the RTC (Real-Time Clock) in text form, using the format: "hh:mm:ss". It is updated with every use.

TI\$ is a read-only variable, which reads the registers of the RTC and formats the values to a string.

Remarks: TI\$ is a reserved system variable.

It is possible to access the RTC registers directly via **PEEK**. The start address of the registers is at \$FFD7110. For example:

For more information on how to set the Real-Time Clock, refer to the Configuring Utility section on page 4-11.

```
100 REM ***** READ RTC ***** ALL VALUES ARE BCD ENCODED
110 RT = $FFD7110           :REM ADDRESS OF RTC
120 FOR I=0 TO 5           :REM SS,MM,HH,DD,MO,YY
130 T(I)=PEEK(RT+I)       :REM READ REGISTERS
140 NEXT I                 :REM USE ONLY LAST TWO DIGITS
150 T(2) = T(2) AND 127    :REM REMOVE 24H MODE FLAG
160 T(5) = T(5) + $2000    :REM ADD YEAR 2000
170 FOR I=2 TO 0 STEP -1  :REM TIME INFO
180 PRINT USING ">## ";HEX$(T(I));
190 NEXT I
RUN
12 52 36
```

Example: Using TI\$

```
PRINT DT$;TI$
05-APR-2021 15:10:00
```

TO

Token: \$A4

Format: keyword **TO**

Usage: **TO** is a secondary keyword used in combination with primary keywords, such as **BACKUP**, **BSAVE**, **CHANGE**, **CONCAT**, **COPY**, **FOR**, **GO**, **RENAME**, and **SET DISK**

Remarks: **TO** cannot be used on its own.

Example: Using **TO**

```
10 GO TO 1000 :REM AS GOTO 1000
20 GOTO 1000 :REM SHORTER AND FASTER
30 FOR I=1 TO 10 :REM TO IS PART OF THE LOOP
40 PRINT I:NEXT :REM LOOP END
50 COPY "CODES" TO "BACKUP" :REM COPY SINGLE FILE
```

TRAP

Token: \$D7

Format: TRAP [line number]

Usage: TRAP with a valid line number registers the BASIC error handler. When a program has an error handler, the run-time behaviour changes. Normally, BASIC will exit the program and display an error message.

However, if a BASIC error handler has been registered, BASIC will instead save the execution pointer and line number, place the error number into the system variable **ER**, and **GOTO** the line number of **TRAP**. The trapping routine can examine **ER** and process the error. From this, the **TRAP** error handler can then decide whether to **STOP** or **RESUME** execution.

TRAP with no argument disables the error handler. Errors will be handled by the normal system routines.

Example: Using **TRAP**

```
10 TRAP 100
20 FOR I=1 TO 100
30 PRINT EXP(I)
40 NEXT
50 PRINT "STOPPED FOR I =" ; I
60 END
100 PRINT ERR$(ER) : RESUME 50
```

TROFF

Token: \$D9

Format: TROFF

Usage: Turns off trace mode (switched on by **TRON**).

Example: Using **TROFF**

```
10 TRON          :REM ACTIVATE TRACE MODE
20 FOR I=85 TO 100
30 PRINT I;EXP(I)
40 NEXT
50 TROFF         :REM DEACTIVATE TRACE MODE
```

```
RUN
[10][20][30] 85  8.22301268E+36
[40][30] 86  2.2352466E+37
[40][30] 87  6.0760302E+37
[40][30] 88  1.65163625E+38
[40][30] 89
?OVERFLOW ERROR IN 30
READY.
```

TRON

Token: \$D8

Format: TRON

Usage: Turns on trace mode.

Example: Using TRON

```
10 TRON           :REM ACTIVATE TRACE MODE
20 FOR I=85 TO 100
30 PRINT I;EXP(I)
40 NEXT
50 TROFF          :REM DEACTIVATE TRACE MODE

RUN

[10][20][30] 85  8.22301268E+36
[40][30] 86  2.2352466E+37
[40][30] 87  6.0760302E+37
[40][30] 88  1.65163625E+38
[40][30] 89
?OVERFLOW ERROR IN 30
READY.
```

TYPE

Token: \$FE \$27

Format: **TYPE filename [,D drive] [,U unit]**

Usage: Prints the contents of a file containing text encoded as PETSCII.

filename is either a quoted string, e.g. **"data"** or a string expression in brackets, e.g. **(FI\$)**.

drive drive # in dual drive disk units.

The drive # defaults to **0** and can be omitted on single drive units such as the 1541, 1571, or 1581.

unit device number on the IEC bus. Typically in the range from 8 to 11 for disk units. If a variable is used, it must be placed in brackets. The unit # defaults to **8**.

Remarks: **TYPE** cannot be used to type BASIC programs. Use **LIST** for programs instead. **TYPE** can only process **SEQ** or **USR** files containing records of PETSCII text, delimited by the CR vcharacter.

The CR character is also known as carriage return, and can be created by using **CHR\$(13)**.

Example: Using **TYPE**

```
TYPE "README"  
TYPE "README 1ST",U9
```

UNTIL

Token: \$FC

Format: **DO** ... **LOOP**
DO [<**UNTIL** | **WHILE**> <logical expr.>
... statements [**EXIT**]
LOOP [<**UNTIL** | **WHILE**> <logical expr.>

Usage: **DO** and **LOOP** define the start of a BASIC loop. Using **DO** and **LOOP** alone without any modifiers creates an infinite loop, which can only be exited by the **EXIT** statement. The loop can be controlled by adding **UNTIL** or **WHILE** after the **DO** or **LOOP**.

Remarks: **DO** loops may be nested. An **EXIT** statement exits the current loop only.

Examples: Using **DO** and **LOOP**.

```
10 PW$="":DO
20 GET A$:PW$=PW$+A$
30 LOOP UNTIL LEN(PW$)>7 OR A$=CHR$(13)

10 DO : REM WAIT FOR USER DECISION
20 GET A$
30 LOOP UNTIL A$="Y" OR A$="N" OR A$="y" OR A$="n"

10 DO WHILE ABS(EPS) > 0.001
20 GOSUB 2000 : REM ITERATION SUBROUTINE
30 LOOP

10 I%=0 : REM INTEGER LOOP 1-100
20 DO I%=I%+1
30 LOOP WHILE I% < 101
```

USING

Token: \$FB

Format: **PRINT [# channel,] USING format;argument**

Usage: Parses the **format** string and evaluates the argument. The argument can be either a string or a numeric value. The format of the resulting output is directed by the **format** string.

channel number, which was given to a previous call to commands such as **APPEND**, **DOPEN**, or **OPEN**. If no channel is specified, the output goes to the screen.

format string variable or a string constant which defines the rules for formatting. When using a number as the **argument**, formatting can be done in either CBM style, providing a pattern such as ###.## or in C style using a <width.precision> specifier, such as %3D %7.2F %4X .

argument the number to be formatted. If the argument does not fit into the format e.g. trying to print a 4 digit variable into ### a series of asterisks will replace the format character.

argument may consist of printable characters and control codes. Printable characters are printed to the cursor position, while control codes are executed. The number of # characters sets the width of the output. If the first character of the format string is an equals '=' sign, the argument string is centered. If the first character of the format string is a greater than '>' sign, the argument string is right justified.

Remarks: The format string is only applied for one argument, but it is possible to append more than one **USING format;argument** sequences.

Example: USING with a corresponding PRINT#

```
PRINT USING "###.###";a, USING " [%6.4F] ";SQR(2)
3.14 [1.4142]
```

```
PRINT USING "< # # # > ";12*31
< 3 7 2 >
```

```
PRINT USING "####"; "ABCDE"
ABC
```

```
PRINT USING ">####"; "ABCDE"
CDE
```

```
PRINT USING "ADDRESS:%4X";65000
ADDRESS:$FDE8
```

```
A$="###,###,###.#":PRINT USING A$;1E8/3
33,333,333.3
```

USR

Token: \$B7

Format: USR(numeric expression)

Usage: Invokes an assembly language routine whose memory address is stored at \$02F8 - \$02F9. The result of the **numeric expression** is written to floating point accumulator 1.

After executing the assembly routine, BASIC returns the contents of the floating point accumulator 1.

Remarks: Banks 0-127 give access to RAM or ROM banks. Banks greater than 127 are used to access I/O, and the underlying SYSTEM hardware such as the VIC, SID, FDC, etc.

If you would like to learn more, there is a lot more information and examples in the MEGA65 Developer Guide.

Example: Using USR

```
10 UX = DEC("7F00")           :REM ADDRESS OF USER ROUTINE
20 BANK 128                   :REM SELECT SYSTEM BANK
30 BLOAD "ML-PROG",P(UX)      :REM LOAD USER ROUTINE
40 POKE (DEC("2F8")),UX AND 255 :REM USR JUMP TARGET LOW
50 POKE (DEC("2F9")),UX / 256  :REM USR JUMP TARGET HIGH
60 PRINT USR(1)               :REM PRINT RESULT FOR ARGUMENT P1
```

VAL

Token: \$C5

Format: VAL(string expression)

Usage: Converts a string to a floating point value.

This function acts in the same way as reading from a string.

Remarks: A string containing an invalid number will not produce an error, but return 0 as the result instead.

Example: Using VAL

```
PRINT VAL("78E2")
```

```
7800
```

```
PRINT VAL("7+5")
```

```
7
```

```
PRINT VAL("1.256")
```

```
1.256
```

```
PRINT VAL("$FFFF")
```

```
0
```

VERIFY

Token: \$95

Format: **VERIFY filename [,unit [,binflag]]**

Usage: **VERIFY** with no **binflag** compares a BASIC program in memory with a disk file of type **PRG**. It does the same as **DVERIFY**, but the syntax is different.

VERIFY with **binflag** compares a binary file in memory with a disk file of type **PRG**. It does the same as **BVERIFY**, but the syntax is different.

filename is either a quoted string, e.g. "**prog**" or a string expression.

unit device number on the IEC bus. Typically in the range from 8 to 11 for disk units. If a variable is used, it must be placed in brackets. The unit # defaults to **8**.

Remarks: **VERIFY** can only test for equality. It gives no information about the number or position of different valued bytes. **VERIFY** exits with either the message **OK** or with **VERIFY ERROR**.

VERIFY is obsolete in BASIC 65. It is only here for backwards compatibility. It is recommended to use **DVERIFY** and **BVERIFY** instead.

Examples: Using **VERIFY**

```
VERIFY "ADVENTURE"  
VERIFY "ZORK-1",9  
VERIFY "1:DUNGEON",10
```

VIEWPORT

Token: \$FE \$3 1

Format: **VIEWPORT** <CLR|DEF> X, Y, DX, DY

Usage: **VIEWPORT DEF** defines a clipping region with the origin (upper left position) set to **X,Y** and the width **DX** and the height **DY**. All following graphics commands are limited to the **VIEWPORT** region.

Remarks: **VIEWPORT** must be followed by either **CLR** or **DEF**, and four integer parameters.

VIEWPORT CLR resets the clipping region to the entire screen.

Example: Using **VIEWPORT**

```
VIEWPORT DEF 20,20,100,100 :REM REGION 20->119, 20->119
VIEWPORT CLR :REM FULL SCREEN
```

VOL

Token: \$DB

Format: VOL volume

Usage: Sets the volume for sound output with **SOUND** or **PLAY**.
volume 0 (off) to 15 (loudest).

Remarks: This volume setting affects all voices.

Example: Using VOL

```
10 TEMPO 22
20 FOR V = 2 TO 8 STEP 2
30 VOL V
40 PLAY "T0M3040G6GFED","T204M5P0H.DP5GB","T503IGAGAGAABABAB"
50 IF RPLAY(1) THEN GOTO 50
60 NEXT V
70 PLAY "T005QC046EH.C","T205IEFEDECEG06P9CP0R","T503ICDCDEFEDC04C"
```

WAIT

Token: \$92

Format: **WAIT** address, andmask [, xormask]

Usage: Pauses the BASIC program until a requested bit pattern is read from the given address.

address the address at the current memory bank, which is read.

andmask **AND** mask applied.

xormask **XOR** mask applied.

WAIT reads the byte value from **address** and applies the masks:
result = PEEK(address) AND andmask XOR xormask.

The pause ends if the result is non-zero, otherwise reading is repeated. This may hang the computer indefinitely if the condition is never met.

Remarks: **WAIT** is typically used to examine hardware registers or system variables and wait for an event, e.g. joystick event, mouse event, keyboard press or a specific raster line is about to be drawn to the screen.

Example: Using **WAIT**

```
10 BANK 128
20 WAIT 211,1 :REM WAIT FOR SHIFT KEY BEING PRESSED
```

WHILE

Token: \$ED

Format: **DO ... LOOP**
DO [<**UNTIL** | **WHILE**> <logical expr.>
... statements [**EXIT**]
LOOP [<**UNTIL** | **WHILE**> <logical expr.>

Usage: **DO** and **LOOP** define the start of a BASIC loop. Using **DO** and **LOOP** alone without any modifiers creates an infinite loop, which can only be exited by the **EXIT** statement. The loop can be controlled by adding **UNTIL** or **WHILE** after the **DO** or **LOOP**.

Remarks: **DO** loops may be nested. An **EXIT** statement exits the current loop only.

Examples: Using **DO** and **LOOP**

```
10 PW$="":DO
20 GET A$:PW$=PW$+A$
30 LOOP UNTIL LEN(PW$)>7 OR A$=CHR$(13)

10 DO : REM WAIT FOR USER DECISION
20 GET A$
30 LOOP UNTIL A$="Y" OR A$="N" OR A$="y" OR A$="n"

10 DO WHILE ABS(EPS) > 0.001
20 GOSUB 2000 : REM ITERATION SUBROUTINE
30 LOOP

10 I%=0 : REM INTEGER LOOP 1-100
20 DO I%=I%+1
30 LOOP WHILE I% < 101
```

WINDOW

Token: \$FE \$1A

Format: WINDOW left, top, right, bottom [,clear]

Usage: Sets the text screen window.

left left column

top top row

right right column

bottom bottom row

clear clear text window flag

Remarks: The row values count from 0 to 24. The column values count from 0 to either 39 or 79. This depends on the screen mode.

There can be only one window on the screen. Pressing  twice or **PRINTing CHR\$(19)CHR\$(19)** will reset the window to the default (full screen).

Example: Using WINDOW

```
10 WINDOW 0,1,79,24 :REM SCREEN WITHOUT TOP ROW
20 WINDOW 0,0,79,24,1 :REM FULL SCREEN WINDOW CLEARED
30 WINDOW 0,12,79,24 :REM LOWER HALF OF SCREEN
40 WINDOW 20,5,59,15 :REM SMALL CENTRED WINDOW
```

XOR

Token: \$E9

Format: operand **XOR** operand

Usage: The Boolean **XOR** operator performs a bit-wise logical exclusive OR operation on two 16-bit values. Integer operands are used as they are. Real operands are converted to a signed 16-bit integer (losing precision). Logical operands are converted to 16-bit integer using \$FFFF, decimal -1 for TRUE and \$0000, decimal 0, for FALSE.

```
0 XOR 0 -> 0
0 XOR 1 -> 1
1 XOR 0 -> 1
1 XOR 1 -> 0
```

Remarks: The result is of type integer. If the result is used in a logical context, the value of 0 is regarded as FALSE, and all other non-zero values are regarded as TRUE.

Example: Using **XOR**

```
FOR I = 0 TO 8: PRINT I XOR 5;: NEXT I
5 4 7 6 1 0 3 2 13
```

APPENDIX



Special Keyboard Controls and Sequences













- **PETSCII Codes and CHR\$**
- **Control codes**
- **Shifted codes**
- **Escape Sequences**

PETSCII CODES AND CHR\$

In BASIC, `PRINT CHR$(X)` can be used to print a character from a PETSCII code. Below is the full table of PETSCII codes you can print by index. For example, while in the default uppercase/graphics mode, by using index 65 from the table below as: `PRINT CHR$(65)` you will print the letter **A**. You can read more about **CHR\$** on page B-38.



You can also do the reverse with the `ASC` statement. For example: `PRINT ASC("A")` will output 65, which matches with the code in the table.

NOTE: Function key (F1-F14 + HELP) values in this table are not intended to be printed via `CHR$()`, but rather to allow function-key input to be assessed in BASIC programs via the `GET` / `GETKEY` commands.

0	18 	37 %	57 9
1	19 	38 &	58 :
2 UNDERLINE ON	20 	39 '	59 ;
3	21 F10 / BACK WORD	40 (60 <
4	22 F11	41)	61 =
5 WHITE	23 F12 / NEXT WORD	42 *	62 >
6	24 SET/CLEAR TAB	43 +	63 ?
7 BELL	25 F13	44 ,	64 @
8	26 F14 / BACK TAB	45 -	65 A
9 	27 ESCAPE	46 .	66 B
10 LINEFEED	28 RED	47 /	67 C
11 DISABLE  	29 	48 0	68 D
12 ENABLE  	30 GREEN	49 1	69 E
13 	31 BLUE	50 2	70 F
14 LOWER CASE	32 	51 3	71 G
15 BLINK/FLASH ON	33 !	52 4	72 H
16 F9	34 "	53 5	73 I
17 	35 #	54 6	74 J
	36 \$	55 7	75 K
		56 8	76 L













77 M	106	135 F5	163
78 N	107	136 F7	164
79 O	108	137 F2	165
80 P	109	138 F4	166
81 Q	110	139 F6	167
82 R	111	140 F8	168
83 S	112	141	169
84 T	113	142 UPPERCASE	170
85 U	114	143 BLINK/FLASH OFF	171
86 V	115	144 BLACK	172
87 W	116	145	173
88 X	117	146	174
89 Y	118	147	175
90 Z	119	148	176
91 [120	149 BROWN	177
92 £	121	150 LT. RED	178
93]	122	151 DK. GRAY	179
94 ↑	123	152 GRAY	180
95 ←	124	153 LT. GREEN	181
96	125	154 LT. BLUE	182
97	126 π	155 LT. GRAY	183
98	127	156 PURPLE	184
99	128	157	185
100	129 ORANGE	158 YELLOW	186
101	130 UNDERLINE OFF	159 CYAN	187
102	131	160	188
103	132 HELP	161	189
104	133 F1	162	190
105	134 F3		191





NOTE: Codes from 192 to 223 are the equal to 96 to 127. Codes from 224 to 254 are equal to 160 to 190, and code 255 is equal to 126.

NOTE2: While using lowercase/uppercase mode (by pressing  + ), be aware that:









- The uppercase letters in region 65-90 of the above table are replaced with lowercase letters.
- The graphical characters in region 97-122 of the above table are replaced with uppercase letters.
- PETSCII's lowercase (65-90) and uppercase (97-122) letters are in ASCII's uppercase (65-90) and lowercase (97-122) letter regions.

CONTROL CODES



Keyboard Control	Function
Colours	
 +  to 	Choose from the first range of colours. More information on the colours available is under the BASIC BACKGROUND command on page B-18.
 +  to 	Choose from the second range of colours.
 + 	Restores the colour of the cursor back to the default (white).
Tabs	
 + 	Tabs the cursor to the left. If there are no tab positions remaining, the cursor will remain at the start of the line.
 + 	Tabs the cursor to the right. If there are no tab positions remaining, the cursor will remain at the end of the line.



































Keyboard Control	Function
	Sets or clears the current screen column as a tab position. Use  +  and  to jump back and forth to all positions set with  .

Movement





	Moves the cursor down one line at a time. Equivalent to  .
	Moves the cursor down a position. If you are on a long line of BASIC code that has extended to two lines, then the cursor will move down two rows to be on the next line.
	Equivalent to  .
	Backspace the character immediately to the left and to shift all rightmost characters one position to the left. This is equivalent to  .
	Performs a carriage return, equivalent to  .

Word movement

	Moves the cursor back to the start of the previous word. If there are no words between the current cursor position and the start of the line, the cursor will move to the first column of the current line.
	Advances the cursor forward to the start of the next word. If there are no words between the cursor and the end of the line, the cursor will move to the first column of the next line.











Keyboard Control	Function
Scrolling	
 + 	Scroll BASIC listing down one line. Equivalent to  .
 + 	Scroll BASIC listing up one line. Equivalent to  .
 + 	Equivalent to  .
Formatting	
 + 	Enables underline text mode. You can disable underline mode by pressing  , then  .
 + 	Enables flashing text mode. You can disable flashing mode by pressing  , then  .
Casing	
 + 	Changes the text case mode from uppercase to lowercase.
 + 	Locks the uppercase/lowercase mode switch usually performed with  +  .
 + 	Enables the uppercase/lowercase mode switch that is performed with the  +  .
Miscellaneous	
 + 	Produces a bell tone.
 + 	Equivalent to pressing  .
 + 	Enters the Matrix Mode Debugger.







SHIFTED CODES

Keyboard Control	Function
 + 	Insert a character at the current cursor position and move all characters to the right by one position.
 + 	Clear home, clear the entire screen, and move the cursor to the home position.









ESCAPE SEQUENCES

To perform an Escape Sequence, press and release , then press one of the following keys to perform the sequence:











Key	Sequence
Editor behaviour	
 	Clears the screen and toggles between 40 and 80-column modes.
 	Clears a region of the screen, starting from the current cursor position, to the end of the screen.
 	Cancel the quote, reverse, underline, and flash modes.
Scrolling	
 	Scrolls the entire screen up one line.
 	Scrolls the entire screen down one line.







Key	Sequence
 	Enables scrolling when  is pressed at the bottom of the screen.
 	Disables scrolling. When pressing  at the bottom of the screen, the cursor will move to the top of the screen. However, when pressing  at the top of the screen, the cursor will remain on the first line.

Insertion and deletion











 	Inserts an empty line at the current cursor position and moves all subsequent lines down one position.
 	Deletes the current line and moves lines below the cursor up one position.
 	Erases all characters from the cursor to the start of the current line.
 	Erases all characters from the cursor to the end of the current line.

Movement









 	Moves the cursor to the start of the current line.
 	Moves the cursor to the last non-whitespace character on the current line.
 	Saves the current cursor position. Use   (next to ) to move it back to the saved position. Note that the  used here is next to  .

Key	Sequence
 	Restores the cursor position to the position stored via a prior a press of the   (next to ) key sequence. Note that the  used here is next to  .

Windowing

 	Sets the top-left corner of the windowed area. All typed characters and screen activity will be restricted to the area. Also see   . Windowed mode can be disabled by pressing  twice.
 	Sets the bottom right corner of the windowed area. All typed characters and screen activity will be restricted to the area. Also see   . Windowed mode can be disabled by pressing  twice.

Cursor behaviour

 	Enables auto-insert mode. Any keys pressed will be inserted at the current cursor position, shifting all characters on the current line after the cursor to the right by one position.
 	Disables auto-insert mode, reverting back to overwrite mode.
 	Sets the cursor to non-flashing mode.
 	Sets the cursor to regular flashing mode.

Bell behaviour

Key	Sequence
ESC G	Enables the bell which can be sounded using CTRL and G .
ESC H	Disable the bell so that pressing CTRL and G will have no effect.

Colours

ESC S	Switches the VIC-IV to colour range 16-31. These colours can be accessed with CTRL and keys 1 to 8 or M and keys 1 to 8 .
ESC U	Switches the VIC-IV to colour range 0-15. These colours can be accessed with CTRL and keys 1 to 8 or M and keys 1 to 8 .

Tabs

ESC Y	Set the default tab stops (every 8 spaces) for the entire screen.
ESC Z	Clears all tab stops. Any tabbing with CTRL and I will move the cursor to the end of the line.

APPENDIX

D

The MEGA65 Keyboard

- **Hardware Accelerated Keyboard Scanning**
- **Keyboard Theory of Operation**
- **C65 Keyboard Matrix**
- **Synthetic Key Events**
- **Keyboard LED Control**
- **Native Keyboard Matrix**

The MEGA65 has a full mechanical keyboard which is compatible with the C65 and C64 keyboards, and features four distinct cursor keys which work in both C64 and C65-mode, as well as eleven new C65 keys that normally work only in C65-mode.

HARDWARE ACCELERATED KEYBOARD SCANNING

To make use of the new extended keyboard easier, the MEGA65 features a hardware accelerated keyboard scan circuit, that provides ASCII (not PETSCII!) codes for keys and key-combinations. This makes it very simple to use the full capabilities of the MEGA65's keyboard, including the entry of ASCII symbols such as {, _ and |, which are not possible to type on a normal C64 and C128 keyboards.

The hardware accelerated keyboard scanner has a buffer of 3 keys, which helps to make it easier to read from the keyboard without having check it too regularly. Further, the hardware accelerated keyboard scanner supports most Latin-1 code-page characters, allowing the entry of many accented characters. These keys are entered by holding down  and pressing other keys or key-combinations. The use of ASCII or Latin-1 symbols not present in the PETSCII character set requires the use of a font that contains these symbols, and software which supports them.

The hardware accelerated keyboard scanner is very simple to use: First, make sure that you have the MEGA65 I/O context activated, then read memory location \$D610 (decimal 54800). If the register contains zero, no key has been pressed. Otherwise the value will be the ASCII code of the most recent key or key-combination that has been pressed. Reading \$D610 again will continue to read the same value until you **POKE** any value into \$D610. This clears the key from the input buffer.

The hardware accelerated keyboard scanner also provides a register that indicates which of the modifier keys are currently being held down. This is accessed via the read-only register \$D611 (decimal 54801):

Bit 0 Right 

Bit 1 Left 

Bit 2 

Bit 3 

Bit 4 

Bit 5 

Bit 6 

Bit 7 Reserved

Note that the hardware accelerated keyboard scanner operates independently of the C64 or C65 KERNAL keyboard scanning routines. That is, the KERNAL will still have any keys that you have entered buffered in the normal way. For assembly language programs the easiest solution to this is to disable interrupts via the SEI instruction. This prevents the KERNAL keyboard scanner from running.

Latin-1 Keyboard Map

KEYBOARD THEORY OF OPERATION

The MEGA65 keyboard is a full mechanical keyboard, constructed as a matrix. Every key switch is fitted with a diode, which allows the keyboard hardware to detect when any combination of keys are pressed at the same time. This matrix is scanned by the firmware in the CPLD chip on the keyboard PCB many thousands of times per second. The matrix arrangement of the MEGA65 keyboard does not use the C65 matrix layout.

Instead, the CPLD also sorts the natural matrix of the keyboard into the C65 keyboard matrix order, and transmits this serially via the keyboard cable to the MEGA65 mainboard. The MEGA65 core reads this serial data and uses it to reconstruct a C65-compatible virtual keyboard in the FPGA. This virtual keyboard also takes input from the on-screen-keyboard, synthetic keyboard injection mechanism and/or other keyboard input sources depending on the MEGA65 model.

The end-to-end latency of the keyboard is less than one milli-second.

C65 KEYBOARD MATRIX

The MEGA65 keyboard presents to legacy software as a C65-compatible keyboard. In this mode all keys are available for standard PETSCII scanning as per normal. There is also a hardware accelerated mechanism for detecting arbitrary combinations of keys that are held down. This is via \$D6 14 (decimal 54804). Writing a value between 0 and 8 to this register selects the corresponding row of the C65 keyboard matrix, which can then be read back from \$D6 13. If a bit is zero, then it means that the key is being pressed. If the bit is one, then the key is not being pressed.

The left and up cursor keys are special, because they logically press cursor right or down, and the right shift key. To be able to differentiate between these two situations, you can read \$D60F: Bit 0 is the state of the left cursor key and bit 1 is the state of the up cursor key.





The C65 keyboard matrix layout is as follows:

	0	1	2	3	4	5	6	7	8
0	INST DEL	3	5	7	9	+	£	1	NO SCROLL
1	RETURN	W	R	Y	I	P	*	←	TAB
2	→	A	D	G	J	L	;	CTRL	ALT
3	F7	4	6	8	0	-	CLR HOME	2	HELP
4	F1	Z	C	B	M	.	SHIFT right	SPC	F9
5	F3	S	F	H	K	:	=	⏏	F11
6	F5	E	T	U	O	@	↑	Q	F13
7	↓	SHIFT left	X	V	N	,	/	RUN STOP	ESC

Note that the keyboard matrix is identical to the C64 keyboard matrix, except for the addition of one extra column on the right-hand side. The cursor left and up keys on the MEGA65 and C65 are implemented as cursor right and down, but with the right shift key applied. This enables them to work in C64-mode.  is not part of the matrix, but has its own dedicated line. Its status can be read from bit 6 of register \$D611 (decimal 54801):

The numbers across the top indicate the columns of the matrix, and the numbers down the left indicate the rows. The unique scan code of a key is calculated by multiplying the column by eight, and adding the row. For example,  is in column 6 and row 3. Thus its scan code is $6 \times 8 + 3 = 51$.

SYNTHETIC KEY EVENTS

The MEGA65 keyboard interface logic allows the use of a variety of keyboard types and alternatives. This is partly to cater for the early development on general purpose FPGA boards, the MEGApHONE with its touch interface, and the desktop versions of the MEGA65 architecture. The depressing of up to 3 three keys can be simulated via the registers \$D615 - \$D617 (decimal 54,805 - 54,807). By setting the lower 7 bits of these registers to any C65 keyboard scan code, the MEGA65 will behave as though that key is being held down.  exists outside of the keyboard matrix, as on the C64. To simulate holding  down, write \$52 (ASCII code for a capital R), and to simulate a quick tap of the , write \$72 (ASCII code for a lowercase R). Another value must be written after the \$72 value has been written, if you wish to simulate multiple presses of .

To release a key, write \$7F (decimal 127) to the register containing the active key press. For example, to simulate briefly pressing the * key, the following could be used:

```
POKE DEC("D615"),6*8+1:FORI=1TO100:NEXT:POKE DEC("D615"),127
```

The FOR loop provides a suitable delay to simulate holding the key for a short time. All statements should be on a single line like this, if entered directly into the BASIC interpreter, because otherwise the MEGA65 will continue to act as though the * key is being held down, making it rather difficult to enter the other commands!

KEYBOARD LED CONTROL

The LEDs on the MEGA65's keyboard are normally controlled automatically by the system. However, it is also possible to place them under user control. This is activated by setting bit 7 (decimal 128) of \$D61D (decimal 54813). The lower bits indicate which keyboard LED to set. Values 0 through 11 correspond to the red, green and blue channels of the four LEDs. The table below shows the specific values:

- 0** left-half of DRIVE LED, RED
- 1** left-half of DRIVE LED, GREEN
- 2** left-half of DRIVE LED, BLUE
- 3** right-half of DRIVE LED, RED
- 4** right-half of DRIVE LED, GREEN
- 5** right-half of DRIVE LED, BLUE
- 6** left-half of POWER LED, RED
- 7** left-half of POWER LED, GREEN
- 8** left-half of POWER LED, BLUE
- 9** right-half of POWER LED, RED
- 10** right-half of POWER LED, GREEN
- 11** right-half of POWER LED, BLUE

Register \$D61E (decimal 54814) is used to specify the intensity that should be given to a specific LED (value between 0 and 255).

Note that whatever value is in \$D61E gets written to whatever register is currently selected in \$D61D. Therefore to safely change the intensity of one specific LED en-

sure \$D61D is set to 255 first. This prevents affecting another LED when we set the intended intensity value into \$D61E. Now select the target LED by setting \$D61D to $128 + x$, where x is a value from the table above. Hold the \$D61D, \$D61E configuration for approximately one millisecond to give the keyboard logic enough time to pick up the new intensity value for the selected LED.

To return the keyboard LEDs to hardware control, clear bit 7 of \$D61D.

For example to pulse the keyboard LEDs red and blue, the following program could be used:

```
10 REM ENABLE SOFTWARE CONTROL OF LEDS
20 POKEDC("D61D"),128
30 REM SET ALL LEDS TO OFF
40 POKEDC("D61E"),0
50 FORI=0TO11:POKEDC("D61D"),128+I:NEXT
60 REM SELECT RED CHANNEL OF RIGHT MOST LED
70 POKEDC("D61D"),128
80 REM CYCLE FROM BLACK TO RED AND BACK
90 FORI=0TO255:POKEDC("D61E"),I:NEXT
100 FORI=255TO0STEP-1:POKEDC("D61E"),I:NEXT
110 REM SELECT BLUE CHANNEL OF LEFT MOST LED
120 POKEDC("D61D"),128+8
130 REM CYCLE FRO BLACK TO BLUE AND BACK
140 FORI=0TO255:POKEDC("D61E"),I:NEXT
150 FORI=255TO0STEP-1:POKEDC("D61E"),I:NEXT
160 GOTO70
```

NATIVE KEYBOARD MATRIX

The native keyboard matrix is accessible only from the CPLD on the MEGA65's keyboard. If you are programming the MEGA65 computer, you should not need to use this.

0 F5

1 9





2 |

3 K

4 <

5 INST
DEL

6 CLR
HOME

- 7 O
- 8 **F3**
- 9 8
- 10 U
- 11 J
- 12 M
- 13 
- 14 £
- 15 =
- 16 **F1**
- 17 7
- 18 Y
- 19 H
- 20 N
- 21 
- 22 -
- 23 ;
- 24 Reserved
- 25 6
- 26 T
- 27 G
- 28 B
- 29  (cursor left)
- 30 +
- 31 :
- 32 **NO SCROLL**
- 33 5
- 34 R
- 35 F
- 36 V
- 37 **SPACE**
- 38 0
- 39 L
- 40 **CAPS LOCK**
- 41 4
- 42 E
- 43 D
- 44 C
- 45 Reserved
- 46 **HELP**
- 47 **RETURN**
- 48 **ALT**
- 49 3
- 50 W
- 51 S
- 52 X
- 53  (cursor up)
- 54 **F13**
- 55  (next to *)
- 56 **ESC**
- 57 2
- 58 Q
- 59 A
- 60 Z
- 61 right **SHIFT**

62 **F11**

63 *

64 Reserved

65 1

66 Reserved

67 Reserved

68 left **SHIFT** and **SHIFT LOCK**

69 /

70 **F9**

71 @

72 **RUN STOP**

73 **←** (next to 1)

74 **TAB**

75 **CTRL**

76 **M**

77 >

78 **F7**

79 P

APPENDIX

E

Decimal, Binary and Hexadecimal

- **Numbers**
- **Notations and Bases**
- **Operations**
- **Signed and Unsigned Numbers**
- **Bit-wise Logical Operators**
- **Converting Numbers**

NUMBERS

Simple computer programs, such as most of the introductory BASIC programs in this book, do not require an understanding of mathematics or much knowledge about the inner workings of the computer. This is because BASIC is considered a high-level programming language. It lets us program the computer somewhat indirectly, yet still gives us control over the computer's features. Most of the time, we don't need to concern ourselves with the computer's internal architecture, which is why BASIC is user friendly and accessible.

As you acquire deeper knowledge and become more experienced, you will often want to instruct the computer to perform complex or specialised tasks that differ from the examples given in this book. Perhaps for reasons of efficiency, you may also want to exercise direct and precise control over the contents of the computer's memory. This is especially true for applications that deal with advanced graphics and sound. Such operations are closer to the hardware and are therefore considered low-level. Some simple mathematical knowledge is required to be able to use these low-level features effectively.

The collective position of the tiny switches inside the computer—whether each switch is on or off—is the state of the computer. It is natural to associate numerical concepts with this state. Numbers let us understand and manipulate the internals of the machine via logic and arithmetic operations. Numbers also let us encode the two essential and important pieces of information that lie within every computer program: *instructions* and *data*.

A program's instructions tell a computer what to do and how to do it. For example, the action of outputting a text string to the screen via the statement **PRINT** is an instruction. The action of displaying a sprite and the action of changing the screen's border colour are instructions too. Behind the scenes, every instruction you give to the computer is associated with one or more numbers (which, in turn, correspond to the tiny switches inside the computer being switched on or off). Most of the time these instructions won't look like numbers to you. Instead, they might take the form of statements in BASIC.

A program's data consists of information. For example, the greeting "HELLO MEGA65!" is PETSCII character data in the form of a text string. The graphical design of a sprite might be pixel data in the form of a hero for a game. And the colour data of the screen's border might represent orange. Again, behind the scenes, every piece of data you give to the computer is associated with one or more numbers. Data is sometimes given directly next to the statement to which it applies. This data is referred to as a parameter or argument (such as when changing the screen colour with a **BACKGROUND 1** statement). Data may also be given within the program via the BASIC statement **DATA** which accepts a list of comma-separated values.

All such numbers—regardless of whether they represent instructions or data—reside in the computer’s memory. Although the computer’s memory is highly structured, the computer does not distinguish between instructions and data, nor does it have separate areas of memory for each kind of information. Instead, both are stored in whichever memory location is considered convenient. Whether a given memory location’s contents is part of the program’s instructions or is part of the program’s data largely depends on your viewpoint, the program being written and the needs of the programmer.

Although BASIC is a high-level language, it still provides statements that allow programmers to manipulate the computer’s memory efficiently. The statement **PEEK** lets us read the information from a specified memory location: we can inspect the contents of a memory address. The statement **POKE** lets us store information inside a specified memory location: we can modify the contents of a memory address so that it is set to a given value.

NOTATIONS AND BASES

We now take a look at numbers.

Numbers are ideas about quantity and magnitude. In order to manipulate numbers and determine relationships between them, it’s important for them to have a unique form. This brings us to the idea of the symbolic representation of numbers using a positional notation. In this appendix we’ll restrict our discussion to whole numbers, which are also called *integers*.

The *decimal* representation of numbers is the one with which you will be most comfortable since it is the one you were taught at school. Decimal notation uses the ten Hindu–Arabic numerals 0, 1, 2, 3, 4, 5, 6, 7, 8 and 9 and is thus referred to as a base 10 numeral system. As we shall see later, in order to express large numbers in decimal, we use a positional system in which we juxtapose digits into columns to form a bigger number.

For example, 53280 is a decimal number. Each such digit (0 to 9) in a decimal number represents a multiple of some power of 10. When a BASIC statement (such as **PEEK** or **POKE**) requires an integer as a parameter, that parameter is given in the decimal form.

Although the decimal notation feels natural and comfortable for humans to use, modern computers, at their most fundamental level, use a different notation. This notation is called *binary*. It is also referred to as a base 2 numeral system because it uses only two Hindu–Arabic numerals: 0 and 1. Binary reflects the fact that each of the tiny switches inside the computer must be in exactly one of two mutually exclusive states: on or off. The number 0 is associated with off and the number 1 is associated with on.

Binary is the simplest notation that captures this idea. In order to express large numbers in binary, we use a positional system in which we juxtapose digits into columns to form a bigger number and prefix it with a % sign.

For example, %1001 0110 is a binary number. Each such digit (0 or 1) in a binary number represents a multiple of some power of 2.

We'll see later how we can use special BASIC statements to manipulate the patterns of ones and zeros present in a binary number to change the state of the switches associated with it. Effectively, we can toggle individual switches on or off, as needed.

A third notation called *hexadecimal* is also often used. This is a base 16 numeral system. Because it uses more than ten digits, we need to use some letters to represent the extra digits. Hexadecimal uses the ten Hindu-Arabic digits 0 to 9 as well as the six Latin alphabetic characters as "digits" (A, B, C, D, E and F) to represent the numbers 10 to 15. This gives a total of sixteen symbols for the numbers 0 to 15. To express a large number in hexadecimal, we use a positional system in which we juxtapose digits into columns to form a bigger number and prefix it with a \$ sign.

For example, \$E7 is a hexadecimal number. Each such digit (0 to 9 and A to F) in a hexadecimal number represents a multiple of some power of 16.

Hexadecimal is not often used when programming in BASIC. It is more commonly used when programming in low-level languages like machine code or assembly language. It also appears in computer memory maps and its brevity makes it a useful notation, so it is described here.

Always remember that decimal, binary and hexadecimal are just different notations for numbers. A notation just changes the way the number is written (i.e., the way it looks on paper or on the screen), but its intrinsic value remains unchanged. A notation is essentially different ways of representing the same thing. The reason that we use different notations is that each notation lends itself more naturally to a different task.

When using decimal, binary and hexadecimal for extended periods you may find it handy to have a scientific pocket calculator with a programmer mode. Such calculators can convert between bases with the press of a button. They can also add, subtract, multiply and divide, and perform various bit-wise logical operations. See Chapter/Appendix R on page R-3 as it contains a Base Conversion table for decimal, binary, and hexadecimal for integers between 0 and 255.

The BASIC listing for this appendix is a utility program that converts individual numbers into different bases. It can also convert multiple numbers within a specified range.

Although these concepts might be new now, with some practice they'll soon seem like second nature. We'll look at ways of expressing numbers in more detail. Later, we'll also investigate the various operations that we can perform on such numbers.

Decimal

When representing integers using decimal notation, each column in the number is for a different power of 10. The rightmost position represents the number of units (because $10^0 = 1$) and each column to the left of it is 10 times larger than the column before it. The rightmost column is called the units column. Columns to the left of it are labelled tens (because $10^1 = 10$), hundreds (because $10^2 = 100$), thousands (because $10^3 = 1000$), and so on.

To give an example, the integer 53280 represents the total of 5 lots of 10000, 3 lots of 1000, 2 lots of 100, 8 lots of 10 and 0 units. This can be seen more clearly if we break the integer up into distinct parts, by column.

Since

$$53280 = 50000 + 3000 + 200 + 80 + 0$$

we can present this as a table with the sum of each column at the bottom.

TEN THOUSANDS	THOUSANDS	HUNDREDS	TENS	UNITS
$10^4 = 10000$	$10^3 = 1000$	$10^2 = 100$	$10^1 = 10$	$10^0 = 1$
5	0	0	0	0
	3	0	0	0
		2	0	0
			8	0
				0
5	3	2	8	0

Another way of stating this is to write the expression using multiples of powers of 10.

$$53280 = (5 \times 10^4) + (3 \times 10^3) + (2 \times 10^2) + (8 \times 10^1) + (0 \times 10^0)$$

Alternatively

$$53280 = (5 \times 10000) + (3 \times 1000) + (2 \times 100) + (8 \times 10) + (0 \times 1)$$

We now introduce some useful terminology that is associated with decimal numbers.

The rightmost digit of a decimal number is called the least significant digit, because, being the smallest multiplier of a power of 10, it contributes the least to the number's magnitude. Each digit to the left of this digit has increasing significance. The leftmost (non-zero) digit of the decimal number is called the most significant digit, because, being the largest multiplier of a power of 10, it contributes the most to the number's magnitude.

For example, in the decimal number 53280, the digit 0 is the least significant digit and the digit 5 is the most significant digit.

A decimal number a is m orders of magnitude greater than the decimal number b if $a = b \times (10^m)$. For example, 50000 is three orders of magnitude greater than 50, because it has three more zeros. This terminology can be useful when making comparisons between numbers or when comparing the time efficiency or space efficiency of two programs with respect to the sizes of the given inputs.

Note that unlike binary (which uses a conventional % prefix) and hexadecimal (which uses a conventional \$ prefix), decimal numbers are given no special prefix. In some textbooks you might see such numbers with a subscript instead. So decimal numbers will have a sub-scripted 10, binary numbers will have a sub-scripted 2, and hexadecimal numbers will have a sub-scripted 16.

Another useful concept is the idea of signed and unsigned decimal integers.

A signed decimal integer can be positive or negative or zero. To represent a signed decimal integer, we prefix it with either a + sign or a - sign. (By convention, zero, which is neither positive nor negative, is given the + sign.)

If, on the other hand, a decimal integer is unsigned it must be either zero or positive and does not have a negative representation. This can be illustrated with the BASIC statements **PEEK** and **POKE**. When we use **PEEK** to return the value contained within a memory location, we get back an unsigned decimal number. For example, the statement **PRINT (PEEK (49152))** outputs the contents of memory location 49152 to the screen as an unsigned decimal number. Note that the memory address that we gave to **PEEK** is itself an unsigned integer. When we use **POKE** to store a value inside a memory location, both the memory address and the value to store inside it are given as unsigned integers. For example, the statement **POKE 49152, 128** stores the unsigned decimal integer 128 into the memory address given by the unsigned decimal integer 49152.

Each memory location in the MEGA65 can store a decimal integer between 0 and 255. This corresponds to the smallest and largest decimal integers that can be represented using eight binary digits (eight bits). Also, the memory addresses are decimal integers between 0 and 65535. This corresponds to the smallest and largest decimal integers that can be represented using sixteen binary digits (sixteen bits).

Note that the largest number expressible using d decimal digits is $10^d - 1$. (This number will have d nines in its representation.)

Binary

Binary notation uses powers of 2 (instead of 10 which is for decimal). The rightmost position represents the number of units (because $2^0 = 1$) and each column to the left of it is 2 times larger than the column before it. Columns to the left of the rightmost

column are the twos column (because $2^1 = 2$), the fours column (because $2^2 = 4$), the eights column (because $2^3 = 8$), and so on.

As an example, the integer %1101 0011 uses exactly eight binary digits and represents the total of 1 lot of 128, 1 lot of 64, 0 lots of 32, 1 lot of 16, 0 lots of 8, 0 lots of 4, 1 lot of 2 and 1 unit.

We can break this integer up into distinct parts, by column.

Since

$$\%1101\ 0011 = \%1000\ 0000 + \%100\ 0000 + \%00\ 0000 + \%1\ 0000 + \%0000 + \%000 + \%10 + \%1$$

we can present this as a table with the sum of each column at the bottom.

ONE HUNDRED AND TWENTY-EIGHTS	SIXTY- FOURS	THIRTY- TWS	SIXTEENS	EIGHTS	FOURS	TWOS	UNITS
$2^7 = 128$	$2^6 = 64$	$2^5 = 32$	$2^4 = 16$	$2^3 = 8$	$2^2 = 4$	$2^1 = 2$	$2^0 = 1$
1	0	0	0	0	0	0	0
	1	0	0	0	0	0	0
		0	0	0	0	0	0
			1	0	0	0	0
				0	0	0	0
					0	0	0
						1	0
							1
1	1	0	1	0	0	1	1

Another way of stating this is to write the expression in decimal, using multiples of powers of 2.

$$\%11010011 = (1 \times 2^7) + (1 \times 2^6) + (0 \times 2^5) + (1 \times 2^4) + (0 \times 2^3) + (0 \times 2^2) + (1 \times 2^1) + (1 \times 2^0)$$

Alternatively

$$\%11010011 = (1 \times 128) + (1 \times 64) + (0 \times 32) + (1 \times 16) + (0 \times 8) + (0 \times 4) + (1 \times 2) + (1 \times 1)$$

which is the same as writing

$$\%11010011 = 128 + 64 + 16 + 2 + 1$$

Binary has terminology of its own. Each binary digit in a binary number is called a *bit*. In an 8-bit number the bits are numbered consecutively with the least significant (i.e., rightmost) bit as bit 0 and the most significant (i.e., leftmost) bit as bit 7. In a 16-bit number the most significant bit is bit 15. A bit is said to be *set* if it equals 1. A bit is

said to be *clear* if it equals 0. When a particular bit has a special meaning attached to it, we sometimes refer to it as a *flag*.

1	1	0	1	0	0	1	1
Bit 7	Bit 6	Bit 5	Bit 4	Bit 3	Bit 2	Bit 1	Bit 0

As mentioned earlier, each memory location can store an integer between 0 and 255. The minimum corresponds to %0000 0000 and the maximum corresponds to %1111 1111, which are the smallest and largest numbers that can be represented using exactly eight bits. The memory addresses use 16 bits. The smallest memory address, represented in exactly sixteen bits, is %0000 0000 0000 0000 and this corresponds to the smallest 16-bit number. Likewise, the largest memory address, represented in exactly sixteen bits, is %1111 1111 1111 1111 and this corresponds to the largest 16-bit number.

It is often convenient to refer to groups of bits by different names. For example, eight bits make a *byte* and 1024 bytes make a *kilobyte*. Half a byte is called a *nibble*. See Chapter/Appendix R on page R-3 for the Units of Storage table for further information.

Note that the largest number expressible using d binary digits is (in decimal) $2^d - 1$. (This number will have d ones in its representation.)

Hexadecimal

Hexadecimal notation uses powers of 16. Each of the sixteen hexadecimal numerals has an associated value in decimal.

Hexadecimal Numeral	Decimal Equivalent
\$0	0
\$1	1
\$2	2
\$3	3
\$4	4
\$5	5
\$6	6
\$7	7
\$8	8
\$9	9
\$A	10
\$B	11
\$C	12
\$D	13
\$E	14
\$F	15

The rightmost position in a hexadecimal number represents the number of ones (since $16^0 = 1$). Each column to the left of this digit is 16 times larger than the column before it. Columns to the left of the rightmost column are the 16-column (since $16^1 = 16$), the 256-column (since $16^2 = 256$), the 4096-column (since $16^3 = 4096$), and so on.

As an example, the integer \$A3F2 uses exactly four hexadecimal digits and represents the total of 10 lots of 4096 (because \$A = 10), 3 lots of 256 (because \$3 = 3), 15 lots of 16 (because \$F = 15) and 2 units (because \$2 = 2). We can break this integer up into distinct parts, by column.

Since

$$\$A3F2 = \$A000 + \$300 + \$F0 + \$2$$

we can present this as a table with the sum of each column at the bottom.

FOUR THOUSAND AND NINETY-SIXES	TWO HUNDRED AND FIFTY-SIXES	SIXTEENS	UNITS
$16^3 = 4096$	$16^2 = 256$	$16^1 = 16$	$16^0 = 1$
A	0	0	0
	3	0	0
		F	0
			2
A	3	F	2

Another way of stating this is to write the expression in decimal, using multiples of powers of 16.

$$\text{\$A3F2} = (10 \times 16^3) + (3 \times 16^2) + (15 \times 16^1) + (2 \times 16^0)$$

Alternatively

$$\text{\$A3F2} = (10 \times 4096) + (3 \times 256) + (15 \times 16) + (2 \times 1)$$

which is the same as writing

$$\text{\$A3F2} = 40960 + 768 + 240 + 2$$

Again, like binary and decimal, the rightmost digit is the least significant and the leftmost digit is the most significant.

Each memory location can store an integer between 0 and 255, and this corresponds to the hexadecimal numbers $\text{\$00}$ and $\text{\$FF}$. The hexadecimal number $\text{\$FFFF}$ corresponds to 65535—the largest 16-bit number.

Hexadecimal notation is often more convenient to use and manipulate than binary. Binary numbers consist of a longer sequence of ones and zeros, while hexadecimal is much shorter and more compact. This is because one hexadecimal digit is equal to exactly four bits. So a two-digit hexadecimal number comprises of eight bits with the low nibble equalling the right digit and the high nibble equalling the left digit.

Note that the largest number expressible using d hexadecimal digits is (in decimal) $16^d - 1$. (This number will have d $\text{\$}$ symbols in its representation.)

OPERATIONS

In this section we'll take a tour of some familiar operations like counting and arithmetic, and we'll see how they apply to numbers written in binary and hexadecimal.

Then we'll take a look at various logical operations using logic gates. These operations are easy to understand. They're also very important when it comes to writing programs that have extensive numeric, graphic or sound capabilities.

Counting

If we consider carefully the process of *counting* in decimal, this will help us to understand how counting works when using binary and hexadecimal.

Let's suppose that we're counting in decimal and that we're starting at 0. Recall that the list of numerals for decimal is (in order) 0, 1, 2, 3, 4, 5, 6, 7, 8 and 9. Notice that

when we add 1 to 0 we obtain 1, and when we add 1 to 1 we obtain 2. We can continue in this manner, always adding 1:

$$\begin{aligned}0 + 1 &= 1 \\1 + 1 &= 2 \\2 + 1 &= 3 \\3 + 1 &= 4 \\4 + 1 &= 5 \\5 + 1 &= 6 \\6 + 1 &= 7 \\7 + 1 &= 8 \\8 + 1 &= 9\end{aligned}$$

Since 9 is the highest numeral in our list of numerals for decimal, we need some way of handling the following special addition: $9 + 1$. The answer is that we can reuse our old numerals all over again. In this important step, we reset the units column back to 0 and (at the same time) add 1 to the tens column. Since the tens column contained a 0, this gives us $9 + 1 = 10$. We say we “carried” the 1 over to the tens column while the units column cycled back to 0.

Using this technique, we can count as high as we like. The principle of counting for binary and hexadecimal is very much the same, except instead of using ten symbols, we get to use two symbols and sixteen symbols, respectively.

Let’s take a look at counting in binary. Recall that the list of numerals for binary is (in order) just 0 and 1. So, if we begin counting at %0 and then add %1, we obtain %1 as the result:

$$\%0 + \%1 = \%1$$

Now, the sum $\%1 + \%1$ will cause us to perform the analogous step: we reset the units column back to zero and (at the same time) add %1 to the twos column. Since the twos column contained a %0, this gives us $\%1 + \%1 = \%10$. We say we “carried” the %1 over to the twos column while the units column cycled back to %0. If we continue in this manner we can count higher.

$$\begin{aligned}\%1 + \%1 &= \%10 \\ \%10 + \%1 &= \%11 \\ \%11 + \%1 &= \%100 \\ \%100 + \%1 &= \%101 \\ \%101 + \%1 &= \%110 \\ \%110 + \%1 &= \%111 \\ \%111 + \%1 &= \%1000\end{aligned}$$

Now we'll look at counting in hexadecimal. The list of numerals for hexadecimal is (in order) 0, 1, 2, 3, 4, 5, 6, 7, 8, 9, A, B, C, D, E and F. If we begin counting at \$0 and repeatedly add \$1 we obtain:

$$\begin{aligned}
 \$0 + \$1 &= \$1 \\
 \$1 + \$1 &= \$2 \\
 \$2 + \$1 &= \$3 \\
 \$3 + \$1 &= \$4 \\
 \$4 + \$1 &= \$5 \\
 \$5 + \$1 &= \$6 \\
 \$6 + \$1 &= \$7 \\
 \$7 + \$1 &= \$8 \\
 \$8 + \$1 &= \$9 \\
 \$9 + \$1 &= \$A \\
 \$A + \$1 &= \$B \\
 \$B + \$1 &= \$C \\
 \$C + \$1 &= \$D \\
 \$D + \$1 &= \$E \\
 \$E + \$1 &= \$F
 \end{aligned}$$

Now, when we compute \$F + \$1 we must reset the units column back to \$0 and add \$1 to the sixteens column as that number is "carried".

$$\$F + \$1 = \$10$$

Again, this process allows us to count as high as we like.

Arithmetic

The standard arithmetic operations of addition, subtraction, multiplication and division are all possible using binary and hexadecimal.

Addition is done in the same way that addition is done using decimal, except that we use base 2 or base 16 as appropriate. Consider the following example for the addition of two binary numbers.

$$\begin{array}{r}
 \% 1 1 0 \\
 + \% 1 1 1 \\
 \hline
 \% 1 1 0 1
 \end{array}$$

We obtain the result by first adding the units columns of both numbers. This gives us %0 + %1 = %1 with nothing to carry into the next column. Then we add the twos columns of both numbers: %1 + %1 = %0 with a %1 to carry into the next column. We then add the fours columns (plus the carry) giving (%1 + %1) + %1 = %1 with a %1 to carry

into the next column. Last of all are the eights columns. Because these are effectively both zero we only concern ourselves with the carry which is %1. So $(%0 + %0) + %1 = %1$. Thus, %1101 is the sum.

Next is an example for the addition of two hexadecimal numbers.

$$\begin{array}{r} \$ 7 D \\ + \$ 6 9 \\ \hline \$ E 6 \end{array}$$

We begin by adding the units columns of both numbers. This gives us $\$D + \$9 = \$6$ with a \$1 to carry into the next column. We then add the sixteens columns (plus the carry) giving $(\$7 + \$6) + \$1 = \E with nothing to carry and so \$E6 is the sum.

We now look at subtraction. As you might suspect, binary and hexadecimal subtraction follows a similar process to that of subtraction for decimal integers.

Consider the following subtraction of two binary numbers.

$$\begin{array}{r} \% 1 0 1 1 \\ - \% 1 1 0 \\ \hline \% 1 0 1 \end{array}$$

Starting in the units columns we perform the subtraction $\%1 - \%0 = \%1$. Next, in the twos columns we perform another subtraction $\%1 - \%1 = \%0$. Last of all we subtract the fours columns. This time, because %0 is less than %1, we'll need to borrow a %1 from the eights column of the top number to make the subtraction. Thus we compute $\%10 - \%1 = \%1$ and deduct %1 from the eights column. The eights columns are now both zeros. Since $\%0 - \%0 = \%0$ and because this is the leading digit of the result we can drop it from the final answer. This gives %101 as the result.

Let's now look at the subtraction of two hexadecimal numbers.

$$\begin{array}{r} \$ 3 D \\ - \$ 1 F \\ \hline \$ 1 E \end{array}$$

To perform this subtraction we compute the difference of the units columns. In order to do this, we note that because \$D is less than \$F we will need to borrow \$1 from the sixteens column of the top number to make the subtraction. Thus, we compute $\$1D - \$F = \$E$ and also compute $\$3 - \$1 = \$2$ in the sixteens column for the for the \$1 that we just borrowed. Next, we compute the difference of the sixteens column as $\$2 - \$1 = \$1$. This gives us a final answer of \$1E.

We won't give in depth examples of multiplication and division for binary and hexadecimal notation. Suffice to say that principles parallel those for the decimal system. Multiplication is repeated addition and division is repeated subtraction.

We will, however, point out a special type of multiplication and division for both binary and hexadecimal. This is particularly useful for manipulating binary and hexadecimal numbers.

For binary, multiplication by two is simple—just shift all bits to the left by one position and fill in the least significant bit with a %0. Division by two is simple too—just shift all bits to the right by one position and fill in the most significant bit with a %0. By doing these repeatedly we can multiply and divide by powers of two with ease.

Thus the binary number %1111, when multiplied by eight has three extra zeros on the end of it and is equal to %1111000. (Recall that $2^3 = 8$.) And the binary number %10100, when divided by four has two less digits and equals %101. (Recall that $2^2 = 4$.)

These are called left and right *bit shifts*. So if we say that we shift a number to the left four bit positions, we really mean that we multiplied it by $2^4 = 16$.

For hexadecimal, the situation is similar. Multiplication by sixteen is simple—just shift all digits to the left by one position and fill in the rightmost digit with a \$0. Division by sixteen is simple too—just shift all digits to the right by one position. By doing this repeatedly we can multiply and divide by powers of sixteen with ease.

Thus the hexadecimal number \$F, when multiplied 256 has two extra zeros on the end of it and is equal to \$F00. (Recall that $16^2 = 256$.) And the hexadecimal number \$EA0, when divided by sixteen has one less digit and equals \$EA. (Recall that $16^1 = 16$.)

Logic Gates

There exist several so-called *logic gates*. The fundamental ones are NOT, AND, OR and XOR.

They let us set, clear and invert specific binary digits. For example, when dealing with sprites, we might want to clear bit 6 (i.e., make it equal to 0) and set bit 1 (i.e., make it equal to 1) at the same time for a particular graphics chip register. Certain logic gates will, when used in combination, let us do this.

Learning how these logic gates work is very important because they are the key to understanding how and why the computer executes programs as it does.

All logic gates accept one or more inputs and produce a single output. These inputs and outputs are always single binary digits (i.e., they are 1-bit numbers).

The NOT gate is the only gate that accepts exactly one bit as input. All other gates—AND, OR, and XOR—accept exactly two bits as input. All gates produce exactly one output, and that output is a single bit.

First, let's take a look at the simplest gate, the NOT gate.

The NOT gate behaves by inverting the input bit and returning this resulting bit as its output. This is summarised in the following table.

INPUT X	OUTPUT
0	1
1	0

We write NOT x where x is the input bit.

Next, we take a look at the AND gate.

As mentioned earlier, the AND gate accepts two bits as input and produces a single bit as output. The AND gate behaves in the following manner. Whenever both input bits are equal to 1 the result of the output bit is 1. For all other inputs the result of the output bit is 0. This is summarised in the following table.

INPUT X	INPUT Y	OUTPUT
0	0	0
0	1	0
1	0	0
1	1	1

We write x AND y where x and y are the input bits.

Next, we take a look at the OR gate.

The OR gate accepts two bits as input and produces a single bit as output. The OR gate behaves in the following manner. Whenever both input bits are equal to 0 the result is 0. For all other inputs the result of the output bit is 1. This is summarised in the following table.

INPUT X	INPUT Y	OUTPUT
0	0	0
0	1	1
1	0	1
1	1	1

We write x OR y where x and y are the input bits.

Last of all we look at the XOR gate.

The XOR gate accepts two bits as input and produces a single bit as output. The XOR gate behaves in the following manner. Whenever both input bits are equal in value the output bit is 0. Otherwise, both input bits are unequal in value and the output bit is 1. This is summarised in the following table.

INPUT X	INPUT Y	OUTPUT
0	0	0
0	1	1
1	0	1
1	1	0

We write $x \text{ XOR } y$ where x and y are the input bits.

Note that there do exist some other gates. They are easy to construct.

- NAND gate: this is an AND gate followed by a NOT gate
- NOR gate: this is an OR gate followed by a NOT gate
- XNOR gate: this is an XOR gate followed by a NOT gate

SIGNED AND UNSIGNED NUMBERS

So far we've largely focused on unsigned integers. Unsigned integers have no positive or negative sign. They are always assumed to be positive. (For this purpose, zero is regarded as positive.)

Signed numbers, as mentioned earlier, can have a positive sign or a negative sign.

Signed numbers are represented by treating the most significant bit as a sign bit. This bit cannot be used for anything else. If the most significant bit is 0 then the result is interpreted as having a positive sign. Otherwise, the most significant bit is 1, and the result is interpreted as having a negative sign.

A signed 8-bit number can represent positive-sign numbers between 0 and 127, and negative-sign numbers between -1 and -128.

A signed 16-bit number can represent positive-sign numbers between 0 and 32767, and negative-sign numbers between -1 and -32768.

Reserving the most significant bit as the sign of the signed number effectively halves the range of the available positive numbers (i.e., compared to unsigned numbers), with the trade-off being that we gain an equal quantity of negative numbers instead.

To negate any signed number, every bit in the signed number must be inverted and then %1 must be added to the result. Thus, negating %0000 0101 (which is the signed number +5) gives %1111 1011 (which is the signed number -5). As expected, performing the negation of this negative number gives us +5 again.

BIT-WISE LOGICAL OPERATORS

The BASIC statements **NOT**, **AND**, **OR** and **XOR** have functionality similar to that of the logic gates that they are named after.

The **NOT** statement must be given a 16-bit signed decimal integer as a parameter. It returns a 16-bit signed decimal integer as a result.

In the following example, all sixteen bits of the signed decimal number +0 are equal to 0. The **NOT** statement inverts all sixteen bits as per the NOT gate. This sets all sixteen bits. If we interpret the result as a signed decimal number, we obtain the answer of -1.

```
PRINT (NOT 0)
-1
```

As expected, repeating the **NOT** statement on the parameter of -1 gets us back to where we started, since all sixteen set bits become cleared.

```
PRINT (NOT -1)
0
```

The **AND** statement must be given two 16-bit signed decimal integers as parameters. The second parameter is called the *bit mask*. The statement returns a 16-bit signed decimal integer as a result, having changed each bit as per the AND gate.

In the following example, the number +253 is used as the first parameter. As a 16-bit signed decimal integer, this is equivalent to the following number in binary: %0000 0000 1111 1101. The **AND** statement uses a bit mask as the second parameter with a 16-bit signed decimal value of +239. In binary this is the number %0000 0000 1110 1110. If we use the AND logic gate table on corresponding pairs of bits, we obtain the 16-bit signed decimal integer +237 (which is %0000 0000 1110 1100 in binary).

```
PRINT (253 AND 239)
237
```

We can see this process more clearly in the following table.

	%	0	0	0	0	0	0	0	0	1	1	1	1	1	1	0	1
AND	%	0	0	0	0	0	0	0	0	1	1	1	0	1	1	1	0
	%	0	0	0	0	0	0	0	0	1	1	1	0	1	1	0	0

Notice that each bit in the top row passes through unchanged wherever there is a 1 in the mask bit below it. Otherwise the bit in that position gets cleared.

The **OR** statement must be given two 16-bit signed decimal integers as parameters. The second parameter is called the *bit mask*. The statement returns a 16-bit signed decimal integer as a result, having changed each bit as per the OR gate.

In the following example, the number +240 is used as the first parameter. As a 16-bit signed decimal integer, this is equivalent to the following number in binary: %0000 0000 1111 0000. The **OR** statement uses a bit mask as the second parameter with a 16-bit signed decimal value of +19. In binary this is the number %0000 0000 0001 0011. If we use the OR logic gate table on corresponding pairs of bits, we obtain the 16-bit signed decimal integer +243 (which is %0000 0000 1111 0011 in binary).

```
PRINT (240 OR 19)
243
```

We can see this process more clearly in the following table.

	%	0	0	0	0	0	0	0	0	1	1	1	1	0	0	0	0	0
OR	%	0	0	0	0	0	0	0	0	0	0	0	1	0	0	1	1	
	%	0	0	0	0	0	0	0	0	1	1	1	1	0	0	1	1	

Notice that each bit in the top row passes through unchanged wherever there is a 0 in the mask bit below it. Otherwise the bit in that position gets set.

Next we look at the **XOR** statement. This statement must be given two 16-bit unsigned decimal integers as parameters. The second parameter is called the *bit mask*. The statement returns a 16-bit unsigned decimal integer as a result, having changed each bit as per the XOR gate.

In the following example, the number 14091 is used as the first parameter. As a 16-bit unsigned decimal integer, this is equivalent to the following number in binary: %0011 0111 0000 1011. The **XOR** statement uses a bit mask as the second parameter with a 16-bit unsigned decimal value of 8653. In binary this is the number %0010 0001 1100 1101. If we use the XOR logic gate table on corresponding pairs of bits, we obtain the 16-bit unsigned decimal integer 5830 (which is %0001 0110 1100 0110 in binary).

```
PRINT (XOR(14091,8653))
5830
```

We can see this process more clearly in the following table.

	%	0	0	1	1	0	1	1	1	0	0	0	0	1	0	1	1
XOR	%	0	0	1	0	0	0	0	1	1	1	0	0	1	1	0	1
	%	0	0	0	1	0	1	1	0	1	1	0	0	0	1	1	0

Notice that when the bits are equal the resulting bit is 0. Otherwise the resulting bit is 1.

Much of the utility of these bit-wise logical operators comes through combining them together into a compound statement. For example, the VIC II register to enable sprites is memory address 53269. There are eight sprites (numbered 0 to 7) with each bit corresponding to a sprite's status. Now suppose we want to switch off sprite 5 and switch on sprite 1, while leaving the statuses of the other sprites unchanged. We can do this with the following BASIC statement which combines an **AND** statement with an **OR** statement.

```
POKE 53269, (((PEEK(53269)) AND 223) OR 2)
```

The technique of using **PEEK** on a memory address and combining the result with bit-wise logical operators, followed by a **POKE** to that same memory address is very common.

CONVERTING NUMBERS

The program below is written in BASIC. It does number conversion for you. Type it in and save it under the name "CONVERT.BAS".

To execute the program, type **RUN** and press .

The program presents you with a series of text menus. You may choose to convert a single decimal, binary or hexadecimal number. Alternatively, you may choose to convert a range of such numbers.

The program can convert numbers in the range of 0 to 65535.

```

10 REM *****
20 REM *           *
30 REM * INTEGER BASE CONVERTER *
40 REM *           *
50 REM *****
60 POKE 0,65: BORDER 6: BACKGROUND 6: FOREGROUND 1
70 DIM P(15)
80 E$ = "STARTING INTEGER MUST BE LESS THAN OR EQUAL TO ENDING INTEGER"
90 FOR N = 0 TO 15
100 : P(N) = 2 ↑ N
110 NEXT N
120 REM *** OUTPUT MAIN MENU ***
130 PRINT CHR$(147)
140 PRINT: PRINT "INTEGER BASE CONVERTER"
150 L = 22: GOSUB 1930: PRINT L$
160 PRINT: PRINT "SELECT AN OPTION (S, M OR Q):-": PRINT
170 PRINT "[S](SPACE*2)SINGLE INTEGER CONVERSION"
180 PRINT "[M](SPACE*2)MULTIPLE INTEGER CONVERSION"
190 PRINT "[Q](SPACE*2)QUIT PROGRAM"
200 GET M$
210 IF (M$="S") THEN GOSUB 260: GOTO 140
220 IF (M$="M") THEN GOSUB 380: GOTO 140
230 IF (M$="Q") THEN END
240 GOTO 200
250 REM *** OUTPUT SINGLE CONVERSION MENU ***
260 PRINT: PRINT "{SPACE*2}SELECT AN OPTION (D, B, H OR R):-": PRINT
270 PRINT "{SPACE*2}[D](SPACE*2)CONVERT A DECIMAL INTEGER"
280 PRINT "{SPACE*2}[B](SPACE*2)CONVERT A BINARY INTEGER"
290 PRINT "{SPACE*2}[H](SPACE*2)CONVERT A HEXADECIMAL INTEGER"
300 PRINT "{SPACE*2}[R](SPACE*2)RETURN TO TOP MENU"
310 GET M1$
320 IF (M1$="D") THEN GOSUB 500: GOTO 260
330 IF (M1$="B") THEN GOSUB 760: GOTO 260
340 IF (M1$="H") THEN GOSUB 810: GOTO 260
350 IF (M1$="R") THEN RETURN
360 GOTO 310
370 REM *** OUTPUT MULTIPLE CONVERSION MENU ***
380 PRINT: PRINT "{SPACE*2}SELECT AN OPTION (D, B, H OR R):-": PRINT
390 PRINT "{SPACE*2}[D](SPACE*2)CONVERT A RANGE OF DECIMAL INTEGERS"
400 PRINT "{SPACE*2}[B](SPACE*2)CONVERT A RANGE OF BINARY INTEGERS"
410 PRINT "{SPACE*2}[H](SPACE*2)CONVERT A RANGE OF HEXADECIMAL INTEGERS"

```

```

420 PRINT "(SPACE*2)[R](SPACE*2)RETURN TO TOP MENU"
430 GET M2$
440 IF (M2$="D") THEN GOSUB 1200: GOTO 380
450 IF (M2$="B") THEN GOSUB 1670: GOTO 380
460 IF (M2$="H") THEN GOSUB 1800: GOTO 380
470 IF (M2$="R") THEN RETURN
480 GOTO 430
490 REM *** CONVERT SINGLE DECIMAL INTEGER ***
500 D$ = ""
510 PRINT: INPUT "ENTER DECIMAL INTEGER (UP TO 65535): ", D$
520 GOSUB 1030: REM VALIDATE DECIMAL INPUT
530 IF (V = 0) THEN GOTO 510
540 PRINT: PRINT " DEC";SPC(4);"BIN";SPC(19);"HEX"
550 L = 5: GOSUB 1930: L1$ = L$
560 L = 20: GOSUB 1930: L2$ = L$
570 PRINT SPC(1);L1$;SPC(2);L2$;SPC(2);L1$
580 FOREGROUND 7
590 B$ = ""
600 D1 = 0
610 IF (D < 256) THEN GOTO 660
620 D1 = INT(D / 256)
630 FOR N = 1 TO 8
640 : IF ((D1 AND P(8 - N)) > 0) THEN B$ = B$ + "1": ELSE B$ = B$ + "0"
650 NEXT N
660 IF (D < 256) THEN B$ = "%" + B$: ELSE B$ = "%" + B$ + " "
670 D2 = D - 256*D1
680 FOR N = 1 TO 8
690 : IF ((D2 AND P(8 - N)) > 0) THEN B$ = B$ + "1": ELSE B$ = B$ + "0"
700 NEXT N
710 H$ = HEX$(D)
720 IF (D < 256) THEN H$ = "(SPACE*2)$" + RIGHT$(H$,2): ELSE H$ = "$" + H$
730 IF (D < 256) THEN PRINT SPC(6 - LEN(D$)); D$;SPC(12) + MID$(B$,1,5) +
" " + MID$(B$,6,10); "(SPACE*2)" + H$: FOREGROUND 1: RETURN
740 PRINT SPC(6 - LEN(D$));D$;"(SPACE*2)" + MID$(B$,1,5) + " " + MID$(B$,6,4) +
MID$(B$,10,5) + " " + MID$(B$,15,4); "(SPACE*2)" + H$: FOREGROUND 1: RETURN
750 REM *** CONVERT SINGLE BINARY INTEGER ***
760 I$=""
770 PRINT: INPUT "ENTER BINARY INTEGER (UP TO 16 BITS): ", I$
780 GOSUB 1110: REM VALIDATE BINARY INPUT
790 IF (V = 0) THEN GOTO 760: ELSE GOTO 540
800 REM *** CONVERT SINGLE HEXADECIMAL INTEGER ***

```

```

810 H$=""
820 PRINT: INPUT "ENTER HEXADECIMAL INTEGER (UP TO 4 DIGITS): ",H$
830 GOSUB 1220: REM VALIDATE HEXADECIMAL INPUT
840 IF (V = 0) THEN GOTO 810: ELSE GOTO 540
850 REM *** VALIDATE DECIMAL INPUT STRING ***
860 FOR N = 1 TO LEN(D$)
870 : M = ASC(MID$(D$,N,1)) - ASC("0")
880 : IF ((M < 0) OR (M > 9)) THEN V = 0
890 NEXT N: RETURN
900 REM *** VALIDATE BINARY INPUT STRING ***
910 FOR N = 1 TO LEN(I$)
920 : M = ASC(MID$(I$,N,1)) - ASC("0")
930 : IF ((M < 0) OR (M > 1)) THEN V = 0
940 NEXT N: RETURN
950 REM *** VALIDATE HEXADECIMAL INPUT STRING ***
960 FOR N = 1 TO LEN(H$)
970 : M = ASC(MID$(H$,N,1)) - ASC("0")
980 : IF (NOT ((M >= 0) AND (M <= 9)) OR
(M >= 17) AND (M <= 22))) THEN V = 0
990 NEXT N: RETURN
1000 REM *** OUTPUT ERROR MESSAGE ***
1010 FOREGROUND 2: PRINT: PRINT A$: FOREGROUND 1: RETURN
1020 REM *** VALIDATE DECIMAL INPUT ***
1030 V = 1: GOSUB 860: REM VALIDATE DECIMAL INPUT STRING
1040 IF (V = 0) THEN A$ = "INVALID DECIMAL NUMBER": GOSUB 1010
1050 IF (V = 1) THEN BEGIN
1060 : D = VAL(D$)
1070 : IF ((D < 0) OR (D > 65535)) THEN A$ = "DECIMAL NUMBER OUT OF RANGE":
GOSUB 1010: V = 0
1080 BEND
1090 RETURN
1100 REM *** VALIDATE BINARY INPUT ***
1110 V = 1: GOSUB 910: REM VALIDATE BINARY INPUT STRING
1120 IF (V = 0) THEN A$ = "INVALID BINARY NUMBER": GOSUB 1010: RETURN
1130 IF (LEN(I$) > 16) THEN A$ = "BINARY NUMBER OUT OF RANGE":
GOSUB 1010: V = 0 : RETURN
1140 IF (V = 1) THEN BEGIN
1150 : I = 0
1160 : FOR N = 1 TO LEN(I$)
1170 : I = I + VAL(MID$(I$,N,1)) * P(LEN(I$) - N)
1180 : NEXT N

```

```

1190 BEND
1200 D$ = STR$(I): D = I: RETURN
1210 REM *** VALIDATE HEXADECIMAL INPUT ***
1220 V = 1: GOSUB 960: REM VALIDATE HEXADECIMAL INPUT STRING
1230 IF (V = 0) THEN A$ = "INVALID HEXADECIMAL NUMBER": GOSUB 1010: RETURN
1240 IF (LEN(H$) > 4) THEN A$ = "HEXADECIMAL NUMBER OUT OF RANGE":
GOSUB 1010: V = 0: RETURN
1250 D = DEC(H$): D$ = STR$(D): H = D: RETURN
1260 RETURN
1270 REM *** CONVERT MULTIPLE DECIMAL INTEGERS ***
1280 DB$=""
1290 PRINT: INPUT "ENTER STARTING DECIMAL INTEGER (UP TO 65535): ", DB$
1300 D$=DB$: GOSUB 1030: D$="": REM VALIDATE DECIMAL INPUT
1310 IF (V = 0) THEN GOTO 1290
1320 DE$=""
1330 PRINT: INPUT "ENTER ENDING DECIMAL INTEGER (UP TO 65535): ", DE$
1340 D$=DE$: GOSUB 1030: D$="": REM VALIDATE DECIMAL INPUT
1350 IF (V = 0) THEN GOTO 1330
1360 DB=VAL(DB$): DE=VAL(DE$)
1370 IF (DE < DB) THEN A$ = E$: GOSUB 1010: GOTO 1280
1380 SC = 1: SM = INT(((DE - DB) / 36) + 1)
1390 D = DB
1400 FOR J = SC TO SM
1410 : PRINT CHR$(147) + "RANGE: " + DB$ + " TO " + DE$ + "{SPACE*10}SCREEN: "
+ STR$(J) + " OF " + STR$(SM)
1420 : PRINT: PRINT "DEC";SPC(4);"BIN";SPC(19);"HEX";SPC(8);"DEC";SPC(4);
"BIN";SPC(19);"HEX"
1430 L = 5: GOSUB 1930: L1$ = L$
1440 L = 20: GOSUB 1930: L2$ = L$
1450 : PRINT SPC(1);L1$;SPC(2);L2$;SPC(2);L1$;SPC(6);L1$;SPC(2);
L2$;SPC(2);L1$
1460 : FOR K = 0 TO 17
1470 : FOREGROUND (7 + MOD(K,2))
1480 : D$ = STR$(D): GOSUB 590: D = D + 1
1490 : IF (D > DE) THEN GOTO 1630
1500 : NEXT K
1510 : PRINT CHR$(19): PRINT: PRINT: PRINT
1520 : FOR K = 0 TO 17
1530 : FOREGROUND (7 + MOD(K,2))
1540 : D$ = STR$(D): PRINT TAB(40): GOSUB 590: D = D + 1

```

```

1550 :     IF (D > DE) THEN GOTO 1630
1560 : NEXT K
1570 : FOREGROUND 1: PRINT: PRINT SPC(19);"PRESS X TO EXIT OR SPACEBAR TO CONTINUE..."
1580 : GET B$
1590 : IF B$="X" THEN RETURN
1600 : IF B$=" " THEN GOTO 1620
1610 : GOTO 1580
1620 NEXT J
1630 PRINT CHR$(19): FOR I = 1 TO 22: PRINT: NEXT I
1640 PRINT SPC(20); "COMPLETE. PRESS SPACEBAR TO CONTINUE..."
1650 GET B$: IF B$("<") " THEN GOTO 1650: ELSE RETURN
1660 REM *** CONVERT MULTIPLE BINARY INTEGERS ***
1670 IB$=""
1680 PRINT: INPUT "ENTER STARTING BINARY INTEGER (UP TO 16 BITS): ", IB$
1690 I$=IB$: GOSUB 1110: I$="": REM VALIDATE BINARY INPUT
1700 IF (V = 0) THEN GOTO 1680
1710 IB = I
1720 IE$=""
1730 PRINT: INPUT "ENTER ENDING BINARY INTEGER (UP TO 16 BITS): ", IE$
1740 I$=IE$: GOSUB 1110: I$="": REM VALIDATE BINARY INPUT
1750 IF (V = 0) THEN GOTO 1730
1760 IE = I
1770 IF (IE < IB) THEN A$ = E$: GOSUB 1010: GOTO 1670
1780 DB = IB: DE = IE: DB$ = STR$(IB): DE$ = STR$(IE): GOTO 1300
1790 REM *** CONVERT MULTIPLE HEXADECIMAL INTEGERS ***
1800 HB$=""
1810 PRINT: INPUT "ENTER STARTING HEXADECIMAL INTEGER (UP TO 4 DIGITS): ", HB$
1820 H$=HB$: GOSUB 1220: H$="": REM VALIDATE HEXADECIMAL INPUT
1830 IF (V = 0) THEN GOTO 1810
1840 HB = H
1850 HE$=""
1860 PRINT: INPUT "ENTER ENDING HEXADECIMAL INTEGER (UP TO 4 DIGITS): ", HE$
1870 H$=HE$: GOSUB 1220: H$="": REM VALIDATE HEXADECIMAL INPUT
1880 IF (V = 0) THEN GOTO 1860
1890 HE = H
1900 IF (HE < HB) THEN A$ = E$: GOSUB 1010: GOTO 1800
1910 DB = HB: DE = HE: DB$ = STR$(HB): DE$ = STR$(HE): GOTO 1300
1920 REM *** MAKE LINES ***
1930 L$=""
1940 FOR K = 1 TO L: L$ = L$ + "-": NEXT K
1950 RETURN

```

APPENDIX

F

System Memory Map

- **Introduction**
- **MEGA65 Native Memory Map**
- **\$D000 – \$DFFF I/O Personalities**
- **CPU Memory Banking**
- **C64/C65 ROM Emulation**

INTRODUCTION

The MEGA65 computer has a large 28-bit address space, which allows it to address up to 256MB of memory and memory-mapped devices. This memory map has several different views, depending on which mode the computer is operating in. Broadly, there are five main modes: (1) Hypervisor mode; (2) C64 compatibility mode; (3) C65 compatibility mode; (4) UltiMAX compatibility mode; and (5) MEGA65-mode, or one of the other modes, where the programmer has made use of MEGA65 enhanced features.

It is important to understand that, unlike the C128, the C65 and MEGA65 allow access to all enhanced features from C64-mode, if the programmer wishes to do so. This means that while we frequently talk about “C64-mode,” “C65-mode” and “MEGA65-mode,” these are simply terms of convenience for the MEGA65 with its memory map (and sometimes other features) configured to provide an environment that matches the appropriate mode. The heart of this is the MEGA65’s flexible memory map.

In this appendix, we will begin by describing the MEGA65’s native memory map, that is, where all of the memory, I/O devices and other features appear in the 28-bit address space. We will then explain how C64 and C65 compatible memory maps are accessed from this 28-bit address space.

MEGA65 NATIVE MEMORY MAP

The First Sixteen 64KB Banks

The MEGA65 uses a similar memory map to that of the C65 for the first MB of memory, i.e., 16 memory banks of 64KB each. This is because the C65's 45 10 CPU can access only 1MB of address space. These banks can be accessed from BASIC 65 using the **BANK**, **DMA**, **PEEK** and **POKE** commands. The following table summarises the contents of the first 16 banks:

HEX	DEC	Address	Contents
0	0	\$0xxxx	First 64KB RAM. This is the RAM visible in C64-mode.
1	1	\$1xxxx	Second 64KB RAM. This is the 2nd 64KB of RAM present on a C65.
2	2	\$2xxxx	First half of C65 ROM (C64-mode and shared components) or RAM
3	3	\$3xxxx	Second half of C65 ROM (C65-mode components) or RAM
4	4	\$4xxxx	Additional RAM (384KB or larger chip-RAM models)
5	5	\$5xxxx	Additional RAM (384KB or larger chip-RAM models)
6	6	\$6xxxx	Additional RAM (512KB or larger chip-RAM models)
7	7	\$7xxxx	Additional RAM (512KB or larger chip-RAM models)
8	8	\$8xxxx	Additional RAM (1MB or larger chip-RAM models)
9	9	\$9xxxx	Additional RAM (1MB or larger chip-RAM models)
A	10	\$Axxxx	Additional RAM (1MB or larger chip-RAM models)
B	11	\$Bxxxx	Additional RAM (1MB or larger chip-RAM models)
C	12	\$Cxxxx	Additional RAM (1MB or larger chip-RAM models)
D	13	\$Dxxxx	Additional RAM (1MB or larger chip-RAM models)

continued ...

...continued

HEX	DEC	Address	Contents
E	14	\$Exxxx	Additional RAM (1MB or larger chip-RAM models)
F	15	\$Fxxxx	Additional RAM (1MB or larger chip-RAM models)

The key features of this address space are the 128KB of RAM in the first two banks, which is also present on the C65. If you intend to write programs which can also run on a C65, you should only use these two banks of RAM.

On all models it is possible to use all or part of the 128KB of "ROM" space as RAM. To do this, you must first request that the Hypervisor removes the read-only protection on this area, before you will be able to change its contents. If you are writing a program which will start from C64-mode, or otherwise switch to using the C64 part of the ROM, instead of the C65 part), then the second half of that space, i.e., BANK 3, can be safely used for your programs. This gives a total of 192KB of RAM, which is available on all models of the MEGA65.

On models that have 384KB or more of chip RAM, BANK 4 and 5 are also available. Similarly, models which provide 1MB or more of chip RAM will have BANK 6 through 15 also available, giving a total of 896KB (or 960KB, if only the C64 part of the ROM is required) of RAM available for your programs. Note that the MEGA65's built-in freeze cartridge currently freezes only the first 384KB of RAM.

Colour RAM

The MEGA65's VIC-IV video controller supports much larger screens than the VIC-II or VIC-III. For this reason, it has access to a separate colour RAM, similar to on the C64. For compatibility with the C65, the first two kilo-bytes of this are accessible at \$1F800 - \$1FFFF. The full 32KB or 64KB of colour RAM is located at \$FF80000. This is most easily access through the use of advanced DMA operations, or the 32-bit base-page indirect addressing mode of the processor.

At the time of writing, the **BANK** and **DMA** commands cannot be used to access the rest of the colour RAM, because the colour RAM is not located in the first mega-byte of address space. This may be corrected in a future revision of the MEGA65, allowing access to the full colour RAM via BANK 15 or an equivalent DMA job.

28-bit Address Space

In addition to the C65-style 1MB address space, the MEGA65 extends this to 256MB, by using 28-bit addresses. The following shows the high-level layout of this address space.

HEX	DEC	Size	Contents
0000000	0	1	CPU I/O Port Data Direction Register
0000001	1	1	CPU I/O Port Data
0000002 - 005FFFF	2 - 384KB	384KB	Fast chip RAM (40MHz)
0060000 - 0FFFFFF	384KB - 16MB	15.6MB	Reserved for future chip RAM expansion
1000000 - 3FFFFFF	16MB - 64MB	48MB	Reserved
4000000 - 7FFFFFF	64MB - 128MB	64MB	Cartridge port and other devices on the slow bus (1 - 10 MHz)
8000000 - 87FFFFF	128MB - 135MB	8MB	8MB ATTIC RAM (selected models only)
8800000 - 8FFFFFF	135MB - 144MB	8MB	8MB CELLAR RAM (selected models only)
9000000 - EFFFFFF	144MB - 240MB	96MB	Reserved for future expansion RAM
F000000 - FF7DFFF	240MB - 255.49MB	15.49MB	Reserved for future I/O expansion
FF7E000 - FF7EFFF	255.49MB - 255.49MB	4KB	VIC-IV Character ROM (write only)
FF80000 - FF87FFF	255.5MB - 255.53MB	32KB	VIC-IV Colour RAM (32KB colour RAM models)
FF88000 - FF8FFFF	255.53MB - 255.57MB	32KB	Additional VIC-IV Colour RAM (64KB colour RAM models only)
FF90000 - FFCAFFF	255.53MB - 255.80MB	216KB	Reserved
FFCB000 - FFCBFFF	255.80MB - 255.80MB	4KB	Emulated C1541 RAM
FFCC000 - FFCFFFF	255.80MB - 255.81MB	16KB	Emulated C1541 ROM
FFD0000 - FFD0FFF	255.81MB - 255.81MB	4KB	C64 \$Dxxx I/O Personality

continued ...

...continued

HEX	DEC	Size	Contents
FFD1000 - FFD1FFF	255.81MB - 255.82MB	4KB	C65 \$Dxxx I/O Personality
FFD2000 - FFD2FFF	255.82MB - 255.82MB	4KB	MEGA65 \$Dxxx Ethernet I/O Personality
FFD3000 - FFD3FFF	255.82MB - 255.82MB	4KB	MEGA65 \$Dxxx Normal I/O Personality
FFD4000 - FFD5FFF	255.82MB - 255.83MB	8KB	Reserved
FFD6000 - FFD67FF	255.83MB - 255.83MB	2KB	Hypervisor scratch space
FFD6000 - FFD6BFF	255.83MB - 255.83MB	3KB	Hypervisor scratch space
FFD6C00 - FFD6DFF	255.83MB - 255.83MB	512	F011 floppy controller sector buffer
FFD6E00 - FFD6FFF	255.83MB - 255.83MB	512	SD Card controller sector buffer
FFD7000 - FFD70FF	255.83MB - 255.83MB	256	MEGAphone r1 I2C peripherals
FFD7100 - FFD71FF	255.83MB - 255.83MB	256	MEGA65 r2 I2C peripherals
FFD7200 - FFD72FF	255.83MB - 255.83MB	256	MEGA65 HDMI I2C registers (only for models fitted with the ADV7511 HDMI driver chip)
FFD7300 - FFD7FFF	255.83MB - 255.84MB	3.25KB	Reserved for future I2C peripherals
FFD8000 - FFDBFFF	255.83MB - 255.86MB	16KB	Hypervisor ROM (only visible in Hypervisor Mode)
FFDC000 - FFDDFFF	255.86MB - 255.87MB	8KB	Reserved for Hypervisor Mode ROM expansion
FFDE000 - FFDE7FF	255.87MB - 255.87MB	2KB	Reserved for Ethernet buffer expansion
FFDE800 - FFDEFFF	255.87MB - 255.87MB	2KB	Ethernet frame read buffer (read only) and Ethernet frame write buffer (write only)
FFDF000 - FFDFFFF	255.87MB - 255.87MB	4KB	Virtual FPGA registers (selected models only)
FFE0000 - FFFFFFF	255.87MB - 256MB	128KB	Reserved

\$D000 – \$DFFF I/O PERSONALITIES

The MEGA65 supports four different I/O personalities. These are selected by writing the appropriate values to the \$D02F KEY register, which is visible in all four I/O personalities. There is more information in Chapter/Appendix 10 on page 10-3 about the use of the KEY register.

The following table shows which I/O devices are visible in each of these I/O modes, as well as the KEY register values that are used to select the I/O personality.

HEX	C64	C65	MEGA65 ETHERNET	MEGA65
KEY	\$00	\$A5, \$96	\$45, \$54	\$47, \$53
\$D000 - \$D02F	VIC-II	VIC-II	VIC-II	VIC-II
\$D030 - \$D07F	VIC-II ¹	VIC-III	VIC-III	VIC-III
\$D080 - \$D08F	VIC-II	F011	F011	F011
\$D090 - \$D09F	VIC-II	-	SD card	SD card
\$D0A0 - \$D0FF	VIC-II	RAM EXPAND CONTROL	-	-
\$D100 - \$D1FF	VIC-II	RED Palette	RED Palette	RED Palette
\$D200 - \$D2FF	VIC-II	GREEN Palette	GREEN Palette	GREEN Palette
\$D300 - \$D3FF	VIC-II	BLUE Palette	BLUE Palette	BLUE Palette
\$D400 - \$D41F	SID Right #1	SID Right #1	SID Right #1	SID Right #1
\$D420 - \$D43F	SID Right #2	SID Right #2	SID Right #2	SID Right #2
\$D440 - \$D45F	SID Left #1	SID Left #1	SID Left #1	SID Left #1
\$D460 - \$D47F	SID Left #2	SID Left #2	SID Left #2	SID Left #2
\$D480 - \$D49F	SID Right #1	SID Right #1	SID Right #1	SID Right #1
\$D4A0 - \$D4BF	SID Right #2	SID Right #2	SID Right #2	SID Right #2
\$D4C0 - \$D4DF	SID Left #1	SID Left #1	SID Left #1	SID Left #1
\$D4E0 - \$D4FF	SID Left #2	SID Left #2	SID Left #2	SID Left #2
\$D500 - \$D5FF	SID images	-	Reserved	Reserved
\$D600 - \$D63F	-	UART	UART	UART
\$D640 - \$D67F	-	UART images	HyperTrap Registers	HyperTrap Registers
\$D680 - \$D6FF	-	-	MEGA65 Devices	MEGA65 Devices
\$D700 - \$D7FF	-	-	MEGA65 Devices	MEGA65 Devices
\$D800 - \$DBFF	COLOUR RAM	COLOUR RAM	ETHERNET Buffer	COLOUR RAM
\$DC00 - \$DDFF	CIA's	CIA's / COLOUR RAM	ETHERNET Buffer	CIA's / COLOUR RAM
\$DE00 - \$DFFF	CART I/O	CART I/O	ETHERNET Buffer	CART I/O / SD SECTOR

¹ In the C64 I/O personality, \$D030 behaves as on C128, allowing toggling between 1MHz and 2MHz CPU speed.

² The additional MEGA65 SIDs are visible in all I/O personalities.

³ Some models may replace the repeated images of the first four SIDs with four additional SIDs, for a total of 8 SIDs.

CPU MEMORY BANKING

The 45GS10 processor, like the 6502, can only “see” 64KB of memory at a time. Access to additional memory is via a selection of bank-switching mechanisms. For backward-compatibility with the C64 and C65, the memory banking mechanisms for both of these computers existing the MEGA65:

1. C65-style MAP instruction banking
2. C65-style \$D030 banking
3. C64-style cartridge banking
4. C64-style \$00 / \$01 banking

It is important to understand that these different banking modes have a priority order: If a higher priority form of banking is being used, it takes priority over a lower priority form. The C65 banking methods take priority of the C64-mode banking methods. So, for example, if the 45GS10 MAP instruction has been used to provide a particular memory layout, the C64-style \$00 / \$01 banking will not be visible.

This makes the overall banking scheme more complex than on the C64. Thus to understand what the actual memory layout will be, you should start by considering the effects of C64 memory banking, and then if any C65 MAP instruction memory banking is enabled, using that to override the C64-style memory banking. Then if any C65 \$D030 memory banking is used, that overrides both the C64 and C65 MAP instruction memory banking. Finally, if I/O is banked, or if there are any cartridges inserted and active, their effects are made.

The following diagram shows the different types of banking that can apply to the different areas of the 64KB that the CPU can see. The higher layers take priority over the lower layers, as described in the previous paragraph.

I/O/CART		CART ROMLO	CART ROMHI		I/O	CART ROMHI
C65		BASIC	BASIC	INTER-FACE		KERNAL
MAP	MAP LO (4 x 8KB slabs)	MAP HI (4 x 8KB slabs)				
C64			BASIC		CHAR ROM	KERNAL
RAM	RAM*	RAM	RAM	RAM	RAM	RAM
	\$0000 - \$7FFF	\$8000 - \$9FFF	\$A000 - \$BFFF	\$C000 - \$CFFF	\$D000 - \$DFFF	\$E000 - \$FFFF

(There are actually a few further complications. For example, if the cartridge selects the UltiMAX™ game mode, then only the first 4KB of RAM will be visible, and the remaining address space will be un-mapped, and able to be supplied by the cartridge.)

For example, using \$D030 to bank in C65 ROM at \$A000, this will take priority over the C64 BASIC 2 ROM at the same address.

C64/C65 ROM EMULATION

The C64 and C65 use ROM memories to hold the KERNAL and BASIC system. The MEGA65 is different: It uses 128KB of its 384KB fast chip RAM at \$20000 - \$3FFFF (banks 2 and 3) to hold these system programs. This makes it possible to change or upgrade the “ROM” that the MEGA65 is running, without having to open the computer. It is even possible to use the MEGA65’s Freeze Menu to change the “ROM” being used while a program is running.

The C64 and C65 memory banking methods use this 128KB of area when making ROM banks visible. When the RAM banks are mapped, they are always read-only. However, if the MAP instruction or DMA is used to access that address area, it is possible to write to it. For improved backward compatibility, the whole 128KB region of memory is normally set to read-only.

A program can, however, request read-write access to this 128KB area of memory, so that it can make full use of the MEGA65’s 384KB of chip RAM. This is accomplished by triggering the *Toggle Rom Write-protect* system trap of the hypervisor. The following code-fragment demonstrates how to do this. Calling it a second time will re-activate the write-protection.

```
LDA #$70
STA $D640
NOP
```

This fragment works by calling sub-function \$70 (toggle ROM write-protect) of Hypervisor trap \$00. Note that the `NOP` is mandatory. The MEGA65 I/O personality must be first selected, so that the \$D640 register is un-hidden.

The current write-protection state can be tested by attempting to write to this area of memory. Also, you can examine and toggle the current state from in the MEGA65 Freeze Menu.

NOTE: If you are starting your program from C65-mode, you must first make sure that the I/O area is visible at \$D000-\$DFFF. The simplest way to do this is to use the MAP instruction with all zero values in the registers. The following fragment demonstrates

this, and also makes sure that the MEGA65 I/O context is active, so that the hypervisor trap will be able to trigger:

```
; Clear C65 memory map
LDA #$00
TAX
TAY
TAZ
MAP
; Bank I/O in via C64 mechanism
LDA #$35
STA $01
; Do MEGA65 / VIC-IV I/O knock
LDA #$47
STA $D02F
LDA #$53
STA $D02F
; End MAP sequence, thus allowing interrupts to occur again
EOM
; Do Hypervisor call to un-write-protect the ROM area
LDA #$70
STA $D640
NOP
```

C65 Compatibility ROM Layout

The layout of the C65 compatibility 128KB ROM area is identical to that of the C65:

HEX	Contents
\$3E000 -- \$3FFFF	C65 KERNAL
\$3C000 -- \$3DFFF	RESERVED
\$38000 -- \$3BFFF	C65 BASIC GRAPHICS ROUTINES
\$32000 -- \$37FFF	C65 BASIC
\$30000 -- \$31FFF	MONITOR (gets mapped at \$6000 -- \$7FFF)
\$2E000 -- \$2FFFF	C64 KERNAL
\$2D000 -- \$2DFFF	C64 CHARSET
\$2C000 -- \$2CFFF	INTERFACE
\$24000 -- \$27FFF	RESERVED
\$20000 -- \$23FFF	DOS (gets mapped at \$8000 -- \$BFFF)

The INTERFACE program is a series of routines that are used by the C65 to switch between C64-mode, C65-mode and the C65's built-in DOS. The DOS is located in the lower-eighth of the ROM.

APPENDIX



45GS02 Microprocessor

- **Introduction**
- **Differences to the 6502**
- **C64 CPU Memory Mapped Registers**
- **New CPU Memory Mapped Registers**
- **MEGA65 CPU Maths Acceleration Registers**
- **MEGA65 Hypervisor Mode**

INTRODUCTION

The 45GS02 is an enhanced version of the processor portion of the CSG4510 and of the F018 "DMAgic" DMA controller used in the Commodore 65 computer prototypes. The 4510 is, in turn, an enhanced version of the 65CE02. The reader is referred to the considerable documentation available for the 6502 and 65CE02 processors for the backwards-compatible operation of the 45GS02.

This chapter will focus on the differences between the 45GS02 and the earlier 6502-class processors, and the documentation of the many built-in memory-mapped I/O registers of the 45GS02.

DIFFERENCES TO THE 6502

The 45GS02 has a number of key differences to earlier 6502-class processors:

Supervisor/Hypervisor Privileged Mode

Unlike the earlier 6502 variants, the 45GS02 has a privileged mode of operation. This mode is intended for use by an operating system or type-1 hypervisor. The ambiguity between operating system and Hypervisor on the MEGA65 stems from the fact that the operating system of the MEGA65 is effectively little more than a loader and task-switcher for C64 and C65 environments, i.e., effectively operating as a hypervisor, but provides only limited virtualisation of the hardware.

The key differences between normal and supervisor mode on the MEGA65, are that in supervisor mode:

- A special 16KB memory area is mapped to \$8000 - \$BFFF, which is used to contain both the program and data of the Hypervisor / supervisor program. This is normally the Hyppo program. This memory is not mappable by any means when the processor is in the normal mode (the chip-select line to it is inhibited), protecting it from accidental or malicious access.
- The 64 SYSCALL trap registers in the MEGA65 I/O-mode at \$D640 - \$D67F are replaced by the virtualisation control registers. These registers allow complete control over the system, and it is their access that truly defines the privilege of the supervisor mode.

- The processor always operates at full speed (40MHz) and in the 4510 processor personality.

The Hypervisor Mode is described in more detail later in this appendix.

6502 Illegal Opcodes

The 65C02, 65CE02 and CSG4510 processors extended the original 6502 processor by using previously unallocated opcodes of the 6502 to provide additional instructions. All software that followed the official documentation of the 6502 processor will therefore work on these newer processors, possibly with different instruction timing. However, the common practice on the C64 and other home computers of using undefined opcodes (often called “illegal opcodes”, although there is no law against using them), means that many existing programs will not work on these newer processors.

To alleviate this problem the 45GS02 has the ability to switch processor personalities between the 4510 and 6502. The effect is that in 6502 mode, none of the new opcodes of the 65C02, 65CE02, 4510 or 45GS02 are available, and are replaced with the original, often strange, behaviour of the undefined opcodes of the 6502.

WARNING: This feature is incomplete and untested. Most undocumented 6502 opcodes do not operate correctly when the 6502 personality is enabled.

Read-Modify-Write Instruction Bug Compatibility

The 65CE02 processor optimised a group of instructions called the Read-Modify-Write (RMW) instructions. For such instructions, such as INC, that increments the contents of a memory location, the 6502 would read the original value and then write it back unchanged, before writing it back with the new increased value. For most purposes, this did not cause any problems. However, it turned out to be a fast way to acknowledge VIC-II interrupts, because writing the original value back (which the instruction doesn't need to do) acknowledges the interrupt. This method is faster and uses fewer bytes than any alternative, and so became widely used in C64 software.

The problem came with the C65 with its 65CE02 derived CSG4510 that didn't do this extra write during the RMW instructions. This made the RMW instructions one cycle faster, which made software run slightly faster. Unfortunately, it also meant that a lot of existing C64 software simply won't run on a C65, unless the interrupt acknowledgement code in each program is patched to work around this problem. This is the

single most common reason why many C64 games and other software titles won't run on a C65.

Because this problem is so common, the MEGA65's 45GS02 includes bug compatibility with this commonly used feature of the original 6502. It does this by checking if the target of an RMW instruction is \$D019, i.e., the interrupt status register of the VIC-II. If it is, then the 45GS02 performs the dummy write, allowing many C64 software titles to run unmodified on the MEGA65, that do not run on a C65 prototype. By only performing the dummy write if the address is \$D019, the MEGA65 maintains C64 compatibility, without sacrificing the speed improvement for all other uses of these instructions.

Variable CPU Speed

The 45GS02 is able to run at 1MHz, 2MHz, 3.5MHz and 40MHz, to support running software designed for the C64, C128 in C64-mode, C65 and MEGA65.

Slow (1MHz - 3.5MHz) Operation

In these modes, the 45GS02 processor slows down, so that the same number of instructions per video frame are executed as on a PAL or NTSC C64, C128 in C64-mode or C65 prototype. This is to allow existing software to run on the MEGA65 at the correct speed, and with minimal display problems. The VIC-IV video controller provides cycle indication pulses to the 45GS02 that are used to keep time.

In these modes, opcodes take the same number of cycles as an 6502. However memory accesses within an instruction are not guaranteed to occur in the same cycle as on a 1MHz 6502. Normally the effect is that instructions complete faster, and the processor idles until the correct number of cycles have passed. This means that timing may be incorrect by up to 7 micro-seconds. This is not normally a problem, and even many C64 fast loaders will function correctly. For example, the GEOS™ Graphical Operating System for the C64 can be booted and used from a 1541 connected to the MEGA65's serial port.

However, some advanced VIC-II graphics tricks, such as Variable Screen Position (VSP) are highly unlikely to work correctly, due to the uncertainty in timing of the memory write cycles of instructions. However, in most cases such problems can be easily solved by using the advanced features of the MEGA65's VIC-IV video controller. For example, VSP is unnecessary on the MEGA65, because you can set the screen RAM address to any location in memory.

Full Speed (40MHz) Instruction Timing

When the MEGA65's processor is operating at full speed (currently 40MHz), the instruction timing no longer exactly mirrors the 6502: Instructions that can be executed in fewer cycles will do so. For example, branches are typically require fewer instructions on the 45GS02. There are also some instructions that require more cycles on the 45GS02, in particular the LDA, LDX, LDY and LDZ instructions. Those instructions typically require one additional cycle. However as the processor is running at 40MHz, these instructions still execute much more quickly than on even a C65 or C64 with an accelerator.

CPU Speed Fine-Tuning

It is also possible to more smoothly vary the CPU speed using the **SPEEDBIAS** register located at \$D7FA (55290), when MEGA65 I/O mode is enabled. The default value is \$80 (128), which means no bias on the CPU speed. Higher values increase the CPU speed, with \$FF meaning 2× the expected speed. Lower values slow the processor down, with \$00 bring the CPU to a complete stand-still. Thus the speed can be varied between 0× and 2× the intended value.

This register is provided to allow tweaking the processor speed in games.

Note that this register has no effect when the processor is running at full-speed, because it only affects the way in which VIC-IV video cycle indication pulses are processed by the CPU.

Direct Memory Access (DMA)

Direct Memory Access (DMA) is a method for quickly filling, copying or swapping memory regions. The MEGA65 implements an improved version of the F018 "DMAgic" DMA controller of the C65 prototypes. Unlike on the C65 prototypes, the DMA controller is part of the CPU on the MEGA65.

Detailed information on how to use the DMA controller and these advanced features can be found in Chapter/Appendix L on page L-3

Accessing memory between the 64KB and 1MB points

The C65 included four ways to access memory beyond the 64KB point: three methods that are limited, specialised or both, and two general-purpose methods. We will first consider the limited methods, before documenting the general-purpose methods.

C64-Style Memory Banking

The first method, is to use the C64-style \$00/\$01 ROM/RAM banking. This method is very limited, however, as it allows only the banking in and out of the two 8KB regions that correspond to the C64 BASIC and KERNAL ROMs. These are located at \$2A000 and \$2E000 in the 20-bit C65 address space, i.e., \$002A000 and \$002E000 in the 28-bit address space of the MEGA65. It can also provide access to the C64 character ROM data at \$D000, which is located at \$2D000 in the C65 memory map, and thus \$002D0000 in the MEGA65 address space. In addition to being limited to which regions this method can access, it also only provides read-only access to these memory regions, i.e., it cannot be used to modify these memory regions.

VIC-III "ROM" Banking

Similar to the C64-style memory banking, the C65 included the facility to bank several other regions of the C65's 128KB ROM. These are banked in and out using various bits of the VIC-III's \$D030 register:

\$D030 Bit	Signal Name	20-bit Address	16-bit Address	Read-Write Access?
0	CRAM2K	\$1F800 - \$1FFFF, \$FF80000 - \$FF807FF	\$D800 - \$DBFF	Y
3	ROM8	\$38000 - \$39FFF	\$8000 - \$9FFF	N
4	ROMA	\$3A000 - \$3BFFF	\$A000 - \$BFFF	N
5	ROMC	\$2C000 - \$2CFFF	\$C000 - \$CFFF	N
6	CROM9	\$29000 - \$29FFF	\$D000 - \$DBFF	N
7	ROME	\$3E000 - \$3FFFF	\$E000 - \$FFFF	N

The CRAM2K signal causes the normal 1KB of colour RAM, which is located at \$1F800 - \$1FBFF and is visible at \$D800 - \$DBFF, to instead be visible from \$D800 - \$DBFF. That is, the entire range \$1F800 - \$1FFFF is visible, and can be both read from and written to. Unlike on the C64, the colour RAM on the MEGA65 is always visible as 8-bit bytes. Also, on the MEGA65, the colour RAM is 32KB in size, and exists at \$FF80000 - \$FF87FFF. The visibility of the colour RAM at \$1F800 - \$1FFFF is achieved by mirroring writes to both regions when accessing the colour RAM via this mechanism.

Note that these VIC-III memory banking signals take precedence over the C64-style memory banking.

VIC-III Display Address Translator

The third specialised manner to access to memory above the 64KB point is to use the VIC-III's Display Address Translator. Use of this mechanism is documented in Chapter/Appendix M on page M-5.

The MAP instruction

The first general-purpose means of access to memory is the MAP instruction of the 4510 processor. The MEGA65's 45GS02 processor also supports this mechanism. This instruction divides the 64KB address of the 6502 into eight blocks of 8KB each. For each of these blocks, the block may either be accessed normally, i.e., accessing an 8KB region of the first 64KB of RAM of the system. Alternatively, each block may instead be re-mapped (hence the name of the MAP instruction) to somewhere else in the address space, by adding an offset to the address. Mapped addresses in the first 32KB use one offset, the lower offset, and the second 32KB uses another, the upper offset. Re-mapping of memory using the MAP instruction takes precedence over the C64-style memory banking, but not the C65's ROM banking mechanism.

The offsets must be a multiple of 256 bytes, and thus consist of 12 bits in order to allow an arbitrary offset in the 1MB address space of the C65. As each 8KB block in a 32KB half of memory can be either mapped or not, this requires one bit per 8KB block. Thus the processor requires 16 bits of information for each half of memory, for a total of 32 bits of information. This is achieved by setting the A and X registers for the lower half of memory and the Y and Z registers for the upper half of memory, before executing the MAP instruction.

The MAP instruction copies the contents of these registers into the processors internal registers that hold the mapping information. Note that there is no way to use the MAP instruction to determine the current memory mapping configuration, which somewhat limits its effectiveness.

The following diagram illustrates how the MAP instruction takes the values of the four A, X, Y and Z registers, and uses them to compute the upper and lower address offsets, and sets the bank enable bits for each of the eight 8KB memory regions of the 6502 address space:

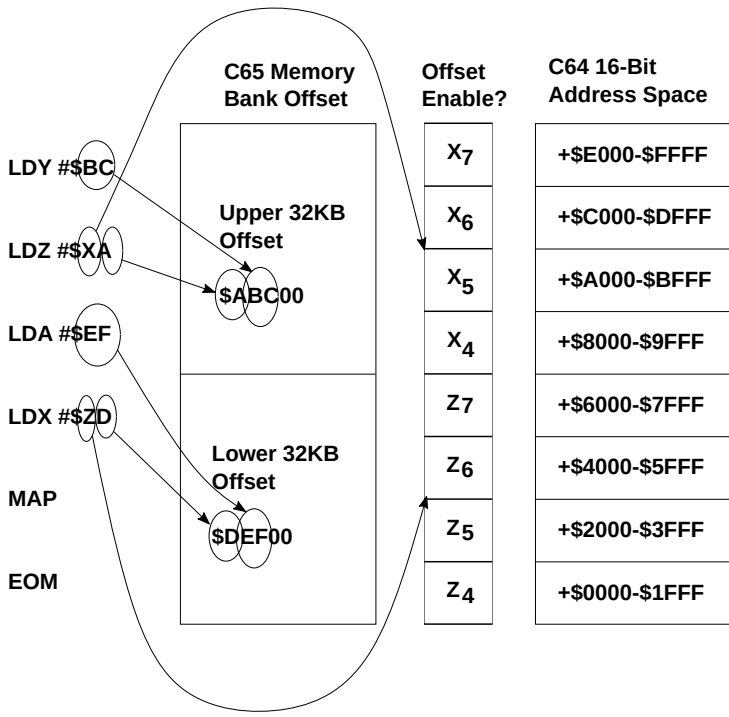

That is, the contents of the A register and the lower-nibble of the X register form a 12-bit value that is multiplied by 256 to produce the offset used for any of the 8KB banks in the lower 32KB half of the 6502's 16-bit address space. The upper nibble of the X register is used as flags to indicate which of the four 8KB blocks in that 32KB half of the 6502 address space should have the offset added to their addresses to compute the actual address.

The Y and Z registers are used in a similar way to produce the offset for the upper 32KB half of the 6502 address space, and the flags to indicate whether the offset is used for each of the four 8KB blocks in that half of the address space.

Note that the lower 8 bits of the offset cannot be set. That is, the offset will be a multiple of 256 bytes, unlike on some extended 6502 processors. However, in practice this restriction is rarely limiting.

To understand how this works in practice, the following example shows how this works with a concrete example, showing the address ranges that would be visible in each of the 8KB slices of the 6502's 64KB address space:

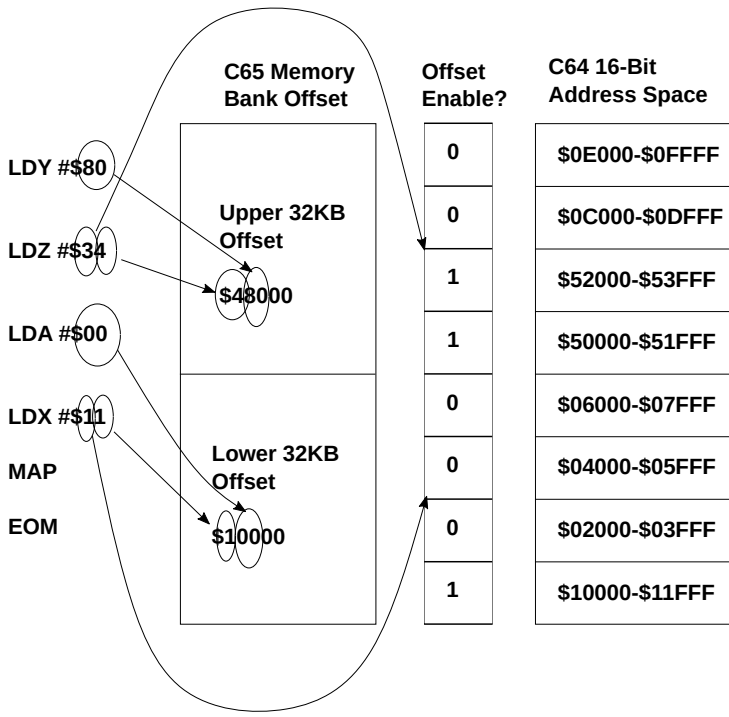

Notice that the offsets for each of the two 32KB address ranges get added to the 6502 address. This is why the offset of \$48000 for the upper 32KB generates an address of \$50000 at the 6502 address \$8000.

See also under "Using the MAP instruction to access >1MB" for further explanation.

Direct Memory Access (DMA) Controller

The C65's F018/F018A DMA controller allows for rapid filling, copying and swapping of the contents of memory anywhere in the 1MB address space. Detailed information about the F018 DMA controller, and the MEGA65's enhancements to this, refer to Chapter/Appendix L on page L-3

Flat Memory Access

Accessing memory beyond the 1MB point

The MEGA65 can support up to 256MB of memory. This is more than the 1MB address space of the CSG4510 on which it is based. There are several ways of performing this.

Using the MAP instruction to access >1MB

The full address space is available to the MAP instruction for legacy C65-style memory mapping, although some care is required, as the MAP instruction must be called up to three times. The reason for this is that the MAP instruction must be called to first select which mega-byte of memory will be used for the lower and upper map regions, before it is again called in the normal way to set the memory mapping. Because between these two calls the memory mapping offset will be a mix of the old and new addresses, all mapping should be first disabled via the MAP instruction. This means that the code to re-map memory should live in the bottom 64KB of RAM or in one of the ROM-bankable regions, so that it can remain visible during the mapping process.

Failure to handle this situation properly will result in the processor executing instructions from somewhere unexpected half-way through the process, because the routine it is executing to perform the mapping will suddenly no longer be mapped.

Because of the relative complexity of this process, and the other problems with the MAP instruction as a means of memory access, we recommend that for accessing data outside of the current memory map that you use either DMA or the flat-memory address features of the 45GS02 that are described below. Indeed, access to the full address space via the MAP instruction is only provided for completeness.

As an other example of how the MAP instruction can be used to map an area of memory from the expanded address space, the following program maps the Ethernet frame buffer from its natural location at \$FFDE8000 to appear at \$6800. To keep the example as simple as possible, we assume that the code is running from in the bottom 64KB of RAM, and not in the region between \$6000 - \$8000.

As the MAP instruction normally is only aware of the C65-style 20-bit addresses, the MEGA65 extension to the instruction must be used to set the upper 8 bits of the 28-bit MEGA65 addresses, i.e., which mega-byte of address space should be used for the address translation. This is done by setting the X register to \$0F when setting the mega-byte number for the lower-32KB of the C64-style 64KB address space. This does not create any incompatibility with any sensible use of the MAP instruction on a C65, because this value indicates that none of the four 8KB memory blocks will be re-mapped, but at the same time specifies that the upper 4 bits of the address offset for

re-mapped block is the non-zero value of \$F. The mega-byte number is then specified by setting the A register.

The same approach applies to the upper 32KB, but using the Z and Y registers instead of the X and A registers. However, in this case, we do not need to re-map the upper 32KB of memory in this example, we will leave the Z and Y registers set to zero. We must however set X and A to set the mega-byte number for the lower-32KB to \$FF. Therefore A must have the value \$FF. To set the lower 20-bits of the address offset we use the MAP instruction a second time, this time using it in the normal C65 manner. As we want to remap \$6800 to \$FFDE800, and have already dealt with the \$FFxxxx offset via the mega-byte number, we need only to apply the offset to make \$6800 point to \$DE800. \$DE800 minus \$6800 = \$D8000. As the MAP instruction operates with a mapping granularity of 256 bytes = \$100, we can drop the last two digits from \$D8000 to obtain the MAP offset of \$D80. The lower 8-bits, \$80, must be loaded into the A register. The upper 4-bits, \$D, must be loaded into the low-nibble of the X register. As we wish to apply the mapping to only the fourth of the 8KB blocks that make up the lower 32KB half of the C64 memory map, we must set the 4th bit of the upper nibble. That is, the upper nibble must be set to %1000, i.e., \$8. Therefore the X register must be loaded with \$8D. Thus we yield the complete example program:

```
; Map Ethernet registers at $6000 - $7FFF

; Ethernet controller really lives $FFDE000 - $FFDEFFF, so select $FF megabyte section for MAP LO
LDA #$ff
LDX #$0f
LDY #$00
LDZ #$00
Map

; now enable mapping of $DE000-$DFFFF at $6000
; MAPs are offset based, so we need to subtract $6000 from the target address
; $DE000 - $6000 = $D8000
LDA #$80
LDX #$8d
LDY #$00
LDZ #$00
Map
EOM

; Ethernet buffer now visible at $6800 - $6FFF
```

Note that the EOM (End Of Mapping) instruction (which is the same as NOP on a 6502, i.e., opcode \$EA) was only supplied after the last MAP instruction, to make sure that no interrupts could occur while the memory map contained mixed values with the mega-byte number set, but the lower-bits of the mapping address had not been updated.

No example in BASIC for the MAP instruction is possible, because the MAP is a machine code instruction of the 4510 / 45GS02 processors.

Flat-Memory Access

The 45GS02 makes it easy to read or write a byte from anywhere in memory by allowing the Zero-Page Indirect addressing mode to use a 32-bit pointer instead of the normal 16-bit pointer. This is accomplished by using the Z-indexed Zero-Page Indirect Addressing Mode for the access, and having the instruction directly preceded by a NOP instruction (opcode \$EA). For example:

```
NOP
LDA ($45),Z
```

If you are using the ACME assembler, or another assembler that supports the 45GS02 extensions, you can instead use square-brackets to indicate that you are performing a flat-memory operation. Such assemblers will insert the \$EA prefix automatically for you. For example:

```
LDA [$45],Z
```

Regardless which tool you are using, this example would read the four bytes of Zero-Page memory at \$45 - \$48 to form a 32-bit memory address, and add the value of the Z register to this to form the actual address that will be read from. The byte order in the address is the same as the 6502, i.e., the right-most (least significant) byte of the address will be read from the first address (\$45 in this case), and so on, until the left-most (most significant) byte will be read from \$48. For example, to read from memory location \$12345678, the contents of memory beginning at \$45 should be 78 56 43 12.

This method is much more efficient and also simpler than either using the MAP instruction or the DMA controller for single memory accesses, and is what we generally recommend. The DMA controller can be used for moving/filler larger regions of memory. We recommend the MAP instruction only be used for banking code, or in rare situations where extensive access to a small region of memory is required, and the extra cycles of reading the 32-bit addresses is problematic.

Virtual 32-bit Register

The 45GS02 allows the use of its four general purpose registers, A, X, Y and Z as a single virtual 32-bit register. This can greatly simplify and speed up many common operations, and help avoid many common programming errors. For example, adding two 16-bit or 32-bit values can now be easily accomplished with something like:

```
; Clear carry before performing addition, as normal
CLC
; Prefix an instruction with two NEG instructions to select virtual 32-bit register mode
NEG
NEG
LDA $1234 ; Load the contents of $1234-$1237 into A,X,Y and Z respectively
; And again, for the addition
NEG
NEG
ADC $1238 ; Add the contents of $1238-$123B
; The result of the addition is now in A, X, Y and Z.
; And can be written out in whole or part

; To write it all out, again, we need the NEG + NEG prefix
NEG
NEG
STA $123C ; Write the whole out to $123C-$123F

; Or to write out the bottom bytes, we can just write the contents of A and X as normal
STA $1240
STX $1241
```

This approach works with the LDA, STA, ADC, SBC, CMP, EOR, AND, BIT, ORA, ASL, ASR, LSR, ROL, ROR, INC and DEC instructions. If you are using ACME or another 45GS02 aware assembler, you can instead use the new **LDQ, STQ, ADCQ, SBCQ, CPQ, EORQ, ANDQ, BITQ, ORQ, ASLQ, ASRQ, LSRQ, ROLQ, RORQ, INQ** and **DEQ** mnemonics. The previous example would thus become:

```

; Clear carry before performing addition, as normal
CLC
LDQ $1234 ; Load the contents of $1234-$1237 into A,X,Y and Z respectively
; And again, for the addition
ADCQ $1238 ; Add the contents of $1238-$123B
; The result of the addition is now in A, X, Y and Z.
; And can be written out in whole or part

; To write it all out, again, we need the NEG + NEG prefix
STQ $123C ; Write the whole out to $123C-$123F

; Or to write out the bottom bytes, we can just write the contents of A and X as normal
STA $1240
STX $1241

```

The virtual 32-bit addressing mode works with any addressing mode. However, indexed addressing modes, where X, Y or Z are added to the address should be used with care, because these registers may in fact be holding part of a 32-bit value.

The exception is the Zero-Page Indirect Z-Indexed addressing mode: In this case the Z register is NOT added to the target address, unlike would normally be the case. This is to allow the virtual 32-bit register to be able to be used with flat-memory access with the combined prefix of **NEG NEG NOP**, before the instruction to allow accessing a 32-bit value anywhere in memory in a single instruction.

Note that the virtual 32-bit register cannot be used in immediate mode, e.g., to load a constant into the four general purpose registers, or to add or subtract a constant value. This is to avoid problems with variable length instructions.

For LDQ and STQ, it would save at most one byte compared to LDA # $\$nn$... LDZ # $\$nn$, and would be no faster. In fact, for many common values, such as # $\$00000000$, there are short-cuts, such as:

```

LDA # $\$00$ 
TAX
TAY
TAZ

```

If you need to add or subtract a 32-bit immediate value, this may require you to reorder the arguments, or perform other minor gymnastics. For example, to compute the sum of the contents of memory and an immediate value, you can load the A, X, Y and Z registers with the immediate value, and then use **ADCQ** with the memory address, e.g.:

```

; Get the immediate value #$12345678 into Q
LDA #$78
LDX #$56
LDY #$34
LDZ #$12
; Add the contents of memory locations $1234-$1237
NEG
NEG
ADC $1234
; Store the result back in $1234-$1237
NEG
NEG
STA $1234

```

Again, if you are using the ACME or another 45GS02-aware assembler, this can be more compactly and clearly written as follows. But note that in both cases the same byte-sequence of machine code is produced, and the program will take the same number of cycles to execute.

```

; Get the immediate value #$12345678 into Q
LDA #$78
LDX #$56
LDY #$34
LDZ #$12
; Add the contents of memory locations $1234-$1237
ADCQ $1234
; Store the result back in $1234-$1237
STQ $1234

```

C64 CPU MEMORY MAPPED REGISTERS

HEX	DEC	Signal	Description
00	0	PORTDDR	6510/45GS10 CPU port DDR
01	1	PORT	6510/45GS10 CPU port data

NEW CPU MEMORY MAPPED REGISTERS

HEX	DEC	DB7	DB6	DB5	DB4	DB3	DB2	DB1	DB0
D640	54848								HTRAP00
D641	54849								HTRAP01
D642	54850								HTRAP02
D643	54851								HTRAP03
D644	54852								HTRAP04
D645	54853								HTRAP05
D646	54854								HTRAP06
D647	54855								HTRAP07
D648	54856								HTRAP08
D649	54857								HTRAP09
D64A	54858								HTRAP0A
D64B	54859								HTRAP0B
D64C	54860								HTRAP0C
D64D	54861								HTRAP0D
D64E	54862								HTRAP0E
D64F	54863								HTRAP0F
D650	54864								HTRAP10
D651	54865								HTRAP11
D652	54866								HTRAP12
D653	54867								HTRAP13
D654	54868								HTRAP14
D655	54869								HTRAP15
D656	54870								HTRAP16
D657	54871								HTRAP17
D658	54872								HTRAP18
D659	54873								HTRAP19
D65A	54874								HTRAP1A
D65B	54875								HTRAP1B
D65C	54876								HTRAP1C
D65D	54877								HTRAP1D
D65E	54878								HTRAP1E
D65F	54879								HTRAP1F
D660	54880								HTRAP20
D661	54881								HTRAP21

continued ...

...continued

HEX	DEC	DB7	DB6	DB5	DB4	DB3	DB2	DB1	DB0	
D662	54882	HTRAP22								
D663	54883	HTRAP23								
D664	54884	HTRAP24								
D665	54885	HTRAP25								
D666	54886	HTRAP26								
D667	54887	HTRAP27								
D668	54888	HTRAP28								
D669	54889	HTRAP29								
D66A	54890	HTRAP2A								
D66B	54891	HTRAP2B								
D66C	54892	HTRAP2C								
D66D	54893	HTRAP2D								
D66E	54894	HTRAP2E								
D66F	54895	HTRAP2F								
D670	54896	HTRAP30								
D671	54897	HTRAP31								
D672	54898	HTRAP32								
D673	54899	HTRAP33								
D674	54900	HTRAP34								
D675	54901	HTRAP35								
D676	54902	HTRAP36								
D677	54903	HTRAP37								
D678	54904	HTRAP38								
D679	54905	HTRAP39								
D67A	54906	HTRAP3A								
D67B	54907	HTRAP3B								
D67C	54908	HTRAP3C								
D67D	54909	HTRAP3D								
D67E	54910	HTRAP3E								
D67F	54911	HTRAP3F								
D710	55056	-	BADEXTRA		BRCOST	-				
D7FA	55290	FRAMECOUNT								
D7FB	55291	-						CARTEN	-	
D7FD	55293	NOEXROM	NOGAME	-				POWEREN		
D7FE	55294	-						OCEANA	PREFETCH	

- **BADEXTRA** Cost of badlines minus 40. ie. 00=40 cycles, 11 = 43 cycles.

- **BRCOST** 1=charge extra cycle(s) for branches taken
- **CARTEN** 1= enable cartridges
- **FRAMECOUNT** Count number of elapsed video frames
- **HTRAP00** Writing triggers hypervisor trap \$00
- **HTRAP01** Writing triggers hypervisor trap \$01
- **HTRAP02** Writing triggers hypervisor trap \$02
- **HTRAP03** Writing triggers hypervisor trap \$03
- **HTRAP04** Writing triggers hypervisor trap \$04
- **HTRAP05** Writing triggers hypervisor trap \$05
- **HTRAP06** Writing triggers hypervisor trap \$06
- **HTRAP07** Writing triggers hypervisor trap \$07
- **HTRAP08** Writing triggers hypervisor trap \$08
- **HTRAP09** Writing triggers hypervisor trap \$09
- **HTRAP0A** Writing triggers hypervisor trap \$0A
- **HTRAP0B** Writing triggers hypervisor trap \$0B
- **HTRAP0C** Writing triggers hypervisor trap \$0C
- **HTRAP0D** Writing triggers hypervisor trap \$0D
- **HTRAP0E** Writing triggers hypervisor trap \$0E
- **HTRAP0F** Writing triggers hypervisor trap \$0F
- **HTRAP10** Writing triggers hypervisor trap \$10
- **HTRAP11** Writing triggers hypervisor trap \$11
- **HTRAP12** Writing triggers hypervisor trap \$12
- **HTRAP13** Writing triggers hypervisor trap \$13
- **HTRAP14** Writing triggers hypervisor trap \$14
- **HTRAP15** Writing triggers hypervisor trap \$15
- **HTRAP16** Writing triggers hypervisor trap \$16
- **HTRAP17** Writing triggers hypervisor trap \$17
- **HTRAP18** Writing triggers hypervisor trap \$18

- **HTRAP19** Writing triggers hypervisor trap \$19
- **HTRAP1A** Writing triggers hypervisor trap \$1A
- **HTRAP1B** Writing triggers hypervisor trap \$1B
- **HTRAP1C** Writing triggers hypervisor trap \$1C
- **HTRAP1D** Writing triggers hypervisor trap \$1D
- **HTRAP1E** Writing triggers hypervisor trap \$1E
- **HTRAP1F** Writing triggers hypervisor trap \$1F
- **HTRAP20** Writing triggers hypervisor trap \$20
- **HTRAP21** Writing triggers hypervisor trap \$21
- **HTRAP22** Writing triggers hypervisor trap \$22
- **HTRAP23** Writing triggers hypervisor trap \$23
- **HTRAP24** Writing triggers hypervisor trap \$24
- **HTRAP25** Writing triggers hypervisor trap \$25
- **HTRAP26** Writing triggers hypervisor trap \$26
- **HTRAP27** Writing triggers hypervisor trap \$27
- **HTRAP28** Writing triggers hypervisor trap \$28
- **HTRAP29** Writing triggers hypervisor trap \$29
- **HTRAP2A** Writing triggers hypervisor trap \$2A
- **HTRAP2B** Writing triggers hypervisor trap \$2B
- **HTRAP2C** Writing triggers hypervisor trap \$2C
- **HTRAP2D** Writing triggers hypervisor trap \$2D
- **HTRAP2E** Writing triggers hypervisor trap \$2E
- **HTRAP2F** Writing triggers hypervisor trap \$2F
- **HTRAP30** Writing triggers hypervisor trap \$30
- **HTRAP31** Writing triggers hypervisor trap \$31
- **HTRAP32** Writing triggers hypervisor trap \$32
- **HTRAP33** Writing triggers hypervisor trap \$33
- **HTRAP34** Writing triggers hypervisor trap \$34

- **HTRAP35** Writing triggers hypervisor trap \$35
- **HTRAP36** Writing triggers hypervisor trap \$36
- **HTRAP37** Writing triggers hypervisor trap \$37
- **HTRAP38** Writing triggers hypervisor trap \$38
- **HTRAP39** Writing triggers hypervisor trap \$39
- **HTRAP3A** Writing triggers hypervisor trap \$3A
- **HTRAP3B** Writing triggers hypervisor trap \$3B
- **HTRAP3C** Writing triggers hypervisor trap \$3C
- **HTRAP3D** Writing triggers hypervisor trap \$3D
- **HTRAP3E** Writing triggers hypervisor trap \$3E
- **HTRAP3F** Writing triggers hypervisor trap \$3F
- **NOEXROM** Override for /EXROM : Must be 0 to enable /EXROM signal
- **NOGAME** Override for /GAME : Must be 0 to enable /GAME signal
- **OCEANA** Enable Ocean Type A cartridge emulation
- **POWEREN** Set to zero to power off computer on supported systems. WRITE ONLY.
- **PREFETCH** Enable expansion RAM pre-fetch logic

MEGA65 CPU MATHS ACCELERATION REGISTERS

Every MEGA65 contains a combined 32-bit hardware multiplier and divider. This device takes two 32-bit inputs, MULTINA and MULTINB, and simultaneously calculates:

- the 64-bit product of MULTINA and MULTINB
- the 32-bit whole part of $MULTINA / MULTINB$
- the 32-bit fractional part of $MULTINA / MULTINB$

It is always updating the outputs based on the inputs, so there is no need to take special action when changing the inputs. The multiplier takes 1 cycle to calculate, and the updated result will thus be available immediately. The hardware divider, however, can take upto 16 cycles depending on the particular inputs. Thus programmers should insert a short delay after changing the inputs before reading the output. As this delay

is so short, it can be implemented by simply reading the first byte of the result four times consecutively, as the 4th read will occur after the result has settled.

Some models of the MEGA65 also include a math unit, which helps to accelerate the calculation of fixed-point formulae. This presently disabled in all models of the MEGA65 and will be further documented if and when it becomes available.

HEX	DEC	DB7	DB6	DB5	DB4	DB3	DB2	DB1	DB0
D70F	55055	DIVBUSY	MULBUSY	-					
D768	55144	DIVOUT							
D769	55145	DIVOUT							
D76A	55146	DIVOUT							
D76B	55147	DIVOUT							
D76C	55148	DIVOUT							
D76D	55149	DIVOUT							
D76E	55150	DIVOUT							
D76F	55151	DIVOUT							
D770	55152	MULTINA							
D771	55153	MULTINA							
D772	55154	MULTINA							
D773	55155	MULTINA							
D774	55156	MULTINB							
D775	55157	MULTINB							
D776	55158	MULTINB							
D777	55159	MULTINB							
D778	55160	MULTOUT							
D779	55161	MULTOUT							
D77A	55162	MULTOUT							
D77B	55163	MULTOUT							
D77C	55164	MULTOUT							
D77D	55165	MULTOUT							
D77E	55166	MULTOUT							
D77F	55167	MULTOUT							
D780	55168	MATHINO							
D781	55169	MATHINO							
D782	55170	MATHINO							
D783	55171	MATHINO							
D784	55172	MATHIN 1							
D785	55173	MATHIN 1							
D786	55174	MATHIN 1							
D787	55175	MATHIN 1							

continued ...

...continued

HEX	DEC	DB7	DB6	DB5	DB4	DB3	DB2	DB1	DB0
D788	55176					MATHIN2			
D789	55177					MATHIN2			
D78A	55178					MATHIN2			
D78B	55179					MATHIN2			
D78C	55180					MATHIN3			
D78D	55181					MATHIN3			
D78E	55182					MATHIN3			
D78F	55183					MATHIN3			
D790	55184					MATHIN4			
D791	55185					MATHIN4			
D792	55186					MATHIN4			
D793	55187					MATHIN4			
D794	55188					MATHIN5			
D795	55189					MATHIN5			
D796	55190					MATHIN5			
D797	55191					MATHIN5			
D798	55192					MATHIN6			
D799	55193					MATHIN6			
D79A	55194					MATHIN6			
D79B	55195					MATHIN6			
D79C	55196					MATHIN7			
D79D	55197					MATHIN7			
D79E	55198					MATHIN7			
D79F	55199					MATHIN7			
D7A0	55200					MATHIN8			
D7A1	55201					MATHIN8			
D7A2	55202					MATHIN8			
D7A3	55203					MATHIN8			
D7A4	55204					MATHIN9			
D7A5	55205					MATHIN9			
D7A6	55206					MATHIN9			
D7A7	55207					MATHIN9			
D7A8	55208					MATHIN 10			
D7A9	55209					MATHIN 10			
D7AA	55210					MATHIN 10			
D7AB	55211					MATHIN 10			
D7AC	55212					MATHIN 11			
D7AD	55213					MATHIN 11			

continued ...

...continued

HEX	DEC	DB7	DB6	DB5	DB4	DB3	DB2	DB1	DB0
D7AE	55214								MATHIN 11
D7AF	55215								MATHIN 11
D7B0	55216								MATHIN 12
D7B1	55217								MATHIN 12
D7B2	55218								MATHIN 12
D7B3	55219								MATHIN 12
D7B4	55220								MATHIN 13
D7B5	55221								MATHIN 13
D7B6	55222								MATHIN 13
D7B7	55223								MATHIN 13
D7B8	55224								MATHIN 14
D7B9	55225								MATHIN 14
D7BA	55226								MATHIN 14
D7BB	55227								MATHIN 14
D7BC	55228								MATHIN 15
D7BD	55229								MATHIN 15
D7BE	55230								MATHIN 15
D7BF	55231								MATHIN 15
D7C0	55232			UNIT0INB					UNIT0INA
D7C1	55233			UNIT1INB					UNIT1INA
D7C2	55234			UNIT2INB					UNIT2INA
D7C3	55235			UNIT3INB					UNIT3INA
D7C4	55236			UNIT4INB					UNIT4INA
D7C5	55237			UNIT5INB					UNIT5INA
D7C6	55238			UNIT6INB					UNIT6INA
D7C7	55239			UNIT7INB					UNIT7INA
D7C8	55240			UNIT8INB					UNIT8INA
D7C9	55241			UNIT9INB					UNIT9INA
D7CA	55242			UNIT10INB					UNIT10INA
D7CB	55243			UNIT11INB					UNIT11INA
D7CC	55244			UNIT12INB					UNIT12INA
D7CD	55245			UNIT13INB					UNIT13INA
D7CE	55246			UNIT14INB					UNIT14INA
D7CF	55247			UNIT15INB					UNIT15INA
D7D0	55248			-					UNIT0OUT
D7D1	55249			-					UNIT1OUT
D7D2	55250			-					UNIT2OUT
D7D3	55251			-					UNIT3OUT

continued ...

...continued

HEX	DEC	DB7	DB6	DB5	DB4	DB3	DB2	DB1	DB0
D7D4	55252		-				UNIT4OUT		
D7D5	55253		-				UNIT5OUT		
D7D6	55254		-				UNIT6OUT		
D7D7	55255		-				UNIT7OUT		
D7D8	55256		-				UNIT8OUT		
D7D9	55257		-				UNIT9OUT		
D7DA	55258		-				UNIT10OUT		
D7DB	55259		-				UNIT11OUT		
D7DC	55260		-				UNIT12OUT		
D7DD	55261		-				UNIT13OUT		
D7DE	55262		-				UNIT14OUT		
D7DF	55263		-				UNIT15OUT		
D7E0	55264	LATCHINT							
D7E1	55265		-					CALCEN	WREN
D7E2	55266	RESERVED							
D7E3	55267	RESERVED							

- **CALCEN** Enable committing of output values from math units back to math registers (clearing effectively pauses iterative formulae)
- **DIVBUSY** Set if hardware divider is busy
- **DIVOUT** 64-bit output of $MULTINA \div MULTINB$
- **LATCHINT** Latch interval for latched outputs (in CPU cycles)
- **MATHINO** Math unit 32-bit input 0
- **MATHIN1** Math unit 32-bit input 1
- **MATHIN10** Math unit 32-bit input 10
- **MATHIN11** Math unit 32-bit input 11
- **MATHIN12** Math unit 32-bit input 12
- **MATHIN13** Math unit 32-bit input 13
- **MATHIN14** Math unit 32-bit input 14
- **MATHIN15** Math unit 32-bit input 15
- **MATHIN2** Math unit 32-bit input 2
- **MATHIN3** Math unit 32-bit input 3
- **MATHIN4** Math unit 32-bit input 4

- **MATHIN5** Math unit 32-bit input 5
- **MATHIN6** Math unit 32-bit input 6
- **MATHIN7** Math unit 32-bit input 7
- **MATHIN8** Math unit 32-bit input 8
- **MATHIN9** Math unit 32-bit input 9
- **MULBUSY** Set if hardware multiplier is busy
- **MULTINA** Multiplier input A / Divider numerator (32 bit)
- **MULTINB** Multiplier input B / Divider denominator (32 bit)
- **MULTOUT** 64-bit output of $MULTINA \times MULTINB$
- **RESERVED** Reserved
- **UNIT0INA** Select which of the 16 32-bit math registers is input A for Math Function Unit 0.
- **UNIT0INB** Select which of the 16 32-bit math registers is input B for Math Function Unit 0.
- **UNIT0OUT** Select which of the 16 32-bit math registers receives the output of Math Function Unit 0
- **UNIT10INA** Select which of the 16 32-bit math registers is input A for Math Function Unit 10.
- **UNIT10INB** Select which of the 16 32-bit math registers is input B for Math Function Unit 10.
- **UNIT10OUT** Select which of the 16 32-bit math registers receives the output of Math Function Unit A
- **UNIT11INA** Select which of the 16 32-bit math registers is input A for Math Function Unit 11.
- **UNIT11INB** Select which of the 16 32-bit math registers is input B for Math Function Unit 11.
- **UNIT11OUT** Select which of the 16 32-bit math registers receives the output of Math Function Unit B
- **UNIT12INA** Select which of the 16 32-bit math registers is input A for Math Function Unit 12.
- **UNIT12INB** Select which of the 16 32-bit math registers is input B for Math Function Unit 12.

- **UNIT12OUT** Select which of the 16 32-bit math registers receives the output of Math Function Unit C
- **UNIT13INA** Select which of the 16 32-bit math registers is input A for Math Function Unit 13.
- **UNIT13INB** Select which of the 16 32-bit math registers is input B for Math Function Unit 13.
- **UNIT13OUT** Select which of the 16 32-bit math registers receives the output of Math Function Unit D
- **UNIT14INA** Select which of the 16 32-bit math registers is input A for Math Function Unit 14.
- **UNIT14INB** Select which of the 16 32-bit math registers is input B for Math Function Unit 14.
- **UNIT14OUT** Select which of the 16 32-bit math registers receives the output of Math Function Unit E
- **UNIT15INA** Select which of the 16 32-bit math registers is input A for Math Function Unit 15.
- **UNIT15INB** Select which of the 16 32-bit math registers is input B for Math Function Unit 15.
- **UNIT15OUT** Select which of the 16 32-bit math registers receives the output of Math Function Unit F
- **UNIT1INA** Select which of the 16 32-bit math registers is input A for Math Function Unit 1.
- **UNIT1INB** Select which of the 16 32-bit math registers is input B for Math Function Unit 1.
- **UNIT1OUT** Select which of the 16 32-bit math registers receives the output of Math Function Unit 1
- **UNIT2INA** Select which of the 16 32-bit math registers is input A for Math Function Unit 2.
- **UNIT2INB** Select which of the 16 32-bit math registers is input B for Math Function Unit 2.
- **UNIT2OUT** Select which of the 16 32-bit math registers receives the output of Math Function Unit 2
- **UNIT3INA** Select which of the 16 32-bit math registers is input A for Math Function Unit 3.

- **UNIT3INB** Select which of the 16 32-bit math registers is input B for Math Function Unit 3.
- **UNIT3OUT** Select which of the 16 32-bit math registers receives the output of Math Function Unit 3
- **UNIT4INA** Select which of the 16 32-bit math registers is input A for Math Function Unit 4.
- **UNIT4INB** Select which of the 16 32-bit math registers is input B for Math Function Unit 4.
- **UNIT4OUT** Select which of the 16 32-bit math registers receives the output of Math Function Unit 4
- **UNIT5INA** Select which of the 16 32-bit math registers is input A for Math Function Unit 5.
- **UNIT5INB** Select which of the 16 32-bit math registers is input B for Math Function Unit 5.
- **UNIT5OUT** Select which of the 16 32-bit math registers receives the output of Math Function Unit 5
- **UNIT6INA** Select which of the 16 32-bit math registers is input A for Math Function Unit 6.
- **UNIT6INB** Select which of the 16 32-bit math registers is input B for Math Function Unit 6.
- **UNIT6OUT** Select which of the 16 32-bit math registers receives the output of Math Function Unit 6
- **UNIT7INA** Select which of the 16 32-bit math registers is input A for Math Function Unit 7.
- **UNIT7INB** Select which of the 16 32-bit math registers is input B for Math Function Unit 7.
- **UNIT7OUT** Select which of the 16 32-bit math registers receives the output of Math Function Unit 7
- **UNIT8INA** Select which of the 16 32-bit math registers is input A for Math Function Unit 8.
- **UNIT8INB** Select which of the 16 32-bit math registers is input B for Math Function Unit 8.
- **UNIT8OUT** Select which of the 16 32-bit math registers receives the output of Math Function Unit 8

- **UNIT9INA** Select which of the 16 32-bit math registers is input A for Math Function Unit 9.
- **UNIT9INB** Select which of the 16 32-bit math registers is input B for Math Function Unit 9.
- **UNIT9OUT** Select which of the 16 32-bit math registers receives the output of Math Function Unit 9
- **WREN** Enable setting of math registers (must normally be set)

MEGA65 HYPERVISOR MODE

Reset



On power-up or reset, the MEGA65 starts up in hypervisor mode, and expects to find a program in the 16KB hypervisor memory, and begins executing instructions at address \$8100. Normally a JMP instruction will be located at this address, that will jump into a reset routine. That is, the 45GS02 does not use the normal 6502 reset vector. It's function is emulated by the Hyppo hypervisor program, which fetches the address from the 6502 reset vector in the loaded client operating system when exiting hypervisor mode.

The hypervisor memory is automatically mapped on reset to \$8000 - \$BFFF. This special memory is not able to mapped or in anyway accessed, except when in hypervisor mode. It can, however, always be accessed from the serial monitor/debugger interface via its 28-bit address, \$FFF8000 - \$FFFBFFF. This is to protect it from accidental or malicious access from a guest operating system.

Entering / Exiting Hypervisor Mode

Entering the Hypervisor occurs whenever any of the following events occurs:

- **Power-on** When the MEGA65 is first powered on.
- **Reset** If the reset line is lowered, or a watch-dog triggered reset occurs.
- **SYSCALL register accessed** The registers \$D640 - \$D67F in the MEGA65 I/O context trigger SYSCALLs when accessed. This is intended to be the mechanism by which a client operating system or process requests the attention of the hypervisor or operating system.

- **Page Fault** On MEGA65s that feature virtual memory, a page fault will cause a trap to hypervisor mode.
- **Certain keyboard events** Pressing  for >0.5 seconds, or the  and  key combination traps to the hypervisor. Typically the first is used to launch the Freeze Menu and the second to toggle the display of debug interface.
- **Accessing virtualised I/O devices** For example, if the F011 (internal 3.5" disk drive controller) has been virtualised, then attempting to read or write sectors using this device will cause traps to the hypervisor.
- **Executing an instruction that would lock up the CPU** A number of undocumented opcodes on the 6502 will cause the CPU to lockup. On the MEGA65, instead of locking up, the computer will trap to the hypervisor. This could be used to implement alternative instruction behaviours, or simply to tell the user that something bad has happened.
- **Certain special events** Some devices can generate hypervisor-level interrupts. These are implemented as traps to the hypervisor.

The 45GS02 handles all of these in a similar manner internally:

1. The SYSCALL or trap address is calculated, based on the event.
2. The contents of all CPU registers are saved into the virtualisation control registers.
3. The hypervisor mode memory layout is activated, the CPU decimal flag and special purpose registers are all set to appropriate values. The contents of the A,X,Y and Z and most other CPU flags are preserved, so that they can be accessed from the Hypervisor's SYSCALL/trap handler routine, without having to load them, thus saving a few cycles for each call.
4. The hypervisor-mode flag is asserted, and the program counter (PC) register is set to the computed address.

All of the above happens in one CPU cycle, i.e., in 25 nano-seconds. Returning from a SYSCALL or trap consists simply of writing to \$D67F, which requires 125 nano-seconds, for a total overhead of 150 nano-seconds. This gives the MEGA65 SYSCALL performance rivalling – even beating – even the fastest modern computers, where the system call latency is typically hundreds to tens of thousands of cycles [2].

Hypervisor Memory Layout

The hypervisor memory is 16KB in size. The first 512 bytes are reserved for SYSCALL and system trap entry points, with four bytes for each. For example, the reset entry

point is at \$8100 - \$8100 + 3 = \$8100 - \$8103. This allows 4 bytes for an instruction, typically a JMP instruction, followed by a NOP to pad it to 4 bytes.

The full list of SYSCALLs and traps is:

HEX	DEC	Name	Description
8000	32768	SYSCALL00	SYSCALL 0 entry point
8004	32772	SYSCALL01	SYSCALL 1 entry point
8008	32776	SYSCALL02	SYSCALL 2 entry point
800C	32780	SYSCALL03	SYSCALL 3 entry point
8010	32784	SYSCALL04	SYSCALL 4 entry point
8014	32788	SYSCALL05	SYSCALL 5 entry point
8018	32792	SYSCALL06	SYSCALL 6 entry point
801C	32796	SYSCALL07	SYSCALL 7 entry point
8020	32800	SYSCALL08	SYSCALL 8 entry point
8024	32804	SYSCALL09	SYSCALL 9 entry point
8028	32808	SYSCALL0A	SYSCALL 10 entry point
802C	32812	SYSCALL0B	SYSCALL 11 entry point
8030	32816	SYSCALL0C	SYSCALL 12 entry point
8034	32820	SYSCALL0D	SYSCALL 13 entry point
8038	32824	SYSCALL0E	SYSCALL 14 entry point
803C	32828	SYSCALL0F	SYSCALL 15 entry point
8040	32832	SYSCALL10	SYSCALL 16 entry point
8044	32836	SECURENTR	Enter secure container trap entry point
8048	32840	SECUREXIT	Leave secure container trap entry point.
804C	32844	SYSCALL13	SYSCALL 19 entry point
8050	32848	SYSCALL14	SYSCALL 20 entry point
8054	32852	SYSCALL15	SYSCALL 21 entry point
8058	32856	SYSCALL16	SYSCALL 22 entry point
805C	32860	SYSCALL17	SYSCALL 23 entry point
8060	32864	SYSCALL18	SYSCALL 24 entry point
8064	32868	SYSCALL19	SYSCALL 25 entry point
8068	32872	SYSCALL1A	SYSCALL 26 entry point
806C	32876	SYSCALL1B	SYSCALL 27 entry point
8070	32880	SYSCALL1C	SYSCALL 28 entry point
8074	32884	SYSCALL1D	SYSCALL 29 entry point
8078	32888	SYSCALL1E	SYSCALL 30 entry point
807C	32892	SYSCALL1F	SYSCALL 31 entry point
8080	32896	SYSCALL20	SYSCALL 32 entry point
8084	32900	SYSCALL21	SYSCALL 33 entry point
8088	32904	SYSCALL22	SYSCALL 34 entry point

continued ...

...continued

HEX	DEC	Name	Description
808C	32908	SYSCALL23	SYSCALL 35 entry point
8090	32912	SYSCALL24	SYSCALL 36 entry point
8094	32916	SYSCALL25	SYSCALL 37 entry point
8098	32920	SYSCALL26	SYSCALL 38 entry point
809C	32924	SYSCALL27	SYSCALL 39 entry point
80A0	32928	SYSCALL28	SYSCALL 40 entry point
80A4	32932	SYSCALL29	SYSCALL 41 entry point
80A8	32936	SYSCALL2A	SYSCALL 42 entry point
80AC	32940	SYSCALL2B	SYSCALL 43 entry point
80B0	32944	SYSCALL2C	SYSCALL 44 entry point
80B4	32948	SYSCALL2D	SYSCALL 45 entry point
80B8	32952	SYSCALL2E	SYSCALL 46 entry point
80BC	32956	SYSCALL2F	SYSCALL 47 entry point
80C0	32960	SYSCALL30	SYSCALL 48 entry point
80C4	32964	SYSCALL31	SYSCALL 49 entry point
80C8	32968	SYSCALL32	SYSCALL 50 entry point
80CC	32972	SYSCALL33	SYSCALL 51 entry point
80D0	32976	SYSCALL34	SYSCALL 52 entry point
80D4	32980	SYSCALL35	SYSCALL 53 entry point
80D8	32984	SYSCALL36	SYSCALL 54 entry point
80DC	32988	SYSCALL37	SYSCALL 55 entry point
80E0	32992	SYSCALL38	SYSCALL 56 entry point
80E4	32996	SYSCALL39	SYSCALL 57 entry point
80E8	33000	SYSCALL3A	SYSCALL 58 entry point
80EC	33004	SYSCALL3B	SYSCALL 59 entry point
80F0	33008	SYSCALL3C	SYSCALL 60 entry point
80F4	33012	SYSCALL3D	SYSCALL 61 entry point
80F8	33016	SYSCALL3E	SYSCALL 62 entry point
80FC	33020	SYSCALL3F	SYSCALL 63 entry point
8100	33024	RESET	Power-on/reset entry point
8104	33028	PAGFAULT	Page fault entry point (not currently used)
8108	33032	RESTORKEY	Restore-key long press trap entry point
810C	33036	ALT+TABKEY	ALT+TAB trap entry point
8110	33040	VF011RD	F011 virtualised disk read trap entry point
8114	33044	VF011WR	F011 virtualised disk write trap entry point

continued ...

...continued

HEX	DEC	Name	Description
8118	33048	BREAKPT	CPU break-point encountered
811C - 81FB	33048 - 33275	RESERVED	Reserved traps point entry
81FC	33276	CPUKIL	KIL instruction in 6502-mode trap entry point

The remainder of the 16KB hypervisor memory is available for use by the programmer, but will typically use the last 512 bytes for the stack and zero-page, giving an overall memory map as follows:

HEX	DEC	Description
8000 - 81FF	32768 - 33279	SYSCALL and trap entry points
8200 - BDFF	33280 - 48639	Available for hypervisor or operating system program
8E00 - BEFF	48640 - 48895	Processor stack for hypervisor or operating system
8F00 - BFFF	48896 - 49151	Processor zero-page storage for hypervisor or operating system

The stack is used for holding the return address of function calls. The zero-page storage is typically used for holding variables and other short-term storage, as is customary on the 6502.

Hypervisor Virtualisation Control Registers

HEX	DEC	DB7	DB6	DB5	DB4	DB3	DB2	DB1	DB0
D640	54848	REGA							
D641	54849	REGX							
D643	54851	REGZ							

continued ...

...continued

HEX	DEC	DB7	DB6	DB5	DB4	DB3	DB2	DB1	DB0	
D644	54852	REGB								
D645	54853	SPL								
D646	54854	SPH								
D647	54855	PFLAGS								
D648	54856	PCL								
D649	54857	PCH								
D64A	54858	MAPLO								
D64B	54859	MAPLO								
D64C	54860	MAPHI								
D64D	54861	MAPHI								
D64E	54862	MAPLOMB								
D64F	54863	MAPHIMB								
D650	54864	PORT00								
D651	54865	PORT01								
D652	54866	-					EXSID	VICMODE		
D653	54867	DMASRCMB								
D654	54868	DMADSTMB								
D655	54869	DMALADDR								
D656	54870	DMALADDR								
D657	54871	DMALADDR								
D658	54872	DMALADDR								
D659	54873	-					VFLOP	VFLOP		
D670	54896	GEORAMBASE								
D671	54897	GEORAMMASK								
D672	54898	-	MATRIXEN							-
D67C	54908	UARTDATA								
D67D	54909	WATCHDOG								
D67E	54910	HICKED								
D67F	54911	ENTEREXIT								

- **ASCFast** Hypervisor enable ASC/DIN CAPS LOCK key to enable/disable CPU slow-down in C64/C128/C65 modes
- **CPUFast** Hypervisor force CPU to 48MHz for userland (userland can override via POKE0)
- **DMADSTMB** Hypervisor DMAgic destination MB
- **DMALADDR** Hypervisor DMAGic list address bits 0-7
- **DMASRCMB** Hypervisor DMAgic source MB

- **ENTEREXIT** Writing trigger return from hypervisor
- **EXSID** 0=Use internal SIDs, 1=Use external(1) SIDs
- **F4502** Hypervisor force CPU to 4502 personality, even in C64 IO mode.
- **GEORAMBASE** Hypervisor GeoRAM base address (x MB)
- **GEORAMMASK** Hypervisor GeoRAM address mask (applied to GeoRAM block register)
- **HICKED** Hypervisor already-upgraded bit (writing sets permanently)
- **JMP32EN** Hypervisor enable 32-bit JMP/JSR etc
- **MAPHI** Hypervisor MAPHI register storage (high bits)
- **MAPHIMB** Hypervisor MAPHI mega-byte number register storage
- **MAPLO** Hypervisor MAPLO register storage (high bits)
- **MAPLOMB** Hypervisor MAPLO mega-byte number register storage
- **MATRIXEN** Enable composited Matrix Mode, and disable UART access to serial monitor.
- **PCH** Hypervisor PC-high register storage
- **PCL** Hypervisor PC-low register storage
- **PFLAGS** Hypervisor P register storage
- **PIRQ** Hypervisor flag to indicate if an IRQ is pending on exit from the hypervisor / set 1 to force IRQ/NMI deferral for 1,024 cycles on exit from hypervisor.
- **PNMI** Hypervisor flag to indicate if an NMI is pending on exit from the hypervisor.
- **PORT00** Hypervisor CPU port \$00 value
- **PORT01** Hypervisor CPU port \$01 value
- **REGA** Hypervisor A register storage
- **REGB** Hypervisor B register storage
- **REGX** Hypervisor X register storage
- **REGZ** Hypervisor Z register storage
- **ROMPROT** Hypervisor write protect C65 ROM \$20000-\$3FFFF
- **RSVD** RESERVED
- **SPH** Hypervisor SPH register storage

- **SPL** Hypervisor SPL register storage
- **UARTDATA** (write) Hypervisor write serial output to UART monitor
- **VFLOP** 1=Virtualise SD/Floppy0 access (usually for access via serial debugger interface)
- **VICMODE** VIC-II/VIC-III/VIC-IV mode select
- **WATCHDOG** Hypervisor watchdog register: writing any value clears the watch dog

Programming for Hypervisor Mode

The easiest way to write a program for Hypervisor Mode on the MEGA65 is to use KickC, which is a special version of C made for writing programs for 6502-class processors. The following example programs are from KickC's supplied examples. KickC produces very efficient code, and directly supports the MEGA65's hypervisor mode quite easily through the use of a linker definition file with the following contents:

```
.file [name="%0.bin", type="bin", segments="XMega65Bin"]
.segmentdef XMega65Bin [segments="Syscall, Code, Data, Stack, Zeropage"]
.segmentdef Syscall [start=$8000, max=$81ff]
.segmentdef Code [start=$8200, min=$8200, max=$bdff]
.segmentdef Data [startAfter="Code", min=$8200, max=$bdff]
.segmentdef Stack [min=$be00, max=$beff, fill]
.segmentdef Zeropage [min=$bf00, max=$bfff, fill]
```

This file instructs KickC's assembler to create a 16KB file with the 512 byte SYSCALL/trap entry point region at the start, followed by code and data areas, and then the stack and zero-page areas. It enforces the size and location of these fields, and will give an error during compilation if anything is too big to fit.

With this file in place, you can then create a KickC source file that provides data structures for the SYSCALL/trap table, e.g.:

```

// XMEGA65 KERNEL Development Template
// Each function of the KERNEL is a no-args function
// The functions are placed in the SYSCALLS table surrounded by JMP and NOP

import "string"

// Use a linker definition file (put the previous listing into that file)
#pragma link("mega65hyper.ld")

// Some definitions of addresses and special values that this program uses
const char* RASTER = 0xd012;
const char* VIC+MEMORY = 0xd018;
const char* SCREEN = 0x0400;
const char* BGCOL = 0xd021;
const char* COLS = 0xd000;
const char BLACK = 0;
const char WHITE = 1;

// Some text to display
char[] MESSAGE = "hello world!";

void main() {
    // Initialise screen memory, and select correct font
    *VIC+MEMORY = 0x14;
    // Fill the screen with spaces
    memset(SCREEN, ' ', 40*25);
    // Set the colour of every character on the screen to white
    memset(COLS, WHITE, 40*25);
    // Print the "hello world!" message
    char* sc = SCREEN+40; // Display it one line down on the screen
    char* msg = MESSAGE; // The message to display
    // A simple copy routine to copy the string
    while(*msg) {
        *sc++ = *msg++;
    }
    // Loop forever showing two white lines as raster bars
    while(true) {
        if(*RASTER==54 || *RASTER==66) {
            *BGCOL = WHITE;
        } else {
            *BGCOL = BLACK;
        }
    }
}

// Here are a couple sample SYSCALL handlers that just display a character on the screen
void syscall1() {

```

If you save the first listing into a file called `mega65hyper.ld`, and the second into a file called `mega65hyper.kc`, you can then compile them using KickC with a command like:

```
kickc -a mega65hyper
```

It will then produce a file called `mega65hyper.bin`, which you can then try out on your MEGA65, or run in the XMega65 emulator with a command like:

```
xmega65 -kickup mega65hyper.bin
```

APPENDIX

H

45GS02 & 6502 Instruction Sets

- **Addressing Modes**
- **6502 Instruction Set**
- **4510 Instruction Set**
- **45GS02 Compound Instructions**

The 45GS02 CPU is able to operate in native mode, where it is compatible with the CSG 4510, and in 6502 compatibility mode, where 6502 undocumented instructions, also known as illegal instructions, are supported for compatibility.

When in 4510 compatibility mode, the 45GS02 also supports a number of extensions through *compound instructions*. These work by prefixing the desired instruction's opcode with one or more *prefix bytes*, which represent sequences of instructions that should not normally occur. For example, two **NEG** instructions in a row acts as a prefix to tell the 45GS02 that the following instruction will operate on 32 bits of data, instead of the usual 8 bits of data. This means that a 45GS02 instruction stream can be readily decoded or disassembled, without needing to set special instruction length flags, as is the case with the 65816 family of microprocessors. The trade-off is increased execution time, as the 45GS02 must skip over the prefix bytes.

The remainder of this chapter introduces the addressing modes, instructions, opcodes and instruction timing data of the 45GS02, beginning with 6502 compatibility mode, before moving on to 4510 compatibility mode, and the 45GS02 extensions.

ADDRESSING MODES

The 45GS02 supports 36 different addressing modes, which are explained below. Many of these are very similar to one another, being variations of the normal 6502 or 65CE02 addressing modes, except that they accept either 32-bit pointers, operate on 32-bits of data, or both.

Implied

In this mode, there are no operands, as the precise function of the instruction is implied by the instruction itself. For example, the **INX** instruction increments the X Register.

Accumulator

In this mode, the Accumulator is the operand. This is typically used to shift, rotate or modify the value of the Accumulator Register in some way. For example, **INC A** increments the value in the Accumulator Register.

Q Pseudo Register

In this mode, the Q Pseudo Register is the operand. This is typically used to shift, rotate or modify the value of the Q Pseudo Register in some way. For example, `ASL Q` shifts the value in the Q Pseudo Register left one bit.

Remember that the Q Pseudo Register is simply the A, X, Y and Z registers acting together as a pseudo 32-bit register, where A contains the least significant bits, and Z the most significant bits. There are some cases where using a Q mode instruction can be helpful for operating on the four true registers.

Immediate Mode

In this mode, the argument to the instruction is a value that is used directly. This is indicated by proceeding the value with a # character. Most assemblers allow values to be entered in decimal, or in hexadecimal by preceding the value with a \$ sign, in binary, by preceding the value with a % sign. For example, to set the Accumulator Register to the value 5, you could use the following:

```
LDA #5
```

The immediate argument is encoded as a single byte following the instruction. For the above case, the instruction stream would contain `$A9`, the opcode for LDA immediate mode, followed by `$05`, the immediate operand.

Immediate Word Mode

In this mode, the argument is a 16-bit value that is used directly. There is only one instruction which uses this addressing mode, `PHW`. For example, to push the word `$1234` onto the stack, you could use:

```
PHW #$1234
```

The low byte of the immediate value follows the opcode of the instruction. The high byte of the immediate value then follows that. For the above example, the instruction stream would thus be `$F4 $34 $12`.

Base Page (Zero-Page) Mode

In this mode, the argument is an 8-bit address. The upper 8-bits of the address are taken from the Base Page Register. On 6502 processors, there is no Base Page Register, and instead, the upper 8-bits are always set to zero – hence the name of this mode on the 6502: Zero-Page. On the 45GS02, it is possible to move this “Zero-Page” to any page in the processor’s 64KB view of memory by setting the Base Page Register using the `TAB` instruction. Base Page Mode allows faster access to a 256 region of memory, and uses less instruction bytes to do so.

The argument is encoded as a single byte that immediately follows the instruction opcode. For example, `LDA $12` would read the value stored in location \$12 in the Base Page, and put it into the Accumulator Register. The instruction byte stream for this would be `$85 $12`.

Base Page (Zero-Page) Quad Mode

In this mode, the argument is an 8-bit address. The upper 8-bits of the address are taken from the Base Page Register. On 6502 processors, there is no Base Page Register, and instead, the upper 8-bits are always set to zero – hence the name of this mode on the 6502: Zero-Page. On the 45GS02, it is possible to move this “Zero-Page” to any page in the processor’s 64KB view of memory by setting the Base Page Register using the `TAB` instruction. Base Page Mode allows faster access to a 256 region of memory, and uses less instruction bytes to do so.

The argument is encoded as a single byte that immediately follows the instruction opcode. For example, `LDR $12` would read the value stored in locations \$12 – \$15 in the Base Page, and put them into the Q Pseudo Register.

Base Page (Zero-Page) X Indexed Mode

This mode is identical to Base Page Mode, except that the address is formed by taking the argument, and adding the value of the X Register to it. In 6502 mode, the result will always be in the Base Page, that is, any carry due to the addition from the low byte into the high byte of the address will be ignored. The encoding for this addressing mode is identical to Base Page Mode.

Base Page (Zero-Page) Quad X Indexed Mode

This mode is identical to Base Page Quad Mode, except that the address is formed by taking the argument, and adding the value of the X Register to it. In 6502 mode, the result will always be in the Base Page, that is, any carry due to the addition from the low byte into the high byte of the address will be ignored. The encoding for this addressing mode is identical to Base Page Quad Mode.

Base Page (Zero-Page) Y Indexed Mode

This mode is identical to Base Page Mode, except that the address is formed by taking the argument, and adding the value of the Y Register to it. In 6502 mode, the result will always be in the Base Page, that is, any carry due to the addition from the low byte into the high byte of the address will be ignored. The encoding for this addressing mode is identical to Base Page Mode.

Base Page (Zero-Page) Base Y Indexed Mode

This mode is identical to Base Page Quad Mode, except that the address is formed by taking the argument, and adding the value of the Y Register to it. In 6502 mode, the result will always be in the Base Page, that is, any carry due to the addition from the low byte into the high byte of the address will be ignored. The encoding for this addressing mode is identical to Base Page Quad Mode.

Base Page (Zero-Page) Z Indexed Mode

This mode is identical to Base Page Mode, except that the address is formed by taking the argument, and adding the value of the Z Register to it. In 6502 mode, the result will always be in the Base Page, that is, any carry due to the addition from the low byte

into the high byte of the address will be ignored. The encoding for this addressing mode is identical to Base Page Mode.

Base Page (Zero-Page) Quad Z Indexed Mode

This mode is identical to Base Page Quad Mode, except that the address is formed by taking the argument, and adding the value of the Z Register to it. In 6502 mode, the result will always be in the Base Page, that is, any carry due to the addition from the low byte into the high byte of the address will be ignored. The encoding for this addressing mode is identical to Base Page Quad Mode.

Absolute Mode

In this mode, the argument is an 16-bit address. The low 8-bits of the address are taken from the byte immediately following the instruction opcode. The upper 8-bits are taken from the byte following that. For example, the instruction `LDA $1234`, would read the memory location \$1234, and place the read value into the Accumulator Register. This would be encoded as `$AD $34 $12`.

Absolute Quad Mode

In this mode, the argument is an 16-bit address. The low 8-bits of the address are taken from the byte immediately following the instruction opcode. The upper 8-bits are taken from the byte following that. For example, the instruction `LQA $1234`, would read the memory locations \$1234 - \$1237, and place the read values into the Q Pseudo Register. This would be encoded as `$42 $42 $AD $34 $12`.

Absolute X Indexed Mode

This mode is identical to Absolute Mode, except that the address is formed by taking the argument, and adding the value of the X Register to it. If the indexing causes the address to cross a page boundary, i.e., if the upper byte of the address changes, this may incur a 1 cycle penalty, depending on the processor mode and speed setting. The encoding for this addressing mode is identical to Absolute Mode.

Absolute Quad X Indexed Mode

This mode is identical to Absolute Quad Mode, except that the address is formed by taking the argument, and adding the value of the X Register to it. If the indexing causes the address to cross a page boundary, i.e., if the upper byte of the address changes, this may incur a 1 cycle penalty, depending on the processor mode and speed setting. The encoding for this addressing mode is identical to Absolute Quad Mode.

Absolute Y Indexed Mode

This mode is identical to Absolute Mode, except that the address is formed by taking the argument, and adding the value of the Y Register to it. If the indexing causes the address to cross a page boundary, i.e., if the upper byte of the address changes, this may incur a 1 cycle penalty, depending on the processor mode and speed setting. The encoding for this addressing mode is identical to Absolute Mode.

Absolute Quad Y Indexed Mode

This mode is identical to Absolute Quad Mode, except that the address is formed by taking the argument, and adding the value of the Y Register to it. If the indexing causes the address to cross a page boundary, i.e., if the upper byte of the address changes, this may incur a 1 cycle penalty, depending on the processor mode and speed setting. The encoding for this addressing mode is identical to Absolute Quad Mode.

Absolute Z Indexed Mode

This mode is identical to Absolute Mode, except that the address is formed by taking the argument, and adding the value of the Z Register to it. If the indexing causes the address to cross a page boundary, i.e., if the upper byte of the address changes, this may incur a 1 cycle penalty, depending on the processor mode and speed setting. The encoding for this addressing mode is identical to Absolute Mode.

Absolute Quad Z Indexed Mode

This mode is identical to Absolute Quad Mode, except that the address is formed by taking the argument, and adding the value of the Z Register to it. If the indexing causes the address to cross a page boundary, i.e., if the upper byte of the address changes,

this may incur a 1 cycle penalty, depending on the processor mode and speed setting. The encoding for this addressing mode is identical to Absolute Quad Mode.

Absolute Indirect Mode

In this mode, the 16-bit argument is the address that points to, i.e., contains the address of actual byte to read. For example, if memory location \$1234 contains \$78 and memory location \$1235 contains \$56, then `JMP ($1234)` would jump to address \$5678. The encoding for this addressing mode is identical to Absolute Mode.

Absolute Indirect X-Indexed Mode

In this mode, the 16-bit argument is the address that points to, i.e., contains the address of actual byte to read. It is identical to Absolute Indirect Mode, except that the value of the X Register is added to the pointer address. For example, if the X Register contains the value \$04, memory location \$1238 contains \$78 and memory location \$1239 contains \$56, then `JMP ($1234)` would jump to address \$5678. The encoding for this addressing mode is identical to Absolute Mode.

Base Page Indirect X-Indexed Mode

This addressing mode is identical to Absolute Indirect X-Indexed Mode, except that the address of the pointer is formed from the Base Page Register (high byte) and the 8-bit operand (low byte). The encoding for this addressing mode is identical to Base Page Mode.

Base Page Quad Indirect X-Indexed Mode

This addressing mode is identical to Base Page Indirect X-Indexed Mode, except that the address of the pointer is formed from the Base Page Register (high byte) and the 8-bit operand (low byte). The encoding for this addressing mode is identical to Base Page Quad Mode.

Base Page Indirect Y-Indexed Mode

This addressing mode differs from the X-Indexed Indirect modes, in that the Y Register is added to the address that is read from the pointer, instead of being added to the pointer. This is a very useful mode, that is frequently because it effectively provides access to “the Y-th byte of the memory at the address pointed to by the operand.” That is, it de-references a pointer. The encoding for this addressing mode is identical to Base Page Mode.

Base Page Quad Indirect Y-Indexed Mode

This addressing mode is identical to the Base Page Indirect Y-Indexed Mode, except that 32-bits of data are operated on. The encoding for this addressing mode is identical to Base Page Mode, except that it is prefixed by \$42, \$42.

Base Page Indirect Z-Indexed Mode

This addressing mode differs from the X-Indexed Indirect modes, in that the Z Register is added to the address that is read from the pointer, instead of being added to the pointer. This is a very useful mode, that is frequently because it effectively provides access to “the Z-th byte of the memory at the address pointed to by the operand.” That is, it de-references a pointer. The encoding for this addressing mode is identical to Base Page Mode.

That is, it is equivalent to the Base Page Indirect Y-Indexed Mode.

Base Page Quad Indirect Z-Indexed Mode

This addressing mode is identical to the Base Page Indirect Z-Indexed Mode, except that 32-bits of data are operated on. The encoding for this addressing mode is identical to Base Page Mode, except that it is prefixed by \$42, \$42.

32-bit Base Page Indirect Z-Indexed Mode

This mode is formed by preceding a Base Page Indirect Z-Indexed Mode instruction with the NOP instruction (opcode \$EA). This causes the 45GS02 to read a 32-bit address instead of a 16-bit address from the Base Page address indicated by its operand. The Z index is added to that pointer. Importantly, the 32-bit address does not refer to the processor's current 64KB view of memory, but rather to the 45GS02's true 28-bit address space. This allows easy access to any memory, without requiring the use of complex bank-switching or DMA operations.

For example, if addresses \$12 to \$15 contained the bytes \$20, \$D0, \$FF, \$0D, and the Z index contained the value \$01, the following instruction sequence would change the screen colour to blue:

```
LDA #$06  
LDZ #$01  
STA [$12],Z
```

32-bit Base Page Indirect Quad Z-Indexed Mode

This addressing mode is identical to the 32-bit Base Page Indirect Z-Indexed Mode, except that it operates on 32-bits of data at the 32-bit address formed by the argument, in comparison to 32-bit Base Page Indirect Z-Indexed Mode which operates on only 8 bits of data. The encoding of this addressing mode is \$42, \$42, \$EA, followed by the natural 6502 opcode for the instruction being performed.

32-bit Base Page Indirect Mode

This mode is formed by preceding a Base Page Indirect Z-Indexed Mode instruction with the NOP instruction (opcode \$EA). This causes the 45GS02 to read a 32-bit address instead of a 16-bit address from the Base Page address indicated by its operand. Importantly, the 32-bit address does not refer to the processor's current 64KB view of memory, but rather to the 45GS02's true 28-bit address space. This allows easy access to any memory, without requiring the use of complex bank-switching or DMA operations.

For example, if addresses \$12 to \$15 contained the bytes \$20, \$D0, \$FF, \$0D, the following instruction sequence would change the screen border colour to blue:

```
LDA #$06  
STA [$12]
```

NOTE: The ACME assembler is the only assembler that currently supports this addressing mode. For other assemblers, you can achieve the same result by using a **NOP** instruction to prefix the equivalent *Base Page Indirect, Indexed by Z* instruction.

```
LDA #$06  
NOP  
STA ($12),Z
```

The encoding for this addressing mode is identical to Base Page Mode.

32-bit Base Page Indirect Mode

This addressing mode is identical to the 32-bit Base Page Indirect Mode, except that it operates on 32-bits of data at the 32-bit address formed by the argument, in comparison to 32-bit Base Page Indirect Mode which operates on only 8 bits of data. The encoding of this addressing mode is \$42, \$42, \$EA, followed by the natural 6502 opcode for the instruction being performed.

Stack Relative Indirect, Indexed by Y

This addressing mode is similar to Base Page Indirect Y-Indexed Mode, except that instead of providing the address of the pointer in the Base Page, the operand indicates the offset in the stack to find the pointer. This addressing mode effectively de-references a pointer that has been placed on the stack, e.g., as part of a function call from a high-level language. It is encoded identically to the Base Page Mode.

Relative Addressing Mode

In this addressing mode, the operand is an 8-bit signed offset to the current value of the Program Counter (PC). It is used to allow branches to encode the nearby address at which execution should proceed if the branch is taken.

Relative Word Addressing Mode

This addressing mode is identical to Relative Addressing Mode, except that the address offset is a 16-bit value. This allows a relative branch or jump to any location in the current 64KB memory view. This makes it possible to write software that is fully relocatable, by avoiding the need for absolute addresses when calling routines.

6502 INSTRUCTION SET

NOTE: The mechanisms for switching from 4510 to 6502 CPU personality have yet to be finalised.

NOTE: Not all 6502 illegal opcodes are currently implemented.

Opcode Map

\$x0	\$x1	\$x2	\$x3	\$x4	\$x5	\$x6	\$x7	\$x8	\$x9	\$xA	\$xB	\$xC	\$xD	\$xE	\$xF
\$0x BRK	ORA KIL	SLO	NOP	ORA	ASL	SLO	PHP	ORA	ASL	ANC	NOP	ORA	ASL	SLO	SLO
\$1x BPL	ORA KIL	SLO	NOP	ORA	ASL	SLO	CLC	ORA	NOP	SLO	NOP	ORA	ASL	SLO	SLO
\$2x JSR	AND KIL	RLA	BIT	AND	ROL	RLA	PLP	AND	ROL	ANCBIT	AND	ROL	RLA	AND	ROL
\$3x BMI	AND KIL	RLA	NOP	AND	ROL	RLA	SEC	AND	NOP	RLA	NOP	AND	ROL	RLA	AND
\$4x RTI	FOR KIL	SRE	NOPE	OR	LSR	SRE	PHA	FOR	LSR	ALR	JMP	FOR	LSR	SRE	SRE
\$5x BVC	FOR KIL	SRE	NOPE	OR	LSR	SRE	CLI	FOR	NOP	SRE	NOP	FOR	LSR	SRE	SRE
\$6x RTS	ADCKIL	RRA	NOP	ADC	ROR	RRA	PLA	ADC	ROR	ARR	JMP	ADC	ROR	RRA	RRA
\$7x BVS	ADCKIL	RRA	NOP	ADC	ROR	RRA	SEI	ADC	NOP	RRA	NOP	ADC	ROR	RRA	RRA
\$8x NOP	STA	NOP	SAX	STY	STA	STX	SAX	DEY	NOP	TYA	XAA	STY	STA	STX	SAX
\$9x BCC	STA	KIL	SHA	STY	STA	STX	SAX	TYA	STA	TXS	TAS	SHY	STA	SHX	SHA
\$Ax LDY	LDA	LDX	LAX	LDY	LDA	LDX	LAX	TAY	LDA	TAX	LAX	LDY	LDA	LDX	LAX
\$Bx BCS	LDA	KIL	LAX	LDY	LDA	LDX	LAX	CLV	LDA	TSX	LAS	LDY	LDA	LDX	LAX
\$Cx CPY	CMP	NOP	DCP	CPY	CMP	DEC	DCP	CLD	CMP	NOP	DCP	NOP	CMP	DEC	DCP
\$Dx BNE	CMP	KIL	DCP	NOP	CMP	DEC	DCP	CLD	CMP	NOP	DCP	NOP	CMP	DEC	DCP
\$Ex CPX	SBC	NOP	ISC	CPX	SBC	INC	ISC	INX	SBC	NOP	SBC	CPX	SBC	INC	ISC
\$Fx BEO	SBC	KIL	ISC	NOP	SBC	INC	ISC	SED	SBC	NOP	ISC	NOP	SBC	INC	ISC

Instruction Timing

The following table summarises the base instruction timing for 6502 mode. Please also read the information for 4510 mode, as it discusses a number of important factors that affect these figures.

\$x0	\$x1	\$x2	\$x3	\$x4	\$x5	\$x6	\$x7	\$x8	\$x9	\$xA	\$xB	\$xC	\$xD	\$xE	\$xF
\$0x7	6	9	8	3	3	5	5	3	2	2	2	2	4	4	6
\$1x2 ^b	5 ^p	9	8	4	4 ^p	6	6	2	4 ^p	2	7	4 ^p	4 ^p	7	7
\$2x6	6	9	8	3	3	5	5	4	2	2	2	4	4	6	6
\$3x2 ^b	5 ^p	9	8	4	4	6	6	2	4 ^p	2	7	4 ^p	4 ^p	7	7
\$4x6	6	9	8	3	3	5	5	3	2	2	2	3	4	6	6
\$5x2 ^b	5 ^p	9	8	4	4	6	6	2	4 ^p	2	7	4 ^p	4 ^p	7	7
\$6x6	6	9	8	3	3	5	5	4	2	2	2	5	4	6	6
\$7x2 ^b	5 ^p	9	8	4	4	6	6	2	4 ^p	2	7	4 ^p	4 ^p	7	7
\$8x2	6	2	6	3	3	3	3	2	2	2	2	4	4	4	4
\$9x2 ^b	6	9	6	4	4	4	4	2	5	2	5	5	5	5	5
\$Ax2	6	2	6	3	3	3	3	2	2	2	2	4	4	4	4
\$Bx2 ^b	5 ^p	9	5 ^p	4	4	4	4	2	4 ^p	2	4 ^p	4 ^p	4 ^p	4 ^p	4 ^p
\$Cx2	6	2	8	3	3	5	5	2	2	2	2	4	4	6	6
\$Dx2 ^b	5 ^p	9	8	4	4	6	6	2	4 ^p	2	7	4 ^p	4 ^p	7	7
\$Ex2	6	2	8	3	3	5	5	2	2	2	2	4	4	6	6
\$Fx2 ^b	5 ^p	9	8	4	4	6	6	2	4 ^p	2	7	4 ^p	4 ^p	7	7

*b*Add one cycle if branch crosses a page boundary.

*p*Add one cycle if indexing crosses a page boundary.

Addressing Mode Table

\$x0	\$x1	\$x2	\$x3	\$x4	\$x5	\$x6	\$x7	\$x8	\$x9	\$xA	\$xB	\$xC	\$xD	\$xE	\$xF
\$0x	(m,n)	(m,n)	(m,n)	(m,n)	(m,n)	(m,n)	(m,n)	(m,n)	(m,n)	(m,n)	(m,n)	(m,n)	(m,n)	(m,n)	(m,n)
\$1x	(m,n)	(m,n)	(m,n)	(m,n)	(m,n)	(m,n)	(m,n)	(m,n)	(m,n)	(m,n)	(m,n)	(m,n)	(m,n)	(m,n)	(m,n)
\$2x	(m,n)	(m,n)	(m,n)	(m,n)	(m,n)	(m,n)	(m,n)	(m,n)	(m,n)	(m,n)	(m,n)	(m,n)	(m,n)	(m,n)	(m,n)
\$3x	(m,n)	(m,n)	(m,n)	(m,n)	(m,n)	(m,n)	(m,n)	(m,n)	(m,n)	(m,n)	(m,n)	(m,n)	(m,n)	(m,n)	(m,n)
\$4x	(m,n)	(m,n)	(m,n)	(m,n)	(m,n)	(m,n)	(m,n)	(m,n)	(m,n)	(m,n)	(m,n)	(m,n)	(m,n)	(m,n)	(m,n)
\$5x	(m,n)	(m,n)	(m,n)	(m,n)	(m,n)	(m,n)	(m,n)	(m,n)	(m,n)	(m,n)	(m,n)	(m,n)	(m,n)	(m,n)	(m,n)
\$6x	(m,n)	(m,n)	(m,n)	(m,n)	(m,n)	(m,n)	(m,n)	(m,n)	(m,n)	(m,n)	(m,n)	(m,n)	(m,n)	(m,n)	(m,n)
\$7x	(m,n)	(m,n)	(m,n)	(m,n)	(m,n)	(m,n)	(m,n)	(m,n)	(m,n)	(m,n)	(m,n)	(m,n)	(m,n)	(m,n)	(m,n)
\$8x	(m,n)	(m,n)	(m,n)	(m,n)	(m,n)	(m,n)	(m,n)	(m,n)	(m,n)	(m,n)	(m,n)	(m,n)	(m,n)	(m,n)	(m,n)
\$9x	(m,n)	(m,n)	(m,n)	(m,n)	(m,n)	(m,n)	(m,n)	(m,n)	(m,n)	(m,n)	(m,n)	(m,n)	(m,n)	(m,n)	(m,n)
\$Ax	(m,n)	(m,n)	(m,n)	(m,n)	(m,n)	(m,n)	(m,n)	(m,n)	(m,n)	(m,n)	(m,n)	(m,n)	(m,n)	(m,n)	(m,n)
\$Bx	(m,n)	(m,n)	(m,n)	(m,n)	(m,n)	(m,n)	(m,n)	(m,n)	(m,n)	(m,n)	(m,n)	(m,n)	(m,n)	(m,n)	(m,n)
\$Cx	(m,n)	(m,n)	(m,n)	(m,n)	(m,n)	(m,n)	(m,n)	(m,n)	(m,n)	(m,n)	(m,n)	(m,n)	(m,n)	(m,n)	(m,n)
\$Dx	(m,n)	(m,n)	(m,n)	(m,n)	(m,n)	(m,n)	(m,n)	(m,n)	(m,n)	(m,n)	(m,n)	(m,n)	(m,n)	(m,n)	(m,n)
\$Ex	(m,n)	(m,n)	(m,n)	(m,n)	(m,n)	(m,n)	(m,n)	(m,n)	(m,n)	(m,n)	(m,n)	(m,n)	(m,n)	(m,n)	(m,n)
\$Fx	(m,n)	(m,n)	(m,n)	(m,n)	(m,n)	(m,n)	(m,n)	(m,n)	(m,n)	(m,n)	(m,n)	(m,n)	(m,n)	(m,n)	(m,n)

Official And Unintended Instructions

The 6502 opcode matrix has a size of $16 \times 16 = 256$ possible opcodes. Those, that are officially documented, form the set of the **legal** instructions. All instructions of this legal set are headed by a blue coloured mnemonic.

The remaining opcodes form the set of the **unintended** instructions (sometimes called "illegal" instructions). For the sake of completeness these are documented too. All instructions of the unintended set are headed by a red coloured mnemonic.

The unintended instructions are implemented in the 6502 mode, but are not guaranteed to produce exactly the same results as on other CPU's of the 65xx family. Many of these instructions are known to be unstable, even running on old hardware.

ADC

This instruction adds the argument to the contents of the Accumulator Register and the Carry Flag. If the D flag is set, then the addition is performed using Binary Coded Decimal.

Side effects

- The N flag will be set if the result is negative, else it will be cleared.
- The Z flag will be set if the result is zero, else it will be cleared.
- The V flag will be set if the result has a different sign to both of the arguments, else it will be cleared. If the flag is set, this indicates that a signed overflow has occurred.
- The C flag will be set if the unsigned result is >255, or >99 if the D flag is set.

ADC : Add with carry			6502		
A ← A+M+C					
NZ I CDV E + + · + · + ·					
Addressing Mode	Assembly	Code	Bytes	Cycles	
(indirect),X	ADC (\$nn,X)	61	2	6	
zero-page	ADC \$nn	65	2	3	
immediate	ADC #\$nn	69	2	2	
absolute	ADC \$nnnn	6D	3	4	
(indirect),Y	ADC (\$nn),Y	71	2	5	<i>p</i>
zero-page,X	ADC \$nn,X	75	2	4	
absolute,Y	ADC \$nnnn,Y	79	3	4	<i>p</i>
absolute,X	ADC \$nnnn,X	7D	3	4	<i>p</i>

*p*Add one cycle if indexing crosses a page boundary.

ALR [unintended]

This instruction shifts the Accumulator one bit right after performing a binary AND of the Accumulator and the immediate mode argument. Bit 7 will be set to zero, and the bit 0 will be shifted out into the Carry Flag

Side effects

- The N flag will be set if the result is negative, i.e., if bit 7 is set after the operation, else it will be cleared.
- The Z flag will be set if the result is zero, else it will be cleared.
- The C flag will be set if bit 0 of the value was set, prior to being shifted.

ALR : Binary AND and Logical Shift Right		6502	
$A \leftarrow (A \text{ AND Value}) \gg 1, C \leftarrow A(0)$			
NZ I CDV E ++ . + . . .			
Addressing Mode	AssemblyCode	Bytes	Cycles
immediate	ALR #\$nn	4B	2 2

ANC [unintended]

This instructions performs a binary AND operation of the argument with the accumulator, and stores the result in the accumulator. Only bits that were already set in the accumulator, and that are set in the argument will be set in the accumulator on completion. Unlike the AND instruction, the Carry Flag is set as though the result were shifted left one bit. That is, the Carry Flag is set in the same way as the Negative Flag.

Side effects

- The N flag will be set if the result is negative, else it will be cleared.
- The C flag will be set if the result is negative, else it will be cleared.
- The Z flag will be set if the result is zero, else it will be cleared.

ANC : Binary AND, and Set Carry		6502	
$A \leftarrow A \text{ AND } M, C \leftarrow A7 \text{ AND } M7$			
NZ I CDV E ++			
Addressing Mode	AssemblyCode	Bytes	Cycles
immediate	ANC #\$nn	0B	2 2
immediate	ANC #\$nn	2B	2 2

AND

This instructions performs a binary AND operation of the argument with the accumulator, and stores the result in the accumulator. Only bits that were already set in the accumulator, and that are set in the argument will be set in the accumulator on completion.

Side effects

- The N flag will be set if the result is negative, else it will be cleared.
- The Z flag will be set if the result is zero, else it will be cleared.

AND : Binary AND		6502		
$A \leftarrow A \text{ AND } M$				
		NZ I CDV E		
		++		
Addressing Mode	Assembly	Code	Bytes	Cycles
(indirect,X)	AND (\$nn,X)	21	2	6
zero-page	AND \$nn	25	2	3
immediate	AND #\$nn	29	2	2
absolute	AND \$nnnn	2D	3	4
(indirect),Y	AND (\$nn),Y	31	2	5 ^p
zero-page,X	AND \$nn,X	35	2	4
absolute,Y	AND \$nnnn,Y	39	3	4 ^p
absolute,X	AND \$nnnn,X	3D	3	4 ^p

^pAdd one cycle if indexing crosses a page boundary.

ARR [unintended]

This instruction shifts the Accumulator one bit right after performing a binary AND of the Accumulator and the immediate mode argument. Bit 7 is exchanged with the carry.

Side effects

- The N flag will be set if the result is negative, i.e., if bit 7 is set after the operation, else it will be cleared.
- The Z flag will be set if the result is zero, else it will be cleared.
- The V flag will be apparently be affected in some way.

- The C flag will be set if bit 7 of the value was set, prior to being shifted.

ARR : Binary AND and Rotate Right		6502		
$A \leftarrow (A \text{ AND Value}) \gg 1, C \leftarrow A(7)$				
NZ I CDV E				
++ · + · + ·				
Addressing Mode	Assembly	Code	Bytes	Cycles
immediate	ARR #\$nn	6B	2	2

ASL

This instruction shifts either the Accumulator or contents of the provided memory location one bit left. Bit 0 will be set to zero, and the bit 7 will be shifted out into the Carry Flag

Side effects

- The N flag will be set if the result is negative, i.e., if bit 7 is set after the operation, else it will be cleared.
- The Z flag will be set if the result is zero, else it will be cleared.
- The C flag will be set if bit 7 of the value was set, prior to being shifted.

ASL : Arithmetic Shift Left		6502		
$A \leftarrow A \ll 1 \text{ or } M \leftarrow M \ll 1$				
NZ I CDV E				
++ · + · · ·				
Addressing Mode	Assembly	Code	Bytes	Cycles
zero-page	ASL \$nn	06	2	5
accumulator	ASL A	0A	1	2
absolute	ASL \$nnnn	0E	3	6
zero-page,X	ASL \$nn,X	16	2	6
absolute,X	ASL \$nnnn,X	1E	3	7

BCC

This instruction branches to the indicated address if the Carry Flag is clear.

BCC : Branch on Carry Flag Clear					6502
PC ← PC + R8					
NZ I CDV E					
Addressing Mode	AssemblyCode	Bytes	Cycles		
relative	BCC \$rr	90	2	2	^b

^bAdd one cycle if branch is taken.

Add one more cycle if branch taken crosses a page boundary.

BCS

This instruction branches to the indicated address if the Carry Flag is set.

BCS : Branch on Carry Flag Set					6502
PC ← PC + R8					
NZ I CDV E					
Addressing Mode	AssemblyCode	Bytes	Cycles		
relative	BCS \$rr	B0	2	2	^b

^bAdd one cycle if branch is taken.

Add one more cycle if branch taken crosses a page boundary.

BEQ

This instruction branches to the indicated address if the Zero Flag is set.

BEQ : Branch on Zero Flag Set					6502
PC ← PC + R8					
NZ I CDV E					
Addressing Mode	AssemblyCode	Bytes	Cycles		
relative	BEQ \$rr	F0	2	2	^b

^bAdd one cycle if branch is taken.

Add one more cycle if branch taken crosses a page boundary.

BIT

This instruction is used to test the bits stored in a memory location. Bits 6 and 7 of the memory location's contents are directly copied into the Overflow Flag and Negative Flag. The Zero Flag is set or cleared based on the result of performing the binary AND of the Accumulator Register and the contents of the indicated memory location.

Side effects

- The N flag will be set if the bit 7 of the memory location is set, else it will be cleared.
- The V flag will be set if the bit 6 of the memory location is set, else it will be cleared.
- The Z flag will be set if the result of $A \text{ AND } M$ is zero, else it will be cleared.

BIT : Perform Bit Test		6502		
$N \leftarrow M(7), V \leftarrow M(6), Z \leftarrow A \text{ AND } M$				
		NZ I CDV E		
		++ . . . + .		
Addressing Mode	AssemblyCode	Bytes	Cycles	
zero-page	BIT \$nn	24	2	3
absolute	BIT \$nnnn	2C	3	4

BMI

This instruction branches to the indicated address if the Negative Flag is set.

BMI : Branch on Negative Flag Set		6502		
$PC \leftarrow PC + R8$				
		NZ I CDV E		
			
Addressing Mode	AssemblyCode	Bytes	Cycles	
relative	BMI \$rr	30	2	2 ^b

^bAdd one cycle if branch is taken.

Add one more cycle if branch taken crosses a page boundary.

BNE

This instruction branches to the indicated address if the Zero Flag is clear.

BNE : Branch on Zero Flag Clear				6502
PC ← PC + R8				
NZ I CDV E				
Addressing Mode	AssemblyCode	Bytes	Cycles	
relative	BNE \$rr	D0	2	2 ^b

^bAdd one cycle if branch is taken.

Add one more cycle if branch taken crosses a page boundary.

BPL

This instruction branches to the indicated address if the Negative Flag is clear.

BPL : Branch on Negative Flag Clear				6502
PC ← PC + R8				
NZ I CDV E				
Addressing Mode	AssemblyCode	Bytes	Cycles	
relative	BPL \$rr	10	2	2 ^b

^bAdd one cycle if branch is taken.

Add one more cycle if branch taken crosses a page boundary.

BRK

The break command causes the microprocessor to go through an interrupt sequence under program control. The address of the BRK instruction + 2 is pushed to the stack along with the status register with the Break flag set. This allows the interrupt service routine to distinguish between IRQ events and BRK events. For example:

```

PLA          ; load status
PHA          ; restore stack
AND #$10    ; mask break flag
BNE DO_BREAK ; -> it was a BRK
...         ; else continue with IRQ server

```

Cite from: MCS6500 Microcomputer Family Programming Manual, January 1976, Second Edition, MOS Technology Inc., Page 144:

"The BRK is a single byte instruction and its addressing mode is Implied."

There are debates, that BRK could be seen as a two byte instruction with the addressing mode immediate, where the operand byte is discarded. The byte following the BRK could then be used as a call argument for the break handler. Commodore however used the BRK, as stated in the manual, as a single byte instruction, which breaks into the ML monitor, if present. These builtin monitors decremented the stacked PC, so that it could be used to return or jump directly to the code byte after the BRK.

BRK : Break to Interrupt		6502		
PC ← (\$FFFE)				
NZ I CDV E				
.				
Addressing Mode	AssemblyCode	Bytes	Cycles	
implied	BRK	00	1	7

BVC

This instruction branches to the indicated address if the Overflow (V) Flag is clear.

BVC : Branch on Overflow Flag Clear		6502		
PC ← PC + R8				
NZ I CDV E				
.				
Addressing Mode	AssemblyCode	Bytes	Cycles	
relative	BVC \$rr	50	2	2 ^b

^bAdd one cycle if branch is taken.

Add one more cycle if branch taken crosses a page boundary.

BVS

This instruction branches to the indicated address if the Overflow (V) Flag is set.

BVS : Branch on Overflow Flag Set		6502		
PC ← PC + R8				
NZ I CDV E				
.				
Addressing Mode	AssemblyCode	Bytes	Cycles	
relative	BVS \$rr	70	2	2 ^b

^bAdd one cycle if branch is taken.

Add one more cycle if branch taken crosses a page boundary.

CLC

This instruction clears the Carry Flag.

Side effects

- The C flag is cleared.

CLC : Clear Carry Flag		6502		
C ← 0				
NZ I CDV E				
.				
Addressing Mode	AssemblyCode	Bytes	Cycles	
implied	CLC	18	1	2

CLD

This instruction clears the Decimal Flag. Arithmetic operations will use normal binary arithmetic, instead of Binary-Coded Decimal (BCD).

Side effects

- The D flag is cleared.

CLD : Clear Decimal Flag		6502		
D ← 0				
NZ I CDV E				
.				
Addressing Mode	AssemblyCode	Bytes	Cycles	
implied	CLD	D8	1	2

CLI

This instruction clears the Interrupt Disable Flag. Interrupts will now be able to occur.

Side effects

- The I flag is cleared.

CLI : Clear Interrupt Disable Flag		6502		
I ← 0		NZ I CDV E		
Addressing Mode	AssemblyCode	Bytes	Cycles	
implied	CLI	58	1	2

CLV

This instruction clears the Overflow Flag.

Side effects

- The V flag is cleared.

CLV : Clear Overflow Flag		6502		
V ← 0		NZ I CDV E		
Addressing Mode	AssemblyCode	Bytes	Cycles	
implied	CLV	B8	1	2

CMP

This instruction performs $A - M$, and sets the processor flags accordingly, but does not modify the contents of the Accumulator Register.

Side effects

- The N flag will be set if the result of $A - M$ is negative, i.e. bit 7 is set in the result, else it will be cleared.

- The C flag will be set if the result of $A - M$ is zero or positive, i.e., if A is not less than M , else it will be cleared.
- The Z flag will be set if the result of $A - M$ is zero, else it will be cleared.

CMP : Compare Accumulator		6502			
			NZ I CDV E		
			++ · + · · ·		
Addressing Mode	Assembly	Code	Bytes	Cycles	
(indirect,X)	CMP (\$nn,X)	C1	2	6	
zero-page	CMP \$nn	C5	2	3	
immediate	CMP #\$nn	C9	2	2	
absolute	CMP \$nnnn	CD	3	4	
(indirect),Y	CMP (\$nn),Y	D1	2	5	<i>p</i>
zero-page,X	CMP \$nn,X	D5	2	4	
absolute,Y	CMP \$nnnn,Y	D9	3	4	<i>p</i>
absolute,X	CMP \$nnnn,X	DD	3	4	<i>p</i>

*p*Add one cycle if indexing crosses a page boundary.

CPX

This instruction performs $X - M$, and sets the processor flags accordingly, but does not modify the contents of the Accumulator Register.

Side effects

- The N flag will be set if the result of $X - M$ is negative, i.e. bit 7 is set in the result, else it will be cleared.
- The C flag will be set if the result of $X - M$ is zero or positive, i.e., if X is not less than M , else it will be cleared.
- The Z flag will be set if the result of $X - M$ is zero, else it will be cleared.

CPX : Compare X Register		6502		
			NZ I CDV E	
			++ · + · · ·	
Addressing Mode	Assembly Code	Bytes	Cycles	
immediate	CPX #\$nn	E0	2	2
zero-page	CPX \$nn	E4	2	3
absolute	CPX \$nnnn	EC	3	4

CPY

This instruction performs $Y - M$, and sets the processor flags accordingly, but does not modify the contents of the Accumulator Register.

Side effects

- The N flag will be set if the result of $Y - M$ is negative, i.e. bit 7 is set in the result, else it will be cleared.
- The C flag will be set if the result of $Y - M$ is zero or positive, i.e., if Y is not less than M, else it will be cleared.
- The Z flag will be set if the result of $Y - M$ is zero, else it will be cleared.

CPY : Compare Y Register		6502		
			NZ I CDV E	
			++ · + · · ·	
Addressing Mode	Assembly Code	Bytes	Cycles	
immediate	CPY #\$nn	C0	2	2
zero-page	CPY \$nn	C4	2	3
absolute	CPY \$nnnn	CC	3	4

DCP [unintended]

This instruction decrements the contents of the indicated memory location, and then performs $A - M$, and sets the processor flags accordingly, but does not modify the contents of the Accumulator Register.

Side effects

- The N flag will be set if the result of $A - M$ is negative, i.e. bit 7 is set in the result, else it will be cleared.
- The C flag will be set if the result of $A - M$ is zero or positive, i.e., if A is not less than M, else it will be cleared.
- The Z flag will be set if the result of $A - M$ is zero, else it will be cleared.

DCP : Decrement and Compare Accumulator		6502		
$M \leftarrow M - 1, A - M$				
NZ I CDV E ++ · + · · ·				
Addressing Mode	Assembly	Code	Bytes	Cycles
(indirect,X)	DCP (\$nn,X)	C3	2	8
zero-page	DCP \$nn	C7	2	5
absolute	DCP \$nnnn	CF	3	6
(indirect),Y	DCP (\$nn),Y	D3	2	8
zero-page,X	DCP \$nn,X	D7	2	6
absolute,Y	DCP \$nnnn,Y	DB	3	7
absolute,X	DCP \$nnnn,X	DF	3	7

DEC

This instruction decrements the Accumulator Register or indicated memory location.

Side effects

- The N flag will be set if the result is negative, else it will be cleared.
- The Z flag will be set if the result is zero, else it will be cleared.

DEC : Decrement Memory or Accumulator		6502		
$A \leftarrow A - 1$ or $M \leftarrow M - 1$				
NZ I CDV E ++ · · · · ·				
Addressing Mode	Assembly	Code	Bytes	Cycles
zero-page	DEC \$nn	C6	2	5
absolute	DEC \$nnnn	CE	3	6
zero-page,X	DEC \$nn,X	D6	2	6
absolute,X	DEC \$nnnn,X	DE	3	7

DEX

This instruction decrements the X Register.

Side effects

- The N flag will be set if the result is negative, else it will be cleared.
- The Z flag will be set if the result is zero, else it will be cleared.

DEX : Decrement X Register		6502	
$X \leftarrow X - 1$			
		NZ I CDV E	
		++	
Addressing Mode	AssemblyCode	Bytes	Cycles
implied	DEX	CA	1 2

DEY

This instruction decrements the Y Register.

Side effects

- The N flag will be set if the result is negative, else it will be cleared.
- The Z flag will be set if the result is zero, else it will be cleared.

DEY : Decrement Y Register		6502	
$Y \leftarrow Y - 1$			
		NZ I CDV E	
		++	
Addressing Mode	AssemblyCode	Bytes	Cycles
implied	DEY	88	1 2

EOR

This instructions performs a binary XOR operation of the argument with the accumulator, and stores the result in the accumulator. Only bits that were already set in the accumulator, or that are set in the argument will be set in the accumulator on completion, but not both.

Side effects

- The N flag will be set if the result is negative, else it will be cleared.
- The Z flag will be set if the result is zero, else it will be cleared.

EOR : Binary Exclusive OR		6502		
$A \leftarrow A \text{ XOR } M$				
NZ I CDV E				
++				
Addressing Mode	Assembly	Code	Bytes	Cycles
(indirect,X)	EOR (\$nn,X)	41	2	6
zero-page	EOR \$nn	45	2	3
immediate	EOR #\$nn	49	2	2
absolute	EOR \$nnnn	4D	3	4
(indirect),Y	EOR (\$nn),Y	51	2	5 ^p
zero-page,X	EOR \$nn,X	55	2	4
absolute,Y	EOR \$nnnn,Y	59	3	4 ^p
absolute,X	EOR \$nnnn,X	5D	3	4 ^p

^pAdd one cycle if indexing crosses a page boundary.

INC

This instruction increments the Accumulator Register or indicated memory location.

Side effects

- The N flag will be set if the result is negative, else it will be cleared.
- The Z flag will be set if the result is zero, else it will be cleared.

INC : Increment Memory or Accumulator		6502		
$A \leftarrow A + 1 \text{ or } M \leftarrow M + 1$				
NZ I CDV E				
++				
Addressing Mode	Assembly	Code	Bytes	Cycles
zero-page	INC \$nn	E6	2	5
absolute	INC \$nnnn	EE	3	6
zero-page,X	INC \$nn,X	F6	2	6
absolute,X	INC \$nnnn,X	FE	3	7

INX

This instruction increments the X Register, i.e., adds 1 to it.

Side effects

- The N flag will be set if the result is negative, else it will be cleared.
- The Z flag will be set if the result is zero, else it will be cleared.

INX : Increment X Register		6502		
$X \leftarrow X + 1$				
		NZ I CDV E		
		++		
Addressing Mode	AssemblyCode	Bytes	Cycles	
implied	INX	E8	1	2

INY

This instruction increments the Y Register, i.e., adds 1 to it.

Side effects

- The N flag will be set if the result is negative, else it will be cleared.
- The Z flag will be set if the result is zero, else it will be cleared.

INY : Increment Y Register		6502		
$Y \leftarrow Y + 1$				
		NZ I CDV E		
		++		
Addressing Mode	AssemblyCode	Bytes	Cycles	
implied	INY	C8	1	2

ISC [unintended]

This instruction increments the indicated memory location, and then performs $A - M - 1 + C$, and sets the processor flags accordingly. The result is stored in the Accumulator Register.

NOTE: This instruction is affected by the status of the Decimal Flag.

Side effects

- The N flag will be set if the result of $A - M$ is negative, i.e. bit 7 is set in the result, else it will be cleared.
- The C flag will be set if the result of $A - M$ is zero or positive, i.e., if A is not less than M , else it will be cleared.
- The V flag will be set if the result has a different sign to both of the arguments, else it will be cleared. If the flag is set, this indicates that a signed overflow has occurred.
- The Z flag will be set if the result of $A - M$ is zero, else it will be cleared.

ISC : Increment Memory, Subtract With Carry 6502				
$M \leftarrow M+1, A \leftarrow -M - 1 + C$				
NZ I CDV E				
+ + · + · + ·				
Addressing Mode	Assembly	Code	Bytes	Cycles
(indirect),X	ISC (\$nn,X)	E3	2	8
zero-page	ISC \$nn	E7	2	5
absolute	ISC \$nnnn	EF	3	6
(indirect),Y	ISC (\$nn),Y	F3	2	8
zero-page,X	ISC \$nn,X	F7	2	6
absolute,Y	ISC \$nnnn,Y	FB	3	7
absolute,X	ISC \$nnnn,X	FF	3	7

JMP

This instruction sets the Program Counter (PC) Register to the address indicated by the instruction, causing execution to continue from that address.

JMP : Jump to Address 6502				
$PC \leftarrow M2:M1$				
NZ I CDV E				
· · · · ·				
Addressing Mode	Assembly	Code	Bytes	Cycles
absolute	JMP \$nnnn	4C	3	3
indirect	JMP (\$nnnn)	6C	3	5

JSR

This instruction saves the address of the instruction following the JSR instruction onto the stack, and then sets the Program Counter (PC) Register to the address indicated by the instruction, causing execution to continue from that address. Because the return address has been saved on the stack, the RTS instruction can be used to return from the called sub-routine and resume execution following the JSR instruction.

NOTE: This instruction actually pushes the address of the last byte of the JSR instruction onto the stack. The RTS instruction naturally is aware of this, and increments the address on popping it from the stack, before setting the Program Counter (PC) register.

JSR : Jump to Sub-Routine		6502		
PC ← M2:M1, Stack ← PCH:PCL				
NZ I CDV E				
Addressing Mode	AssemblyCode	Bytes	Cycles	
absolute	JSR \$nnnn	20	3	6

KIL [unintended]

On a 6502, these instructions cause the processor to enter an infinite loop in their internal logic that can only be aborted by resetting the computer. On the 45GS02 these instructions cause Hypervisor Traps. Or rather, they will, once this functionality has been implemented. Thus they can be used to detect whether running on a 6502 or a 45GS02: If on a 6502 processor, the instruction will never return, while they will cause an exception on a 45GS02, likely causing the calling program to be aborted or crash.

KIL : Lock-up 6502 Processor		6502		
			NZ I CDV E	
			
Addressing Mode	AssemblyCode	Bytes	Cycles	
implied	KIL	02	1	9
implied	KIL	12	1	9
implied	KIL	22	1	9
implied	KIL	32	1	9
implied	KIL	42	1	9
implied	KIL	52	1	9
implied	KIL	62	1	9
implied	KIL	72	1	9
implied	KIL	92	1	9
implied	KIL	B2	1	9
implied	KIL	D2	1	9
implied	KIL	F2	1	9

LAS [unintended]

NOTE: This monstrosity of an instruction, aside from being devoid of any conceivable useful purpose is unstable on many 6502 processors and should therefore also be avoided for that reason, if you had not already been put off.

Side effects

- The N flag will be set if the result is negative, else it will be cleared.
- The Z flag will be set if the result is zero, else it will be cleared.
- A feeling of hollow satisfaction, when you actually discover a useful purpose for this instruction. exactly how it works.

LAS : Set A, X and SPL Register With Useless Value		6502		
SP, A, X ← SP AND M			NZ I CD VE	
			
Addressing Mode	Assembly	Code	Bytes	Cycles
absolute,Y	LAS \$nnnn,Y	BB	3	4 ^p

^pAdd one cycle if indexing crosses a page boundary.

LAX [unintended]

This instruction loads both the Accumulator Register and X Register with the indicated value, or with the contents of the indicated location.

NOTE: The LAX instruction is known to be unstable on many 6502 processors, and should not be used. Non-immediate modes MAY be stable enough to be usable, but should generally be avoided.

Side effects

- The N flag will be set if the result is negative, else it will be cleared.
- The Z flag will be set if the result is zero, else it will be cleared.

LAX : Load Accumulator and X Registers			6502		
A, X ← M			NZ I CDV E		
			++		
Addressing Mode	Assembly	Code	Bytes	Cycles	
(indirect,X)	LAX (\$nn,X)	A3	2	6	
zero-page	LAX \$nn	A7	2	3	
immediate	LAX #\$nn	AB	2	2	
absolute	LAX \$nnnn	AF	3	4	
(indirect),Y	LAX (\$nn),Y	B3	2	5	<i>p</i>
zero-page,Y	LAX \$nn,Y	B7	2	4	
absolute,Y	LAX \$nnnn,Y	BF	3	4	<i>p</i>

*p*Add one cycle if indexing crosses a page boundary.

LDA

This instruction loads the Accumulator Register with the indicated value, or with the contents of the indicated location.

Side effects

- The N flag will be set if the result is negative, else it will be cleared.
- The Z flag will be set if the result is zero, else it will be cleared.

LDA : Load Accumulator		6502		
A ← M				
NZ I CDV E				
++				
Addressing Mode	Assembly	Code	Bytes	Cycles
(indirect),X	LDA (\$nn,X)	A1	2	6
zero-page	LDA \$nn	A5	2	3
immediate	LDA #\$nn	A9	2	2
absolute	LDA \$nnnn	AD	3	4
(indirect),Y	LDA (\$nn),Y	B1	2	5 ^p
zero-page,X	LDA \$nn,X	B5	2	4
absolute,Y	LDA \$nnnn,Y	B9	3	4 ^p
absolute,X	LDA \$nnnn,X	BD	3	4 ^p

^pAdd one cycle if indexing crosses a page boundary.

LDX

This instruction loads the X Register with the indicated value, or with the contents of the indicated location.

Side effects

- The N flag will be set if the result is negative, else it will be cleared.
- The Z flag will be set if the result is zero, else it will be cleared.

LDX : Load X Register		6502		
X ← M				
NZ I CDV E				
++				
Addressing Mode	Assembly	Code	Bytes	Cycles
immediate	LDX #\$nn	A2	2	2
zero-page	LDX \$nn	A6	2	3
absolute	LDX \$nnnn	AE	3	4
zero-page,Y	LDX \$nn,Y	B6	2	4
absolute,Y	LDX \$nnnn,Y	BE	3	4 ^p

^pAdd one cycle if indexing crosses a page boundary.

LDY

This instruction loads the Y Register with the indicated value, or with the contents of the indicated location.

Side effects

- The N flag will be set if the result is negative, else it will be cleared.
- The Z flag will be set if the result is zero, else it will be cleared.

LDY : Load Y Register		6502		
Y ← M		NZ I CDV E		
		++		
Addressing Mode	Assembly	Code	Bytes	Cycles
immediate	LDY #\$nn	A0	2	2
zero-page	LDY \$nn	A4	2	3
absolute	LDY \$nnnn	AC	3	4
zero-page,X	LDY \$nn,X	B4	2	4
absolute,X	LDY \$nnnn,X	BC	3	4 ^p

^pAdd one cycle if indexing crosses a page boundary.

LSR

This instruction shifts either the Accumulator or contents of the provided memory location one bit right. Bit 7 will be set to zero, and the bit 0 will be shifted out into the Carry Flag

Side effects

- The N flag will be set if the result is negative, i.e., if bit 7 is set after the operation, else it will be cleared.
- The Z flag will be set if the result is zero, else it will be cleared.
- The C flag will be set if bit 0 of the value was set, prior to being shifted.

LSR : Logical Shift Right		6502		
$A \leftarrow A \gg 1, C \leftarrow A(0) \text{ or } M \leftarrow M \gg 1$				
NZ I CDV E				
++ · + · · ·				
Addressing Mode	Assembly	Code	Bytes	Cycles
zero-page	LSR \$nn	46	2	5
accumulator	LSR A	4A	1	2
absolute	LSR \$nnnn	4E	3	6
zero-page,X	LSR \$nn,X	56	2	6
absolute,X	LSR \$nnnn,X	5E	3	7

NOP

These instructions act as null instructions: They perform the bus accesses as though they were real instructions, but then do nothing with the retrieved value. They can thus be used either as delay instructions, or to read from registers that have side-effects when read, without corrupting a register.

Only \$EA is an intended opcode for NOP on the 6502. All others are only available on NMOS versions of the processor, or the 45GS02 in 6502 mode.

NOP : No-Operation (some are unintended opcodes)6502

NZ I CD VE

.

Addressing Mode	Assembly	Code	Bytes	Cycles	
zero-page	NOP \$nn	04	2	3	
absolute	NOP \$nnnn	0C	3	4	
zero-page,X	NOP \$nn,X	14	2	4	
implied	NOP	1A	1	2	
absolute,X	NOP \$nnnn,X	1C	3	4	<i>p</i>
zero-page,X	NOP \$nn,X	34	2	4	
implied	NOP	3A	1	2	
absolute,X	NOP \$nnnn,X	3C	3	4	<i>p</i>
zero-page	NOP \$nn	44	2	3	
zero-page,X	NOP \$nn,X	54	2	4	
implied	NOP	5A	1	2	
absolute,X	NOP \$nnnn,X	5C	3	4	<i>p</i>
zero-page	NOP \$nn	64	2	3	
zero-page,X	NOP \$nn,X	74	2	4	
implied	NOP	7A	1	2	
absolute,X	NOP \$nnnn,X	7C	3	4	<i>p</i>
immediate	NOP # \$nn	80	2	2	
immediate	NOP # \$nn	82	2	2	
immediate	NOP # \$nn	89	2	2	
immediate	NOP # \$nn	C2	2	2	
zero-page,X	NOP \$nn,X	D4	2	4	
implied	NOP	DA	1	2	
absolute,X	NOP \$nnnn,X	DC	3	4	<i>p</i>
immediate	NOP # \$nn	E2	2	2	
implied	NOP	EA	1	2	
zero-page,X	NOP \$nn,X	F4	2	4	
implied	NOP	FA	1	2	
absolute,X	NOP \$nnnn,X	FC	3	4	<i>p</i>

*p*Add one cycle if indexing crosses a page boundary.

ORA

This instructions performs a binary OR operation of the argument with the accumulator, and stores the result in the accumulator. Only bits that were already set in the accumulator, or that are set in the argument will be set in the accumulator on completion, or both.

Side effects

- The N flag will be set if the result is negative, else it will be cleared.
- The Z flag will be set if the result is zero, else it will be cleared.

ORA : Decrement Memory or Accumulator		6502		
$A \leftarrow A + 1$ or $M \leftarrow M + 1$				
NZ I CDV E				
++				
Addressing Mode	Assembly	Code	Bytes	Cycles
(indirect,X)	ORA (\$nn,X)	01	2	6
zero-page	ORA \$nn	05	2	3
immediate	ORA #\$nn	09	2	2
absolute	ORA \$nnnn	0D	3	4
(indirect),Y	ORA (\$nn),Y	11	2	5 ^p
zero-page,X	ORA \$nn,X	15	2	4 ^p
absolute,Y	ORA \$nnnn,Y	19	3	4 ^p
absolute,X	ORA \$nnnn,X	1D	3	4 ^p

^pAdd one cycle if indexing crosses a page boundary.

PHA

This instruction pushes the contents of the Accumulator Register onto the stack, and decrements the value of the Stack Pointer by 1.

PHA : Push Accumulator Register onto the Stack		6502		
$STACK \leftarrow A, SP \leftarrow SP - 1$				
NZ I CD VE				
.				
Addressing Mode	Assembly	Code	Bytes	Cycles
implied	PHA	48	1	3

PHP

This instruction pushes the contents of the Processor Flags onto the stack, and decrements the value of the Stack Pointer by 1.

PHP : Push Processor Flags onto the Stack		6502	
STACK ← P, SP ← SP - 1			
NZ I CDV E			
Addressing Mode	AssemblyCode	Bytes	Cycles
implied	PHP	08	1 3

PLA

This instruction replaces the contents of the Accumulator Register with the top value from the stack, and increments the value of the Stack Pointer by 1.

PLA : Pull Accumulator Register from the Stack		6502	
A ← STACK, SP ← SP + 1			
NZ I CD V E ++			
Addressing Mode	AssemblyCode	Bytes	Cycles
implied	PLA	68	1 4

PLP

This instruction replaces the contents of the Processor Flags with the top value from the stack, and increments the value of the Stack Pointer by 1.

NOTE: This instruction does NOT replace the Extended Stack Disable Flag (E Flag), or the Software Interrupt Flag (B Flag)

PLP : Pull Processor Flags from the Stack		6502	
A ← STACK, SP ← SP + 1			
NZ I CDV E +++ +++ + .			
Addressing Mode	AssemblyCode	Bytes	Cycles
implied	PLP	28	1 4

RLA [unintended]

This instruction shifts the contents of the provided memory location one bit left. Bit 0 will be set to the current value of the Carry Flag, and the bit 7 will be shifted out into the Carry Flag. The result is then ANDed with the Accumulator.

Side effects

- The N flag will be set if the result is negative, i.e., if bit 7 is set after the operation, else it will be cleared.
- The Z flag will be set if the result is zero, else it will be cleared.
- The C flag will be set if bit 7 of the value was set, prior to being shifted.

RLA : Rotate Left Memory, and AND with Accumulator				
$M \leftarrow M \ll 1, C \leftarrow M(7), M(0) \leftarrow C, A \leftarrow A \text{ AND } M \ll 1$				
			NZ I CD	VE
			++ · +	· ·
Addressing Mode	Assembly	Code	Bytes	Cycles
(indirect),X	RLA (\$nn,X)	23	2	8
zero-page	RLA \$nn	27	2	5
absolute	RLA \$nnnn	2F	3	6
(indirect),Y	RLA (\$nn),Y	33	2	8
zero-page,X	RLA \$nn,X	37	2	6
absolute,Y	RLA \$nnnn,Y	3B	3	7
absolute,X	RLA \$nnnn,X	3F	3	7

ROL

This instruction shifts either the Accumulator or contents of the provided memory location one bit left. Bit 0 will be set to the current value of the Carry Flag, and the bit 7 will be shifted out into the Carry Flag.

Side effects

- The N flag will be set if the result is negative, i.e., if bit 7 is set after the operation, else it will be cleared.
- The Z flag will be set if the result is zero, else it will be cleared.
- The C flag will be set if bit 7 of the value was set, prior to being shifted.

ROL : Rotate Left Memory or Accumulator		6502		
$M \leftarrow M \ll 1, C \leftarrow M(7), M(0) \leftarrow C$				
NZ I CDV E ++ · + · · ·				
Addressing Mode	Assembly	Code	Bytes	Cycles
zero-page	ROL \$nn	26	2	5
accumulator	ROL A	2A	1	2
absolute	ROL \$nnnn	2E	3	6
zero-page,X	ROL \$nn,X	36	2	6
absolute,X	ROL \$nnnn,X	3E	3	7

ROR

This instruction shifts either the Accumulator or contents of the provided memory location one bit right. Bit 7 will be set to the current value of the Carry Flag, and the bit 0 will be shifted out into the Carry Flag

Side effects

- The N flag will be set if the result is negative, i.e., if bit 7 is set after the operation, else it will be cleared.
- The Z flag will be set if the result is zero, else it will be cleared.
- The C flag will be set if bit 7 of the value was set, prior to being shifted.

ROR : Rotate Right Memory or Accumulator		6502		
$M \leftarrow M \gg 1, C \leftarrow M(0), M(7) \leftarrow C$				
NZ I CDV E ++ · + · · ·				
Addressing Mode	Assembly	Code	Bytes	Cycles
zero-page	ROR \$nn	66	2	5
accumulator	ROR A	6A	1	2
absolute	ROR \$nnnn	6E	3	6
zero-page,X	ROR \$nn,X	76	2	6
absolute,X	ROR \$nnnn,X	7E	3	7

RRA [unintended]

This instruction shifts either the contents of the provided memory location one bit right. Bit 7 will be set to the current value of the Carry Flag, and the bit 0 will be shifted out into the Carry Flag. The result is added to the Accumulator.

Side effects

- The N flag will be set if the result is negative, i.e., if bit 7 is set after the operation, else it will be cleared.
- The Z flag will be set if the result is zero, else it will be cleared.
- The C flag will be set if the addition results in an overflow in the Accumulator.

RRA : Rotate Right Memory, and Add to Accumulator 6502				
$M \leftarrow M \gg 1, C \leftarrow M(0), M(7) \leftarrow C, A \leftarrow A + M \gg 1 + C$				
NZ I CD VE				
+ + · + · · ·				
Addressing Mode	Assembly	Code	Bytes	Cycles
(indirect),X	RRA (\$nn,X)	63	2	8
zero-page	RRA \$nn	67	2	5
absolute	RRA \$nnnn	6F	3	6
(indirect),Y	RRA (\$nn),Y	73	2	8
zero-page,X	RRA \$nn,X	77	2	6
absolute,Y	RRA \$nnnn,Y	7B	3	7
absolute,X	RRA \$nnnn,X	7F	3	7

RTI

This instruction pops the processor flags from the stack, and then pops the Program Counter (PC) register from the stack, allowing an interrupted program to resume.

- The 6502 Processor Flags are restored from the stack.
- Neither the B (Software Interrupt) nor E (Extended Stack) flags are set by this instruction.

RTI : Return From Interrupt		6502	
P ← STACK, PC ← STACK, SP ← SP + 3			
NZ I CDV E + · + + + + ·			
Addressing Mode	AssemblyCode	Bytes	Cycles
implied	RTI	40	1 6

RTS

This instruction adds optional argument to the Stack Pointer (SP) Register, and then pops the Program Counter (PC) register from the stack, allowing a routine to return to its caller.

RTS : Return From Subroutine		6502	
PC ← STACK + N, SP ← SP + 2 + N			
NZ I CDV E · · · · · · · ·			
Addressing Mode	AssemblyCode	Bytes	Cycles
implied	RTS	60	1 6

SAX [unintended]

This instruction acts as a combination of AND and CMP. The result is stored in the X Register. Because it includes functionality from CMP rather than SBC, the Carry Flag is not used in the subtraction, although it is modified by the instruction.

NOTE: This instruction is affected by the status of the Decimal Flag.

Side effects

- The N flag will be set if the result of A – M is negative, i.e. bit 7 is set in the result, else it will be cleared.
- The C flag will be set if the result of A – M is zero or positive, i.e., if A is not less than M, else it will be cleared.
- The V flag will be set if the result has a different sign to both of the arguments, else it will be cleared. If the flag is set, this indicates that a signed overflow has occurred.
- The Z flag will be set if the result of A – M is zero, else it will be cleared.

SAX : AND Accumulator and X, and Subtract Without Carry 6502 $X \leftarrow (A \text{ AND } X) - \text{Value}$

NZ	I	CD	VE
++	·	+	·

Addressing Mode	Assembly	Code	Bytes	Cycles
(indirect,X)	SAX (\$nn,X)	83	2	6
zero-page	SAX \$nn	87	2	3
absolute	SAX \$nnnn	8F	3	4
zero-page,Y	SAX \$nn,Y	97	2	4

SBC

This instruction performs $A - M - 1 + C$, and sets the processor flags accordingly. The result is stored in the Accumulator Register.

NOTE: This instruction is affected by the status of the Decimal Flag.

Side effects

- The N flag will be set if the result of $A - M$ is negative, i.e. bit 7 is set in the result, else it will be cleared.
- The C flag will be set if the result of $A - M$ is zero or positive, i.e., if A is not less than M, else it will be cleared.
- The V flag will be set if the result has a different sign to both of the arguments, else it will be cleared. If the flag is set, this indicates that a signed overflow has occurred.
- The Z flag will be set if the result of $A - M$ is zero, else it will be cleared.

SBC : Subtract With Carry		6502		
$A \leftarrow -M - 1 + C$				
NZ I CDV E				
++ · + · + ·				
Addressing Mode	Assembly	Code	Bytes	Cycles
(indirect),X	SBC (\$nn,X)	E1	2	6
zero-page	SBC \$nn	E5	2	3
immediate	SBC #\$nn	E9	2	2
immediate	SBC #\$nn	EB	2	2
absolute	SBC \$nnnn	ED	3	4
(indirect),Y	SBC (\$nn),Y	F1	2	5 ^p
zero-page,X	SBC \$nn,X	F5	2	4
absolute,Y	SBC \$nnnn,Y	F9	3	4 ^p
absolute,X	SBC \$nnnn,X	FD	3	4 ^p

^pAdd one cycle if indexing crosses a page boundary.

SBX [unintended]

This instruction loads the X Register with the binary AND of the Accumulator Register and X Register, less the immediate argument.

NOTE: The subtraction effect in this instruction is due to *CMP*, not *SBC*. Thus the Negative Flag is set according to the function of *CMP*, not *SBC*. That is, the carry flag is not used in the calculation.

Side effects

- The N flag will be set if the result is negative, else it will be cleared.
- The Z flag will be set if the result is zero, else it will be cleared.
- The C flag will be set if the result is zero or positive, else it will be cleared.

SBX : AND and Subtract		6502		
$X \leftarrow (A \text{ AND } X) - V$				
NZ I CDV E				
++ · · · · ·				
Addressing Mode	Assembly	Code	Bytes	Cycles
immediate	SBX #\$nn	CB	2	2

SEC

This instruction sets the Carry Flag.

Side effects

- The C flag is set.

SEC : Set Carry Flag		6502		
C ← 1		NZ I CDV E		
Addressing Mode	AssemblyCode	Bytes	Cycles	
implied	SEC	38	1	2

SED

This instruction sets the Decimal Flag. Binary arithmetic will now use Binary-Coded Decimal (BCD) mode.

NOTE: The C64's interrupt handler does not clear the Decimal Flag, which makes it dangerous to set the Decimal Flag without first setting the Interrupt Disable Flag.

Side effects

- The D flag is set.

SED : Set Decimal Flag		6502		
D ← 1		NZ I CDV E		
Addressing Mode	AssemblyCode	Bytes	Cycles	
implied	SED	F8	1	2

SEI

This instruction sets the Interrupt Disable Flag. Normal (IRQ) interrupts will no longer be able to occur. Non-Maskable Interrupts (NMI) will continue to occur, as their name suggests.

Side effects

- The I flag is set.

SEI : Set Interrupt Disable Flag		6502		
$I \leftarrow 1$				
NZ I CDV E				
Addressing Mode	Assembly	CodeBytes	Cycles	
implied	SEI	78	1	2

SHA [unintended]

NOTE: This instruction is unstable on many 6502 processors, and should be avoided.

This instruction stores the binary AND of the contents of the Accumulator Register, X Register and the third byte of the instruction into the indicated location.

SHA : Store binary AND of A, X and 3rd Instruction Byte		6502		
$M \leftarrow A \text{ AND } X \text{ AND } B3$				
NZ I CD VE				
Addressing Mode	Assembly	CodeBytes	Cycles	
(indirect),Y	SHA (\$nn),Y	93	2	6
absolute,Y	SHA \$nnnn,Y	9F	3	5

SHX [unintended]

NOTE: This instruction is unstable on many 6502 processors, and should be avoided.

This instruction stores the binary AND of the contents of the X Register and the third byte of the instruction into the indicated location.

SHX : Store Binary AND of X Register and 3rd Instruction Byte		6502		
$M \leftarrow X \text{ AND } B3$				
NZ I CD VE				
Addressing Mode	Assembly	CodeBytes	Cycles	
absolute,Y	SHX \$nnnn,Y	9E	3	5

SHY [unintended]

NOTE: This instruction is unstable on many 6502 processors, and should be avoided.

This instruction stores the binary AND of the contents of the Y Register and the third byte of the instruction into the indicated location.

SHY : Store Binary AND of Y Register and 3rd Instruction Byte 6502				
$M \leftarrow Y \text{ AND } B3$				
			NZ I CD	VE
		
Addressing Mode	Assembly	Code	Bytes	Cycles
absolute,X	SHY \$nnnn,X	9C	3	5

SLO [unintended]

This instruction shifts either contents of the provided memory location one bit left, and then ORs the result with the Accumulator Register, and places the result in the Accumulator.

Side effects

- The N flag will be set if the result is negative, i.e., if bit 7 of the Accumulator is set after the instruction completes, else it will be cleared.
- The Z flag will be set if the Accumulator contains \$00 after the instruction has completed, else it will be cleared.
- The C flag will be set if bit 7 of the memory contents was set, prior to being shifted.

SLO : Shift Left and OR		6502		
$M \leftarrow M \ll 1, A \leftarrow M \ll 1$				
		NZ I CDV E		
		++ · + · · ·		
Addressing Mode	Assembly	CodeBytes	Cycles	
(indirect),X	SLO (\$nn,X)	03	2	8
zero-page	SLO \$nn	07	2	5
absolute	SLO \$nnnn	0F	3	6
(indirect),Y	SLO (\$nn),Y	13	2	8
zero-page,X	SLO \$nn,X	17	2	6
absolute,Y	SLO \$nnnn,Y	1B	3	7
absolute,X	SLO \$nnnn,X	1F	3	7

SRE [unintended]

This instruction shifts the contents of the provided memory location one bit right. Bit 7 will be set to zero, and the bit 0 will be shifted out into the Carry Flag. The result is exclusive ORed with the Accumulator and stored in the Accumulator.

Side effects

- The N flag will be set if the result is negative, i.e., if bit 7 is set after the operation, else it will be cleared.
- The Z flag will be set if the result is zero, else it will be cleared.
- The C flag will be set if bit 0 of the value was set, prior to being shifted.

SRE : Logical Shift Right and Exclusive OR with Accumulator		6502		
$M \leftarrow M \gg 1, A \leftarrow A \text{ XOR } M \gg 1$				
		NZ I CD		
		++ · + · · ·		
		VE		
		· ·		
Addressing Mode	Assembly	CodeBytes	Cycles	
(indirect),X	SRE (\$nn,X)	43	2	8
zero-page	SRE \$nn	47	2	5
absolute	SRE \$nnnn	4F	3	6
(indirect),Y	SRE (\$nn),Y	53	2	8
zero-page,X	SRE \$nn,X	57	2	6
absolute,Y	SRE \$nnnn,Y	5B	3	7
absolute,X	SRE \$nnnn,X	5F	3	7

STA

This instruction stores the contents of the Accumulator Register into the indicated location.

STA : Store Accumulator		6502			
$M \leftarrow A$		NZ I CDV E			
Addressing Mode	Assembly	Code	Bytes	Cycles	
(indirect),X	STA (\$nn),X	81	2	6	
zero-page	STA \$nn	85	2	3	
absolute	STA \$nnnn	8D	3	4	
(indirect),Y	STA (\$nn),Y	91	2	6	
zero-page,X	STA \$nn,X	95	2	4	
absolute,Y	STA \$nnnn,Y	99	3	5	
absolute,X	STA \$nnnn,X	9D	3	5	

STX

This instruction stores the contents of the X Register into the indicated location.

STX : Store X Register		6502			
$M \leftarrow X$		NZ I CDV E			
Addressing Mode	Assembly	Code	Bytes	Cycles	
zero-page	STX \$nn	86	2	3	
absolute	STX \$nnnn	8E	3	4	
zero-page,Y	STX \$nn,Y	96	2	4	

STY

This instruction stores the contents of the Y Register into the indicated location.

STY : Store Y Register		6502		
$M \leftarrow Y$				
NZ I CDV E				
.				
Addressing Mode	Assembly Code	Bytes	Cycles	
zero-page	STY \$nn	84	2	3
absolute	STY \$nnnn	8C	3	4
zero-page,X	STY \$nn,X	94	2	4

TAS [unintended]

NOTE: This monstrosity of an instruction, aside from being devoid of any conceivable useful purpose is unstable on many 6502 processors and should therefore also be avoided for that reason, if you had not already been put off.

Side effects

- Remarkably, despite the over complicated operation that it performs, it modifies none of the processor flags.
- Loss of sanity if you attempt to use it, or even figure out exactly how it works.

TAS : Munge X Register and Stack Pointer		6502		
$SP \leftarrow A \text{ AND } X, M \leftarrow (A \text{ AND } X) \text{ AND } B3$				
NZ I CDV E				
.				
Addressing Mode	Assembly Code	Bytes	Cycles	
absolute,Y	TAS \$nnnn,Y	9B	3	5

TAX

This instruction loads the X Register with the contents of the Accumulator Register.

Side effects

- The N flag will be set if the result is negative, else it will be cleared.
- The Z flag will be set if the result is zero, else it will be cleared.

TAX : Transfer Accumulator Register into the X Register6502 $X \leftarrow A$

NZ	I	CD	VE
++

Addressing Mode	Assembly Code	Bytes	Cycles
implied	TAX	AA 1	2

TAY

This instruction loads the Y Register with the contents of the Accumulator Register.

Side effects

- The N flag will be set if the result is negative, else it will be cleared.
- The Z flag will be set if the result is zero, else it will be cleared.

TAY : Transfer Accumulator Register into the Y Register6502 $Y \leftarrow A$

NZ	I	CD	VE
++

Addressing Mode	Assembly Code	Bytes	Cycles
implied	TAY	A8 1	2

TSX

This instruction loads the X Register with the contents of the Stack Pointer High (SPL) Register.

Side effects

- The N flag will be set if the result is negative, else it will be cleared.
- The Z flag will be set if the result is zero, else it will be cleared.

TSX : Transfer Stack Pointer High Register into the X Register6502 $X \leftarrow \text{SPH}$ **NZ I CD****VE**

++ . . .

Addressing Mode	Assembly Code	Bytes	Cycles
implied	TSX	BA 1	2

TXA

This instruction loads the Accumulator Register with the contents of the X Register.

Side effects

- The N flag will be set if the result is negative, else it will be cleared.
- The Z flag will be set if the result is zero, else it will be cleared.

TXA : Transfer X Register into the Accumulator Register6502 $A \leftarrow X$ **NZ I CD****VE**

++ . . .

Addressing Mode	Assembly Code	Bytes	Cycles
implied	TXA	8A 1	2

TXS

This instruction sets the low byte of the Stack Pointer (SPL) register to the contents of the X Register.

TXS : Transfer X Register into Stack Pointer Low Register6502 $\text{SPL} \leftarrow X$ **NZ I CD****VE**

.

Addressing Mode	Assembly Code	Bytes	Cycles
implied	TXS	9A 1	2

TYA

This instruction loads the Accumulator Register with the contents of the Y Register.

Side effects

- The N flag will be set if the result is negative, else it will be cleared.
- The Z flag will be set if the result is zero, else it will be cleared.

TYA : Transfer Y Register into the Accumulator Register 6502				
$A \leftarrow Y$				
NZ I CD VE				
++				
Addressing Mode	Assembly Code	Bytes	Cycles	
implied	TYA	98	1	2

XAA [unintended]

This instruction loads the Accumulator Register with the binary AND of the X Register and the immediate mode argument.

NOTE: This instruction is unstable on many 6502 processors, and should not be used.

Side effects

- The N flag will be set if the result is negative, else it will be cleared.
- The Z flag will be set if the result is zero, else it will be cleared.

XAA : Transfer X into A and AND with operand 6502				
$A \leftarrow X \text{ AND VALUE}$				
NZ I CDV E				
++				
Addressing Mode	Assembly Code	Bytes	Cycles	
immediate	XAA #\$nn	8B	2	2

4510 INSTRUCTION SET

Opcode Map

\$x0	\$x1	\$x2	\$x3	\$x4	\$x5	\$x6	\$x7	\$x8	\$x9	\$xA	\$xB	\$xC	\$xD	\$xE	\$xF																																																																																																																																																																																																															
\$0x BRK	ORACLE	SEE	TSB	ORASL	RMB0PHP	ORASL	TSY	TSB	ORASL	BBR0	\$1x BPL	ORA	ORA	BPL	TRB	ORASL	BBR1	\$2x JSR	AND	JSR	JSR	BIT	AND	ROL	BBR2	\$3x BMI	AND	AND	BMI	BIT	AND	ROL	RMB3SEC	AND	DEC	DEZ	BIT	AND	ROL	BBR3	\$4x RTI	FOR	NEG	ASR	ASR	EOR	LSR	RMB4PHA	FOR	LSR	TAZ	JMP	FOR	LSR	BBR4	\$5x BVC	FOR	EOR	BVC	ASR	EOR	LSR	RMB5CLI	FOR	PHY	TAB	MAP	FOR	LSR	BBR5	\$6x RTS	ADC	RTS	BSR	STZ	ADC	ROR	RMB6PLA	ADC	ROR	TZA	JMP	ADC	ROR	BBR6	\$7x BVS	ADC	ADC	BVS	STZ	ADC	ROR	RMB7SEI	ADC	PLY	TBA	JMP	ADC	ROR	BBR7	\$8x BRA	STA	STA	BRA	STY	STA	STX	SMB0DEY	BIT	TXA	STY	STY	STA	STX	BBB0	\$9x BCC	STA	STA	BCC	STY	STA	STX	SMB1TYA	STA	TXS	STX	STZ	STA	STZ	BBB1	\$Ax LDY	LDA	LDA	LDX	LDZ	LDY	LDA	LDX	SMB2TAY	LDA	TAX	LDZ	LDY	LDA	LDX	BBB2	\$Bx BCS	LDA	LDA	BCS	LDY	LDA	LDX	SMB3CLV	LDA	TSX	LDZ	LDY	LDA	LDX	BBB3	\$Cx CPY	CMP	CPZ	DEW	CPY	CMP	DEC	SMB4INY	CMP	DEX	ASW	CPY	CMP	DEC	BBB4	\$Dx BNE	CMP	CMP	BNE	CPZ	CMP	DEC	SMB5CLD	CMP	PHX	PHZ	CPZ	CMP	DEC	BBB5	\$Ex CPX	SBC	LDA	INW	CPX	SBC	INC	SMB6INX	SBC	EOM	ROW	CPX	SBC	INC	BBB6	\$Fx BEO	SBC	SBC	BEO	PHW	SBC	INC	SMB7SED	SED	SBC	PLX	PLZ	PHW	SBC	INC	BBB7

Instruction Timing

The following table lists the base cycle count for each opcode. Note that the number of cycles depends on the speed setting of the processor: Some instructions take more or fewer cycles when the processor is running at full-speed, or a C65 compatibility 3.5MHz speed, or at C64 compatibility 1MHz/2MHz speed. More detailed information on this is listed under each instruction's information, but the high-level view is:

- When the processor is running at 1MHz, all instructions take at least two cycles, and dummy cycles are re-inserted into Read-Modify-Write instructions, so that all instructions take exactly the same number of cycles as on a 6502.
- The Read-Modify-Write instructions and all instructions that read a value from memory all require an extra cycle when operating at full speed, to allow signals to propagate within the processor.
- The Read-Modify-Write instructions require an additional cycle if the operand is \$D019, as the dummy write is performed in this case. This is to improve compatibility with C64 software that frequently uses this “bug” of the 6502 to more rapidly acknowledge VIC-II interrupts.
- Page-crossing and branch-taking penalties do not apply when the processor is running at full speed.
- Many instructions require fewer cycles when the processor is running at full speed, as generally most non-bus cycles are removed. For example, Pushing and Pulling values to and from the stack requires only 2 cycles, instead of the 4 that the 6502 requires for these instructions.

Note that it is possible that further changes to processor timing will occur.

Similar issues apply to when the processor is in 6502 mode.

\$x0	\$x1	\$x2	\$x3	\$x4	\$x5	\$x6	\$x7	\$x8	\$x9	\$xA	\$xB	\$xC	\$xD	\$xE	\$xF
\$0x7	6 ^{pr}	1s	1s	3 ^r	3 ^r	4 ^r	4 ^{br}	2	2	1s	1s	5 ^r	4 ^r	5 ^r	
\$1x2 ^b	5 ^{pr}	5 ^{pr}	3 ^b	5 ^r	3 ^r	4 ^r	4 ^{br}	1s	4 ^r	1s	1s	4 ^r	4 ^{pr}	5 ^{pr}	5 ^b
\$2x5	5 ^{pr}	5 ^r	5 ^{pr}	3 ^r	3 ^r	4 ^r	4 ^r	4 ^m	2	1s	1s	4 ^r	4 ^r	5 ^r	5 ^b
\$3x2 ^r	5 ^{pr}	5 ^{pr}	3 ^b	3 ^{pr}	4 ^{pr}	5 ^{pr}	4 ^r	1s	4 ^r	1s	1s	4 ^{pr}	4 ^{pr}	5 ^{pr}	4 ^b
\$4x6 ^m	5 ^r	1s	1s	4 ^r	3 ^r	4 ^r	4 ^r	2	2	1s	1s	3	4 ^r	5 ^r	4 ^{br}
\$5x2 ^b	5 ^{pr}	5 ^{pr}	3 ^b	5 ^{pr}	3 ^p	3 ^{pr}	4 ^r	1s	4 ^{pr}	2	1s	1s	4 ^{pr}	5 ^{pr}	4 ^{br}
\$6x6 ^m	5 ^r	4	3 ^b	3	3 ^r	5 ^r	5 ^r	4 ^m	2	1s	1s	5 ^r	4 ^r	6 ^r	4 ^{br}
\$7x2 ^b	5 ^{pr}	5 ^{pr}	3 ^b	3	3 ^r			4 ^r					4 ^r		
\$8x															
\$9x															
\$Ax															
\$Bx															
\$Cx															
\$Dx															
\$Ex															
\$Fx															

*b*Add one cycle if branch crosses a page boundary.

*m*Subtract non-bus cycles when at 40MHz.

*p*Add one cycle if indexing crosses a page boundary.

*r*Add one cycle if clock speed is at 40 MHz.

*s*Instruction requires 2 cycles when CPU is run at 1MHz or 2MHz.

Addressing Mode Table

\$x0	\$x1	\$x2	\$x5	\$x4	\$x5	\$x6	\$x7/\$x8/\$x9	\$xA/\$xB	\$xC	\$xD	\$xE	\$xF
\$0x	(\$nn,X)			\$nn	\$nn	\$nn	\$nn		\$nnn	\$nnn	\$nnn	\$nn,\$fr
\$1x,\$rr	(\$nn,Y)(\$nn,Z)		\$rrrr	\$nn	\$nn	\$nn,X(\$nn,X)\$nn	\$nnn,YA		\$nnn	\$nnn,X(\$nnn,X)\$nn,\$fr		\$nn,\$fr
\$2x,\$nnnn	(\$nn,X)(\$nnn)		(\$nnnn,X)\$nn	\$nn	\$nn	\$nn	\$nn		\$nnn	\$nnn	\$nnn	\$nn,\$fr
\$3x,\$rr	(\$nn,Y)(\$nn,Z)		\$rrrr	\$nn,X	\$nn	\$nn,X(\$nn,X)\$nn	\$nnn,YA		\$nnn,X	\$nnn,X(\$nnn,X)\$nn,\$fr		\$nn,\$fr
\$4x	(\$nn,X)A		A	\$nn	\$nn	\$nn	\$nn		\$nnn	\$nnn	\$nnn	\$nn,\$fr
\$5x,\$rr	(\$nn,Y)(\$nn,Z)		\$rrrr	\$nn,X	\$nn	\$nn,X(\$nn,X)\$nn	\$nnn,Y		\$nnn	\$nnn,X(\$nnn,X)\$nn,\$fr		\$nn,\$fr
\$6x	(\$nn,X)#\$nn		\$rrrr	\$nn	\$nn	\$nn	\$nn		\$nnn	\$nnn	\$nnn	\$nn,\$fr
\$7x,\$rr	(\$nn,Y)(\$nn,Z)		\$rrrr	\$nn,X	\$nn	\$nn,X(\$nn,X)\$nn	\$nnn,Y		(\$nnn)	\$nnn,X(\$nnn,X)\$nn,\$fr		\$nn,\$fr
\$8x,\$rr	(\$nn,X)(\$nn,SP),Y		\$rrrr	\$nn	\$nn	\$nn	\$nn		\$nnn,X(\$nnn)	\$nnn	\$nnn	\$nn,\$fr
\$9x,\$rr	(\$nn,Y)(\$nn,Z)		\$rrrr	\$nn,X	\$nn	\$nn,X(\$nn,Y)\$nn	\$nnn,Y		\$nnn,Y(\$nnn)	\$nnn	\$nnn	\$nn,\$fr
\$A#,\$nn	(\$nn,X)#\$nn		#\$nn	\$nn	\$nn	\$nn	\$nn		\$nnn	\$nnn	\$nnn	\$nn,\$fr
\$B#,\$rr	(\$nn,Y)(\$nn,Z)		\$rrrr	\$nn,X	\$nn	\$nn,X(\$nn,Y)\$nn	\$nnn,Y		\$nnn,X(\$nnn,X)	\$nnn,Y(\$nn,\$fr		\$nn,\$fr
\$C#,\$nn	(\$nn,X)#\$nn		\$nn	\$nn	\$nn	\$nn	\$nn		\$nnn	\$nnn	\$nnn	\$nn,\$fr
\$D#,\$rr	(\$nn,Y)(\$nn,Z)		\$rrrr	\$nn	\$nn	\$nn,X(\$nn,X)\$nn	\$nnn,Y		\$nnn	\$nnn,X(\$nnn,X)\$nn,\$fr		\$nn,\$fr
\$E#,\$nn	(\$nn,X)(\$nn,SP),Y		\$nn	\$nn	\$nn	\$nn	\$nn		\$nnn	\$nnn	\$nnn	\$nn,\$fr
\$F#,\$rr	(\$nn,Y)(\$nn,Z)		\$rrrr	#(\$nnnn)\$nn,X(\$nn,X)\$nn	\$nn	\$nn	\$nn		\$nnn	\$nnn,X(\$nnn,X)\$nn,\$fr		\$nn,\$fr

ADC

This instruction adds the argument to the contents of the Accumulator Register and the Carry Flag. If the D flag is set, then the addition is performed using Binary Coded Decimal.

Side effects

- The N flag will be set if the result is negative, else it will be cleared.
- The Z flag will be set if the result is zero, else it will be cleared.
- The V flag will be set if the result has a different sign to both of the arguments, else it will be cleared. If the flag is set, this indicates that a signed overflow has occurred.
- The C flag will be set if the unsigned result is >255, or >99 if the D flag is set.

ADC : Add with carry		4510			
A ← A+M+C					
NZ I CDV E					
+ + · + · + ·					
Addressing Mode	Assembly	Code	Bytes	Cycles	
(indirect),X	ADC (\$nn,X)	61	2	5	<i>r</i>
base-page	ADC \$nn	65	2	3	<i>r</i>
immediate	ADC #\$nn	69	2	2	
absolute	ADC \$nnnn	6D	3	4	<i>r</i>
(indirect),Y	ADC (\$nn),Y	71	2	5	<i>pr</i>
(indirect),Z	ADC (\$nn),Z	72	2	5	<i>pr</i>
base-page,X	ADC \$nn,X	75	2	3	<i>r</i>
absolute,Y	ADC \$nnnn,Y	79	3	4	<i>r</i>
absolute,X	ADC \$nnnn,X	7D	3	4	<i>r</i>

*p*Add one cycle if indexing crosses a page boundary.

*r*Add one cycle if clock speed is at 40 MHz.

AND

This instructions performs a binary AND operation of the argument with the accumulator, and stores the result in the accumulator. Only bits that were already set in the accumulator, and that are set in the argument will be set in the accumulator on completion.

Side effects

- The N flag will be set if the result is negative, else it will be cleared.
- The Z flag will be set if the result is zero, else it will be cleared.

AND : Binary AND				4510	
$A \leftarrow A \text{ AND } M$					
NZ I CDV E					
++					
Addressing Mode	Assembly	Code	Bytes	Cycles	
(indirect),X	AND (\$nn,X)	21	2	5	<i>pr</i>
base-page	AND \$nn	25	2	3	<i>r</i>
immediate	AND #\$nn	29	2	2	
absolute	AND \$nnnn	2D	3	4	<i>r</i>
(indirect),Y	AND (\$nn),Y	31	2	5	<i>pr</i>
(indirect),Z	AND (\$nn),Z	32	2	5	<i>pr</i>
base-page,X	AND \$nn,X	35	2	4	<i>pr</i>
absolute,Y	AND \$nnnn,Y	39	3	4	<i>r</i>
absolute,X	AND \$nnnn,X	3D	3	4	<i>pr</i>

*p*Add one cycle if indexing crosses a page boundary.

*r*Add one cycle if clock speed is at 40 MHz.

ASL

This instruction shifts either the Accumulator or contents of the provided memory location one bit left. Bit 0 will be set to zero, and the bit 7 will be shifted out into the Carry Flag

Side effects

- The N flag will be set if the result is negative, i.e., if bit 7 is set after the operation, else it will be cleared.
- The Z flag will be set if the result is zero, else it will be cleared.
- The C flag will be set if bit 7 of the value was set, prior to being shifted.

ASL : Arithmetic Shift Left**4510** $A \leftarrow A \ll 1$ or $M \leftarrow M \ll 1$ **NZ I CDV E**

++ · + · · ·

Addressing Mode Assembly CodeBytesCycles

base-page	ASL \$nn	06	2	4	<i>r</i>
accumulator	ASL A	0A	1	1	<i>s</i>
absolute	ASL \$nnnn	0E	3	5	<i>r</i>
base-page,X	ASL \$nn,X	16	2	4	<i>r</i>
absolute,X	ASL \$nnnn,X	1E	3	5	<i>pr</i>

*p*Add one cycle if indexing crosses a page boundary.*r*Add one cycle if clock speed is at 40 MHz.*s*Instruction requires 2 cycles when CPU is run at 1MHz or 2MHz.

ASR

This instruction shifts either the Accumulator or contents of the provided memory location one bit right. Bit 7 is considered to be a sign bit, and is preserved. The contents of bit 0 will be shifted out into the Carry Flag

Side effects

- The N flag will be set if the result is negative, i.e., if bit 7 is set after the operation, else it will be cleared.
- The Z flag will be set if the result is zero, else it will be cleared.
- The C flag will be set if bit 0 of the value was set, prior to being shifted.

ASR : Arithmetic Shift Right**4510** $A \leftarrow A \gg 1$ or $M \leftarrow M \gg 1$ **NZ I CDV E**

++ · + · · ·

Addressing Mode AssemblyCodeBytesCycles

accumulator	ASR A	43	1	1	<i>s</i>
base-page	ASR \$nn	44	2	4	<i>r</i>
base-page,X	ASR \$nn,X	54	2	5	<i>pr</i>

*p*Add one cycle if indexing crosses a page boundary.*r*Add one cycle if clock speed is at 40 MHz.*s*Instruction requires 2 cycles when CPU is run at 1MHz or 2MHz.

ASW

This instruction shifts a 16-bit value in memory left one bit.

For example, if location \$1234 contained \$87 and location \$1235 contained \$A9, ASW \$1234 would result in location \$1234 containing \$0E and location \$1235 containing \$53, and the Carry Flag being set.

Side effects

- The N flag will be set if the result is negative, i.e., if bit 7 of the upper byte is set after the operation, else it will be cleared.
- The Z flag will be set if the result is zero, else it will be cleared.
- The C flag will be set if bit 7 of the upper byte was set, prior to being shifted.

ASW : Arithmetic Shift Word Left		4510
M ← M << 1		
NZ I CDV E		
+ + . + . . .		
Addressing Mode	Assembly Code	BytesCycles
absolute	ASW \$nnnn CB	3

BBRO

This instruction branches to the indicated address if bit 0 is clear in the indicated base-page memory location.

BBRO : Branch on Bit 0 Reset		4510
PC ← PC + R8		
NZ I CDV E		
.		
Addressing Mode	Assembly Code	BytesCycles
base-page and relative	BBRO \$nn,\$rr OF	3

BBR 1

This instruction branches to the indicated address if bit 1 is clear in the indicated base-page memory location.

BBR1 : Branch on Bit 1 Reset		4510	
PC ← PC + R8			
NZ I CDV E			
Addressing Mode	Assembly	CodeBytes	Cycles
base-page and relative	BBR1 \$nn,\$rr	1F 3	5 ^b

^bAdd one cycle if branch is taken.

Add one more cycle if branch taken crosses a page boundary.

BBR2

This instruction branches to the indicated address if bit 2 is clear in the indicated base-page memory location.

BBR2 : Branch on Bit 2 Reset		4510	
PC ← PC + R8			
NZ I CDV E			
Addressing Mode	Assembly	CodeBytes	Cycles
base-page and relative	BBR2 \$nn,\$rr	2F 3	5 ^b

^bAdd one cycle if branch is taken.

Add one more cycle if branch taken crosses a page boundary.

BBR3

This instruction branches to the indicated address if bit 3 is clear in the indicated base-page memory location.

BBR3 : Branch on Bit 3 Reset		4510	
PC ← PC + R8			
NZ I CDV E			
Addressing Mode	Assembly	CodeBytes	Cycles
base-page and relative	BBR3 \$nn,\$rr	3F 3	4 ^b

^bAdd one cycle if branch is taken.

Add one more cycle if branch taken crosses a page boundary.

BBR4

This instruction branches to the indicated address if bit 4 is clear in the indicated base-page memory location.

BBR4 : Branch on Bit 4 Reset	4510			
PC ← PC + R8				
	NZ I CDV E			
Addressing Mode	Assembly	Code	Bytes	Cycles
base-page and relative	BBR4 \$nn,\$rr	4F	3	4 ^{br}

*b*Add one cycle if branch is taken.

Add one more cycle if branch taken crosses a page boundary.

*r*Add one cycle if clock speed is at 40 MHz.

BBR5

This instruction branches to the indicated address if bit 5 is clear in the indicated base-page memory location.

BBR5 : Branch on Bit 5 Reset	4510			
PC ← PC + R8				
	NZ I CDV E			
Addressing Mode	Assembly	Code	Bytes	Cycles
base-page and relative	BBR5 \$nn,\$rr	5F	3	4 ^{br}

*b*Add one cycle if branch is taken.

Add one more cycle if branch taken crosses a page boundary.

*r*Add one cycle if clock speed is at 40 MHz.

BBR6

This instruction branches to the indicated address if bit 6 is clear in the indicated base-page memory location.

BBR6 : Branch on Bit 6 Reset		4510	
PC ← PC + R8			
NZ I CDV E			
Addressing Mode	Assembly	CodeBytes	Cycles
base-page and relative	BBR6 \$nn,\$rr	6F 3	4 ^{br}

^bAdd one cycle if branch is taken.

^rAdd one more cycle if branch taken crosses a page boundary.

^rAdd one cycle if clock speed is at 40 MHz.

BBR7

This instruction branches to the indicated address if bit 7 is clear in the indicated base-page memory location.

BBR7 : Branch on Bit 7 Reset		4510	
PC ← PC + R8			
NZ I CDV E			
Addressing Mode	Assembly	CodeBytes	Cycles
base-page and relative	BBR7 \$nn,\$rr	7F 3	

BBS0

This instruction branches to the indicated address if bit 0 is set in the indicated base-page memory location.

BBS0 : Branch on Bit 0 Set		4510	
PC ← PC + R8			
NZ I CDV E			
Addressing Mode	Assembly	CodeBytes	Cycles
base-page and relative	BBS0 \$nn,\$rr	8F 3	

BBS1

This instruction branches to the indicated address if bit 1 is set in the indicated base-page memory location.

BBS1 : Branch on Bit 1 Set		4510
PC ← PC + R8		
	NZ I CDV E	
	
Addressing Mode	Assembly	CodeBytesCycles
base-page and relative	BBS1 \$nn,\$rr	9F 3

BBS2

This instruction branches to the indicated address if bit 2 is set in the indicated base-page memory location.

BBS2 : Branch on Bit 2 Set		4510
PC ← PC + R8		
	NZ I CDV E	
	
Addressing Mode	Assembly	CodeBytesCycles
base-page and relative	BBS2 \$nn,\$rr	AF 3

BBS3

This instruction branches to the indicated address if bit 3 is set in the indicated base-page memory location.

BBS3 : Branch on Bit 3 Set		4510
PC ← PC + R8		
	NZ I CDV E	
	
Addressing Mode	Assembly	CodeBytesCycles
base-page and relative	BBS3 \$nn,\$rr	BF 3

BBS4

This instruction branches to the indicated address if bit 4 is set in the indicated base-page memory location.

BBS4 : Branch on Bit 4 Set	4510
PC ← PC + R8	
	NZ I CDV E
Addressing Mode	Assembly CodeBytesCycles
base-page and relative	BBS4 \$nn,\$rr CF 3

BBS5

This instruction branches to the indicated address if bit 5 is set in the indicated base-page memory location.

BBS5 : Branch on Bit 5 Set	4510
PC ← PC + R8	
	NZ I CDV E
Addressing Mode	Assembly CodeBytesCycles
base-page and relative	BBS5 \$nn,\$rr DF 3

BBS6

This instruction branches to the indicated address if bit 6 is set in the indicated base-page memory location.

BBS6 : Branch on Bit 6 Set	4510
PC ← PC + R8	
	NZ I CDV E
Addressing Mode	Assembly CodeBytesCycles
base-page and relative	BBS6 \$nn,\$rr EF 3

BBS7

This instruction branches to the indicated address if bit 7 is set in the indicated base-page memory location.

BBS7 : Branch on Bit 7 Set		4510	
PC ← PC + R8			
		NZ I CDV E	
		
Addressing Mode	Assembly	CodeBytes	Cycles
base-page and relative	BBS7 \$nn,\$rr	FF	3

BCC

This instruction branches to the indicated address if the Carry Flag is clear.

BCC : Branch on Carry Flag Clear		4510	
PC ← PC + R8 <i>or</i> PC ← PC + R16			
		NZ I CDV E	
		
Addressing Mode	Assembly	CodeBytes	Cycles
relative	BCC \$rr	90	2
16-bit relative	BCC \$rrrr	93	3

BCS

This instruction branches to the indicated address if the Carry Flag is set.

BCS : Branch on Carry Flag Set		4510	
PC ← PC + R8 <i>or</i> PC ← PC + R16			
		NZ I CDV E	
		
Addressing Mode	Assembly	CodeBytes	Cycles
relative	BCS \$rr	B0	2
16-bit relative	BCS \$rrrr	B3	3

BEQ

This instruction branches to the indicated address if the Zero Flag is set.

BEQ : Branch on Zero Flag Set		4510		
PC ← PC + R8 <i>or</i> PC ← PC + R16				
NZ I CDV E				
Addressing Mode	Assembly Code	Bytes	Cycles	
relative	BEQ \$rr	F0	2	
16-bit relative	BEQ \$rrrr	F3	3	

BIT

This instruction is used to test the bits stored in a memory location. Bits 6 and 7 of the memory location's contents are directly copied into the Overflow Flag and Negative Flag. The Zero Flag is set or cleared based on the result of performing the binary AND of the Accumulator Register and the contents of the indicated memory location.

Side effects

- The N flag will be set if the bit 7 of the memory location is set, else it will be cleared.
- The V flag will be set if the bit 6 of the memory location is set, else it will be cleared.
- The Z flag will be set if the result of $A \text{ AND } M$ is zero, else it will be cleared.

BIT : Perform Bit Test		4510		
N ← M(7), V ← M(6), Z ← A AND M				
NZ I CDV E ++...+.				
Addressing Mode	Assembly Code	Bytes	Cycles	
base-page	BIT \$nn	24	2	3 ^r
absolute	BIT \$nnnn	2C	3	4 ^r
base-page,X	BIT \$nn,X	34	2	3 ^{pr}
absolute,X	BIT \$nnnn,X	3C	3	4 ^{pr}
immediate	BIT # \$nn	89	2	

^pAdd one cycle if indexing crosses a page boundary.

^rAdd one cycle if clock speed is at 40 MHz.

BMI

This instruction branches to the indicated address if the Negative Flag is set.

BMI : Branch on Negative Flag Set		4510		
PC ← PC + R8 <i>or</i> PC ← PC + R16				
NZ I CDV E				
Addressing Mode	AssemblyCode	Bytes	Cycles	
relative	BMI \$rr	30	2	2 <i>r</i>
16-bit relative	BMI \$rrrr	33	3	3 <i>b</i>

*b*Add one cycle if branch is taken.

Add one more cycle if branch taken crosses a page boundary.

*r*Add one cycle if clock speed is at 40 MHz.

BNE

This instruction branches to the indicated address if the Zero Flag is clear.

BNE : Branch on Zero Flag Clear		4510		
PC ← PC + R8 <i>or</i> PC ← PC + R16				
NZ I CDV E				
Addressing Mode	AssemblyCode	Bytes	Cycles	
relative	BNE \$rr	D0	2	
16-bit relative	BNE \$rrrr	D3	3	

BPL

This instruction branches to the indicated address if the Negative Flag is clear.

BPL : Branch on Negative Flag Clear		4510		
PC ← PC + R8 <i>or</i> PC ← PC + R16				
NZ I CDV E				
Addressing Mode	AssemblyCode	Bytes	Cycles	
relative	BPL \$rr	10	2	2 <i>b</i>
16-bit relative	BPL \$rrrr	13	3	3 <i>b</i>

*b*Add one cycle if branch is taken.

Add one more cycle if branch taken crosses a page boundary.

BRA

This instruction branches to the indicated address.

BRA : Branch Unconditionally		4510	
PC ← PC + R8 <i>or</i> PC ← PC + R16			
NZ I CDV E			
Addressing Mode	AssemblyCode	Bytes	Cycles
relative	BRA \$rr	80	2
16-bit relative	BRA \$rrrr	83	3

BRK

The break command causes the microprocessor to go through an interrupt sequence under program control. The address of the BRK instruction + 2 is pushed to the stack along with the status register with the Break flag set. This allows the interrupt service routine to distinguish between IRQ events and BRK events. For example:

```
PLA          ; load status
PHA          ; restore stack
AND #$10    ; mask break flag
BNE DO_BREAK ; -> it was a BRK
...         ; else continue with IRQ server
```

Cite from: MCS6500 Microcomputer Family Programming Manual, January 1976, Second Edition, MOS Technology Inc., Page 144:

"The BRK is a single byte instruction and its addressing mode is Implied."

There are debates, that BRK could be seen as a two byte instruction with the addressing mode immediate, where the operand byte is discarded. The byte following the BRK could then be used as a call argument for the break handler. Commodore however used the BRK, as stated in the manual, as a single byte instruction, which breaks into the ML monitor, if present. These builtin monitors decremented the stacked PC, so that it could be used to return or jump directly to the code byte after the BRK.

BRK : Break to Interrupt		4510		
PC ← (\$FFFE)				
NZ I CDV E				
.				
Addressing Mode	AssemblyCode	Bytes	Cycles	
implied	BRK	00	1	7

BSR

This instruction branches to the indicated address, saving the address of the caller on the stack, so that the routine can be returned from using an RTS instruction.

This instruction is helpful for using relocatable code, as it provides a relative-addressed alternative to JSR.

BSR : Branch Sub-Routine		4510		
PC ← PC + R8 <i>or</i> PC ← PC + R16				
NZ I CDV E				
.				
Addressing Mode	AssemblyCode	Bytes	Cycles	
16-bit relative	BSR \$rrrr	63	3	3 ^b

^bAdd one cycle if branch is taken.

Add one more cycle if branch taken crosses a page boundary.

BVC

This instruction branches to the indicated address if the Overflow (V) Flag is clear.

BVC : Branch on Overflow Flag Clear		4510		
PC ← PC + R8 <i>or</i> PC ← PC + R16				
NZ I CDV E				
.				
Addressing Mode	AssemblyCode	Bytes	Cycles	
relative	BVC \$rr	50	2	2 ^b
16-bit relative	BVC \$rrrr	53	3	3 ^b

^bAdd one cycle if branch is taken.

Add one more cycle if branch taken crosses a page boundary.

BVS

This instruction branches to the indicated address if the Overflow (V) Flag is set.

BVS : Branch on Overflow Flag Set				4510
PC ← PC + R8 <i>or</i> PC ← PC + R16				
NZ I CDV E				
Addressing Mode	Assembly Code	Bytes	Cycles	
relative	BVS \$rr	70	2	2 ^b
16-bit relative	BVS \$rrrr	73	3	3 ^b

^bAdd one cycle if branch is taken.

Add one more cycle if branch taken crosses a page boundary.

CLC

This instruction clears the Carry Flag.

Side effects

- The C flag is cleared.

CLC : Clear Carry Flag				4510
C ← 0				
NZ I CDV E				
Addressing Mode	Assembly Code	Bytes	Cycles	
implied	CLC	18	1	1 ^s

^sInstruction requires 2 cycles when CPU is run at 1MHz or 2MHz.

CLD

This instruction clears the Decimal Flag. Arithmetic operations will use normal binary arithmetic, instead of Binary-Coded Decimal (BCD).

Side effects

- The D flag is cleared.

CLD : Clear Decimal Flag				4510
D ← 0				
NZ I CDV E				
Addressing Mode	AssemblyCode	Bytes	Cycles	
implied	CLD	D8	1	

CLE

This instruction clears the Extended Stack Disable Flag. This causes the stack to be able to exceed 256 bytes in length, by allowing the processor to modify the value of the high byte of the stack address (SPH).

Side effects

- The E flag is cleared.

CLE : Clear Extended Stack Disable Flag				4510
E ← 0				
NZ I CDV E				
Addressing Mode	AssemblyCode	Bytes	Cycles	
implied	CLE	02	1	1 ^s

^sInstruction requires 2 cycles when CPU is run at 1MHz or 2MHz.

CLI

This instruction clears the Interrupt Disable Flag. Interrupts will now be able to occur.

Side effects

- The I flag is cleared.

CLI : Clear Interrupt Disable Flag		4510	
$I \leftarrow 0$		NZ I CDV E	
Addressing Mode	AssemblyCode	Bytes	Cycles
implied	CLI	58	1 1 ^s

^sInstruction requires 2 cycles when CPU is run at 1MHz or 2MHz.

CLV

This instruction clears the Overflow Flag.

Side effects

- The V flag is cleared.

CLV : Clear Overflow Flag		4510	
$V \leftarrow 0$		NZ I CDV E	
Addressing Mode	AssemblyCode	Bytes	Cycles
implied	CLV	B8	1

CMP

This instruction performs $A - M$, and sets the processor flags accordingly, but does not modify the contents of the Accumulator Register.

Side effects

- The N flag will be set if the result of $A - M$ is negative, i.e. bit 7 is set in the result, else it will be cleared.
- The C flag will be set if the result of $A - M$ is zero or positive, i.e., if A is not less than M, else it will be cleared.
- The Z flag will be set if the result of $A - M$ is zero, else it will be cleared.

CMP : Compare Accumulator **4510****NZ I CDV E**

++ · + · · ·

Addressing Mode	Assembly	Code	Bytes	Cycles
(indirect),X	CMP (\$nn,X)	C1		2
base-page	CMP \$nn	C5		2
immediate	CMP #\$nn	C9		2
absolute	CMP \$nnnn	CD		3
(indirect),Y	CMP (\$nn),Y	D1		2
(indirect),Z	CMP (\$nn),Z	D2		2
base-page,X	CMP \$nn,X	D5		2
absolute,Y	CMP \$nnnn,Y	D9		3
absolute,X	CMP \$nnnn,X	DD		3

CPX

This instruction performs $X - M$, and sets the processor flags accordingly, but does not modify the contents of the Accumulator Register.

Side effects

- The N flag will be set if the result of $X - M$ is negative, i.e. bit 7 is set in the result, else it will be cleared.
- The C flag will be set if the result of $X - M$ is zero or positive, i.e., if X is not less than M, else it will be cleared.
- The Z flag will be set if the result of $X - M$ is zero, else it will be cleared.

CPX : Compare X Register **4510****NZ I CDV E**

++ · + · · ·

Addressing Mode	Assembly	Code	Bytes	Cycles
immediate	CPX #\$nn	E0		2
base-page	CPX \$nn	E4		2
absolute	CPX \$nnnn	EC		3

CPY

This instruction performs $Y - M$, and sets the processor flags accordingly, but does not modify the contents of the Accumulator Register.

Side effects

- The N flag will be set if the result of $Y - M$ is negative, i.e. bit 7 is set in the result, else it will be cleared.
- The C flag will be set if the result of $Y - M$ is zero or positive, i.e., if Y is not less than M, else it will be cleared.
- The Z flag will be set if the result of $Y - M$ is zero, else it will be cleared.

CPY : Compare Y Register		4510	
		NZ I CDV E	
		++ · + · · ·	
Addressing Mode	Assembly Code	Bytes	Cycles
immediate	CPY # $\$nn$	C0	2
base-page	CPY $\$nn$	C4	2
absolute	CPY $\$nnnn$	CC	3

CPZ

This instruction performs $Z - M$, and sets the processor flags accordingly, but does not modify the contents of the Accumulator Register.

Side effects

- The N flag will be set if the result of $Z - M$ is negative, i.e. bit 7 is set in the result, else it will be cleared.
- The C flag will be set if the result of $Z - M$ is zero or positive, i.e., if Z is not less than M, else it will be cleared.
- The Z flag will be set if the result of $Z - M$ is zero, else it will be cleared.

CPZ : Compare Z Register		4510	
		NZ I CDV E	
		++ · + · · ·	
Addressing Mode	Assembly	CodeBytes	Cycles
immediate	CPZ # $\$nn$	C2	2
base-page	CPZ $\$nn$	D4	2
absolute	CPZ $\$nnnn$	DC	3

DEC

This instruction decrements the Accumulator Register or indicated memory location.

Side effects

- The N flag will be set if the result is negative, else it will be cleared.
- The Z flag will be set if the result is zero, else it will be cleared.

DEC : Decrement Memory or Accumulator		4510	
$A \leftarrow A - 1$ or $M \leftarrow M - 1$			
		NZ I CDV E	
		++ · · · · ·	
Addressing Mode	Assembly	CodeBytes	Cycles
accumulator	DEC A	3A	1 1 ^s
base-page	DEC $\$nn$	C6	2
absolute	DEC $\$nnnn$	CE	3
base-page,X	DEC $\$nn,X$	D6	2
absolute,X	DEC $\$nnnn,X$	DE	3

^sInstruction requires 2 cycles when CPU is run at 1MHz or 2MHz.

DEW

This instruction decrements the indicated memory word in the Base Page. The low numbered address contains the least significant bits. For example, if memory location \$12 contains \$78 and memory location \$13 contains \$56, the instruction DEW \$12 would cause memory location to be set to \$77.

Side effects

- The N flag will be set if the result is negative, else it will be cleared.
- The Z flag will be set if the result is zero, else it will be cleared.

DEW : Decrement Memory Word		4510	
$M16 \leftarrow M16 - 1$			
NZ I CDV E			
++			
Addressing Mode	AssemblyCode	Bytes	Cycles
base-page	DEW \$nn	C3	2

DEX

This instruction decrements the X Register.

Side effects

- The N flag will be set if the result is negative, else it will be cleared.
- The Z flag will be set if the result is zero, else it will be cleared.

DEX : Decrement X Register		4510	
$X \leftarrow X - 1$			
NZ I CDV E			
++			
Addressing Mode	AssemblyCode	Bytes	Cycles
implied	DEX	CA	1

DEY

This instruction decrements the Y Register.

Side effects

- The N flag will be set if the result is negative, else it will be cleared.
- The Z flag will be set if the result is zero, else it will be cleared.

DEY : Decrement Y Register		4510	
$Y \leftarrow Y - 1$			
NZ I CDV E ++			
Addressing Mode	AssemblyCode	Bytes	Cycles
implied	DEY	88	1

DEZ

This instruction decrements the Z Register.

Side effects

- The N flag will be set if the result is negative, else it will be cleared.
- The Z flag will be set if the result is zero, else it will be cleared.

DEZ : Decrement Z Register		4510	
$Z \leftarrow Z - 1$			
NZ I CDV E ++			
Addressing Mode	AssemblyCode	Bytes	Cycles
implied	DEZ	3B	1 1 ^s

Instruction requires 2 cycles when CPU is run at 1MHz or 2MHz.

EOM

In contrast with the 6502, the NOP instruction on the 45GS02 performs two additional roles when in 4502 mode.

First, indicate the end of a memory mapping sequence caused by a MAP instruction, allowing interrupts to occur again.

Second, it instructs the processor that if the following instruction uses Base-Page Indirect Z Indexed addressing, that the processor should use a 32-bit pointer instead of a 16-bit 6502 style pointer. Such 32-bit addresses are unaffected by C64, C65 or MEGA65 memory banking. This allows fast and easy access to the entire address space of the MEGA65 without having to perform or be aware of any banking, or using the DMA controller. This addressing mode causes a two cycle penalty, caused by the time required to read the extra two bytes of the pointer.

Side effects

- Removes the prohibition on all interrupts caused by the the MAP instruction, allowing Non-Maskable Interrupts to again occur, and IRQ interrupts, if the Interrupt Disable Flag is not set.

EOM : End of Mapping Sequence / No-Operation				4510
			NZ I CD VE	
			
Addressing Mode	Assembly	Code	Bytes	Cycles
implied	EOM	EA	1	

EOR

This instructions performs a binary XOR operation of the argument with the accumulator, and stores the result in the accumulator. Only bits that were already set in the accumulator, or that are set in the argument will be set in the accumulator on completion, but not both.

Side effects

- The N flag will be set if the result is negative, else it will be cleared.
- The Z flag will be set if the result is zero, else it will be cleared.

EOR : Binary Exclusive OR				4510
$A \leftarrow A \text{ XOR } M$				
				NZ I CDV E
				+ +
Addressing Mode	Assembly	Code	Bytes	Cycles
(indirect),X	EOR (\$nn,X)	41	2	5 <i>r</i>
base-page	EOR \$nn	45	2	3 <i>r</i>
immediate	EOR #\$nn	49	2	2
absolute	EOR \$nnnn	4D	3	4 <i>r</i>
(indirect),Y	EOR (\$nn),Y	51	2	5 <i>pr</i>
(indirect),Z	EOR (\$nn),Z	52	2	5 <i>pr</i>
base-page,X	EOR \$nn,X	55	2	3 <i>p</i>
absolute,Y	EOR \$nnnn,Y	59	3	4 <i>pr</i>
absolute,X	EOR \$nnnn,X	5D	3	4 <i>pr</i>

*p*Add one cycle if indexing crosses a page boundary.

*r*Add one cycle if clock speed is at 40 MHz.

INC

This instruction increments the Accumulator Register or indicated memory location.

Side effects

- The N flag will be set if the result is negative, else it will be cleared.
- The Z flag will be set if the result is zero, else it will be cleared.

INC : Increment Memory or Accumulator			4510	
$A \leftarrow A + 1$ or $M \leftarrow M + 1$				
NZ I CDV E ++				
Addressing Mode	Assembly	Code	Bytes	Cycles
accumulator	INC A	1A	1	1 ^s
base-page	INC \$nn	E6	2	
absolute	INC \$nnnn	EE	3	
base-page,X	INC \$nn,X	F6	2	
absolute,X	INC \$nnnn,X	FE	3	

*s*Instruction requires 2 cycles when CPU is run at 1MHz or 2MHz.

INW

This instruction increments the indicated memory word in the Base Page. The low numbered address contains the least significant bits. For example, if memory location \$12 contains \$78 and memory location \$13 contains \$56, the instruction DEW \$12 would cause memory location to be set to \$79.

Side effects

- The N flag will be set if the result is negative, else it will be cleared.
- The Z flag will be set if the result is zero, else it will be cleared.

INW : Increment Memory Word			4510	
$M16 \leftarrow M16 + 1$				
NZ I CDV E ++				
Addressing Mode	Assembly	Code	Bytes	Cycles
base-page	INW \$nn	E3	2	

INX

This instruction increments the X Register, i.e., adds 1 to it.

Side effects

- The N flag will be set if the result is negative, else it will be cleared.
- The Z flag will be set if the result is zero, else it will be cleared.

INX : Increment X Register		4510	
$X \leftarrow X + 1$		NZ I CDV E ++	
Addressing Mode	AssemblyCode	Bytes	Cycles
implied	INX	E8	1

INY

This instruction increments the Y Register, i.e., adds 1 to it.

Side effects

- The N flag will be set if the result is negative, else it will be cleared.
- The Z flag will be set if the result is zero, else it will be cleared.

INY : Increment Y Register		4510	
$Y \leftarrow Y + 1$		NZ I CDV E ++	
Addressing Mode	AssemblyCode	Bytes	Cycles
implied	INY	C8	1

INZ

This instruction increments the Z Register, i.e., adds 1 to it.

Side effects

- The N flag will be set if the result is negative, else it will be cleared.

- The Z flag will be set if the result is zero, else it will be cleared.

INZ : Increment Z Register					4510
$Z \leftarrow Y + 1$					
		NZ I CDV E			
		++			
Addressing Mode	Assembly	Code	Bytes	Cycles	
implied	INZ	1B	1	1	^s

^sInstruction requires 2 cycles when CPU is run at 1MHz or 2MHz.

JMP

This instruction sets the Program Counter (PC) Register to the address indicated by the instruction, causing execution to continue from that address.

JMP : Jump to Address					4510
$PC \leftarrow M2:M1$					
		NZ I CDV E			
				
Addressing Mode	Assembly	Code	Bytes	Cycles	
absolute	JMP \$nnnn	4C	3	3	
indirect	JMP (\$nnnn)	6C	3	5	^r
indirect,X	JMP (\$nnnn,X)	7C	3		

^rAdd one cycle if clock speed is at 40 MHz.

JSR

This instruction saves the address of the instruction following the JSR instruction onto the stack, and then sets the Program Counter (PC) Register to the address indicated by the instruction, causing execution to continue from that address. Because the return address has been saved on the stack, the RTS instruction can be used to return from the called sub-routine and resume execution following the JSR instruction.

NOTE: This instruction actually pushes the address of the last byte of the JSR instruction onto the stack. The RTS instruction naturally is aware of this, and increments the address on popping it from the stack, before setting the Program Counter (PC) register.

JSR : Jump to Sub-Routine				4510	
PC ← M2:M1, Stack ← PCH:PCL					
NZ I CDV E					
.					
Addressing Mode	Assembly	Code	Bytes	Cycles	
absolute	JSR \$nnnn	20	3	5	
indirect	JSR (\$nnnn)	22	3	5	<i>r</i>
indirect,X	JSR (\$nnnn,X)	23	3	5	<i>pr</i>

*p*Add one cycle if indexing crosses a page boundary.

*r*Add one cycle if clock speed is at 40 MHz.

LDA

This instruction loads the Accumulator Register with the indicated value, or with the contents of the indicated location.

Side effects

- The N flag will be set if the result is negative, else it will be cleared.
- The Z flag will be set if the result is zero, else it will be cleared.

LDA : Load Accumulator				4510	
A ← M					
NZ I CDV E					
++					
Addressing Mode	Assembly	Code	Bytes	Cycles	
(indirect,X)	LDA (\$nn,X)	A1	2		
base-page	LDA \$nn	A5	2		
immediate	LDA #\$nn	A9	2		
absolute	LDA \$nnnn	AD	3		
(indirect),Y	LDA (\$nn),Y	B1	2		
(indirect),Z	LDA (\$nn),Z	B2	2		
base-page,X	LDA \$nn,X	B5	2		
absolute,Y	LDA \$nnnn,Y	B9	3		
absolute,X	LDA \$nnnn,X	BD	3		
(indirect,SP),Y	LDA (\$nn,SP),Y	E2	2		

LDX

This instruction loads the X Register with the indicated value, or with the contents of the indicated location.

Side effects

- The N flag will be set if the result is negative, else it will be cleared.
- The Z flag will be set if the result is zero, else it will be cleared.

LDX : Load X Register		4510	
X ← M		NZ I CDV E	
		++	
Addressing Mode	Assembly	CodeBytes	Cycles
immediate	LDX # $\$nn$	A2	2
base-page	LDX $\$nn$	A6	2
absolute	LDX $\$nnnn$	AE	3
base-page,Y	LDX $\$nn,Y$	B6	2
absolute,Y	LDX $\$nnnn,Y$	BE	3

LDY

This instruction loads the Y Register with the indicated value, or with the contents of the indicated location.

Side effects

- The N flag will be set if the result is negative, else it will be cleared.
- The Z flag will be set if the result is zero, else it will be cleared.

LDY : Load Y Register			4510
Y ← M			
			NZ I CDV E
			++
Addressing Mode	Assembly	CodeBytes	Cycles
immediate	LDY #\$nn	A0	2
base-page	LDY \$nn	A4	2
absolute	LDY \$nnnn	AC	3
base-page,X	LDY \$nn,X	B4	2
absolute,X	LDY \$nnnn,X	BC	3

LDZ

This instruction loads the Z Register with the indicated value, or with the contents of the indicated location.

Side effects

- The N flag will be set if the result is negative, else it will be cleared.
- The Z flag will be set if the result is zero, else it will be cleared.

LDZ : Load Z Register			4510
Z ← M			
			NZ I CDV E
			++
Addressing Mode	Assembly	CodeBytes	Cycles
immediate	LDZ #\$nn	A3	2
absolute	LDZ \$nnnn	AB	3
absolute,X	LDZ \$nnnn,X	BB	3

LSR

This instruction shifts either the Accumulator or contents of the provided memory location one bit right. Bit 7 will be set to zero, and the bit 0 will be shifted out into the Carry Flag

Side effects

- The N flag will be set if the result is negative, i.e., if bit 7 is set after the operation, else it will be cleared.
- The Z flag will be set if the result is zero, else it will be cleared.
- The C flag will be set if bit 0 of the value was set, prior to being shifted.

LSR : Logical Shift Right		4510		
$A \leftarrow A \gg 1, C \leftarrow A(0) \text{ or } M \leftarrow M \gg 1$		NZ I CDV E		
		++ · + · · ·		
Addressing Mode	Assembly	Code	Bytes	Cycles
base-page	LSR \$nn	46	2	4 ^r
accumulator	LSR A	4A	1	1 ^s
absolute	LSR \$nnnn	4E	3	5 ^r
base-page,X	LSR \$nn,X	56	2	3 ^{pr}
absolute,X	LSR \$nnnn,X	5E	3	5 ^{pr}

^pAdd one cycle if indexing crosses a page boundary.

^rAdd one cycle if clock speed is at 40 MHz.

^sInstruction requires 2 cycles when CPU is run at 1MHz or 2MHz.

MAP

This instruction sets the C65 or MEGA65 style memory map, depending on the values in the Accumulator, X, Y and Z registers.

Care should be taken to ensure that after the execution of an MAP instruction that appropriate memory is mapped at the location of the following instruction. Failure to do so will result in unpredictable results.

Further information on this instruction is available in Appendix G.

Side effects

- The memory map is immediately changed to that requested.
- All interrupts, including Non-Maskable Interrupts (NMIs) are blocked from occurring until an EOM (NOP) instruction is encountered.

MAP : Set Memory Map		4510		
		NZ I CDV E		
			
Addressing Mode	AssemblyCode	Bytes	Cycles	
implied	MAP	5C	1	1 ^s

^sInstruction requires 2 cycles when CPU is run at 1MHz or 2MHz.

NEG

This instruction replaces the contents of the Accumulator Register with the two's-complement of the contents of the Accumulator Register.

Side effects

- The N flag will be set if the result is negative, else it will be cleared.
- The Z flag will be set if the result is zero, else it will be cleared.

NEG : Negate Accumulator		4510		
$A \leftarrow -A$				
		NZ I CDV E		
		++		
Addressing Mode	AssemblyCode	Bytes	Cycles	
accumulator	NEG A	42	1	1 ^s

^sInstruction requires 2 cycles when CPU is run at 1MHz or 2MHz.

ORA

This instructions performs a binary OR operation of the argument with the accumulator, and stores the result in the accumulator. Only bits that were already set in the accumulator, or that are set in the argument will be set in the accumulator on completion, or both.

Side effects

- The N flag will be set if the result is negative, else it will be cleared.
- The Z flag will be set if the result is zero, else it will be cleared.

ORA : Decrement Memory or Accumulator				4510	
$A \leftarrow A + 1$ or $M \leftarrow M + 1$					
NZ I CDV E					
+ +					
Addressing Mode	Assembly	Code	Bytes	Cycles	
(indirect),X	ORA (\$nn,X)	01	2	6	<i>pr</i>
base-page	ORA \$nn	05	2	3	<i>r</i>
immediate	ORA #\$nn	09	2	2	
absolute	ORA \$nnnn	0D	3	4	<i>r</i>
(indirect),Y	ORA (\$nn),Y	11	2	5	<i>pr</i>
(indirect),Z	ORA (\$nn),Z	12	2	5	<i>pr</i>
base-page,X	ORA \$nn,X	15	2	3	<i>r</i>
absolute,Y	ORA \$nnnn,Y	19	3	4	<i>r</i>
absolute,X	ORA \$nnnn,X	1D	3	4	<i>pr</i>

*p*Add one cycle if indexing crosses a page boundary.

*r*Add one cycle if clock speed is at 40 MHz.

PHA

This instruction pushes the contents of the Accumulator Register onto the stack, and decrements the value of the Stack Pointer by 1.

PHA : Push Accumulator Register onto the Stack				4510	
$STACK \leftarrow A, SP \leftarrow SP - 1$					
NZ I CD VE					
.					
Addressing Mode	Assembly	Code	Bytes	Cycles	
implied	PHA	48	1	2	

PHP

This instruction pushes the contents of the Processor Flags onto the stack, and decrements the value of the Stack Pointer by 1.

PHP : Push Processor Flags onto the Stack		4510	
STACK ← P, SP ← SP - 1			
NZ I CDV E			
Addressing Mode	AssemblyCode	Bytes	Cycles
implied	PHP	08	1 2

PHW

This instruction pushes either a 16-bit literal value or the memory word indicated onto the stack, and decrements the value of the Stack Pointer by 2.

PHW : Push Word onto the Stack		4510	
STACK ← M1:M2, SP ← SP - 2			
NZ I CDV E ++.....			
Addressing Mode	Assembly	Code	BytesCycles
immediate	PHW # \$nnnn	F4	3
absolute	PHW \$nnnn	FC	3

PHX

This instruction pushes the contents of the X Register onto the stack, and decrements the value of the Stack Pointer by 1.

PHX : Push X Register onto the Stack		4510	
STACK ← X, SP ← SP - 1			
NZ I CDV E			
Addressing Mode	Assembly	Code	BytesCycles
implied	PHX	DA	1

PHY

This instruction pushes the contents of the Y Register onto the stack, and decrements the value of the Stack Pointer by 1.

PHY : Push Y Register onto the Stack				4510
STACK ← Y, SP ← SP - 1				
NZ I CDV E				
Addressing Mode	AssemblyCode	Bytes	Cycles	
implied	PHY	5A	1	2

PHZ

This instruction pushes the contents of the Z Register onto the stack, and decrements the value of the Stack Pointer by 1.

PHZ : Push Z Register onto the Stack				4510
STACK ← z, SP ← SP - 1				
NZ I CDV E				
Addressing Mode	AssemblyCode	Bytes	Cycles	
implied	PHZ	DB	1	

PLA

This instruction replaces the contents of the Accumulator Register with the top value from the stack, and increments the value of the Stack Pointer by 1.

PLA : Pull Accumulator Register from the Stack				4510
A ← STACK, SP ← SP + 1				
NZ I CD V E ++				
Addressing Mode	AssemblyCode	Bytes	Cycles	
implied	PLA	68	1	4 ^m

m Subtract non-bus cycles when at 40MHz.

PLP

This instruction replaces the contents of the Processor Flags with the top value from the stack, and increments the value of the Stack Pointer by 1.

NOTE: This instruction does NOT replace the Extended Stack Disable Flag (E Flag), or the Software Interrupt Flag (B Flag)

PLP : Pull Processor Flags from the Stack		4510	
A ← STACK, SP ← SP + 1			
NZ I CDV E + + + + + + ·			
Addressing Mode	AssemblyCode	Bytes	Cycles
implied	PLP	28	1 4 ^m

^mSubtract non-bus cycles when at 40MHz.

PLX

This instruction replaces the contents of the X Register with the top value from the stack, and increments the value of the Stack Pointer by 1.

PLX : Pull X Register from the Stack		4510	
X ← STACK, SP ← SP + 1			
NZ I CDV E + + · · · · ·			
Addressing Mode	AssemblyCode	Bytes	Cycles
implied	PLX	FA	1

PLY

This instruction replaces the contents of the Y Register with the top value from the stack, and increments the value of the Stack Pointer by 1.

PLY : Pull Y Register from the Stack		4510	
Y ← STACK, SP ← SP + 1			
NZ I CDV E + + · · · · ·			
Addressing Mode	AssemblyCode	Bytes	Cycles
implied	PLY	7A	1

PLZ

This instruction replaces the contents of the Z Register with the top value from the stack, and increments the value of the Stack Pointer by 1.

PLZ : Pull Z Register from the Stack		4510	
Z ← STACK, SP ← SP + 1			
NZ I CDV E ++			
Addressing Mode	AssemblyCode	Bytes	Cycles
implied	PLZ	FB	1

RMBO

This instruction clears bit zero of the indicated address. No flags are modified, regardless of the result.

RMBO : Reset Bit 0 in Base Page		4510	
M(0) ← 0			
NZ I CDV E			
Addressing Mode	AssemblyCode	Bytes	Cycles
base-page	RMBO \$nn	07 2	4 ^{br}

^bAdd one cycle if branch is taken.

ⁱAdd one more cycle if branch taken crosses a page boundary.

^rAdd one cycle if clock speed is at 40 MHz.

RMB1

This instruction clears bit 1 of the indicated address. No flags are modified, regardless of the result.

RMB1 : Reset Bit 1 in Base Page			4510		
M(1) ← 0					
NZ I CDV E					
Addressing Mode	AssemblyCode	Bytes	Cycles		
base-page	RMB1 \$nn	17	2	4	<i>br</i>

*b*Add one cycle if branch is taken.

Add one more cycle if branch taken crosses a page boundary.

*r*Add one cycle if clock speed is at 40 MHz.

RMB2

This instruction clears bit 2 of the indicated address. No flags are modified, regardless of the result.

RMB2 : Reset Bit 2 in Base Page			4510		
M(2) ← 0					
NZ I CDV E					
Addressing Mode	AssemblyCode	Bytes	Cycles		
base-page	RMB2 \$nn	27	2	4	<i>r</i>

*r*Add one cycle if clock speed is at 40 MHz.

RMB3

This instruction clears bit 3 of the indicated address. No flags are modified, regardless of the result.

RMB3 : Reset Bit 3 in Base Page			4510		
M(3) ← 0					
NZ I CDV E					
Addressing Mode	AssemblyCode	Bytes	Cycles		
base-page	RMB3 \$nn	37	2	4	<i>r</i>

*r*Add one cycle if clock speed is at 40 MHz.

RMB4

This instruction clears bit 4 of the indicated address. No flags are modified, regardless of the result.

RMB4 : Reset Bit 4 in Base Page		4510			
M(4) ← 0		NZ I CDV E			
Addressing Mode	AssemblyCodeBytesCycles				
base-page	RMB4 \$nn	47	2	4	<i>r</i>

*r*Add one cycle if clock speed is at 40 MHz.

RMB5

This instruction clears bit 5 of the indicated address. No flags are modified, regardless of the result.

RMB5 : Reset Bit 5 in Base Page		4510			
M(5) ← 0		NZ I CDV E			
Addressing Mode	AssemblyCodeBytesCycles				
base-page	RMB5 \$nn	57	2	4	<i>r</i>

*r*Add one cycle if clock speed is at 40 MHz.

RMB6

This instruction clears bit 6 of the indicated address. No flags are modified, regardless of the result.

RMB6 : Reset Bit 6 in Base Page		4510			
M(6) ← 0		NZ I CDV E			
Addressing Mode	AssemblyCodeBytesCycles				
base-page	RMB6 \$nn	67	2	5	<i>r</i>

*r*Add one cycle if clock speed is at 40 MHz.

RMB7

This instruction clears bit 7 of the indicated address. No flags are modified, regardless of the result.

RMB7 : Reset Bit 7 in Base Page		4510	
M(7) ← 0			
NZ I CDV E			
Addressing Mode	Assembly	Code	BytesCycles
base-page	RMB7 \$nn	77	2

ROL

This instruction shifts either the Accumulator or contents of the provided memory location one bit left. Bit 0 will be set to the current value of the Carry Flag, and the bit 7 will be shifted out into the Carry Flag

Side effects

- The N flag will be set if the result is negative, i.e., if bit 7 is set after the operation, else it will be cleared.
- The Z flag will be set if the result is zero, else it will be cleared.
- The C flag will be set if bit 7 of the value was set, prior to being shifted.

ROL : Rotate Left Memory or Accumulator		4510	
M ← M<<1, C ← M(7), M(0) ← C			
NZ I CDV E + + . + . . .			
Addressing Mode	Assembly	Code	BytesCycles
base-page	ROL \$nn	26	2 4 ^r
accumulator	ROL A	2A	1 1 ^s
absolute	ROL \$nnnn	2E	3 5 ^r
base-page,X	ROL \$nn,X	36	2 5 ^{pr}
absolute,X	ROL \$nnnn,X	3E	3 5 ^{pr}

^pAdd one cycle if indexing crosses a page boundary.

^rAdd one cycle if clock speed is at 40 MHz.

^sInstruction requires 2 cycles when CPU is run at 1MHz or 2MHz.

ROR

This instruction shifts either the Accumulator or contents of the provided memory location one bit right. Bit 7 will be set to the current value of the Carry Flag, and the bit 0 will be shifted out into the Carry Flag

Side effects

- The N flag will be set if the result is negative, i.e., if bit 7 is set after the operation, else it will be cleared.
- The Z flag will be set if the result is zero, else it will be cleared.
- The C flag will be set if bit 7 of the value was set, prior to being shifted.

ROR : Rotate Right Memory or Accumulator			4510		
$M \leftarrow M \gg 1, C \leftarrow M(0), M(7) \leftarrow C$					
			NZ I CDV E		
			++ · + · · ·		
Addressing Mode	Assembly	Code	Bytes	Cycles	
base-page	ROR \$nn	66	2	5	<i>r</i>
accumulator	ROR A	6A	1	1	<i>s</i>
absolute	ROR \$nnnn	6E	3	6	<i>r</i>
base-page,X	ROR \$nn,X	76	2		
absolute,X	ROR \$nnnn,X	7E	3		

*r*Add one cycle if clock speed is at 40 MHz.

*s*Instruction requires 2 cycles when CPU is run at 1MHz or 2MHz.

ROW

This instruction rotates the contents of the indicated memory word one bit left. Bit 0 of the low byte will be set to the current value of the Carry Flag, and the bit 7 of the high byte will be shifted out into the Carry Flag

Side effects

- The N flag will be set if the result is negative, i.e., if bit 7 is set after the operation, else it will be cleared.
- The Z flag will be set if the result is zero, else it will be cleared.
- The C flag will be set if bit 7 of the upper byte was set, prior to being shifted.

ROW : Rotate Word Left		4510	
M2:M1 \leftarrow M2:M1 \ll 1, C \leftarrow M2(7), M1(0) \leftarrow C			
NZ I CDV E			
+ . + . . .			
Addressing Mode	Assembly Code	Bytes	Cycles
absolute	ROW \$nnnn EB	3	

RTI

This instruction pops the processor flags from the stack, and then pops the Program Counter (PC) register from the stack, allowing an interrupted program to resume.

- The 6502 Processor Flags are restored from the stack.
- Neither the B (Software Interrupt) nor E (Extended Stack) flags are set by this instruction.

RTI : Return From Interrupt		4510	
P \leftarrow STACK, PC \leftarrow STACK, SP \leftarrow SP + 3			
NZ I CDV E			
+ . + + + + .			
Addressing Mode	Assembly Code	Bytes	Cycles
implied	RTI	40	1 6 ^m

m Subtract non-bus cycles when at 40MHz.

RTS

This instruction adds optional argument to the Stack Pointer (SP) Register, and then pops the Program Counter (PC) register from the stack, allowing a routine to return to its caller.

RTS : Return From Subroutine		4510	
PC \leftarrow STACK + N, SP \leftarrow SP + 2 + N			
NZ I CDV E			
.			
Addressing Mode	Assembly Code	Bytes	Cycles
implied	RTS	60	1 6 ^m
immediate	RTS #\$nn	62	2 4

m Subtract non-bus cycles when at 40MHz.

SBC

This instruction performs $A - M - 1 + C$, and sets the processor flags accordingly. The result is stored in the Accumulator Register.

NOTE: This instruction is affected by the status of the Decimal Flag.

Side effects

- The N flag will be set if the result of $A - M$ is negative, i.e. bit 7 is set in the result, else it will be cleared.
- The C flag will be set if the result of $A - M$ is zero or positive, i.e., if A is not less than M, else it will be cleared.
- The V flag will be set if the result has a different sign to both of the arguments, else it will be cleared. If the flag is set, this indicates that a signed overflow has occurred.
- The Z flag will be set if the result of $A - M$ is zero, else it will be cleared.

SBC : Subtract With Carry		4510		
$A \leftarrow -M - 1 + C$				
		NZ I CDV E		
		++ · + · + ·		
Addressing Mode	Assembly	Code	Bytes	Cycles
(indirect),X	SBC (\$nn,X)	E1	2	
base-page	SBC \$nn	E5	2	
immediate	SBC #\$nn	E9	2	
absolute	SBC \$nnnn	ED	3	
(indirect),Y	SBC (\$nn),Y	F1	2	
(indirect),Z	SBC (\$nn),Z	F2	2	
base-page,X	SBC \$nn,X	F5	2	
absolute,Y	SBC \$nnnn,Y	F9	3	
absolute,X	SBC \$nnnn,X	FD	3	

SEC

This instruction sets the Carry Flag.

Side effects

- The C flag is set.

SEC : Set Carry Flag		4510	
C ← 1		NZ I CDV E	
Addressing Mode	AssemblyCode	Bytes	Cycles
implied	SEC	38	1 1 ^s

Instruction requires 2 cycles when CPU is run at 1MHz or 2MHz.

SED

This instruction sets the Decimal Flag. Binary arithmetic will now use Binary-Coded Decimal (BCD) mode.

NOTE: The C64's interrupt handler does not clear the Decimal Flag, which makes it dangerous to set the Decimal Flag without first setting the Interrupt Disable Flag.

Side effects

- The D flag is set.

SED : Set Decimal Flag		4510	
D ← 1		NZ I CDV E	
Addressing Mode	AssemblyCode	Bytes	Cycles
implied	SED	F8	1

SEE

This instruction sets the Extended Stack Disable Flag. This causes the stack to operate as on the 6502, i.e., limited to a single page of memory. The page of memory in which the stack is located can still be modified by setting the Stack Pointer High (SPH) Register.

Side effects

- The E flag is set.

SEE : Set Extended Stack Disable Flag		4510	
E ← 1		NZ I CDV E	
Addressing Mode	AssemblyCode	Bytes	Cycles
implied	SEE	03	1 1 ^s

^sInstruction requires 2 cycles when CPU is run at 1MHz or 2MHz.

SEI

This instruction sets the Interrupt Disable Flag. Normal (IRQ) interrupts will no longer be able to occur. Non-Maskable Interrupts (NMI) will continue to occur, as their name suggests.

Side effects

- The I flag is set.

SEI : Set Interrupt Disable Flag		4510	
I ← 1		NZ I CDV E	
Addressing Mode	AssemblyCode	Bytes	Cycles
implied	SEI	78	1

SMB0

This instruction sets bit zero of the indicated address. No flags are modified, regardless of the result.

SMB0 : Set Bit 0 in Base Page		4510	
M(0) ← 1		NZ I CDV E	
Addressing Mode	AssemblyCode	Bytes	Cycles
base-page	SMB0 \$nn	87	2

SMB1

This instruction sets bit 1 of the indicated address. No flags are modified, regardless of the result.

SMB1 : Set Bit 1 in Base Page		4510
M(1) ← 1		
NZ I CDV E		
.		
Addressing Mode	AssemblyCode	BytesCycles
base-page	SMB1 \$nn 97	2

SMB2

This instruction sets bit 2 of the indicated address. No flags are modified, regardless of the result.

SMB2 : Set Bit 2 in Base Page		4510
M(2) ← 1		
NZ I CDV E		
.		
Addressing Mode	AssemblyCode	BytesCycles
base-page	SMB2 \$nn A7	2

SMB3

This instruction sets bit 3 of the indicated address. No flags are modified, regardless of the result.

SMB3 : Set Bit 3 in Base Page		4510
M(3) ← 1		
NZ I CDV E		
.		
Addressing Mode	AssemblyCode	BytesCycles
base-page	SMB3 \$nn B7	2

SMB4

This instruction sets bit 4 of the indicated address. No flags are modified, regardless of the result.

SMB4 : Set Bit 4 in Base Page		4510
$M(4) \leftarrow 1$		
		NZ I CDV E
	
Addressing Mode	AssemblyCode	BytesCycles
base-page	SMB4 \$nn C7	2

SMB5

This instruction sets bit 5 of the indicated address. No flags are modified, regardless of the result.

SMB5 : Set Bit 5 in Base Page		4510
$M(5) \leftarrow 1$		
		NZ I CDV E
	
Addressing Mode	AssemblyCode	BytesCycles
base-page	SMB5 \$nn D7	2

SMB6

This instruction sets bit 6 of the indicated address. No flags are modified, regardless of the result.

SMB6 : Set Bit 6 in Base Page		4510
$M(6) \leftarrow 1$		
		NZ I CDV E
	
Addressing Mode	AssemblyCode	BytesCycles
base-page	SMB6 \$nn E7	2

SMB7

This instruction sets bit 7 of the indicated address. No flags are modified, regardless of the result.

SMB7 : Set Bit 7 in Base Page		4510	
M(7) ← 1			
NZ I CDV E			
Addressing Mode	Assembly	CodeBytes	Cycles
base-page	SMB7 \$nn F7	2	

STA

This instruction stores the contents of the Accumulator Register into the indicated location.

STA : Store Accumulator		4510	
M ← A			
NZ I CDV E			
Addressing Mode	Assembly	CodeBytes	Cycles
(indirect,X)	STA (\$nn,X)	81 2	
(indirect,SP),Y	STA (\$nn,SP),Y	82 2	
base-page	STA \$nn	85 2	
absolute	STA \$nnnn	8D 3	
(indirect),Y	STA (\$nn),Y	91 2	
(indirect),Z	STA (\$nn),Z	92 2	
base-page,X	STA \$nn,X	95 2	
absolute,Y	STA \$nnnn,Y	99 3	
absolute,X	STA \$nnnn,X	9D 3	

STX

This instruction stores the contents of the X Register into the indicated location.

STX : Store X Register			4510	
$M \leftarrow X$				
NZ I CDV E				
Addressing Mode	Assembly	Code	Bytes	Cycles
base-page	STX \$nn	86	2	
absolute	STX \$nnnn	8E	3	
base-page,Y	STX \$nn,Y	96	2	
absolute,Y	STX \$nnnn,Y	9B	3	

STY

This instruction stores the contents of the Y Register into the indicated location.

STY : Store Y Register			4510	
$M \leftarrow Y$				
NZ I CDV E				
Addressing Mode	Assembly	Code	Bytes	Cycles
base-page	STY \$nn	84	2	
absolute,X	STY \$nnnn,X	8B	3	
absolute	STY \$nnnn	8C	3	
base-page,X	STY \$nn,X	94	2	

STZ

This instruction stores the contents of the Z Register into the indicated location.

STZ : Store Z Register			4510	
$M \leftarrow Z$				
NZ I CDV E				
Addressing Mode	Assembly	Code	Bytes	Cycles
base-page	STZ \$nn	64	2	3
base-page,X	STZ \$nn,X	74	2	3
absolute	STZ \$nnnn	9C	3	
absolute,X	STZ \$nnnn,X	9E	3	

TAB

This instruction sets the Base Page register to the contents of the Accumulator Register. This allows the relocation of the 6502's Zero-Page into any page of memory.

TAB : Transfer Accumulator into Base Page Register 4510					
B ← A					
			NZ I CD		VE
			· · · · ·		· ·
Addressing Mode	AssemblyCode	Bytes	Cycles		
implied	TAB	5B	1	1	^s

^sInstruction requires 2 cycles when CPU is run at 1MHz or 2MHz.

TAX

This instruction loads the X Register with the contents of the Accumulator Register.

Side effects

- The N flag will be set if the result is negative, else it will be cleared.
- The Z flag will be set if the result is zero, else it will be cleared.

TAX : Transfer Accumulator Register into the X Register 4510					
X ← A					
			NZ I CD		VE
			++ · · ·		· ·
Addressing Mode	AssemblyCode	Bytes	Cycles		
implied	TAX	AA	1		

TAY

This instruction loads the Y Register with the contents of the Accumulator Register.

Side effects

- The N flag will be set if the result is negative, else it will be cleared.
- The Z flag will be set if the result is zero, else it will be cleared.

TAY : Transfer Accumulator Register into the Y Register4510

Y ← A

NZ	I	CD	VE
++	·	·	·

Addressing Mode	Assembly Code	Bytes	Cycles
implied	TAY	A8	1

TAZ

This instruction loads the Z Register with the contents of the Accumulator Register.

Side effects

- The N flag will be set if the result is negative, else it will be cleared.
- The Z flag will be set if the result is zero, else it will be cleared.

TAZ : Transfer Accumulator Register into the Z Register4510

Z ← A

NZ	I	CD	VE
++	·	·	·

Addressing Mode	Assembly Code	Bytes	Cycles
implied	TAZ	4B	1

^sInstruction requires 2 cycles when CPU is run at 1MHz or 2MHz.

TBA

This instruction loads the Accumulator Register with the contents of the Base Page Register.

Side effects

- The N flag will be set if the result is negative, else it will be cleared.
- The Z flag will be set if the result is zero, else it will be cleared.

TBA : Transfer Base Page Register into the Accumulator 45 10

A ← B

NZ I CD **VE**
 ++

Addressing Mode	Assembly	Code	Bytes	Cycles
implied	TBA	7B	1	

TRB

This instruction sets performs a binary AND of the negation of the Accumulator Register and the indicated memory location, storing the result there. That is, any bits set in the Accumulator Register will be reset in the indicated memory location.

It also performs a test for any bits in common between the accumulator and indicated memory location. This can be used to construct simple shared-memory multi-processor systems, by providing an atomic means of setting a semaphore or acquiring a lock.

Side effects

- The Z flag will be set if the binary AND of the Accumulator Register and contents of the indicated memory location prior are zero, prior to the execution of the instruction.

TRB : Test and Reset Bit 45 10

M ← M AND (NOT A)

NZ I CDV E
 . +

Addressing Mode	Assembly	Code	Bytes	Cycles
base-page	TRB \$nn	14	2	5 ^r
absolute	TRB \$nnnn	1C	3	4 ^r

^rAdd one cycle if clock speed is at 40 MHz.

TSB

This instruction sets performs a binary OR of the Accumulator Register and the indicated memory location, storing the result there. That is, any bits set in the Accumulator Register will be set in the indicated memory location.

It also performs a test for any bits in common between the accumulator and indicated memory location. This can be used to construct simple shared-memory multi-processor systems, by providing an atomic means of setting a semaphore or acquiring a lock.

Side effects

- The Z flag will be set if the binary AND of the Accumulator Register and contents of the indicated memory location prior are zero, prior to the execution of the instruction.

TSB : Test and Set Bit				4510	
$M \leftarrow M \text{ OR } A$					
				NZ I CDV E	
				· + · · · · ·	
Addressing Mode	AssemblyCode	Bytes	Cycles		
base-page	TSB \$nn	04	2	3	<i>r</i>
absolute	TSB \$nnnn	0C	3	5	<i>r</i>

*r*Add one cycle if clock speed is at 40 MHz.

TSX

This instruction loads the X Register with the contents of the Stack Pointer High (SPL) Register.

Side effects

- The N flag will be set if the result is negative, else it will be cleared.
- The Z flag will be set if the result is zero, else it will be cleared.

TSX : Transfer Stack Pointer High Register into the X Register				4510	
$X \leftarrow \text{SPH}$					
				NZ I CD	
				VE	
				++ · · · · ·	
Addressing Mode	AssemblyCode	Bytes	Cycles		
implied	TSX	BA	1		

TSY

This instruction loads the Y Register with the contents of the Stack Pointer High (SPH) Register.

Side effects

- The N flag will be set if the result is negative, else it will be cleared.

- The Z flag will be set if the result is zero, else it will be cleared.

TSY : Transfer Stack Pointer High Register into the Y Register 45 10					
Y ← SPH					
		NZ I CD		VE	
		++	
Addressing Mode	AssemblyCodeBytes		Cycles		
implied	TSY	0B	1	1	^s

^sInstruction requires 2 cycles when CPU is run at 1MHz or 2MHz.

TXA

This instruction loads the Accumulator Register with the contents of the X Register.

Side effects

- The N flag will be set if the result is negative, else it will be cleared.
- The Z flag will be set if the result is zero, else it will be cleared.

TXA : Transfer X Register into the Accumulator Register 45 10					
A ← X					
		NZ I CD		VE	
		++	
Addressing Mode	AssemblyCodeBytes		Cycles		
implied	TXA	8A	1		

TXS

This instruction sets the low byte of the Stack Pointer (SPL) register to the contents of the X Register.

TXS : Transfer X Register into Stack Pointer Low Register 45 10					
SPL ← X					
		NZ I CD		VE	
		
Addressing Mode	AssemblyCodeBytes		Cycles		
implied	TXS	9A	1		

TYA

This instruction loads the Accumulator Register with the contents of the Y Register.

Side effects

- The N flag will be set if the result is negative, else it will be cleared.
- The Z flag will be set if the result is zero, else it will be cleared.

TYA : Transfer Y Register into the Accumulator Register4510					
A ← Y					
		NZ I CD		VE	
		++	
Addressing Mode	AssemblyCode	Bytes	Cycles		
implied	TYA	98	1		

TYS

This instruction sets the high byte of the Stack Pointer (SPH) register to the contents of the Y Register. This allows changing the memory page where the stack is located (if the Extended Stack Disable Flag (E) is set), or else allows setting the current Stack Pointer to any page in memory, if the Extended Stack Disable Flag (E) is clear.

TYS : Transfer Y Register into Stack Pointer High Register4510						
SPH ← Y						
		NZ I CD			VE	
		
Addressing Mode	AssemblyCode	Bytes	Cycles			
implied	TYS	2B	1	1	<i>s</i>	

*s*Instruction requires 2 cycles when CPU is run at 1MHz or 2MHz.

TZA

This instruction loads the Accumulator Register with the contents of the Z Register.

Side effects

- The N flag will be set if the result is negative, else it will be cleared.
- The Z flag will be set if the result is zero, else it will be cleared.

TZA : Transfer Z Register into the Accumulator Register4510

A ← Z

NZ I CD	VE
+ +

Addressing Mode	AssemblyCode	Bytes	Cycles
implied	TZA	6B 1	1 ^s

^sInstruction requires 2 cycles when CPU is run at 1MHz or 2MHz.

45GS02 COMPOUND INSTRUCTIONS

As the 4510 has no unallocated opcodes, the 45GS02 uses compound instructions to implement its extension. These compound instructions consist of one or more single byte instructions placed immediately before a conventional instruction. These prefixes instruct the 45GS02 to treat the following instruction differently, as described in Chapter/Appendix G on page G-3.

ADC

This instruction adds the argument to the contents of the Accumulator Register and the Carry Flag. If the D flag is set, then the addition is performed using Binary Coded Decimal.

Side effects

- The N flag will be set if the result is negative, else it will be cleared.
- The Z flag will be set if the result is zero, else it will be cleared.
- The V flag will be set if the result has a different sign to both of the arguments, else it will be cleared. If the flag is set, this indicates that a signed overflow has occurred.
- The C flag will be set if the unsigned result is >255, or >99 if the D flag is set.

ADC : Add with carry			45GS02	
A ← A+M+C				
NZ I CDV E ++ · + · + ·				
Addressing Mode	Assembly Code	Bytes	Cycles	
No description	ADC [\$nn],ZEA	72 0	7	<i>i</i> ^r

*i*Add one cycle if clock speed is at 40 MHz.

*p*Add one cycle if indexing crosses a page boundary.

*r*Add one cycle if clock speed is at 40 MHz.

ADCQ

This instruction adds the argument to the contents of the 32-bit Q pseudo-register Register and the Carry Flag. If the D flag is set, then the operation is undefined, and is subject to change.

Side effects

- The N flag will be set if the result is negative, else it will be cleared.
- The Z flag will be set if the result is zero, else it will be cleared.
- The V flag will be set if the result has a different sign to both of the arguments, else it will be cleared. If the flag is set, this indicates that a signed overflow has occurred.
- The C flag will be set if the unsigned result is >255 if the D flag is clear.

ADCQ : Add with carry			45GS02	
Q ← Q+M+C				
NZ I CDV E ++ · + · + ·				
Addressing Mode	Assembly Code	Bytes	Cycles	
base-page quad	ADCQ \$nn	42 42 65	4	8 <i>r</i>
absolute quad	ADCQ \$nnnn	42 42 6D	5	9 <i>r</i>
(indirect quad)	ADCQ (\$nn)	42 42 72	4	10 <i>i</i> ^r
[indirect quad]	ADCQ [\$nn]	42 42 EA 72	5	13 <i>i</i> ^r

*i*Add one cycle if clock speed is at 40 MHz.

*p*Add one cycle if indexing crosses a page boundary.

*r*Add one cycle if clock speed is at 40 MHz.

AND

This instructions performs a binary AND operation of the argument with the accumulator, and stores the result in the accumulator. Only bits that were already set in the accumulator, and that are set in the argument will be set in the accumulator on completion.

Side effects

- The N flag will be set if the result is negative, else it will be cleared.
- The Z flag will be set if the result is zero, else it will be cleared.

AND : Binary AND		45GS02		
$A \leftarrow A \text{ AND } M$		NZ I CDV E		
		++		
Addressing Mode	Assembly Code	Bytes	Cycles	
No description	AND [\$nn],ZEA	32	0	7 ^{<i>i</i>} _{<i>p</i>} ^{<i>r</i>}

*i*Add one cycle if clock speed is at 40 MHz.

*p*Add one cycle if indexing crosses a page boundary.

*r*Add one cycle if clock speed is at 40 MHz.

ANDQ

This instructions performs a binary AND operation of the argument with the Q pseudo register, and stores the result in the accumulator. Only bits that were already set in the Q pseudo register, and that are set in the argument will be set in the Q pseudo register on completion.

Note that the indicated memory location is treated as the first byte of a 32-bit little-endian value.

Side effects

- The N flag will be set if the result is negative, else it will be cleared.
- The Z flag will be set if the result is zero, else it will be cleared.

ANDQ : Binary AND			45GS02		
$Q \leftarrow Q \text{ AND } M$					
NZ I CDV E					
++					
Addressing Mode	Assembly Code	Code	Bytes	Cycles	
base-page quad	ANDQ \$nn	42 42 25	4	8	<i>r</i>
absolute quad	ANDQ \$nnnn	42 42 2D	5	9	<i>r</i>
(indirect quad)	ANDQ (\$nn)	42 42 32	4	10	<i>ipr</i>
[indirect quad]	ANDQ [\$nn]	42 42 EA 32	5	13	<i>ipr</i>

*i*Add one cycle if clock speed is at 40 MHz.

*p*Add one cycle if indexing crosses a page boundary.

*r*Add one cycle if clock speed is at 40 MHz.

ASLQ

This instruction shifts either the Q pseudo-register or contents of the provided memory location and following three one bit left, treating them as holding a little-endian 32-bit value. Bit 0 will be set to zero, and the bit i31 will be shifted out into the Carry Flag

Side effects

- The N flag will be set if the result is negative, i.e., if bit 7 is set after the operation, else it will be cleared.
- The Z flag will be set if the result is zero, else it will be cleared.
- The C flag will be set if bit 7 of the value was set, prior to being shifted.

ASLQ : Arithmetic Shift Left**45GS02** $Q \leftarrow Q \ll 1$ or $M \leftarrow M \ll 1$ **NZ I CDV E**

+ + . + . . .

Addressing Mode	Assembly	Code	Bytes	Cycles	
base-page quad	ASLQ \$nn	42 42 06	4	12	<i>dmr</i>
Q Pseudo Register	ASLQ Q	42 42 0A	3	3	
absolute quad	ASLQ \$nnnn	42 42 0E	5	13	<i>dmr</i>
base-page quad,X	ASLQ \$nn,X	42 42 16	4	12	<i>dmpr</i>
absolute quad,X	ASLQ \$nnnn,X	42 42 1E	5	13	<i>dmpr</i>

*d*Subtract one cycle when CPU is at 3.5MHz.*m*Subtract non-bus cycles when at 40MHz.*p*Add one cycle if indexing crosses a page boundary.*r*Add one cycle if clock speed is at 40 MHz.

ASRQ

This instruction shifts either the Q pseudo-register or contents of the provided memory location and following three one bit left, treating them as holding a little-endian 32-bit value. Bit 0 will be set to zero, and the bit i31 will be shifted out into the Carry Flag

Side effects

- The N flag will be set if the result is negative, i.e., if bit 7 is set after the operation, else it will be cleared.
- The Z flag will be set if the result is zero, else it will be cleared.
- The C flag will be set if bit 7 of the value was set, prior to being shifted.

ASRQ : Arithmetic Shift Left			45GS02		
$Q \leftarrow Q \ll 1$ or $M \leftarrow M \ll 1$					
			NZ I CDV E		
				
Addressing Mode	Assembly Code	Bytes	Cycles		
Q Pseudo Register	ASRQ Q	42 42 43	3	3	
base-page quad	ASRQ \$nn	42 42 44	4	12	<i>dmr</i>
base-page quad,X	ASRQ \$nn,X	42 42 54	4	12	<i>dmpr</i>

d Subtract one cycle when CPU is at 3.5MHz.

m Subtract non-bus cycles when at 40MHz.

p Add one cycle if indexing crosses a page boundary.

r Add one cycle if clock speed is at 40 MHz.

BITQ

This instruction is used to test the bits stored in a memory location and following three, treating them as holding a little-endian 32-bit value. Bits 30 and 31 of the memory location's contents are directly copied into the Overflow Flag and Negative Flag. The Zero Flag is set or cleared based on the result of performing the binary AND of the Q Register and the contents of the indicated memory location.

Side effects

- The N flag will be set if the bit 31 of the memory location is set, else it will be cleared.
- The V flag will be set if the bit 30 of the memory location is set, else it will be cleared.
- The Z flag will be set if the result of $Q \text{ AND } M$ is zero, else it will be cleared.

BITQ : Perform Bit Test			45GS02		
$N \leftarrow M(31), V \leftarrow M(30), Z \leftarrow Q \text{ AND } M$					
			NZ I CDV E		
			+ + . . . + .		
Addressing Mode	Assembly Code	Bytes	Cycles		
base-page quad	BITQ \$nn	42 42 24	4	8	<i>r</i>
absolute quad	BITQ \$nnnn	42 42 2C	5	9	<i>r</i>

r Add one cycle if clock speed is at 40 MHz.

CMP

This instruction performs $A - M$, and sets the processor flags accordingly, but does not modify the contents of the Accumulator Register.

Side effects

- The N flag will be set if the result of $A - M$ is negative, i.e. bit 7 is set in the result, else it will be cleared.
- The C flag will be set if the result of $A - M$ is zero or positive, i.e., if A is not less than M, else it will be cleared.
- The Z flag will be set if the result of $A - M$ is zero, else it will be cleared.

CMP : Compare Accumulator		45GS02	
		NZ I CDV E	
		++ · + · · ·	
Addressing Mode	Assembly	Code Bytes	Cycles
No description	CMP [\$nn],ZEA D2	0	7 ^{<i>ipr</i>}

*i*Add one cycle if clock speed is at 40 MHz.

*p*Add one cycle if indexing crosses a page boundary.

*r*Add one cycle if clock speed is at 40 MHz.

CMPQ

This instruction performs $Q - M$, and sets the processor flags accordingly, but does not modify the contents of the Q Register. The memory location is treated as the address of a little-endian 32-bit value.

Side effects

- The N flag will be set if the result of $A - M$ is negative, i.e. bit 31 is set in the result, else it will be cleared.
- The C flag will be set if the result of $A - M$ is zero or positive, i.e., if A is not less than M, else it will be cleared.
- The Z flag will be set if the result of $A - M$ is zero, else it will be cleared.

CMPO : Compare Q Pseudo Register**45GS02****NZ I CDV E**

++ . + . . .

Addressing Mode	Assembly Code	Bytes	Cycles
base-page quad	CMPO \$nn	42 42 C5	4 8 <i>r</i>
absolute quad	CMPO \$nnnn	42 42 CD	5 9 <i>r</i>
(indirect quad)	CMPO (\$nn)	42 42 D2	4 10 <i>ipr</i>
[indirect quad]	CMPO [\$nn]	42 42 EA D2	5 13 <i>ipr</i>

*i*Add one cycle if clock speed is at 40 MHz.*p*Add one cycle if indexing crosses a page boundary.*r*Add one cycle if clock speed is at 40 MHz.

DEQ

This instruction decrements the Accumulator Register or indicated memory location.

Note that the indicated memory location is treated as the first byte of a 32-bit little-endian value.

Side effects

- The N flag will be set if the result is negative, else it will be cleared.
- The Z flag will be set if the result is zero, else it will be cleared.

DEQ : Decrement Memory or Q**45GS02** $Q \leftarrow Q - 1$ or $M \leftarrow M - 1$ **NZ I CDV E**

++

Addressing Mode	Assembly Code	Bytes	Cycles
Q Pseudo Register	DEQ Q	42 42 3A	3 3
base-page quad	DEQ \$nn	42 42 C6	4 12 <i>dmr</i>
absolute quad	DEQ \$nnnn	42 42 CE	5 13 <i>dmr</i>
base-page quad,X	DEQ \$nn,X	42 42 D6	4 12 <i>dmpr</i>
absolute quad,X	DEQ \$nnnn,X	42 42 DE	5 13 <i>dmpr</i>

*d*Subtract one cycle when CPU is at 3.5MHz.*m*Subtract non-bus cycles when at 40MHz.*p*Add one cycle if indexing crosses a page boundary.*r*Add one cycle if clock speed is at 40 MHz.

EOR

This instructions performs a binary XOR operation of the argument with the accumulator, and stores the result in the accumulator. Only bits that were already set in the accumulator, or that are set in the argument will be set in the accumulator on completion, but not both.

Side effects

- The N flag will be set if the result is negative, else it will be cleared.
- The Z flag will be set if the result is zero, else it will be cleared.

EOR : Binary Exclusive OR		45GS02		
$A \leftarrow A \text{ XOR } M$		NZ I CDV E		
		++		
Addressing Mode	Assembly Code	Bytes	Cycles	
No description	EOR [\$nn],ZEA	52	0	7 ^{<i>ipr</i>}

*i*Add one cycle if clock speed is at 40 MHz.

*p*Add one cycle if indexing crosses a page boundary.

*r*Add one cycle if clock speed is at 40 MHz.

EORQ

This instructions performs a binary XOR operation of the argument with the Q pseudo register, and stores the result in the Q pseudo register. Only bits that were already set in the Q pseudo register, or that are set in the argument will be set in the accumulator on completion, but not bits that were set in both.

Side effects

- The N flag will be set if the result is negative, i.e., bit 31 is set, else it will be cleared.
- The Z flag will be set if the result is zero, else it will be cleared.

EORQ : Binary Exclusive OR				45GS02	
$Q \leftarrow Q \text{ XOR } M$				NZ I CDV E	
				++	
Addressing Mode	Assembly Code	Bytes	Cycles		
base-page quad	EORQ \$nn	42 42 45	4	8	<i>r</i>
absolute quad	EORQ \$nnnn	42 42 4D	5	9	<i>r</i>
(indirect quad)	EORQ (\$nn)	42 42 52	4	10	<i>ipr</i>
[indirect quad]	EORQ [\$nn]	42 42 EA 52	5	13	<i>ipr</i>

*i*Add one cycle if clock speed is at 40 MHz.

*p*Add one cycle if indexing crosses a page boundary.

*r*Add one cycle if clock speed is at 40 MHz.

INQ

This instruction increments the Q pseudo register or indicated memory location.

Note that the indicated memory location is treated as the first byte of a 32-bit little-endian value.

Side effects

- The N flag will be set if the result is negative, else it will be cleared.
- The Z flag will be set if the result is zero, else it will be cleared.

INQ : Increment Memory or Accumulator				45GS02	
$Q \leftarrow Q + 1 \text{ or } M \leftarrow M + 1$				NZ I CDV E	
				++	
Addressing Mode	Assembly Code	Bytes	Cycles		
Q Pseudo Register	INQ Q	42 42 1A	3	3	
base-page quad	INQ \$nn	42 42 E6	4	13	<i>dmr</i>
absolute quad	INQ \$nnnn	42 42 EE	5	14	<i>dmr</i>
base-page quad,X	INQ \$nn,X	42 42 F6	4	13	<i>dmpr</i>
absolute quad,X	INQ \$nnnn,X	42 42 FE	5	14	<i>dpr</i>

*d*Subtract one cycle when CPU is at 3.5MHz.

*m*Subtract non-bus cycles when at 40MHz.

*p*Add one cycle if indexing crosses a page boundary.

*r*Add one cycle if clock speed is at 40 MHz.

LDA

This instruction loads the Accumulator Register with the indicated value, or with the contents of the indicated location.

Side effects

- The N flag will be set if the result is negative, else it will be cleared.
- The Z flag will be set if the result is zero, else it will be cleared.

LDA : Load Accumulator		45GS02	
A ← M		NZ I CDV E	
		++	
Addressing Mode	Assembly Code	Bytes	Cycles
No description	LDA [\$nn],ZEA B2	0 7	<i>ipr</i>

*i*Add one cycle if clock speed is at 40 MHz.

*p*Add one cycle if indexing crosses a page boundary.

*r*Add one cycle if clock speed is at 40 MHz.

LDO

This instruction loads the Q pseudo register with the indicated value, or with the contents of the indicated location. As the Q register is an alias for A, X, Y and Z used together, this operation will set those four registers. A contains the least significant bits, X the next least significant, then Y, and Z contains the most significant bits.

Side effects

- The N flag will be set if the result is negative, i.e., bit 31 is set, else it will be cleared.
- The Z flag will be set if the result is zero, else it will be cleared.

LDQ : Load Q Pseudo Register			45GS02			
Q ← M						
			NZ I CDV E			
			++			
Addressing Mode	Assembly Code		Bytes	Cycles		
base-page quad	LDQ \$nn	42 42 A5	4	8	<i>r</i>	
absolute quad	LDQ \$nnnn	42 42 AD	5	9	<i>r</i>	
(indirect quad)	LDQ (\$nn)	42 42 B2	4	10	<i>i</i> <i>pr</i>	
[indirect quad]	LDQ [\$nn]	42 42 EA B2	5	13	<i>i</i> <i>pr</i>	

*i*Add one cycle if clock speed is at 40 MHz.

*p*Add one cycle if indexing crosses a page boundary.

*r*Add one cycle if clock speed is at 40 MHz.

LSRQ

This instruction shifts either the Q pseudo register or contents of the provided memory location one bit right. Bit 31 will be set to zero, and the bit 0 will be shifted out into the Carry Flag.

Note that the memory address is treated as the first address of a little-endian encoded 32-bit value.

Side effects

- The N flag will be set if the result is negative, i.e., if bit 31 is set after the operation, else it will be cleared.
- The Z flag will be set if the result is zero, else it will be cleared.
- The C flag will be set if bit 0 of the value was set, prior to being shifted.

LSRQ : Logical Shift Right				45GS02		
$Q \leftarrow Q \gg 1, C \leftarrow A(0) \text{ or } M \leftarrow M \gg 1$				NZ I CDV E		
				+ + . + . . .		
Addressing Mode	Assembly	Code	Bytes	Cycles		
base-page quad	LSRQ \$nn	42 42 46	4	12	<i>dmr</i>	
Q Pseudo Register	LSRQ Q	42 42 4A	3	3		
absolute quad	LSRQ \$nnnn	42 42 4E	5	13	<i>dmr</i>	
base-page quad,X	LSRQ \$nn,X	42 42 56	4	12	<i>dmpr</i>	
absolute quad,X	LSRQ \$nnnn,X	42 42 5E	5	13	<i>dmpr</i>	

d Subtract one cycle when CPU is at 3.5MHz.

m Subtract non-bus cycles when at 40MHz.

p Add one cycle if indexing crosses a page boundary.

r Add one cycle if clock speed is at 40 MHz.

ORA

This instructions performs a binary OR operation of the argument with the accumulator, and stores the result in the accumulator. Only bits that were already set in the accumulator, or that are set in the argument will be set in the accumulator on completion, or both.

Side effects

- The N flag will be set if the result is negative, else it will be cleared.
- The Z flag will be set if the result is zero, else it will be cleared.

ORA : Decrement Memory or Accumulator				45GS02		
$A \leftarrow A + 1 \text{ or } M \leftarrow M + 1$				NZ I CDV E		
				+ +		
Addressing Mode	Assembly	Code	Bytes	Cycles		
No description	ORA [\$nn],ZEA	12 0	7	<i>ipr</i>		

i Add one cycle if clock speed is at 40 MHz.

p Add one cycle if indexing crosses a page boundary.

r Add one cycle if clock speed is at 40 MHz.

ORQ

This instructions performs a binary OR operation of the argument with the Q pseudo register, and stores the result in the Q pseudo register. Only bits that were already set in the Q pseudo register, or that are set in the argument, or both, will be set in the Q pseudo register on completion.

Note that this operation treats the memory address as the first address of a 32-bit little-endian value. That is, the memory address and the three following will be used.

Side effects

- The N flag will be set if the result is negative, else it will be cleared.
- The Z flag will be set if the result is zero, else it will be cleared.

ORQ : Decrement Memory or Q			45GS02		
$Q \leftarrow Q + 1$ or $M \leftarrow M + 1$			NZ I CDV E		
			++		
Addressing Mode	Assembly Code	Bytes	Cycles		
base-page quad	ORQ \$nn	42 42 05	4	8	<i>r</i>
absolute quad	ORQ \$nnnn	42 42 0D	5	9	<i>r</i>
(indirect quad)	ORQ (\$nn)	42 42 12	4	10	<i>pr</i>
[indirect quad]	ORQ [\$nn]	42 42 EA 12	5	13	<i>pr</i>

*p*Add one cycle if indexing crosses a page boundary.

*r*Add one cycle if clock speed is at 40 MHz.

RESQ

These extended opcodes are reserved, and their function is undefined and subject to change in future revisions of the 45GS02. They should therefore not be used in any program.

RESQ : Reserved extended opcode**45GS02**

UNDEFINED

NZ I CDV E

.

Addressing Mode	Assembly	Code	Bytes	Cycles	
(indirect quad),X	RESQ (\$nn,X)	42 42 01	4	10	<i>ipr</i>
(indirect quad),Y	RESQ (\$nn),Y	42 42 11	4	10	<i>ipr</i>
base-page quad,X	RESQ \$nn,X	42 42 15	4	8	<i>pr</i>
absolute quad,Y	RESQ \$nnnn,Y	42 42 19	5	9	<i>pr</i>
absolute quad,X	RESQ \$nnnn,X	42 42 1D	5	9	<i>pr</i>
(indirect quad,X)	RESQ (\$nn,X)	42 42 21	4	10	<i>ir</i>
(indirect quad),Y	RESQ (\$nn),Y	42 42 31	4	10	<i>ipr</i>
base-page quad,X	RESQ \$nn,X	42 42 34	4	8	<i>pr</i>
base-page quad,X	RESQ \$nn,X	42 42 35	4	8	<i>pr</i>
absolute quad,Y	RESQ \$nnnn,Y	42 42 39	5	10	<i>pr</i>
absolute quad,X	RESQ \$nnnn,X	42 42 3C	5	9	<i>pr</i>
absolute quad,X	RESQ \$nnnn,X	42 42 3D	5	10	<i>pr</i>
(indirect quad,X)	RESQ (\$nn,X)	42 42 41	4	10	<i>ipr</i>
(indirect quad),Y	RESQ (\$nn),Y	42 42 51	4	10	<i>ipr</i>
base-page quad,X	RESQ \$nn,X	42 42 55	4	8	<i>pr</i>
absolute quad,Y	RESQ \$nnnn,Y	42 42 59	5	9	<i>pr</i>
absolute quad,X	RESQ \$nnnn,X	42 42 5D	5	9	<i>pr</i>
(indirect quad,X)	RESQ (\$nn,X)	42 42 61	4	10	<i>ir</i>
(indirect quad),Y	RESQ (\$nn),Y	42 42 71	4	10	<i>ipr</i>
base-page quad,X	RESQ \$nn,X	42 42 75	4	8	<i>pr</i>
absolute quad,Y	RESQ \$nnnn,Y	42 42 79	5	10	<i>pr</i>
absolute quad,X	RESQ \$nnnn,X	42 42 7D	5	10	<i>pr</i>

*i*Add one cycle if clock speed is at 40 MHz.*p*Add one cycle if indexing crosses a page boundary.*r*Add one cycle if clock speed is at 40 MHz.

ROLO

This instruction shifts either the Accumulator or contents of the provided memory location one bit left. Bit 0 will be set to the current value of the Carry Flag, and the bit 31 will be shifted out into the Carry Flag.

NOTE: The memory address is treated as the first address of a little-endian encoded 32-bit value.

Side effects

- The N flag will be set if the result is negative, i.e., if bit 31 is set after the operation, else it will be cleared.
- The Z flag will be set if the result is zero, else it will be cleared.
- The C flag will be set if bit 31 of the value was set, prior to being shifted.

ROLO : Rotate Left Memory or Q			45GS02			
$M \leftarrow M \ll 1, C \leftarrow M(31), M(0) \leftarrow C$						
			NZ I CDV E ++ · + · · ·			
Addressing Mode	Assembly	Code	Bytes	Cycles		
base-page quad	ROLO \$nn	42 42 26	4	12	<i>dmr</i>	
Q Pseudo Register	ROLO Q	42 42 2A	3	3		
absolute quad	ROLO \$nnnn	42 42 2E	5	13	<i>dmr</i>	
base-page quad,X	ROLO \$nn,X	42 42 36	4	12	<i>dmpr</i>	
absolute quad,X	ROLO \$nnnn,X	42 42 3E	5	13	<i>dmpr</i>	

*d*Subtract one cycle when CPU is at 3.5MHz.

*m*Subtract non-bus cycles when at 40MHz.

*p*Add one cycle if indexing crosses a page boundary.

*r*Add one cycle if clock speed is at 40 MHz.

RORQ

This instruction shifts either the Q pseudo register or contents of the provided memory location one bit right. Bit 31 will be set to the current value of the Carry Flag, and the bit 0 will be shifted out into the Carry Flag

Note that the address is treated as the first address of a little-endian 32-bit value.

Side effects

- The N flag will be set if the result is negative, i.e., if bit 31 is set after the operation, else it will be cleared.
- The Z flag will be set if the result is zero, else it will be cleared.
- The C flag will be set if bit 31 of the value was set, prior to being shifted.

RORQ : Rotate Right Memory or Accumulator**45GS02** $M \leftarrow M \gg 1, C \leftarrow M(0), M(31) \leftarrow C$ **NZ I CDV E**

+ + . + . . .

Addressing Mode	Assembly	Code	Bytes	Cycles	
base-page quad	RORQ \$nn	42 42 66	4	12	<i>dmr</i>
Q Pseudo Register	RORQ Q	42 42 6A	3	3	
absolute quad	RORQ \$nnnn	42 42 6E	5	13	<i>dmr</i>
base-page quad,X	RORQ \$nn,X	42 42 76	4	12	<i>dmpr</i>
absolute quad,X	RORQ \$nnnn,X	42 42 7E	5	13	<i>dmpr</i>

*d*Subtract one cycle when CPU is at 3.5MHz.*m*Subtract non-bus cycles when at 40MHz.*p*Add one cycle if indexing crosses a page boundary.*r*Add one cycle if clock speed is at 40 MHz.

RSVQ

These extended opcodes are reserved, and their function is undefined and subject to change in future revisions of the 45GS02. They should therefore not be used in any program.

RSVQ : Reserved extended opcode**45GS02**

UNDEFINED

NZ I CDV E

.

Addressing Mode	Assembly	Code	Bytes	Cycles	
(indirect quad,X)	RSVQ (\$nn,X)	42 42 8 1	4	10	<i>ip</i>
(indirect quad,SP),Y	RSVQ (\$nn,SP),Y	42 42 8 2	4	10	<i>ip</i>
(indirect quad),Y	RSVQ (\$nn),Y	42 42 9 1	4	10	<i>ip</i>
base-page quad,X	RSVQ \$nn,X	42 42 9 5	4	8	<i>p</i>
absolute quad,Y	RSVQ \$nnnn,Y	42 42 9 9	5	9	<i>p</i>
absolute quad,X	RSVQ \$nnnn,X	42 42 9 D	5	9	<i>p</i>
(indirect quad,X)	RSVQ (\$nn,X)	42 42 A 1	4	10	<i>ipr</i>
(indirect quad,X)	RSVQ (\$nn,X)	42 42 C 1	4	10	<i>ipr</i>
(indirect quad),Y	RSVQ (\$nn),Y	42 42 D 1	4	10	<i>ipr</i>
base-page quad,X	RSVQ \$nn,X	42 42 D 5	4	8	<i>pr</i>
absolute quad,Y	RSVQ \$nnnn,Y	42 42 D 9	5	9	<i>pr</i>
absolute quad,X	RSVQ \$nnnn,X	42 42 D D	5	9	<i>pr</i>
(indirect quad,X)	RSVQ (\$nn,X)	42 42 E 1	4	10	<i>ipr</i>
(indirect quad),Y	RSVQ (\$nn),Y	42 42 F 1	4	10	<i>ipr</i>
base-page quad,X	RSVQ \$nn,X	42 42 F 5	4	8	<i>pr</i>
absolute quad,Y	RSVQ \$nnnn,Y	42 42 F 9	5	8	<i>pr</i>
absolute quad,X	RSVQ \$nnnn,X	42 42 F D	5	9	<i>pr</i>

*i*Add one cycle if clock speed is at 40 MHz.*p*Add one cycle if indexing crosses a page boundary.*r*Add one cycle if clock speed is at 40 MHz.

SBC

This instruction performs $A - M - 1 + C$, and sets the processor flags accordingly. The result is stored in the Accumulator Register.

NOTE: This instruction is affected by the status of the Decimal Flag.

Side effects

- The N flag will be set if the result of $A - M$ is negative, i.e. bit 7 is set in the result, else it will be cleared.
- The C flag will be set if the result of $A - M$ is zero or positive, i.e., if A is not less than M, else it will be cleared.

- The V flag will be set if the result has a different sign to both of the arguments, else it will be cleared. If the flag is set, this indicates that a signed overflow has occurred.
- The Z flag will be set if the result of $A - M$ is zero, else it will be cleared.

SBC : Subtract With Carry		45GS02	
$A \leftarrow -M - 1 + C$			
NZ I CDV E			
++ · + · + ·			
Addressing Mode	Assembly Code	Bytes	Cycles
No description	SBC [\$nn],ZEA F2	0 8	<i>pr</i>

*p*Add one cycle if indexing crosses a page boundary.

*r*Add one cycle if clock speed is at 40 MHz.

SBCQ

This instruction performs $Q - M - 1 + C$, and sets the processor flags accordingly. The result is stored in the Q pseudoregister.

NOTE: that the indicated memory location is treated as the first byte of a 32-bit little-endian value.

NOTE: The decimal (D) flag must be clear. Operation is reserved when D flag is set.

Side effects

- The N flag will be set if the result of $A - M$ is negative, i.e. bit 31 is set in the result, else it will be cleared.
- The C flag will be set if the result of $A - M$ is zero or positive, i.e., if A is not less than M, else it will be cleared.
- The V flag will be set if the result has a different sign to both of the arguments, else it will be cleared. If the flag is set, this indicates that a signed overflow has occurred.
- The Z flag will be set if the result of $A - M$ is zero, else it will be cleared.

SBCQ : Subtract With Carry				45GS02	
$Q \leftarrow -M - 1 + C$					
				NZ I CDV E	
				+ + · + · + ·	
Addressing Mode	Assembly Code	Code	Bytes	Cycles	
base-page quad	SBCQ \$nn	42 42 E5	4	8	<i>r</i>
absolute quad	SBCQ \$nnnn	42 42 ED	5	9	<i>r</i>
(indirect quad)	SBCQ (\$nn)	42 42 F2	4	10	<i>ipr</i>
[indirect quad]	SBCQ [\$nn]	42 42 EA F2	5	13	<i>ipr</i>

*i*Add one cycle if clock speed is at 40 MHz.

*p*Add one cycle if indexing crosses a page boundary.

*r*Add one cycle if clock speed is at 40 MHz.

STA

This instruction stores the contents of the Accumulator Register into the indicated location.

STA : Store Accumulator				45GS02	
$M \leftarrow A$					
				NZ I CDV E	
				· · · · ·	
Addressing Mode	Assembly Code	Code	Bytes	Cycles	
No description	STA [\$nn],ZEA	92 0	0	8	<i>ip</i>

*i*Add one cycle if clock speed is at 40 MHz.

*p*Add one cycle if indexing crosses a page boundary.

STQ

This instruction stores the contents of the Q pseudo register into the indicated location.

As Q is composed of A, X, Y and Z, this means that these four registers will be written to the indicated memory location through to the indicated memory location plus 3, respectively.

STQ : Store Q**45GS02** $M \leftarrow Q = M+0 \leftarrow A, \dots, M+3 \leftarrow Z$ **NZ I CDV E**

.

Addressing Mode	Assembly Code	Bytes	Cycles		
base-page quad	STQ \$nn	42 42 85	4	8	
absolute quad	STQ \$nnnn	42 42 8D	5	9	
(indirect quad)	STQ (\$nn)	42 42 92	4	10	<i>ip</i>
[indirect quad]	STQ [\$nn]	42 42 EA 92	5	13	<i>ip</i>

*i*Add one cycle if clock speed is at 40 MHz.*p*Add one cycle if indexing crosses a page boundary.

APPENDIX



Developing System Programmes

- **Introduction**
- **Flash Menu**
- **Format/FDISK Utility**
- **Keyboard Test Utility**
- **MEGA65 Configuration Utility**
- **Freeze Menu**
- **Freeze Menu Helper Programmes**

- Hypervisor
- OpenROM

INTRODUCTION

The MEGA65 has a number of system programs and utilities that are used at various times to perform various functions. This includes the utilities accessible via the Utility Menu , the Freeze Menu and its own helper programs, as well as the Flash Menu .

A number of these system programs are pre-loaded into the MEGA65 bitstream, while others live on the SD card. For those that are pre-loaded into the MEGA65 bitstream, this works by having areas of pre-initialised memory, that contain the appropriate program. For example, the utilities accessible via the Utility Menu are all located in the colour RAM, while the Flash Menu is located at \$50000 - \$57FFF.

In one sense, the easiest way to test new versions of these utilities is to generate a new bitstream with the updated versions. However, synthesising a new bitstream is very time consuming, typically taking an hour on a reasonably fast computer. Therefore this chapter explains the procedure for loading an alternate version of each of these system programs, as well as providing some useful information about these programs, how they operate, and the environment in which they operate compared with normal C64 or C65-mode programs.

FLASH MENU

The flash menu is located in pre-initialised RAM at \$50000 - \$57FFFF. It is executed during the first boot each time the MEGA65 is powered on. It is unusual in that it executes in the hypervisor context. This is so that it has access to the QSPI flash, which is not available outside of Hypervisor Mode, so that user programs cannot corrupt the cores stored in the flash.

It is also important to note that the flash menu program must fit *entirely* below \$8000 when loaded *and* executing, as the Hypervisor is still mapped at \$8000 - \$BFFF, and can easily be corrupted by an ill behaved flash menu program. In this regard, the flash menu can be regarded as an extension of the hypervisor that is discarded after the first boot. This is unlike all other system programs, that operate in a dedicated memory context, from where the Hypervisor is safe from corruption. It also means that you can't crunch the flash menu to make it fit, as it would overwrite the Hypervisor during decrunching.

Also, as the flash menu is executed very early in the boot process, only the pre-included OpenROM ROM image is available. Thus you must ensure that your flash menu program is compatible with that ROM.

The Hypervisor maintains a flag that indicates whether the flash menu has been executed or not. This flag is updated at the point where the Hypervisor exits to user

mode for the first time, since after that point, the contents of \$50000 - \$57FFF can no longer be trusted to contain the flash menu. This means that if you wish to have the Hypervisor run a new version of the flash menu that you have loaded, you must prevent the Hypervisor from exiting to user mode first.

The easiest way to achieve this is to hold the ALT key down while powering on the MEGA65. This will cause the Hypervisor to display the Utility Menu, rather than exiting to user mode. It is safe at this time to use the `m65` utility to load the replacement flash menu program using a command similar to the following:

```
m65 -c newflashmenu.prg@50000
```

That command would load the file `newflashmenu.prg` at memory location \$50000.

After that, you can simply press the reset button on the side of the MEGA65 while holding  down, and it will boot again, and because it never left Hypervisor Mode during the previous boot cycle, it will run your updated flash menu program.

It should also be possible to completely automate this process, by first using `m65 -b` to load a new bitstream, thus simulating a cold boot, and then quickly calling `m65` again to simulate depressing the ALT key (or perhaps simply halting the processor), then `m65 -@ . . .` and finally `m65 -F` to reset the machine. Writing a script or utility that correctly implements this automation is left as an exercise for the reader.

FORMAT/FDISK UTILITY

The Format/FDISK utility is accessed as part of the Utility Menu system. These utilities are compiled, crunched and linked using the `utilpacker` program. If you have checked out the `mega65-core` source repository, you can re-build the colour RAM image by using:

```
make bin/COLOURRAM.BIN
```

You will of course need to first have modified the Format/FDISK utility, which is normally located in the `src/mega65-freeze-menu` subdirectory.

You need to then load this modified colour RAM image into the running machine. Similar to when updating the flash menu, the Hypervisor will only present the utility menu on the first boot, before exiting to user mode for the first time, because it cannot otherwise be sure that the colour RAM contains the valid utility programs.

So as for the flash menu, you would power the MEGA65 off, and then holding the ALT key down, you switch the MEGA65 back on, so that it displays the utility menu. At this point you can use the following command to load your modified COLOURRAM.BIN file:

```
m65 -c COLOURRAM.BIN
```

You can now hold  down, and press the reset button on the left-hand side of the MEGA65, which should again present the utility menu, but this time with your modified format/fdisk utility in place.

KEYBOARD TEST UTILITY

The process for updating the Keyboard test utility is essentially the same as for the format/FDISK utility, as it lives in the colour RAM

MEGA65 CONFIGURATION UTILITY

The process for updating the MEGA65 Configuration utility is essentially the same as for the format/FDISK utility, as it lives in the colour RAM

FREEZE MENU

The Freeze Menu is a normal program, which is stored in FREEZER.M65 on the SD card's FAT32 file system.

To update the Freeze Menu, simply use the `m65ftp` utility or some other means to upload your updated FREEZER.M65 file to the SD card's FAT32 file system. The format of the program is simply a C64-mode PRG file, just renamed to FREEZER.M65.

FREEZE MENU HELPER PROGRAMMES

The Freeze Menu helper programs are updated in the same way as the Freeze Menu itself.

HYPERVERSOR

The Hypervisor is normally built as HICKUP.M65, a 16KB file that contains the complete Hypervisor program. MEGA65 bitstreams contain a pre-build version located at \$FFF8000 - \$FFFBFFF. Updated versions of the Hypervisor can be tested using two main approaches:

- 1. Place the updated HICKUP.M65 file on the FAT32 file system of the SD card, and then power the MEGA65 off and on. This works because the Hypervisor contains code that checks for an updated version of itself, and if found, loads it. However this approach is problematic in that if you install a newer bitstream, it will still downgrade the Hypervisor to whatever version is found in the HICKUP.M65 file on the SD card. This method is only recommended for developers who have a need to test their modified Hypervisor code from a cold start. Even then, it is recommended to remove the HICKUP.M65 file immediately after testing to avoid unexpected down-grading in the future.
- 2. Use the `m65` command's `t -k` option to replace the Hypervisor in place, and then reset the MEGA65 using the reset button on the left-hand side of the case. This should be done when the Hypervisor is *not* active, so that corruption of current execution cannot occur. However, it must also occur before any ROM has been loaded to replace the default OpenROM image. This is because the Hypervisor will attempt to call into the ROM on first-boot in preparation for calling the flash menu, and assumes that the OpenROM is present, because it uses a special OpenROM-specific call to initialise parts of the system state for the flash menu. This is best done by using a command like `m65 -k bin/HICKUP.M65 -R bin/MEGA65.ROM` to load both a new Hypervisor program and re-load an OpenROM image.

OPENROM

To load a new version of a ROM, there are several options, including replacing both the Hypervisor and ROM at the same time, as described above. However, typically the easiest is to copy the new ROM onto the FAT32 filesystem of the SD card as either `MEGA65.ROM`, or `MEGA65x.ROM`, where `x` is replaced by a digit between 0 and 9. When resetting the MEGA65, `MEGA65.ROM` will then be loaded as normal, or if a digit between 0 and 9 is held down on the keyboard while resetting, the Hypervisor will instead load `MEGA65x.ROM`, where `x` is the number being held down on the keyboard.

MEGA65 Hypervisor Services

- **General Services**
- **Disk/Storage Hypervisor Calls**
- **Disk Image Management**
- **Task and Process Management**
- **System Partition & Freezing**
- **Secure Mode**

The MEGA65's Hypervisor provides a number of services via Hypervisor Traps. This chapter will describe these services. For detailed information on how Hypervisor Traps are facilitated by the CPU is described in Chapter/Appendix G on page G-3.

The hypervisor calls are identified by the trap register (\$D640 - \$D67F), and the value of the accumulator register when writing to the trap register. Thus a hypervisor call \$00:\$02 would be made via the following sequence of instructions:

```
LDA #$02
STA $D640+$00
NOP                ; All traps calls MUST be followed by a NOP instruction
```

The values of the other registers or other structures will be described for each individual call.

GENERAL SERVICES

\$00:\$00 – Get Hypervisor Version

Returns the version of the Hypervisor operating system and DOS components in the four registers:

- A = Hypervisor Operating System Major Version number.
- X = Hypervisor Operating System Minor Version number.
- Y = Hypervisor DOS Minor Version number.
- Z = Hypervisor DOS Major Version number.

These values can be used to check whether a given MEGA65 system's hypervisor supports features that become available (or are deprecated) at particular versions.

\$00:\$38 – Get Current Error Code (geterrorcode)

Returns the current error code from the Hypervisor. The currently supported error codes are:

- \$01 (1) – Partition Not Interesting, indicating that an attempt to mount a partition was rejected because the partition was not of a supported type.

- \$02 (2) - Bad Signature, indicating that the signature bytes at the end of a partition table or of the first sector of a partition were missing or incorrect.
- \$03 (3) - An attempt was made to mount a FAT 12 or FAT 16 partition. Only FAT32 partitions are supported.
- \$04 (4) - An attempt was made to mount a partition that has too many reserved sectors. The number of reserved sectors must be less than 65,536.
- \$05 (5) - An attempt was made to mount a partition that does not have exactly two copies of the FAT structure.
- \$06 (6) - An attempt was made to mount a partition that contains a partition with too few clusters.
- \$07 (7) - A read timeout occurred.
- \$08 (8) - An unspecified error occurred while handling a partition.
- \$10 (16) - An invalid address was supplied to the Setup Transfer Area For Other Calls function.
- \$11 (17) - An illegal value was supplied to a Hypervisor call.
- \$20 (32) - A read error occurred.
- \$21 (33) - A write error occurred.
- \$80 (128) - An attempt was made to select or operate on a disk or partition that does not exist.
- \$81 (129) - The supplied filename was too long.
- \$82 (130) - A Hypervisor call was made to a function that is not implemented.
- \$83 (131) - An attempt was made to load a file into memory that is longer than 16MB.
- \$84 (132) - Too many files are open, and no free file descriptor could be obtained for the requested operation.
- \$85 (133) - The supplied cluster number is invalid.
- \$86 (134) - An attempt was made to operate on a directory, where a normal file was expected.
- \$87 (135) - An attempt was made to operate on a normal file, where a directory was expected.
- \$88 (136) - The requested file could not be located.
- \$89 (137) - An invalid file descriptor was supplied.

- \$8A (138) - A disk image file had the wrong length, and was rejected for this reason.
- \$8B (139) - A disk image was attempted to be mounted, but could not because it is fragmented on the file system. Disk images must be stored contiguously on disk. This is because of the way that the SD card controller and floppy controller work: They load the starting sector of the disk image into special registers, and have no way to correctly handle a disk image that is stored in separate pieces on the disk.
- \$8C (140) - The disk has no free space for the requested operation.
- \$8D (141) - An attempt was made to create a file that already exists, or to rename a file to have the name of a file that already exists.
- \$8E (142) - An attempt was made to create a file in a directory that cannot accommodate any more entries.
- \$FF (255) - The end of a file or directory was encountered.

\$00:\$3A - Setup Transfer Area for Other Calls (setup_transfer_area)

Setup the transfer area for various hypervisor calls. The page number of the transfer area is supplied in the Y register. This page must be between \$00 (0) and \$7E (126), thus indicating a transfer area starting between \$0000 and \$7E00 (0 and 32,256). The transfer area is 256 bytes long for most calls. Note that the transfer area is indicated using the processor's current memory mapping at the time that a function is called. However, it is good practice to always place it in the bottom 32KB of main memory.

- Y = Page number of the transfer area (\$00 - \$7E).

This call can produce the following error codes:

- \$10 (16) - An invalid transfer area address was supplied, i.e., Y > \$7E (126).

DISK/STORAGE HYPERVISOR CALLS

\$00:\$02 – Get Default Drive (SD card Partition)

This call returns the default drive (SD card partition) number in the A register.

\$00:\$04 – Get Current Drive (SD card Partition)

This call returns the current selected drive (SD card partition) in the A register.

\$00:\$06 – Select Drive (SD card Partition)

This call sets the currently selected drive (SD card partition) to the drive indicated in the X register.

- X = Selected drive (SD card partition) number.

This call can produce the following error codes:

- \$80 (128) – An attempt was made to select or operate on a disk or partition that does not exist.

\$00:\$08 – NOT IMPLEMENTED Get Disk Size

When implemented, this call will return information on the size of the currently selected disk (SD card partition).

\$00:\$0A – NOT IMPLEMENTED Get Current Working Directory

When implemented, this call will return information on the currently selected directory or sub-directory.

\$00:\$0C – Change Working Directory

Changes the current working directory to the directory specified in the dirent structure. The dirent structure can be populated by using any of the findfirst, findnext, findfile, or readdir Hypervisor calls.

This call can produce the following error codes:

- \$87 (135) – An attempt was made to operate on a normal file, where a directory was expected.

\$00:\$0E – NOT IMPLEMENTED Create Directory

When implemented, this call will allow the creation of new subdirectories.

\$00:\$10 – NOT IMPLEMENTED Remove Directory

When implemented, this call will allow the removal of a directory.

\$00:\$12 – Open Directory (opendir)

Open the current working directory.

On success, it returns the file descriptor of the opened directory in the A register.

This call can result in the following error codes:

- \$07 (7) – A read timeout occurred.
- \$08 (8) – An unspecified error occurred while handling a partition.
- \$10 (16) – An invalid address was supplied to the Setup Transfer Area For Other Calls function.
- \$11 (17) – An illegal value was supplied to a Hypervisor call.
- \$20 (32) – A read error occurred.
- \$21 (33) – A write error occurred.

- \$80 (128) - An attempt was made to select or operate on a disk or partition that does not exist.
- \$84 (132) - Too many files are open, and no free file descriptor could be obtained for the requested operation.

\$00:\$14 - Read Next Directory Entry (readdir)

\$00:\$16 - Close Directory (closedir)

\$00:\$18 - Open File (openfile)

\$00:\$1A - Read From a File (readfile)

\$00:\$1C - NOT IMPLEMENTED Write to a File (writefile)

\$00:\$1E - NOT IMPLEMENTED Create File (mkfile)

\$00:\$20 - Close a File (closefile)

\$00:\$22 - Close All Open Files (closeall)

\$00:\$24 - NOT IMPLEMENTED Seek to a Given Offset in a File (seekfile)

\$00:\$26 – NOT IMPLEMENTED Delete a File (rmfile)

\$00:\$28 – NOT IMPLEMENTED Get Information About a File (fstat)

\$00:\$2A – NOT IMPLEMENTED Rename a File (rename)

\$00:\$2C – NOT IMPLEMENTED Set time stamp of a file (filedate)

\$00:\$2E – Set the current filename (setname)

Sets the current Hypervisor filename to the ASCII string stored at \$YYXX. The provided address must be in the first 31KB of main memory. Addresses at \$7F00 or above will result in errors.

The filename indicates a file in the current working directory of the SD card's FAT file system. This call will *not* work with names of files that are stored on floppy disks or floppy disk images.

\$00:\$30 – Find first matching file (find-first)

\$00:\$32 – Find subsequent matching file (findnext)

\$00:\$34 – Find matching file (one only) (findfile)

\$00:\$36 – Load a File into Main Memory (loadfile)

On success, this call loads the file specified by the setname Hypervisor call into the specified address in main (chip) memory. It is limited to files of 16MB size, and the first 16MB of the address space. The load address will be \$00ZZYYXX.

Addresses during loading will wrap around within the same 16MB region of memory, i.e., the most significant address byte will not be incremented during loading.

\$00:\$3C – Change Working Directory to Root Directory of Selected Partition

\$00:\$3E – Load a File into Attic Memory (loadfile_attic)

On success, this call loads the file specified by the setname Hypervisor call into the specified address in the Attic RAM memory. It is limited to files of 16MB size, and the first 16MB of the attic RAM address space. The load address will be \$08ZZYYXX.

Addresses during loading will wrap around within the same 16MB region of memory, i.e., the most significant address byte will not be incremented during loading.

DISK IMAGE MANAGEMENT

\$00:\$40 – Attach a D8 1 Disk Image to Drive 0

\$00:\$42 – Detach All D8 1 Disk Images

\$00:\$44 – Write Enable All Currently Attached D8 1 Disk Images

\$00:\$46 – Attach a D8 1 Disk Image to Drive 1

TASK AND PROCESS MANAGEMENT

\$00:\$50 – NOT IMPLEMENTED Get Task List

\$00:\$52 – NOT IMPLEMENTED Send Message to Another Task

\$00:\$54 – NOT IMPLEMENTED Receive Messages From Other Tasks

\$00:\$56 – NOT IMPLEMENTED Write Into Memory of Another Task

\$00:\$58 – NOT IMPLEMENTED Read From Memory of Another Task

\$00:\$60 – NOT IMPLEMENTED Terminate Another Task

\$00:\$62 – NOT IMPLEMENTED Create a Native MEGA65 Task

\$00:\$64 – NOT IMPLEMENTED Load File Into Task

\$00:\$66 – NOT IMPLEMENTED Create a C64-Mode Task

\$00:\$68 – NOT IMPLEMENTED Create a C65-Mode Task

\$00:\$6A – NOT IMPLEMENTED Exit and Switch to Another Task

\$00:\$6C – NOT IMPLEMENTED Context-Switch to Another Task

\$00:\$6E – NOT IMPLEMENTED Exit This Task

\$00:\$70 – Toggle Write Protection of ROM Area

\$00:\$72 – Toggle 4510 vs 6502 Processor Mode

\$00:\$74 – Get current 4510 memory MAPping

Y = page where memory mapping is to be stored. Six bytes will be returned: Y must be <= \$7E.

- \$00 – Low byte of MAPLO (lower 32KB RAM mapping)
- \$01 – High byte of MAPLO (lower 32KB RAM mapping)
- \$02 – Low byte of MAPHI (upper 32KB RAM mapping)
- \$03 – High byte of MAPHI (upper 32KB RAM mapping)
- \$04 – Megabyte offset for MAPLO (lower 32KB RAM mapping)
- \$05 – Megabyte offset for MAPHI (upper 32KB RAM mapping)

\$00:\$76 – Set 4510 memory MAPping

This call performs the opposite of the Get 4510 memory MAPping, reading 6 bytes from the memory page indicated by Y, and storing them into the current processor's mapping status. Y must be <= \$7E.

\$00:\$7C – Write Character to Serial Monitor/Matrix Mode Interface

\$00:\$7E – Reset MEGA65

\$01:\$00 – Enable Write Protection of ROM Area

\$01:\$02 – Disable Write Protection of ROM Area

SYSTEM PARTITION & FREEZING

\$02:\$00 - Read System Config Sector Into Memory

\$02:\$02 - Write System Config Sector From Memory

\$02:\$04 - Apply System Config Sector Current Loaded Into Memory

\$02:\$06 - Set DMAgic Revision Based On Loaded ROM

\$02:\$10 - Locate First Sector of Freeze Slot

\$02:\$12 - Unfreeze From Freeze Slot

\$02:\$14 - Read Freeze Region List

\$02:\$16 - Get Number of Freeze Slots

\$03:\$XX - Write Character to Serial Monitor/Matrix Mode Interface

SECURE MODE

\$11:\$XX – Request Enter Secure Mode

\$12:\$XX – Request Exit Secure Mode

\$32:\$XX – DEPRECATED Set Protected Hardware Configuration

This call will be removed once the secure mode framework is more completely implemented.

Until it is removed, this call allows a process to request the setting of the protected hardware configuration to allow or restrict access to various sub-systems, including the SD card storage system.

\$3F:\$XX – Freeze Self

APPENDIX

K

Machine Language Monitor

- **Introduction**
- **C65 ROM Standard Machine Language Monitor**
- **Enhanced Machine Language Monitor**
- **MEGA65 Matrix Mode Monitor Interface**

INTRODUCTION

Before we go any further, it is important to remember that the MEGA65 typically has two separate machine language monitors: The one included in C65 ROMs, and the one that is part of the Matrix Mode debug interface. It is also possible to replace the standard C65 monitor in the ROM with the enhanced MEGA65 OpenROMs machine language monitor, which corrects many bugs and adds many new features - including support for all enhanced CPU instructions of the MEGA65. This chapter describes all three of these machine language monitors.

C65 ROM STANDARD MACHINE LANGUAGE MONITOR

The machine language monitor is a debugging tool for machine language programs. It includes a mini-assembler, a disassembler and many useful commands. When the program execution encounters the code 00 (zero) alias BRK, the default action of the operating system is, to call the monitor. This features allows the debugging of programs by setting breakpoints.

Table of C65 ROM Standard Monitor Commands

C	mnemonic	description
A	ASSEMBLE	Assemble a line of 45GS02 code
C	COMPARE	Compare two sections of memory
D	DISASSEMBLE	Disassemble a line of 45GS02 code
F	FILL	Fill a section of memory with a value
G	GO	Start execution at specified address
H	HUNT	Find specified data in a section of memory
L	LOAD	Load a file from disk
M	MEMORY	Dump a section of memory
R	REGISTERS	Display the contents of the 45GS02 registers
S	SAVE	Save a section of memory to a disk file
T	TRANSFER	Transfer memory to another location
V	VERIFY	Compare a section of memory with a disk file
X	EXIT	Exit Monitor mode
.	<period>	Assembles a line of 45GS02 code
>	<greater>	Modifies memory
;	<semicolon>	Modifies register contents
@	<at sign>	Disk command, directory or status
\$	<hex>	Display hex, decimal, octal, and binary value
+	<decimal>	Display hex, decimal, octal, and binary value
&	<octal>	Display hex, decimal, octal, and binary value
%	<binary>	Display hex, decimal, octal, and binary value

Calling the Monitor

To enter the monitor from BASIC, type: **MONITOR**

The monitor responds with a display of register contents and waits for a command:

```
MONITOR
  PC  SR  AC  XR  YR  ZR  BP  SP
; 000000 00 00 00 00 00 00 F8
```

addresses and numbers

All addresses and numbers must be numbers of base 16 (hex), 10 (decimal), 8 (octal) or 2 (dual). Symbolic names like CHROUT or arithmetics like \$1000+5 are not allowed.

It is an old tradition since the first monitor of the Commodore PET, that the default base is 16. In fact the old monitors would not accept any other numbers, than hexadecimal (short hex). This may confuse beginners, because a statement like

```
LDA #10
```

loads the decimal value 16 into the accumulator. Later monitors, like that of the Commodore 128 accepted numbers of base 16,10,8 and 2 - like this one, but still used 16 (hex) as default. Additionally the MEGA65 monitor allows character entry, which uses the PETSCII value of the character. Following prefixes can be used to specify the base of the following number:

base	name	prefix	digits characters	example
16	hexadecimal		0123456789ABCDEF	100
16	hexadecimal	\$	0123456789ABCDEF	\$100
10	decimal	+	0123456789	+256
8	octal	&	01234567	&400
2	dual	%	01	%100000000
	character	'	all	'A

D : DISASSEMBLE

Format: D [from [,to]]

Usage: Prints a machine language listing for the specified address range assuming, that it contains code. If only one argument is present, the disassembler disassembles the next 21 bytes. If no argument is given, the disassembly continues with the last used disassemble address. The contents are printed as hex values.

Remarks: The rows start with the dot character '.'. This enables direct full screen editing of the disassembly. Typing return in any row will assemble the changed command of the cursor row back to memory, if writable RAM is there. See monitor command ..

The disassembler knows the instruction set of the C65 CPU GS6502. Enhanced instructions from the 45GS02 CPU of the MEGA65 are not recognised.

Example: Using D

```

DL"*
SEARCHING FOR 0:*
LOADING
READY.
MONITOR

MONITOR
  PC  SR AC XR YR ZR SP
; 000000 00 00 00 00 00 F8
0 31F7
. 0031F7 A4 29      LDY $29
. 0031F9 AB 29 00 LDZ $0029
. 0031FC B1 AC      LDA ($AC),Y
. 0031FE 91 57      STA ($57),Y
. 003200 EA          NOP
. 003201 B2 AE      LDA ($AE),Z
. 003203 EA          NOP
. 003204 92 59      STA ($59),Z
. 003206 3B          DEZ
. 003207 88          DEY
. 003208 10 F2      BPL $31FC
. 00320A 18          CLC
. 00320B A5 AC      LDA $AC

```

M : MEMORY

Format: **M** [from [,to]]

Usage: Prints a memory dump for the given address range. The dump displays memory contents, organised in rows of 16 consecutive addresses starting with the address, given as 1st. argument. The dump continues until a row has been printed, containing the value of the address given as 2nd. argument. If no 2nd. argument is present, the dump displays a full page of 256 bytes in 16 rows. The contents are printed as 16 byte values in hex, followed by the character representation.

Remarks: The rows start with the character '>'. This enables direct full screen editing of the dump. Typing return in any row will write the changed values of the cursor row back to memory, if writable RAM is there. See monitor command >.

Example: Using **M**

```

M 0322A0
>0322A0 20 20 42 41 53 49 43 20 31 30 2E 30 20 20 20 20: BASIC 10.0
>0322B0 56 30 2E 39 2E 39 31 30 31 31 31 20 20 20 20 41: U0.9.910111 A
>0322C0 4C 4C 20 52 49 47 48 54 53 20 52 45 53 45 52 56: LL RIGHTS RESERV
>0322D0 45 44 0D 00 60 A2 17 BD E1 22 9D FA 02 CA 10 F7: ED. . . . .
>0322E0 60 ED 78 8A 2D 11 B0 4D 2E EC 2E 8C 23 6C 33 C9: -L2. . . . . #3
>0322F0 2B A8 4C 9C 23 F0 33 C4 2C E3 3D A0 00 20 3B 23: +vL #r3 = . ;#
>032300 C9 20 F0 F5 C9 3A B0 06 38 E9 30 38 E9 D0 60 A9: . . . . . 8/08
>032310 50 80 3A A9 3F 80 36 A9 52 80 32 A9 5C 80 2E A9: P. : 2.6/R.2 £..
>032320 66 80 2A A9 61 80 16 A9 70 80 12 A9 70 80 1E A9: * * * * *
>032330 50 80 1A A9 61 80 16 A9 24 80 02 A9 3D DB DA AA: P. / * / $ . . = +
>032340 AB 84 00 20 74 FF FA FB 29 FF 60 A9 24 08 DB DA: . . . . . ) n $ +
>032350 AA AB 85 00 B5 01 C9 20 B0 03 AB 84 00 20 74 FF: . . . . . ) n $ +
>032360 FA FB 28 29 FF 60 08 DB 48 AB 85 00 B5 01 C9 20: . . . . . ) n $ +
>032370 B0 03 AB 84 00 68 20 77 FF FB 28 60 A2 3D 08 DB: . . . . . ) n $ +
>032380 AB 84 00 20 77 FF FB 28 60 6C 04 03 FC 3D 00 20: . . . . . ) n $ +
>032390 FB 22 80 03 20 F9 22 90 FB 6C 0C 03 93 8E 00 C9: . . . . . ) n $ +

```

ENHANCED MACHINE LANGUAGE MONITOR

This machine language monitor is a new development for the MEGA65. It is available both in the 92xxxx ROMs and in the OpenROMs.

The enhanced monitor has following additional features:

Addresses:

All addresses are used as 32-bit (4 bytes) addresses. This allows access to the whole MEGA65 address range, which needs 28-bit. This is especially useful for the access to the 8MB RAM blocks called attic RAM at \$8000000 (builtin) and cellar RAM at \$8800000 (optional). Setting bit 31 of an address to 1 gives access to a special (banked) configuration. In this case the I/O area at \$D000 and the ROM area \$6000 - \$7FFF (monitor ROM) and \$E000 - \$FFFF (kernel ROM) overlay the current bank.

Commands:

The additional command **B** displays character bitmaps.

Disk access:

The disk command character knows two more functions: **U1** for reading a sequence of disk blocks to memory and **U2** for writing a memory range to disk blocks. This enables disk editing, for example modifying directory entries

or can be even used to backup whole floppy contents or disk images. The attic RAM is large enough to hold the contents of 8 complete 1581 floppies.

Disassembler:

The disassembler can decode all additional address modes, like the 32-bit indirect mode [*\$nn*], *Z* and the compound instructions involving the use of the 32-bit *Q* register.

Register:

The register displays the full 16-bit stack pointer and the base page register and accepts new settings for them.

Table of MEGA65 Enhanced Monitor Commands

C	mnemonic	description
A	ASSEMBLE	Assemble a line of 45GS02 code
B	BITMAPS	Display 8x8 bitmaps (characters)
C	COMPARE	Compare two sections of memory
D	DISASSEMBLE	Disassemble a line of 45GS02 code
F	FILL	Fill a section of memory with a value
G	GO	Start execution at specified address
H	HUNT	Find specified data in a section of memory
L	LOAD	Load a file from disk
M	MEMORY	Dump a section of memory
R	REGISTERS	Display the contents of the 45GS02 registers
S	SAVE	Save a section of memory to a disk file
T	TRANSFER	Transfer memory to another location
V	VERIFY	Compare a section of memory with a disk file
X	EXIT	Exit Monitor mode
.	<period>	Assembles a line of 45GS02 code
>	<greater>	Modifies memory
;	<semicolon>	Modifies register contents
@	<at sign>	Disk command, directory or status
\$	<hex>	Display hex, decimal, octal, and binary value
+	<decimal>	Display hex, decimal, octal, and binary value
&	<octal>	Display hex, decimal, octal, and binary value
%	<binary>	Display hex, decimal, octal, and binary value

Calling the Monitor

To enter the monitor from BASIC, type: `MONITOR`

The monitor responds with a display of register contents and waits for a command:

```
MONITOR
CS MONITOR COMMANDS: ABCDFGHJRTX<>?S+BX/LSU
PC SR AC XR YR ZR BP SP NVEBDIZC
; 00CFA4 35 00 00 00 00 00 01F8 --11-1-1
```

addresses and numbers

All addresses and numbers must be numbers of base 16 (hex), 10 (decimal), 8 (octal) or 2 (dual). Symbolic names like `CHROUT` or arithmetics like `$1000+5` are not allowed.

It is an old tradition since the first monitor of the Commodore PET, that the default base is 16. In fact the old monitors would not accept any other numbers, than hexadecimal (short hex). This may confuse beginners, because a statement like

```
LDA #10
```

loads the decimal value 16 into the accumulator. Later monitors, like that of the Commodore 128 accepted numbers of base 16,10,8 and 2 - like this one, but still used 16 (hex) as default. Additionally the MEGA65 monitor allows character entry, which uses the PETSCII value of the character. Following prefixes can be used to specify the base of the following number:

base	name	prefix	digits characters	example
16	hexadecimal		0123456789ABCDEF	100
16	hexadecimal	\$	0123456789ABCDEF	\$100
10	decimal	+	0123456789	+256
8	octal	&	01234567	&400
2	dual	%	01	%100000000
	character	'	all	'A

Assembler

The monitor has a builtin mini-assembler, which can be used to write machine language code using the standard mnemonics like **LDA** or **STA**, etc. The most important difference to a full assembler is the necessity to use numeric constants as operands for

the instructions only. So you cannot use named variables, labels or subroutine names. A call to the kernel routine, which prints a character to the screen would be written **JSR CHROUT** in a full assembler, while the mini-assembler needs the syntax **JSR FFD2** (you need to know or lookup the addresses). There is the convenience for branch instructions, that the target address is written to the operand field and the mini-assembler computes the relative address, that is inserted in the code.

The assembler knows all instructions and address modes of the MEGA65 CPU 45GS02 (except the instructions using the Q register, these will be added later). So an instruction like **LDA [TXTPTR],Z** will be assembled as loading the accumulator using a 32-bit pointer at the addresses **TXTPTR, TXTPTR+1, TXTPTR+2, TXTPTR+3**.

A : ASSEMBLE

Format: **A address mnemonic operand**

Usage: The mini assembler allows entry of machine language instructions using easy to remember mnemonics instead of opcodes. The operand may be entered as hex, decimal, binary or character. Branch targets are automatically converted to relative distances. After each entered instruction, the mini assembler generates the 1-3 byte long machine code, prints this code along with the instruction and advances the program counter. A new line is generated with the command **A** and the new value of the program counter printed. This eases the fast entry of instructions. The assembly input mode is stopped by pressing RETURN only. Any line of the entered code or a line in disassembly format can be changed by moving the cursor into that line and changing the desired element, for example the mnemonic or the operand. Listed hex values before the mnemonic are ignored.

If the monitor shall be reentered after executing the code, the last instruction must be a **BRK** instruction and the program must be called with I/O and monitor ROM active. This is done by setting the bit 31 of the execution address. If the program was entered in bank 0 on address 1500, it should be started with: **G 80001500**.

If the entered code is a subroutine, it must end with a **RTS** instruction.

Remarks: The assembler recognises all 45GS02 instructions of the MEGA65, except the instructions, that use the Q register. These instructions can be entered by typing the NEG NEG prefix explicit. E.g. instead of **LDQ \$1234**, entering the 3 instructions (on 3 different rows) **NEG NEG LDA \$1234** is assembled to the equivalent code.

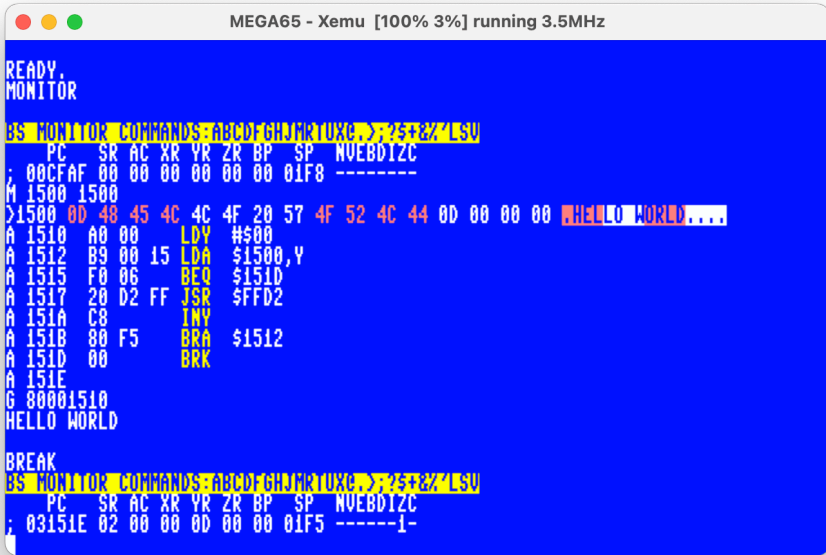

B : BITMAPS

Format: B display character bitmaps

Usage: B address

Remarks: The B command displays the contents of memory cells bitwise by printing an asterisk for 1 and a dot for 0. The special arrangement of character data with 8 bytes forming one character cell, is considered. 8 characters are displayed for each call.

There are three ROM character sets builtin in the 92xxxx ROMs:

```

FONT A : $029000 : ASCII [E]†+ (I)† included
FONT B : $03D000 : serif version of A
FONT C : $02D000 : original C64 font

```

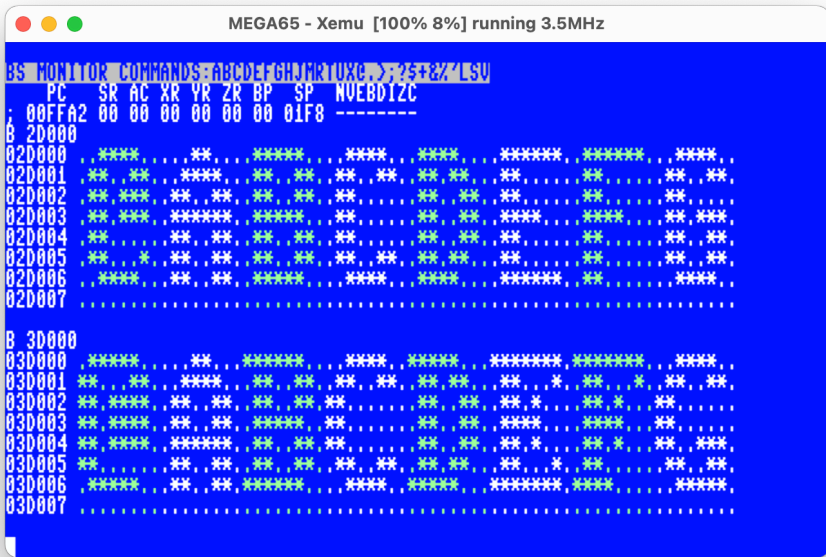

MEGA65 MATRIX MODE MONITOR INTERFACE

This monitor is different to the other two: It is part of the MEGA65 system itself, and runs concurrently with MEGA65's processor. That is, you can view and modify the memory the MEGA65, *while a program is running*.

This works using dedicated hardware in the MEGA65 design, that implements a little helper processor that runs this monitor interface, and has a special access mechanism to the memory and processor of the MEGA65.

In comparison with the ROM-based monitors that execute on the MEGA65's primary processor, the Matrix Mode monitor has several advantages and disadvantages:



- It can be used while a program is running.
- It can be used, even if the ROM area is being used for program code or data, instead of containing a standard C65 or MEGA65 ROM.

- It can be accessed via the serial debug interface, via the JB1 connector.
- It can be instructed to stop the processor as soon as the program counter (PC) register of the main processor reaches a user specified address. That is, it supports a (single) hardware breakpoint.
- It can be instructed to stop the processor whenever a specified memory address is written to. That is, it supports a “write watch” on a single memory address. The memory address is specified as a full 28-bit address, allowing it to detect memory writes via any means. Note that DMA operations will complete, before the watch point takes effect.
- It can be instructed to stop the processor whenever specific CPU flags are set or cleared, which can also be used to support debugging of programs.
- On some models of the MEGA65, the integrated ROM of the monitor processor is very small, which means that functionality may be limited. This is why, for example, there is no “assemble” command for this monitor. This may be corrected in future core updates for MEGA65 models that have capacity for a larger monitor processor ROM.

Table of Matrix Mode Monitor Commands

C	mnemonic	description
#	HYPERTRAP	Enable/disable CPU hypervisor traps
+	UARTDIVISOR	Set UART bitrate divisor
?	HELP	help
@	CPUMEM	(show memory from CPU context)
B	BREAKPOINT	Set/clear CPU execution break point
D	DISASSEMBLE	Disassemble memory
E	FLAGWATCH	Set/clear CPU flags watch point
F	FILL	Fill memory with a value
G	SETPC	Set CPU program counter
H	HELP	help
I	INTERRUPTS	Enable/disable CPU interrupts
J	DEBUGMON	Various debug functions for the monitor itself
L	LOADMEMORY	Load data into memory
M	MEMORY	Show memory contents
R	REGISTERS	show registers
S	SETMEMORY	Set memory contents
T	TRACE	set CPU trace/run mode
W	MEMORYWATCH	Set/clear memory write watch point
Z	CPUHISTORY	CPU history

Calling the Monitor

To enter or exit the monitor hold down  and press . You will see an animation of green characters raining down from the top of the screen, and then be presented with a simple text terminal interface which is transparent, so that you can see the screen output of your running program at the same time.

: Hypervisor trap enable/disable

Format: # Enable or disable Hypervisor Traps

Usage: #[0|1]

Remarks: If the argument is 1, then Hypervisor traps are enabled, otherwise they are disabled.

It is not confirmed if this command is currently functional.



+ : Set Serial Interface UART Divisor



Format: + Set Serial Interface UART Divisor

Usage: + divisor

Remarks: Sets the divisor for the serial monitor interface. This allows changing the baud rate of the serial monitor interface from the default 2,000,000 bits per second. The baud rate will be equal to $40,500,000 \div (\text{divisor} - 1)$. This affects only the serial UART interface, and does not affect accessing this monitor via the Matrix Mode composited display.

For example, to slow the serial monitor interface down to 19,200 bits per second, the divisor would need to be $40,500,000 \div (19,200 - 1) = 2108$. The + command then requires that you convert this value to hexadecimal, thus the command would be +83c.

Note that this command does *no* sanity checking of the provided value. If you accidentally provide an incorrect value for your needs, you can recover from this situation by activating the Matrix Mode interface by holding down  and tapping , and entering the appropriate command to correct the divisor, e.g., +14 to return to the default of 2,000,000 bits per second.

You must then exit the Matrix Mode again by repeating the  +  key combination, before the serial UART interface will become active again. This is because the Matrix Mode disables the serial UART interface when active.

@ : CPUMEMORY

Format: @ [address]

Usage: Prints a memory dump for the given 16-bit address, *as interpreted by the current CPU memory mapping*. If you wish to inspect the contents of memory anywhere in the 28-bit address space, use the M command instead.

The dump displays memory contents, organised in rows of 16 consecutive addresses starting with the address. The dump displays a full page of

256 bytes in 16 rows. The contents are printed as 16 byte values in hex, followed by the character representation.

Remarks: If not address is provided, it will show the next 256 bytes.

? or H : HELP

Format: ? or h

Usage: Displays a (very) brief message identifying the monitor. On some models of the MEGA65 that have more memory available to the monitor processor, this command may display information about each of the available commands.

B : BREAKPOINT

Format: b [address]

Usage: Sets or clears the hardware breakpoint. If no address is provided, then the breakpoint will be disabled. Otherwise the breakpoint is set to the provided 16-bit address.

Whenever the program counter (PC) register of the MEGA65's processor equals the value provided to this command, the processor will halt, and the Matrix Mode monitor interface will display the last instruction executed and current register values to alert the user to this event. It does not activate the Matrix Mode display when this occurs. It is normally expected that Matrix Mode will either already be active, or that the user is interacting via the serial interface.

D : DISASSEMBLE

Format: <d|D> [address]

Usage: Disassembles and displays the instruction stored at the indicated 28-bit address.

To disassemble instructions from the CPU's current memory context, taking into account current memory banking, prefix the address with 777, e.g., d777080D would disassemble the instruction at \$080D, as currently visible to the MEGA65's processor.

Use D instead of d to disassemble 16 instructions at a time, instead of just one.

E : FLAGWATCH

Format: e [value]

Usage: Sets or clears the CPU flag watch point: If no argument is provided, the flag watch point is disabled. If a value is provided, it is assumed to be a 16-bit value, where the first two hexadecimal digits indicate the processor flags that will trigger the watch point if they are set. The second two hexadecimal digits indicate which processor flags will trigger the watch point if they are clear. In this way any combination of processor flag values can be monitored.

This command does not function correctly at the time of writing.

Example: To cause the watch point to trigger when the Negative Flag is asserted, the command e8000 would be used.

F : FILL

Format: f [start] [end+1] [value]

Usage: Fills the indicated 28-bit address range with the indicated value.

Remarks: The end address should be one more than the last address that is desired to be filled.

G : SETPC

Format: g address

Usage: Sets the Program Counter (PC) register of the MEGA65's processor to the supplied 16-bit address. If the processor is running at the time, execution will immediately proceed from that address. If the processor is halted at the time, e.g., due to the use of the tt t1 command, the processor remains halted, but with the Program Counter set to the indicated address, ready for when the processor is again allowed to run.

I : INTERRUPTS

Format: **i[0|1]**

Usage: Enables or disables interrupts on the MEGA65's processor. Disabling interrupts can be helpful when single-stepping through a program, as otherwise you will tend to end up only stepping through the interrupt handler code, because the interrupts will happen more frequently than the steps through the code.

Remarks: *This command is known to have problems, and may not currently function.*

J : DEBUGMON

Format: **j [value]**

Usage: Display, and optionally set, internal signals of the matrix mode monitor interface.

L : LOADMEMORY

Format: **l <start addr> <end addr + 1>**

Usage: Fast-load a block of memory via the serial monitor interface. Immediately after sending this command, the bytes of memory to be loaded should be sent to the serial monitor interface. The bytes are read as-is, and thus should be provided as natural bytes, not encoded in hexadecimal. This allows loading data at approximately 200KB per second at the default serial baud rate of 2,000,000 bits per second.

M : MEMORY

Format: **<m|M> [address]**

Usage: Prints a memory dump for the given 28-bit address. If you wish to inspect the contents of memory as currently seen by the processor's current banking configuration, use the command instead.

The dump displays memory contents, organised in rows of 16 consecutive addresses starting with the address. The dump displays a full page of 256 bytes in 16 rows. The contents are printed as 16 byte values in hex, followed by the character representation.

Remarks: If not address is provided, it will show the next 256 bytes.

R : REGISTERS

Format: `r`

Usage: Displays the current value of various processor registers and flags, as well as a disassembly of the most recently executed instruction.

S : SETMEMORY

Format: `s addr <value ...>`

Usage: Sets the contents of the indicated memory location to the supplied value. If more than one space-separated value is provided, then multiple consecutive memory locations will be set.

This command uses 28-bit addresses, and therefore ignores the current selected memory banking configuration.

T : TRACE

Format: `t<0|1|c>`

Usage: Selects the trace or run mode of the processor: t0 means that the processor runs freely, t1 halts the processor, and tc runs the processor in continuous-trace mode, where it displays each instruction and the register values immediately following its execution, as though t1 had been selected, and the user were to then immediately press return or enter to request the next instruction to be executed.

If t1 is selected, pressing enter or return in the Matrix Mode monitor will cause the next instruction to be executed.

The t0 command is also used following the triggering of a break-point or watch-point, to allow the processor to resume.

W : WATCHPOINT

Format: `w [address]`

Usage: Sets or clears the hardware watch-point. If no address is provided, then the watch-point will be disabled. Otherwise the watch-point is set to the provided 28-bit address.

Whenever the MEGA65's processor writes to the address provided to this command, the processor will halt, and the Matrix Mode monitor interface will display the last instruction executed and current register values to alert the user to this event. It does not activate the Matrix Mode display when this occurs. It is normally expected that Matrix Mode will either already be active, or that the user is interacting via the serial interface.

Z : CPUHISTORY

Format: z [address]

Usage: Displays information about the instructions recently executed by the MEGA65's processor.

Remarks: *This command is suspected to not be correctly operational at the time of writing.*

APPENDIX



F018-Compatible Direct Memory Access (DMA) Controller

- **F018A/B DMA Jobs**
- **MEGA65 Enhanced DMA Jobs**
- **Texture Scaling and Line Drawing**
- **Audio DMA**
- **F018 “DMAgic” DMA Controller**
- **MEGA65 DMA Controller Extensions**
- **Unimplemented Functionality**

The MEGA65 includes an F018/F018A backward-compatible DMA controller. Unlike in the C65, where the DMA controller exists as a separate chip, it is part of the 45GS02 processor in the MEGA65. However, as the use of the DMA controller is a logically separate topic, it is documented separately in this appendix.

The MEGA65's DMA controller provides several important improvements over the F018/F018A DMA chips of the C65:

- **Speed** The MEGA65 performs DMA operations at 40MHz, allowing filling 40MB or copying 20MB per second. For example, it is possible to copy a complete 8KB C64-style bitmap display in about 200 micro-seconds, equivalent to less than four raster lines!
- **Large Memory Access** The MEGA65's DMA controller allows access to all 256MB of address space.
- **Texture Copying Support** The MEGA65's DMA controller can do fractional address calculations to support hardware texture scaling, as well as address striding, to make it possible in principle to simultaneously scale-and-draw a texture from memory to the screen. This would be useful, should anyone be crazy enough to try to implement a Wolfenstein or Doom style-game on the MEGA65.
- **Transparency/Mask Value Support** The MEGA65's DMA controller can be told to ignore a special value when copying memory, leaving the destination memory contents unchanged. This allows masking of transparent regions when performing a DMA copy, which considerably simplifies blitting of graphics shapes.
- **Per-Job Option List** A number of options can be configured for each job in a chained list of DMA jobs, for example, selecting F018 or F018B mode, changing the transparency value, fractional address stepping or the source or destination memory region.
- **Background Audio DMA** The MEGA65 includes background audio DMA capabilities similar to the Amiga™ series of computers. Key differences are that the MEGA65 can use either 8 or 16-bit samples, supports very high sample rates up to approximately 1 MHz, has 256 volume settings per channel, and no inter-channel modulation.

F018A/B DMA JOBS

To execute a DMA job using the F018 series of DMA controllers, you must construct the list of DMA jobs in memory, and then write the address of this list into the DMA address registers. The DMA job will execute when you write to the ADDR LSB TRIG register (\$D700). For this reason you must write the MSB and bank number of the DMA list into

\$D701 and \$D702 first, and the LSB only after having set these other two registers. If you wish to execute multiple DMA jobs using the same list structure in memory, you can simply write to ADDR LSBTRIG again after updating the list contents – provided that no other program has modified the contents of \$D701 or \$D702. Note that BASIC 65 uses the DMA controller to scroll the screen, so it is usually safest to always write to all three registers.

When ADDR LSBTRIG has been written to, the DMA job completes immediately. Unlike on the C65, the DMA controller is part of the processor of the MEGA65. This means that the processor stops trying to execute instructions *or fetching audio samples for DMA audio playback* until the DMA job has completed. It also means that, unlike on the C65, DMA jobs cannot be interrupted. If your program has sensitive timing requirements, you may need to break larger DMA jobs into several smaller jobs. This is somewhat mitigated by the high speed of the MEGA65's DMA, which is able to fill memory at 40.5MB per second and copy memory at 20.25MB per second, compared with circa 3.5MB and 1.7MB per second on a C65. This allows larger DMA jobs to be executed, without needing to worry about the impact on real-time elements of a program. For example, it is possible to fill an 80 column 50 row text screen using the MEGA65's DMA controller in just 200 microseconds.

F018 DMA Job List Format

The MEGA65's DMA controller supports the two different DMA job list formats used by the original F018 part that was used in the earlier C65 prototypes (upto Revision 2B) and the F018B and later revisions used in the Revision 3 – 5 C65 prototypes. The main difference is the addition of a second command byte, as the following tables show:

It is important to know which style the DMA controller is expecting. The MEGA65's Hypervisor sets the mode based on the detected version of C65 ROM, if one is running. If it is an older one, then the F018 style is expected, otherwise the newer F018B style is expected. You can check which style has been selected by querying bit 0 of \$D703: If it is a 1, then the newer F018B 12 byte list format is expected. If it is a 0, then the older F018 11 byte list format is expected. The expected style can be set by writing to this register.

Unless you are writing software that must also run on a C65 prototype, you should most probably use the MEGA65's Enhanced DMA Jobs, where the list format is explicitly specified in the list itself. As the Enhanced DMA Jobs are an extension of the F018/F018B DMA jobs, you should still read the following, unless you are already familiar with the behaviour of the F018 DMA controller.

F018 11 byte DMA List Structure

Offset	Contents
\$00	Command LSB
\$01	Count LSB
\$02	Count MSB
\$03	Source Address LSB
\$04	Source Address MSB
\$05	Source Address BANK and FLAGS
\$06	Destination Address LSB
\$07	Destination Address MSB
\$08	Destination Address BANK and FLAGS
\$09	Modulo LSB
\$0a	Modulo MSB

* The Command MSB is \$00 when using this list format.

F018B 12 byte DMA List Structure

Offset	Contents
\$00	Command LSB
\$01	Count LSB
\$02	Count MSB
\$03	Source Address LSB
\$04	Source Address MSB
\$05	Source Address BANK and FLAGS
\$06	Destination Address LSB
\$07	Destination Address MSB
\$08	Destination Address BANK and FLAGS
\$09	Command MSB
\$0a	Modulo LSB / Mode
\$0b	Modulo MSB / Mode

The structure of the command word is as follows:

Bit(s)	Contents
0 - 1	DMA Operation Type
2	Chain (i.e., another DMA list follows)
3	Yield to interrupts
4	MINTERM -SA,-DA bit
5	MINTERM -SA,DA bit
6	MINTERM SA,-DA bit
7	MINTERM SA,DA bit
8 - 9	Addressing mode of source
10 - 11	Addressing mode of destination
12 - 15	RESESRVED. Always set to 0's

The command field take the following four values:

Value	Contents
%00 (0)	Copy
%01 (1)	Mix (via MINTERMs)
%10 (2)	Swap
%11 (3)	Fill

* Only Copy and Fill are implemented at the time of writing.

The addressing mode fields take the following four values:

Value	Contents
%00 (0)	Linear (normal) addressing
%01 (1)	Modulo (rectangular) addressing
%10 (2)	Hold (constant address)
%11 (3)	XY MOD (bitmap rectangular) addressing

* Only Linear, Modulo and Hold are implemented at the time of writing.

The BANK and FLAGS field for the source address allow selection of addresses within a 1MB address space. To access memory beyond the first 1MB, it is necessary to use an Enhanced DMA Job with the appropriate option bytes to select the source and/or destination MB of memory. The BANK and FLAGS field has the following structure:

Bit(s)	Contents
0 - 3	Memory BANK within the selected MB
4	HOLD, i.e., do not change the address
5	MODULO, i.e., apply the MODULO field to wrap-around within a limited memory space
6	DIRECTION. If set, then the address is decremented instead of incremented.
7	I/O. If set, then I/O registers are visible during the DMA controller at \$D000 - \$DFFF.

Performing Simple DMA Operations

For information on using the DMA controller from BASIC 65, refer to the **DMA** BASIC command in Chapter/Appendix B on page B-63.

To use the DMA controller from assembly language, set up a data structure with the DMA list, and then set \$D702 - \$D700 to the address of the list. For example, to clear the screen in C65-mode by filling it with spaces, the following routine could be used:

```
LDA #$00      ; DMA list exists in BANK 0
STA $D702
LDA #>dmaList ; Set MSB of DMA list address
STA $D701
LDA #<dmaList ; Set LSB of DMA list address, and execute DMA
STA $D700
RTS

dmaList:
.byte $03 ; Command low byte: FILL
.word 2000 ; Count: 80x25 = 2000 bytes
.word $0020 ; Fill with value $20
.byte $00 ; Source bank (ignored with FILL operation)
.word $0800 ; Destination address where screen lives
.byte $00 ; Screen is in bank 0
.byte $00 ; Command high byte
.word $0000 ; Modulo (ignored due to selected command)
```

It is also possible to execute more than one DMA job at the same time, by setting the CHAIN bit in the low byte of the command word. For example to clear the screen as above, and also clear the colour RAM for the screen, you could use something like:

```

LDA #$00      ; DMA list exists in BANK 0
STA $D702
LDA #>dmaList ; Set MSB of DMA list address
STA $D701
LDA #<dmaList ; Set LSB of DMA list address, and execute DMA
STA $D700
RTS

```

dmaList:

```

.byte $04 ; Command low byte: FILL + CHAIN
.word 2000 ; Count: 80x25 = 2000 bytes
.word $0020 ; Fill with value $20
.byte $00 ; Source bank (ignored with FILL operation)
.word $0800 ; Destination address where screen lives
.byte $00 ; Screen is in bank 0
.byte $00 ; Command high byte
.word $0000 ; Modulo (ignored due to selected command)

; Second DMA job immediately follows the first
.byte $03 ; Command low byte: FILL
.word 2000 ; Count: 80x25 = 2000 bytes
.word $0001 ; Fill with value $01 = white
.byte $00 ; Source bank (ignored with FILL operation)
.word $F800 ; Destination address where colour RAM lives
.byte $01 ; colour RAM is in bank 1 ($1F800-$1FFFF)
.byte $00 ; Command high byte
.word $0000 ; Modulo (ignored due to selected command)

```

Copying memory is very similar to filling memory, except that the command low byte must be modified, and the source address field must be correctly initialised. For example, to copy the character set from where it lives in the ROM at \$2D000 - \$2DFFF to \$5000, you could use something like:

```

LDA #500      ; DMA list exists in BANK 0
STA $D702
LDA #>dmaList ; Set MSB of DMA list address
STA $D701
LDA #<dmaList ; Set LSB of DMA list address, and execute DMA
STA $D700
RTS

```

dmaList:

```

.byte 500      ; Command low byte: COPY
.word $1000    ; Count: 4KB = 4096
.word $D000    ; Copy from $xD000
.byte 502      ; Source bank = 502 for $2xxxx
.word $5000    ; Destination address where screen lives
.byte 500      ; Screen is in bank 0
.byte 500      ; Command high byte
.word $0000    ; Modulo (ignored due to selected command)

```

It is also possible to perform a DMA operation from BASIC 2 in C64 mode by POKEing the necessary values, after first making sure that MEGA65 or C65 I/O mode has been selected by writing the appropriate values to \$D02F (53295). For example, to clear the screen in C64 BASIC 2 using the DMA controller, you could use something like:

```

10 rem enable mega65 I/O
20 poke53295,asc("g"):poke53295,asc("s")
30 rem dma list in data statements
40 data 3: rem command lsb = fill
50 data 232,3 : rem screen is 1000 bytes = 3*256+232
60 data 32,0: rem fill with space = 32
70 data 0: rem source bank (unused for fill)
80 data 0,4: rem screen address = 1024 = 4*256
90 data 0: rem screen lives in bank 0
100 data 0: rem command high byte
110 data 0,0: rem modulo (unused in this job)
120 rem put dma list at $c000 = 49152
130 fori=0to11:reada:poke49152+i,a:next
140 rem execute job
150 poke55042,0: rem dma list is in bank 0
160 poke55041,192: rem dma list is in $c0xx
170 poke55040,0: rem dma list is in $xx00, and execute

```

While this is rather cumbersome to do each time, if you wanted to clear the screen again, all you would need to do would be to **POKE 55040, 0** again, assuming that the DMA list and DMA controller registers had not been modified since the previous time the DMA job had been run.

The HOLD, I/O and other options can also be used to create interesting effects. For example, to write a new value to the screen background colour very quickly, you could copy a region of memory to \$D021, with the I/O flag set to make the I/O register visible for writing in the DMA job, and the HOLD flag set, so that the same address gets written to repeatedly. This will write to the background colour at a rate of 20.5MHz, which is almost as fast as the video pixel clock (27MHz). Thus we can change the colour almost every pixel.

With a little care, we can make this routine such that it takes exactly one raster-line to run, and thus draw vertical raster bars, or to create a kind of frankenstein video mode that uses a linear memory layout - at the cost of consuming all of the processor's time during the active part of the display.

The following example does this to draw vertical raster bars on the screen. This program assumes that the MEGA65 is set to PAL. For NTSC, the size of the DMA transfer would need to be decreased a little. The other thing to note with this program, is that it uses MEGA65 Enhanced DMA Job option \$81 to set the destination megabyte in memory to \$FFxxxx, and the bank is set to \$D, and the destination address to \$0021, to form the complete address \$FFD0021. This is the true location of the VIC-IV's border colour register. The program is written using ACME-compatible syntax.

```

basicheader:
;; 2020 SYS 2061
!word $00a,2020
!byte $9e,$32,$30,$36,$31,0,0,0

;; Actual code beginning at $080d = 2061
Main:
sei
lda #$47      ; enable MEGA65 I/O
sta $D02f
lda #$53
sta $d02f
lda #65 ; Set CPU speed to fast
sta 0
lda #0      ; disable screen to show only the border
sta $d011

lda $d012      ; Wait until start of the next raster
raster+sync:   ; before beginning loop for horizontal alignment
cmp $d012
beq raster+sync

;; The following loop takes exactly one raster line at 40.5MHz in PAL
loop:
jsr triggerdma
jmp loop

triggerdma:
lda #0 ; make sure F018 list format
sta $d703

lda #0      ; dma list bank
sta $d702
lda #>rasterdma1ist
sta $d701
lda #<rasterdma1ist
sta $d705
rts

```

```

rasterdmlist:
!byte $81,$ff,$00
!byte $00 ; COPY
!word 619 ; DMA transfer is 619 bytes long
!word rastercolours ; source address
!byte $00 ; source bank
!word $0020 ; destination address
!byte $1d ; destination bank + HOLD
;; unused modulo field
!word $0000

```

```

rastercolours:
!byte 0,0,0,0,0,0,0,0,0,0,0,0,0,0,0
!byte 0,0,0,11,11,11,12,12,12,15,15,15,1,1,1,1,15,15,15,12,12,12,11,11,11,0,0,0
!byte 0,0,0,6,6,6,4,4,4,14,14,14,3,3,3,1,1,1,3,3,3,14,14,14,4,4,4,6,6,6,0,0,0
!byte 0,0,0,11,11,11,12,12,12,15,15,15,1,1,1,1,15,15,15,12,12,12,11,11,11,0,0,0
!byte 0,0,0,6,6,6,4,4,4,14,14,14,3,3,3,1,1,1,3,3,3,14,14,14,4,4,4,6,6,6,0,0,0
!byte 0,0,0,11,11,11,12,12,12,15,15,15,1,1,1,1,15,15,15,12,12,12,11,11,11,0,0,0
!byte 0,0,0,6,6,6,4,4,4,14,14,14,3,3,3,1,1,1,3,3,3,14,14,14,4,4,4,6,6,6,0,0,0
!byte 0,0,0,11,11,11,12,12,12,15,15,15,1,1,1,1,15,15,15,12,12,12,11,11,11,0,0,0
!byte 0,0,0,6,6,6,4,4,4,14,14,14,3,3,3,1,1,1,3,3,3,14,14,14,4,4,4,6,6,6,0,0,0
!byte 0,0,0,11,11,11,12,12,12,15,15,15,1,1,1,1,15,15,15,12,12,12,11,11,11,0,0,0
!byte 0,0,0,6,6,6,4,4,4,14,14,14,3,3,3,1,1,1,3,3,3,14,14,14,4,4,4,6,6,6,0,0,0
!byte 0,0,0,11,11,11,12,12,12,15,15,15,1,1,1,1,15,15,15,12,12,12,11,11,11,0,0,0
!byte 0,0,0,6,6,6,4,4,4,14,14,14,3,3,3,1,1,1,3,3,3,14,14,14,4,4,4,6,6,6,0,0,0
!byte 0,0,0,11,11,11,12,12,12,15,15,15,1,1,1,1,15,15,15,12,12,12,11,11,11,0,0,0
!byte 0,0,0,6,6,6,4,4,4,14,14,14,3,3,3,1,1,1,3,3,3,14,14,14,4,4,4,6,6,6,0,0,0
!byte 0,0,0,11,11,11,12,12,12,15,15,15,1,1,1,1,15,15,15,12,12,12,11,11,11,0,0,0
!byte 0,0,0,6,6,6,4,4,4,14,14,14,3,3,3,1,1,1,3,3,3,14,14,14,4,4,4,6,6,6,0,0,0

```

MEGA65 ENHANCED DMA JOBS

The MEGA65's implementation of the DMAgic supports significantly enhanced DMA jobs. An enhanced DMA job is indicated by writing the low byte of the DMA list address to \$D705 instead of to \$D700. The MEGA65 will then look for one or more *job option tokens* at the start of the DMA list. Those tokens will be interpreted, before executing the DMA job which immediately follows the *end of job options* token (\$00).

Job option tokens that take an argument have the most-significant bit set, and always take a 1 byte option. Job option tokens that take no argument have the most-significant-bit clear. Unsupported job option tokens are simply ignored. This allows for future revisions of the DMAgic to add support for additional options, without breaking backward compatibility.

These options are also used to achieve advanced features, such as hardware texture scaling at up to 20Mpixels per second, and hardware line drawing at up to 40Mpixels per second. These advanced functions are implemented by allowing complex calculations to be made to the source and/or destination address of DMA jobs as they execute.

The list of valid job option tokens is:

\$00	End of job option list
\$06	Disable use of transparent value
\$07	Enable use of transparent value
\$0A	Use 11 byte F011A DMA list format
\$0B	Use 12 byte F011B DMA list format
\$53	Enable 'Shallan Spiral' Mode
\$80	Source address bits 20 - 27
\$81	Destination address bits 20 - 27
\$82	Source skip rate (256 ^{ths} of bytes)
\$83	Source skip rate (whole bytes)
\$84	Destination skip rate (256 ^{ths} of bytes)
\$85	Destination skip rate (whole bytes)
\$86	Transparent value (bytes with matching value are not written)
\$87	Set X column bytes (LSB) for line drawing destination address
\$88	Set X column bytes (MSB) for line drawing destination address
\$89	Set Y row bytes (LSB) for line drawing destination address
\$8A	Set Y row bytes (MSB) for line drawing destination address
\$8B	Slope (LSB) for line drawing destination address
\$8C	Slope (MSB) for line drawing destination address
\$8D	Slope accumulator initial fraction (LSB) for line drawing destination address
\$8E	Slope accumulator initial fraction (MSB) for line drawing destination address
\$8F	Line Drawing Mode enable and options for destination address (set in argument byte): Bit 7 = enable line mode, Bit 6 = select X or Y direction, Bit 5 = slope is negative.
\$97	Set X column bytes (LSB) for line drawing source address
\$98	Set X column bytes (MSB) for line drawing source address
\$99	Set Y row bytes (LSB) for line drawing source address
\$9A	Set Y row bytes (MSB) for line drawing source address
\$9B	Slope (LSB) for line drawing source address
\$9C	Slope (MSB) for line drawing source address
\$9D	Slope accumulator initial fraction (LSB) for line drawing source address
\$9E	Slope accumulator initial fraction (MSB) for line drawing source address
\$9F	Line Drawing Mode enable and options for source address (set in argument byte): Bit 7 = enable line mode, Bit 6 = select X or Y direction, Bit 5 = slope is negative.

TEXTURE SCALING AND LINE DRAWING

The DMAgic supports an advanced internal address calculator that allows it to draw scaled textures and draw lines with arbitrary slopes on VIC-IV FCM video displays.

For texture scaling, the FCM screen must be arranged vertically, as shown below:

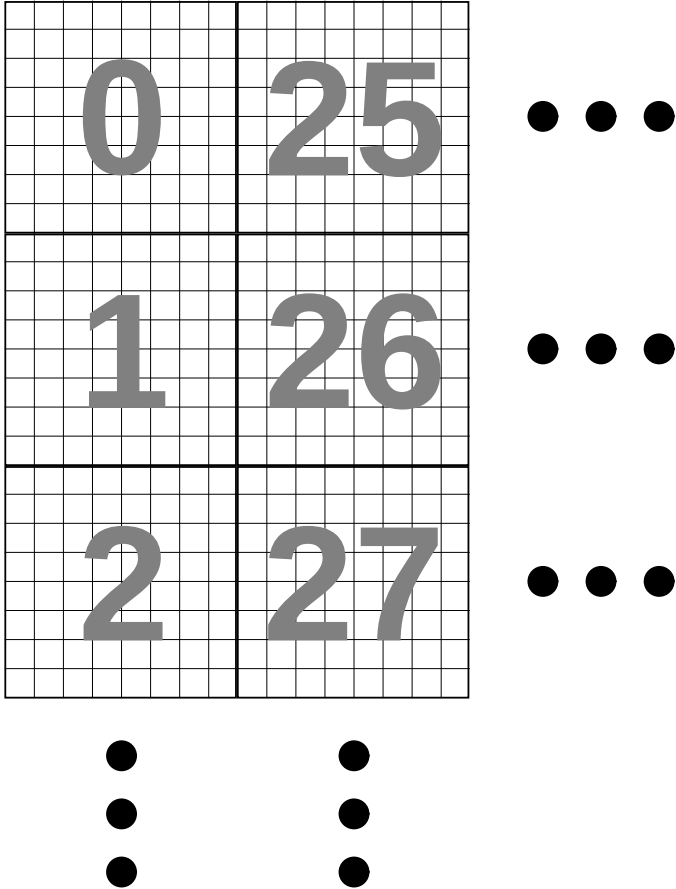

By lining the characters into vertical columns like this, advancing vertically by one pixel adds a constant 8 bytes each time, as shown below:

right. Similarly, it must also know how much must be added to the address of a bottom most pixel in one row of FCM characters in order to calculate the address of the pixel appearing immediately below it. This allows for flexible screen layout options, and arbitrary screen sizes. You must then also specify the slope of the line, and whether the line has the X or Y as its major axis, and whether the slope is positive or negative.

The file `test_290.c` in the <https://github.com/mega65/mega65-tools> repository provides an example of using these facilities to implement hardware accelerated line drawing. This is *very* fast, as it draws lines at the full DMA fill speed, i.e., approximately 40,500,000 pixels per second.

AUDIO DMA

The MEGA65 includes four channels of DMA-driven audio playback that can be used in place of the direct digital audio registers at \$D6F8-\$D6FB. That is, you must select which of these two sources to feed to the audio cross-bar mixer. This is selected via the AUDEN signal (\$D7 1 1 bit 7), which simultaneously enables the audio DMA function in the processor, as well as instructing the audio cross-bar mixer to use the audio from this instead of the \$D6F8-\$D6FB digital audio registers. If you wish to have no other audio than the audio DMA channels, the audio cross-bar mixer can be bypassed, and the DMA audio played at full volume by setting the NOMIX signal (\$D7 1 1 bit 4). In that mode no audio from the SIDs, FM, microphones or other sources will be available. All other bits in \$D7 1 1 should ordinarily be left clear, i.e., write \$80 to \$D7 1 1 to enable audio DMA.

Two channels form the left digital audio channel, and the other two channels form the right digital audio channel. It is these left and right channels that are then fed into the MEGA65's audio cross-bar mixer.

As the DMA controller is part of the processor of the MEGA65, and the MEGA65 does not have reserved bus slots for multi-media operations, the MEGA65 uses idle CPU cycles to perform background DMA. This requires that the MEGA65 CPU be set to the "full speed" mode, i.e., approximately 40MHz. In this mode, there is a wait-state whenever reading an operand from memory. Thus each instruction that loads a byte from memory will create one implicit audio DMA slot. This is rarely a problem in practice, except if the processor idles in a very tight loop. To ensure that audio continues to play in the background, such loops should include a read instruction, such as:

```
loop: LDA $1234 // Ensure loop has at least one idle cycle for
        // audio DMA
        JMP loop
```

Each of the four DMA channels is configured using a block of 16 registers at \$D720, \$D730, \$D740 and \$D750, respectively. We will explain the registers for the first channel, channel 0, at \$D720 - \$D72F.

Sample Address Management

To play an audio sample you must first supply the start address of the sample. This is a 24-bit address, and must be in the main chip memory of the MEGA65. This is done by writing the address into \$D72A - \$D72C. This is the address of the first sample value that will be played. You must then provide the end address of the sample in \$D727 - \$D728. But note that this is only 16 bits. This is because the MEGA65 compares only the bottom 16 bits of the address when checking if it has reached the end of a sample. In practice, this means that samples cannot be more than 64KB in size. If the sample contains a section that should be repeated, then the start address of the repeating part should be loaded into \$D721 - \$D723, and the CH0LOOP bit should be set (\$D720 bit 6).

You can determine the current sample address at any time by reading the registers at \$D72A - \$D72C. But beware: These registers are not latched, so it is possible that the values may be updated as you read the registers, unless you stop the channel first by clearing the CH0EN signal.

Sample Playback frequency and Volume

The MEGA65 controls the playback rate of audio DMA samples by using a 24-bit counter. Whenever the 24-bit counter overflows, the next sample is requested. Sample speed control is achieved by setting the value added to this counter each CPU cycle. Thus a value of \$FFFFFF would result in a sample rate of almost 40.5 MHz. In practice, sample rates above a few megahertz are not possible, because there are insufficient idle CPU cycles, and distorted audio will result. Even below this, care must be taken to ensure that idle cycles come sufficiently often and dispersed throughout the processor's instruction stream to prevent distortion. At typical sample rates below 16KHz and using 8-bit samples these effects are typically negligible for normal instruction streams, and so no special action is normally required for typical audio playback.

At the other end of the scale, sample rates as low as $40.5\text{MHz}/2^{24} = 2.4$ samples per second are possible. This is sufficiently low enough for even the most demanding infra-sound applications.

Volume is controlled by setting \$D729. Maximum volume is obtained with the value \$FF, while a value of \$00 will effectively mute the channel. The first two audio channels are normally allocated to the left, and the second two to the right. However, the MEGA65 includes separate volume controls for the opposite channels. For example, to play audio DMA channel 0 at full volume on both left and right-hand sides of the audio output, set both \$D729 and \$D71C to \$FF. This allows panning of the four audio DMA channels.

Both the frequency and volume can be freely adjusted while a sample is playing to produce various effects.

Pure Sine Wave

Where it is necessary to produce a stable sine wave, especially at higher frequencies, there is a special mode to support this. By setting the CH0SINE signal, the audio channel will play a 32 byte 16-bit sine wave pattern. The sample addresses still need to be set, as though the sine wave table were located in the bottom 64 bytes of memory, as the normal address generation logic is used in this mode. However, no audio DMA fetches are performed when a channel is in this mode, thus avoiding all sources of distortion due to irregular spacing of idle cycles in the processor's instruction stream.

This can be used to produce sine waves in both the audible range, as well as well into the ultrasonic range, at frequencies exceeding 60,000Hz, provided that the MEGA65 is connected to an appropriately speaker arrangement.

Sample playback control

To begin a channel playing a sample, set the CH0EN signal (\$D720 bit 7). The sample will play until its completion, unless the CH0LOOP signal has also been set. When a sample completes playing, the CH0STP flag will be set. The audio DMA subsystem cannot presently generate interrupts.

Unlike on the Amiga™, the MEGA65 audio DMA system supports both 8 and 16-bit samples. It also supports packed 4-bit samples, playing either the lower or upper nibble of each sample byte. This allows two separate samples to occupy the same byte, thus effectively halving the amount of space required to store two equal length samples.

F018 "DMAGIC" DMA CONTROLLER

HEX	DEC	Signal	Description
D700	55040	ADDRLSB-TRIG	DMAgic DMA list address LSB, and trigger DMA (when written)
D701	55041	ADDRMSB	DMA list address high byte (address bits 8 - 15).
D702	55042	ADDRBANK	DMA list address bank (address bits 16 - 22). Writing clears \$D704.

MEGA65 DMA CONTROLLER EXTENSIONS

HEX	DEC	DB7	DB6	DB5	DB4	DB3	DB2	DB1	DB0
D703	55043	-							EN018B
D704	55044	ADDRMB							
D705	55045	ETRIG							
D70E	55054	ADDRLSB							
D711	55057	AUDEN	BLKD	AUDWR- BLK	NOMIX	-	AUDBLKTO		
D71C	55068	CH0RVOL							
D71D	55069	CH1RVOL							
D71E	55070	CH2LVOL							
D71F	55071	CH3LVOL							
D720	55072	CH0EN	CH0LOOP	CH0SGN	CH0SINE	CH0STP	-	CH0SBITS	
D721	55073	CH0BADDR							
D722	55074	CH0BADDR							
D723	55075	CH0BADDR							
D724	55076	CH0FREQ							
D725	55077	CH0FREQ							
D726	55078	CH0FREQ							
D727	55079	CH0TADDR							
D728	55080	CH0TADDR							
D729	55081	CH0VOLUME							
D72A	55082	CH0CURADDR							
D72B	55083	CH0CURADDR							
D72C	55084	CH0CURADDR							
D72D	55085	CH0TMRADDR							
D72E	55086	CH0TMRADDR							

continued ...

...continued

HEX	DEC	DB7	DB6	DB5	DB4	DB3	DB2	DB1	DB0
D72F	55087	CH0TMRADDR							
D730	55088	CH1EN	CH1LOOP	CH1SGN	CH1SINE	CH1STP	-	CH1SBITS	
D731	55089	CH1BADDR							
D732	55090	CH1BADDR							
D733	55091	CH1BADDR							
D734	55092	CH1FREQ							
D735	55093	CH1FREQ							
D736	55094	CH1FREQ							
D737	55095	CH1TADDR							
D738	55096	CH1TADDR							
D739	55097	CH1VOLUME							
D73A	55098	CH1CURADDR							
D73B	55099	CH1CURADDR							
D73C	55100	CH1CURADDR							
D73D	55101	CH1TMRADDR							
D73E	55102	CH1TMRADDR							
D73F	55103	CH1TMRADDR							
D740	55104	CH2EN	CH2LOOP	CH2SGN	CH2SINE	CH2STP	-	CH1SBITS	
D741	55105	CH2BADDR							
D742	55106	CH2BADDR							
D743	55107	CH2BADDR							
D744	55108	CH2FREQ							
D745	55109	CH2FREQ							
D746	55110	CH2FREQ							
D747	55111	CH2TADDR							
D748	55112	CH2TADDR							
D749	55113	CH2VOLUME							
D74A	55114	CH2CURADDR							
D74B	55115	CH2CURADDR							
D74C	55116	CH2CURADDR							
D74D	55117	CH2TMRADDR							
D74E	55118	CH2TMRADDR							
D74F	55119	CH2TMRADDR							
D750	55120	CH3EN	CH3LOOP	CH3SGN	CH3SINE	CH3STP	-	CH3SBITS	
D751	55121	CH3BADDR							
D752	55122	CH3BADDR							
D753	55123	CH3BADDR							
D754	55124	CH3FREQ							

continued ...

...continued

HEX	DEC	DB7	DB6	DB5	DB4	DB3	DB2	DB1	DB0
D755	55125								CH3FREQ
D756	55126								CH3FREQ
D757	55127								CH3TADDR
D758	55128								CH3TADDR
D759	55129								CH3VOLUME
D75A	55130								CH3CURADDR
D75B	55131								CH3CURADDR
D75C	55132								CH3CURADDR
D75D	55133								CH3TMRADDR
D75E	55134								CH3TMRADDR
D75F	55135								CH3TMRADDR

- **ADDRLSB** DMA list address low byte (address bits 0 - 7) WITHOUT STARTING A DMA JOB (used by Hypervisor for unfreezing DMA-using tasks)
- **ADDRMB** DMA list address mega-byte
- **AUDBLKTO** Audio DMA block timeout (read only) DEBUG
- **AUDEN** Enable Audio DMA
- **AUDWRBLK** Audio DMA block writes (samples still get read)
- **BLKD** Audio DMA blocked (read only) DEBUG
- **CH0BADDR** Audio DMA channel 0 base address LSB
- **CH0CURADDR** Audio DMA channel 0 current address LSB
- **CH0EN** Enable Audio DMA channel 0
- **CH0FREQ** Audio DMA channel 0 frequency LSB
- **CH0LOOP** Enable Audio DMA channel 0 looping
- **CH0RVOL** Audio DMA channel 0 right channel volume
- **CH0SBITS** Audio DMA channel 0 sample bits (11=16, 10=8, 01=upper nybl, 00=lower nybl)
- **CH0SGN** Enable Audio DMA channel 0 signed samples
- **CH0SINE** Audio DMA channel 0 play 32-sample sine wave instead of DMA data
- **CH0STP** Audio DMA channel 0 stop flag
- **CH0TADDR** Audio DMA channel 0 top address LSB

- **CH0TMRADDR** Audio DMA channel 0 timing counter LSB
- **CH0VOLUME** Audio DMA channel 0 playback volume
- **CH1BADDR** Audio DMA channel 1 base address LSB
- **CH1CURADDR** Audio DMA channel 1 current address LSB
- **CH1EN** Enable Audio DMA channel 1
- **CH1FREQ** Audio DMA channel 1 frequency LSB
- **CH1LOOP** Enable Audio DMA channel 1 looping
- **CH1RVOL** Audio DMA channel 1 right channel volume
- **CH1SBITS** Audio DMA channel 1 sample bits (11=16, 10=8, 01=upper nybl, 00=lower nybl)
- **CH1SGN** Enable Audio DMA channel 1 signed samples
- **CH1SINE** Audio DMA channel 1 play 32-sample sine wave instead of DMA data
- **CH1STP** Audio DMA channel 1 stop flag
- **CH1TADDR** Audio DMA channel 1 top address LSB
- **CH1TMRADDR** Audio DMA channel 1 timing counter LSB
- **CH1VOLUME** Audio DMA channel 1 playback volume
- **CH2BADDR** Audio DMA channel 2 base address LSB
- **CH2CURADDR** Audio DMA channel 2 current address LSB
- **CH2EN** Enable Audio DMA channel 2
- **CH2FREQ** Audio DMA channel 2 frequency LSB
- **CH2LOOP** Enable Audio DMA channel 2 looping
- **CH2LVOL** Audio DMA channel 2 left channel volume
- **CH2SGN** Enable Audio DMA channel 2 signed samples
- **CH2SINE** Audio DMA channel 2 play 32-sample sine wave instead of DMA data
- **CH2STP** Audio DMA channel 2 stop flag
- **CH2TADDR** Audio DMA channel 2 top address LSB
- **CH2TMRADDR** Audio DMA channel 2 timing counter LSB
- **CH2VOLUME** Audio DMA channel 2 playback volume
- **CH3BADDR** Audio DMA channel 3 base address LSB

- **CH3CURADDR** Audio DMA channel 3 current address LSB
- **CH3EN** Enable Audio DMA channel 3
- **CH3FREQ** Audio DMA channel 3 frequency LSB
- **CH3LOOP** Enable Audio DMA channel 3 looping
- **CH3LVOL** Audio DMA channel 3 left channel volume
- **CH3SBITS** Audio DMA channel 3 sample bits (11=16, 10=8, 01=upper nybl, 00=lower nybl)
- **CH3SGN** Enable Audio DMA channel 3 signed samples
- **CH3SINE** Audio DMA channel 3 play 32-sample sine wave instead of DMA data
- **CH3STP** Audio DMA channel 3 stop flag
- **CH3TADDR** Audio DMA channel 3 top address LSB
- **CH3TMRADDR** Audio DMA channel 3 timing counter LSB
- **CH3VOLUME** Audio DMA channel 3 playback volume
- **EN018B** DMA enable F0 18B mode (adds sub-command byte)
- **ETRIG** Set low-order byte of DMA list address, and trigger Enhanced DMA job (uses DMA option list)
- **NOMIX** Audio DMA bypasses audio mixer

UNIMPLEMENTED FUNCTIONALITY

The MEGA65's DMAgic does not currently support either memory-swap or mini-term operations.

Miniterms were intended for bitplane blitting, which is not required for the MEGA65 which offers greatly advanced character modes and stepped and fractional DMA address incrementing which allows efficient texture copying and scaling. Also there exists no known software which ever used this facility, and it remains uncertain if it was ever implemented in any revision of the DMAgic chip used in C65 prototypes.

The memory-swap operation is intended to be implemented, but can be worked around in the meantime by copying the first region to a 3rd region that acts as a temporary buffer, then copying the 2nd region to the 1st, and the 3rd to the 2nd.

APPENDIX

M

VIC-IV Video Interface Controller

- **Features**
- **VIC-II/III/IV Register Access Control**
- **Video Output Formats, Timing and
Compatibility**
- **Memory Interface**
- **Hot Registers**
- **New Modes**
- **Sprites**

- **VIC-II / C64 Registers**
- **VIC-III / C65 Registers**
- **VIC-IV / MEGA65 Specific Registers**

FEATURES

The VIC-IV is a fourth generation Video Interface Controller developed especially for the MEGA65, and featuring very good backwards compatibility with the VIC-II that was used in the C64, and the VIC-III that was used in the C65. The VIC-IV can be programmed as though it were either of those predecessor systems. In addition it supports a number of new features. It is easy to mix older VIC-II/III features with the new VIC-IV features, making it easy to transition from the VIC-II or VIC-III to the VIC-IV, just as the VIC-III made it easy to transition from the VIC-II. Some of the new features and enhancements of the VIC-IV include:

- **Direct access to 384KB RAM** (up from 16KB/64KB with the VIC-II and 128KB with the VIC-III).
- Support for **32KB of 8-bit Colour/Attribute RAM** (up from 2KB on the VIC-III), to support very large screens.
- **HDTV 720×576 / 800×600 native resolution** at both 50Hz and 60Hz for **PAL and NTSC**, with **VGA and digital video** output.
- **81MHz pixel clock** (up from ~ 8MHz with the VIC-II/III), which enables a wide range of new features.
- New 16-colour (16×8 pixels per character cell) and 256-colour (8×8 pixels per character cell) **full-colour text modes**.
- Support for up to **8,192 unique characters in a character set**.
- **Four 256-colour palette banks** (versus the VIC-III's single palette bank), each supporting **23-bit colour depth** (versus the VIC-III's 12-bit colour depth), and which can be rapidly alternated to create even more colourful graphics than is possible with the VIC-III.
- Screen, bitmap, colour and character data can be positioned at any **address with byte-level granularity** (compared with fixed 1KB - 16KB boundaries with the VIC-II/III)
- **Virtual screen dimensioning**, which combined with byte-level data position granularity provides effective **hardware support for scrolling and panning in both X and Y directions**.
- **New sprite modes**: Bitplane modification, **full-colour** (15 foreground colours + transparency) and tiled modes, allowing a wide variety of new and exciting sprite-based effects
- The ability to stack sprites in a bit-planar manner to produce **sprites with up to 256 colours**.

- Sprites can use 64 bits of data per raster line, allowing **sprites to be 64 pixels wide** when using VIC-II/III mono/multi-colour mode, or 16 pixels wide when using the new VIC-IV full-colour sprite mode.
- **Sprite tile mode**, which allows a sprite to be repeated horizontally across an entire raster line, allowing sprites to be used to create animated backgrounds in a memory-efficient manner.
- Sprites can be configured to use a **separate 256-colour palette** to that used to draw other text and graphics, allowing for a more colourful display.
- **Super-extended attribute mode** which uses two screen RAM bytes and two colour RAM bytes per character mode, which supports a wide variety of new features including **alpha-blending/anti-aliasing, hardware kerning/variable-width characters**, hardware horizontal/vertical flipping, alternate palette selection and other powerful features that make it easy to create highly dynamic and colourful displays.
- **Raster-Rewrite Buffer** which allows **hardware-generated pseudo-sprites**, similar to “bobs” on Amiga™ computers, but with the advantage that they are rendered in the display pipeline, and thus do not need to be un-drawn and re-drawn to animate them.
- **Multiple 8-bit colour play-fields** are also possible using the Raster-Rewrite Buffer.

In short, the VIC-IV is a powerful evolution of the VIC-II/III, while retaining the character and distinctiveness of the VIC-series of video controllers.

For a full description of the additional registers that the VIC-IV provides, as well as documentation of the legacy VIC-II and VIC-III registers, refer to the corresponding sections of this appendix. The remainder of the appendix will focus on describing the capabilities and use of many of the VIC-IV’s new features.

VIC-II/III/IV REGISTER ACCESS CONTROL

Because the new features of the VIC-IV are all extensions to the existing VIC-II/III designs, there is no concept of having to select the mode in which the VIC-IV will operate: It is always in VIC-IV mode. However, for backwards compatibility with software, the many additional registers of the VIC-IV can be hidden, so that it appears to be either a VIC-II or VIC-III. This is done in the same manner that the VIC-III uses to hide its new features from legacy VIC-II software.

The mechanism is the VIC-III write-only KEY register (\$D02F, 53295 decimal). The VIC-III by default conceals its new features until a “knock” sequence is performed. This consists of writing two special values one after the other to \$D02F. The following table summarises the knock sequences supported by the VIC-IV, and indicates which are VIC-IV specific, and which are supported by the VIC-III:

First Value Hex (Decimal)	Second Value Hex (Decimal)	Effect	VIC-IV Specific?
\$00 (0)	\$00 (0)	Only VIC-II registers visible (all VIC-III and VIC-IV new registers are hidden)	No
\$A5 (165)	\$96 (150)	VIC-III new registers visible	No
\$47 (71)	\$53 (83)	Both VIC-III and VIC-IV new registers visible	Yes
\$45 (69)	\$54 (84)	No VIC-II/III/IV registers visible. 45E100 Ethernet controller buffers are visible instead	Yes

Detecting VIC-II/III/IV

Detecting which generation of the VIC-II/III/IV a machine is fitted with can be important for programs that support only particular generations, or that wish to vary their graphical display based on the capabilities of the machine. While there are many possibilities for this, the following is a simple and effective method. It relies on the fact that the VIC-III and VIC-IV do not repeat the VIC-II registers throughout the I/O address space. Thus while \$D000 and \$D100 are synonymous when a VIC-II is present (or a VIC-III/IV is hiding their additional registers), this is not the case when a VIC-III or VIC-IV is making all of its registers visible. Therefore presence of a VIC-III/IV can be determined by testing whether these two locations are aliases for the same register, or represent separate registers. The detection sequence consists of using the KEY register to attempt to make either VIC-IV or VIC-III additional registers visible. If either succeeds, then we can assume that the corresponding generation of VIC is installed. As the VIC-IV supports the VIC-III KEY knocks, we must first test for the presence of a VIC-IV. Also, we assume that the MEGA65 starts in VIC-IV mode, even when running C65 BASIC. Thus the test can be done in BASIC from either C64 or C65-mode as follows:

```

0 REM IN C65-MODE WE CANNOT SAFELY WRITE TO $D02F, SO WE TEST A DIFFERENT WAY
10 IF PEEK($D018) AND 32 THEN GOTO 65
20 POKE $D000,1:POKE $D02F,71:POKE $D02F,83
30 POKE $D000+256,0:IF PEEK($D000)=1 THEN PRINT"VIC-IV PRESENT":END
40 POKE $D000,1:POKE $D02F,165:POKE $D02F,150
50 POKE $D000+256,0:IF PEEK($D000)=1 THEN PRINT"VIC-III PRESENT":END
60 PRINT "VIC-II PRESENT":END
65 REM WE ASSUME WE HAVE A C65 HERE
70 V1=PEEK($D050):V2=PEEK($D050):V3=PEEK($D050)
80 IF V1<>V2 OR V1<>V3 OR V2<>V3 THEN PRINT "VIC-IV PRESENT":END
90 GOTO 40

```

Line 10 of this program checks whether the screen is a multiple of 2KB. As the screen on the C64 is located at 1KB, this test will fail, and execution will continue to line 20. Line 20 writes 1 to one of the VIC-II sprite position registers, 53248, before writing the MEGA65 knock to the key register, 53295. Line 30 writes to 53248 + 256, which on the C64 is a mirror of 53248, but on a MEGA65 with VIC-IV I/O enabled will be one of the red palette registers. After writing to 53248 + 256, the program checks if the register at 53248 has been modified by the write to 53248 + 256. If it has, then the two addresses point to the same register. This will happen on either a C64 or C65, but not on a computer with a VIC-IV. Thus if 53248 has not changed, we report that we have detected a VIC-IV. If writing to 53248 + 256 did change the value in register 53248, then we proceed to line 40, which writes to 53248 again, and this time writes the VIC-III knock to the key register. Line 50 is like line 30, but as it appears after a VIC-III knock, it allows the detection of a VIC-III. Finally, if neither a VIC-IV nor VIC-III is detected, we conclude that only a VIC-II must be present.

As the MEGA65 is the only C64-class computer that is fitted with a VIC-IV, this can be used as a *de facto* test for the presence of a MEGA65 computer. Detection of a VIC-III can be similarly assumed to indicate the presence of a C65.

VIDEO OUTPUT FORMATS, TIMING AND COMPATIBILITY

Integrated Marvellous Digital Hookup™(IMDH™) Digital Video Output

The MEGA65 features VGA analog video output and Integrated Marvellous Digital Hookup™ (IMDH™). This is different to existing common digital video standards in several key points:

1. We didn't invent a new connector for it: We instead used the most common digital video connector already in use. So your existing cables should work fine!
2. We didn't make it purposely incompatible with any existing digital video standard. So your existing TVs and monitors should work fine!
3. We don't engage in highway-robbery for other vendors to use the IMDH™ digital video standard, by trying to charge them \$10,000 every year, just for the permission to be able to sell a single device. This means that the MEGA65 is cheaper for you!
4. The IMDH™ standard does not allow content-protection or other sovereignty eroding flim-flam. If you produced the video, you can do whatever you like with it!

Connecting to Naughty Proprietary Digital Video Standards

There are digital video standards that are completely backwards compared with IMDH™. Fortunately because of IMDH™'s open approach to interoperability, these should, in most cases, function with the MEGA65 without difficulty. Simply find a video cable fits the IMDH™connector on the back of your MEGA65, and connect it to your MEGA65 and a TV, Monitor or Projector that has the same connector.

However, regrettably, not all manufacturers have submitted their devices for IMDH™compliance testing with the MEGA65 team. This means that some TVs and Monitors are, unfortunately, not IMDH™compliant. Thus while most TVs and Monitors will work with the MEGA65, you might find that you need to try a couple to get a satisfactory result. If you do find a monitor that doesn't work with the MEGA65, please let us know, and also report the problem to the Monitor vendor, recommending that they submit their devices for IMDH™compliance testing.

The VIC-IV was designed for use in the MEGA65 and related systems, including the MEGAsphere family of portable devices. The VIC-IV supports both VGA and digital video output, using the non-proprietary IMDH™ interface. It also supports parallel digital video output suitable for driving LCD display panels. Considerable care has been taken to create a common video front-end that supports these three output modes.

For simplicity and accuracy of frame timing for legacy software, the video format is normally based on the HDTV PAL and NTSC 720×576/480 (576p and 480p) modes using a 27MHz output pixel clock. This is ideal for digital video and LCD display panels. However not all VGA displays support these modes, especially 720×576 at 50Hz.

In terms of VIC-II and VIC-III backwards compatibility, this display format has several effects that do not cause problems for most programs, but can cause some differences in behaviour:

1. Because the VIC-IV display is progressive rather than interlaced, two physical raster lines are produced for each logical VIC-II or VIC-III raster line. This means that there are either 63 or 65 cycles per logical double raster, rather than per physical 576p/480p physical raster. This can cause some minor visual artefacts, when programs make assumptions about where on a horizontal line the VIC is drawing when, for example, the border or screen colour is changed.
2. The VIC-IV does not follow the behaviour of the VIC-III, which allowed changes in video modes, e.g., between text and bitmap mode, on characters. Nor does it follow the VIC-II's policy of having such changes take effect immediately. Instead, the VIC-IV applies changes at the start of each raster line. This can cause some minor artefacts.
3. The VIC-IV uses a single-raster rendering buffer which is populated using the VIC-IV's internal 81MHz pixel clock, before being displayed using the 27MHz output pixel clock. This means that a raster lines display content tends to be rendered much earlier in a raster line than on either the VIC-II or VIC-III. This can cause some artefacts with displays, particularly in demos that rely on specific behaviour of the VIC-II at particular cycles in a raster line, for example for effects such as VSP or FLI. At present, such effects are unlikely to display correctly on the current revision of the VIC-IV. Improved support for these features is planned for a future revision of the VIC-IV.
4. The 1280×200 and 1280×400 display modes of the VIC-III are not currently supported, as they cannot be meaningfully displayed on any modern monitor, and no software is known to support or use this feature.

Frame Timing

Frame timing is designed to match that of the 6502 + VIC-II combination of the C64. Both PAL and NTSC timing is supported, and the number of cycles per logical raster line, the number of raster lines per frame, and the number of cycles per frame are all adjusted accordingly. To achieve this, the VIC-IV ordinarily uses HDTV 576p 50Hz (PAL) and 480p 60Hz (NTSC) video modes, with timing tweaked to be as close as possible to double-scan PAL and NTSC composite TV modes as used by the VIC-II.

The VIC-IV produces timing impulses at approximately 1MHz which are used by the 45GS02 processor, so that the correct effective frequency is provided when operating at the 1MHz, 2MHz and 3.5MHz C64, C128 and C65 compatibility modes. This allows the single machine to switch between accurate PAL and NTSC CPU timing, as well as video modes. The exact frequency varies between PAL and NTSC modes, to mimic the behaviour of PAL versus NTSC C64, C128 and C65 processor and video timing.

The PAL frame is constructed from 624 physical raster lines, consisting of 864 pixel clock ticks. The pixel clock is 27MHz, which is 1/3 the VIC-IV pixel clock. The visible frame is 720×576 pixels, the entirety of which can be used in VIC-IV mode. In VIC-II and VIC-III modes, the border area reduces the usable size to 640×400 pixels. In VIC-II mode and VIC-III 200H modes, the display is double scanned, with two 31.5 micro-second physical rasters corresponding to a single 63 micro-second VIC-II-style raster line. Thus each frame consists of 312 VIC-II raster lines of 63 micro-seconds each, exactly matching that of a PAL C64.

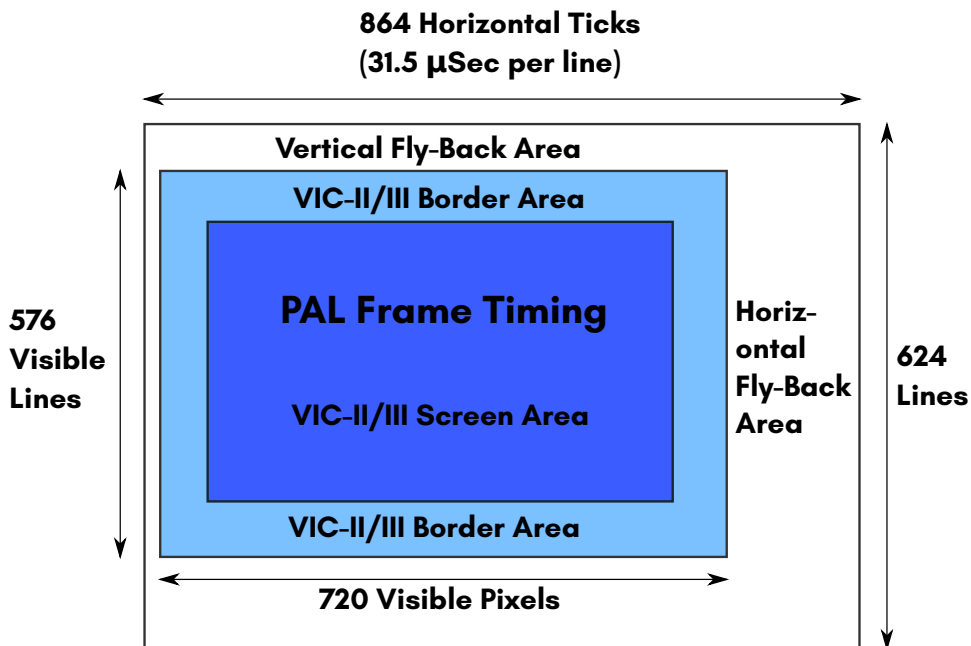

The NTSC frame is constructed from 526 physical raster lines, consisting of 858 pixel clock ticks. The pixel clock is 27MHz, which is 1/3 the VIC-IV pixel clock. The visible frame is 720×480 pixels, the entirety of which can be used in VIC-IV mode. In VIC-II and VIC-III modes, the border area reduces the usable size to 640×400 pixels. In VIC-II mode and VIC-III 200H modes, the display is double scanned, with two 32 micro-second physical rasters corresponding to a single 64 micro-second VIC-II-style raster line. Thus each frame consists of 263 VIC-II raster lines of 64 micro-seconds each, matching the most common C64 NTSC video timing.

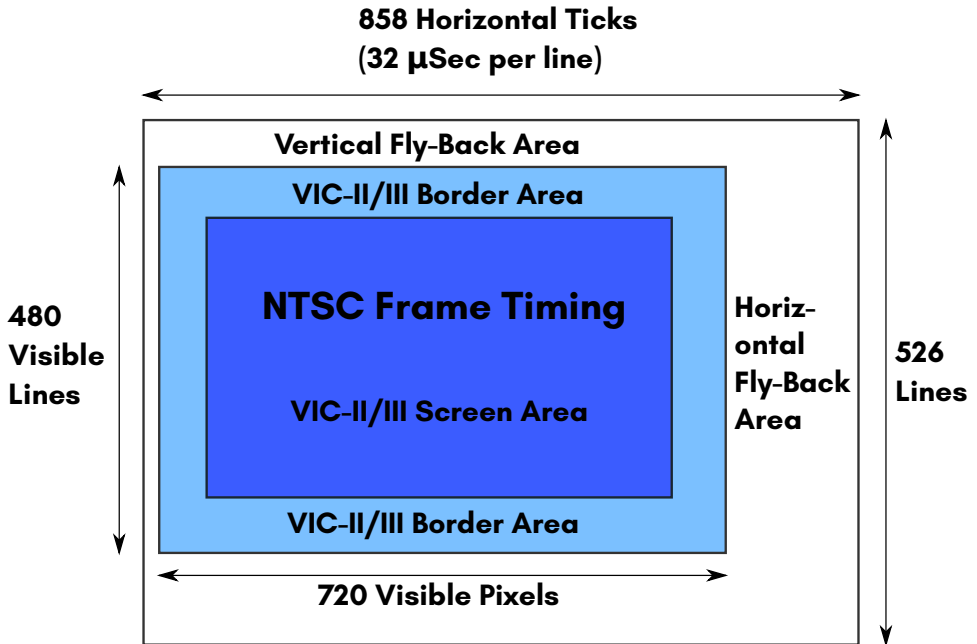

As these HDTV video modes are not supported by all VGA monitors, a compatibility mode is included that provides a 640×480 VGA-style mode. However, as the pixel clock of the MEGA65 is fixed at 27MHz, this mode runs at 63Hz. Nonetheless, this should work on the vast majority of VGA monitors. There should be no problem with the PAL / NTSC modes when using the digital video output of the MEGA65 with the vast majority of IMDH™-enabled monitors and TVs.

To determine whether the MEGA65 is operating in PAL or NTSC, you can enter the Freeze Menu, which displays the current video mode, or from a program you can check the PALNTSC signal (bit 7 of \$D06F, 53359 decimal). If this bit is set, then the machine is operating in NTSC mode, and clear if operating in PAL mode. This bit can be modified to change between the modes, e.g.:

```

10 REM ENABLE C65+MEGA65 I/O
20 IF PEEK($D018)<32 THEN POKE $D02F,ASC("6"):POKE $D02F,ASC("5")
30 REM CHECK NTSC BIT
40 NTSC=PEEK($D06F) AND 128
50 REM DISPLAY STATE AND ASK FOR TOGGLE
60 PRINT"MEGA65 IS IN ";:IF NTSC THEN PRINT"NTSC MODE":ELSE PRINT"PAL MODE"
70 INPUT"SWITCH MODES (Y/N)? ",A$
80 REM TOGGLE NTSC BIT
90 IF A$="Y" THEN POKE $D06F,PEEK($D06F) XOR 128:ELSE END
100 REM DISPLAY NEW STATE
110 NTSC=PEEK($D06F) AND 128
120 PRINT"MEGA65 IS IN ";:IF NTSC THEN PRINT"NTSC MODE":ELSE PRINT"PAL MODE"

```

Physical and Logical Rasters

Physical rasters per frame refers to the number of actual raster lines in the PAL or NTSC Enhanced Definition TV (EDTV) video modes used by the MEGA65. Logical Rasters refers to the number of VIC-II-style rasters per frame. Each logical raster consists of two physical rasters per line, since EDTV modes are double-scan modes compared with the original PAL and NTSC Standard Definition TV modes used by the C64. The frame parameters of the VIC-IV for PAL and NTSC are as follows:

Standard	Cycles per Raster	Physical Rasters per Frame	Logical Rasters per Frame
PAL	63	626	312
NTSC	65	526	263

The result is that the frames on the VIC-IV consist of exactly the same number of ~ 1MHz CPU cycles as on the VIC-II exactly.

Bad Lines

The VIC-IV does not natively incur any “bad lines”, because the VIC-IV has its own dedicated memory busses to the main memory and colour RAM of the MEGA65. This means that both the processor and VIC-IV can access the memory at the same time, unlike on the C64 or C65, where they are alternated.

However, to improve compatibility, the VIC-IV signals when a “bad line” would have occurred on the VIC-II. The 45GS02 processor of the MEGA65 accepts these bad line signals, and pauses the CPU for 40 clock cycles, except if the processor is running at full speed, in which case they are ignored. This improves the timing compatibility with the VIC-II considerably. However, the timing is not exact, because the current revision of the 45GS02 pauses for exactly 40 cycles, instead of 40 – 43 cycles, depending on the instruction being executed at the time. Also, the VIC-IV and 45GS02 do not currently pause for sprite fetches.

The bad line emulation is controlled by bit 0 of \$D7 10: setting this bit enables bad line emulation, and clearing it prevents any bad line from stealing time from the processor.

MEMORY INTERFACE

The VIC-IV supports up to 64KB of colour RAM and, in principle, 16MB of direct access RAM for video data. However in typical installations 32KB of colour RAM and 384KB of addressable RAM is present. In MEGA65 systems, the second 128KB of RAM is typically used to hold a C65-compatible ROM, leaving 256KB available, unless software is written to avoid the need to use C65 ROM routines, in which case all 384KB can be used.

The VIC-IV supports all legacy VIC-II and VIC-III methods for accessing this RAM, including the VIC-II’s use of 16KB banks, and the VIC-III’s Display Address Translator (DAT). This additional memory can be used for character and bitmap displays, as well as for sprites. However, the VIC-III bitplane modes remain limited to using only the first 128KB of RAM, as the VIC-IV does not enhance the bitplane mode.

Relocating Screen Memory

To use the additional memory for screen RAM, the screen RAM start address can be adjusted to any location in memory with byte-level granularity by setting the SCRNPTR registers (\$D060 – \$D063, 53344 – 53347 decimal). For example, to set the screen memory to address 12345:

```
REM ENABLE C65+MEGA65 I/O
IF PEEK($D018)<32 THEN POKE $D02F,ASC("6"):POKE $D02F,ASC("5")
POKE $D060,$45:POKE $D061,$23:POKE $D062,$1
```

Relocating Character Generator Data

The location of the character generator data can also be set with byte-level precision via the CHARPTR registers at \$D068 - \$D06A (53352 - 53354 decimal). As usual, the first of these registers holds the lowest-order byte, and the last the highest-order byte. The three bytes allow for placement of character data anywhere in the first 16MB of RAM. For systems with less than 16MB of RAM accessible by the VIC-IV, the upper address bits should be zero.

For example, to indicate that character generator data should be sourced beginning at \$41200 (266752 decimal), the following could be used. Note that the AND binary operator only works with arguments between 0 and 65,535. Therefore we first subtract $4 \times 65,536 = 262,144$ from the address (the 4 is determined by calculating $\text{INT}(266752/65536)$), before we use the AND operator to compute the lower part of the address:

```
REM ENABLE C65+MEGA65 I/O
IF PEEK($D018)<32 THEN POKE $D02F,ASC("G"):POKE $D02F,ASC("S")
REM HEX $41200 IS EASILY DIVIDED IN ITS 3 BYTES $00, $12, $4
REM BUT YOU CAN ALSO USE MATH TO EXTRACT THE PARTS
POKE $D060,(266752-INT(266752/65536)*$10000) AND 255
POKE $D061,INT((266752-INT(266752/65536)*65536)/256)
POKE $D062,INT(266752/65536)
```

Relocating Colour / Attribute RAM

The area of colour RAM being used can be similarly set using the COLPTR registers (\$D064 - \$D065, 53348 - 53349 decimal). That is, the value is an offset from the start of the colour / attribute RAM. This is because, like on the C64, the colour / attribute RAM of the MEGA65 is a separate memory component, with its own dedicated connection to the VIC-IV. By default, the COLPTRs are set to zero, which replicates the behaviour of the VIC-II/III. To set the display to use the colour / attribute RAM beginning at offset \$4000, one could use something like:

```
REM ENABLE C65+MEGA65 I/O
IF PEEK($D018)<32 THEN POKE $D02F,ASC("G"):POKE $D02F,ASC("S")
REM SET COLPTR TO $4000, SPLITS INTO $00 LSB and $40 MSB
POKE $D064,$00
POKE $D065,$40
```

Relocating Sprite Pointers and Images

The location of the sprite pointers can also be moved, and sprites can be made to have their data anywhere in first 4MB of memory. This is accomplished by first setting the location of the sprite pointers by setting the SPRPTRADR registers (\$D06C - \$D06E, 53356 - 53358 decimal, but note that only the bottom 7 bits of \$D06E are used, as the highest bit is used for the SPRPTR16 signal). This allows the list of eight sprite pointers to be moved from the end of screen RAM to an arbitrary location in the first 8MB of RAM. To allow sprites themselves to be located anywhere in the first 4MB of RAM, the SPRPTR16 bit in \$D06E must be set. In this mode, two bytes are used to indicate the location of each sprite, instead of one. That is, the list of sprite pointers will be 16 bytes long, instead of 8 bytes long as on the VIC-II/III. When SPRPTR16 is enabled, the location of the sprite pointers should always be set explicitly via the SPRPTRADR registers. For example, to position the sprite pointers at location 800 - 815, you could use something like the following code. Note that a little gymnastics is required to keep the SPRPTR16 bit unchanged, and also to work around the AND binary operator not working with values greater than 65535:

```
REM ENABLE CG5+MEGA65 I/O
IF PEEK($D018)<32 THEN POKE $D02F,ASC("G"):POKE $D02F,ASC("S")
POKE $D06C,(800-INT(800/65536)*65536) AND 255
POKE $D06D,INT(800/256) AND 255
POKE $D06E,(PEEK($D06E) AND 128)+INT(800/65536)
```

The location of each sprite image remains a multiple of 64 bytes, thus allowing for up to 65,536 unique sprite images to be used at any point in time, if the system is equipped with sufficient RAM (4MB or more). In this mode, the VIC-II 16KB banking is ignored, and the location of sprite data is simply $64 \times$ the pointer value. For example, to have the data for a sprite at \$C000 (49152 decimal), this would be sprite location 768, because $49152 \text{ divided by } 64 = 768$. We then need to split 768 into high and low bytes, to set the two pointer bytes: $768 = 256 \times 3$, with remainder 0, so this would require the two sprite pointer bytes to be 0 (low byte, which comes first) and 3 (high byte). Thus if the sprite pointers were located at \$7F8 (2040 decimal), setting the first sprite to sprite image 768 could be done with something like:

```
POKE 2040,768-256*INT(768/256)
POKE 2041,INT(768/256)
```

HOT REGISTERS

Because of the availability of precise vernier registers to set a wide range of video parameters directly, \$D011 (53265 decimal), \$D016 (53270 decimal) and other VIC-II and VIC-III video mode registers are implemented as virtual registers: by default, writing to any of these results in computed consistent values being applied to all of the relevant vernier registers. This means that writing to any of these virtual registers will reset the video mode. Thus some care has to be taken when using new VIC-IV features to not touch any of the “hot” VIC-II and VIC-III registers.

The “hot” registers to be careful with are:

\$D011, \$D016, \$D018, \$D031 (53265, 53270, 53272 and 53297 decimal) and the VIC-II bank bits of \$DD00 (56576 decimal).

If you write to any of those, various VIC-IV registers will need to be re-written with the values you wish to maintain.

This “hot” register behaviour is intended primarily for legacy software. It can be disabled by clearing the HOTREG signal (bit 7 of \$D05D, 53341 decimal).

NEW MODES

Why the new VIC-IV modes are Character and Bitmap modes, not Bitplane modes

The new VIC-IV video modes are derived from the VIC-II character and bitmap modes, rather than the VIC-III bitplane modes. This decision was based on several realities of programming a memory-constrained 8-bit home computer:

1. Bitplanes require that the same amount of memory is given to each area on screen, regardless of whether it is showing empty space, or complex graphics. There is no way with bitplanes to reuse content from within an image in another part of the image. However, most C64 games use highly repetitive displays, with common elements appearing in various places on the screen, of which Boulder Dash and Super Giana Sisters would be good examples.
2. Bitplanes also make it difficult to update a display, because every pixel is unique, in that there is no way to make a change, for example to the animation in an

onscreen element, and have it take effect in all places at the same time. The diamond animations in Boulder Dash are a good example of this problem. The requirement to modify multiple separate bytes in each bitplane create an increased computational burden, which is why there were calls for the Amiga AAA chip-set to include so-called “chunky” modes, rather than just bitplane based modes. While the Display Address Translator (DAT) and DMAgic of the C65 provide some relief to this problem, the relief is only partial.

3. Scrolling using the C65 bitplanes requires copying the entire bitplane, as the hardware support for smooth scrolling does not extend to changing the bitplane source address in a fine manner. Even using the DMAgic to assist, scrolling a 320×200 256-colour display requires 128,000 clock cycles in the best case (reading and writing $320 \times 200 = 64000$ bytes). At 3.5MHz on the C65 this would require about 36 milli-seconds, or about 2 complete video frames. Thus for smooth scrolling of such a display, a double buffered arrangement would be required, which would consume 128,000 of the 131,072 bytes of memory.

In contrast, the well known character modes of the VIC-II are widely used in games, due to their ability to allow a small amount of screen memory to select which 8×8 block of pixels to display, allowing very rapid scrolling, reduced memory consumption, and effective hardware acceleration of animation of common elements. Thus the focus of improvements in the VIC-IV has been on character mode. As bitmap mode on the VIC-II is effectively a special case of character mode, with implied character numbers, it comes along free for the ride on the VIC-IV, and will only be mentioned in the context of a very few bitmap-mode specific improvements that were trivial to make, and it thus seemed foolish to not implement, in case they find use.

Displaying more than 256 unique characters via “Super-Extended Attribute Mode”

The primary innovation is the addition of the Super-Extended Attribute Mode. The VIC-II already uses 12 bits per character: Each 8×8 cell is defined by 12 bits of data: 8 bits of screen RAM data, by default from $\$0400 - \$07E7$ (1024 - 2023 decimal), indicating which characters to show, and 4 bits of colour data from the 1K nibble colour RAM at $\$D800 - \$DBFF$ (55296 - 56319 decimal). The VIC-III of the C65 uses 16 bits, as the colour RAM is now 8 bits, instead of 4, with the extra 4 bits of colour RAM being used to support attributes (blink, bold, underline and reverse video). It is recommended to revise how this works, before reading the following. A good

introduction to the VIC-II text mode can be found in many places. Super-Extended Attribute mode doubles the number of bits per character used from the VIC-III's 16, to 32: Two bytes of screen RAM and two bytes of colour/attribute RAM.

Super-Extended Attribute Mode is enabled by setting bit 0 in \$D054 (53332 decimal). Remember to first enable VIC-IV mode, to make this register accessible. When this bit is set, two bytes are used for each of the screen memory and colour RAM for each character shown on the display. Thus, in contrast to the 12 bits of information that the C64 uses per character, and the 16 bits that the VIC-III uses, the VIC-IV has 32 bits of information. How those 32 bits are used varies slightly among the particular modes. The default is as follows:

Bit(s)	Function
Screen RAM byte 0	Lower 8 bits of character number, the same as the VIC-II and VIC-III
Screen RAM byte 1, bits 0 - 4	Upper 5 bits of character number, allowing addressing of 8,192 unique characters
Screen RAM byte 1, bits 5 - 7	Trim pixels from right-hand side of character (bits 0 - 2) <i>or</i> Set character data Y offset if GOTOX set set (bits 0 - 2)
Colour RAM byte 0, bit 7	Vertically flip the character <i>or</i> enable transparency for subsequent characters if GOTOX is set
Colour RAM byte 0, bit 6	Horizontally flip the character
Colour RAM byte 0, bit 5	Alpha blend mode (leave 0, discussed later)
Colour RAM byte 0, bit 4	GOTO X (allows repositioning of characters along a raster via the Raster-Rewrite Buffer, discussed later), must be set to 0 for displaying characters
Colour RAM byte 0, bits 3	If set, Full-Colour characters use 4 bits per pixel and are 16 pixels wide (less any right-hand side trim bits), instead of using 8 bits per pixel. When using 8 bits per pixels, the characters are the normal 8 pixels wide
Colour RAM byte 0, bits 2	Trim pixels from right-hand side of character (bit 3) <i>or</i> Set character data Y offset if GOTOX set set (bit 3)
Colour RAM byte 0, bits 0 - 1	Number of pixels to trim from top or bottom of character
Colour RAM byte 1, bits 0 - 3	Low 4 bits of colour of character
Colour RAM byte 1, bits 4 - 7	Upper 4 bits of colour of character (if VIC-II multi-colour mode is enabled)
Colour RAM byte 1, bit 4	Hardware blink of character (if VIC-III extended attributes are enabled)

continued ...

...continued

Bit(s)	Function
Colour RAM byte 1, bit 5	Hardware reverse video enable of character (if VIC-III extended attributes are enabled)*
Colour RAM byte 1, bit 6	Hardware bold attribute of character (if VIC-III extended attributes are enabled)*
Colour RAM byte 1, bit 7	Hardware underlining of character (if VIC-III extended attributes are enabled)

* Enabling BOLD and REVERSE attributes at the same time on the MEGA65 selects an alternate palette, effectively allowing 512 colours on screen, but each 8×8 character can use colours only from one 256 colour palette.

If the GOTOX bit is set, some of the fields have different meanings:

Bit(s)	Function
Screen RAM byte 0	Lower 8 bits of new X position to start drawing the next character, relative to the start of character drawing. Setting to 0 causes the next character to be drawn over the top of the left-most character.
Screen RAM byte 1, bits 0 - 1	Upper 2 bits of new X position
Screen RAM byte 1, bits 3 - 4	RESERVED, set to 0
Screen RAM byte 1, bits 5 - 7	FCM Character data offset: Characters display normally when set to zero. When non-zero, 8 × the value is added to the character address. With careful planning, this can be used to smoothly vertically scroll multiple layers of RRB content.
Colour RAM byte 0, bit 4 - 5	RESERVED, set to 0
Colour RAM byte 0, bits 6	If set, the following characters will be rendered as background, allowing sprites to appear in front of them, even when sprites are set to background.
Colour RAM byte 0, bit 7	If set, then background/transparent pixels will not be drawn, allowing layering
Colour RAM byte 0, bit 4	GOTO X, set to 1

continued ...

...continued

Bit(s)	Function
Colour RAM byte 0, bits 3	ROWMASK. If set, then the pixel row mask is used to determine which pixel rows of the following characters should be rendered. This can be used to vertically scroll characters using the Raster-Rewrite Buffer, by drawing each character twice, once shifted down on the screen line on which it appears, and a second time, shifted up in the following screen line, and masked so that only the pixel rows belonging to the scrolled character are displayed, and not data from either before or after that character's data.
Colour RAM byte 0, bits 2	If set, the following characters will be rendered as foreground, regardless of their colouring, allowing sprites to appear behind them.
Colour RAM byte 0, bits 0 - 1	RESERVED, set to 0
Colour RAM byte 1, bits 0 - 7	Pixel row mask flags

We can see that we still have the C64 style bottom 8 bits of the character number in the first screen byte. The second byte of screen memory gets five extra bits for that, allowing $2^{13} = 8,192$ different characters to be used on a single screen. That's more than enough for unique characters covering an 80×50 screen (which is possible to create with the VIC-IV). The remaining bits allow for trimming of the character. This allows for variable width characters, which can be used to do things that would not normally be possible, such as using text mode for free horizontal placement of characters (or parts thereof). This was originally added to provide hardware support for proportional width fonts.

For the colour RAM, the second byte (byte 1) is the same as the C65, i.e., the lower half providing four bits of foreground colour, as on the C64, plus the optional VIC-III extended attributes. The C65 specifications document describes the behaviour when more than one of these are used together, most of which are logical, but there are a few combinations that behave differently than one might expect. For example, combining bold with blink causes the character to toggle between bold and normal mode. Bold mode itself is implemented by effectively acting as bit 4 of the foreground colour value, causing the colour to be drawn from different palette entries than usual.

However, if you do not need VIC-III extended attributes, you can instead use the upper four bits of the second byte of colour RAM to contain more bits for the colour index, allowing selection from the full range of 256 colour entries. This mode is activated by enabling the VIC-II's multi-colour mode while full-colour mode is active.

The C65 / VIC-III attributes and the use of 256 colour 8-bit values for various VIC-II colour registers is enabled by setting bit 5 of \$D031 (53297 decimal). Therefore this is highly recommended when using the VIC-IV mode, as otherwise certain functions will not behave as expected. Note that BOLD+REVERSE together has the meaning of selecting an alternate palette on the MEGA65, which differs from the C65.

Many effects are possible due to Super-Extended Attribute Mode. A few possibilities are explained in the following sub-sections.

Using Super-Extended Attribute Mode

Super-Extended Attribute Mode requires double the screen RAM and colour RAM as the VIC-II/III text modes. This is because two bytes of each are required to define each character, instead of one. The screen RAM can be located anywhere in the 384KB of main memory using registers \$D060 - \$D062 (53344 - 53346 decimal). The colour RAM can be located anywhere in the 32KB colour RAM. Only the first 1 or 2KB of the colour RAM is visible at \$D800 - \$DBFF or \$D800 - \$DFFF (if the *CRAM2K* signal is set in bit 0 of \$D030, 53296 decimal). Thus if using a screen larger than 40×25 characters use of the DMA controller or some other means may be required to access the full amount of colour RAM. Thus we will initially discuss using Super-Extender Attribute Mode with a 40x25 character display, so that the use of DMA or other means to access the additional colour RAM.

The first step is to enable the Super-Extended Attribute Mode by asserting the *FCLRHI* and *CHR16* signals, by setting bits 2 and 0 of \$D054 (53332 decimal). As this is a VIC-IV register, we must first enable the VIC-IV I/O mode. The VIC-IV must also be configured to 40 column mode, by clearing the *H640* signal by clearing bit 7 of \$D031 (53297 decimal). This is because each pair of characters will be used to form a single character on screen, with one character requiring two screen RAM bytes, thus 80 screen RAM bytes are required to display 40 characters. Similarly 80 colour RAM bytes are required as well.

To understand this visually, it is helpful to first consider the normal C64 screen memory layout:

\$400	\$401	\$402	\$403	\$404	\$405	\$406	\$407	\$408	\$409	\$40a	\$40b	\$40c	\$40d	\$40e	\$40f	\$410	\$411	\$412	\$413	\$414	\$415	\$416	\$417	\$418	\$419	\$41a	\$41b	\$41c	\$41d	\$41e	\$41f	\$420	\$421	\$422	\$423	\$424	\$425	\$426	\$427																																																																																																																																																																																																								
\$428	\$429	\$42a	\$42b	\$42c	\$42d	\$42e	\$42f	\$430	\$431	\$432	\$433	\$434	\$435	\$436	\$437	\$438	\$439	\$43a	\$43b	\$43c	\$43d	\$43e	\$43f	\$440	\$441	\$442	\$443	\$444	\$445	\$446	\$447	\$448	\$449	\$44a	\$44b	\$44c	\$44d	\$44e	\$44f	\$450	\$451	\$452	\$453	\$454	\$455	\$456	\$457	\$458	\$459	\$45a	\$45b	\$45c	\$45d	\$45e	\$45f	\$460	\$461	\$462	\$463	\$464	\$465	\$466	\$467	\$468	\$469	\$46a	\$46b	\$46c	\$46d	\$46e	\$46f	\$470	\$471	\$472	\$473	\$474	\$475	\$476	\$477																																																																																																																																																																
\$478	\$479	\$47a	\$47b	\$47c	\$47d	\$47e	\$47f	\$480	\$481	\$482	\$483	\$484	\$485	\$486	\$487	\$488	\$489	\$48a	\$48b	\$48c	\$48d	\$48e	\$48f	\$490	\$491	\$492	\$493	\$494	\$495	\$496	\$497	\$498	\$499	\$49a	\$49b	\$49c	\$49d	\$49e	\$49f	\$500	\$501	\$502	\$503	\$504	\$505	\$506	\$507	\$508	\$509	\$50a	\$50b	\$50c	\$50d	\$50e	\$50f	\$510	\$511	\$512	\$513	\$514	\$515	\$516	\$517																																																																																																																																																																																
\$518	\$519	\$51a	\$51b	\$51c	\$51d	\$51e	\$51f	\$520	\$521	\$522	\$523	\$524	\$525	\$526	\$527	\$528	\$529	\$52a	\$52b	\$52c	\$52d	\$52e	\$52f	\$530	\$531	\$532	\$533	\$534	\$535	\$536	\$537	\$538	\$539	\$53a	\$53b	\$53c	\$53d	\$53e	\$53f	\$540	\$541	\$542	\$543	\$544	\$545	\$546	\$547	\$548	\$549	\$54a	\$54b	\$54c	\$54d	\$54e	\$54f	\$550	\$551	\$552	\$553	\$554	\$555	\$556	\$557	\$558	\$559	\$55a	\$55b	\$55c	\$55d	\$55e	\$55f	\$560	\$561	\$562	\$563	\$564	\$565	\$566	\$567																																																																																																																																																																
\$568	\$569	\$56a	\$56b	\$56c	\$56d	\$56e	\$56f	\$570	\$571	\$572	\$573	\$574	\$575	\$576	\$577	\$578	\$579	\$57a	\$57b	\$57c	\$57d	\$57e	\$57f	\$580	\$581	\$582	\$583	\$584	\$585	\$586	\$587	\$588	\$589	\$58a	\$58b	\$58c	\$58d	\$58e	\$58f	\$590	\$591	\$592	\$593	\$594	\$595	\$596	\$597	\$598	\$599	\$59a	\$59b	\$59c	\$59d	\$59e	\$59f	\$600	\$601	\$602	\$603	\$604	\$605	\$606	\$607																																																																																																																																																																																
\$608	\$609	\$60a	\$60b	\$60c	\$60d	\$60e	\$60f	\$610	\$611	\$612	\$613	\$614	\$615	\$616	\$617	\$618	\$619	\$61a	\$61b	\$61c	\$61d	\$61e	\$61f	\$620	\$621	\$622	\$623	\$624	\$625	\$626	\$627	\$628	\$629	\$62a	\$62b	\$62c	\$62d	\$62e	\$62f	\$630	\$631	\$632	\$633	\$634	\$635	\$636	\$637	\$638	\$639	\$63a	\$63b	\$63c	\$63d	\$63e	\$63f	\$640	\$641	\$642	\$643	\$644	\$645	\$646	\$647	\$648	\$649	\$64a	\$64b	\$64c	\$64d	\$64e	\$64f	\$650	\$651	\$652	\$653	\$654	\$655	\$656	\$657																																																																																																																																																																
\$658	\$659	\$65a	\$65b	\$65c	\$65d	\$65e	\$65f	\$660	\$661	\$662	\$663	\$664	\$665	\$666	\$667	\$668	\$669	\$66a	\$66b	\$66c	\$66d	\$66e	\$66f	\$670	\$671	\$672	\$673	\$674	\$675	\$676	\$677	\$678	\$679	\$67a	\$67b	\$67c	\$67d	\$67e	\$67f	\$680	\$681	\$682	\$683	\$684	\$685	\$686	\$687	\$688	\$689	\$68a	\$68b	\$68c	\$68d	\$68e	\$68f	\$690	\$691	\$692	\$693	\$694	\$695	\$696	\$697	\$698	\$699	\$69a	\$69b	\$69c	\$69d	\$69e	\$69f	\$700	\$701	\$702	\$703	\$704	\$705	\$706	\$707	\$708	\$709	\$70a	\$70b	\$70c	\$70d	\$70e	\$70f	\$710	\$711	\$712	\$713	\$714	\$715	\$716	\$717	\$718	\$719	\$71a	\$71b	\$71c	\$71d	\$71e	\$71f	\$720	\$721	\$722	\$723	\$724	\$725	\$726	\$727	\$728	\$729	\$72a	\$72b	\$72c	\$72d	\$72e	\$72f	\$730	\$731	\$732	\$733	\$734	\$735	\$736	\$737	\$738	\$739	\$73a	\$73b	\$73c	\$73d	\$73e	\$73f	\$740	\$741	\$742	\$743	\$744	\$745	\$746	\$747	\$748	\$749	\$74a	\$74b	\$74c	\$74d	\$74e	\$74f	\$750	\$751	\$752	\$753	\$754	\$755	\$756	\$757	\$758	\$759	\$75a	\$75b	\$75c	\$75d	\$75e	\$75f	\$760	\$761	\$762	\$763	\$764	\$765	\$766	\$767	\$768	\$769	\$76a	\$76b	\$76c	\$76d	\$76e	\$76f	\$770	\$771	\$772	\$773	\$774	\$775	\$776	\$777	\$778	\$779	\$77a	\$77b	\$77c	\$77d	\$77e	\$77f	\$780	\$781	\$782	\$783	\$784	\$785	\$786	\$787	\$788	\$789	\$78a	\$78b	\$78c	\$78d	\$78e	\$78f	\$790	\$791	\$792	\$793	\$794	\$795	\$796	\$797	\$798	\$799	\$79a	\$79b	\$79c	\$79d	\$79e	\$79f	\$800	\$801	\$802	\$803	\$804	\$805	\$806	\$807
\$808	\$809	\$80a	\$80b	\$80c	\$80d	\$80e	\$80f	\$810	\$811	\$812	\$813	\$814	\$815	\$816	\$817	\$818	\$819	\$81a	\$81b	\$81c	\$81d	\$81e	\$81f	\$820	\$821	\$822	\$823	\$824	\$825	\$826	\$827	\$828	\$829	\$82a	\$82b	\$82c	\$82d	\$82e	\$82f	\$830	\$831	\$832	\$833	\$834	\$835	\$836	\$837	\$838	\$839	\$83a	\$83b	\$83c	\$83d	\$83e	\$83f	\$840	\$841	\$842	\$843	\$844	\$845	\$846	\$847	\$848	\$849	\$84a	\$84b	\$84c	\$84d	\$84e	\$84f	\$850	\$851	\$852	\$853	\$854	\$855	\$856	\$857	\$858	\$859	\$85a	\$85b	\$85c	\$85d	\$85e	\$85f	\$860	\$861	\$862	\$863	\$864	\$865	\$866	\$867	\$868	\$869	\$86a	\$86b	\$86c	\$86d	\$86e	\$86f	\$870	\$871	\$872	\$873	\$874	\$875	\$876	\$877	\$878	\$879	\$87a	\$87b	\$87c	\$87d	\$87e	\$87f	\$880	\$881	\$882	\$883	\$884	\$885	\$886	\$887	\$888	\$889	\$88a	\$88b	\$88c	\$88d	\$88e	\$88f	\$890	\$891	\$892	\$893	\$894	\$895	\$896	\$897	\$898	\$899	\$89a	\$89b	\$89c	\$89d	\$89e	\$89f	\$900	\$901	\$902	\$903	\$904	\$905	\$906	\$907																																																																																
\$908	\$909	\$90a	\$90b	\$90c	\$90d	\$90e	\$90f	\$910	\$911	\$912	\$913	\$914	\$915	\$916	\$917	\$918	\$919	\$91a	\$91b	\$91c	\$91d	\$91e	\$91f	\$920	\$921	\$922	\$923	\$924	\$925	\$926	\$927	\$928	\$929	\$92a	\$92b	\$92c	\$92d	\$92e	\$92f	\$930	\$931	\$932	\$933	\$934	\$935	\$936	\$937	\$938	\$939	\$93a	\$93b	\$93c	\$93d	\$93e	\$93f	\$940	\$941	\$942	\$943	\$944	\$945	\$946	\$947	\$948	\$949	\$94a	\$94b	\$94c	\$94d	\$94e	\$94f	\$950	\$951	\$952	\$953	\$954	\$955	\$956	\$957	\$958	\$959	\$95a	\$95b	\$95c	\$95d	\$95e	\$95f	\$960	\$961	\$962	\$963	\$964	\$965	\$966	\$967	\$968	\$969	\$96a	\$96b	\$96c	\$96d	\$96e	\$96f	\$970	\$971	\$972	\$973	\$974	\$975	\$976	\$977	\$978	\$979	\$97a	\$97b	\$97c	\$97d	\$97e	\$97f	\$980	\$981	\$982	\$983	\$984	\$985	\$986	\$987	\$988	\$989	\$98a	\$98b	\$98c	\$98d	\$98e	\$98f	\$990	\$991	\$992	\$993	\$994	\$995	\$996	\$997	\$998	\$999	\$99a	\$99b	\$99c	\$99d	\$99e	\$99f	\$1000	\$1001	\$1002	\$1003	\$1004	\$1005	\$1006	\$1007																																																																																

That is, each character cell uses one byte of screen RAM, and the addresses increase smoothly, both within lines, and between lines. Super-Extended Attribute Mode requires two bytes per character cell. So if you set \$D054 to \$05, for example, you will get screen addresses like this:

\$400	\$402	\$404	\$406	\$408	\$410	\$412	\$414	\$416	\$418	\$41a	\$41c	\$41e	\$420	\$422	\$424	\$426	\$428	\$42a	\$42c	\$42e	\$430	\$432	\$434	\$436	\$438	\$43a	\$43c	\$43e	\$440	\$442	\$444	\$446	\$448	\$44a	\$44c	\$44e	\$448	\$44a	\$44c	\$44e																									
\$450	\$452	\$454	\$456	\$458	\$45a	\$45c	\$45e	\$460	\$462	\$464	\$466	\$468	\$46a	\$46c	\$46e	\$470	\$472	\$474	\$476	\$478	\$47a	\$47c	\$47e	\$480	\$482	\$484	\$486	\$488	\$48a	\$48c	\$48e	\$490	\$492	\$494	\$496	\$498	\$49a	\$49c	\$49e																										
\$478	\$47a	\$47c	\$47e	\$480	\$482	\$484	\$486	\$488	\$48a	\$48c	\$48e	\$490	\$492	\$494	\$496	\$498	\$49a	\$49c	\$49e	\$4a0	\$4a2	\$4a4	\$4a6	\$4a8	\$4aa	\$4ac	\$4ae	\$4b0	\$4b2	\$4b4	\$4b6	\$4b8	\$4ba	\$4bc	\$4be	\$4c0	\$4c2	\$4c4	\$4c6	\$4c8	\$4ca	\$4cc	\$4ce																						
\$4a0	\$4a2	\$4a4	\$4a6	\$4a8	\$4aa	\$4ac	\$4ae	\$4b0	\$4b2	\$4b4	\$4b6	\$4b8	\$4ba	\$4bc	\$4be	\$4c0	\$4c2	\$4c4	\$4c6	\$4c8	\$4ca	\$4cc	\$4ce	\$4d0	\$4d2	\$4d4	\$4d6	\$4d8	\$4da	\$4dc	\$4de	\$4e0	\$4e2	\$4e4	\$4e6	\$4e8	\$4ea	\$4ec	\$4ee	\$4f0	\$4f2	\$4f4	\$4f6	\$4f8	\$4fa	\$4fc	\$4fe																		
\$4c8	\$4ca	\$4cc	\$4ce	\$4d0	\$4d2	\$4d4	\$4d6	\$4d8	\$4da	\$4dc	\$4de	\$4e0	\$4e2	\$4e4	\$4e6	\$4e8	\$4ea	\$4ec	\$4ee	\$4f0	\$4f2	\$4f4	\$4f6	\$4f8	\$4fa	\$4fc	\$4fe	\$500	\$502	\$504	\$506	\$508	\$50a	\$50c	\$50e	\$510	\$512	\$514	\$516	\$518	\$51a	\$51c	\$51e	\$520	\$522	\$524	\$526	\$528	\$52a	\$52c	\$52e	\$530	\$532	\$534	\$536	\$538	\$53a	\$53c	\$53e						
\$4f0	\$4f2	\$4f4	\$4f6	\$4f8	\$4fa	\$4fc	\$4fe	\$500	\$502	\$504	\$506	\$508	\$50a	\$50c	\$50e	\$510	\$512	\$514	\$516	\$518	\$51a	\$51c	\$51e	\$520	\$522	\$524	\$526	\$528	\$52a	\$52c	\$52e	\$530	\$532	\$534	\$536	\$538	\$53a	\$53c	\$53e	\$540	\$542	\$544	\$546	\$548	\$54a	\$54c	\$54e	\$550	\$552	\$554	\$556	\$558	\$55a	\$55c	\$55e	\$560	\$562	\$564	\$566	\$568	\$56a	\$56c	\$56e		
\$518	\$51a	\$51c	\$51e	\$520	\$522	\$524	\$526	\$528	\$52a	\$52c	\$52e	\$530	\$532	\$534	\$536	\$538	\$53a	\$53c	\$53e	\$540	\$542	\$544	\$546	\$548	\$54a	\$54c	\$54e	\$550	\$552	\$554	\$556	\$558	\$55a	\$55c	\$55e	\$560	\$562	\$564	\$566	\$568	\$56a	\$56c	\$56e	\$570	\$572	\$574	\$576	\$578	\$57a	\$57c	\$57e	\$580	\$582	\$584	\$586	\$588	\$58a	\$58c	\$58e						
\$568	\$56a	\$56c	\$56e	\$570	\$572	\$574	\$576	\$578	\$57a	\$57c	\$57e	\$580	\$582	\$584	\$586	\$588	\$58a	\$58c	\$58e	\$590	\$592	\$594	\$596	\$598	\$59a	\$59c	\$59e	\$5a0	\$5a2	\$5a4	\$5a6	\$5a8	\$5aa	\$5ac	\$5ae	\$5b0	\$5b2	\$5b4	\$5b6	\$5b8	\$5ba	\$5bc	\$5be	\$5c0	\$5c2	\$5c4	\$5c6	\$5c8	\$5ca	\$5cc	\$5ce	\$5d0	\$5d2	\$5d4	\$5d6	\$5d8	\$5da	\$5dc	\$5de						
\$590	\$592	\$594	\$596	\$598	\$59a	\$59c	\$59e	\$5a0	\$5a2	\$5a4	\$5a6	\$5a8	\$5aa	\$5ac	\$5ae	\$5b0	\$5b2	\$5b4	\$5b6	\$5b8	\$5ba	\$5bc	\$5be	\$5c0	\$5c2	\$5c4	\$5c6	\$5c8	\$5ca	\$5cc	\$5ce	\$5d0	\$5d2	\$5d4	\$5d6	\$5d8	\$5da	\$5dc	\$5de	\$5e0	\$5e2	\$5e4	\$5e6	\$5e8	\$5ea	\$5ec	\$5ee	\$5f0	\$5f2	\$5f4	\$5f6	\$5f8	\$5fa	\$5fc	\$5fe										
\$5b8	\$5ba	\$5bc	\$5be	\$5c0	\$5c2	\$5c4	\$5c6	\$5c8	\$5ca	\$5cc	\$5ce	\$5d0	\$5d2	\$5d4	\$5d6	\$5d8	\$5da	\$5dc	\$5de	\$5e0	\$5e2	\$5e4	\$5e6	\$5e8	\$5ea	\$5ec	\$5ee	\$5f0	\$5f2	\$5f4	\$5f6	\$5f8	\$5fa	\$5fc	\$5fe	\$600	\$602	\$604	\$606	\$608	\$60a	\$60c	\$60e	\$610	\$612	\$614	\$616	\$618	\$61a	\$61c	\$61e	\$620	\$622	\$624	\$626	\$628	\$62a	\$62c	\$62e						
\$5e0	\$5e2	\$5e4	\$5e6	\$5e8	\$5ea	\$5ec	\$5ee	\$5f0	\$5f2	\$5f4	\$5f6	\$5f8	\$5fa	\$5fc	\$5fe	\$600	\$602	\$604	\$606	\$608	\$60a	\$60c	\$60e	\$610	\$612	\$614	\$616	\$618	\$61a	\$61c	\$61e	\$620	\$622	\$624	\$626	\$628	\$62a	\$62c	\$62e	\$630	\$632	\$634	\$636	\$638	\$63a	\$63c	\$63e	\$63e	\$640	\$642	\$644	\$646	\$648	\$64a	\$64c	\$64e									
\$608	\$60a	\$60c	\$60e	\$610	\$612	\$614	\$616	\$618	\$61a	\$61c	\$61e	\$620	\$622	\$624	\$626	\$628	\$62a	\$62c	\$62e	\$630	\$632	\$634	\$636	\$638	\$63a	\$63c	\$63e	\$63e	\$640	\$642	\$644	\$646	\$648	\$64a	\$64c	\$64e	\$64e	\$650	\$652	\$654	\$656	\$658	\$65a	\$65c	\$65e	\$65e	\$660	\$662	\$664	\$666	\$668	\$66a	\$66c	\$66e	\$670	\$672	\$674	\$676	\$678	\$67a	\$67c	\$67e			
\$630	\$632	\$634	\$636	\$638	\$63a	\$63c	\$63e	\$63e	\$640	\$642	\$644	\$646	\$648	\$64a	\$64c	\$64e	\$64e	\$650	\$652	\$654	\$656	\$658	\$65a	\$65c	\$65e	\$65e	\$660	\$662	\$664	\$666	\$668	\$66a	\$66c	\$66e	\$66e	\$670	\$672	\$674	\$676	\$678	\$67a	\$67c	\$67e	\$67e	\$680	\$682	\$684	\$686	\$688	\$68a	\$68c	\$68e	\$68e	\$690	\$692	\$694	\$696	\$698	\$69a	\$69c	\$69e				
\$658	\$65a	\$65c	\$65e	\$65e	\$660	\$662	\$664	\$666	\$668	\$66a	\$66c	\$66e	\$66e	\$670	\$672	\$674	\$676	\$678	\$67a	\$67c	\$67e	\$67e	\$680	\$682	\$684	\$686	\$688	\$68a	\$68c	\$68e	\$68e	\$690	\$692	\$694	\$696	\$698	\$69a	\$69c	\$69e	\$69e	\$6a0	\$6a2	\$6a4	\$6a6	\$6a8	\$6aa	\$6ac	\$6ae	\$6b0	\$6b2	\$6b4	\$6b6	\$6b8	\$6ba	\$6bc	\$6be									
\$688	\$68a	\$68c	\$68e	\$68e	\$690	\$692	\$694	\$696	\$698	\$69a	\$69c	\$69e	\$69e	\$6a0	\$6a2	\$6a4	\$6a6	\$6a8	\$6aa	\$6ac	\$6ae	\$6b0	\$6b2	\$6b4	\$6b6	\$6b8	\$6ba	\$6bc	\$6be	\$6c0	\$6c2	\$6c4	\$6c6	\$6c8	\$6ca	\$6cc	\$6ce	\$6d0	\$6d2	\$6d4	\$6d6	\$6d8	\$6da	\$6dc	\$6de	\$6e0	\$6e2	\$6e4	\$6e6	\$6e8	\$6ea	\$6ec	\$6ee	\$6f0	\$6f2	\$6f4	\$6f6	\$6f8	\$6fa	\$6fc	\$6fe				
\$6a8	\$6aa	\$6ac	\$6ae	\$6b0	\$6b2	\$6b4	\$6b6	\$6b8	\$6ba	\$6bc	\$6be	\$6c0	\$6c2	\$6c4	\$6c6	\$6c8	\$6ca	\$6cc	\$6ce	\$6d0	\$6d2	\$6d4	\$6d6	\$6d8	\$6da	\$6dc	\$6de	\$6e0	\$6e2	\$6e4	\$6e6	\$6e8	\$6ea	\$6ec	\$6ee	\$6f0	\$6f2	\$6f4	\$6f6	\$6f8	\$6fa	\$6fc	\$6fe	\$700	\$702	\$704	\$706	\$708	\$70a	\$70c	\$70e	\$710	\$712	\$714	\$716	\$718	\$71a	\$71c	\$71e						
\$6d0	\$6d2	\$6d4	\$6d6	\$6d8	\$6da	\$6dc	\$6de	\$6e0	\$6e2	\$6e4	\$6e6	\$6e8	\$6ea	\$6ec	\$6ee	\$6f0	\$6f2	\$6f4	\$6f6	\$6f8	\$6fa	\$6fc	\$6fe	\$700	\$702	\$704	\$706	\$708	\$70a	\$70c	\$70e	\$710	\$712	\$714	\$716	\$718	\$71a	\$71c	\$71e	\$71e	\$720	\$722	\$724	\$726	\$728	\$72a	\$72c	\$72e	\$730	\$732	\$734	\$736	\$738	\$73a	\$73c	\$73e	\$740	\$742	\$744	\$746	\$748	\$74a	\$74c	\$74e	
\$6f8	\$6fa	\$6fc	\$6fe	\$700	\$702	\$704	\$706	\$708	\$70a	\$70c	\$70e	\$710	\$712	\$714	\$716	\$718	\$71a	\$71c	\$71e	\$71e	\$720	\$722	\$724	\$726	\$728	\$72a	\$72c	\$72e	\$730	\$732	\$734	\$736	\$738	\$73a	\$73c	\$73e	\$740	\$742	\$744	\$746	\$748	\$74a	\$74c	\$74e	\$750	\$752	\$754	\$756	\$758	\$75a	\$75c	\$75e	\$760	\$762	\$764	\$766	\$768	\$76a	\$76c	\$76e					
\$720	\$722	\$724	\$726	\$728	\$72a	\$72c	\$72e	\$730	\$732	\$734	\$736	\$738	\$73a	\$73c	\$73e	\$740	\$742	\$744	\$746	\$748	\$74a	\$74c	\$74e	\$750	\$752	\$754	\$756	\$758	\$75a	\$75c	\$75e	\$760	\$762	\$764	\$766	\$768	\$76a	\$76c	\$76e	\$76e	\$770	\$772	\$774	\$776	\$778	\$77a	\$77c	\$77e	\$780	\$782	\$784	\$786	\$788	\$78a	\$78c	\$78e	\$790	\$792	\$794	\$796	\$798	\$79a	\$79c	\$79e	
\$748	\$74a	\$74c	\$74e	\$750	\$752	\$754	\$756	\$758	\$75a	\$75c	\$75e	\$760	\$762	\$764	\$766	\$768	\$76a	\$76c	\$76e	\$76e	\$770	\$772	\$774	\$776	\$778	\$77a	\$77c	\$77e	\$780	\$782	\$784	\$786	\$788	\$78a	\$78c	\$78e	\$790	\$792	\$794	\$796	\$798	\$79a	\$79c	\$79e	\$79e	\$800	\$802	\$804	\$806	\$808	\$80a	\$80c	\$80e	\$810	\$812	\$814	\$816	\$818	\$81a	\$81c	\$81e				
\$770	\$772	\$774	\$776	\$778	\$77a	\$77c	\$77e	\$780	\$782	\$784	\$786	\$788	\$78a	\$78c	\$78e	\$790	\$792	\$794	\$796	\$798	\$79a	\$79c	\$79e	\$79e	\$800	\$802	\$804	\$806	\$808	\$80a	\$80c	\$80e	\$810	\$812	\$814	\$816	\$818	\$81a	\$81c	\$81e	\$81e	\$820	\$822	\$824	\$826	\$828	\$82a	\$82c	\$82e	\$830	\$832	\$834	\$836	\$838	\$83a	\$83c	\$83e	\$840	\$842	\$844	\$846	\$848	\$84a	\$84c	\$84e
\$798	\$79a	\$79c	\$79e	\$7a0	\$7a2	\$7a4	\$7a6	\$7a8	\$7aa	\$7ac	\$7ae	\$7b0	\$7b2	\$7b4	\$7b6	\$7b8	\$7ba	\$7bc	\$7be	\$7c0	\$7c2	\$7c4	\$7c6	\$7c8	\$7ca	\$7cc	\$7ce	\$7d0	\$7d2	\$7d4	\$7d6	\$7d8	\$7da	\$7dc	\$7de	\$7e0	\$7e2	\$7e4	\$7e6	\$7e8	\$7ea	\$7ec	\$7ee	\$7f0	\$7f2	\$7f4	\$7f6	\$7f8	\$7fa	\$7fc	\$7fe	\$800	\$802	\$804	\$806	\$808	\$80a	\$80c	\$80e						
\$7d0	\$7d2	\$7d4	\$7d6	\$7d8	\$7da	\$7dc	\$7de	\$7e0	\$7e2	\$7e4	\$7e6	\$7e8	\$7ea	\$7ec	\$7ee	\$7f0	\$7f2	\$7f4	\$7f6	\$7f8	\$7fa	\$7fc	\$7fe	\$800	\$802	\$804	\$806	\$808	\$80a	\$80c	\$80e	\$810	\$812	\$814	\$816	\$818	\$81a	\$81c	\$81e	\$81e	\$820	\$822	\$824	\$826	\$828	\$82a	\$82c	\$82e	\$830	\$832	\$834	\$836	\$838	\$83a	\$83c	\$83e	\$840	\$842	\$844	\$846	\$848	\$84a	\$84c	\$84e	

There are two things to notice in the above table: First, the address advances by two bytes for each character cell, because two bytes are required to define each character. Second, the start address of each screen line still only advances by 40 (\$28 in hexadecimal). This isn't what we really want, because it means that half of the previous row will get displayed again on each current row. This is fixed by setting the number of bytes to advance each screen row in \$D058 (LSB) and \$D059 (MSB). So in this case, we want to increase the number of bytes skipped each line from 40 bytes, to 80 bytes, which we can do by setting \$D058 to 80 (\$50 in hexadecimal), and \$D059 to 0. This gives us a screen layout like this:

\$A00	\$A02	\$A04	\$A06	\$A08	\$A0A	\$A0C	\$A0E	\$A10	\$A12	\$A14	\$A16	\$A18	\$A1A	\$A1C	\$A1E	\$A20	\$A22	\$A24	\$A26	\$A28	\$A2A	\$A2C	\$A2E	\$A30	\$A32	\$A34	\$A36	\$A38	\$A3A	\$A3C	\$A3E	\$A40	\$A42	\$A44	\$A46	\$A48	\$A4A	\$A4C	\$A4E	\$A50	\$A52	\$A54	\$A56	\$A58	\$A5A	\$A5C	\$A5E	\$A60	\$A62	\$A64	\$A66	\$A68	\$A6A	\$A6C	\$A6E	\$A70	\$A72	\$A74	\$A76	\$A78	\$A7A	\$A7C	\$A7E	\$A80	\$A82	\$A84	\$A86	\$A88	\$A8A	\$A8C	\$A8E	\$A90	\$A92	\$A94	\$A96	\$A98	\$A9A	\$A9C	\$A9E	\$AA0	\$AA2	\$AA4	\$AA6	\$AA8	\$AAA	\$AAC	\$AAE	\$AB0	\$AB2	\$AB4	\$AB6	\$AB8	\$ABA	\$ABC	\$ABE	\$AC0	\$AC2	\$AC4	\$AC6	\$AC8	\$ACA	\$ACC	\$ACE	\$AD0	\$AD2	\$AD4	\$AD6	\$AD8	\$ADA	\$ADC	\$ADE	\$AE0	\$AE2	\$AE4	\$AE6	\$AE8	\$AEA	\$AEC	\$AEE	\$AF0	\$AF2	\$AF4	\$AF6	\$AF8	\$AFA	\$AFC	\$AFE	\$B00	\$B02	\$B04	\$B06	\$B08	\$B0A	\$B0C	\$B0E	\$B10	\$B12	\$B14	\$B16	\$B18	\$B1A	\$B1C	\$B1E	\$B20	\$B22	\$B24	\$B26	\$B28	\$B2A	\$B2C	\$B2E	\$B30	\$B32	\$B34	\$B36	\$B38	\$B3A	\$B3C	\$B3E	\$B40	\$B42	\$B44	\$B46	\$B48	\$B4A	\$B4C	\$B4E	\$B50	\$B52	\$B54	\$B56	\$B58	\$B5A	\$B5C	\$B5E	\$B60	\$B62	\$B64	\$B66	\$B68	\$B6A	\$B6C	\$B6E	\$B70	\$B72	\$B74	\$B76	\$B78	\$B7A	\$B7C	\$B7E	\$B80	\$B82	\$B84	\$B86	\$B88	\$B8A	\$B8C	\$B8E	\$B90	\$B92	\$B94	\$B96	\$B98	\$B9A	\$B9C	\$B9E	\$BA0	\$BA2	\$BA4	\$BA6	\$BA8	\$BAA	\$BAC	\$BAE	\$BB0	\$BB2	\$BB4	\$BB6	\$BB8	\$BBA	\$BBC	\$BBE	\$BC0	\$BC2	\$BC4	\$BC6	\$BC8	\$BCA	\$BCC	\$BCE	\$BD0	\$BD2	\$BD4	\$BD6	\$BD8	\$BDA	\$BDC	\$BDE	\$BE0	\$BE2	\$BE4	\$BE6	\$BE8	\$BEA	\$BEC	\$BEE	\$BF0	\$BF2	\$BF4	\$BF6	\$BF8	\$BFA	\$BFC	\$BFE	\$C00	\$C02	\$C04	\$C06	\$C08	\$C0A	\$C0C	\$C0E	\$C10	\$C12	\$C14	\$C16	\$C18	\$C1A	\$C1C	\$C1E	\$C20	\$C22	\$C24	\$C26	\$C28	\$C2A	\$C2C	\$C2E	\$C30	\$C32	\$C34	\$C36	\$C38	\$C3A	\$C3C	\$C3E	\$C40	\$C42	\$C44	\$C46	\$C48	\$C4A	\$C4C	\$C4E	\$C50	\$C52	\$C54	\$C56	\$C58	\$C5A	\$C5C	\$C5E	\$C60	\$C62	\$C64	\$C66	\$C68	\$C6A	\$C6C	\$C6E	\$C70	\$C72	\$C74	\$C76	\$C78	\$C7A	\$C7C	\$C7E	\$C80	\$C82	\$C84	\$C86	\$C88	\$C8A	\$C8C	\$C8E	\$C90	\$C92	\$C94	\$C96	\$C98	\$C9A	\$C9C	\$C9E	\$CA0	\$CA2	\$CA4	\$CA6	\$CA8	\$CAA	\$CAC	\$CAE	\$CB0	\$CB2	\$CB4	\$CB6	\$CB8	\$CBA	\$CBC	\$CBE	\$CC0	\$CC2	\$CC4	\$CC6	\$CC8	\$CCA	\$CCC	\$CCE	\$CD0	\$CD2	\$CD4	\$CD6	\$CD8	\$CDA	\$CDC	\$CDE	\$CE0	\$CE2	\$CE4	\$CE6	\$CE8	\$CEA	\$CEC	\$CEE	\$CF0	\$CF2	\$CF4	\$CF6	\$CF8	\$CFA	\$CFC	\$CFE	\$D00	\$D02	\$D04	\$D06	\$D08	\$D0A	\$D0C	\$D0E	\$D10	\$D12	\$D14	\$D16	\$D18	\$D1A	\$D1C	\$D1E	\$D20	\$D22	\$D24	\$D26	\$D28	\$D2A	\$D2C	\$D2E	\$D30	\$D32	\$D34	\$D36	\$D38	\$D3A	\$D3C	\$D3E	\$D40	\$D42	\$D44	\$D46	\$D48	\$D4A	\$D4C	\$D4E	\$D50	\$D52	\$D54	\$D56	\$D58	\$D5A	\$D5C	\$D5E	\$D60	\$D62	\$D64	\$D66	\$D68	\$D6A	\$D6C	\$D6E	\$D70	\$D72	\$D74	\$D76	\$D78	\$D7A	\$D7C	\$D7E	\$D80	\$D82	\$D84	\$D86	\$D88	\$D8A	\$D8C	\$D8E	\$D90	\$D92	\$D94	\$D96	\$D98	\$D9A	\$D9C	\$D9E	\$DA0	\$DA2	\$DA4	\$DA6	\$DA8	\$DAA	\$DAC	\$DAE	\$DB0	\$DB2	\$DB4	\$DB6	\$DB8	\$DBA	\$DBC	\$DBE	\$DC0	\$DC2	\$DC4	\$DC6	\$DC8	\$DCA	\$DCC	\$DCE	\$DD0	\$DD2	\$DD4	\$DD6	\$DD8	\$DDA	\$DDC	\$DDE	\$DE0	\$DE2	\$DE4	\$DE6	\$DE8	\$DEA	\$DEC	\$DEE	\$DF0	\$DF2	\$DF4	\$DF6	\$DF8	\$DFA	\$DFC	\$DFE	\$E00	\$E02	\$E04	\$E06	\$E08	\$E0A	\$E0C	\$E0E	\$E10	\$E12	\$E14	\$E16	\$E18	\$E1A	\$E1C	\$E1E	\$E20	\$E22	\$E24	\$E26	\$E28	\$E2A	\$E2C	\$E2E	\$E30	\$E32	\$E34	\$E36	\$E38	\$E3A	\$E3C	\$E3E	\$E40	\$E42	\$E44	\$E46	\$E48	\$E4A	\$E4C	\$E4E	\$E50	\$E52	\$E54	\$E56	\$E58	\$E5A	\$E5C	\$E5E	\$E60	\$E62	\$E64	\$E66	\$E68	\$E6A	\$E6C	\$E6E	\$E70	\$E72	\$E74	\$E76	\$E78	\$E7A	\$E7C	\$E7E	\$E80	\$E82	\$E84	\$E86	\$E88	\$E8A	\$E8C	\$E8E	\$E90	\$E92	\$E94	\$E96	\$E98	\$E9A	\$E9C	\$E9E	\$EA0	\$EA2	\$EA4	\$EA6	\$EA8	\$EAA	\$EAC	\$EAE	\$EB0	\$EB2	\$EB4	\$EB6	\$EB8	\$EBA	\$EBC	\$EBE	\$EC0	\$EC2	\$EC4	\$EC6	\$EC8	\$ECA	\$ECC	\$ECE	\$ED0	\$ED2	\$ED4	\$ED6	\$ED8	\$EDA	\$EDC	\$EDE	\$EE0	\$EE2	\$EE4	\$EE6	\$EE8	\$EEA	\$EEC	\$EEE	\$EF0	\$EF2	\$EF4	\$EF6	\$EF8	\$EFA	\$EFC	\$EFE	\$F00	\$F02	\$F04	\$F06	\$F08	\$F0A	\$F0C	\$F0E	\$F10	\$F12	\$F14	\$F16	\$F18	\$F1A	\$F1C	\$F1E	\$F20	\$F22	\$F24	\$F26	\$F28	\$F2A	\$F2C	\$F2E	\$F30	\$F32	\$F34	\$F36	\$F38	\$F3A	\$F3C	\$F3E	\$F40	\$F42	\$F44	\$F46	\$F48	\$F4A	\$F4C	\$F4E	\$F50	\$F52	\$F54	\$F56	\$F58	\$F5A	\$F5C	\$F5E	\$F60	\$F62	\$F64	\$F66	\$F68	\$F6A	\$F6C	\$F6E	\$F70	\$F72	\$F74	\$F76	\$F78	\$F7A	\$F7C	\$F7E	\$F80	\$F82	\$F84	\$F86	\$F88	\$F8A	\$F8C	\$F8E	\$F90	\$F92	\$F94	\$F96	\$F98	\$F9A	\$F9C	\$F9E	\$FA0	\$FA2	\$FA4	\$FA6	\$FA8	\$FAA	\$FAC	\$FAE	\$FB0	\$FB2	\$FB4	\$FB6	\$FB8	\$FBA	\$FBC	\$FBE	\$FC0	\$FC2	\$FC4	\$FC6	\$FC8	\$FCA	\$FCC	\$FCE	\$FD0	\$FD2	\$FD4	\$FD6	\$FD8	\$FDA	\$FDC	\$FDE	\$FE0	\$FE2	\$FE4	\$FE6	\$FE8	\$FEA	\$FEC	\$FEE	\$FF0	\$FF2	\$FF4	\$FF6	\$FF8	\$FFA	\$FFC	\$FFE	\$000	\$002	\$004	\$006	\$008	\$00A	\$00C	\$00E	\$010	\$012	\$014	\$016	\$018	\$01A	\$01C	\$01E	\$020	\$022	\$024	\$026	\$028	\$02A	\$02C	\$02E	\$030	\$032	\$034	\$036	\$038	\$03A	\$03C	\$03E	\$040	\$042	\$044	\$046	\$048	\$04A	\$04C	\$04E	\$050	\$052	\$054	\$056	\$058	\$05A	\$05C	\$05E	\$060	\$062	\$064	\$066	\$068	\$06A	\$06C	\$06E	\$070	\$072	\$074	\$076	\$078	\$07A	\$07C	\$07E	\$080	\$082	\$084	\$086	\$088	\$08A	\$08C	\$08E	\$090	\$092	\$094	\$096	\$098	\$09A	\$09C	\$09E	\$0A0	\$0A2	\$0A4	\$0A6	\$0A8	\$0AA	\$0AC	\$0AE	\$0B0	\$0B2	\$0B4	\$0B6	\$0B8	\$0BA	\$0BC	\$0BE	\$0C0	\$0C2	\$0C4	\$0C6	\$0C8	\$0CA	\$0CC	\$0CE	\$0D0	\$0D2	\$0D4	\$0D6	\$0D8	\$0DA	\$0DC	\$0DE	\$0E0	\$0E2	\$0E4	\$0E6	\$0E8	\$0EA	\$0EC	\$0EE	\$0F0	\$0F2	\$0F4	\$0F6	\$0F8	\$0FA	\$0FC	\$0FE	\$100	\$102	\$104	\$106	\$108	\$10A	\$10C	\$10E	\$110	\$112	\$114	\$116	\$118	\$11A	\$11C	\$11E	\$120	\$122	\$124	\$126	\$128	\$12A	\$12C	\$12E	\$130	\$132	\$134	\$136	\$138	\$13A	\$13C	\$13E	\$140	\$142	\$144	\$146	\$148	\$14A	\$14C	\$14E	\$150	\$152	\$154	\$156	\$158	\$15A	\$15C	\$15E	\$160	\$162	\$164	\$166	\$168	\$16A	\$16C	\$16E	\$170	\$172	\$174	\$176	\$178	\$17A	\$17C	\$17E	\$180	\$182	\$184	\$186	\$188	\$18A	\$18C	\$18E	\$190	\$192	\$194	\$196	\$198	\$19A	\$19C	\$19E	\$1A0	\$1A2	\$1A4	\$1A6	\$1A8	\$1AA	\$1AC	\$1AE	\$1B0	\$1B2	\$1B4	\$1B6	\$1B8	\$1BA	\$1BC	\$1BE	\$1C0	\$1C2	\$1C4	\$1C6	\$1C8	\$1CA	\$1CC	\$1CE	\$1D0	\$1D2	\$1D4	\$1D6	\$1D8	\$1DA	\$1DC	\$1DE	\$1E0	\$1E2	\$1E4	\$1E6	\$1E8	\$1EA	\$1EC	\$1EE	\$1F0	\$1F2	\$1F4	\$1F6	\$1F8	\$1FA	\$1FC	\$1FE	\$200	\$202	\$204	\$206	\$208	\$20A	\$20C	\$20E	\$210	\$212	\$214	\$216	\$218	\$21A	\$21C	\$21E	\$220	\$222	\$224	\$226	\$228	\$22A	\$22C	\$22E	\$230	\$232	\$234	\$236	\$238	\$23A	\$23C	\$23E	\$240	\$242	\$244	\$246	\$248	\$24A	\$24C	\$24E	\$250	\$252	\$254	\$256	\$258	\$25A	\$25C	\$25E	\$260	\$262	\$264	\$266	\$268	\$26A	\$26C	\$26E	\$270	\$272	\$274	\$276	\$278	\$27A	\$27C	\$27E	\$280	\$282	\$284	\$286	\$288	\$28A	\$28C	\$28E	\$290	\$292	\$294	\$296	\$298	\$29A	\$29C	\$29E	\$2A0	\$2A2	\$2A4	\$2A6	\$2A8	\$2AA	\$2AC	\$2AE	\$2B0	\$2B2	\$2B4	\$2B6	\$2B8	\$2BA	\$2BC	\$2BE	\$2C0	\$2C2	\$2C4	\$2C6	\$2C8	\$2CA	\$2CC	\$2CE	\$2D0	\$2D2	\$2D4	\$2D6	\$2D8	\$2DA	\$2DC	\$2DE	\$2E0	\$2E2	\$2E4	\$2E6	\$2E8	\$2EA	\$2EC	\$2EE	\$2F0	\$2F2	\$2F4	\$2F6	\$2F8	\$2FA	\$2FC	\$2FE	\$300	\$302	\$304	\$306	\$308	\$30A	\$30C	\$30E	\$310	\$312	\$314	\$316	\$318	\$31A	\$31C	\$31E	\$320	\$322	\$324	\$326	\$328	\$32A	\$32C	\$32E	\$330	\$332	\$334	\$336	\$338	\$33A	\$33C	\$33E	\$340	\$342	\$344	\$346	\$348	\$34A	\$34C	\$34E	\$350	\$352	\$354	\$356	\$358	\$35A	\$35C	\$35E	\$360	\$362	\$364	\$366	\$368	\$36A	\$36C	\$36E	\$370	\$372	\$374	\$376	\$378	\$37A	\$37C	\$37E	\$380	\$382	\$384	\$386	\$388	\$38A	\$38C	\$38E	\$390	\$392	\$394	\$396	\$398	\$39A	\$39C	\$39E	\$3A0	\$3A2	\$3A4	\$3A6	\$3A8	\$3AA	\$3AC	\$3AE	\$3B0	\$3B2	\$3B4	\$3B6	\$3B8	\$3BA	\$3BC	\$3BE	\$3C0	\$3C2	\$3C4	\$3C6	\$3C8	\$3CA	\$3CC	\$3CE	\$3D0	\$3D2	\$3D4	\$3D6	\$3D8	\$3DA	\$3DC	\$3DE	\$3E0	\$3E2	\$3E4	\$3E6	\$3E8	\$3EA	\$3EC	\$3EE	\$3F0	\$3F2	\$3F4	\$3F6	\$3F8	\$3FA	\$3FC	\$3FE	\$400	\$402	\$404	\$406	\$408	\$40A	\$40C	\$40E	\$410	\$412	\$414	\$416	\$418	\$41A	\$41C	\$41E	\$420	\$422	\$424	\$426	\$428	\$42A	\$42C	\$42E	\$430	\$432	\$434	\$436	\$438	\$43A	\$43C	\$43E	\$440	\$442	\$444	\$446	\$448	\$44A	\$44C	\$44E	\$450	\$452	\$454	\$456	\$458	\$45A	\$45C	\$45E	\$460	\$462	\$464	\$466	\$468	\$46A	\$46C	\$46E	\$470	\$472	\$474	\$476	\$478	\$47A	\$47C	\$47E	\$480	\$482	\$484	\$486	\$488	\$48A	\$48C	\$48E	\$490	\$492	\$494	\$496	\$498	\$49A	\$49C	\$49E	\$4A0	\$4A2	\$4A4	\$4A6	\$4A8	\$4AA	\$4AC	\$4AE	\$4B0	\$4B2	\$4B4	\$4B6	\$4B8	\$4BA	\$4BC	\$4BE	\$4C0	\$4C2	\$4C4	\$4C6	\$4C8	\$4CA	\$4CC	\$4CE	\$4D0	\$4D2	\$4D4	\$4D6	\$4D8	\$4DA	\$4DC	\$4DE	\$4E0	\$4E2	\$4E4	\$4E6	\$4E8	\$4EA	\$4EC	\$4EE	\$4F0	\$4F2	\$4F4	\$4F6	\$4F8	\$4FA	\$4FC	\$4FE	\$500	\$502	\$504	\$506	\$508	\$50A	\$50C	\$50E	\$510	\$512	\$514	\$516	\$518	\$51A	\$51C	\$51E	\$520	\$522	\$524	\$526	\$528	\$52A	\$52C	\$52E	\$530	\$532	\$534	\$536	\$538	\$53A	\$53C	\$53E	\$540	\$542	\$544	\$546	\$548	\$54A	\$54C	\$54E	\$550	\$552	\$554	\$556	\$558	\$55A	\$55C	\$55E	\$560	\$562	\$564	\$566	\$568	\$56A	\$56C	\$56E	\$570	\$572	\$574	\$576	\$578	\$57A	\$57C	\$57E	\$580	\$582	\$584	\$586	\$588	\$58A	\$58C	\$58E	\$590	\$592	\$594	\$596	\$598	\$59A	\$59C	\$59E	\$5A0	\$5A2	\$5A4	\$5A6	\$5A8	\$5AA	\$5AC	\$5AE	\$5B0	\$5B2	\$5B4	\$5B6	\$5B8	\$5BA	\$5BC	\$5BE	\$5C0	\$5C2	\$5C4	\$5C6	\$5C8	\$5CA	\$5CC	\$5CE	\$5D0	\$5D2	\$5D4	\$5D6	\$5D8	\$5DA	\$5DC	\$5DE	\$5E0	\$5E2	\$5E4	\$5E6	\$5E8	\$5EA	\$5EC	\$5EE	\$5F0	\$5F2	\$5F4	\$5F6	\$5F8	\$5FA	\$5FC	\$5FE	\$600	\$602	\$604	\$606	\$608	\$60A	\$60C	\$60E	\$610	\$612	\$614	\$616	\$618	\$61A	\$61C	\$61E	\$620	\$622	\$624	\$626	\$628	\$62A	\$62C	\$62E	\$630	\$632	\$634	\$636	\$638	\$63A	\$63C	\$63E	\$640	\$642	\$644	\$646	\$648	\$64A	\$64C	\$64E	\$650	\$652	\$654	\$656	\$658	\$65A	\$65C	\$65E	\$660	\$662	\$664	\$666	\$668	\$66A	\$66C	\$66E	\$670	\$672	\$674	\$676	\$678
-------	-------	-------	-------	-------	-------	-------	-------	-------	-------	-------	-------	-------	-------	-------	-------	-------	-------	-------	-------	-------	-------	-------	-------	-------	-------	-------	-------	-------	-------	-------	-------	-------	-------	-------	-------	-------	-------	-------	-------	-------	-------	-------	-------	-------	-------	-------	-------	-------	-------	-------	-------	-------	-------	-------	-------	-------	-------	-------	-------	-------	-------	-------	-------	-------	-------	-------	-------	-------	-------	-------	-------	-------	-------	-------	-------	-------	-------	-------	-------	-------	-------	-------	-------	-------	-------	-------	-------	-------	-------	-------	-------	-------	-------	-------	-------	-------	-------	-------	-------	-------	-------	-------	-------	-------	-------	-------	-------	-------	-------	-------	-------	-------	-------	-------	-------	-------	-------	-------	-------	-------	-------	-------	-------	-------	-------	-------	-------	-------	-------	-------	-------	-------	-------	-------	-------	-------	-------	-------	-------	-------	-------	-------	-------	-------	-------	-------	-------	-------	-------	-------	-------	-------	-------	-------	-------	-------	-------	-------	-------	-------	-------	-------	-------	-------	-------	-------	-------	-------	-------	-------	-------	-------	-------	-------	-------	-------	-------	-------	-------	-------	-------	-------	-------	-------	-------	-------	-------	-------	-------	-------	-------	-------	-------	-------	-------	-------	-------	-------	-------	-------	-------	-------	-------	-------	-------	-------	-------	-------	-------	-------	-------	-------	-------	-------	-------	-------	-------	-------	-------	-------	-------	-------	-------	-------	-------	-------	-------	-------	-------	-------	-------	-------	-------	-------	-------	-------	-------	-------	-------	-------	-------	-------	-------	-------	-------	-------	-------	-------	-------	-------	-------	-------	-------	-------	-------	-------	-------	-------	-------	-------	-------	-------	-------	-------	-------	-------	-------	-------	-------	-------	-------	-------	-------	-------	-------	-------	-------	-------	-------	-------	-------	-------	-------	-------	-------	-------	-------	-------	-------	-------	-------	-------	-------	-------	-------	-------	-------	-------	-------	-------	-------	-------	-------	-------	-------	-------	-------	-------	-------	-------	-------	-------	-------	-------	-------	-------	-------	-------	-------	-------	-------	-------	-------	-------	-------	-------	-------	-------	-------	-------	-------	-------	-------	-------	-------	-------	-------	-------	-------	-------	-------	-------	-------	-------	-------	-------	-------	-------	-------	-------	-------	-------	-------	-------	-------	-------	-------	-------	-------	-------	-------	-------	-------	-------	-------	-------	-------	-------	-------	-------	-------	-------	-------	-------	-------	-------	-------	-------	-------	-------	-------	-------	-------	-------	-------	-------	-------	-------	-------	-------	-------	-------	-------	-------	-------	-------	-------	-------	-------	-------	-------	-------	-------	-------	-------	-------	-------	-------	-------	-------	-------	-------	-------	-------	-------	-------	-------	-------	-------	-------	-------	-------	-------	-------	-------	-------	-------	-------	-------	-------	-------	-------	-------	-------	-------	-------	-------	-------	-------	-------	-------	-------	-------	-------	-------	-------	-------	-------	-------	-------	-------	-------	-------	-------	-------	-------	-------	-------	-------	-------	-------	-------	-------	-------	-------	-------	-------	-------	-------	-------	-------	-------	-------	-------	-------	-------	-------	-------	-------	-------	-------	-------	-------	-------	-------	-------	-------	-------	-------	-------	-------	-------	-------	-------	-------	-------	-------	-------	-------	-------	-------	-------	-------	-------	-------	-------	-------	-------	-------	-------	-------	-------	-------	-------	-------	-------	-------	-------	-------	-------	-------	-------	-------	-------	-------	-------	-------	-------	-------	-------	-------	-------	-------	-------	-------	-------	-------	-------	-------	-------	-------	-------	-------	-------	-------	-------	-------	-------	-------	-------	-------	-------	-------	-------	-------	-------	-------	-------	-------	-------	-------	-------	-------	-------	-------	-------	-------	-------	-------	-------	-------	-------	-------	-------	-------	-------	-------	-------	-------	-------	-------	-------	-------	-------	-------	-------	-------	-------	-------	-------	-------	-------	-------	-------	-------	-------	-------	-------	-------	-------	-------	-------	-------	-------	-------	-------	-------	-------	-------	-------	-------	-------	-------	-------	-------	-------	-------	-------	-------	-------	-------	-------	-------	-------	-------	-------	-------	-------	-------	-------	-------	-------	-------	-------	-------	-------	-------	-------	-------	-------	-------	-------	-------	-------	-------	-------	-------	-------	-------	-------	-------	-------	-------	-------	-------	-------	-------	-------	-------	-------	-------	-------	-------	-------	-------	-------	-------	-------	-------	-------	-------	-------	-------	-------	-------	-------	-------	-------	-------	-------	-------	-------	-------	-------	-------	-------	-------	-------	-------	-------	-------	-------	-------	-------	-------	-------	-------	-------	-------	-------	-------	-------	-------	-------	-------	-------	-------	-------	-------	-------	-------	-------	-------	-------	-------	-------	-------	-------	-------	-------	-------	-------	-------	-------	-------	-------	-------	-------	-------	-------	-------	-------	-------	-------	-------	-------	-------	-------	-------	-------	-------	-------	-------	-------	-------	-------	-------	-------	-------	-------	-------	-------	-------	-------	-------	-------	-------	-------	-------	-------	-------	-------	-------	-------	-------	-------	-------	-------	-------	-------	-------	-------	-------	-------	-------	-------	-------	-------	-------	-------	-------	-------	-------	-------	-------	-------	-------	-------	-------	-------	-------	-------	-------	-------	-------	-------	-------	-------	-------	-------	-------	-------	-------	-------	-------	-------	-------	-------	-------	-------	-------	-------	-------	-------	-------	-------	-------	-------	-------	-------	-------	-------	-------	-------	-------	-------	-------	-------	-------	-------	-------	-------	-------	-------	-------	-------	-------	-------	-------	-------	-------	-------	-------	-------	-------	-------	-------	-------	-------	-------	-------	-------	-------	-------	-------	-------	-------	-------	-------	-------	-------	-------	-------	-------	-------	-------	-------	-------	-------	-------	-------	-------	-------	-------	-------	-------	-------	-------	-------	-------	-------	-------	-------	-------	-------	-------	-------	-------	-------	-------	-------	-------	-------	-------	-------	-------	-------	-------	-------	-------	-------	-------	-------	-------	-------	-------	-------	-------	-------	-------	-------	-------	-------	-------	-------	-------	-------	-------	-------	-------	-------	-------	-------	-------	-------	-------	-------	-------	-------	-------	-------	-------	-------	-------	-------	-------	-------	-------	-------	-------	-------	-------	-------	-------	-------	-------	-------	-------	-------	-------	-------	-------	-------	-------	-------	-------	-------	-------	-------	-------	-------	-------	-------	-------	-------	-------	-------	-------	-------	-------	-------	-------	-------	-------	-------	-------	-------	-------	-------	-------	-------	-------	-------	-------	-------	-------	-------	-------	-------	-------	-------	-------	-------	-------	-------	-------	-------	-------	-------	-------	-------	-------	-------	-------	-------	-------	-------	-------	-------	-------	-------	-------	-------	-------	-------	-------	-------	-------	-------	-------	-------	-------	-------	-------	-------	-------	-------	-------	-------	-------	-------	-------	-------	-------	-------	-------	-------	-------	-------	-------	-------	-------	-------	-------	-------	-------	-------	-------	-------	-------	-------	-------	-------	-------	-------	-------	-------	-------	-------	-------	-------	-------	-------	-------	-------	-------	-------	-------	-------	-------	-------	-------	-------	-------	-------	-------	-------	-------	-------	-------	-------	-------	-------	-------	-------	-------	-------	-------	-------	-------	-------	-------	-------	-------	-------	-------	-------	-------	-------	-------	-------	-------	-------	-------	-------	-------	-------	-------	-------	-------	-------	-------	-------	-------	-------	-------	-------	-------	-------	-------	-------	-------	-------	-------	-------	-------	-------	-------	-------	-------	-------	-------	-------	-------	-------	-------	-------	-------	-------	-------	-------	-------	-------	-------	-------	-------	-------	-------	-------	-------	-------	-------	-------	-------	-------	-------	-------	-------	-------	-------	-------	-------	-------	-------	-------	-------	-------	-------	-------	-------	-------	-------	-------	-------	-------	-------	-------	-------	-------	-------	-------	-------	-------	-------	-------	-------	-------	-------	-------	-------	-------	-------	-------	-------	-------	-------	-------	-------	-------	-------	-------	-------	-------	-------	-------	-------	-------	-------	-------	-------	-------	-------	-------	-------	-------	-------	-------	-------	-------	-------	-------	-------	-------	-------	-------	-------	-------	-------	-------	-------	-------	-------	-------	-------	-------	-------	-------	-------	-------	-------	-------	-------	-------	-------	-------	-------	-------	-------	-------	-------	-------	-------	-------	-------	-------	-------	-------	-------	-------	-------	-------	-------	-------	-------	-------	-------	-------	-------	-------	-------	-------	-------	-------	-------	-------	-------	-------	-------	-------	-------	-------	-------	-------	-------	-------	-------	-------	-------	-------	-------	-------	-------	-------	-------	-------	-------	-------	-------	-------	-------	-------	-------	-------	-------	-------	-------	-------	-------	-------	-------	-------	-------	-------	-------	-------	-------	-------	-------	-------	-------	-------	-------	-------	-------	-------	-------	-------	-------	-------	-------	-------	-------	-------	-------	-------	-------	-------	-------	-------	-------	-------	-------	-------	-------	-------	-------	-------	-------	-------	-------	-------	-------	-------	-------	-------	-------	-------	-------	-------	-------	-------	-------	-------	-------	-------	-------	-------	-------	-------	-------	-------	-------	-------	-------	-------	-------	-------	-------	-------	-------	-------	-------	-------	-------	-------	-------	-------	-------	-------	-------	-------	-------	-------	-------	-------	-------	-------	-------	-------	-------	-------	-------	-------	-------	-------	-------	-------	-------	-------	-------	-------	-------	-------	-------	-------	-------	-------	-------	-------	-------	-------	-------	-------	-------	-------	-------	-------	-------	-------	-------	-------	-------	-------	-------	-------	-------	-------	-------	-------	-------	-------	-------	-------	-------	-------	-------	-------	-------	-------	-------	-------	-------	-------	-------	-------	-------	-------	-------	-------	-------	-------	-------	-------	-------	-------	-------	-------	-------	-------	-------	-------	-------	-------	-------	-------	-------	-------	-------	-------	-------	-------	-------	-------	-------	-------	-------	-------	-------	-------	-------	-------	-------	-------	-------	-------	-------	-------	-------	-------	-------	-------	-------	-------	-------	-------	-------	-------	-------	-------	-------	-------	-------	-------	-------	-------	-------	-------	-------	-------	-------	-------	-------	-------	-------	-------	-------	-------	-------	-------	-------	-------	-------	-------	-------	-------	-------	-------	-------	-------	-------	-------	-------	-------	-------	-------	-------	-------	-------	-------	-------	-------	-------	-------	-------	-------	-------	-------	-------	-------	-------	-------	-------	-------	-------	-------	-------	-------	-------	-------	-------	-------	-------	-------	-------	-------	-------	-------	-------	-------	-------	-------	-------	-------	-------	-------	-------	-------	-------	-------	-------	-------	-------	-------	-------	-------	-------

The following descriptions assume that you have implemented one of the methods described above to set the screen and colour RAM.

Full-Colour (256 colours per character) Text Mode (FCM)

In normal VIC-II/III text mode, one byte is used for each row of pixels in a character. As a reminder for how those modes work, in hi-res mode, each pixel is either the background or foreground colour, based on the state of one bit in the byte. Multi-colour mode uses two bits to select between four possible colours, but as there are still only 8 bits to describe each row of 8 pixels, each pair of pixels has the same colour. The VIC-IV's full-colour text mode removes these limitations, and allows each pixel of a character to be chosen from the 256 colour of either the primary or alternate palette bank, without sacrificing horizontal resolution.

To do this, each character now requires 64 bytes of data. The address of the data is $64 \times$ the character number, regardless of the character set address. FCM should normally be used with Super-Extended Attribute Mode (SEAM), so that more than 256 unique characters can be address. As SEAM allows the selection of 8,192 unique characters, this allows FCM character data to be placed anywhere in the first 512KB of chip RAM (but note that most models of the MEGA65 have only 384KB of chip RAM).

Nibble-colour (16 colours per character) Text Mode (NCM)

The Nibble-Colour Mode (NCM) for text is similar to Full-Colour Text Mode, except that each byte of data describes two pixels using 4 bits each. This makes the NCM unique, because the characters will be 16 pixels wide, instead of the usual 8 pixels wide. This can be used to create colourful displays, without using as much memory as FCM, because fewer characters are required to cover the screen. Unlike the VIC-II's MCM, this mode does not result in a loss of horizontal resolution.

In NCM the lower four bits of the pixel colour comes from the upper or lower four bits of the pixel data. The upper four bits of the colour code come from the colour RAM data for the displayed character. This makes it possible to use all palette entries in NCM, although the limitation of 16 colours per character remains.

A further advantage of NCM is that it uses fewer bus cycles per pixel than FCM, because fewer character data fetches need to occur per raster line. Together with the

reduced memory requirements, this makes NCM particularly useful for creating colourful multiple layers of graphics. This allows the VIC-IV to display arcade style displays with more colours than many 16-bit computers.

XXX

Alpha-Blending / Anti-Aliasing

XXX

Flipping Characters

XXX

Variable Width Fonts

There are 4 bits that allow trimming pixels from the right edge of characters when they are displayed. This has the effect of making characters narrower. This can be useful for making more attractive text displays, where narrow characters, such as “i” take less space than wider characters, such as “m”, without having to use a bitmap display. This feature can be used to make it very efficient to display such variable-width text displays – both in terms of memory usage and processing time.

This feature can be combined with full-colour text mode, alpha blending mode and 4-bits per pixel mode to allow characters that consist of 15 levels of intensity between the background and foreground colour, and that are up to 16 pixels wide. Further, the GOTO bit can be used to implement negative kerning, so that character pairs like A and T do not have excessive white space between them when printed adjacently. The prudent use of these features can result in highly impressive text display, similar to that on modern 32-bit and 64-bit systems, but that are still efficient enough to be implemented on a relatively constrained system such as the MEGA65. The “MegaWAT!?” presentation software for the MEGA65 uses several of these features to produce its attractive anti-aliased proportional text display on slides.

XXX MEGAWat!? screenshot

XXX Example program

Raster Re-write Buffer

If the GOTO bit is set for a character in Super-Extended Attribute Mode, instead of painting a character, the position on the raster is back-tracked (or advanced forward to) the pixel position specified in the low 10 bits of the screen memory bytes. If the vertical flip bit is set, then this has the alternate meaning of preventing the background colour from being painted. This combination can be used to print text material over the top of other text material, providing a crude supplement to the 8 hardware sprites. The amount of material is limited only by the raster time of the VIC-IV. Some experimentation will be required to determine how much can be achieved in PAL and NTSC modes.

If the GOTO bit is set for a character, and the character width reduction bits are also set, they are interpreted as a Y offset to add to the character data address, but only in Full Colour Mode. Setting Y=1 causes the character data to be fetched from 8 bytes later, i.e., the first row of character data will come from the address where the second row of character data would normally be fetched. Similarly for increased values the character data will be fetched from further character rows. With careful arrangement of characters in memory, it is possible to use this feature to provide free vertical placement of soft sprites, without needing to copy the character data.

This ability to draw multiple layers of text and graphics is highly powerful. For example, it can be used to provide multiple overlapping layers of separately scrollable graphics. This gives many of the advantages of bitplane-based play-fields on other computers, such as the Amiga, but without the disadvantages of bitplanes.

A good introduction to the Raster Re-write Buffer and its uses can be found in this video:

<https://www.youtube.com/watch?v=00bm5uBeBos&feature=youtu.be>

One important aspect of the RRB, is that the VIC-IV will display only the character data to the left of, and including, the last drawn character. This means that if you use the GOTO token to overwrite multiple layers of graphics, you must either make sure that the last layer reaches to the right-hand edge of the display, or you must include a GOTO token that moves the render position to the right-hand edge of the display.

XXX Example program

SPRITES

VIC-II/III Sprite Control

The control of sprites for C64 / VIC-II/III compatibility is unchanged from the C64. The only practical differences are very minor. In particular the VIC-IV uses ring-buffer for each sprites data when rendering a raster. This means that a sprite can be displayed multiple times per raster line, thus potentially allowing for horizontal multiplexing.

Extended Sprite Image Sets

On the VIC-II and VIC-III, all sprites must draw their image data from a single 16KB region of memory at any point in time. This limits the number of different sprite images to 256, because each sprite image occupies 64 bytes. In practice, the same 16KB region must also contain either bitmap, text or bitplane data, considerably reducing the number of sprite images that can be used at the same time.

The VIC-IV removes this limitation, by allowing sprite data to be placed anywhere in memory, although still on 64-byte boundaries. This is done by setting the SPRPTR16 signal (bit 7, \$D06E, decimal 53358), which tells the VIC-IV to expect two bytes per sprite pointer instead of one. These addresses are then absolute addresses, and ignore the 16KB VIC-II bank selection logic. Thus 16 bytes are required instead of 8 bytes. The list of pointers can also be placed anywhere in memory by setting the SPRPTRADR (\$D06C - \$D06D, 53356 - 53357 decimal) and SPRPTRBNK signals (bits 0 - 6, \$D06E, 53358 decimal). This allows for sprite data to be located anywhere in the first 4MB of RAM, and the sprite pointer list to be located anywhere in the first 8MB of RAM. Note that typical installations of the VIC-IV have only 384KB of connected RAM, so these limitations are of no practical effect. However, the upper bits of the SPRPTRBNK signal should be set to zero to avoid forward-compatibility problems.

One reason for supporting more sprite images is that sprites on the VIC-IV can require more than one 64 byte image slot. For example, enabling Extra-Wide Sprite Mode means that a sprite will require $8 \times 21 = 168$ bytes, and will thus occupy four VIC-II style 64 byte sprite image slots. If variable height sprites are used, this can grow to as much as $8 \times 255 = 2,040$ bytes per sprite.

Variable Sprite Size

Sprites can be one of three widths with the VIC-IV:

1. Normal VIC-II width (24 pixels wide).
2. Extra Wide, where 64 bits (8 bytes) of data are used per raster line, instead of the VIC-II's 24. This results in sprites that are 64 pixels wide, unless Full-Colour

Sprite Mode is selected for a sprite, in which case the sprite will be $64 \text{ bits} \div 4 \text{ bits per pixel} = 16 \text{ pixels wide}$.

3. Tiled mode, where the sprite is drawn repeatedly until the end of the raster line. Tiled mode should normally only be used with Extra Wide sprite mode, as the tiling always occurs using the full 64-bit sprite data. Thus if you use tiled mode with normal 24 pixel wide mono or multi-colour sprites, the tiling will treat each 2 and $2/3$ rows of sprite data as a single row, resulting in garbled displays.

To enable a sprite to be 64 pixels (or 16 pixels if in Full-Colour Sprite Mode), set the corresponding bit for the sprite in the SPRX64EN register at (\$D057, 53335 decimal). Enabling Full Colour mode for a sprite implicitly enables extended width mode, causes these sprites to be 16 pixels wide.

Similarly, sprites can be various heights: Sprites will be either the 21 pixels high of the VIC-II, or if the corresponding bit for the sprite is enabled in the SPRHG TEN signal (\$D055, 53333 decimal), then that sprite will be the number of pixels tall that is set in the SPRHGT register (\$D056, 53334 decimal).

Variable Sprite Resolution

By default, sprites are the same resolution as on the VIC-II, i.e., each sprite pixel is two physical pixels wide and high. However, sprites can be made to use the native resolution, where sprite pixels are one physical pixel wide and/or high. This is achieved by setting the relevant bit for the sprite in the SPRENV400 (\$D076, 53366 decimal) registers to increase the vertical resolution on a sprite-by-sprite basis. The horizontal resolution for all sprites is either the normal VIC-II resolution, or if the SPR640 signal is set (bit 4 of \$D054, 53332 decimal), then sprites will have the same horizontal resolution as the physical pixels of the display.

Sprite Palette Bank

The VIC-IV has four palette banks, compared with the single palette bank of the VIC-III. The VIC-IV allows the selection of separate palette banks for bitmap/text graphics and for sprites. This makes it easy to have very colourful displays, where the sprites have different colours to the rest of the display, or to use palette animation to achieve interesting visual effects in sprites, without disturbing the palette used by other elements of the display.

The sprite palette bank is selected by setting the SPRPALSEL signal in bits 2 and 3 of the register \$D070 (53360 decimal). It is possible to set this to the same bank as the bitmap/text display, or to select a different palette bank. Palette bank selection

takes effect immediately. Don't forget that to be able to modify a palette, you have to also bank it to be the palette accessible via the palette bank registers at \$D100 - \$D3FF by setting the MAPEDPAL signal in bits 6 and 7 of \$D070.

Full-Colour Sprite Mode

In addition to monochrome and multi-colour modes, the VIC-IV supports a new full-colour sprite mode. In this mode, four bits are used to encode each sprite pixel. However, unlike multi-colour mode where pairs of bits encode pairs of pixels, in full-colour mode the pixels remain at their normal horizontal resolution. The colour zero is considered transparent. If you wish to use black in a full-colour sprite, you must configure the palette bank that is selected for sprites so that one of the 15 colours for the specific sprite encodes black.

Full-colour sprite mode is selectable for each sprite by setting the appropriate bit in the SPR16EN register (\$D06B, 53355 decimal).

To enable the eight sprites to have 15 unique colours each, the sprite colour is drawn using the palette entry corresponding to: $sprite\ number \times 16 + nibble\ value$, where *sprite number* is the number of the sprite (from 0 to 7), and *nibble value* is the value of the half-byte that contains the sprite data for the pixel. In addition, if bitplane mode is enabled for this sprite, then 128 is added to the colour value, which makes it easy to switch between two colour schemes for a given sprite by changing only one bit in the SPRBPMEN register.

Because Full-Colour Sprite Mode requires four bits per pixel, sprites will be only six pixels wide, unless Extra Wide Sprite Mode is enabled for a sprite, in which case the sprite will be 16 pixels wide. Tiled Mode also works with Full-Colour Sprite Mode, and will result in the 16 full-colour pixels of the sprite being repeated until the end of the raster line.

The following BASIC program draws a Full-Colour Sprite in either C64 or C65-mode:

```

10 PRINT CHR$(147)
20 REM C65/C64-MODE DETECT
30 IF PEEK(53272) AND 32 THEN GOTO 100
40 POKE 53295,ASC("G"):POKE 53295,ASC("S")
100 REM SETUP SPRITE
110 AD=4096 :REM $1000 SPRITE ADDR
120 TC=10 :REM TRANSPARENT COLOUR
130 SPR=PEEK(53356)+PEEK(53357)*256 :REM GET SPRITE TABLE ADDRESS
140 POKE SPR,AD/64 :REM SET SPRITE ADDRESS
150 FOR I=AD TO AD+168 :REM CLEAR SPRITE WITH TC
160 POKE I,TC+TC*16 :REM ONE BYTE = 2 PIXEL
170 NEXT
180 POKE 53287,TC :REM SET TRANSPARENT COLOUR
190 POKE 53248,100 :REM PUT SPRITE,..
200 POKE 53249,100 :REM ON SCREEN AT 100,100
210 POKE 53355,1 :REM MAKE SPRITE 0 16-COLOUR
220 POKE 53335,1 :REM MAKE SPRITE 0 USE 16X4-BITS
230 POKE 53269,1 :REM ENABLE SPRITE 0
240 GOSUB 900 :REM READ MULTI-COLOUR SPRITE
250 END

900 REM LOAD SPRITE FROM DATA
910 READ N$:IF N$="END" THEN RETURN
920 GOSUB 1000 :REM DECODE LINE
930 GOTO 910

```

```

1000 REM DECODE STRING OF NIBBLES IN N$ AT ADDRESS AD
1010 IF LEN(N$)<16 THEN BEGIN:PRINT "ILLEGAL SPR DATA!":END:BEND
1020 FOR I=1 TO 16 STEP 2
1030 N=(ASC(MID$(N$,I,1))-ASC("0")) :REM HIGH NYB
1040 IF N<0 THEN N=TC :REM , IS TRANSPARENT
1050 M=(ASC(MID$(N$,I+1,1))-ASC("0")) :REM LOW NYB
1060 IF M<0 THEN M=TC :REM , IS TRANSPARENT
1070 POKE AD,(N AND 15)*16 + (M AND 15):REM SET 2 PIXELS
1080 AD=AD+1 :REM ADVANCE AD
1090 NEXT I
1100 RETURN

```

```

1998 REM SPRITE DATA
1999 REM , = TRANSPARENT, 0-0 = COLOURS 0 TO 15
2000 DATA ".A AFF...H HCC..."
2010 DATA ".A AFF...H HCC..."
2020 DATA ".A AFF...H HCC..."
2030 DATA ".A FF...000...H HC..."
2040 DATA ".F...000000...H H..."
2050 DATA "...000000000000..."
2060 DATA "...000000000000..."
2070 DATA "...000000000000..."
2080 DATA "...000000000000..."
2090 DATA "...000000000000..."
2100 DATA "...000000000000..."
2110 DATA "...000000000000..."
2120 DATA "...000000000000..."
2130 DATA "...000000000000..."
2140 DATA "...000000000000..."
2150 DATA "...000000000000..."
2160 DATA ".I...000000...K K..."
2170 DATA ".D I...000...K K E..."
2180 DATA ".D D I...K K E E..."
2190 DATA "...D D I...K K E E..."
2200 DATA "...D D I...K K E E..."
2210 DATA "END"

```

VIC-II / C64 REGISTERS

HEX	DEC	DB7	DB6	DB5	DB4	DB3	DB2	DB1	DB0	
D000	53248	S0X								
D001	53249	S0Y								
D002	53250	S1X								
D003	53251	S1Y								
D004	53252	S2X								
D005	53253	S2Y								
D006	53254	S3X								
D007	53255	S3Y								
D008	53256	S4X								
D009	53257	S4Y								
D00A	53258	S5X								
D00B	53259	S5Y								
D00C	53260	S6X								
D00D	53261	S6Y								
D00E	53262	S7X								
D00F	53263	S7Y								
D010	53264	SXMSB								
D011	53265	RC	ECM	BMM	BLNK	RSEL	YSCL			
D012	53266	RC								
D013	53267	LPX								
D014	53268	LPY								
D015	53269	SE								
D016	53270	-	RST	MCM	CSEL	XSCL				
D017	53271	SEXY								
D018	53272	VS				CB			-	
D019	53273	-				ILP	ISSC	ISBC	RIRQ	
D01A	53274	-				MISSC		MISBC	MRIRO	
D01B	53275	BSP								
D01C	53276	SCM								
D01D	53277	SEXX								
D01E	53278	SSC								
D01F	53279	SBC								
D020	53280	-				BORDERCOL				
D021	53281	-				SCREENCOL				
D022	53282	-				MC 1				
D023	53283	-				MC2				

continued ...

...continued

HEX	DEC	DB7	DB6	DB5	DB4	DB3	DB2	DB1	DB0
D024	53284	-				MC3			
D025	53285	SPRMC0							
D026	53286	SPRMC1							
D027	53287	SPR0COL							
D028	53288	SPR1COL							
D029	53289	SPR2COL							
D02A	53290	SPR3COL							
D02B	53291	SPR4COL							
D02C	53292	SPR5COL							
D02D	53293	SPR6COL							
D02E	53294	SPR7COL							
D030	53296	-							C128FAST

- **BLNK** disable display
- **BMM** bitmap mode
- **BORDERCOL** display border colour (16 colour)
- **BSP** sprite background priority bits
- **C128FAST** 2MHz select (for C128 2MHz emulation)
- **CB** character set address location (\times 1KiB)
- **CSEL** 38/40 column select
- **ECM** extended background mode
- **ILP** light pen indicate or acknowledge
- **ISBC** sprite:bitmap collision indicate or acknowledge
- **ISSC** sprite:sprite collision indicate or acknowledge
- **LPX** Coarse horizontal beam position (was lightpen X)
- **LPY** Coarse vertical beam position (was lightpen Y)
- **MC1** multi-colour 1 (16 colour)
- **MC2** multi-colour 2 (16 colour)
- **MC3** multi-colour 3 (16 colour)
- **MCM** Multi-colour mode

- **MISBC** mask sprite:bitmap collision IRQ
- **MISSC** mask sprite:sprite collision IRQ
- **MRIRQ** mask raster IRQ
- **RC** raster compare bit 8
- **RIRQ** raster compare indicate or acknowledge
- **RSEL** 24/25 row select
- **RST** Disables video output on MAX Machine(tm) VIC-II 6566. Ignored on normal C64s and the MEGA65
- **S0X** sprite 0 horizontal position
- **S0Y** sprite 0 vertical position
- **S1X** sprite 1 horizontal position
- **S1Y** sprite 1 vertical position
- **S2X** sprite 2 horizontal position
- **S2Y** sprite 2 vertical position
- **S3X** sprite 3 horizontal position
- **S3Y** sprite 3 vertical position
- **S4X** sprite 4 horizontal position
- **S4Y** sprite 4 vertical position
- **S5X** sprite 5 horizontal position
- **S5Y** sprite 5 vertical position
- **S6X** sprite 6 horizontal position
- **S6Y** sprite 6 vertical position
- **S7X** sprite 7 horizontal position
- **S7Y** sprite 7 vertical position
- **SBC** sprite/foreground collision indicate bits
- **SCM** sprite multicolour enable bits
- **SCRENCOL** screen colour (16 colour)
- **SE** sprite enable bits
- **SEXX** sprite horizontal expansion enable bits

- **SEXY** sprite vertical expansion enable bits
- **SPR0COL** sprite 0 colour / 16-colour sprite transparency colour (lower nybl)
- **SPR1COL** sprite 1 colour / 16-colour sprite transparency colour (lower nybl)
- **SPR2COL** sprite 2 colour / 16-colour sprite transparency colour (lower nybl)
- **SPR3COL** sprite 3 colour / 16-colour sprite transparency colour (lower nybl)
- **SPR4COL** sprite 4 colour / 16-colour sprite transparency colour (lower nybl)
- **SPR5COL** sprite 5 colour / 16-colour sprite transparency colour (lower nybl)
- **SPR6COL** sprite 6 colour / 16-colour sprite transparency colour (lower nybl)
- **SPR7COL** sprite 7 colour / 16-colour sprite transparency colour (lower nybl)
- **SPRMC0** Sprite multi-colour 0
- **SPRMC1** Sprite multi-colour 1
- **SSC** sprite/sprite collision indicate bits
- **SXMSB** sprite horizontal position MSBs
- **VS** screen address (× 1KiB)
- **XSCL** horizontal smooth scroll
- **YSCL** 24/25 vertical smooth scroll

VIC-III / C65 REGISTERS

HEX	DEC	DB7	DB6	DB5	DB4	DB3	DB2	DB1	DB0
D020	53280	BORDERCOL							
D021	53281	SCREENCOL							
D022	53282	MC1							
D023	53283	MC2							
D024	53284	MC3							
D025	53285	SPRMC0							
D026	53286	SPRMC1							
D02F	53295	KEY							
D030	53296	ROME	CROM9	ROMC	ROMA	ROM8	PAL	EXTSYNC	CRAM2K
D031	53297	H640	FAST	ATTR	BPM	V400	H1280	MONO	INT
D033	53299	B0ADODD			-	B0ADEVN			-

continued ...

...continued

HEX	DEC	DB7	DB6	DB5	DB4	DB3	DB2	DB1	DB0
D034	53300		B1ADODD		-		B1ADEVN		-
D035	53301		B2ADODD		-		B2ADEVN		-
D036	53302		B3ADODD		-		B3ADEVN		-
D037	53303		B4ADODD		-		B4ADEVN		-
D038	53304		B5ADODD		-		B5ADEVN		-
D039	53305		B6ADODD		-		B6ADEVN		-
D03A	53306		B7ADODD		-		B7ADEVN		-
D03B	53307	BPCOMP							
D03C	53308	BPX							
D03D	53309	BPY							
D03E	53310	HPOS							
D03F	53311	VPOS							
D040	53312	B0PIX							
D041	53313	B1PIX							
D042	53314	B2PIX							
D043	53315	B3PIX							
D044	53316	B4PIX							
D045	53317	B5PIX							
D046	53318	B6PIX							
D047	53319	B7PIX							
D100 - D1FF	53504 - 53759	PALRED							
D200 - D2FF	53760 - 54015	PALGREEN							
D300 - D3FF	54016 - 54271	PALBLUE							

- **ATTR** Enable extended attributes and 8 bit colour entries
- **BOADEVN** - Bitplane 0 address, even lines
- **BOADODD** - Bitplane 0 address, odd lines
- **BOPIX** Display Address Translator (DAT) Bitplane 0 port
- **B1ADEVN** - Bitplane 1 address, even lines
- **B1ADODD** - Bitplane 1 address, odd lines
- **B1PIX** Display Address Translator (DAT) Bitplane 1 port
- **B2ADEVN** - Bitplane 2 address, even lines
- **B2ADODD** - Bitplane 2 address, odd lines

- **B2PIX** Display Address Translator (DAT) Bitplane 2 port
- **B3ADEVN** - Bitplane 3 address, even lines
- **B3ADODD** - Bitplane 3 address, odd lines
- **B3PIX** Display Address Translator (DAT) Bitplane 3 port
- **B4ADEVN** - Bitplane 4 address, even lines
- **B4ADODD** - Bitplane 4 address, odd lines
- **B4PIX** Display Address Translator (DAT) Bitplane 4 port
- **B5ADEVN** - Bitplane 5 address, even lines
- **B5ADODD** - Bitplane 5 address, odd lines
- **B5PIX** Display Address Translator (DAT) Bitplane 5 port
- **B6ADEVN** - Bitplane 6 address, even lines
- **B6ADODD** - Bitplane 6 address, odd lines
- **B6PIX** Display Address Translator (DAT) Bitplane 6 port
- **B7ADEVN** - Bitplane 7 address, even lines
- **B7ADODD** - Bitplane 7 address, odd lines
- **B7PIX** Display Address Translator (DAT) Bitplane 7 port
- **BORDERCOL** display border colour (256 colour)
- **BPCOMP** Complement bitplane flags
- **BPM** Bit-Plane Mode
- **BPX** Bitplane X
- **BPY** Bitplane Y
- **CRAM2K** Map 2nd KB of colour RAM \$DC00-\$DFFF
- **CROM9** Select between C64 and C65 charset.
- **EXTSYNC** Enable external video sync (genlock input)
- **FAST** Enable C65 FAST mode (~3.5MHz)
- **H1280** Enable 1280 horizontal pixels (not implemented)
- **H640** Enable C64 640 horizontal pixels / 80 column mode
- **HPOS** Bitplane X Offset

- **INT** Enable VIC-III interlaced mode
- **KEY** Write \$A5 then \$96 to enable C65/VIC-III IO registers
- **MC1** multi-colour 1 (256 colour)
- **MC2** multi-colour 2 (256 colour)
- **MC3** multi-colour 3 (256 colour)
- **MONO** Enable VIC-III MONO video output (not implemented)
- **PAL** Use PALETTE ROM or RAM entries for colours 0 - 15
- **PALBLUE** blue palette values (reversed nybl order)
- **PALGREEN** green palette values (reversed nybl order)
- **PALRED** red palette values (reversed nybl order)
- **ROM8** Map C65 ROM \$8000
- **ROMA** Map C65 ROM \$A000
- **ROMC** Map C65 ROM \$C000
- **ROME** Map C65 ROM \$E000
- **SCRENCOL** screen colour (256 colour)
- **SPRMC0** Sprite multi-colour 0 (8-bit for selection of any palette colour)
- **SPRMC1** Sprite multi-colour 1 (8-bit for selection of any palette colour)
- **V400** Enable 400 vertical pixels
- **VPOS** Bitplane Y Offset

VIC-IV / MEGA65 SPECIFIC REGISTERS

HEX	DEC	DB7	DB6	DB5	DB4	DB3	DB2	DB1	DB0
D020	53280	BORDERCOL							
D021	53281	SCRENCOL							
D022	53282	MC1							
D023	53283	MC2							
D024	53284	MC3							

continued ...

...continued

HEX	DEC	DB7	DB6	DB5	DB4	DB3	DB2	DB1	DB0
D025	53285	SPRMC0							
D026	53286	SPRMC1							
D02F	53295	KEY							
D048	53320	TBDRPOS							
D049	53321	SPRBPMEN				TBDRPOS			
D04A	53322	BBDRPOS							
D04B	53323	SPRBPMEN				BBDRPOS			
D04C	53324	TEXTXPOS							
D04D	53325	SPRTILEN				TEXTXPOS			
D04E	53326	TEXTYPOS							
D04F	53327	SPRTILEN				TEXTYPOS			
D050	53328	XPOS							
D051	53329	NORRDEL	DBLRR	XPOS					
D052	53330	FNRASTER							
D053	53331	FNRST	SHDEMU	-			FNRASTER		
D054	53332	ALPHEN	VFAST	PALEMU	SPR640	SMTH	FCLRHI	FCLRLO	CHR16
D055	53333	SPRHGTEN							
D056	53334	SPRHGT							
D057	53335	SPRX64EN							
D058	53336	LINESTEP							
D059	53337	LINESTEP							
D05A	53338	CHRXSCL							
D05B	53339	CHRYSCSCL							
D05C	53340	SIDBDRWD							
D05D	53341	HOTREG	RSTDELEN	SIDBDRWD					
D05E	53342	CHRCOUNT							
D05F	53343	SPRXSMSBS							
D060	53344	SCRNPTR							
D061	53345	SCRNPTR							
D062	53346	SCRNPTR							
D063	53347	EXGLYPH	-	CHRCOUNT			SCRNPTR		
D064	53348	COLPTR							
D065	53349	COLPTR							
D068	53352	CHARPTR							
D069	53353	CHARPTR							
D06A	53354	CHARPTR							
D06B	53355	SPR16EN							
D06C	53356	SPRPTRADR							

continued ...

...continued

HEX	DEC	DB7	DB6	DB5	DB4	DB3	DB2	DB1	DB0
D06D	53357	SPRPTRADR							
D06E	53358	SPRPTR16	SPRPTRBNK						
D06F	53359	PALNTSC	VGAHDTV	RASLINE0					
D070	53360	MAPEDPAL		BTPALSEL		SPRPALSEL		ABTPALSEL	
D071	53361	BP16ENS							
D072	53362	SPRYADJ							
D073	53363	RASTERHEIGHT				ALPHADELAY			
D074	53364	SPRENALPHA							
D075	53365	SPRALPHAVAL							
D076	53366	SPRENV400							
D077	53367	SRPYMSBS							
D078	53368	SPRYSMSBS							
D079	53369	RSTCOMP							
D07A	53370	FNRSTCMP	EXTIROQS	RESERVED		SPTR- CONT	RSTCMP		
D07B	53371	Number							
D07C	53372	DEBUGC		VSYNCP	HSYNCP	RE- SERVED	BITPBANK		

- **ABTPALSEL** VIC-IV bitmap/text palette bank (alternate palette)
- **ALPHADELAY** Alpha delay for compositor
- **ALPHEN** Alpha compositor enable
- **BBDRPOS** bottom border position
- **BITPBANK** Set which 128KB bank bitplanes
- **BORDERCOL** display border colour (256 colour)
- **BP16ENS** VIC-IV 16-colour bitplane enable flags
- **BTPALSEL** bitmap/text palette bank
- **CHARPTR** Character set precise base address (bits 0 - 7)
- **CHR16** enable 16-bit character numbers (two screen bytes per character)
- **CHRCOUNT** Number of characters to display per row (LSB)
- **CHRXSCL** Horizontal hardware scale of text mode (pixel 120ths per pixel)
- **CHRYSCS** Vertical scaling of text mode (number of physical rasters per char text row)

- **COLPTR** colour RAM base address (bits 0 - 7)
- **DBLRR** When set, the Raster Rewrite Buffer is only updated every 2nd raster line, limiting resolution to V200, but allowing more cycles for Raster-Rewrite actions.
- **DEBUGC** VIC-IV debug pixel select red(0 1), green(1 0) or blue(1 1) channel visible in \$D07D
- **EXGLYPH** source full-colour character data from expansion RAM
- **EXTIRQS** Enable additional IRQ sources, e.g., raster X position.
- **FCLRHI** enable full-colour mode for character numbers >\$FF
- **FCLRLO** enable full-colour mode for character numbers <=\$FF
- **FNRASTER** Read physical raster position
- **FNRST** Raster compare source (0=VIC-IV fine raster, 1=VIC-II raster)
- **FNRSTCMP** Raster compare is in physical rasters if set, or VIC-II raster if clear
- **HOTREG** Enable VIC-II hot registers. When enabled, touching many VIC-II registers causes the VIC-IV to recalculate display parameters, such as border positions and sizes
- **HSYNCP** hsync polarity
- **KEY** Write \$47 then \$53 to enable C65GS/VIC-IV IO registers
- **LINESTEP** number of bytes to advance between each text row (LSB)
- **MAPEDPAL** palette bank mapped at \$D100-\$D3FF
- **MC1** multi-colour 1 (256 colour)
- **MC2** multi-colour 2 (256 colour)
- **MC3** multi-colour 3 (256 colour)
- **NORRDEL** When clear, raster rewrite double buffering is used
- **Number** of text rows to display
- **PALEMU** Enable PAL CRT-like scan-line emulation
- **PALNTSC** NTSC emulation mode (max raster = 262)
- **RASLINE0** first VIC-II raster line
- **RASTERHEIGHT** physical rasters per VIC-II raster (1 to 16)
- **RESERVED**
- **RSTCMP** Raster compare value MSB

- **RSTCOMP** Raster compare value
- **RSTDELEN** Enable raster delay (delays raster counter and interrupts by one line to match output pipeline latency)
- **SCRENCOL** screen colour (256 colour)
- **SCRNPTR** screen RAM precise base address (bits 0 - 7)
- **SHDEMU** Enable simulated shadow-mask (PALEMU must also be enabled)
- **SIDBDRWD** Width of single side border
- **SMTH** video output horizontal smoothing enable
- **SPR16EN** sprite 16-colour mode enables
- **SPR640** Sprite H640 enable;
- **SPRALPHAVAL** Sprite alpha-blend value
- **SPRBP MEN** Sprite bitplane-modify-mode enables
- **SPRENALPHA** Sprite alpha-blend enable
- **SPRENV400** Sprite V400 enables
- **SPRHGHT** Sprite extended height size (sprite pixels high)
- **SPRHGTEN** sprite extended height enable (one bit per sprite)
- **SPRMC0** Sprite multi-colour 0 (8-bit for selection of any palette colour)
- **SPRMC1** Sprite multi-colour 1 (8-bit for selection of any palette colour)
- **SPRPALSEL** sprite palette bank
- **SPRPTR16** 16-bit sprite pointer mode (allows sprites to be located on any 64 byte boundary in chip RAM)
- **SPRPTRADR** sprite pointer address (bits 7 - 0)
- **SPRPTRBNK** sprite pointer address (bits 22 - 16)
- **SPRTILEN** Sprite horizontal tile enables.
- **SPRX64EN** Sprite extended width enables (8 bytes per sprite row = 64 pixels wide for normal sprites or 16 pixels wide for 16-colour sprite mode)
- **SPRXSMSBS** Sprite H640 X Super-MSBs
- **SPRYADJ** Sprite Y position adjustment
- **SPRYSMSBS** Sprite V400 Y position super MSBs

- **SPTRCONT** Continuously monitor sprite pointer, to allow changing sprite data source while a sprite is being drawn
- **SRPYMSBS** Sprite V400 Y position MSBs
- **TBDRPOS** top border position
- **TEXTXPOS** character generator horizontal position
- **TEXTYPOS** Character generator vertical position
- **VFAST** C65GS FAST mode (48MHz)
- **VGAHDTV** Select more VGA-compatible mode if set, instead of HDMI/HDTV VIC-II cycle-exact frame timing. May help to produce a functional display on older VGA monitors.
- **VSYNCP** vsync polarity
- **XPOS** Read horizontal raster scan position LSB

APPENDIX

N

6526 Complex Interface Adaptor (CIA) Registers

- **CIA 6526 Registers**
- **CIA 6526 Hypervisor Registers**

CIA 6526 REGISTERS

HEX	DEC	DB7	DB6	DB5	DB4	DB3	DB2	DB1	DB0	
DC00	56320	PORTA								
DC01	56321	PORTB								
DC02	56322	DDRA								
DC03	56323	DDRB								
DC04	56324	TIMERA								
DC05	56325	TIMERA								
DC06	56326	TIMERB								
DC07	56327	TIMERB								
DC08	56328	-				TODJIF				
DC09	56329	-		TODSEC						
DC0A	56330	-		TODSEC						
DC0B	56331	TO-DAMPM	-			TODHOUR				
DC0C	56332	SDR								
DC0D	56333	IR	-		FLG	SP	ALRM	TB	TA	
DC0E	56334	TOD50	SPMOD	IMODA	-	RMODA	OMODA	PBONA	STRTA	
DC0F	56335	-	IMODB		LOAD	RMODB	OMODB	PBONB	STRTB	

- **ALRM** TOD alarm
- **DDRA** Port A DDR
- **DDRB** Port B DDR
- **FLG** FLAG edge detected
- **IMODA** Timer A Timer A tick source
- **IMODB** Timer B Timer A tick source
- **IR** Interrupt flag
- **LOAD** Strobe input to force-load timers
- **OMODA** Timer A toggle or pulse
- **OMODB** Timer B toggle or pulse
- **PBONA** Timer A PB6 out
- **PBONB** Timer B PB7 out
- **PORTA** Port A

- **PORTB** Port B
- **RMODA** Timer A one-shot mode
- **RMODB** Timer B one-shot mode
- **SDR** shift register data register(writing starts sending)
- **SP** shift register full/empty
- **SPMOD** Serial port direction
- **STRTA** Timer A start
- **STRTB** Timer B start
- **TA** Timer A underflow
- **TB** Timer B underflow
- **TIMERA** Timer A counter (16 bit)
- **TIMERB** Timer B counter (16 bit)
- **TOD50** 50/60Hz select for TOD clock
- **TODAMPM** TOD PM flag
- **TODHOUR** TOD hours
- **TODJIF** TOD tenths of seconds
- **TODSEC** TOD seconds

HEX	DEC	DB7	DB6	DB5	DB4	DB3	DB2	DB1	DB0	
DC0F	56335	TOEDIT	-							
DD00	56576	PORTA								
DD01	56577	PORTB								
DD02	56578	DDRA								
DD03	56579	DDRB								
DD04	56580	TIMERA								
DD05	56581	TIMERA								
DD06	56582	TIMERB								
DD07	56583	TIMERB								
DD08	56584	-				TODJIF				
DD09	56585	-	TODSEC							
DD0A	56586	-	TODSEC							
DD0B	56587	TO-DAMPM	-			TODHOUR				

continued ...

...continued

HEX	DEC	DB7	DB6	DB5	DB4	DB3	DB2	DB1	DB0
DD0C	56588	SDR							
DD0D	56589	-			FLG	SP	ALRM	TB	TA
DD0E	56590	TOD50	SPMOD	IMODA	-	RMODA	OMODA	PBONA	STRTA
DD0F	56591	TOEDIT	IMODB		LOAD	RMOdB	OMODB	PBONB	STRTB

- **ALRM** TOD alarm
- **DDRA** Port A DDR
- **DDRB** Port B DDR
- **FLG** FLAG edge detected
- **IMODA** Timer A Timer A tick source
- **IMODB** Timer B Timer A tick source
- **LOAD** Strobe input to force-load timers
- **OMODA** Timer A toggle or pulse
- **OMODB** Timer B toggle or pulse
- **PBONA** Timer A PB6 out
- **PBONB** Timer B PB7 out
- **PORTA** Port A
- **PORTB** Port B
- **RMODA** Timer A one-shot mode
- **RMOdB** Timer B one-shot mode
- **SDR** shift register data register(writing starts sending)
- **SP** shift register full/empty
- **SPMOD** Serial port direction
- **STRTA** Timer A start
- **STRTB** Timer B start
- **TA** Timer A underflow
- **TB** Timer B underflow
- **TIMERA** Timer A counter (16 bit)
- **TIMERB** Timer B counter (16 bit)

- **TOD50** 50/60Hz select for TOD clock
- **TODAMPM** TOD PM flag
- **TOEDIT** TOD alarm edit
- **TODHOUR** TOD hours
- **TODJIF** TOD tenths of seconds
- **TODSEC** TOD seconds

CIA 6526 HYPERVISOR REGISTERS

In addition to the standard CIA registers available on the C64 and C65, the MEGA65 provides an additional set of registers that are visible only when the system is in Hypervisor Mode. These additional registers allow the internal state of the CIA to be more fully extracted when freezing, thus allowing more programs to function correctly after being frozen. They are not visible when using the MEGA65 normally, and can be safely ignored by programmers who are not programming the MEGA65 in Hypervisor Mode.

HEX	DEC	DB7	DB6	DB5	DB4	DB3	DB2	DB1	DB0
DC10	56336	TALATCH							
DC11	56337	TALATCH							
DC12	56338	TALATCH							
DC13	56339	TALATCH							
DC14	56340	TALATCH							
DC15	56341	TALATCH							
DC16	56342	TALATCH							
DC17	56343	TALATCH							
DC18	56344	IMFLG	IMSP	IMALRM	IMTB	TODJIF			
DC19	56345	TODSEC							
DC1A	56346	TODMIN							
DC1B	56347	TO-DAMPM	TODHOUR						
DC1C	56348	ALRMJIF							
DC1D	56349	ALRMSEC							
DC1E	56350	ALRMMIN							
DC1F	56351	ALR-MAMPM	ALRMHOUR						

- **ALRMAMPM** TOD Alarm AM/PM flag
- **ALRMHOUR** TOD Alarm hours value

- **ALRMJIF** TOD Alarm 10ths of seconds value
- **ALRMMIN** TOD Alarm minutes value
- **ALRMSEC** TOD Alarm seconds value
- **IMALRM** Interrupt mask for TOD alarm
- **IMFLG** Interrupt mask for FLAG line
- **IMSP** Interrupt mask for shift register (serial port)
- **IMTB** Interrupt mask for Timer B
- **TALATCH** Timer A latch value (16 bit)
- **TODAMPM** TOD AM/PM flag
- **TODHOUR** TOD hours value
- **TODJIF** TOD 10ths of seconds value
- **TODMIN** TOD Alarm minutes value
- **TODSEC** TOD Alarm seconds value

HEX	DEC	DB7	DB6	DB5	DB4	DB3	DB2	DB1	DB0
DD10	56592	TALATCH							
DD11	56593	TALATCH							
DD12	56594	TALATCH							
DD13	56595	TALATCH							
DD14	56596	TALATCH							
DD15	56597	TALATCH							
DD16	56598	TALATCH							
DD17	56599	TALATCH							
DD18	56600	IMFLG	IMSP	IMALRM	IMTB	TODJIF			
DD19	56601	TODSEC							
DD1A	56602	TODMIN							
DD1B	56603	TO-DAMPM	TODHOUR						
DD1C	56604	DD00DELAY	ALRMJIF						
DD1D	56605	ALRMSEC							
DD1E	56606	ALRMMIN							
DD1F	56607	ALR-MAMPM	ALRMHOUR						

- **ALRMAMPM** TOD Alarm AM/PM flag

- **ALRMHOUR** TOD Alarm hours value
- **ALRMJIF** TOD Alarm 10ths of seconds value
- **ALRMMIN** TOD Alarm minutes value
- **ALRMSEC** TOD Alarm seconds value
- **DD00DELAY** Enable delaying writes to \$DD00 by 3 cycles to match real 6502 timing
- **IMALRM** Interrupt mask for TOD alarm
- **IMFLG** Interrupt mask for FLAG line
- **IMSP** Interrupt mask for shift register (serial port)
- **IMTB** Interrupt mask for Timer B
- **TALATCH** Timer A latch value (16 bit)
- **TODAMPM** TOD AM/PM flag
- **TODHOUR** TOD hours value
- **TODJIF** TOD 10ths of seconds value
- **TODMIN** TOD Alarm minutes value
- **TODSEC** TOD Alarm seconds value

APPENDIX



4551 UART, GPIO and Utility Controller

- **C65 6551 UART Registers**
- **4551 General Purpose I/O & Miscellaneous Interface Registers**

C65 6551 UART REGISTERS

HEX	DEC	DB7	DB6	DB5	DB4	DB3	DB2	DB1	DB0
D600	54784	DATA							
D601	54785	-				FRMERR	PTYERR	RXOVR-RUN	RXRDY
D602	54786	TXEN	RXEN	SYNCMOD		CHARSZ		PTYEN	PTYEVEN
D603	54787	DIVISOR							
D604	54788	DIVISOR							
D605	54789	IMTXIRQ	IMRXIRQ	IMTXNMI	IMRXNMI	-			
D606	54790	IFTXIRQ	IFRXIRQ	IFTXNMI	IFRXNMI	-			

- **CHARSZ** UART character size: 00=8, 01=7, 10=6, 11=5 bits per byte
- **DATA** UART data register (read or write)
- **DIVISOR** UART baud rate divisor (16 bit). Baud rate = 7.09375MHz / DIVISOR, unless MEGA65 fast UART mode is enabled, in which case baud rate = 80MHz / DIVISOR
- **FRMERR** UART RX framing error flag (clear by reading \$D600)
- **IFRXIRQ** UART interrupt flag: IRQ on RX (not yet implemented on the MEGA65)
- **IFRXNMI** UART interrupt flag: NMI on RX (not yet implemented on the MEGA65)
- **IFTXIRQ** UART interrupt flag: IRQ on TX (not yet implemented on the MEGA65)
- **IFTXNMI** UART interrupt flag: NMI on TX (not yet implemented on the MEGA65)
- **IMRXIRQ** UART interrupt mask: IRQ on RX (not yet implemented on the MEGA65)
- **IMRXNMI** UART interrupt mask: NMI on RX (not yet implemented on the MEGA65)
- **IMTXIRQ** UART interrupt mask: IRQ on TX (not yet implemented on the MEGA65)
- **IMTXNMI** UART interrupt mask: NMI on TX (not yet implemented on the MEGA65)
- **PTYEN** UART Parity enable: 1=enabled
- **PTYERR** UART RX parity error flag (clear by reading \$D600)
- **PTYEVEN** UART Parity: 1=even, 0=odd
- **RXEN** UART enable receive
- **RXOVRUN** UART RX overrun flag (clear by reading \$D600)
- **RXRDY** UART RX byte ready flag (clear by reading \$D600)

- **SYNCMOD** UART synchronisation mode flags (00=RX & TX both async, 01=RX sync, TX async, 1x=TX sync, RX async (unused on the MEGA65))
- **TXEN** UART enable transmit

4551 GENERAL PURPOSE I/O & MISCELLANEOUS INTERFACE REGISTERS

HEX	DEC	DB7	DB6	DB5	DB4	DB3	DB2	DB1	DB0
D609	54793	-							UFAST
D60B	54795	OSKZEN	OSKZON	PORTF					
D60C	54796	PORTFDDR		PORTFDDR					
D60D	54797	HDSCL	HDSDA	SDBSH	SDCS	SDCLK	SDDATA	RST41	CONN41
D60E	54798	BASHDDR							
D60F	54799	AC-CESSKEY	OSKDIM	REALHW	-			KEYUP	KEYLEFT
D610	54800	ASCIIKEY							
D611	54801	-	MCAPS	MSCRL	MALT	MMEGA	MCTRL	MLSHFT	MRSHFT
D612	54802	LJOYB	LJOYA	JOYSWAP	OSKDE-BUG	-			
D615	54805	OSKEN	VIRTKEY1						
D616	54806	OSKALT	VIRTKEY2						
D617	54807	OSKTOP	VIRTKEY3						
D618	54808	KSCNRATE							
D619	54809	UNUSED							
D61A	54810	SYSCTL							
D61D	54813	Keyboard	Keyboard						
D61E	54814	Keyboard							
D620	54816	POTAX							
D621	54817	POTAY							
D622	54818	POTBX							
D623	54819	POTBY							
D625	54821	J21L							
D626	54822	J21H							
D627	54823	J21LDDR							
D628	54824	J21HDDR							

continued ...

...continued

HEX	DEC	DB7	DB6	DB5	DB4	DB3	DB2	DB1	DB0
D629	54825	M65MODEL							

- **ACCESSKEY** Enable accessible keyboard input via joystick port 2 fire button
- **ASCIKEY** Last key press as ASCII (hardware accelerated keyboard scanner). Write to clear event ready for next.
- **BASHDDR** Data Direction Register (DDR) for \$D60D bit bashing port.
- **CONN41** Internal 1541 drive connect (1=connect internal 1541 drive to IEC bus)
- **HDSCL** HDMI I2C control interface SCL clock
- **HSDA** HDMI I2C control interface SDA data line
- **J21H** J21 pins 11 - 14 input/output values
- **J21HDDR** J21 pins 11 - 14 data direction register
- **J21L** J21 pins 1 - 6, 9 - 10 input/output values
- **J21LDDR** J21 pins 1 - 6, 9 - 10 data direction register
- **JOYSWAP** Exchange joystick ports 1 & 2
- **KEYLEFT** Directly read C65 Cursor left key
- **KEYUP** Directly read C65 Cursor up key
- **KSCNRATE** Physical keyboard scan rate (\$00=50MHz, \$FF=~200KHz)
- **Keyboard** LED control enable
- **LJOYA** Rotate inputs of joystick A by 180 degrees (for left handed use)
- **LJOYB** Rotate inputs of joystick B by 180 degrees (for left handed use)
- **M65MODEL** MEGA65 model ID. Can be used to determine the model of MEGA65 a programme is running on, e.g., to enable touch controls on MEGA-phone.
- **MALT** ALT key state (hardware accelerated keyboard scanner).
- **MCAPS** CAPS LOCK key state (hardware accelerated keyboard scanner).
- **MCTRL** CTRL key state (hardware accelerated keyboard scanner).
- **MLSHFT** Left shift key state (hardware accelerated keyboard scanner).
- **MMEGA** MEGA/C= key state (hardware accelerated keyboard scanner).

- **MRSHT** Right shift key state (hardware accelerated keyboard scanner).
- **MSCRL** NOSCRL key state (hardware accelerated keyboard scanner).
- **OSKALT** Display alternate on-screen keyboard layout (typically dial pad for MEGA65 telephone)
- **OSKDEBUG** Debug OSK overlay (WRITE ONLY)
- **OSKDIM** Light or heavy dimming of background material behind on-screen keyboard
- **OSKEN** Enable display of on-screen keyboard composited overlay
- **OSKTOP** 1=Display on-screen keyboard at top, 0=Display on-screen keyboard at bottom of screen.
- **OSKZEN** Display hardware zoom of region under first touch point for on-screen keyboard
- **OSKZON** Display hardware zoom of region under first touch point always
- **PORTF** PMOD port A on FPGA board (data) (Nexys4 boards only)
- **PORTFDDR** PMOD port A on FPGA board (DDR)
- **POTAX** Read Port A paddle X, without having to fiddle with SID/CIA settings.
- **POTAY** Read Port A paddle Y, without having to fiddle with SID/CIA settings.
- **POTBX** Read Port B paddle X, without having to fiddle with SID/CIA settings.
- **POTBY** Read Port B paddle Y, without having to fiddle with SID/CIA settings.
- **REALHW** Set to 1 if the MEGA65 is running on real hardware, set to 0 if emulated (Xemu) or simulated (ghdl)
- **RST41** Internal 1541 drive reset (1=reset, 0=operate)
- **SDBSH** Enable SD card bitbash mode
- **SDCLK** SD card SCLK
- **SDCS** SD card CS_BO
- **SDDATA** SD card MOSI/MISO
- **SYSCTL** System control flags (target specific)
- **UFAST** C65 UART BAUD clock source: 1 = 7.09375MHz, 0 = 80MHz (VIC-IV pixel clock)
- **UNUSED** port o output value

- **VIRTKEY1** Set to \$7F for no key down, else specify virtual key press.
- **VIRTKEY2** Set to \$7F for no key down, else specify 2nd virtual key press.
- **VIRTKEY3** Set to \$7F for no key down, else specify 3rd virtual key press.

APPENDIX **P**

45E100 Fast Ethernet Controller

- **Overview**
- **Memory Mapped Registers**
- **Example Programs**

OVERVIEW

The 45E100 is a new and simple Fast Ethernet controller that has been designed specially for the MEGA65 and for 8-bit computers generally. In addition to supporting 100Mbit Fast Ethernet, it is radically different from other Ethernet controllers, such as the RR-NET.

The 45E100 includes four receive buffers, allowing upto three frames to be received while another is being processed, or to allow less frequent processing of interrupts. These receive buffers can be memory mapped, and also directly accessed using the MEGA65's DMA controller. Together with automatic CRC32 checking on reception, and automatic CRC32 generation for transmit, these features considerably reduce the burden on the processor, and make it much simpler to write ethernet-enabled programs.

The 45E100 also supports true full-duplex operation at 100Mbit per second, allowing for total bi-directional throughput exceeding 100Mbit per second. The MAC address is software configurable, and promiscuous mode is supported, as are individual control of the reception of broadcast and multi-cast Ethernet frames.

The 45E100 also supports both transmit and receive interrupts, allowing greatly improved real-world performance. When especially low latency is required, it is also possible to immediately abort the transmission of the current Ethernet frame, so that a higher-priority frame can be immediately sent. These features combine to enable sub-millisecond round trip latencies, which can be of particular value for interactive applications, such as multi-player network games.

Differences to the RR-NET and similar solutions

The RR-NET and other Ethernet controllers for the Commodore™ line of 8-bit home computers generally use an Ethernet controller that was designed for 16-bit PCs, but that also supports a so-called "8-bit mode," which suffers from a number of disadvantages. These disadvantages include the lack of working interrupts, as well as processor intensive access to the Ethernet frame buffers. The lack of interrupts forces programs to use polling to check for the arrival of new Ethernet frames. This, together with the complexities of accessing the buffers results in an Ethernet interface that is very slow, and whose real-world throughput is considerably less than its theoretical 10Mbits per second. Even a Commodore 64 with REU cannot achieve speeds above several tens of kilobytes per second.

In contrast, the 45E100 supports both RX (Ethernet frame received) interrupts and TX (ready to transmit) interrupts, freeing the processor from having to poll the device. Because the 45E100 supports RX interrupts, there is no need for large numbers of receive buffers, which is why the 45E100 requires only two RX buffers to achieve very high levels of performance.

Further, the 45E100 supports direct memory mapping of the Ethernet frame buffers, allowing for much more efficient access, including by DMA. Using the MEGA65's integrated DMA controller it is quite possible to achieve transfer rates of several megabytes per second – some 100x faster than the RR-NET.

Theory of Operation: Receiving Frames

The 45E100 is simple to operate: To begin receiving Ethernet frames, the programmer needs only to clear the RST and TXRST bits (bit 0 of register \$D6E0) to ensure that the Ethernet controller is reset, and then set these bits to 1, to release the controller from the reset state. It will then auto-negotiate connection at the highest available speed, typically 100Mbit, full-duplex.

If you wish to simply poll for the arrival of ethernet frames, check the RXQ bit (bit 5 of \$D6E1). If it is set, then there is at least one frame that has been received. To access the next frame that has been received, write \$01 to \$D6E1, and then \$03 to \$D6E1. This will rotate the ring of receive buffers, to make the next received frame accessible by the processor. The receive buffer that was previously accessible by the processor is marked free, and the 45E100 will use it to receive another ethernet frame when required.

Because the 45E100 has four receive buffers, it is possible that to process multiple frames in succession by following this procedure. If all receive buffers contain received frames, and the processor has not accepted them, then the RXBLKD signal will be asserted, so that the processor knows that if any more frames are received, they will be lost. Programmers should take care to avoid this situation. As the 45E100 supports receive interrupts, this is generally easy to manage – but don't underestimate how often ethernet frames can arrive on a 100mbit Fast Ethernet connection: If a sender sends a continuous stream of minimum-length ethernet frames, they can arrive every 6 microseconds or so! While, it is unlikely that you will have to deal with such a high rate of packet reception, you should anticipate the need to process packets at least every milli-second. In particular, a once-per-frame CIA or raster IRQ may cause some packets to be lost, more than three arrive in a 16 – 20 ms video frame. The RXBLKD signal can be used to determine if this situation is likely to have occurred. But

note that it indicates only when all receive buffers are occupied, not if any further frames arrived while there were no free receive buffers.

The receive buffers are 2KB bytes each, and can each hold only one received ethernet frame at a time. This is different to some ethernet controllers that use their total receive buffer memory as a simple ring buffer. The reason for this is to keep the mechanism for programmers as simple as possible. By having the fixed buffers, it means that the controller can memory map the received ethernet frames in exactly the same location each time, making it possible to write much simpler receiver programs, because the location of the received ethernet frames can be assumed to be constant.

The structure of a receive buffer containing an ethernet frame is quite simple: The first two bytes indicate the length of the received frame. The frame then follows immediately. The effective Maximum Transport Unit (MTU) length is 2,042 bytes, as the last four bytes are occupied by the CRC32 checksum of the received ethernet frame. The layout of the receive buffers is thus as follows:

HEX	DEC	Length	Description
0000	0	1	The low byte of the length of the received ethernet frame.
0001	1	1	The lower four bits contain the upper bits of the length of the received ethernet frame. Bit 4 is set if the received ethernet frame is a multi-cast frame. Bit 5 if it is a broadcast frame. Bit 6 is set if the frame's destination address matches the 45E100's programmed MAC address. Bit 7 is set if the CRC32 check for the received frame failed, i.e., that the frame is either truncated or was corrupted in transit.
0002 - 07FB	2 - 2,043	2,042	The received frame. Frames shorter than 2,042 bytes will begin at offset 2.
07FC - 07FF	2,044 - 2,047	4	Reserved space for holding the CRC32 code during reception. The CRC32 code is, however, always located directly after the received frame, and thus will only occupy this space if the received frame is more than 2,038 bytes long. "

Because of the very rapid rate at which Fast Ethernet frames can be received, a programmer should use the receive interrupt feature, enabled by setting RXQEN (bit 7 of \$D6E1). Polling is possible as an alternative, but is not recommended with the 45E100, because at the 100Mbit Fast Ethernet speed, packets can arrive as often

as every 5 microseconds. Fortunately, at the MEGA65's 40MHz full speed mode, and using the 20MB per second DMA copy functionality, it is possible to keep up with such high data rates.

Accessing the Ethernet Frame Buffers

Unlike on the RR-NET, the 45E100's ethernet frame buffers are able to be memory mapped, allowing rapid access via DMA or through assembly language programs. It is also possible to access the buffers from BASIC with some care.

The frame buffers can either be accessed from their natural location in the MEGA65's extended address space at address \$FFDE800 - \$FFDEFFF, or they can be mapped into the normal C64/C65 \$D000 I/O address space. Care must be taken as mapping the ethernet frame buffers into the \$D000 I/O address space causes all other I/O devices to unavailable during this time. Therefore CIA-based interrupts MUST be disabled before doing so, whether using BASIC or machine code. Therefore when programming in assembly language or machine code, it is recommended to use the natural location, and to access this memory area using one of the three mechanisms for accessing extended address space, which are described in Chapter/Appendix G on page G-11.

The method of disabling interrupts differs depending on the context in which a program is being written. For programs being written using C64-mode's BASIC 2, the following will work:

```
POKE56333,127: REM DISABLE CIA TIMER IRQS
```

While for MEGA65's BASIC 65, the following must instead be used, because a VIC-III raster interrupt is used instead of a CIA-based timer interrupt:

```
POKE53274,0: REM DISABLE VIC-II/III/IV RASTER IRQS
```

Once this has been done, the I/O context for the ethernet controller can be activated by writing \$45 (69 in decimal, equal to the character 'E' in PETSCII) and \$54 (84 in decimal, equal to the character 'T' in PETSCII) into the VIC-IV's KEY register (\$D02F, 53295 in decimal), for example:

```
POKE53295,ASC("E"):POKE53295,ASC("T")
```

At this point, the ethernet RX buffer can be read beginning at location \$D000 (53248 in decimal), and the TX buffer can be written to at the same address. Refer to 'Theory of Operation: Receiving Frames' above for further explanation on this.

Once you have finished accessing the ethernet frame buffer, you can restore the normal C64, C65 or MEGA65 I/O context by writing to the VIC-III/IV's KEY register. In most cases, it will make the most sense to revert to the MEGA65's I/O context by writing \$47 (71 decimal) in and \$53 (83 in decimal) to the KEY register, for example:

```
POKE53295 , ASC("G"): POKE53295 , ASC("S")
```

Finally, you should then re-enable interrupts, which will again depend on whether you are programming from C64 or C65-mode. For C64-mode:

```
POKE56333 , 129
```

For C65-mode it would be:

```
POKE53274 , 129
```

Theory of Operation: Sending Frames

Sending frames is similarly simple: The program must simply load the frame to be transmitted into the transmit buffer, write its length into TXSZLSB and TXSZMSB registers, and then write \$01 into the COMMAND register. The frame will then begin to transmit, as soon as the transmitter is idle. There is no need to calculate and attach an ethernet CRC32 field, as the 45E100 does this automatically.

Unlike for the receiver, there is only one frame buffer for the transmitter (this may be changed in a future revision). This means that you cannot prepare the next frame until the previous frame has already been sent. This slightly reduces the maximum data throughput, in return for a very simple architecture.

Also, note that the transmit buffer is write-only from the processor bus interface. This means that you cannot directly read the contents of the transmit buffer, but must load values "blind". Finally, the 45E100 allows you to send ethernet.

Advanced Features

In addition to operating as a simple and efficient ethernet frame transceiver, the 45E100 includes a number of advanced features, described here.

Broadcast and Multicast Traffic and Promiscuous Mode

The 45E100 supports filtering based on the destination Ethernet address, i.e., MAC address. By default, only frames where the destination Ethernet address matches the ethernet address programmed into the MACADDR1 - MACADDR6 registers will be received. However, if the MCST bit is set, then multicast ethernet frames will also be received. Similarly, setting the BCST bit will allow all broadcast frames, i.e., with MAC address ff:ff:ff:ff:ff:ff, to be received. Finally, if the NOPROM bit is cleared, the 45E100 disables the filter entirely, and will receive all valid ethernet frames.

Debugging and Diagnosis Features

The 45E100 also supports several features to assist in the diagnosis of ethernet problems. First, if the NOCRC bit is set, then even ethernet frames that have invalid CRC32 values will be received. This can help debug faulty ethernet devices on a network.

If the STRM bit is set, the ethernet transmitter transmits a continuous stream of debugging frames supplied via a special high-bandwidth logging interface. By default, the 45E100 emits a stream of approximately 2,200 byte ethernet frames that contain compressed video provided by a VIC-IV or compatible video controller that supports the MEGA65 video-over-ethernet interface. By writing a custom decoder for this stream of ethernet frames, it is possible to create a remote display of the MEGA65 via ethernet. Such a remote display can be used, for example, to facilitate digital capture of the display of a MEGA65.

The size and content of the debugging frames can be controlled by writing special values to the COMMAND register. Writing \$F1 allows the selection of frames that are 1,200 bytes long. While this reduces the performance of the debugging and streaming features, it allows the reception of these frames on systems whose ethernet controllers cannot be configured to receive frames of 2,200 bytes.

If the STRM bit is set and bit 2 of \$D6E1 is also set, a compressed log of instructions executed by the 45gs02 CPU will instead be streamed, if a compatible processor is connected to this interface. This mechanism includes back-pressure, and will cause the 45gs02 processor to slowdown, so that the instruction data can be emitted. This typically limits the speed of the connected 45gs02 processor to around 5MHz, depending on the particular instruction mix.

Note also that the status of bit 2 of \$D6E1 cannot currently be read directly. This may be corrected in a future revision.

Finally, if the video streaming functionality is enabled, this also enables reception of synthetic keyboard events via ethernet. These are delivered to the MEGA65's Keyboard Complex Interface Adapter (KCIA), allowing full remote interaction with a MEGA65 via its ethernet interface. This feature is primarily intended for development.

MEMORY MAPPED REGISTERS

The 45E100 Fast Ethernet controller is a MEGA65-specific feature. It is therefore only available in the MEGA65 I/O context. This is enabled by writing \$53 and then \$47 to VIC-IV register \$D02F. If programming in BASIC, this can be done with:

```
POKE53295,ASC("G"):POKE53295,ASC("S")
```

The 45E100 Fast Ethernet controller has the following registers

HEX	DEC	DB7	DB6	DB5	DB4	DB3	DB2	DB1	DB0
D6E0	55008	TXIDLE	RXBLKD	-	KEYEN	DRXDV	DRXD	TXRST	RST
D6E1	55009	RXQEN	TXQEN	RXQ	TXQ	STRM	RXBF		-
D6E2	55010	TXSZLSB							
D6E3	55011	TXSZMSB							
D6E4	55012	COMMAND							
D6E5	55013	-	MCST	BCST	RXPB		NOCRC	NOPROM	
D6E6	55014	MIIMPHY			MIIMREG				
D6E7	55015	MIIMVLSB							
D6E8	55016	MIIMVMSB							
D6E9	55017	MACADDR1							
D6EA	55018	MACADDR2							
D6EB	55019	MACADDR3							
D6EC	55020	MACADDR4							
D6ED	55021	MACADDR5							
D6EE	55022	MACADDR6							

- **BCST** Accept broadcast frames
- **COMMAND** Ethernet command register (write only)
- **DRXD** Read ethernet RX bits currently on the wire
- **DRXDV** Read ethernet RX data valid (debug)
- **KEYEN** Allow remote keyboard input via magic ethernet frames
- **MACADDR1** Ethernet MAC address

- **MACADDR2** Ethernet MAC address
- **MACADDR3** Ethernet MAC address
- **MACADDR4** Ethernet MAC address
- **MACADDR5** Ethernet MAC address
- **MACADDR6** Ethernet MAC address
- **MCST** Accept multicast frames
- **MIIMPHY** Ethernet MIIM PHY number (use 0 for Nexys4, 1 for MEGA65 r1 PCBs)
- **MIIMREG** Ethernet MIIM register number
- **MIIMVLSB** Ethernet MIIM register value (LSB)
- **MIIMVMSB** Ethernet MIIM register value (MSB)
- **NOCRC** Disable CRC check for received packets
- **NOPROM** Ethernet disable promiscuous mode
- **RST** Write 0 to hold ethernet controller under reset
- **RXBF** Number of free receive buffers
- **RXBLKD** Indicate if ethernet RX is blocked until RX buffers freed
- **RXPH** Ethernet RX clock phase adjust
- **RXQ** Ethernet RX IRQ status
- **RXQEN** Enable ethernet RX IRQ
- **STRM** Enable streaming of CPU instruction stream or VIC-IV display on ethernet
- **TXIDLE** Ethernet transmit side is idle, i.e., a packet can be sent.
- **TXPH** Ethernet TX clock phase adjust
- **TXQ** Ethernet TX IRQ status
- **TXQEN** Enable ethernet TX IRQ
- **TXRST** Write 0 to hold ethernet controller transmit sub-system under reset
- **TXSZLSB** TX Packet size (low byte)
- **TXSZMSB** TX Packet size (high byte)

COMMAND register values

The following values can be written to the COMMAND register to perform the described functions. In normal operation only the STARTTX command is required, for example, by performing the following **POKE**:

```
POKE55012,1
```

HEX	DEC	Signal	Description
00	0	STOPTX	Immediately stop transmitting the current ethernet frame. Will cause a partially sent frame to be received, most likely resulting in the loss of that frame.
01	1	STARTTX	Transmit packet
D0	208	RXNORMAL	Disable the effects of RXONLYONE
D4	212	DEBUGVIC	Select VIC-IV debug stream via ethernet when \$D6E1.3 is set
DC	220	DEBUGCPU	Select CPU debug stream via ethernet when \$D6E1.3 is set
DE	222	RXONLYONE	Receive exactly one ethernet frame only, and keep all signals states (for debugging ethernet sub-system)
F1	241	FRAME1K	Select 1KiB frames for video/cpu debug stream frames (for receivers that do not support MTUs of greater than 2KiB)
F2	242	FRAME2K	Select 2KiB frames for video/cpu debug stream frames, for optimal performance.

EXAMPLE PROGRAMS

Example programs for the ethernet controller exist in imperfect for in the MEGA65 Core repository on github in the src/tests and src/examples directories.

If you wish to use the ethernet controller for TCP/IP traffic, you may wish to examine the port of WeeIP to the MEGA65 at <https://github.com/mega65/mega65-weeip>. The code that controls the ethernet controller is located in eth.c.

APPENDIX



45IO27 Multi-Function I/O Controller

- **Overview**
- **F011-compatible Floppy Controller**
- **SD card Controller and F011 Virtuali-
sation Functions**
- **Touch Panel Interface**
- **Audio Support Functions**
- **Miscellaneous I/O Functions**

OVERVIEW

The 45IO27 is a multi-purpose I/O controller that incorporates the functions of the C65's F011 floppy controller, together with the MEGA65's SD card controller interface, and a number of other miscellaneous I/O functions.

Each of these major functions is covered in a separate section of this chapter.

F011-COMPATIBLE FLOPPY CONTROLLER

The MEGA65 computer is one of the very few modern computers that still includes first-class support for magnetic floppy drives. It includes a floppy controller that is backwards compatible with the C65's F011D floppy drive controller.

However, unlike the F011D, the MEGA65's floppy disk controller supports HD and ED media, and similar to the 1541 floppy drive, it also supports variable data rates, so that a determined user could develop disk formats that store more data, include robust copy protection schemes, or both.

GCR encoding is not currently supported, but may be supported by a future revision of the controller. It may also be possible with some creativity and effort to use the debug register interface to read double-density GCR formatted media. This is because there are debug registers that can be queried to indicate the gap between each successive magnetic domain – which is sufficient to decode any disk format.

Multiple Drive Support

Like the C65's F011 floppy drive controller, the 45IO27 supports up to 8 drives. The first two of those drives, drive 0 and drive 1, are assumed to be connected to a standard 34-pin floppy cable, the same as used in standard PCs, i.e., with a twist in the cable to allow the use of two unjumped drives.

As is described in later sections, it is possible to switch drive 0 and drive 1's position, without having to change cabling. Similarly, either or both of the first two drives may reference a real floppy drive, a D81 disk image stored on an attached SD card, or redirected to the floppy drive virtualisation service, so that the sector accesses can be handled by a connected computer, e.g., as part of a comfortable and efficient cross-development environment.

The remaining six drives are supported only in conjunction with a future C1565-compatible external drive port.

Buffered Sector Operations

The 45IO27 support two main modes of reading sectors from a disk: byte-by-byte, and via a memory-mapped sector buffer.

The byte-by-byte mechanism consists of having a loop wait for the DRQ signal to be asserted, and then reading the byte of data from the DATA register (\$D087).

The memory-mapped sector buffer method consists of waiting for the BUSY flag to clear, indicating that the entire sector has been read, and then directly accessing the sector buffer located at \$FFD6C00 - \$FFD6DFF. Care should be taken to ensure that the BUFSEL signal (bit 7 of \$D689) is cleared, so that the floppy sector buffer is visible, rather than the SD card sector buffer for programs other than the Hypervisor. This is because only the Hypervisor has access to the full 4KB SD controller buffer space: Normal programs see either the floppy sector buffer or the SD card sector buffer repeated 8 times between \$FFD6000 and \$FFD6FFF.

Alternatively, the sector buffer can be mapped at \$DE00 - \$DFFF, i.e., in the 4KB I/O area, by writing the \$81 to the SD command register at \$D680. This will hide any I/O peripherals that are otherwise using this area, e.g., from cartridges, or REU emulation. This function can be disabled again by writing \$82 to the SD command register. As with the normal sector buffer memory mapping at \$FFD6xxx, the BUFSEL signal (bit 7 of \$D689) affects whether the FDC or the SD card sector buffer is visible, for software not running in Hypervisor mode. Note that if you use the Matrix Mode / serial monitor interface to inspect the contents of the sector buffer, that this occurs in the Hypervisor context, and so the BUFSEL signal will be ignored, and the full 4KB buffer will be visible.

The memory-mapped sector buffer has the advantage that it can be accessed via DMA, allowing for very efficient copies. Also, it allows for loading a sector to occur in the background, while your program gets on with more interesting things in the meantime.

Reading Sectors from a Disk

There are several steps that you must follow in order to successfully read a sector from a disk. If you follow these instructions, your code will work with both physical disks, as well as D81 disk images that exist on the SD card:

- First, enable the motor and select the appropriate drive. The F011 supports upto 8 physical drives, although it is rare for more than two to be physically

connected. To enable the motor, write \$60 to \$D080. You should then write a SPINUP command (\$20) to \$D081, and wait for the BUSY flag (bit 7 of \$D082) to clear. The drive is now spinning at speed, and ready to service requests.

- Next, select the correct side of the disk by either setting or clearing the SIDE 1 flag (bit 3 of \$D080). This takes effect immediately.
- Third, use the step-in and step-out commands (writing \$10 and \$18 to \$D081) as required to move the head to the correct track. Again, after each command, you should wait for the BUSY flag (bit 7 of \$D082) to clear, before issuing the next command.

Note that you can check if the head is at track 0 by checking the TRACK0 flag, but there is no fool-proof way to know if you are on any other specific track. You can use the registers at \$D6A3 - \$D6A5 to see the track, sector and side value from the last sector header which passed under the head to make an informed guess as to which track is currently selected. Note that this only works for real disks, as disk images do not spin under the read head. Also note that it is possible for tracks to contain sectors which purposely or accidentally have incorrect track numbers in the sector headers.

- Fourth, you need to load the desired track, sector and side number into the TRACK, SECTOR and SIDE registers (\$D084, \$D085 and \$D086, respectively). The FDC is now primed ready to read a sector.
- Fifth, you should write an appropriate read command value into \$D081. This will normally be \$40 (64). You then wait for the RDREQ signal (\$D083, bit 7) to go high, to indicate that the sector has been found. You then either wait for each occasion when DRQ goes high, and read byte-by-byte in such a loop, or wait for the BUSY flag to clear and the DRQ and EQ flags to go high, which indicates that the complete sector has been read into the buffer.

Track Auto-Tune Function Deprecated

The 451027 also includes a track “auto-tune” function, which is enabled by clearing bit 7 of \$D696. That function reads the sector headers to determine which track the head is currently over, and steps the head in or out to try to get to the correct track. Auto-tune is enabled by default.

Sector Skew and Target Any Mode

It is also worth noting that the TARGANY signal can be asserted to tell the floppy controller to simply read the next sector that passes under the head. This applies only

when using real floppy disks, where it offers the considerable advantage of letting you read the sectors in the order in which they exist on the disk. This allows you to read a track at once, without having to wait for the index hole to pass by, or having to know which sector will next pass under the head.

For example, the C65 DOS formats disks using a skew factor of 7, while PCs may use a different skew-factor. If you don't know the skew factor of the disk, you may schedule the reading of the sectors on the track in a sub-optimal order. This can result in transfer rates as low as 5 sectors per second, compared with the optimal case of 50 sectors per second. Thus with either correct sector order, or using the target any mode, it is possible to read approximately two full tracks per second, i.e., two sides \times two tracks, or approximately 20KB/second on DD disks, or double that on HD disks, at around 40KB/second. This compares very favourably with the C65 DOS loading speed, which is typically nearer 1KB/sec in C64-mode.

Disk Layout and 1581 Logical Sectors

The 1581 disk format is unusual in that the physical sectors on the disk are a different size of the size of the data blocks that it presents to the user. Specifically, the disks use 512 byte sectors, while the 1581 (and C65) DOS present 256 byte data blocks. Two blocks are stored in each physical sector. Also, the physical track numbers are from 0 to 79, while the logical track numbers of the DOS are 1 to 80. Physical sectors are also numbered from 1 to 10, while logical block numbers begin are 0 to 39.

This means that if you want to find a 1581 logical sector, you need to know which physical sector it will be found in. To determine the physical sector that contains a block, you first subtract one from the track number, and then divide the sector number by two. Logical sectors 0 to 19 of each track are located in physical sectors 1 to 10 on the first side of the disk. Logical sectors 20 to 39 are located in physical sectors 1 to 10 on the reverse side of the disk.

Thus we can map a some logical track and sector t,s to the physical track, side and sector as follows:

$$track = t - 1$$

$$sector = (s/2) + 1, \text{ IF } s < 20, \text{ ELSE } = ((s - 20)/2) + 1$$

$$side = 0 \text{ IF } sector < 20$$

It is also worth noting that the 451027 is capable of reading from tracks beyond track 80, provided that the disk drive is capable of this. Almost all 3.5 inch floppy drives are capable of reading at least one extra track, as historically manufacturers of floppy disks stored information about the disk on the 81st track. In our experience almost all drives will also be able to access an 82nd track.

FD2000 Disks

The CMD™FD2000™high-density 3.5" disk drives for Commodore™computers use an unusual disk layout that is quite different from PCs: They use 10 sectors, the same as on 720KB double-density (DD) disks, but double the *sector size* from 512 bytes to 1,024 bytes. The 45IO27 does not currently support these larger sectors. At least read-only support is planned to be added via a core update in the future.

However, the 45IO27 *does* already support high-density disks and drives, with much higher capacities than the FD2000 was able to support.

High-Density and Variable-Density Disks

The 45IO27 supports variable data rates, allowing the use of HD drives and media, with a flexible approach to disk formats to support user experimentation, and the easy manipulation of high-capacity software distribution formats.

You are really only limited by your imagination, available time, and the limited number of people who are still interested in inserting a floppy disk into their computer!

The standard high-density (HD) disk format is "1.44MB", using 18 sectors per track over 80 tracks. This results in $80 \text{ tracks} \times 18 \text{ sectors} \times 2 \text{ sides} = 2,880 \text{ sectors}$. As each sector is 512 bytes, this corresponds to 1,440KB. This leads us into the interesting wonderland of "floppy disk marketing megabytes," a phenomena which long predates SD card and hard drive manufacturers using 1,000,000 byte megabytes.

Curiously for floppy disks, the 1,024,000 byte "megabyte" was used, i.e., "1MB" = $1\text{KB} \times 1\text{KB}$, that is a strange hybrid of binary and decimal conventions. Perhaps it was because the previous standard was 720KB, and they thought people would thing it odd if double 720KB was 1.41MB, and complain about the missing kilo-bytes. We will continue to use the $1,024\text{KB} = 1,000\text{KB}$ floppy disk marketing mega-byte for consistency with this historical inconsistency.

However, HD floppy disks are fundamentally capable of holding much more than 1.44MB. For example, the FD2000 stored 1.6MB by using double-sized sectors to squeeze the equivalent of 20 sectors per track, and the Amiga went further by using track-at-once writing to fit 22 sectors per track. Both these formats used a constant data rate over all tracks, and thus a constant number of sectors per track.

However, the circumference of the tracks on a 3.5" floppy disk vary quite a lot: The inner track has a diameter of around 2.5cm, while the outside track is $1.6\times$ longer. The 1.44MB disk format is designed so that the data is reliably stored on those shorter

inner tracks. This means that we should be able to fit 160% more data on the outer-most track compared with the inner-most track, subject to a number of terms and conditions imposed by The Laws of Physics, the design of floppy drive electronics, the quality of media being used and various other annoying things. Because of this variability and uncertainty, the MEGA65's floppy controller supports fully variable data rate on a track-by-track basis.

Track Information Blocks

To support variable data rates, the 45GS27 supports the use of *Track Information Blocks* (TIBs) that contain information on the data rate and encoding used on the track. This allows users to experiment with various densities on various tracks, and yet have the disks function automatically for buffered sector operations.

The Track Information Block is automatically created when using the automatic track format function, but must be manually created if using unbuffered formatting. The TIB itself consists of the following data:

1. $3 \times \$A1$ Sync bytes (written with clock byte $\$FB$)
2. $\$65$ MEGA65 Track Information Block marker (written with clock byte $\$FF$, as are all following bytes in the block)
3. The track number
4. The data rate divisor, in the same format as $\$D6A2$, i.e., data rate = $40.5\text{MHz} / \text{value}$.
5. Track encoding information: Bit 7 = Track-at-once flag, 1 = no inter-sector gaps (Amiga style), 0 = with inter-sector gaps (normal), Bit 6 = data encoding, 0 = MFM, 1=RLL2,7. Other bits are reserved, and should be 0 when written.
6. Sector count, i.e., number of sectors on the track.
7. CRC byte 1, using the normal floppy disk CRC algorithm.
8. CRC byte 2, using the normal floppy disk CRC algorithm.

The Track Information Block is always written at the data rate for a 720KB Double-Density disk, so that they can be present on any disk. Writing the Track Information Block and start-of-track gaps at the DD data rate also ensures that at very high data rates, the head still has sufficient time to switch to write mode, thus avoiding one of the many problems that arise when writing data at very high data rates.

If formatting disks unbuffered, it is the programmer's responsibility to switch the data rate after having written the Track Information Block, and several more bytes to allow

the floppy encoding pipeline to flush out the last byte of the Track Information Block. This is all automatically managed if using the automatic track formatting function.

The inclusion of the TIB allows users to play and explore the possibilities of different data rates on different drives and media, while still being automatically readable in all MEGA65s, because the TIB allows the controller to switch to the correct data rate and encoding. It is likely that over time somewhat standardised formats will develop, quite likely in the range of 2MB to 3.5MB – thus approaching the capacity of ED media in ED drives, without the need for those drives or media.

Formatting Disks

Formatting disks is now possible with the 45IO27, either unbuffered or fully-automatic. To format a track issue one of the following commands to \$D08 1:

- \$A0 – Automatic format, with inter-sector gaps, and write pre-compensation disabled.
- \$A1 – Manual format, write-precompensation disabled.
- \$A4 – Automatic format, with inter-sector gaps, and write pre-compensation enable.
- \$A5 – Manual format, write-precompensation enabled.
- \$A8 – Automatic format, Amiga-style track-at-once, and write pre-compensation disabled.
- \$AC – Automatic format, Amiga-style track-at-once, and write pre-compensation enable.

Manual formatting is not recommended, unless mastering track-at-once formatted disks for software distribution, because of the relative complexity of doing so. Also, at the higher data rates, bytes have to be delivered to the floppy controller as often as every 20 cycles, which requires considerable care when writing the format routine. For more information on manual formatting tracks, refer to the C64 Specifications Manual or the C65 ROM DOS source code, for examples of manual formatting.

The automatic modes, in contrast, format a track with a single command, and are thus much easier to use, and are recommended for general use. Write pre-compensation should normally be enabled, as it is required at higher data rates, and does not cause problems at lower data rates.

Write Pre-Compensation

Write pre-compensation is a family of algorithms used when writing high data-rate signals to floppy disks. It is used to anticipate and cancel out the predictable component of timing variation of magnetic recording. There are a variety of sources of this timing variation, which have been the subject of PhD theses, and a lot of proprietary research by hard drive manufacturers. What is important for us to understand is that adjacent pulses (really magnetic inversions) get pushed together, if they are surrounded by longer pulses, or tend to spread apart if surrounded by shorter pulses.

There are also other fascinatingly complex and difficult to predict factors, that cause things such as the “negative shift of mid-length pulses”, “inverse F-distribution of pulse arrival times” and goodness knows what else. But we shall leave those to the hard drive manufacturers. We limit ourselves to the data pattern induced effect described in the previous paragraph.

The 45GS27 supports two tunable coefficients for small and large corrections to this, which are used with an internal look-up table. However, this is all automatically handled if you enable write pre-compensation. This allows data rates that much more closely approach the expected limit of HD media, although due to the other horrors of magnetic media recording alluded to above, the actual limit is not reached.

Buffered Sector Writing

The 45IO27 can write to disk images that are located on the SD card, or when using virtualised disk access.

To write a sector, you follow a similar process to reading, except that you write \$84 to the command byte instead of \$40. The \$80 indicates a write, and the \$04 activates write-precompensation. This is important when writing to real floppy disks, especially HD and ED disks. Write-precompensation causes bits to be written slightly early or slightly late, using an algorithm that models how the magnetic domains on a disk tend to move after being written.

If you do not wish to use the sector buffer, but instead provide each byte one at a time during the write operation, you must add \$01 to the command code. However, this is not recommended on the MEGA65, because when writing to the SD card or using virtualised disk images the entire sector operation can happen instantaneously from the perspective of your program. This means that it is not possible to supply data reliably when in this mode. Thus apart from being less convenient, it is also less reliable.

Once a write operation has been triggered, the DRQ signal indicates when you should provide the next byte if performing a byte-by-byte write. Otherwise, it is assumed

that you will have pre-filled the sector buffer with the complete 512 bytes of data required.

To write to disks that contain Track Information Blocks, you should first wait for the TIB to be read when changing tracks. This is done by waiting for \$D6A9 (sectors per track from the TIB) to contain a non-zero value.

F011 Floppy Controller Registers

The following are the set of F011 compatibility registers of the 45IO47. Note that registers related to the use of SD card based storage are found in the corresponding section below.

HEX	DEC	DB7	DB6	DB5	DB4	DB3	DB2	DB1	DB0
D080	53376	IRQ	LED	MOTOR	SWAP	SIDE	DS		
D081	53377	WRCMD	RDCMD	FREE	STEP	DIR	ALGO	ALT	NOBUF
D082	53378	BUSY	DRQ	EQ	RNF	CRC	LOST	PROT	TK0
D083	53379	RDREQ	WTREQ	RUN	WGATE	DISKIN	INDEX	IRQ	DSKCHG
D084	53380	TRACK							
D085	53381	SECTOR							
D086	53382	SIDE							
D087	53383	DATA							
D088	53384	CLOCK							
D089	53385	STEP							
D08A	53386	PCODE							

- **ALGO** Selects reading and writing algorithm (currently ignored).
- **ALT** Selects alternate DPLL read recovery method (not implemented)
- **BUSY** F011 FDC busy flag (command is being executed) (read only)
- **CLOCK** Set or read the clock pattern to be used when writing address and data marks. Should normally be left \$FF
- **COMMAND** F011 FDC command register
- **CRC** F011 FDC CRC check failure flag (read only)
- **DATA** F011 FDC data register (read/write) for accessing the floppy controller's 512 byte sector buffer
- **DIR** Sets the stepping direction (inward vs
- **DISKIN** F011 Disk sense (read only)

- **DRQ** F011 FDC DRQ flag (one or more bytes of data are ready) (read only)
- **DS** Drive select (0 to 7). Internal drive is 0. Second floppy drive on internal cable is 1. Other values reserved for C1565 external drive interface.
- **DSKCHG** F011 disk change sense (read only)
- **EQ** F011 FDC CPU and disk pointers to sector buffer are equal, indicating that the sector buffer is either full or empty. (read only)
- **FREE** Command is a free-format (low level) operation
- **INDEX** F011 Index hole sense (read only)
- **IRQ** The floppy controller has generated an interrupt (read only). Note that interrupts are not currently implemented on the 45GS27.
- **LED** Drive LED blinks when set
- **LOST** F011 LOST flag (data was lost during transfer, i.e., CPU did not read data fast enough) (read only)
- **MOTOR** Activates drive motor and LED (unless LED signal is also set, causing the drive LED to blink)
- **NOBUF** Reset the sector buffer read/write pointers
- **PCODE** (Read only) returns the protection code of the most recently read sector. Was intended for rudimentary copy protection. Not implemented.
- **PROT** F011 Disk write protect flag (read only)
- **RDCMD** Command is a read operation if set
- **RDREQ** F011 Read Request flag, i.e., the requested sector was found during a read operation (read only)
- **RNF** F011 FDC Request Not Found (RNF), i.e., a sector read or write operation did not find the requested sector (read only)
- **RUN** F011 Successive match. A synonym of RDREQ on the 45IO47 (read only)
- **SECTOR** F011 FDC sector selection register
- **SIDE** Directly controls the SIDE signal to the floppy drive, i.e., selecting which side of the media is active.
- **STEP** Writing 1 causes the head to step in the indicated direction
- **SWAP** Swap upper and lower halves of data buffer (i.e. invert bit 8 of the sector buffer)
- **TKO** F011 Head is over track 0 flag (read only)

- **TRACK** F011 FDC track selection register
- **WGATE** F011 write gate flag. Indicates that the drive is currently writing to media. Bad things may happen if a write transaction is aborted (read only)
- **WRCMD** Command is a write operation if set
- **WTREQ** F011 Write Request flag, i.e., the requested sector was found during a write operation (read only)

The following registers apply to the 45IO27 only, i.e., are MEGA65 specific:

HEX	DEC	DB7	DB6	DB5	DB4	DB3	DB2	DB1	DB0
D6A0	54944	DENSITY	DBGMO-TORA	DBGMO-TORA	DBGDIR	DBGDIR	DBGW-DATA	DBGW-GATE	DBGW-GATE
D6A2	54946	DATARATE							

- **DATARATE** Set number of bus cycles per floppy magnetic interval (decrease to increase data rate)
- **DBGDIR** Control floppy drive STEPDIR line
- **DBGMOTORA** Control floppy drive MOTOR line
- **DBGWDATA** Control floppy drive WDATA line
- **DBGWGATE** Control floppy drive WGATE line
- **DENSITY** Control floppy drive density select line

SD CARD CONTROLLER AND F011 VIRTUALISATION FUNCTIONS

For those situations where you do not wish to use real floppy disks, the 45IO27 supports two complementary alternative modes:

- SD card Based Disk Image Access.
- Virtualised Disk Image Access.

This is in addition to providing direct access to a dual-bus SD card interface.

SD card Based Disk Image Access

The 45IO27 is both a floppy drive and SD card controller. This enables it to transparently allow access to D81 disk images stored on the SD card. Further, because the controller is combined, it is possible to still have the floppy drive step and spin as though it were being used, providing considerable atmosphere and sense of realism, even when using disk images.

The 45IO27 supports both 800KB standard D81 disk images, as well as 64MB “MEGA Images”. While an operating system may impose restrictions based on the name of a file, the 45IO27 is blind to these requirements. Instead, it requires only that a contiguous 800KB or 64MB of the SD card is used to contain a disk image.

When a disk image is enabled, the corresponding set of sectors on the SD card are effectively placed under user control, and the operating system is no longer able to prevent the reading or writing of any of those sectors. Thus you should never enable access to an image that is shorter than the required size, as it will otherwise allow the user to unwittingly or maliciously access and/or modify data that is not part of the image file.

For the same reason, only the hypervisor can change the sector number where a disk image starts (the D?STARTSEC? signals), or allow the use of disk images instead of the real floppy drive (USEREAL0 and USEREAL1 signals). Once the Hypervisor has set the start sector of a disk image, and cleared the USEREAL0 or USEREAL1 signal, the user can still controll whether an access will go to the real floppy drive or to the disk image by respectively clearing or setting the appropriate signal. For drive 0, this is D0IMG, and for drive 1, it is D1IMG.

There are also signals to control whether a disk image is an 800KB D81 image or a 64MB MEGA Disk image, and whether a disk image is present, and whether it is write protected. These are all located in the \$D68B register. Because of the ability of manipulation of these registers to corrupt or improperly access data, these signals are all read-only, except from within the hypervisor.

The following table lists the registers that are used to control access to disk images resident on the SD card:

HEX	DEC	DB7	DB6	DB5	DB4	DB3	DB2	DB1	DB0
D68B	54923	D1MD	D0MD	D1WP	D1P	D1IMG	D0WP	D0P	D0IMG
D68C	54924	D0STARTSEC0							
D68D	54925	D0STARTSEC1							
D68E	54926	D0STARTSEC2							
D68F	54927	D0STARTSEC3							
D690	54928	D1STARTSEC0							

continued ...

...continued

HEX	DEC	DB7	DB6	DB5	DB4	DB3	DB2	DB1	DB0	
D691	54929	D1STARTSEC1								
D692	54930	D1STARTSEC2								
D693	54931	D1STARTSEC3								
D6A1	54945	-					USE- REAL1	TARGANY	USE- REAL0	

- **DOIMG** F011 drive 0 use disk image if set, otherwise use real floppy drive.
- **DOMD** F011 drive 0 disk image is 64MiB mega image if set (otherwise 800KiB 1581 image)
- **DOP** F011 drive 0 media present
- **DOSTARTSEC0** F011 drive 0 disk image address on SD card (LSB)
- **DOSTARTSEC1** F011 drive 0 disk image address on SD card (2nd byte)
- **DOSTARTSEC2** F011 drive 0 disk image address on SD card (3rd byte)
- **DOSTARTSEC3** F011 drive 0 disk image address on SD card (MSB)
- **DOWP** Write protect F011 drive 0
- **D1IMG** F011 drive 1 use disk image if set, otherwise use real floppy drive.
- **D1MD** F011 drive 1 disk image is 64MiB mega image if set (otherwise 800KiB 1581 image)
- **D1P** F011 drive 1 media present
- **D1STARTSEC0** F011 drive 1 disk image address on SD card (LSB)
- **D1STARTSEC1** F011 drive 1 disk image address on SD card (2nd byte)
- **D1STARTSEC2** F011 drive 1 disk image address on SD card (3rd byte)
- **D1STARTSEC3** F011 drive 1 disk image address on SD card (MSB)
- **D1WP** Write protect F011 drive 1
- **TARGANY** Read next sector under head if set, ignoring the requested side, track and sector number.
- **USEREAL0** Use real floppy drive for drive 0 if set (read-only, except for from hypervisor)
- **USEREAL1** Use real floppy drive for drive 1 if set (read-only, except for from hypervisor)

F011 Virtualisation

In addition to allowing automatic read and write access to SD card based D81 images, it is possible to connect a program to the serial monitor interface that provides and accepts data as though it were the floppy disk.

This is commonly used in a cross-development environment, where you wish to frequently modify a disk image that is used by a program you are developing – without the need to continually push new versions of the disk image on the MEGA65's SD card first. It also has the added benefit that it allows you to easily visualise which sectors are being read from and written to, which can help speed up development and debugging of your program.

This function operates together with the MEGA65's Hypervisor by triggering hyperrupts (that is, interrupts that activate the Hypervisor). There is then special code in the Hypervisor that communicates with the μ 65 program via the serial monitor interface.

If that all sounds rather complex, all you need to know is that to use this function, you run the μ 65 utility with arguments like `-d image.d81`. This should automatically establish the link with the MEGA65. If the BASIC interpreter stops responding, press the reset button (not the power switch) on the left-hand side of your MEGA65, and it should return to the BASIC's READY. prompt – and if your supplied disk image has a C65 auto-boot function, then it should automatically start booting.

This function works very well if the host computer runs Linux, and will allow loading at a speed of around 60KB per second. However, it may be much slower on Windows or Apple OSX-based systems.

Of course to use this, you will also need an interface module and/or cable to connect your cross-development system to the MEGA65's serial monitor interface. This is most easily done using a Trenz TE0790-03 JTAG adapter and mini-USB cable.

More information on using this interface and the μ 65 tool can be found in Chapter/Appendix 14 on page 14-3.

Dual-Bus SD card Controller

The 45IO27 contains a high-speed dual-bus SD card controller. This controller operates in SPI x1 mode at a clock speed of 20MHz, providing a maximum throughput of approximately 2MB/sec. The quality of the SD card makes a significant difference to performance, with some cards routinely delivering 1.7MB/sec, while others 1MB/sec or less. Generally speaking, newer cards marketed as being suitable for video recording perform better. The controller supports SDHC cards, and has experimental support

for SDXC cards. Legacy SD cards with a capacity of 2GB or less are not supported, as these use a different addressing mode.

The SD controller itself is very simple to drive: Supply the sector number in \$D861-\$D684, and then issue a read or write command to the command register (\$D680). The SD controller supports only sector-based buffered operations, using the sector buffer. In hypervisor mode, the sector buffer is located at \$FFD6E00 - \$FFD6FFF, while when the computer is in normal operating mode, the SD card and the floppy controller share a single address for both the floppy drive and SD card sector buffers. Which buffer is visible at that address is dictated by the BUFSEL signal. If it is 1, then the SD card buffer is visible, while if it is 0, then the floppy drive sector buffer is visible. See also Sub-section Q on page Q-4 for further discussion on the precise behaviour of this buffer with regard to normal mode versus Hypervisor mode, and how it can also be mapped at \$DE00.

Write Gate

When writing a sector, you must, however, first open the “write gate”. This is a mechanism to prevent accidental corruption of data on the SD card, as it requires two different values to be written to the command register (\$D680) in quick succession: You have approximately 1 milli second after opening the write gate to command the write, before the write gate effectively closes again, write-protecting the SD card until the write gate is opened again. There are two different write gates: One for the master boot record (sector 0), and the other for all other sectors, both of which are listed in the command table below. This is designed to provide additional protection to the very important master boot record sector against programs accidentally calculating sector 0 as the target for an ordinary write.

Fill Mode

Where you wish to fill sectors with a constant value, the 45IO27 supports a mode for this, so that you do not need to overwrite the contents of the sector buffer. This is activated by placing the desired fill value into the FILLVAL register (\$D686), and then issuing the enable fill mode command (\$83), performing the sector write operations, and then issuing the disable fill mode command (\$84).

Selecting Among Multiple SD cards

The controller supports two SD card interfaces, and it is possible to have a card in both at the same time. However, each card needs to be reset and commanded separately.

Only one card can be commanded at a time. That said, it is possible to reset each card once, and then switch between the cards to perform individual operations.

To select the first SD card slot, write \$C0 to the SD Controller Command Register (\$D680). To select the second SD card slot, write \$C1 instead.

SD Controller Command Table

The SD controller supports the following commands that can be written to the command register at \$D680:

Command	Function
\$00 (0)	Place SD card under reset (deprecated. Use command \$10 instead)
\$01 (1)	Release SD card from reset
\$02 (2)	Read a sector from the SD card
\$03 (3)	Write a single sector to the SD card
\$04 (4)	Write the first sector of a multi-sector write to the SD card
\$05 (5)	Write a subsequent sector of a multi-sector write to the SD card
\$06 (6)	Write the final sector of a multi-sector write to the SD card
\$0C (12)	Request flush of SD card write buffers (experimental)
\$0E (14)	Pull SD handshake line low (debug only)
\$0F (15)	Pull SD handshake line high (debug only)
\$10 (16)	Place SD card under reset with flags set (preferred method)
\$11 (17)	Release SD card from reset (alternate method)
\$40 (64)	Clear the SDHC/SDXC flag, selecting legacy SD card mode (deprecated)
\$41 (65)	Set the SDHC/SDXC mode flag
\$44 (68)	End force clearing of SD card state machine error flag
\$45 (69)	Begin force clearing of SD card state machine error flag
\$4D (77)	Open write-gate to sector 0 (master boot record) for approximately 1 milli-second
\$57 (87)	Open write-gate for all sectors > 0 for approximately 1 milli-second

continued ...

...continued

Command	Function
\$81 (129)	Enable mapping of the SD/FDC sector buffer at \$DE00 - \$DFFF
\$82 (130)	Disable mapping of the SD/FDC sector buffer at \$DE00 - \$DFFF
\$83 (131)	Enable SD card Fill Mode
\$84 (132)	Disable SD card Fill Mode
\$C0 (192)	Select SD card Slot 0
\$C1 (193)	Select SD card Slot 1

Note that the hypervisor can enable or disable direct access to the SD controller. The hypervisor operating system may provide a mechanism for requesting permission to access the SD card controller, e.g., for disk management utilities.

The SD card controller registers are as follows:

HEX	DEC	DB7	DB6	DB5	DB4	DB3	DB2	DB1	DB0	
D680	54912	CMDANDSTAT								
D681	54913	SECTOR0								
D682	54914	SECTOR1								
D683	54915	SECTOR2								
D684	54916	SECTOR3								
D686	54918	FILLVAL								
D68A	54922	-				VFDC1	VFDC0	VICIII	CDC00	
D6AE	54958	-	FDC2XSEL	FDCVAR-SPD	AUTO2XSEL		-			
D6AF	54959	-		VLOST	VDRQ	VRNF	VEQINH	VW-FOUND	VRFFOUND	

- **AUTO2XSEL** Automatically select DD or HD decoder for last sector display
- **CDC00** (read only) Set if colour RAM at \$DC00
- **CMDANDSTAT** SD controller status/command
- **FDC2XSEL** Select HD decoder for last sector display
- **FDCVARSPD** Enable automatic variable speed selection for floppy controller using Track Information Blocks on MEGA65 HD floppies
- **FILLVAL** WRITE ONLY set fill byte for use in fill mode, instead of SD buffer data
- **SECTOR0** SD controller SD sector address (LSB)

- **SECTOR1** SD controller SD sector address (2nd byte)
- **SECTOR2** SD controller SD sector address (3rd byte)
- **SECTOR3** SD controller SD sector address (MSB)
- **VDRQ** Manually set f011_drq signal (indented for virtual F011 mode only)
- **VEQINH** Manually set f011_eq_inhibit signal (indented for virtual F011 mode only)
- **VFDC0** (read only) Set if drive 0 is virtualised (sectors delivered via serial monitor interface)
- **VFDC1** (read only) Set if drive 1 is virtualised (sectors delivered via serial monitor interface)
- **VICIII** (read only) Set if VIC-IV or ethernet IO bank visible
- **VLOST** Manually set f011_lost signal (indented for virtual F011 mode only)
- **VRFOUND** Manually set f011_rsector_found signal (indented for virtual F011 mode only)
- **VRNF** Manually set f011_rnf signal (indented for virtual F011 mode only)
- **VWFOUND** Manually set f011_wsector_found signal (indented for virtual F011 mode only)

TOUCH PANEL INTERFACE

Some MEGA65 variants include an LCD touch panel, primarily the MEGApHONE handheld version of the MEGA65. The touch interface supports the detection of two simultaneous touch events. Some variants may also support gesture detection, however, this is still very experimental.

The touch detection interface that is contained in the 45IO27 is complemented by the on-screen-keyboard interface of the 4551 UART and GPIO controller. Refer to section O for further information. Of particular relevance are bit 7 of the registers \$D615 - \$D617 which allow activating the on-screen keyboard interface, selecting whether the on-screen keyboard is placed in the upper or lower portion of the screen, and whether the primary or secondary on-screen keyboard is displayed.

Direct connections between the 4551 and the 45IO27 combine information about any currently displayed on-screen keyboard and the touch interface controller, allowing synthetic keyboard events to be automatically triggered when the on-screen keyboard portion of the touch interface is pressed. This allows the touch interface

to be used to drive the on-screen keyboard without requiring any support from user programs. This works even when the on-screen keyboard is moving during activation or transitioning between the top and bottom of the screen.

As touch interfaces can require calibration, the 45IO27 allows for a linear transformation of both the X and Y coordinates of a touch event. Specifically, there are scale (TCHXSCALE and TCHYSCALE) and offset registers (TCHXDELTA and TCHYDELTA) that provide for this transformation. It is also possible to flip the touch screen coordinates in either or both the X and Y axes. These calibration registers also affect the operation of the on-screen keyboard.

It should also be noted that some touch interfaces do not have constant horizontal or vertical resolution. For example, some panels have a low horizontal resolution region in the middle of the panel, which can require some care to accommodate.

To detect the primary touch event, the TOUCH1XLSB, TOUCH1XMSB, TOUCH1YLSB, TOUCH1YMSB registers can be read. Similar registers exist for the 2nd touch event: TOUCH2XLSB, TOUCH2XMSB, TOUCH2YLSB, TOUCH2YMSB. Each touch event has a single bit flag that indicates whether the touch event is currently valid: the EV1 and EV2 bits of the register \$D6B0. There are also corresponding bit-fields that indicate whether a given touch event has been made or released, allowing the detection of when a finger both makes and breaks contact with the screen. The UPDN1 and UPDN2 signals provide this information. Binary values of 01 and 10, respectively indicate if the finger has been removed or pressed against the touch panel. Values of 00 and 11 mean that a finger is either being held or not being held against the touch panel.

The primary touch event is also fed into the lightpen input of the VIC-IV, and can be detected using the normal light pen registers of the VIC-IV.

The registers for the touch panel interface are as follows:

HEX	DEC	DB7	DB6	DB5	DB4	DB3	DB2	DB1	DB0
D6B0	54960	YINV	XINV	UPDN2		UPDN1		EV2	EV1
D6B1	54961	CALXSCALELSB							
D6B2	54962	CALXSCALEMSB							
D6B3	54963	CALYSCALELSB							
D6B4	54964	CALYSCALEMSB							
D6B5	54965	CALXDELTA LSB							
D6B7	54967	CALYDELTA LSB							
D6B8	54968	CALYDELTA MSB							
D6B9	54969	TOUCH1XLSB							
D6BA	54970	TOUCH1YLSB							
D6BB	54971	-	TOUCH1YMSB		-	TOUCH1XMSB			
D6BC	54972	TOUCH2XLSB							

continued ...

...continued

HEX	DEC	DB7	DB6	DB5	DB4	DB3	DB2	DB1	DB0
D6BD	54973	TOUCH2YLSB							
D6BE	54974	-	TOUCH2YMSB			-	TOUCH2XMSB		
D6C0	54976	GESTUREID				GESTUREDIRE			

- **CALXDELTA**LSB Touch pad X delta LSB
- **CALXSCALE**LSB Touch pad X scaling LSB
- **CALXSCALE**MSB Touch pad X scaling MSB
- **CALYDELTA**LSB Touch pad Y delta LSB
- **CALYDELTA**MSB Touch pad Y delta MSB
- **CALYSCALE**LSB Touch pad Y scaling LSB
- **CALYSCALE**MSB Touch pad Y scaling MSB
- **EV1** Touch event 1 is valid
- **EV2** Touch event 2 is valid
- **GESTUREDIRE** Touch pad gesture directions (left,right,up,down)
- **GESTUREID** Touch pad gesture ID
- **TOUCH1X**LSB Touch pad touch 1 X LSB
- **TOUCH1X**MSB Touch pad touch #1 X MSBs
- **TOUCH1Y**LSB Touch pad touch 1 Y LSB
- **TOUCH1Y**MSB Touch pad touch #1 Y MSBs
- **TOUCH2X**LSB Touch pad touch #2 X LSB
- **TOUCH2X**MSB Touch pad touch #2 X MSBs
- **TOUCH2Y**LSB Touch pad touch #2 Y LSB
- **TOUCH2Y**MSB Touch pad touch #2 Y MSBs
- **UPDN1** Touch event 1 up/down state
- **UPDN2** Touch event 2 up/down state
- **XINV** Invert horizontal axis
- **YINV** Invert vertical axis

AUDIO SUPPORT FUNCTIONS

The 45IO27 provides the primary interface into the MEGA65's full cross-bar audio mixer. This includes the interface for reading or modifying the mixer co-efficients, as well as accessing the mixer feedback registers, and setting the 16-bit digital sample values that are two of the input channels into the audio mixer.

The audio mixer consists of 128 coefficients, each of which is 16 bits. Each audio output channel, e.g., left speaker, right speaker, left headphone, right headphone, cellular modem 1 (MEGAsphone models only) and so on, are generated by taking each of the audio input channels, multiplying them by the appropriate coefficient, and adding it to the total output of the audio output channel.

Because each audio output channel has its own set of coefficients that are applied to all of the audio input channels, this means that it is possible to produce totally different audio out each audio channel: For example, it is possible to play your favourite quadrophonic SID music out of the headphones while rick-rolling passers by with Amiga-style MOD audio. This is why the audio mixer is referred to as a full cross-bar mixer, because there are no restrictions on how you mix each audio output channel. In this regard, it is very similar to a full-function audio desk, allowing different mixing levels for different speakers.

Because the audio coefficients are 16 bits each, each one is formed using two successive bytes of the audio co-efficient space. Changes to the audio coefficients take effect immediately, so care should be taken when changing coefficients to avoid audible clicks and pops. Also, you must allow 32 cycles to elapse before changing the selected audio coefficient, as otherwise the change may be discarded if the audio mixer accumulator has not had time to re-visit that coefficient.

The audio sources on the MEGA65 and MEGAsphone devices are as follows:

Input Channel ID	Connection
\$0 (0)	Left SIDs
\$1 (1)	Right SIDs
\$2 (2)	Modem Bay 1 (MEGAsphone only)
\$3 (3)	Modem Bay 2 (MEGAsphone only)
\$4 (4)	Bluetooth™Left
\$5 (5)	Bluetooth™Right
\$6 (6)	Headphone Interface 1
\$7 (7)	Headphone Interface 2
\$8 (8)	Digital audio Left

continued ...

...continued

Input Channel ID	Connection
\$9 (9)	Digital audio Right
\$A (10)	MEMs Microphone 0 (Nexys4 and MEGAprone only)
\$B (11)	MEMs Microphone 1 (MEGAprone only)
\$C (12)	MEMs Microphone 2 (MEGAprone only)
\$D (13)	MEMs Microphone 3 (MEGAprone only)
\$E (14)	Headphone jack microphone (Nexys4 and MEGAprone only)
\$F (15)	OPL-compatible FM audio (<i>shares co-efficient with input 14</i>)

The OPL-compatible FM audio which is on source 15 is controlled by the coefficient for source 14. This is because the coefficient for source 15 provides the master volume level for each output.

The audio cross-bar mixer supports the following eight output channels:

Output Channel ID	Connection
\$0 (0)	Left Primary Speaker (digital audio on MEGA65 R2/R3, physical speaker on MEGAprone, headphone jack audio on Nexys4)
\$1 (1)	Right Primary Speaker (digital audio on MEGA65 R2/R3, physical speaker on MEGAprone, headphone jack audio on Nexys4)
\$2 (2)	Modem Bay 1 audio output (MEGAprone only)
\$3 (3)	Modem Bay 2 audio output (MEGAprone only)
\$4 (4)	Bluetooth Left Audio (MEGAprone only)
\$5 (5)	Bluetooth Right Audio (MEGAprone only)
\$6 (6)	Headphone Left output (MEGA65 R2/R3 and MEGAprone only. On Nexys4 boards the primary speaker drives the 3.5mm jack)
\$7 (7)	Headphone Right output (MEGA65 R2/R3 and MEGAprone only. On Nexys4 boards the primary speaker drives the 3.5mm jack)

To determine the coefficient register number for a given source and output, multiply the output number by 32 and multiply the source number by 2. This will be the register number for the LSB of the 16-bit coefficient. The MSB will be the next register. For

example, to set the coefficient of the right SIDs to the 2nd modem bay audio output, the coefficient would be $32 \times 3 + 1 \times 2 = 96 + 2 = 98$.

XXX - mixer stuff XXX - mixer feedback registers XXX - Left and right digi XXX - CPU register for selecting PWM/PDM

HEX	DEC	DB7	DB6	DB5	DB4	DB3	DB2	DB1	DB0	
D6F4	55028	MIXREGSEL								
D6F5	55029	MIXREGDATA								
D6F8	55032	DIGILLSB								
D6F9	55033	DIGILMSB								
D6FA	55034	DIGIRLSB								
D6FB	55035	DIGIRMSB								
D6FC	55036	READBACKLSB								
D6FD	55037	READBACKMSB								
D711	55057	-				PWMPDM	-			

- **DIGILEFTLSB** Digital audio, left channel, LSB
- **DIGILEFTMSB** Digital audio, left channel, MSB
- **DIGILLSB** 16-bit digital audio out (left LSB)
- **DIGILMSB** 16-bit digital audio out (left MSB)
- **DIGIRIGHTLSB** Digital audio, left channel, LSB
- **DIGIRIGHTMSB** Digital audio, left channel, MSB
- **DIGIRLSB** 16-bit digital audio out (right LSB)
- **DIGIRMSB** 16-bit digital audio out (right MSB)
- **MIXREGDATA** Audio Mixer register read port
- **MIXREGSEL** Audio Mixer register select
- **PWMPDM** PWM/PDM audio encoding select
- **READBACKLSB** audio read-back LSB (source selected by \$D6F4)
- **READBACKMSB** audio read-back MSB (source selected by \$D6F4)

MISCELLANEOUS I/O FUNCTIONS

APPENDIX

R

Reference Tables

- **Units of Storage**
- **Base Conversion**

UNITS OF STORAGE

Unit	Equals	Abbreviation
1 Bit		
1 Nibble	4 Bits	
1 Byte	8 bits	B
1 Kilobyte	1024 B	KB
1 Megabyte	1024KB or 1,048,576 B	MB

BASE CONVERSION

Decimal	Binary	Hexadecimal
0	%0	\$0
1	%1	\$1
2	%10	\$2
3	%11	\$3
4	%100	\$4
5	%101	\$5
6	%110	\$6
7	%111	\$7
8	%1000	\$8
9	%1001	\$9
10	%1010	\$A
11	%1011	\$B
12	%1100	\$C
13	%1101	\$D
14	%1110	\$E
15	%1111	\$F
16	%10000	\$10
17	%10001	\$11
18	%10010	\$12
19	%10011	\$13
20	%10100	\$14
21	%10101	\$15
22	%10110	\$16
23	%10111	\$17
24	%11000	\$18
25	%11001	\$19
26	%11010	\$1A
27	%11011	\$1B
28	%11100	\$1C
29	%11101	\$1D
30	%11110	\$1E
31	%11111	\$1F

Decimal	Binary	Hexadecimal
32	%100000	\$20
33	%100001	\$21
34	%100010	\$22
35	%100011	\$23
36	%100100	\$24
37	%100101	\$25
38	%100110	\$26
39	%100111	\$27
40	%101000	\$28
41	%101001	\$29
42	%101010	\$2A
43	%101011	\$2B
44	%101100	\$2C
45	%101101	\$2D
46	%101110	\$2E
47	%101111	\$2F
48	%110000	\$30
49	%110001	\$31
50	%110010	\$32
51	%110011	\$33
52	%110100	\$34
53	%110101	\$35
54	%110110	\$36
55	%110111	\$37
56	%111000	\$38
57	%111001	\$39
58	%111010	\$3A
59	%111011	\$3B
60	%111100	\$3C
61	%111101	\$3D
62	%111110	\$3E
63	%111111	\$3F

Decimal	Binary	Hexadecimal
64	%1000000	\$40
65	%1000001	\$41
66	%1000010	\$42
67	%1000011	\$43
68	%1000100	\$44
69	%1000101	\$45
70	%1000110	\$46
71	%1000111	\$47
72	%1001000	\$48
73	%1001001	\$49
74	%1001010	\$4A
75	%1001011	\$4B
76	%1001100	\$4C
77	%1001101	\$4D
78	%1001110	\$4E
79	%1001111	\$4F
80	%1010000	\$50
81	%1010001	\$51
82	%1010010	\$52
83	%1010011	\$53
84	%1010100	\$54
85	%1010101	\$55
86	%1010110	\$56
87	%1010111	\$57
88	%1011000	\$58
89	%1011001	\$59
90	%1011010	\$5A
91	%1011011	\$5B
92	%1011100	\$5C
93	%1011101	\$5D
94	%1011110	\$5E
95	%1011111	\$5F

Decimal	Binary	Hexadecimal
96	%1100000	\$60
97	%1100001	\$61
98	%1100010	\$62
99	%1100011	\$63
100	%1100100	\$64
101	%1100101	\$65
102	%1100110	\$66
103	%1100111	\$67
104	%1101000	\$68
105	%1101001	\$69
106	%1101010	\$6A
107	%1101011	\$6B
108	%1101100	\$6C
109	%1101101	\$6D
110	%1101110	\$6E
111	%1101111	\$6F
112	%1110000	\$70
113	%1110001	\$71
114	%1110010	\$72
115	%1110011	\$73
116	%1110100	\$74
117	%1110101	\$75
118	%1110110	\$76
119	%1110111	\$77
120	%1111000	\$78
121	%1111001	\$79
122	%1111010	\$7A
123	%1111011	\$7B
124	%1111100	\$7C
125	%1111101	\$7D
126	%1111110	\$7E
127	%1111111	\$7F

Decimal	Binary	Hexadecimal
128	%10000000	\$80
129	%10000001	\$81
130	%10000010	\$82
131	%10000011	\$83
132	%10000100	\$84
133	%10000101	\$85
134	%10000110	\$86
135	%10000111	\$87
136	%10001000	\$88
137	%10001001	\$89
138	%10001010	\$8A
139	%10001011	\$8B
140	%10001100	\$8C
141	%10001101	\$8D
142	%10001110	\$8E
143	%10001111	\$8F
144	%10010000	\$90
145	%10010001	\$91
146	%10010010	\$92
147	%10010011	\$93
148	%10010100	\$94
149	%10010101	\$95
150	%10010110	\$96
151	%10010111	\$97
152	%10011000	\$98
153	%10011001	\$99
154	%10011010	\$9A
155	%10011011	\$9B
156	%10011100	\$9C
157	%10011101	\$9D
158	%10011110	\$9E
159	%10011111	\$9F

Decimal	Binary	Hexadecimal
160	%10100000	\$A0
161	%10100001	\$A1
162	%10100010	\$A2
163	%10100011	\$A3
164	%10100100	\$A4
165	%10100101	\$A5
166	%10100110	\$A6
167	%10100111	\$A7
168	%10101000	\$A8
169	%10101001	\$A9
170	%10101010	\$AA
171	%10101011	\$AB
172	%10101100	\$AC
173	%10101101	\$AD
174	%10101110	\$AE
175	%10101111	\$AF
176	%10110000	\$B0
177	%10110001	\$B1
178	%10110010	\$B2
179	%10110011	\$B3
180	%10110100	\$B4
181	%10110101	\$B5
182	%10110110	\$B6
183	%10110111	\$B7
184	%10111000	\$B8
185	%10111001	\$B9
186	%10111010	\$BA
187	%10111011	\$BB
188	%10111100	\$BC
189	%10111101	\$BD
190	%10111110	\$BE
191	%10111111	\$BF

Decimal	Binary	Hexadecimal
192	%11000000	\$C0
193	%11000001	\$C1
194	%11000010	\$C2
195	%11000011	\$C3
196	%11000100	\$C4
197	%11000101	\$C5
198	%11000110	\$C6
199	%11000111	\$C7
200	%11001000	\$C8
201	%11001001	\$C9
202	%11001010	\$CA
203	%11001011	\$CB
204	%11001100	\$CC
205	%11001101	\$CD
206	%11001110	\$CE
207	%11001111	\$CF
208	%11010000	\$D0
209	%11010001	\$D1
210	%11010010	\$D2
211	%11010011	\$D3
212	%11010100	\$D4
213	%11010101	\$D5
214	%11010110	\$D6
215	%11010111	\$D7
216	%11011000	\$D8
217	%11011001	\$D9
218	%11011010	\$DA
219	%11011011	\$DB
220	%11011100	\$DC
221	%11011101	\$DD
222	%11011110	\$DE
223	%11011111	\$DF

Decimal	Binary	Hexadecimal
224	%11100000	\$E0
225	%11100001	\$E1
226	%11100010	\$E2
227	%11100011	\$E3
228	%11100100	\$E4
229	%11100101	\$E5
230	%11100110	\$E6
231	%11100111	\$E7
232	%11101000	\$E8
233	%11101001	\$E9
234	%11101010	\$EA
235	%11101011	\$EB
236	%11101100	\$EC
237	%11101101	\$ED
238	%11101110	\$EE
239	%11101111	\$EF
240	%11110000	\$F0
241	%11110001	\$F1
242	%11110010	\$F2
243	%11110011	\$F3
244	%11110100	\$F4
245	%11110101	\$F5
246	%11110110	\$F6
247	%11110111	\$F7
248	%11111000	\$F8
249	%11111001	\$F9
250	%11111010	\$FA
251	%11111011	\$FB
252	%11111100	\$FC
253	%11111101	\$FD
254	%11111110	\$FE
255	%11111111	\$FF

APPENDIX

S

Flashing the FPGAs and CPLDs in the MEGA65

- Suggested PC specifications
- Warning
- Installing Vivado
- Installing the FTDI drivers
- Flashing the main FPGA using Vivado
- Flashing the CPLD in the MEGA65's
Keyboard with Lattice
Diamond

- **Flashing the MAX10 FPGA on the MEGA65's Mainboard with INTEL QUARTUS**

The MEGA65 is an open-source and open-hardware computer. This means you are free, not only to write programs that run on the MEGA65 as a finished computer, but also to use the re-programmable chips in the MEGA65 to turn it into all sorts of other things.

If you just want to install an upgrade core for the MEGA65, or a core that lets you use your MEGA65 as another type of computer, you probably want to look in Chapter/Appendix 5 on page 5-3 instead.

This chapter is more intended for people who want to help develop cores for the MEGA65. This chapter may also be of interest to Nexys4 board owners that are interested booting their devices from the on-board QSPI flash memory chip (rather than a bitstream file on the SD card). This will require flashing an .mcs file onto their board's QSPI chip, so as to provide an initial bistream in the 'Slot 0' position.

These re-programmable chips are called Field Programmable Gate Arrays (FPGAs) or Complex Programmable Logic Devices (CPLDs), and can implement a wide variety of circuits. They are normally programmed using a language like VHDL or Verilog. These are languages that are not commonly encountered by most people. They are also quite different in some ways to "normal" programming languages, and it can take a while to understand how they work. But with some effort and perseverance, exciting things can be created with them.

SUGGESTED PC SPECIFICATIONS

Be prepared to install many gigabytes of software on a Linux or Windows PC, before you will be able to write programs for the FPGAs and CPLDs in the MEGA65. Also, "compiling" complex designs can take up to several hours, depending on the speed and memory capacity of your computer. We recommend a computer with at least 12GB RAM (preferably 16GB) if you want to write programs for FPGAs and CPLDs. On the other hand, if all you want to do is load programs onto your MEGA65's FPGAs and CPLDs that other people have written, then most computers running a recent version of Windows or Linux should be able to cope.

- OS: Linux or Windows
- CPU Speed: As fast as you can get your hands on!
- Number of cores: Ideally, 8 or more, as the free license of Vivado can make use of a max of 8 cores.
- Hard disk space: Have about 70GB or more. The exact amount used depends on how many components within Vivado you install (bear in mind that the full install file is about 50GB in itself)

- Memory: minimum of 12GB (ideally, have more, to play it safe)

WARNING

Before we go any further, we do have to provide a warning about reprogramming the FPGAs and CPLDs in the MEGA65. Re-programming the MEGA65 FPGA can potentially cause damage, or leave your MEGA65 in an unresponsive state from which it is very difficult to recover, i.e., “bricked”. Therefore if you choose to open your MEGA65 and reprogram any of the FPGAs it contains, it is no longer possible to guarantee its correct operation. Therefore, we cannot reasonably honour the warranty of the device as a computer. You have been warned!

INSTALLING VIVADO

Installation of Vivado is required to flash the QSPI flash memory within your MEGA65 target device, whether it be a MEGA65 R2/R3, Nexys4/Nexys4DDR/NexysA7, MEGA-phone or other.

Vivado is also the tool used to perform compilation (synthesis, as it is preferably called) of FPGA bitstreams.

To get started, connect to <https://www.xilinx.com/support/download.html>

Select 2020.2 version

Solutions Products Support

Version

- 2020.3
- 2020.2**
- 2020.1
- 2019.2
- Vivado Archive
- ISE Archive
- CAE Vendor Libraries Archive

Vivado Design Suite - HLx Editions - 2020.2 Full Product Installation

Important Information

Vivado® Design Suite 2020.2 is now available

- Public access support for the Xilinx® Versal™ Platforms
- Petalinux now a part of Xilinx Unified Installer
- Access Block Design container now to create team-based designs
- Abstract Shell for Dynamic Function eXchange
- 2020.2 Introduces Vitis™ HLS for Vivado flows
- Add-on for MATLAB® and Simulink® (Unified Model Composer and System Generator)

We **strongly recommend** to use the web installers as it reduces download time and saves significant disk space.

Download Includes

Download Type

Last Updated

Answers

Documentation

Support Forums

NOTE : Some users still have success with using older versions, as the main aim here is to install a version that supports the FPGA of your target hardware.

I.e., the Artix7 100T (for Nexys and R2) or 200T (R3).

Click on Xilinx Unified Installer 2020.2: Windows Self Extracting Web Installer EXE – 248.44MB

Xilinx Unified Installer 2020.2: Windows Self Extracting Web Installer (EXE - 248.44 MB)

MD5 SUM Value : 102bb67c6806a6667dc7176be7997475

Download Verification

Digests Signature Public Key

You will be asked to create an account in order to sign in and be able to download the installation program.

Your credentials will also be requested when doing the installation.

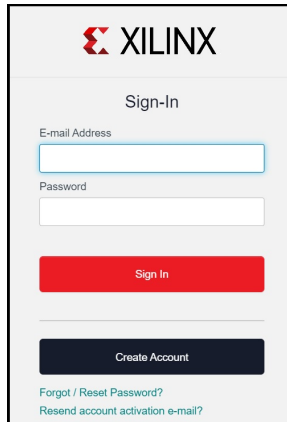

The image shows the Xilinx Sign-In page. At the top is the Xilinx logo. Below it is the heading "Sign-In". There are two input fields: "E-mail Address" and "Password". Below these fields is a red "Sign In" button. Underneath the sign-in button is a dark grey "Create Account" button. At the bottom of the form, there are two links: "Forgot / Reset Password?" and "Resend account activation e-mail?".

After having signed in, you have to provide some personal information and then click on Download

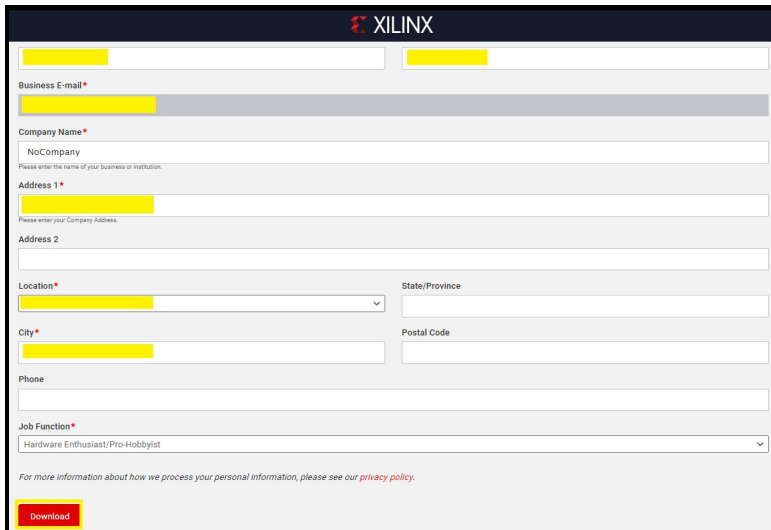

The image shows the Xilinx Personal Information form. At the top is the Xilinx logo. Below it are two input fields for first and last name. The form includes the following fields: "Business E-mail*", "Company Name*" (with a "NoCompany" option and a note "Please enter the name of your business or institution."), "Address 1*" (with a note "Please enter your Company Address."), "Address 2", "Location*" (a dropdown menu), "State/Province", "City*" (with a note "Please enter your City Address."), "Postal Code", "Phone", and "Job Function*" (a dropdown menu with "Hardware Enthusiast/Pro-Hobbyist" selected). At the bottom, there is a link "For more information about how we process your personal information, please see our [privacy policy](#)." and a red "Download" button.

Execute the installer as Administrator (Xilinx_Unified_2020.2_1118_1232_Win64.exe).

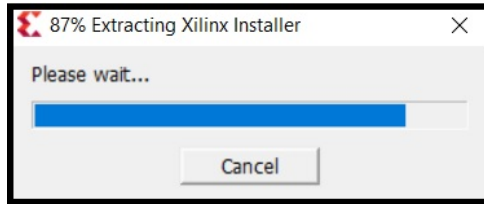

Click on Allow Access.

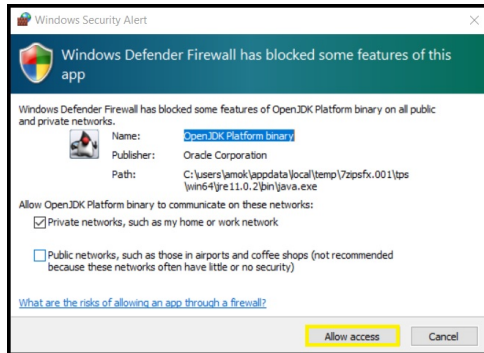

Click on Next.

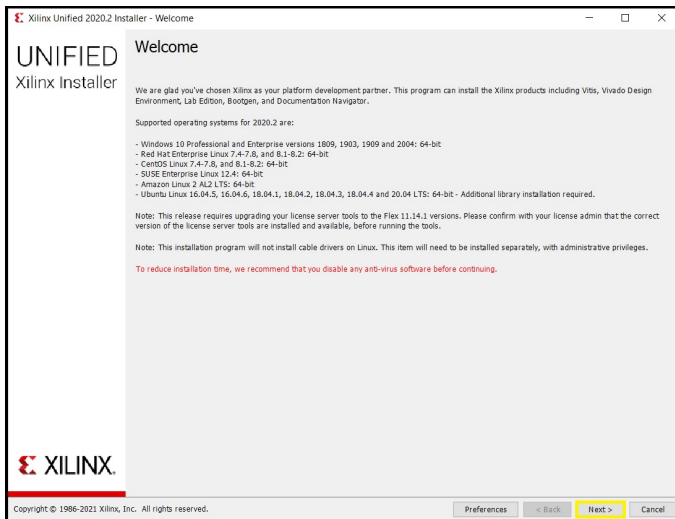

Enter your credentials and click on Next.

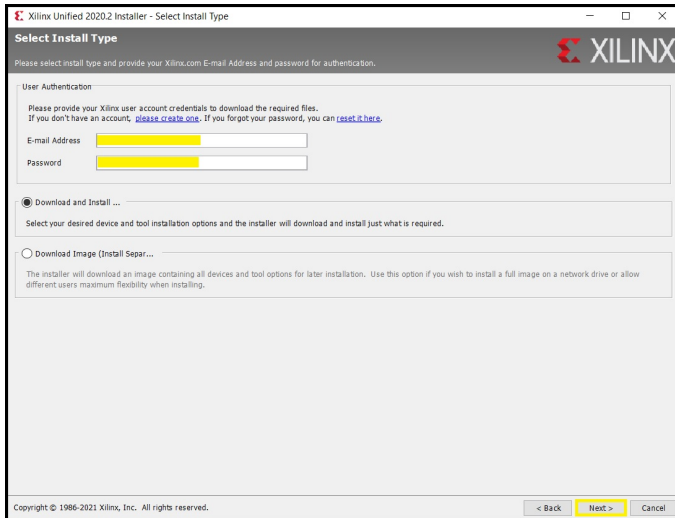

Select Vivado and click on Next.

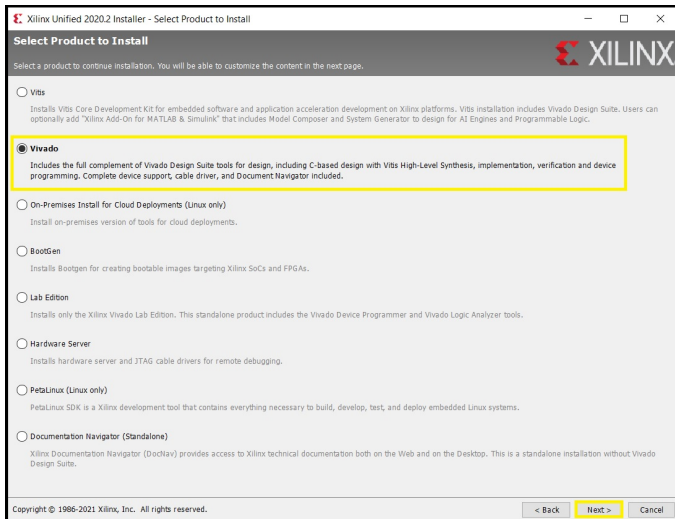

Select "Vivado HL WebPACK" and click on "Next"

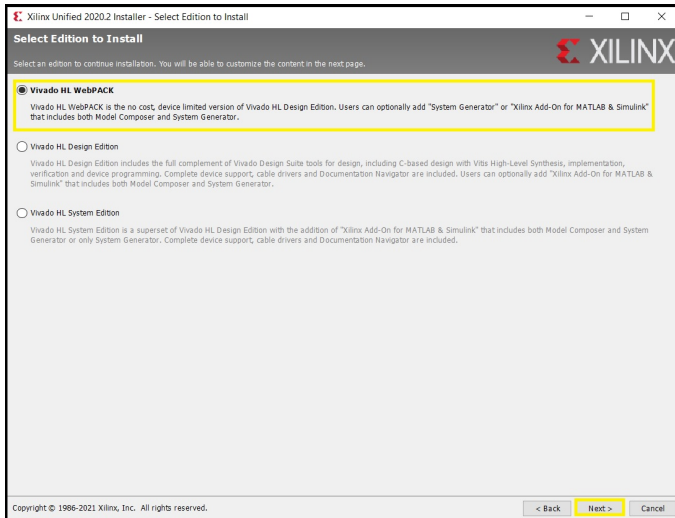

We'd suggest selecting only the **"7 Series"** devices, as our chosen FPGA is within this series, and de-selecting the other series will save you about 6GB in download size. Then click on "Next"

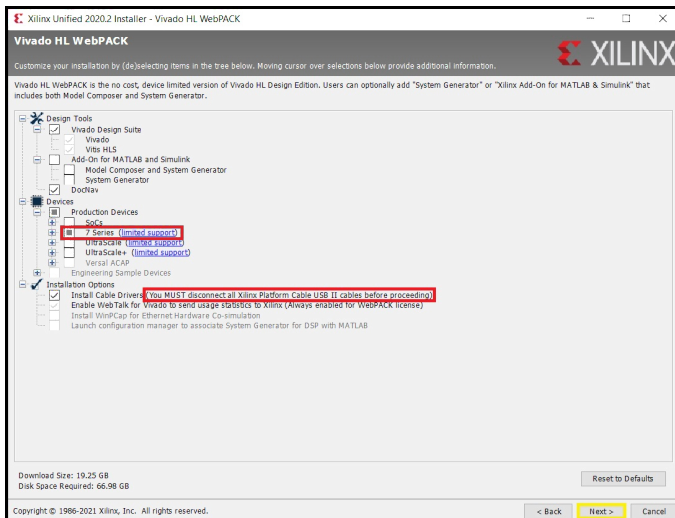

Warning: As stated, disconnect any USB cable that would be connected to your PC from the Nexys board.

Agree with all the End User Licence Agreement and Terms and conditions and click on "Next".

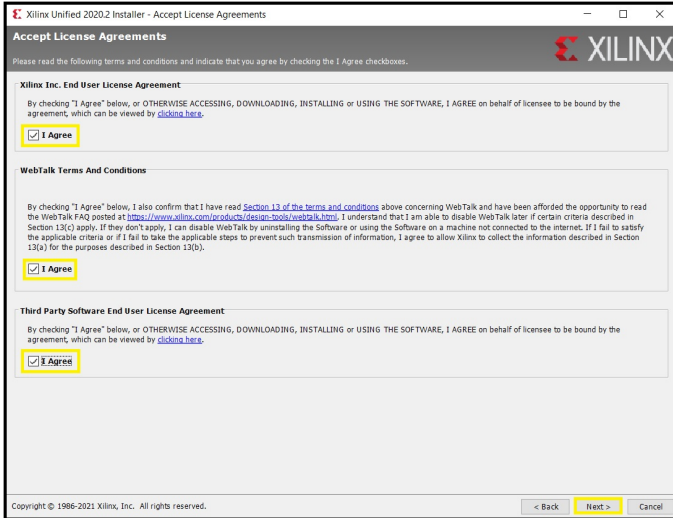

Choose the location where you want to install the software and click on "Next".

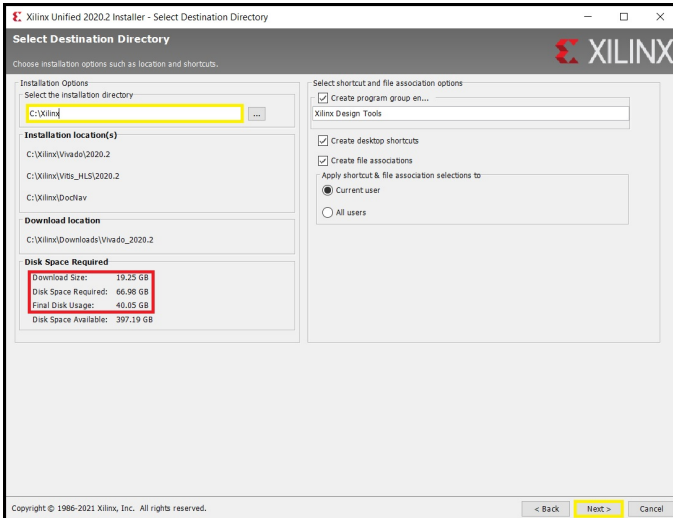

Warning : You are about to download 20GB of software and you need 70GB to perform the installation.

Click on "Yes"

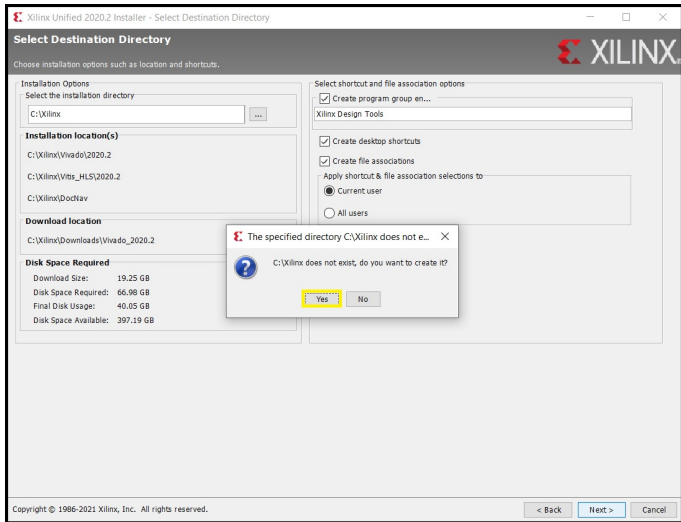

Click on "Install"

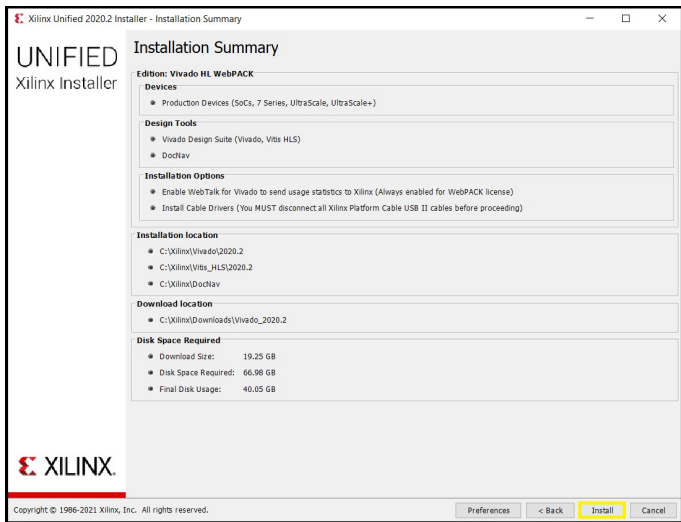

Wait for the installation to complete. At the very end of the installation you will be asked if you want to install Xilinx device software.

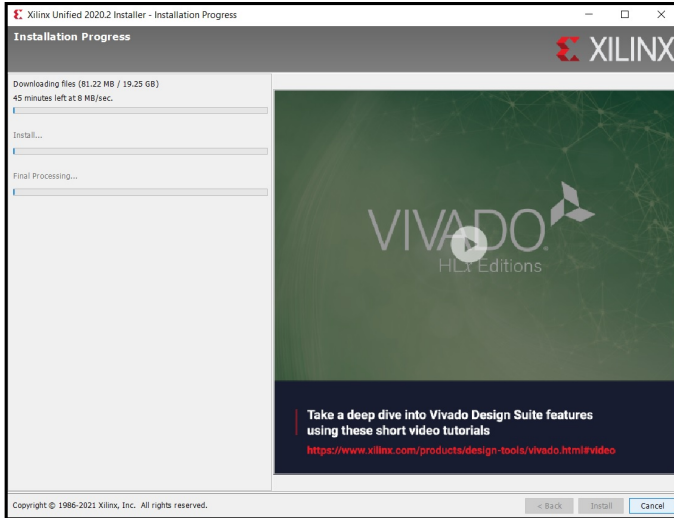

Click on "Install"

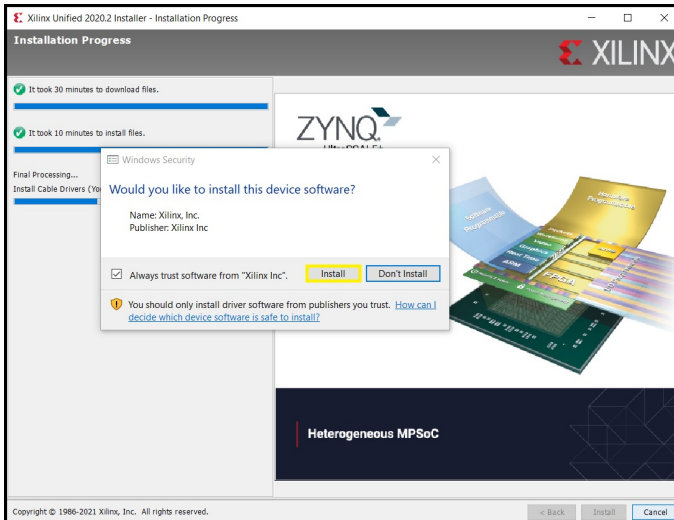

Let the installation complete.

The installation is completed. Click on "OK"

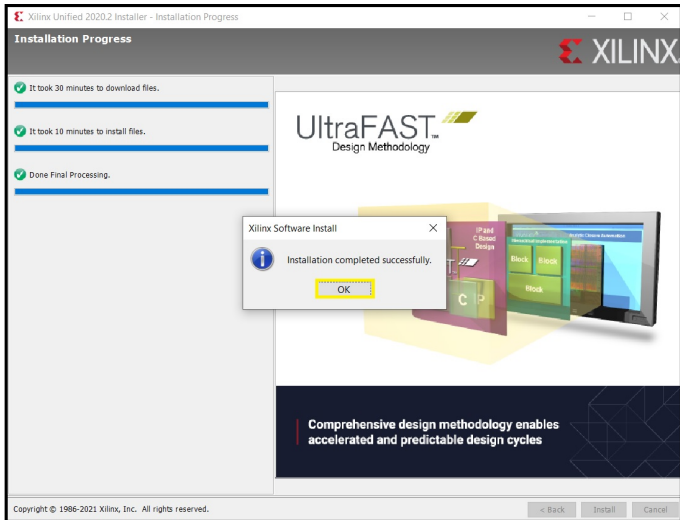

You end up with the following icons on your desktop:



Launch Vivado 2020.2

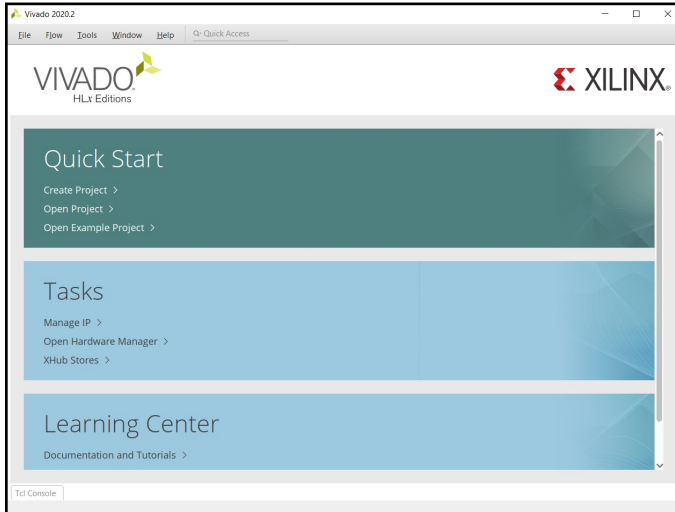

Click on "Help" -> "Obtain a licence Key"

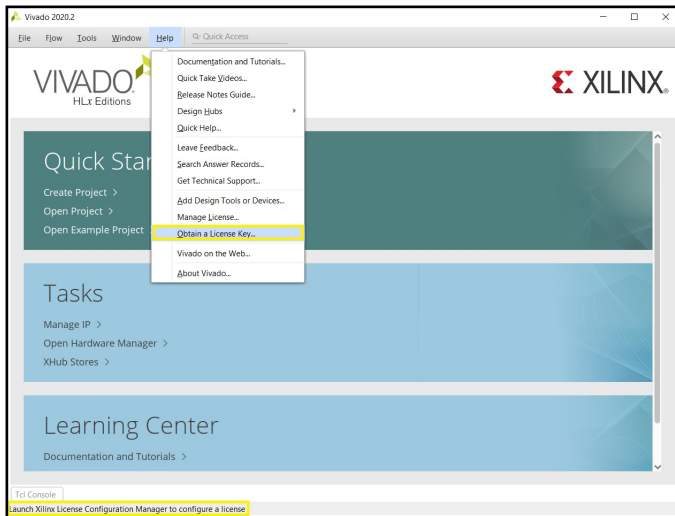

This launches the Vivado licence manager

Select "Get Free ISE WebPACK, ISE/Vivado IP or PetaLinux Licenses"

Click on "Connect Now"



Connect with the user account you have created to be able to download the Vivado software. If you were not already connected to Xilinx website, this will take you to the main webpage. Go back in the licence manager (which is not closed)

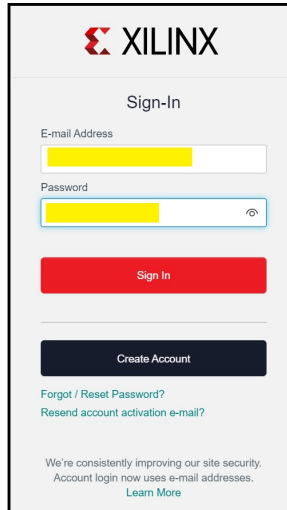

The image shows a sign-in form for Xilinx. At the top is the Xilinx logo. Below it is the heading "Sign-In". There are two input fields: "E-mail Address" and "Password", both containing yellowed-out text. Below the password field is a "Sign In" button. Underneath is a "Create Account" button. At the bottom, there are links for "Forgot / Reset Password?" and "Resend account activation e-mail?". A footer note says "We're consistently improving our site security. Account login now uses e-mail addresses." with a "Learn More" link.

Click again on "Connect Now" (ensure "Get Free ISE WebPACK, ISE/Vivado IP or PetaLinux Licenses" is still selected)



The image shows the Vivado License Manager 2020.2 application window. The title bar reads "Vivado License Manager 2020.2". The interface has a menu bar with "File" and "Help". The main area is titled "License Manager" and features the Vivado and Xilinx logos. A sidebar on the left contains a tree view with the following items: "Get License", "Set Proxy", "Obtain License", "Load License", "Manage License", "Manage License Search Paths", "View License Status", "View System Information", and "View Host Information". The main content area is titled "Obtain License" and contains the following text: "Select one of the following options". There are four radio button options: "Start Now! 30 Day Trial", "Get Vivado or IP Evaluation Licenses", "Get Free ISE WebPACK, ISE/Vivado IP or PetaLinux Licenses" (which is selected and highlighted with a yellow box), and "Get My Full or Purchased Certificate-Based License". Below these options are two buttons: "Connect Now" and "Save Link As...". A section titled "Description of the above selected option" contains the following text: "Get a free ISE WebPACK, PetaLinux or 180-day IP evaluation license (valid for either ISE or Vivado). You will be taken to the Xilinx website where you can generate a license. After generation, the license file is sent to your e-mail. Once you have saved this file to your machine, click on the Load License selection to copy your .lic file to a default location."

You then register your personal information on the Vivado website:

Product Licensing - Name and Address Verification

U.S. Government Export Approval

- U.S. export regulations require that your First Name, Last Name, Company Name and Shipping Address be verified before Xilinx can fulfill your download request. [Please provide accurate and complete information.](#)
- Addresses with Post Office Boxes and names/addresses with Non-Roman Characters with accents such as grave, tilde or colon **are not supported** by US export compliance systems.

First Name*

Last Name*

Business E-mail*

Company Name*

Please enter the name of your business or institution.

Address 1*

Please enter your Company address.

Address 2

Location*

State/Province

City*

Postal Code

Phone

Job Function*

Hardware Enthusiast/Pro-Hobbyist

For more information about how we process your personal information, please see our [privacy policy](#).

Next

Click on "Next".

Select "ISE WebPACK Licence" and "Vivado Design Suite: HL WebPACK 2015 and Earlier License"

Then click on "Generate Node-Locked Licence"

Create a New License File

Create a new license file by making your product selections from the table below. ?

Certificate Based Licenses

Product	Type	License	Available Seats	Status	Subscription End Date
<input type="checkbox"/> Xilinx add-on for Matlab and Simulink, 90 Day Evaluation	Certificate - Evaluation	Node	1/1	Current	90 days
<input type="checkbox"/> ISE Embedded Edition License	Certificate - No Charge	Node	1/1	Current	None
<input type="checkbox"/> Vivado Design Suite: 30-Day Evaluation License	Certificate - Evaluation	Node	1/1	Current	30 days
<input type="checkbox"/> SDSoC Environment, 60 Day Evaluation License	Certificate - Evaluation	Node	1/1	Current	60 days
<input type="checkbox"/> SDAccel OpenCL Development Environment: 30 Day Node Locked Evaluation Lice...	Certificate - Evaluation	Node	1/1	Current	30 days
<input checked="" type="checkbox"/> Vivado Design Suite: HL WebPACK 2015 and Earlier License	Certificate - No Charge	Node	1/1	Current	None
<input checked="" type="checkbox"/> ISE WebPACK License	Certificate - No Charge	Node	1/1	Current	None
<input type="checkbox"/> Xilinx MicroBlaze/All Programmable SoC Software Development Kit - Standalone	Certificate - No Charge	Node	1/1	Current	None
<input type="checkbox"/> PetaLinux Tools License	Certificate - Evaluation	Node	1/1	Current	365 days
<input type="checkbox"/> Vivado HLS Evaluation License	Certificate - Evaluation	Node	1/1	Current	30 days

Generate Node-Locked License

Click on "Next"

Generate Node License

*Fields marked with an asterisk * are required.*

1 PRODUCT SELECTION

Product Selections	Product	Type	Available Seats	Subscription End Date	Requested Seats	Borrowed Seats
<input checked="" type="checkbox"/>	ISE WebPACK License	No Charge	1/1	None	1	

2 SYSTEM INFORMATION

License	Node
Host ID * ?	Any

3 COMMENTS

Comments ?

Click on "Next"

Generate Node License

4 REVIEW LICENSE REQUEST

Product Selections

Product	Subscription End Date	Available Seats	Requested Seats
ISE WebPACK License		1/1	1

System Information

License	Node
Host ID	ANY

Note: WebTalk is always enabled for WebPACK users. WebTalk ignores user and install preference when a bitstream is generated using the WebPACK license. If a design is using a device contained in WebPACK and a WebPACK license is available, the WebPACK license will always be used. To get additional information on WebTalk, go to www.xilinx.com/webtalk.

Check your email box : You should have received an email from Xilinx, Inc. with a licence file attached and named "Xilinc.lic".

Retrieve this file on your PC and keep it in safe place.

Congratulations

Your new license file has been successfully generated and e-mailed to [REDACTED] You can also view the license file under the Manage Licenses tab.

Please add this sender (xilinx.notification@entitlenow.com) to your address book.

License File Details
Node License
Host ID: ANY

Products
ISE WebPACK License (No Charge): 1 seats

Go back to the licence manager (which is still running).

Set "Load License" and click on "Copy License"

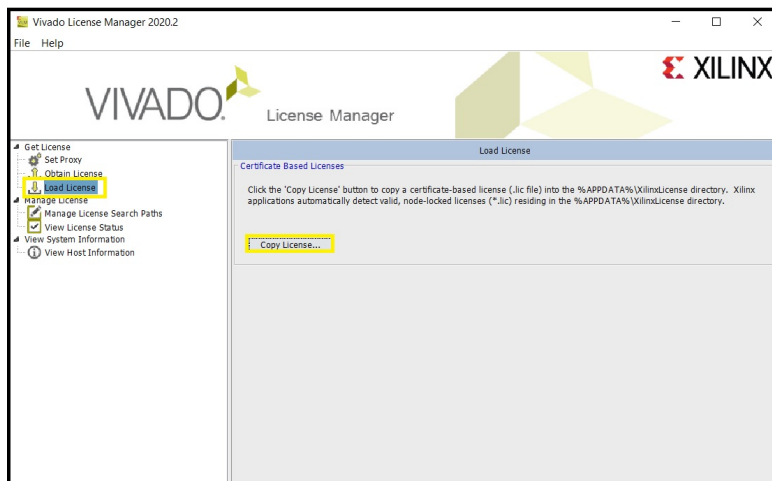

Browse to the location where you saved "Xilinx.lic" file, select it and click on "Open".

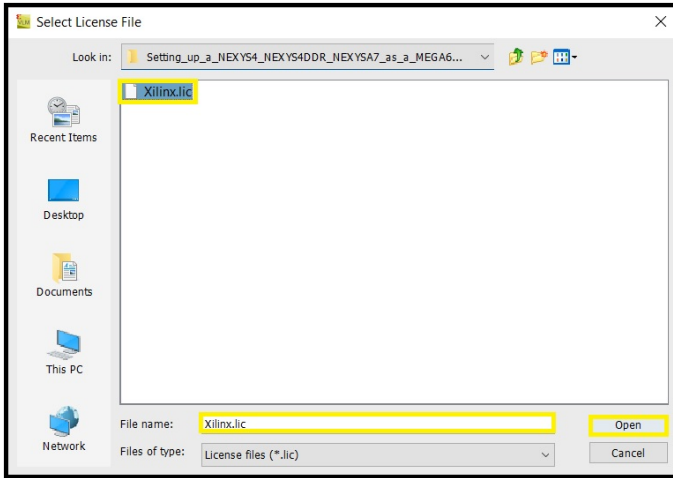

Click on "OK" and close the Vivado licence manager.

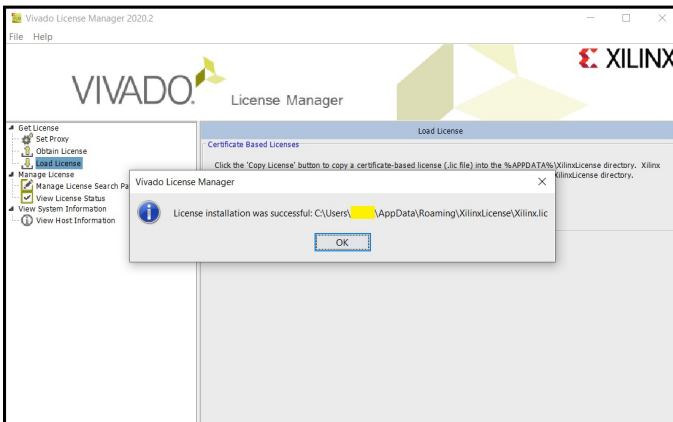

Your Vivado software is registered and you can now use it.

INSTALLING THE FTDI DRIVERS

The FTDI drivers are needed in order for your PC to communicate with the hardware's JTAG port and serial comms port (note that the single physical USB connection made to your PC actually provides these two ports).

Linux drivers

Some Linux users have reported that they have found the FTDI drivers to be installed within their Linux distributions out-of-the-box, while others have found they needed to run this extra command after installing Vivado:

```
cd /opt/Xilinx/Vivado/2018.3/data/xicom/cable_drivers/lin64/install_script/install_drivers
sudo ./install_drivers
```

Windows drivers

Download the following archive to install the drivers:

- https://www.ftdichip.com/Drivers/CDM/CDM21228_Setup.zip

Unzip the file **CDM21228_Setup.zip**, you get the file **CDM21228_Setup.exe**.

Warning:

Before installing the drivers, it is imperative to switch off the Nexys4 board and to disconnect the USB cable from the PC.

Review the devices already installed before the installation:

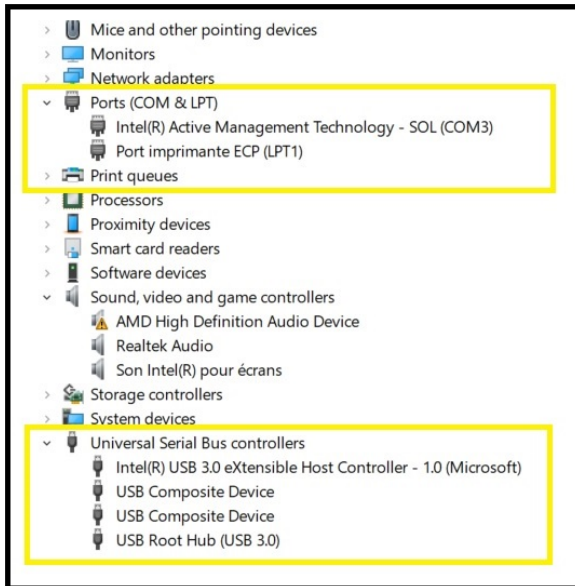

Run the file CDM21228_Setup.exe as administrator:

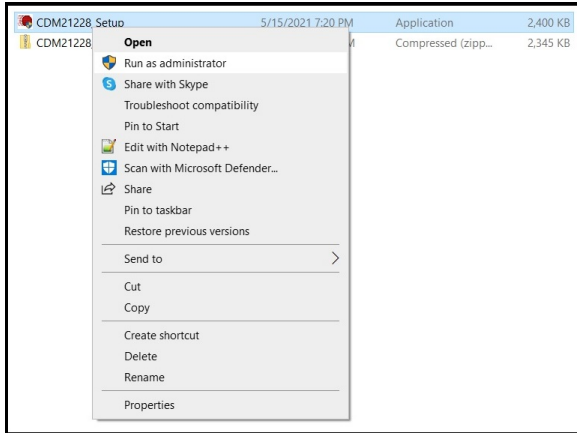

Confirm that you want to run the program.

Click on "Extract".

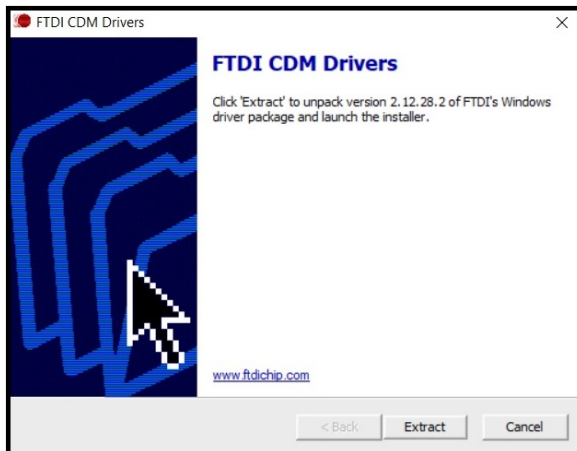

Click on "Next >"

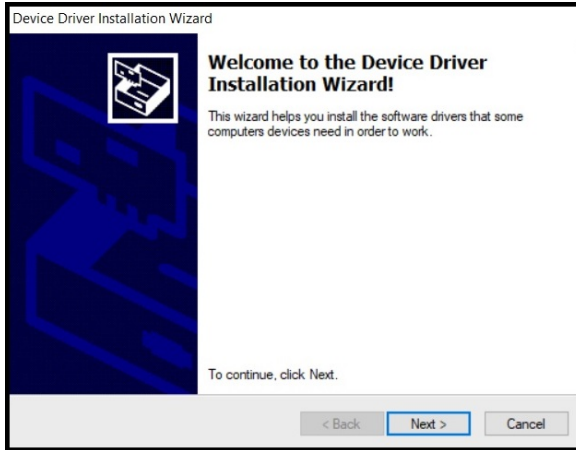

Accept the agreement and click on "Next >"

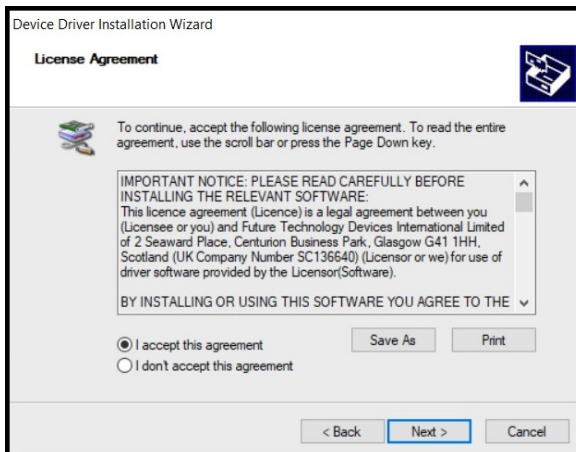

The installation of the drivers starts.

Click on "Finish".

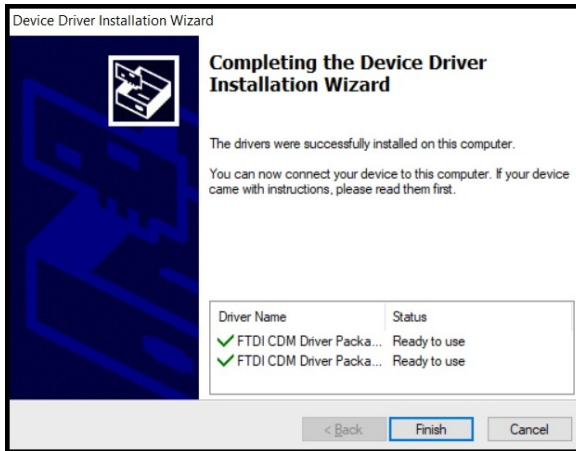

Connect the USB cable to a USB port on the PC **without turning on the Nexys4 board**.
Connecting the USB cable triggers the appearance of new devices.

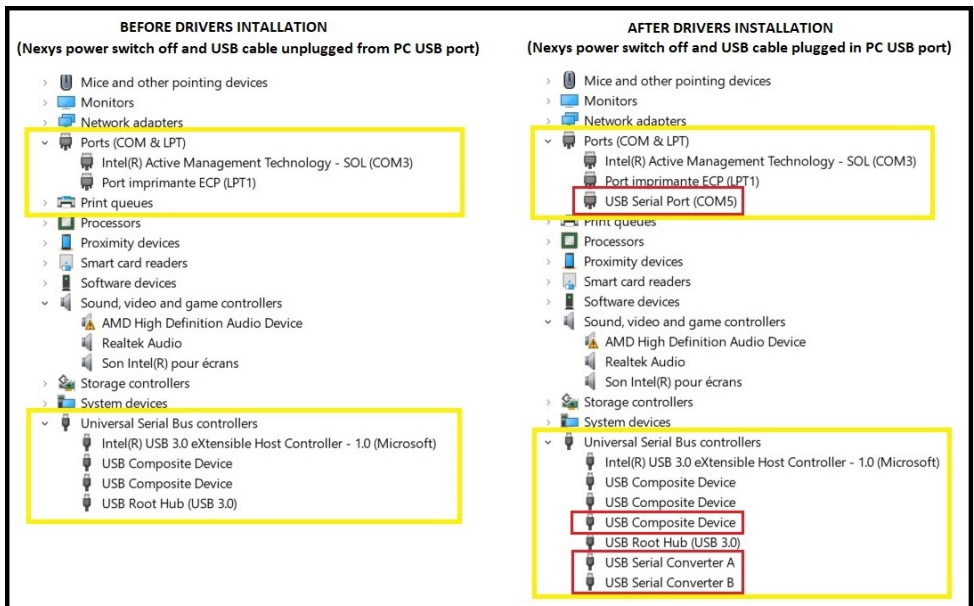

- An additional COM port has been installed: **This is the COM port that will be used to communicate with the Nexys4 board.**
- An additional USB composite device has been installed.

- Two USB serial converter devices have been installed.

At this point the Nexys4 board has still not been powered up.

For more information about the installed drivers, you can download the corresponding documentation:

- https://ftdichip.com/wp-content/uploads/2020/08/AN_396-FTDI-Drivers-Installation-Guide-for-Windows-10.pdf
- https://ftdichip.com/wp-content/uploads/2021/01/AN_119_FTDI_Drivers_Installation_Guide_for_Windows7.pdf

FLASHING THE MAIN FPGA USING VIVADO

Firstly, to clarify that when we say 'flashing the FPGA', in reality, what we mean is that we are flashing the QSPI flash memory chip that the FPGA makes use of upon startup in order to quickly load the bitstream from.

The diagram below shows two common pathways that the FPGA can load bitstreams at startup:

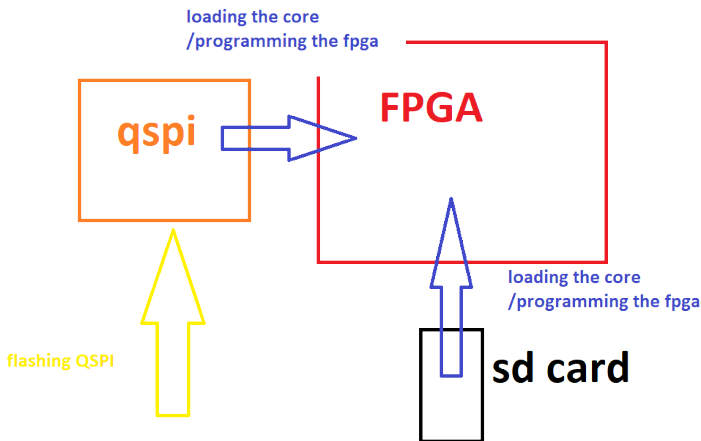

- We can first flash a bitstream/core-file onto the QSPI flash memory chip, and the FPGA can load this quickly at power-up. Flashing the QSPI is quite slow, but the reward of a fast boot-up time is an advantage.

- We can drop a bitstream file onto our SD card and let the FPGA load it (somewhat more slowly) from there at power-up. This way is popular amongst Nexys4 board users, and allows them to swap/upgrade bitstreams quickly.

In this section, we describe the pathway that makes use of the QSPI.

Many of the following steps in this section are applicable not only to MEGA65 R2/R3 owners, but Nexys4 board owners too. There are a few points of distinction along the way that readers will be made aware of.

If you choose to proceed, you will need a functioning installation of Xilinx's Vivado software, and the FTDI drivers installed, as described in the earlier sections.

You will also need to download or build an .mcs bitstream file (and optional .prm checksum verification file) that you intend flash onto the QSPI chip via Vivado. See Bitstream files for more details on where such files can be downloaded.

For MEGA65 R2/R3 owners:

You will need a TE0790-03 JTAG programming module. It is also necessary to have dip-switches 1 and 3 in the ON position and dip-switches 2 and 4 in the OFF position on the TE-0790. With your MEGA65 disconnected from the power, the TE-0790 must be installed on the JB1 connector which is located between the floppy data cable and the audio jack. The gold-plated hole of the TE-0790 must line up with the screw hole below. The mini-USB cable will then connect on the side towards the 3.5" floppy drive. The following image shows the correct position: The TE0790 is surrounded by the yellow box, and the dip-switches by the red box. Dip-switch 1 is the one nearest the floppy data cable.

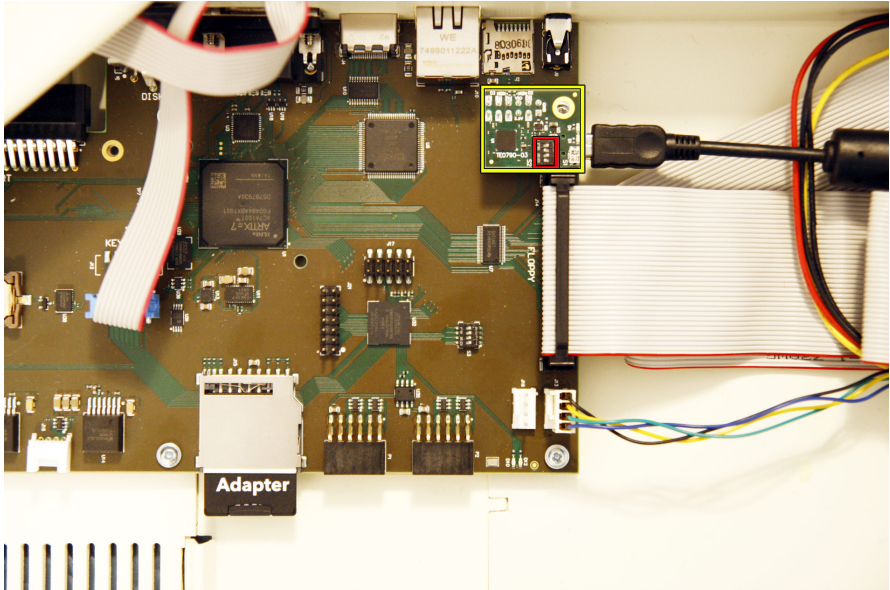

For Nexys4 board owners:

Simply connect your micro-usb cable between your Nexys4 board and your PC via the port labeled 'PROG UART' (J6), as shown:

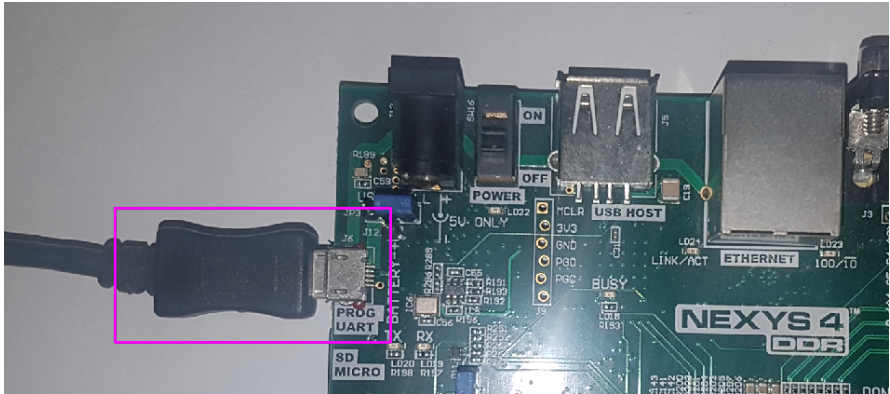

Also, set J1 jumper to the QSPI position:

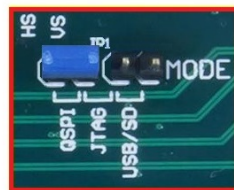
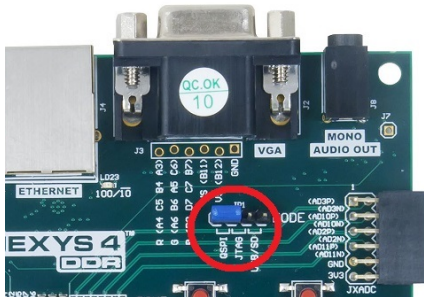

JP1

- Connect your non-8-bit computer to the FPGA programming device using the appropriate USB cable.
- Switch the MEGA65 computer ON.
- Open Vivado.

Step 1a: Create a new Vivado project with "File", "Project", "New...".

NOTE: On future occasions that you need to flash the QSPI, just re-open this project (no need to create a new project each time).

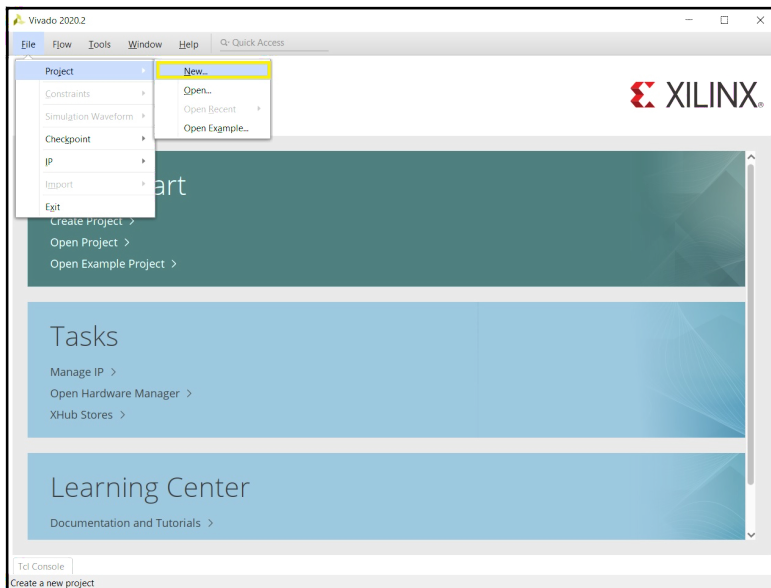

Step 1b: The 'New Project' wizard appears. Click on "Next":

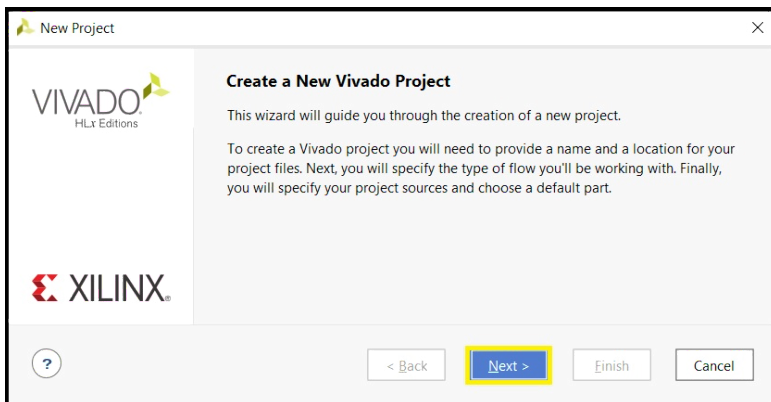

Step 1c: Name your project and choose the location you like, then click on "Next":

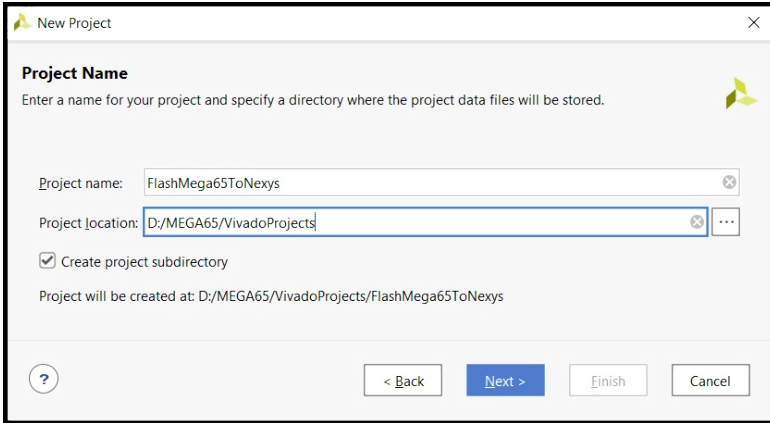

New Project

Project Name
Enter a name for your project and specify a directory where the project data files will be stored.

Project name: FlashMega65ToNexys

Project location: D:/MEGA65/VivadoProjects

Create project subdirectory

Project will be created at: D:/MEGA65/VivadoProjects/FlashMega65ToNexys

< Back **Next >** Finish Cancel

Step 1d: Keep the default selected options and click on "Next":

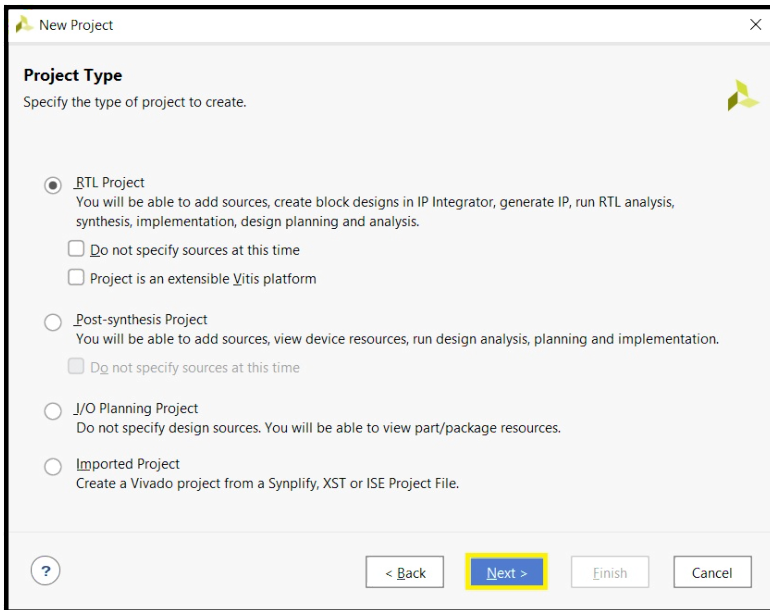

New Project

Project Type
Specify the type of project to create.

RTL Project
You will be able to add sources, create block designs in IP Integrator, generate IP, run RTL analysis, synthesis, implementation, design planning and analysis.

Do not specify sources at this time

Project is an extensible Vitis platform

Post-synthesis Project
You will be able to add sources, view device resources, run design analysis, planning and implementation.

Do not specify sources at this time

J/O Planning Project
Do not specify design sources. You will be able to view part/package resources.

Imported Project
Create a Vivado project from a Synplify, XST or ISE Project File.

< Back **Next >** Finish Cancel

Step 1e: Do not add any sources, keep the default selected options and click on "Next":

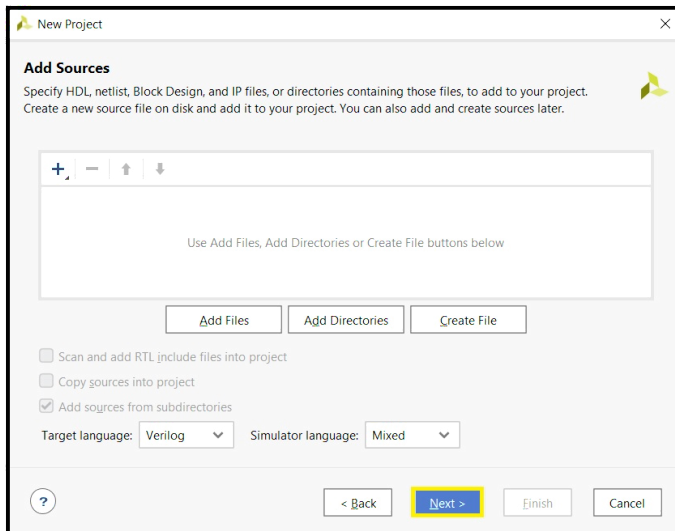

Step 1f: Keep the default selected options and click on "Next":

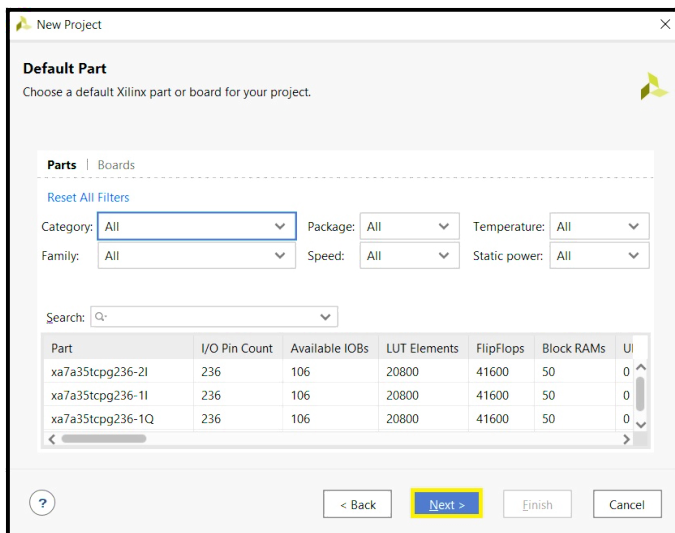

Step 1g: Click on "Finish":

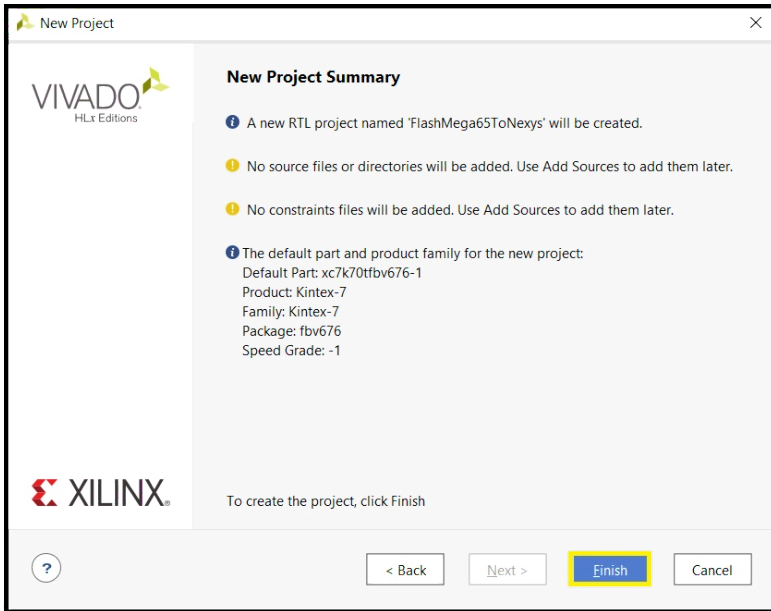

Step 2: In the left column, select "Open Hardware Manager" at the very bottom.

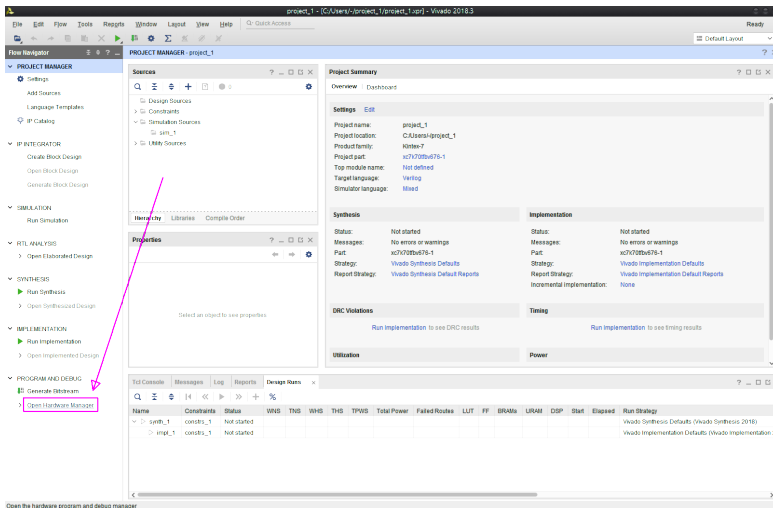

Step 3: Connect to the FPGA:
Under "Open Hardware Manager", choose "Open Target", then "Auto Connect".

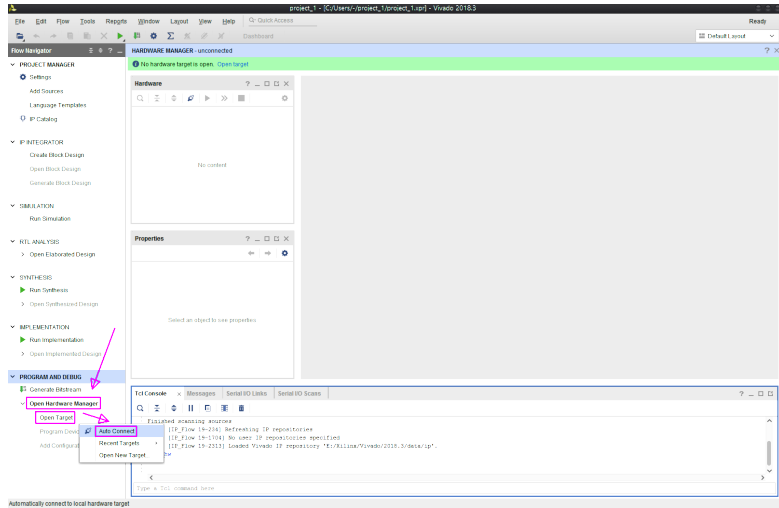

Step 4: Wait a moment, "Connecting to server..." should automatically close without dropping an error to the console.

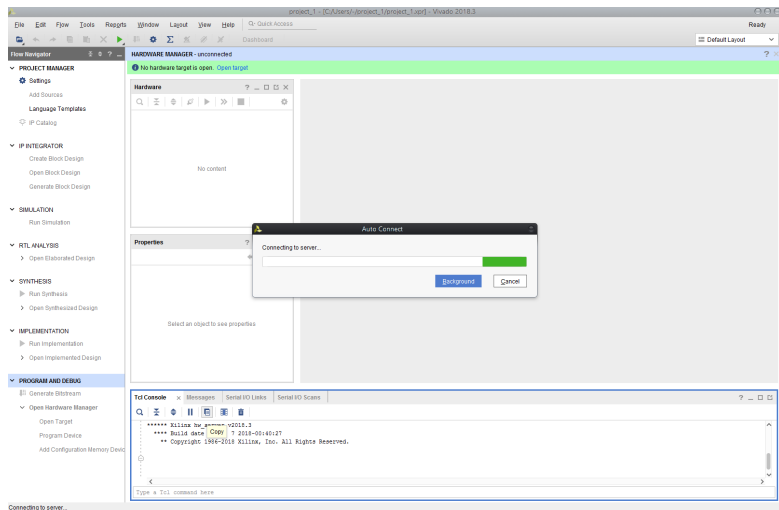

Step 5: Under "Open Hardware Manager", choose "Add Configuration Memory Device", then:

- For MEGA65R3: "xc7a200t_0"
- For Nexys4 and MEGA65R2: "xc7a100t_0".

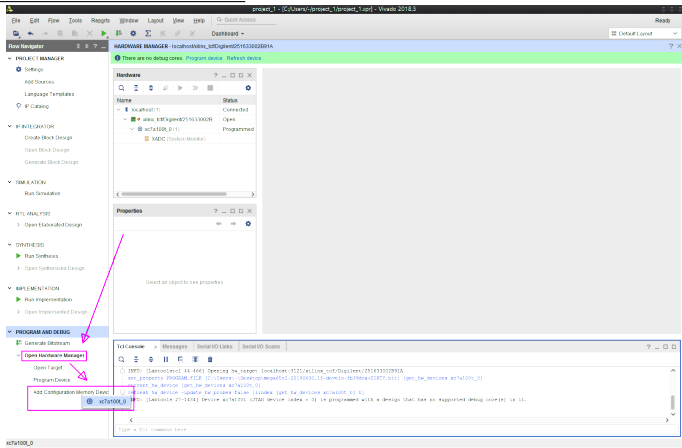

Step 6a: Select Memory Part:

In the newly opened dialogue:

- For MEGA65R2/R3: type "S25fl256s" (without quotes), then select "s25fl256sxxxxx0-spi-x1_x2_x4" (the upper one) and click "OK".
- For Nexys4: type "S25fl128s" (without quotes), then select "s25fl128sxxxxx0-spi-x1_x2_x4" (the upper one) and click "OK".

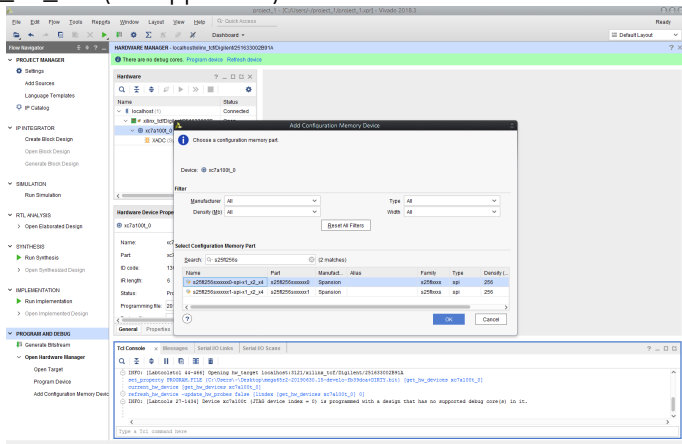

Step 6b: Click on "OK" to confirm you want to program the configuration memory device now.

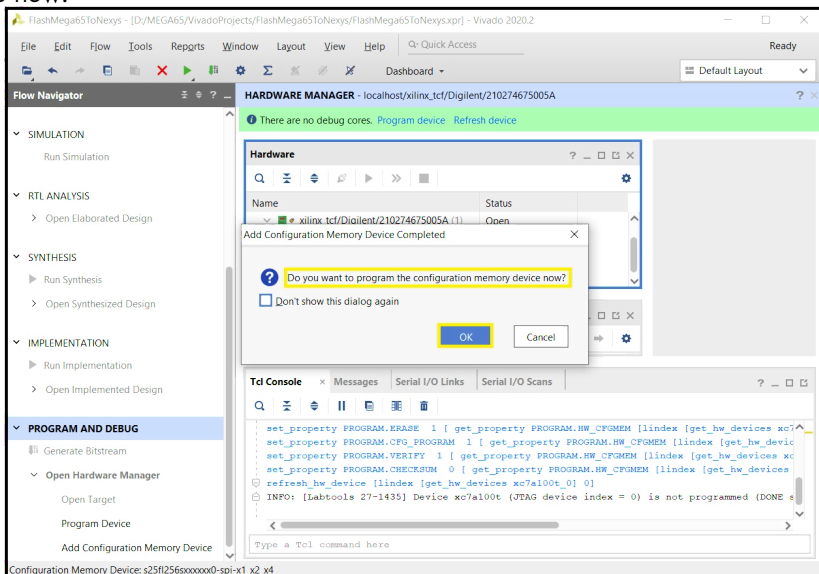

Step 6c: If you do not see such a popup, or wish to reprogram the QSPI on a future occasion, in "Hardware" window, right click on the memory configuration and select "Program Configuration Memory Device":

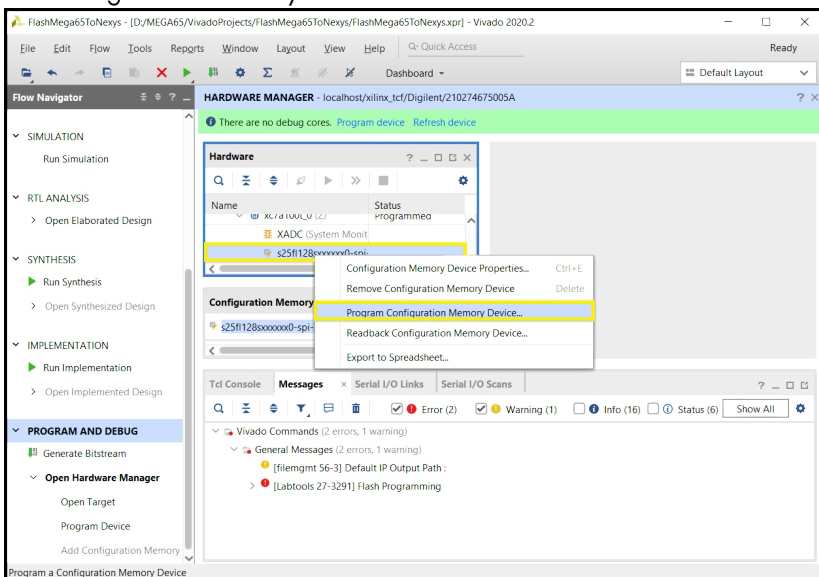

Step 7: Set programming options:

In the next dialogue, set the "Configuration file" to the path of your ".mcs" bitstream file. You can also optionally set the "PRM file" field to the path of your ".prm" file. Leave all other parameters as they are (see screenshot below).

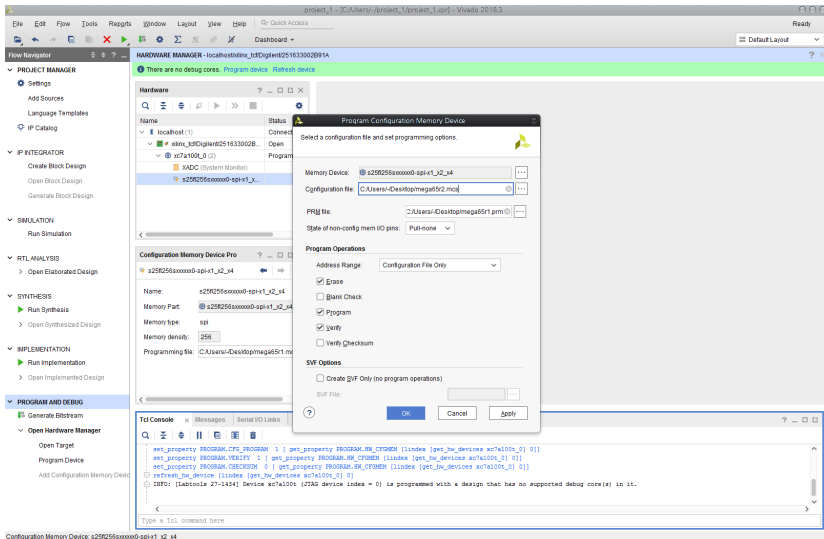

Step 8: Patiently wait for the programming to finish. This can take several minutes as the Vivado software erases and then reprograms the flash memory that is used to initialise the FPGA on power-up.

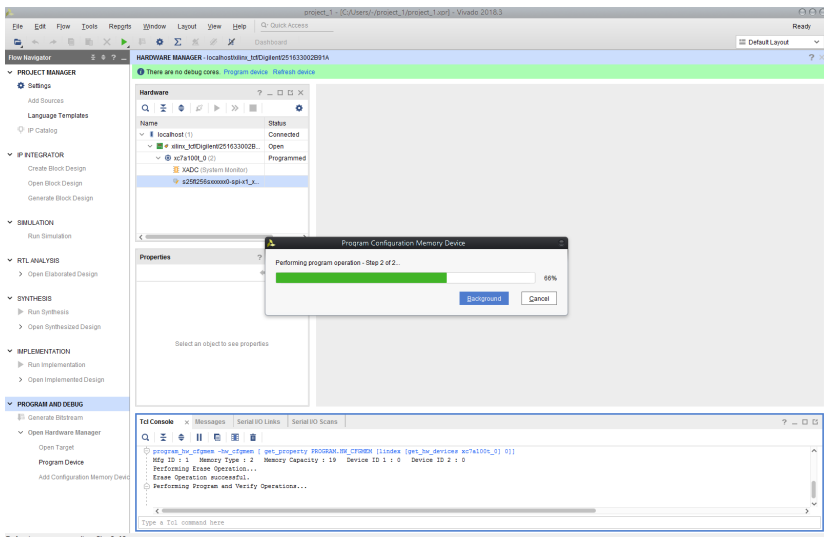

Step 9: If your screen looks like the screenshot below, your new bitstream has been successfully flashed into Slot0 of your QSPI flash memory!

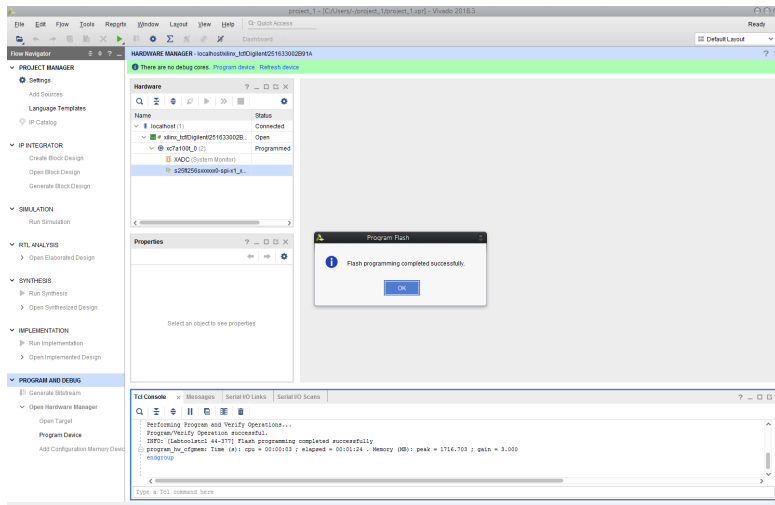

Step 10: If you want to reflash the FPGA, you might find the "Add Configuration Memory Device" option in step 5 greyed out. Instead, select "s25fl256sxxxxxx0-spi-x1_x2_x4" in the "Hardware" window, press right mouse button and select "Program Configuration Memory Device" to flash.

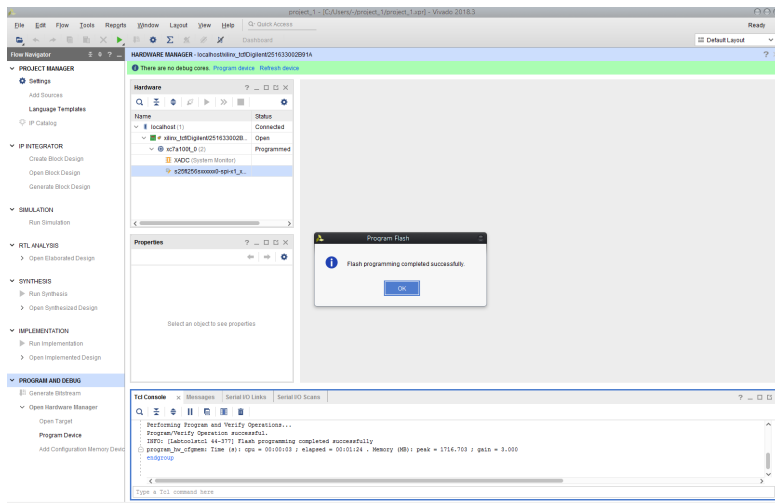

FLASHING THE CPLD IN THE MEGA65'S KEYBOARD WITH LATTICE DIAMOND

If you choose to proceed, you will need a TE0790-03 JTAG programming module and a functioning installation of Lattice Diamond Programmer software. This can be done on either Windows or Linux, but in both cases you will need to install any necessary USB drivers. It is also necessary to have dip-switches 1 and 3 in the ON position and dip-switches 2 and 4 in the OFF position on the TE-0790. With your MEGA65 disconnected from the power, the TE-0790 must be installed on the JB1 connector, which is located between the floppy data cable and the audio jack. The gold-plated hole of the TE-0790 must line up with the screw hole below. The mini-USB cable will then connect on the side towards the 3.5" floppy drive. The following image shows the correct position: The TE0790 is surrounded by the yellow box, and the dip-switches by the red box. Dip-switch 1 is the one nearest the floppy data cable.

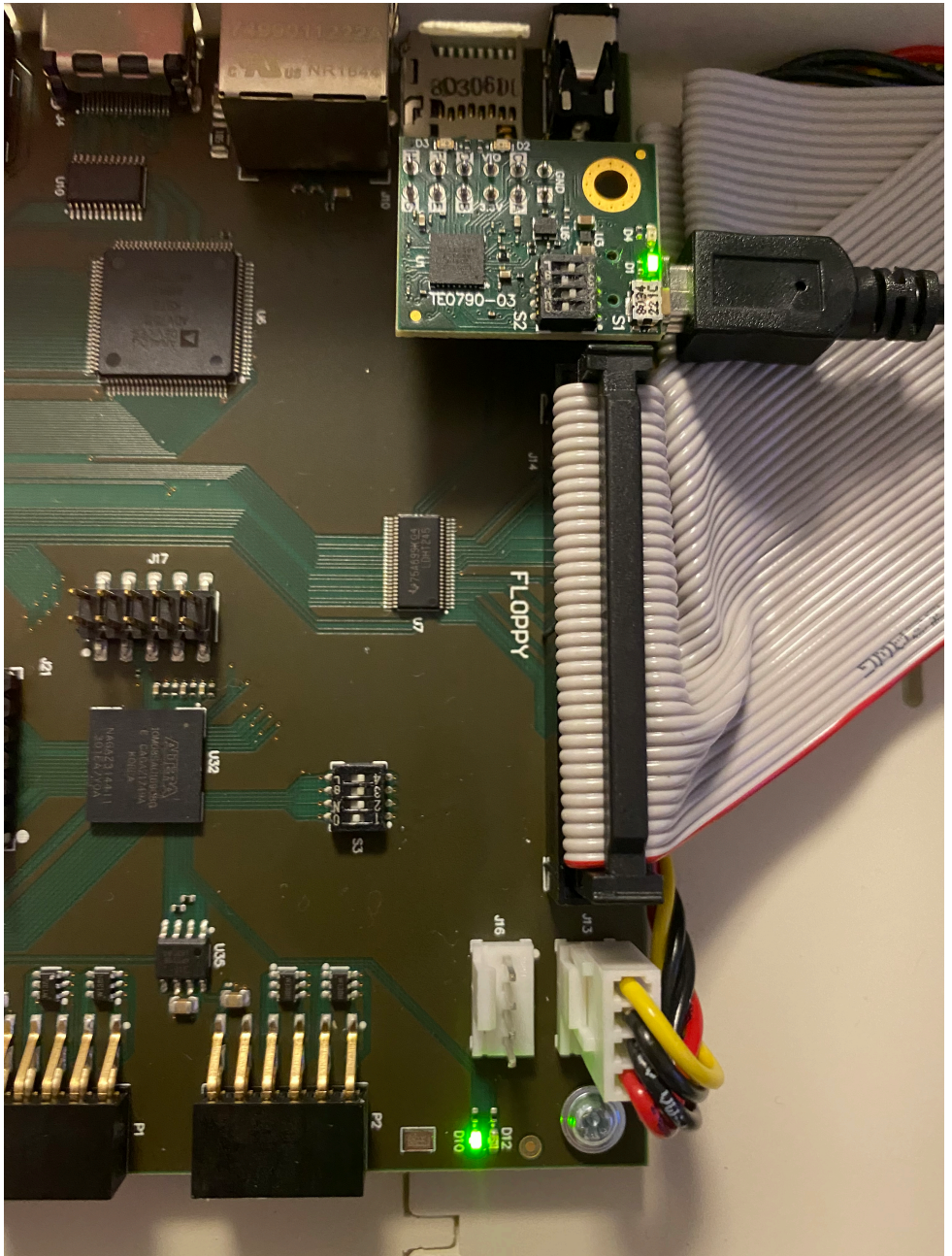

On the PCB R2 MEGA65 mainboard, dip switch 1 (the one nearest to the user sitting in front of the machine) must be in the ON position. The other switches must be OFF. The keyboard will go into "ambulance mode" (blue flashing lights) when set correctly.

Connect your non-8-bit computer to the FPGA programming device using a mini-USB cable. Switch the MEGA65 computer ON. Open the Diamond Programmer which can be downloaded from the Internet.

Step 1: Open DIAMOND PROGRAMMER:

Select "Create a new project from a JTAG scan". If entry under "Cable:" is empty, click "Detect Cable".

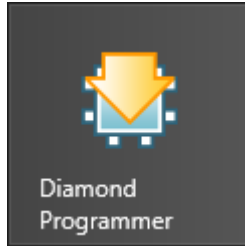

Step 2: Create a new project:

If dialog "Programmer: Multiple Cables Detected" appears, select the first entry ("Location 0000") and click "OK".

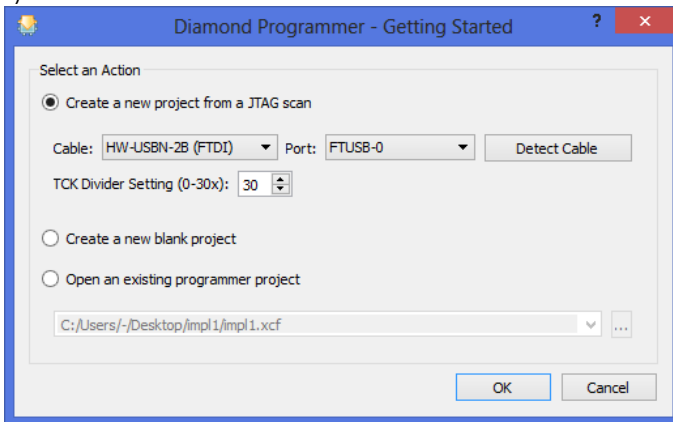

Step 3: Select cable:

You have now created a new project which should display "MachXO2" under "Device Family" and "LCMXO2-1200HC" under "Device"

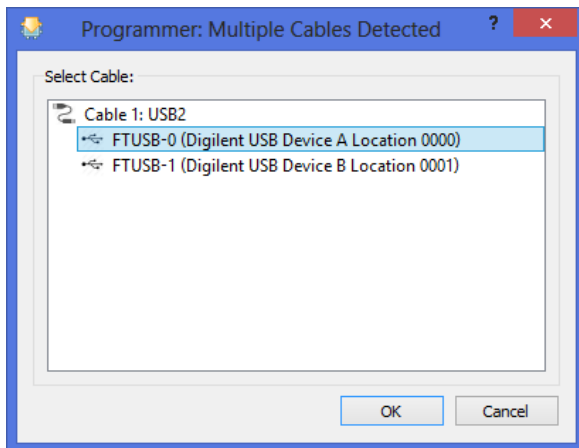

Step 4: New Diamond Programmer project:

Choose "File" then "Open File" to load the Diamond Programmer project with the MEGA65 keyboard firmware update.

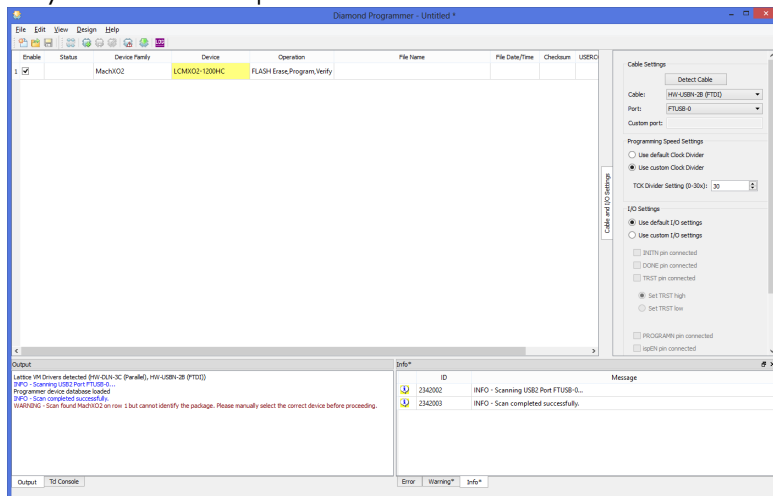

Step 5: Open project:

Navigate into the folder with the extracted MEGA65 keyboard firmware files you have received and select the file ending with ".xcf".

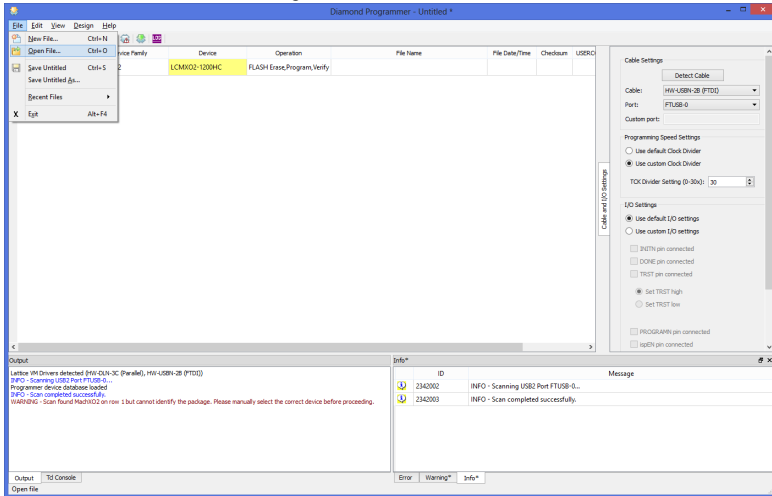

Step 6: Select project file:

Click the three dots under "File Name" to set the correct path and find the file ending with ".jed".

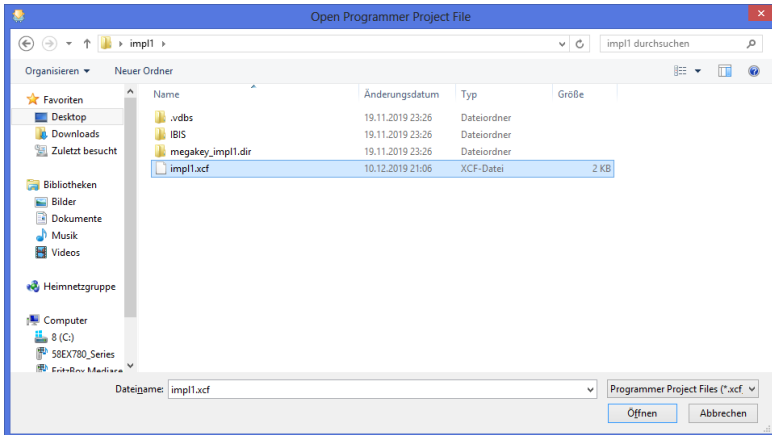

Step 7: Choose correct path of .jed file:
 Select the file ending with ".jed" and click "OK".

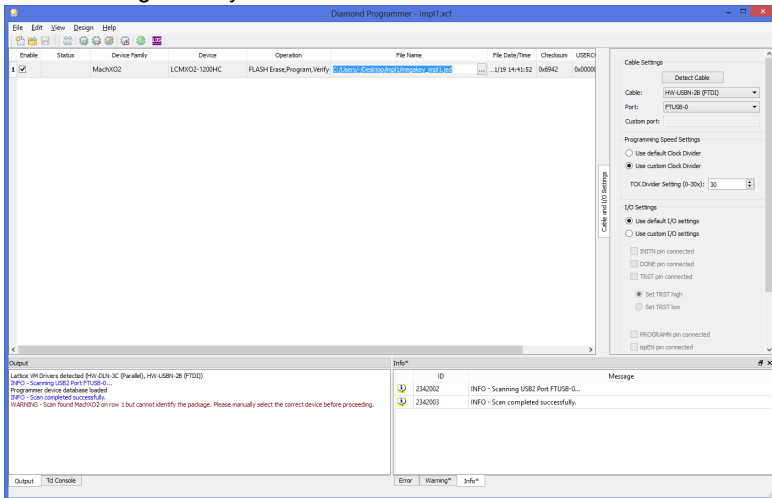

Step 8: Select .jed file:
 Click on the icon with the green arrow facing down "PROGRAM", which looks similar to the Diamond Programmer program icon.

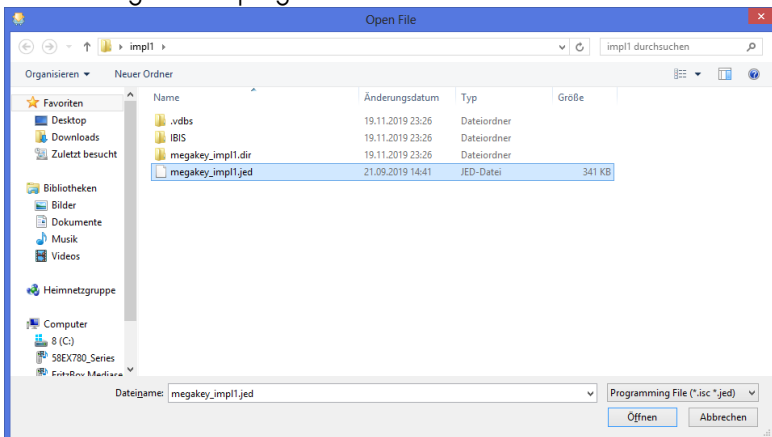

Step 9: Select cable:

After a moment the Output window should display "INFO - Operation: successful." and the "Status" cell should go green (does not always happen).

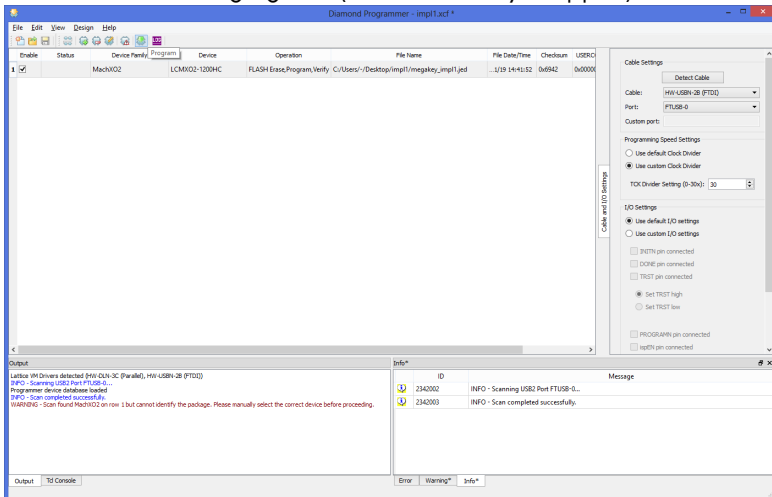

Step 10: Operation successful:

You have now successfully flashed the MEGA65 keyboard. If you wish you can now save the project for later use.

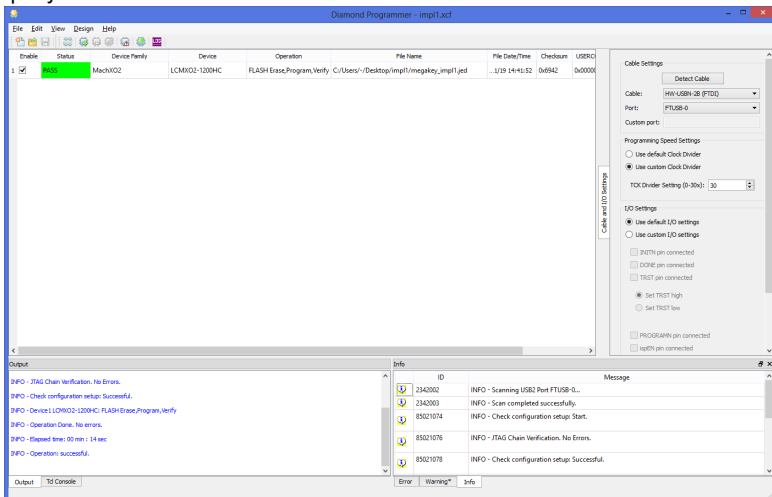

FLASHING THE MAX10 FPGA ON THE MEGA65'S MAINBOARD WITH INTEL QUARTUS

If you choose to proceed, you will need a TEI0004 - Arrow USB Programmer2 module with TEI0004 driver installed and a functioning installation of Quartus Prime Programmer Lite Edition. This can be done on either Windows or Linux, but in both cases you will need to install any necessary USB drivers. With your MEGA65 disconnected from the power, the TEI0004 must be installed on the J17 connector, which is located between the floppy data cable and the ARTIX 7 FPGA on the Mainboard. The micro-USB port of the TEI0004 must face in the opposite direction of the HDMI and LAN sockets, towards the trap door. The following image shows the correct position.

On the PCB R2 MEGA65 mainboard, all dip switches must be in the OFF position. The main FPGA of the MEGA65 R2 must not contain a valid bitstream. See section Flashing the main FPGA using Vivado on how to erase the bitstream from the main FPGA.

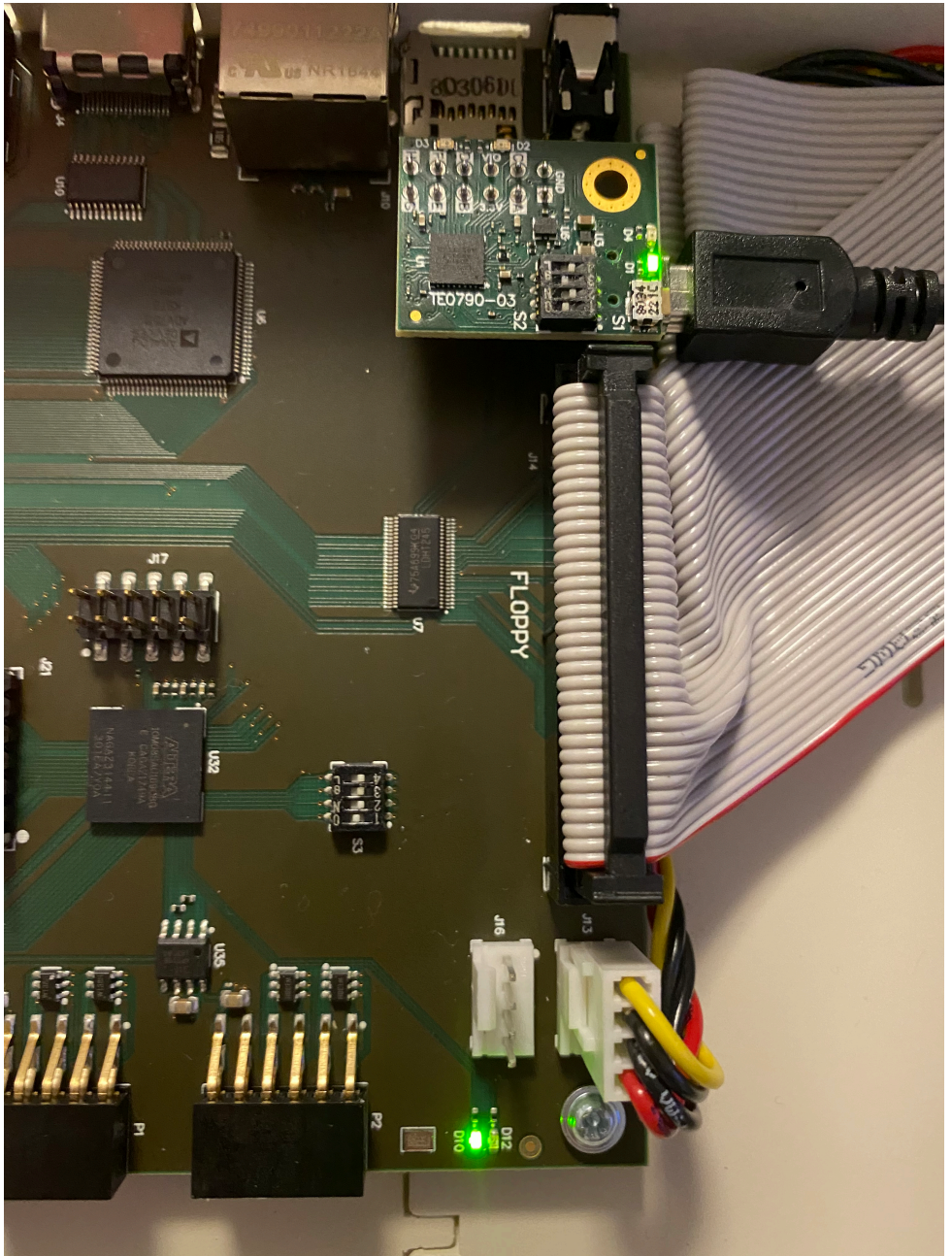

Connect your non-8-bit computer to the FPGA programming device using a micro-USB cable. Open Quartus Prime Programmer Lite Edition, which can be downloaded from the Internet.

Step 1: Open Quartus Prime Programmer Lite Edition:

Click the "Hardware Setup" button in the top left corner of the Quartus Prime Programmer window.

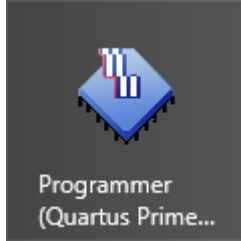

Step 2: Enter Hardware Setup:

In the newly appeared window under "Currently selected hardware" choose "Arrow-USB-Blaster". If "Arrow-USB-Blaster" does not appear, verify cable and drivers being correctly installed.

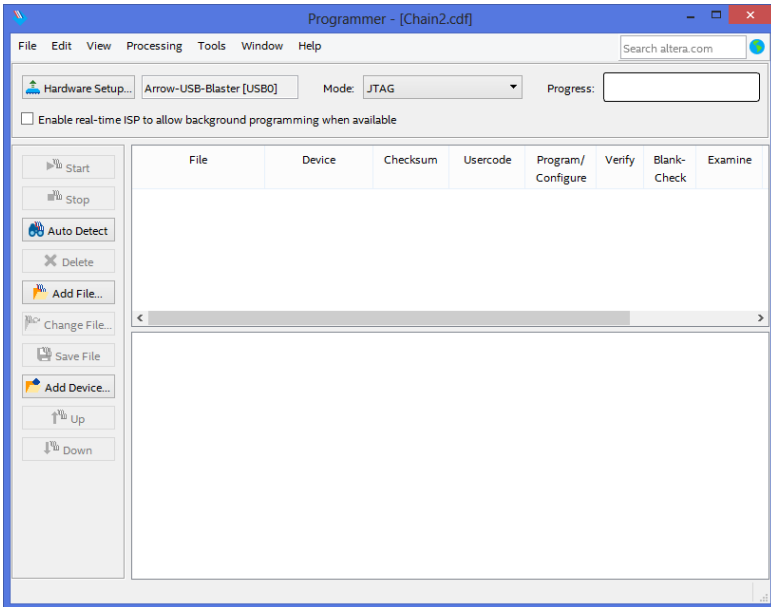

Step 3: Select Arrow USB-Blaster:

Click the "Add File" button from the left row and choose the latest ".pof" file. Then click "Open".

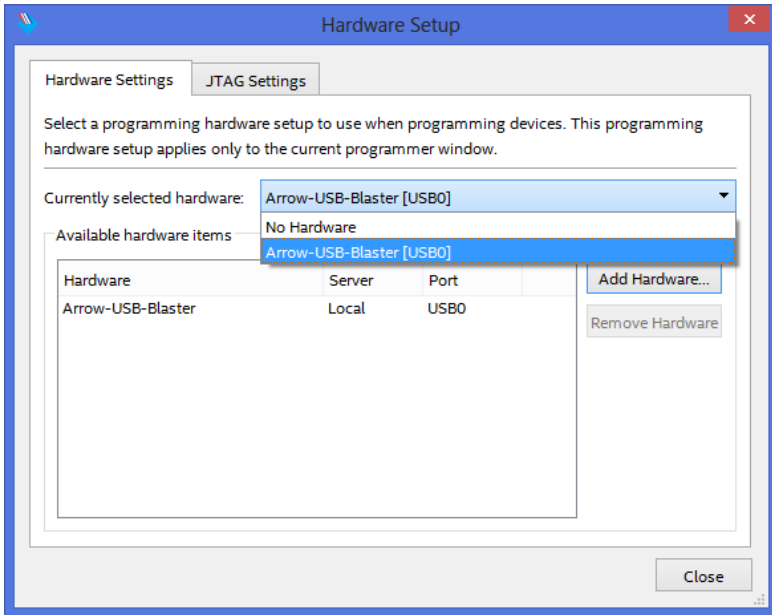

Step 4: Select Programming File:

Tick at least the three boxes under "Program/Configure". Also enabling all boxes under "Verify" and "Blank-Check" will make the process more reliable.

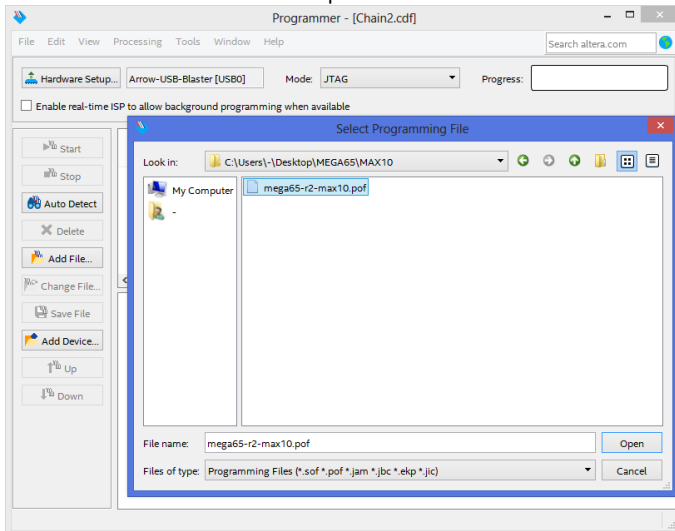

Step 5: Select Program/Configure Options:

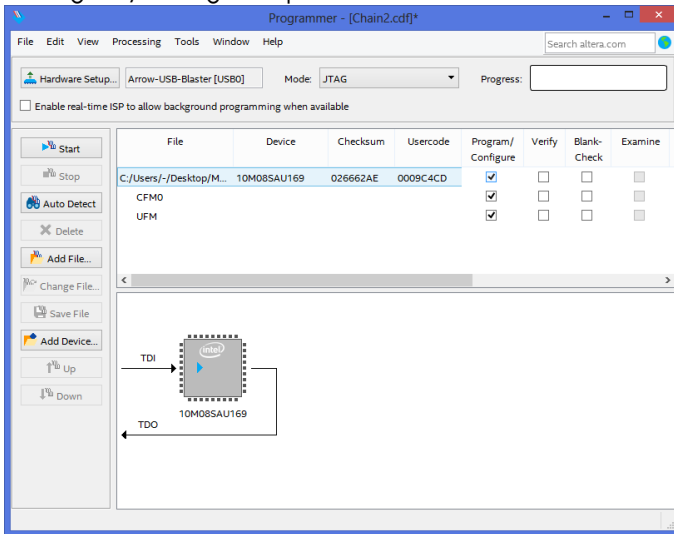

While keeping the Reset-Button pressed, switch the MEGA65 computer ON. The keyboard will go into “ambulance mode” (blue flashing lights). If it does not, the main FPGA is not empty - restart the whole process.

Now click on “Start” in the left row of buttons. The progress bar in the top right corner should quickly go to 100 percent and turn green. You have now successfully updated your MAX10 FPGA.

If you receive an error message instead, make sure the main FPGA bitstream has been erased and that you did not release the reset-button on the MEGA65 beforehand. Switch off the MEGA65 and restart this step.

Step 6: Programming successful:

The screenshot displays the Quartus Prime Programmer Lite Edition interface. The main window title is "Quartus Prime Programmer Lite Edition - [Chain1.cdf]*". The hardware setup is configured for "Arrow-USB-Blaster [USB0]" in "JTAG" mode, with a progress bar indicating "100% (Successful)".

The central table lists the files and their programming status:

File	Device	Checksum	Usercode	Program/Configure	Verify	Blank-Check	Examine	Security Bit	Erase	ISP CLAMP
C:/Users/-/Desktop/ou...	10M08SAU169	026662AE	0009C4CD	<input checked="" type="checkbox"/>	<input checked="" type="checkbox"/>	<input checked="" type="checkbox"/>	<input type="checkbox"/>	<input type="checkbox"/>	<input type="checkbox"/>	<input type="checkbox"/>
CFM0				<input checked="" type="checkbox"/>	<input checked="" type="checkbox"/>	<input checked="" type="checkbox"/>	<input type="checkbox"/>	<input type="checkbox"/>	<input type="checkbox"/>	<input type="checkbox"/>
UFM				<input checked="" type="checkbox"/>	<input checked="" type="checkbox"/>	<input checked="" type="checkbox"/>	<input type="checkbox"/>	<input type="checkbox"/>	<input type="checkbox"/>	<input type="checkbox"/>

Below the table, a diagram shows the connection between the TDI (Test Data In) and TDO (Test Data Out) pins of the 10M08SAU169 device. The TDI pin is connected to the 'mst1' pin of the Arrow-USB-Blaster, and the TDO pin is connected to the 'mst2' pin.

The bottom panel shows the Messages window with the following log entries:

- 209061 Ended Programmer operation at Sat Mar 21 20:46:25 2020
- 209024 Programming device 1
- 209011 Successfully performed operation(s)
- 209061 Ended Programmer operation at Sat Mar 21 20:46:34 2020

The status bar at the bottom indicates "System (22) Processing".

APPENDIX

T

Trouble shooting

- **Hardware**
- **Vivado**
- **mega65_ftp**

HARDWARE

No lights when powering on

If there are occasions when your MEGA65 display any lights when powering on, they relate to having certain Digital Video devices plugged in while the MEGA65 is off, that don't provide enough power for the keyboard's CPLD to be properly powered on, but enough to stop it properly resetting when the MEGA65 powers on. Removing the Digital Video cable and switching the machine off and on again fixes the issue.

VIVADO

RAM requirements

```
INFO: [Synth 8-256] done synthesizing module 'ram32x1024' [/home/...]
INFO: [Synth 8-256] synthesizing module 'charrom' [/home/...]
/opt/Xilinx/Vivado/2019.2/bin/loader: line 280: 2317 killed
WARNING: [Vivado 12-8222] Failed run(s) : 'synth\_1'
ERROR: Application Exception: failed to launch run 'impl\_1'
       due to failures in the following run(s):
       synth\_1
       These failed run(s) need to be reset prior to launching 'impl\_1' again.
```

This error is due to Vivado crashing because the machine doesn't have enough RAM for Vivado to run. Vivado requires at least 4GB to synthesise the MEGA65 target, but 8GB is better.

MEGA65_FTP

Missing Library

```
/usr/bin/ld: cannot find -lncurses
collect2: error: ld returned 1 exit status
Makefile:474: recipe for target 'bin/mega65_ftp' failed
make: *** [bin/mega65_ftp] Error 1
```

This error occurs when the ncurses library is missing from the computer when building the mega65_ftp program. To rectify this issue you will need to ensure that you install this dependency.

```
sudo apt-get install libncurses5-dev libncursesw5-dev
```

APPENDIX



Model Specific Features

- **Detecting MEGA65 Models**
- **MEGA65 Desktop Computer, Revision 3
onwards**
- **MEGA65 Desktop Computer, Revision 2**
- **MEGAphone Handheld, Revisions 1 and 2**
- **Nexys4 DDR FPGA Board**

DETECTING MEGA65 MODELS

While we expect the production version of the MEGA65 to be a stable platform, there may still be cases where detecting which hardware your program is running on. This is particularly important for the MEGA65 system software, which may need to initialise different pieces of hardware on the different models. Also, because there is a hand-held version of the MEGA65 already in development, which uses a slightly different resolution screen (800x480 instead of 720x576), and has a touch screen but no hardware keyboard, you may wish to make programs that adapt to the hand-held devices in a more graceful way. For example, you may enable touch-screen input, and restructure on-screen selections to be large enough to be easily activated by a finger.

The simple way to detect which model of MEGA65 your program is running on, is to check the \$D629 register (but don't forget to enable the MEGA65 I/O personality first, via \$D02F). This contains an 8-bit hardware identifier. The following values are currently defined:

\$01 (1) MEGA65 R1

\$02 (2) MEGA65 R2

\$03 (3) MEGA65 R3

\$21 (33) MEGAsphone (hand-held) R1

\$40 (64) Nexys4 PSRAM

\$41 (65) Nexys4DDR

\$42 (66) Nexys4DDR with widget board

\$FD (253) QMTECH Wukong A100T board

\$FE (254) Simulation run of VHDL

MEGA65 DESKTOP COMPUTER, REVISION 3 ONWARDS

The R3 desktop PCB is very similar to the R2 desktop PCB, with two key changes:

- First, the R3 PCB does not have an ADV7511 digital video driver chip, and so the I2C register block for that device is not present.
- Second, the R3 PCB uses a different on-board amplifier for the PC speakers, which are now present in stereo, rather than mono as on the R2 PCB. The ampli-

fier on the R3 PCB is the same as on the MEGAphone R1 - R2 PCBs. However, the I2C registers are at a different address. On the MEGA65 R3 PCB, the registers are located at \$FFD7 1DC - \$FFD7 1EF.

MEGA65 DESKTOP COMPUTER, REVISION 2

The desktop version of the MEGA65 contains a Real-Time Clock (RTC), which also includes a small amount of non-volatile memory (NVRAM) that retains its value, even if the computer is turned off and disconnected from its power supply. The NVRAM will hold its values for as long as the internal battery has sufficient charge. This battery also powers the Real-Time Clock (RTC) itself, which includes a 100 year calendar spanning the years 2000 - 2099.

The main trick with accessing the RTC from BASIC, is that we will need to use a MEGA65 Enhanced DMA operation to fetch the RTC registers, because the RTC registers sit above the 1MB barrier, which is the limit of the C65's normal DMA operations. The easiest way to do this is to construct a little DMA list in memory somewhere, and make an assembly language routine that uses it. Something like this (using BASIC 65 in C65-mode):

```
10 RESTORE 110:FOR I=0 TO 43:READ A$:POKE 1024+I,DEC(A$):NEXT BANK 128:SYS 1042
20 S=PEEK(1056):M=PEEK(1057):H=PEEK(1058)
30 D=PEEK(1059):MM=PEEK(1060):Y=PEEK(1061)+DEC("2000")
40 IF H AND 128 GOTO 80
50 PRINT "THE TIME IS ";RIGHT$(HEX$(H AND 63),2);":";RIGHT$(HEX$(M),2);":";RIGHT$(HEX$(S),2)
60 IF H AND 32 THEN PRINT "PM": ELSE PRINT "AM"
70 GOTO 90
80 PRINT "THE TIME IS ";RIGHT$(HEX$(H AND 63),1);":";RIGHT$(HEX$(M),2);":";RIGHT$(HEX$(S),2)
90 PRINT "THE DATE IS ";RIGHT$(HEX$(D),2);":";RIGHT$(HEX$(MM),2);":";HEX$(Y)
100 END
110 DATA 00,0F,81,00,00,00,08,00,10,71,8D,20,04,00,00,00,00
120 DATA A9,47,8D,2F,D0,A9,53,8D,2F,D0,A9,00,8D,02,D7,A9
130 DATA 04,8D,01,D7,A9,00,8D,05,D7,60
```

This program works by setting up a DMA list in memory at 1,024 (\$0400) (unused normally on the C65), followed by a routine at 1,042 (\$0412) which ensures we have MEGA65 registers un-hidden, and then sets the DMA controller registers appropriately to trigger the DMA job, and then returns. The rest of the BASIC code PEEKs out the RTC

registers that the DMA job copied to 1,024 - 1,032 (\$0400 - \$0407), and interprets them appropriately to print the time.

The curious can use the MONITOR command, and then D1012 to see the routine.

If you want a running clock, you could replace line 100 with GOTO 10. Doing that, you will get a result something like the following:

```
THE TIME IS 10:05:36 PM
THE DATE IS 20.02.2020
THE TIME IS 10:05:36 PM
THE DATE IS 20.02.2020
THE TIME IS 10:05:36 PM
THE DATE IS 20.02.2020
THE TIME IS 10:05:36 PM
THE DATE IS 20.02.2020
...
```

If you first POKE0,65 to set the CPU to full speed, the whole program can run many times per second. There is an occasional glitch, if the RTC registers are read while being updated by the machine, so we really should de-bounce the values by reading the time a couple of times in succession, and if the values aren't the same both times, then repeat the process until they are. This is left as an exercise for the reader.

NOTE: These registers are not yet fully documented.

MEGAPHONE HANDHELD, REVISIONS 1 AND 2

The MEGAphone revision 1 and 2 contain a Real-Time Clock (RTC), however this RTC does not include a non-volatile memory (NVRAM) area. Other specific features of the MEGAphone revisions 1 and 2 include a 3-axis accelerometer, including analog to digital converters (ADCs), amplifier controller for loud speakers, and several I2C I/O expanders, that are used to connect the joy-pad and other peripherals. The I/O expanders are fully integrated into the MEGAphone design, and thus there should be no normal need to read these registers directly. The I/O expanders are, however, also responsible for power control of the various sub-systems of the MEGAphone.

NOTE: These registers are not yet fully documented.

NEXYS4 DDR FPGA BOARD

NOTE: These registers are not yet fully documented.

APPENDIX

V

Schematics

- **MEGA65 R3 Schematics**
- **MEGA65 R2 Schematics**

MEGA65 R3 SCHEMATICS

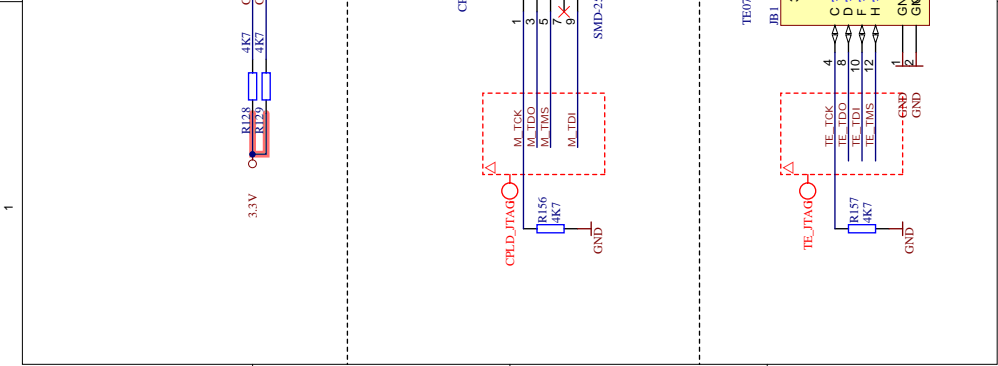
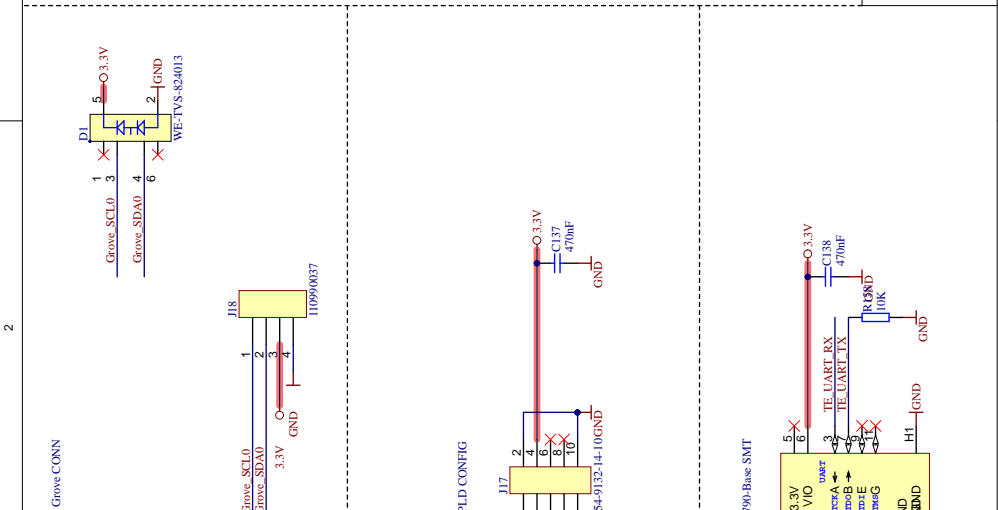
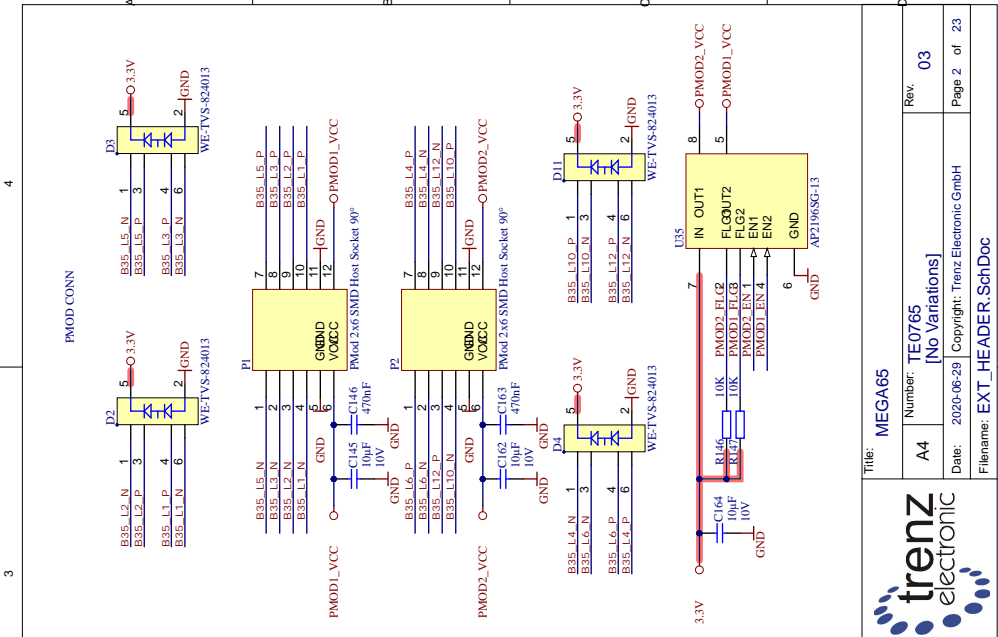

		Title: MEGA65 Number: TE0765 [No Variations]	Rev: 03
A4	Date: 2020-06-29	Copyright: Trenz Electronic GmbH	
Filename: EXT_HEADER_SchDoc		Page 2 of 23	

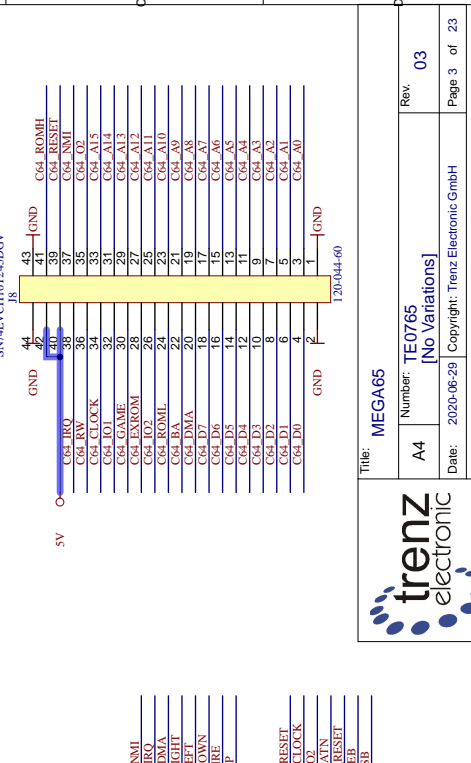
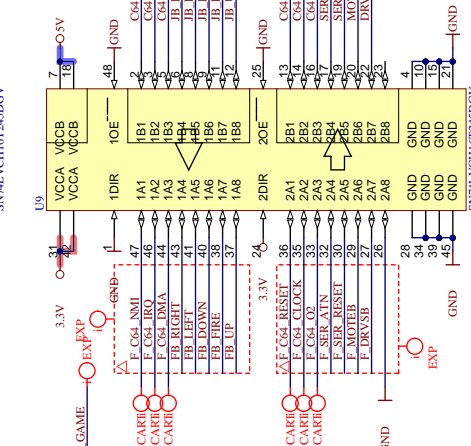
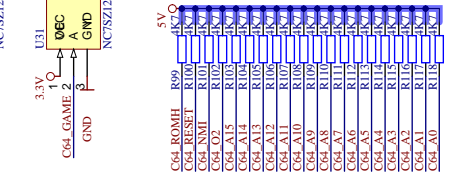
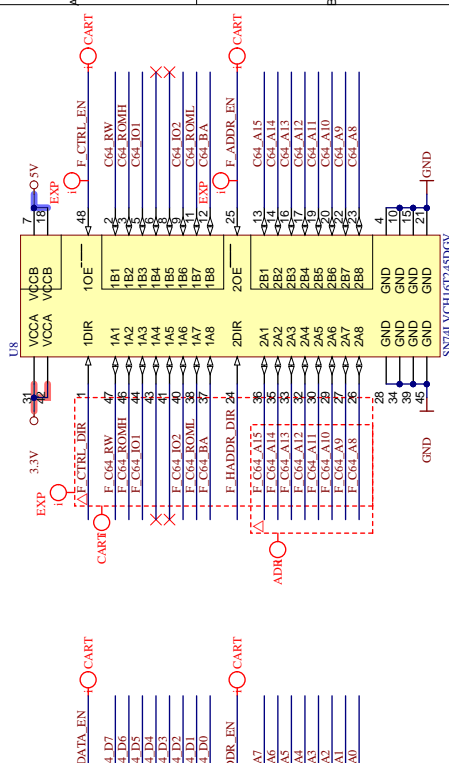
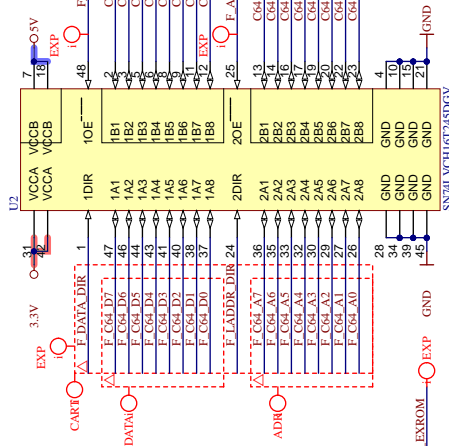
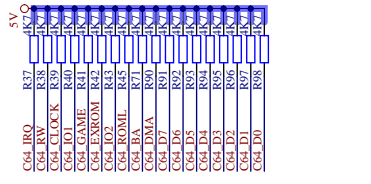

Title: MEGA65
 Number: TE0765
 Date: 2020-06-29 Copyright: Trenz Electronic GmbH
 Filename: EXP_Slot.SchDoc

Rev: 03
 Page 3 of 23

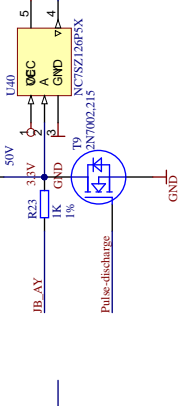
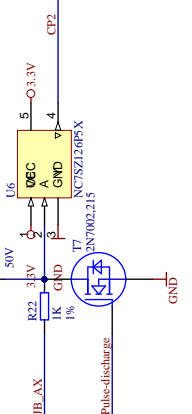
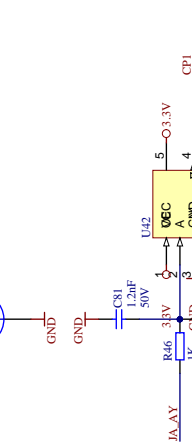
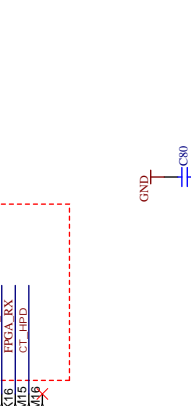
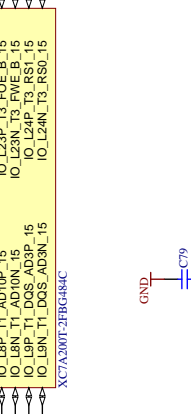
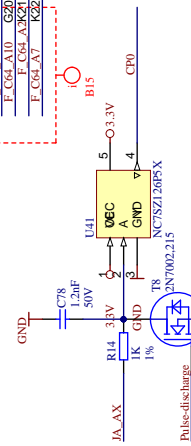
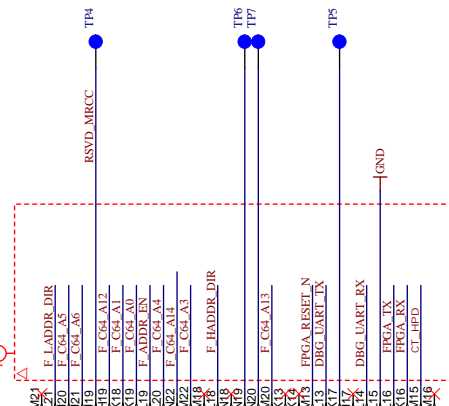
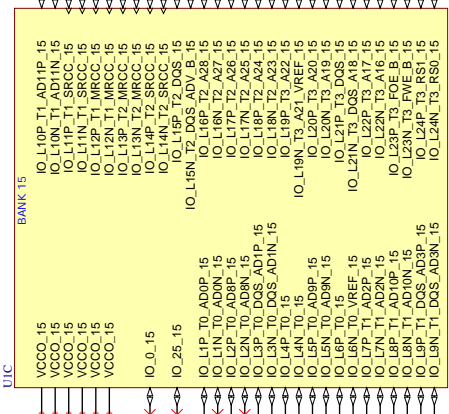
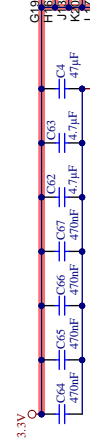

trenz electronic

Title: MEGA65
Number: TE0765 [No Variations]
Date: 2020-06-29 Copyright: Trenz Electronic GmbH
Rev: 03
Page 6 of 23
Filename: B15.SchDoc

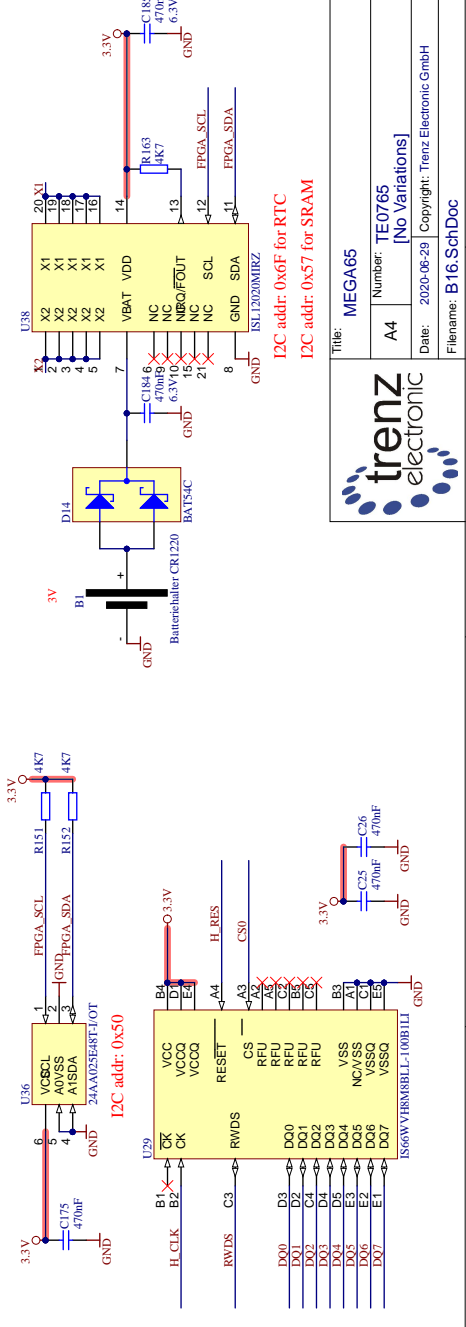
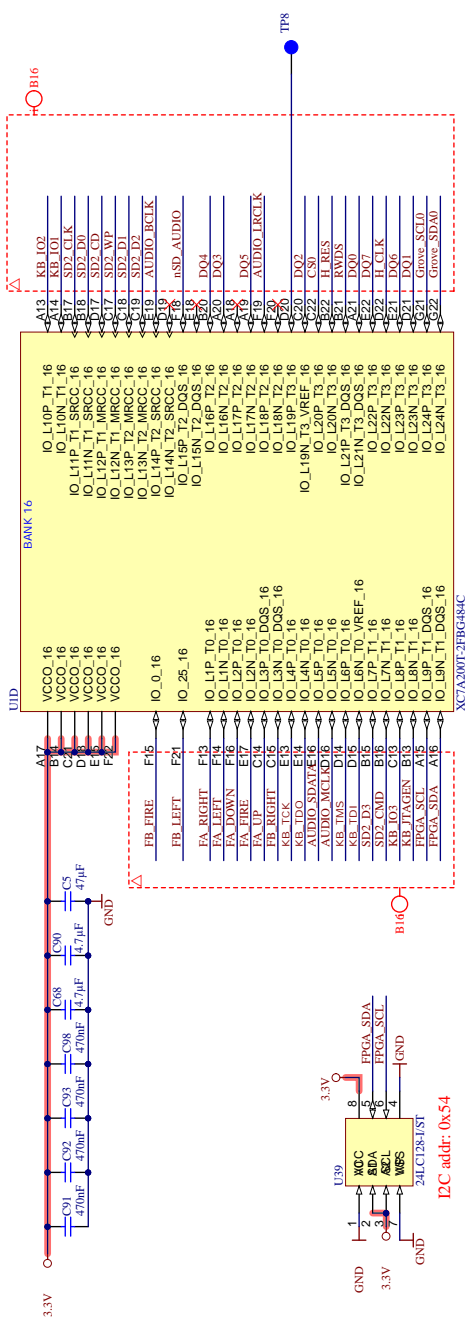

trenz electronic

File: MEGA65
 Number: TE0765 [No Variations]
 Date: 2020-06-29 Copyright: Trenz Electronic GmbH
 Rev: 03
 Page 7 of 23

3.3V

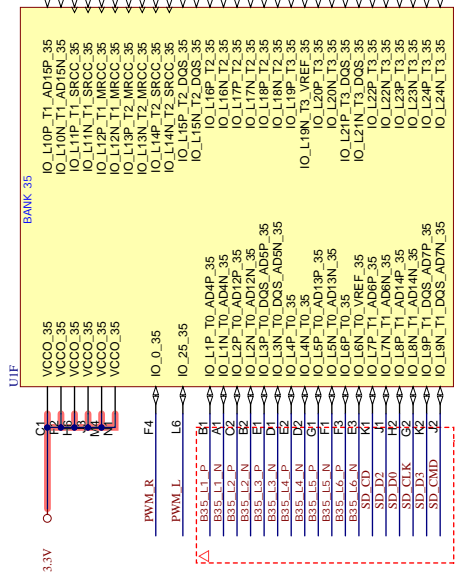
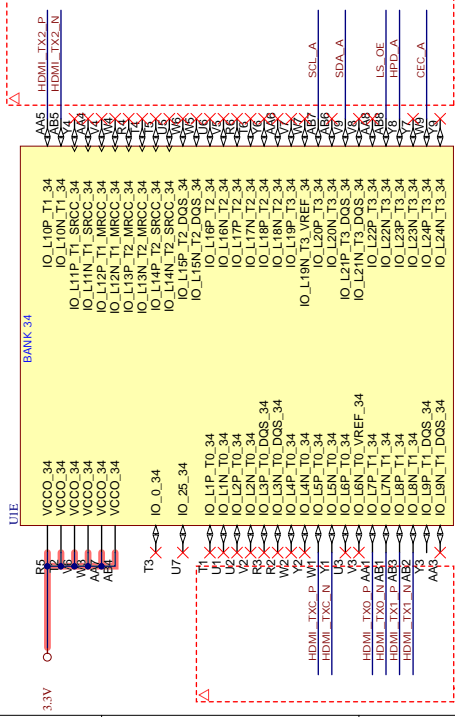
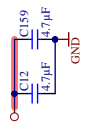

3.3V

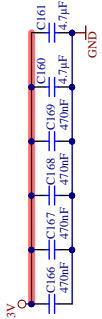

Title: MEGA65

Number: TE0765

[No Variations]

Date: 2020-06-29 Copyright: Trenz Electronic GmbH

Filename: B34.SchDoc

Rev: 03

Page 8 of 23

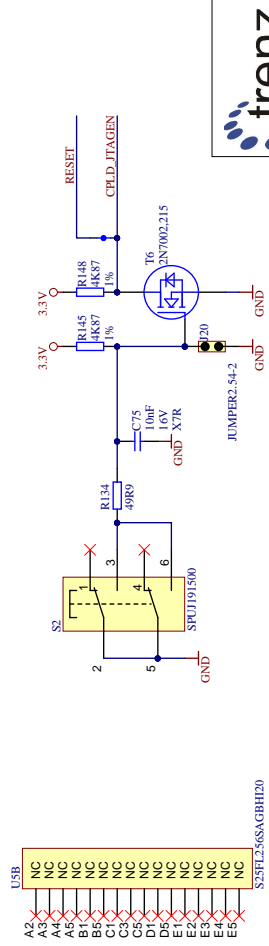
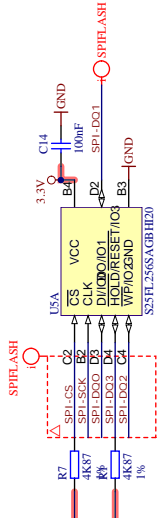
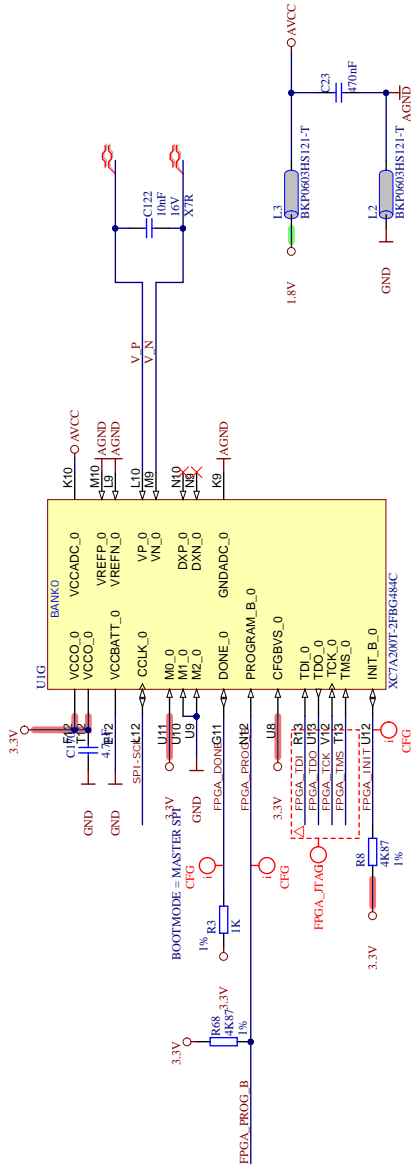

Title: MEGA65
 Number: TE0765
 [No Variations]
 Date: 2020-06-29 Copyright: Trenz Electronic GmbH
 Filename: FPGA-CFG.SchDoc

Rev: 03
 Page 9 of 23

U5B	NC
A2	X
A3	X
A4	X
B1	X
B5	X
C1	X
C3	X
C5	X
D1	X
D2	X
E1	X
E2	X
E3	X
E4	X
E5	X

S25FL256SAGBH20

A A A A

B B B B

C C C C

D D D D

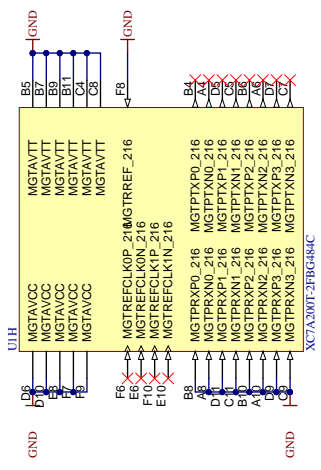



XC7A200T-2FBG484C

Title: MEGA65

Rev: 03	
Number: TE0765 [No Variations]	Page 10 of 23
Date: 2020-06-29	Copyright: Trenz Electronic GmbH
Filename: FPGA-MGT.SchDoc	

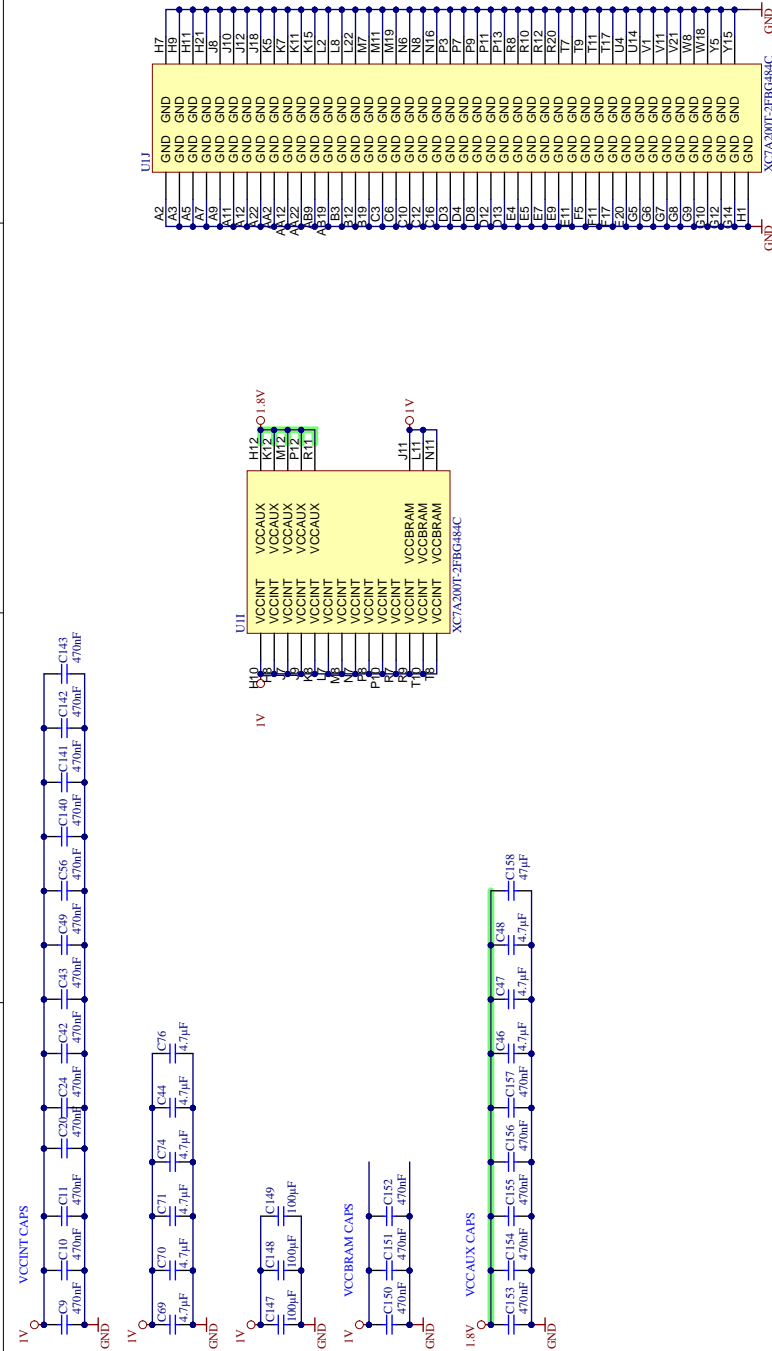





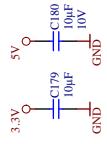
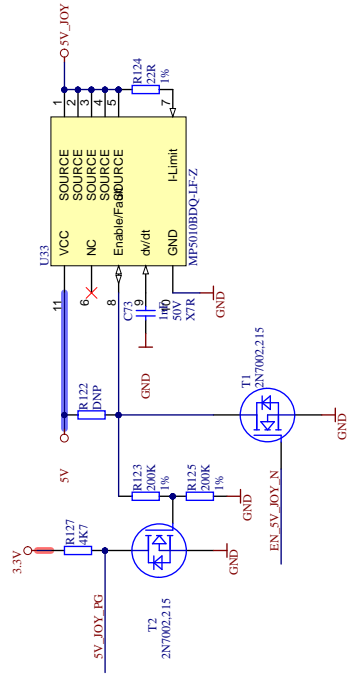
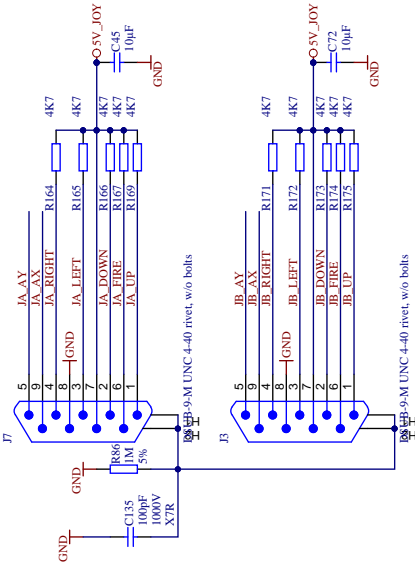
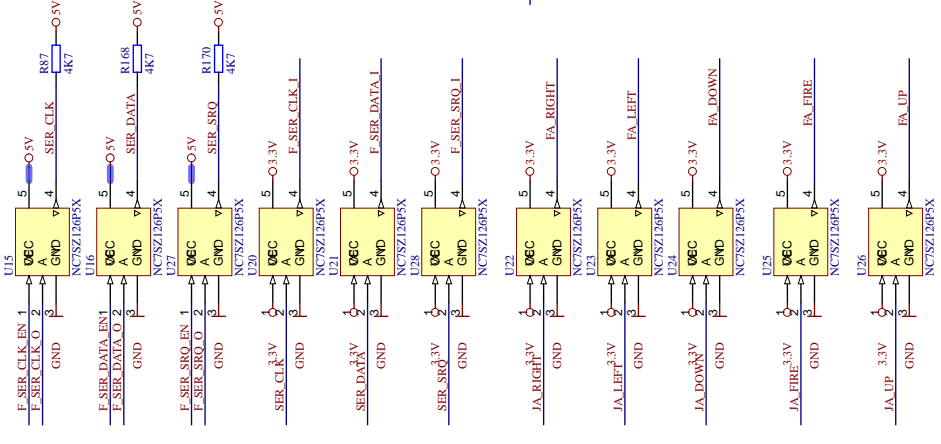
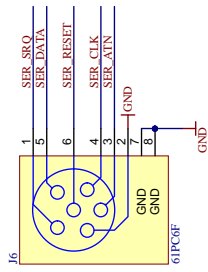

Title: MEGA65	
A4	Number: TE0765 [No Variations]
Date: 2020-06-29 Copyright: Trenz Electronic GmbH	
Filename: FPGA-PWR.SchDoc	

IEC - 1541 style Diskdrive

Title: MEGA65
 Number: TE0765 [No Variations]
 Date: 2020-06-29 Copyright: Trenz Electronic GmbH
 Rev: 03
 Page 13 of 23
 Filename: JOY_SchDoc

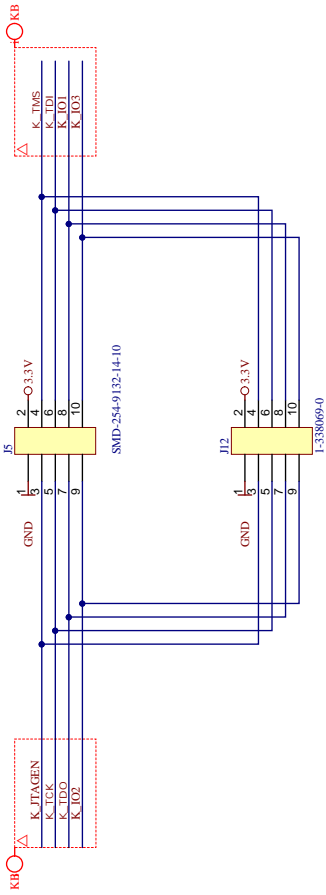

Title: MEGA65

Number: TE0765
[No Variations]

Date: 2020-06-29 Copyright: Trenz Electronic GmbH

Filename: KEYBOARD.SchDoc



Rev: 03

Page 14 of 23

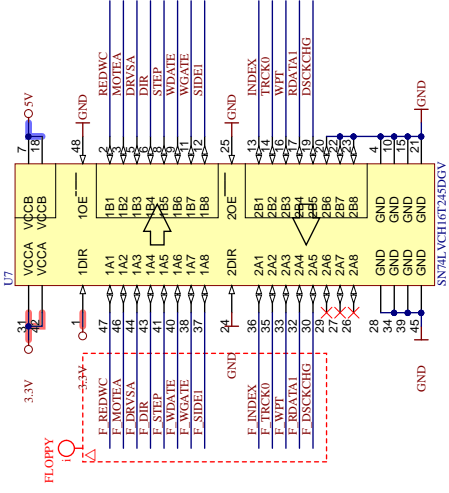
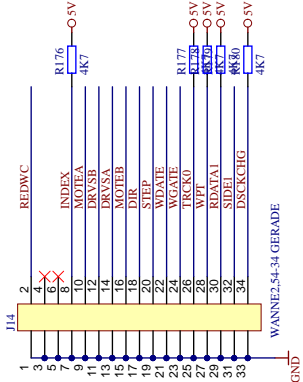
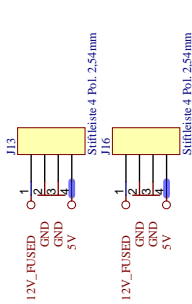

trenz electronic

Title: **MEGA65**

Number: **TE0765**

[No Variations]

Date: 2020-06-29 | Copyright: Trenz Electronic GmbH

Rev: **03**

Page 15 of 23

Filename: Floppy_SchDoc

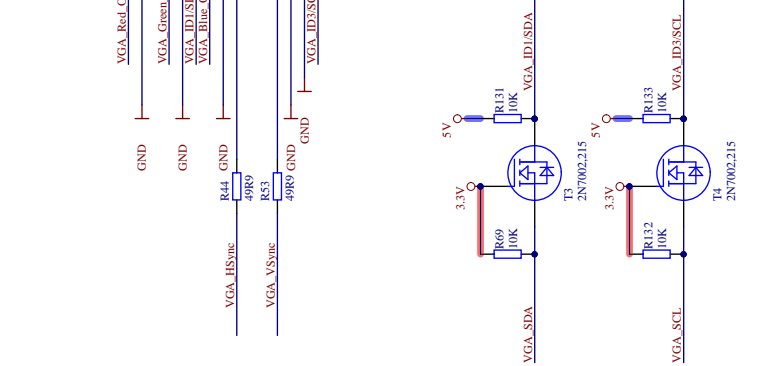
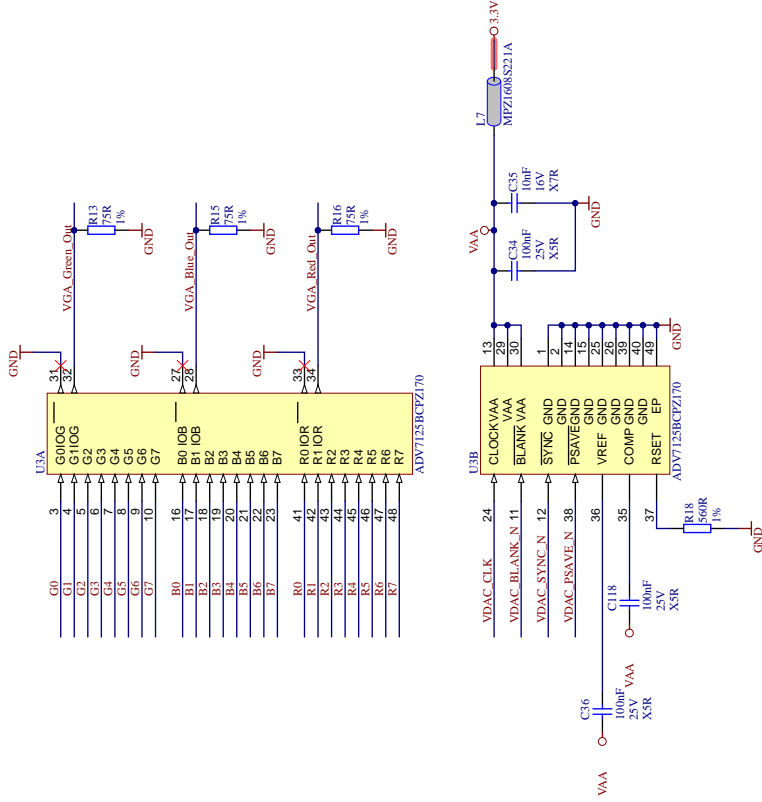

Title: MEGA65
 Number: TE0765
 [No Variations]

A4	Rev: 03
Date: 2020-06-29	Copyright: Trenz Electronic GmbH
Filename: VGA_SchDoc	

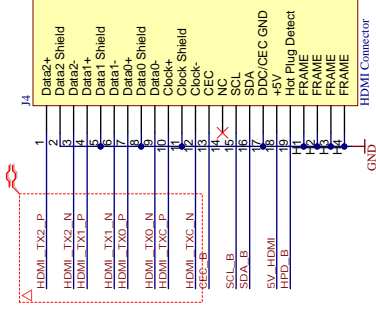
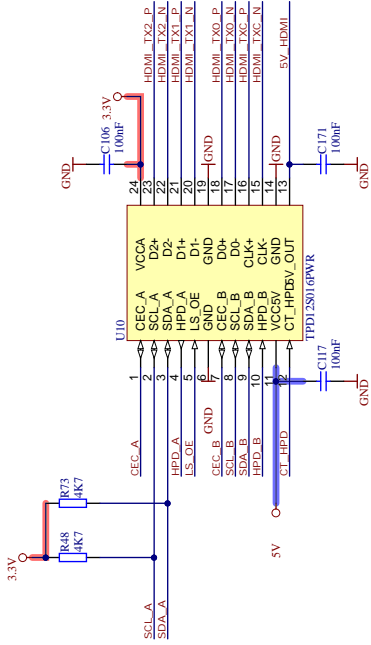

Title: MEGA65
 Number: TE0765
 [No Variations]

Rev: 03
 Date: 2020-06-29 Copyright: Trenz Electronic GmbH
 Page 17 of 23
 Filename: HDMI_SchDoc

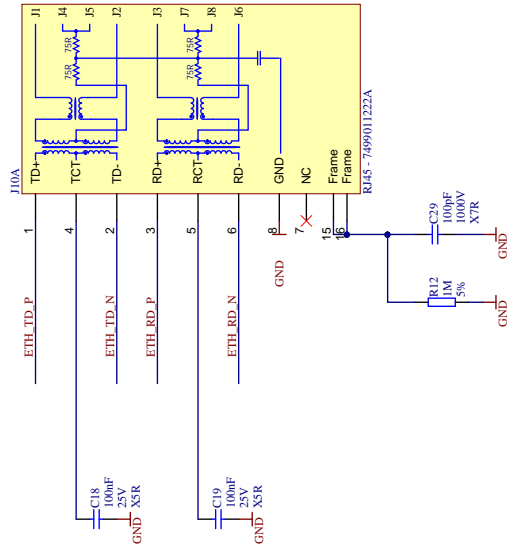
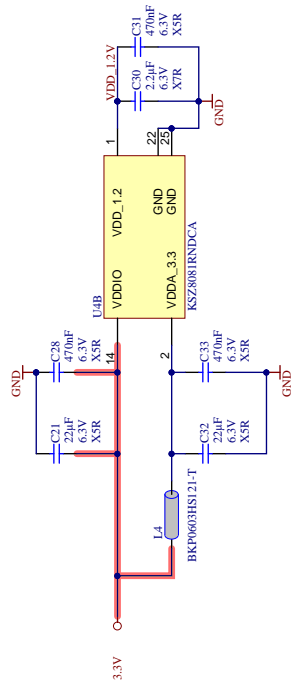
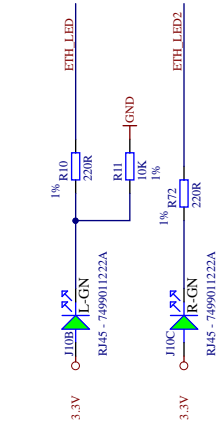
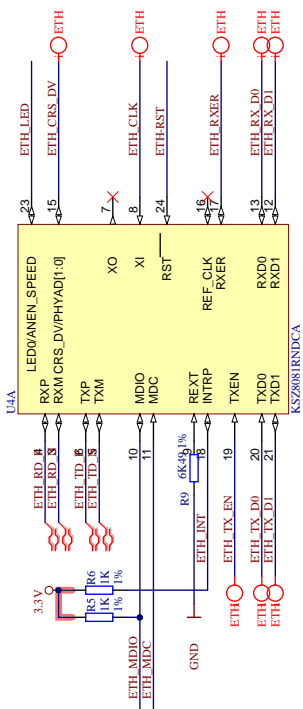

Title: MEGA65
 Number: TE0765
 [No Variations]
 Date: 2020-06-29 Copyright: Trenz Electronic GmbH
 Page 18 of 23
 Filename: Ethernet_SchDoc

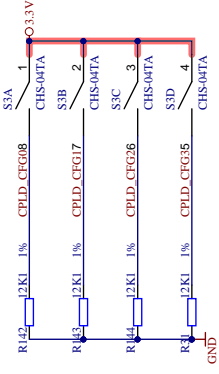
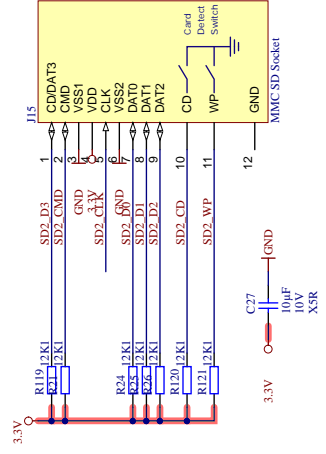
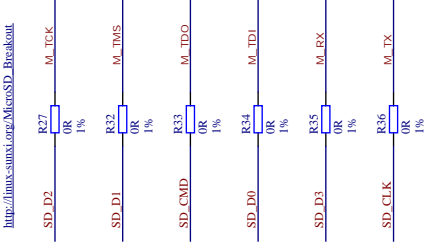
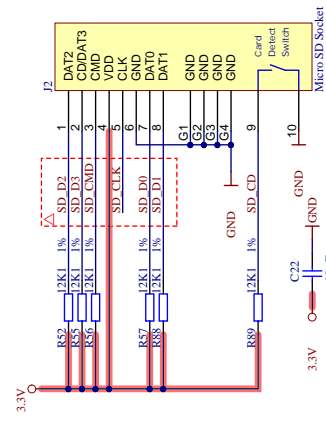

http://linux-sunxi.org/MicroSD_Breakout

Title: MEGA65



Number: TE0765

[No Variations]

Date: 2020-06-29 Copyright: Trenz Electronic GmbH

Filename: LED_SW_BUT_SchDoc

Rev: 03

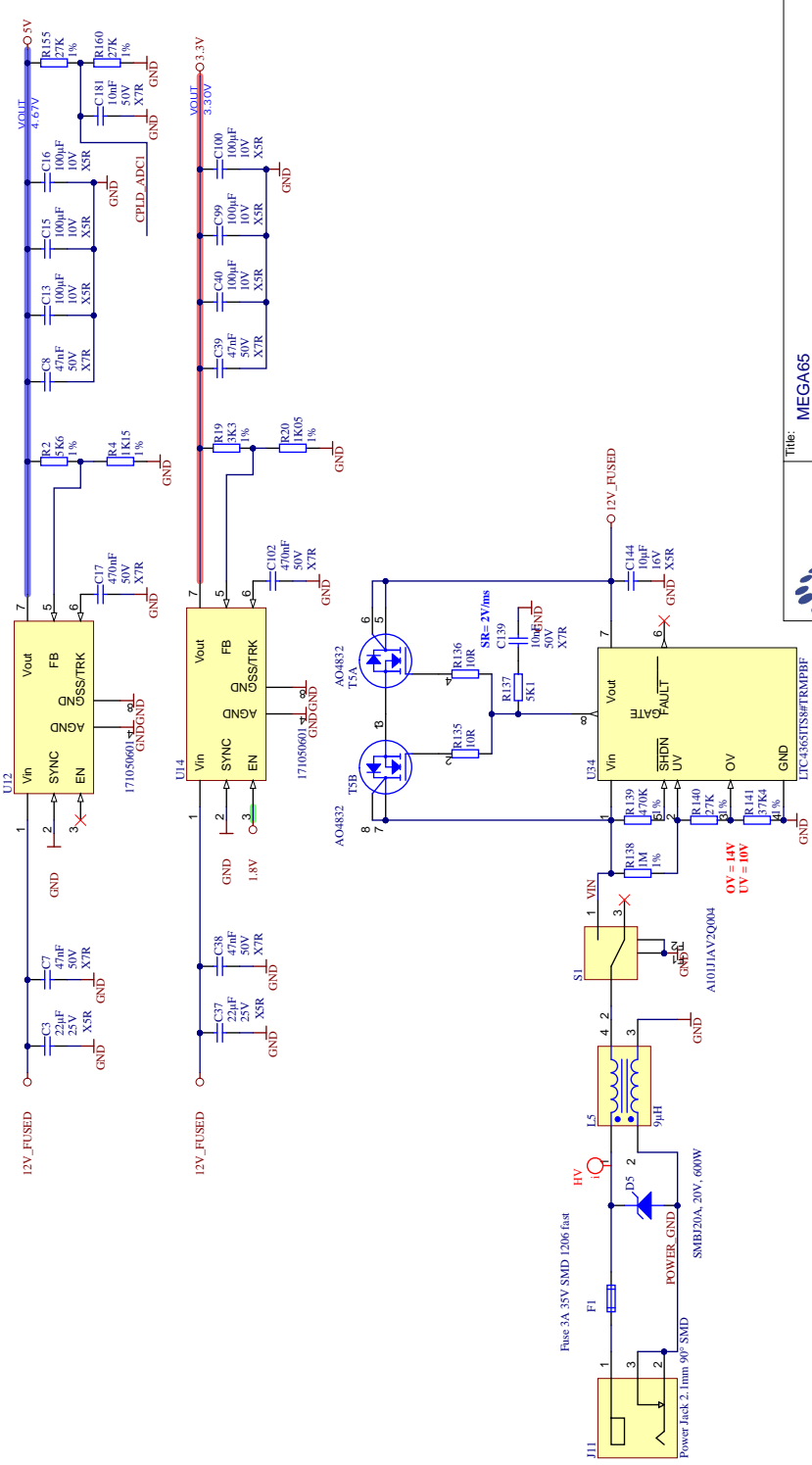

Title: MEGA65	
Number: TE0765	Rev: 03
[No Variations]	
Date: 2020-06-29	Copyright: Trenz Electronic GmbH
Filename: PowerMain_SchDoc	

A4	Rev: 03
Date: 2020-06-29 Copyright: Trenz Electronic GmbH	
Filename: PowerMain_SchDoc	

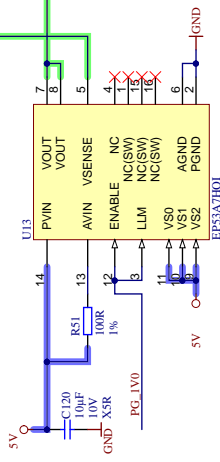
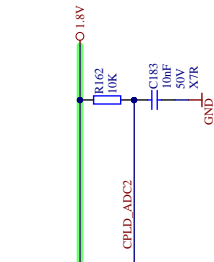
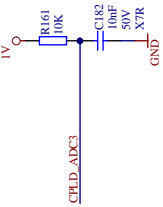
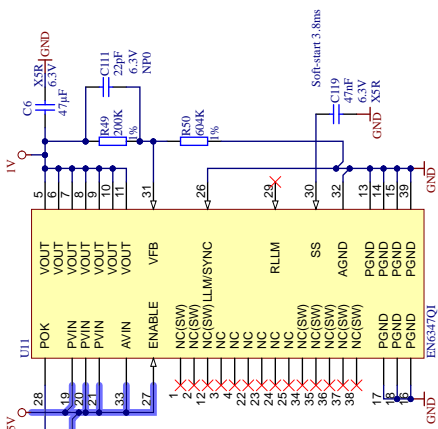

trenz electronic

Title: MEGA65

Number: TE0765 [No Variations]

Date: 2020-06-29 Copyright: Trenz Electronic GmbH / TT

Rev: 03

Page 21 of 23

Filename: POWER_SchDoc

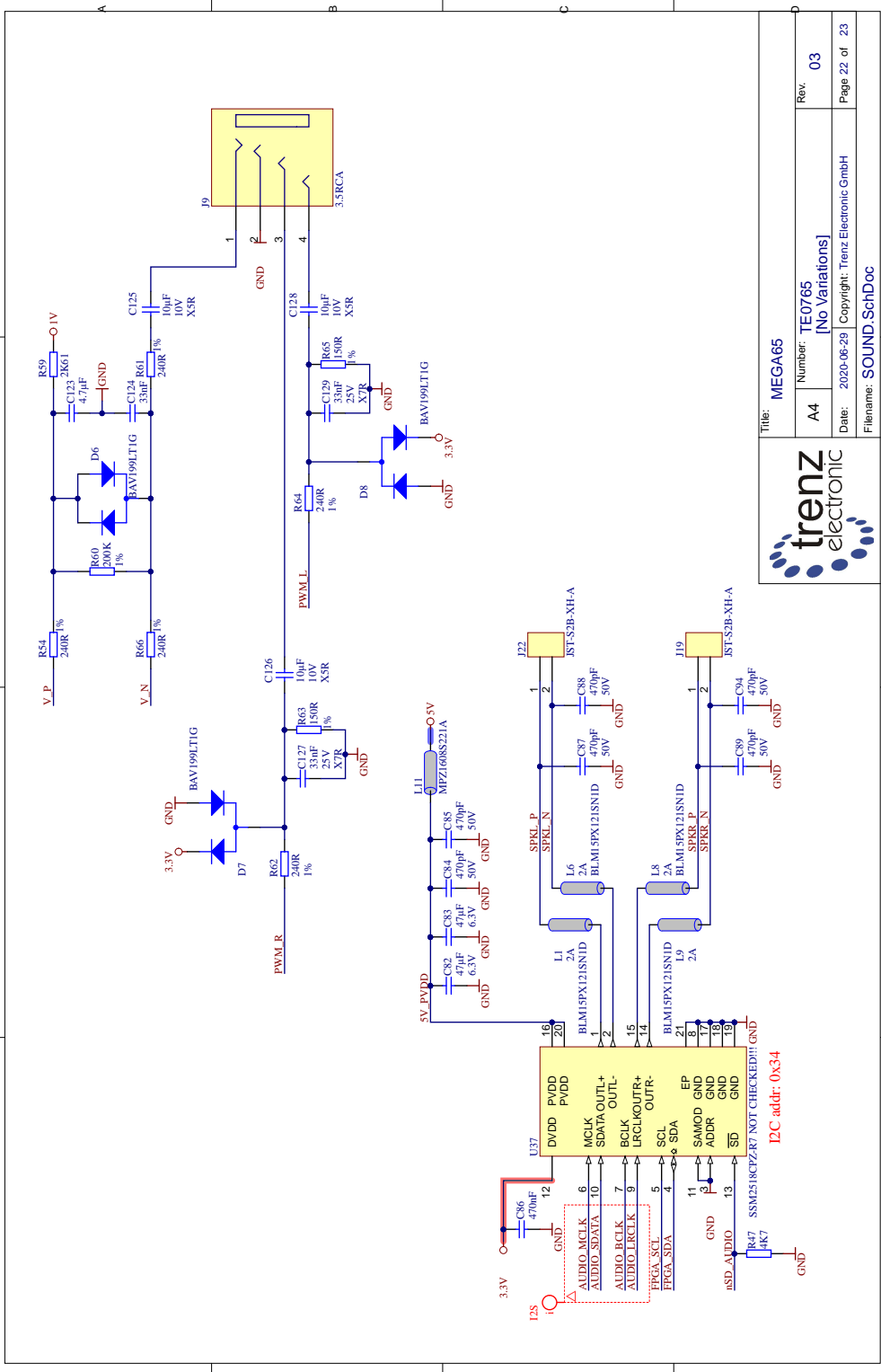

Title: MEGA65

Number: TE0765

[No Variations]

Date: 2020-06-29

Copyright: Trenz Electronic GmbH

Filename: SOUND_SchDoc



Rev: 03

Page 22 of 23

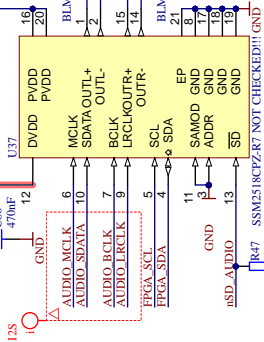

I2C addr: 0x34

SSM2518CZF-R7 NOT CHECKED!!!

REVISION HISTORY

REV	Description	IG
-03	<ul style="list-style-type: none"> 1. Added a VRP resistor on bank 65; 2. LDO U33 is changed on ADP7102ACPZ; 3. Signal FPGA_I00 is connected on AE18 pin of FPGA; 4. Signal DBG_LED3 is connected on AD18 pin of FPGA; 5. Signal MIO11_2_5 connected to J1 pin 33 instead MIO25; 6. Signal R84 is removed; 7. LED D1 is removed; 8. Added TH1 respins J4 on CPLD_JTAGEN; R76 was removed; 9. Signals B49_XX_X are renamed in B88_XX_X; 10. C241 is changed on Inf; 11. Length of CLK signals on REFAC and REFAC are adjusted; 12. Wrong connection on U8 is fixed (PCD); 13. Wrong connection PGOOD1 pin of U7 is fixed; 	

Title: MEGA65

Number: TE0835
[No Variations]

Date: 2020-06-29 Copyright: Trenz Electronic GmbH

Filename: Revision_Changes.SchDoc



Rev: 03

Page 23 of 23

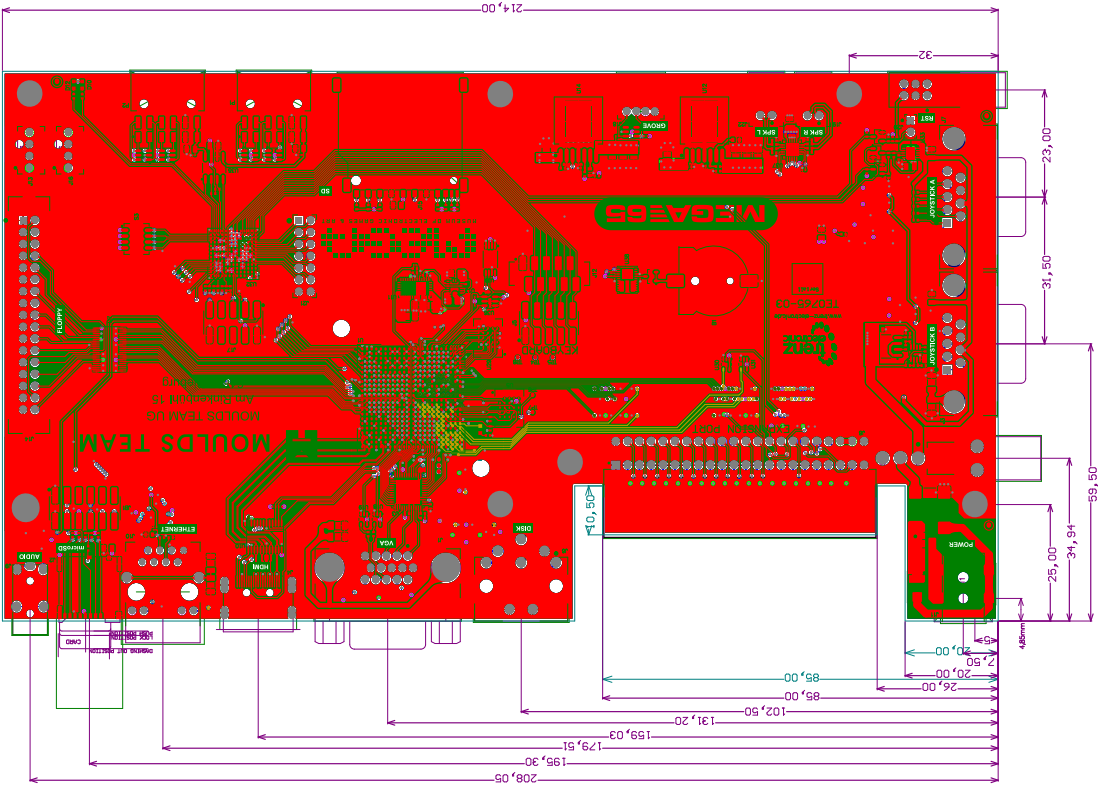

MEGA65 R2 SCHEMATICS

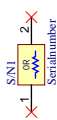
<p>A</p> <p>U_HDMI HDMI.SchDoc</p> <p>U_Ethernet Ethernet.SchDoc</p> <p>U_LED_SW_BUTTON LED_SW_BUTTON.SchDoc</p> <p>U_SYS_MAX10_CTRL SYS_MAX10_CTRL.SchDoc</p> <p>U_SOUND SOUND.SchDoc</p> <p>U_B13 B13.SchDoc</p> <p>U_B14 B14.SchDoc</p> <p>U_B15 B15.SchDoc</p> <p>U_B16 B16.SchDoc</p> <p>U_VGA B34.SchDoc</p> <p>U_FRGA_CFG FRGA_CFG.SchDoc</p> <p>U_FRGA_MGT FRGA_MGT.SchDoc</p> <p>U_FRGA_PWR FRGA_PWR.SchDoc</p> <p>U_JOY JOY.SchDoc</p> <p>U_KEYBOARD KEYBOARD.SchDoc</p> <p>U_POWER POWER.SchDoc</p> <p>U_PowerMain PowerMain.SchDoc</p> <p>U_VGA VGA.SchDoc</p> <p>U_EXT_HEADER EXT_HEADER.SchDoc</p> <p>U_EXP_Sht EXP_Sht.SchDoc</p> <p>U_Floppy Floppy.SchDoc</p>	<p>B</p> <p>Serial Serialnumber 6.3 x 6.3mm</p> 	<p>C</p>	<p>D</p>
---	--	-----------------	-----------------

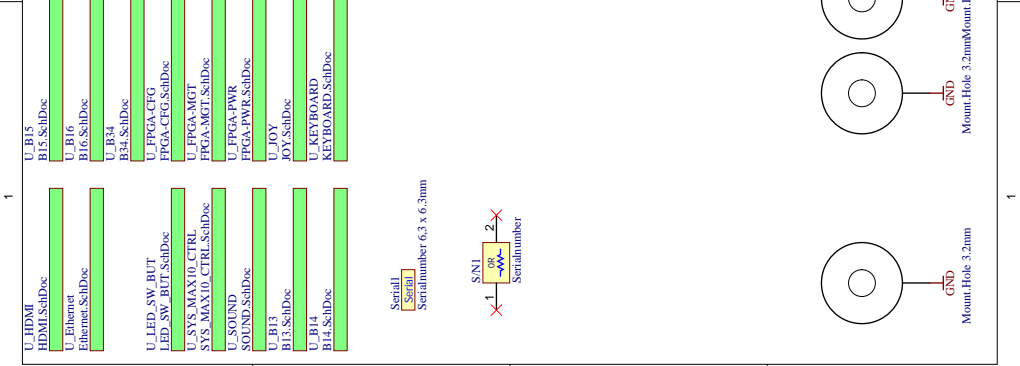

		Title: MEGA65	
A4	Number: TE0765 Default	Rev: 02	
Date: 2019-03-11 Copyright: Trenz Electronic GmbH		Page1 of 23	
Filename:		TE0765_SchDoc	

PMOD CONN

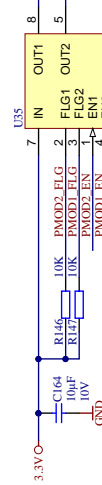
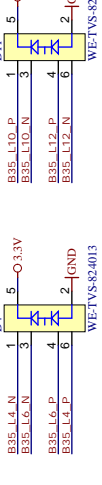
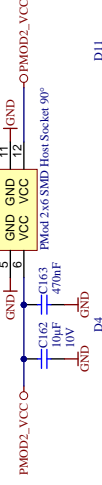
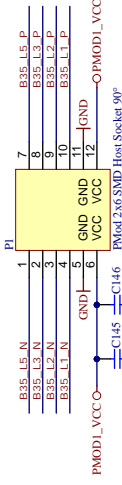
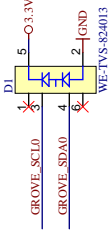
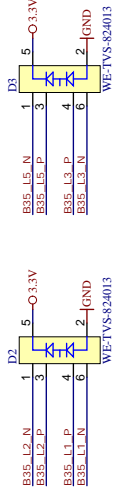

GROVE CONN

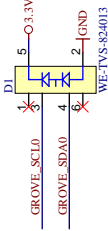

CPHD CONFIG

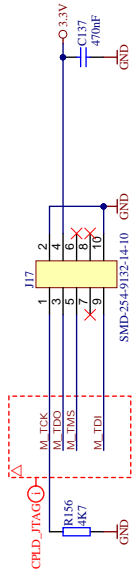

TE0790-Base-SMT

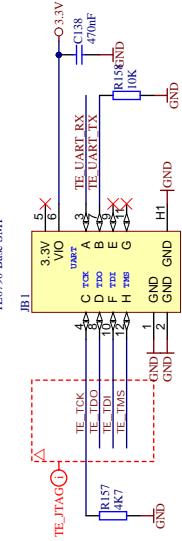

Title: MEGA65

Number: TE0765
Default

Date: 2019-03-11 Copyright: Trenz Electronic GmbH
Filename: EXT_HEADER.SchDoc



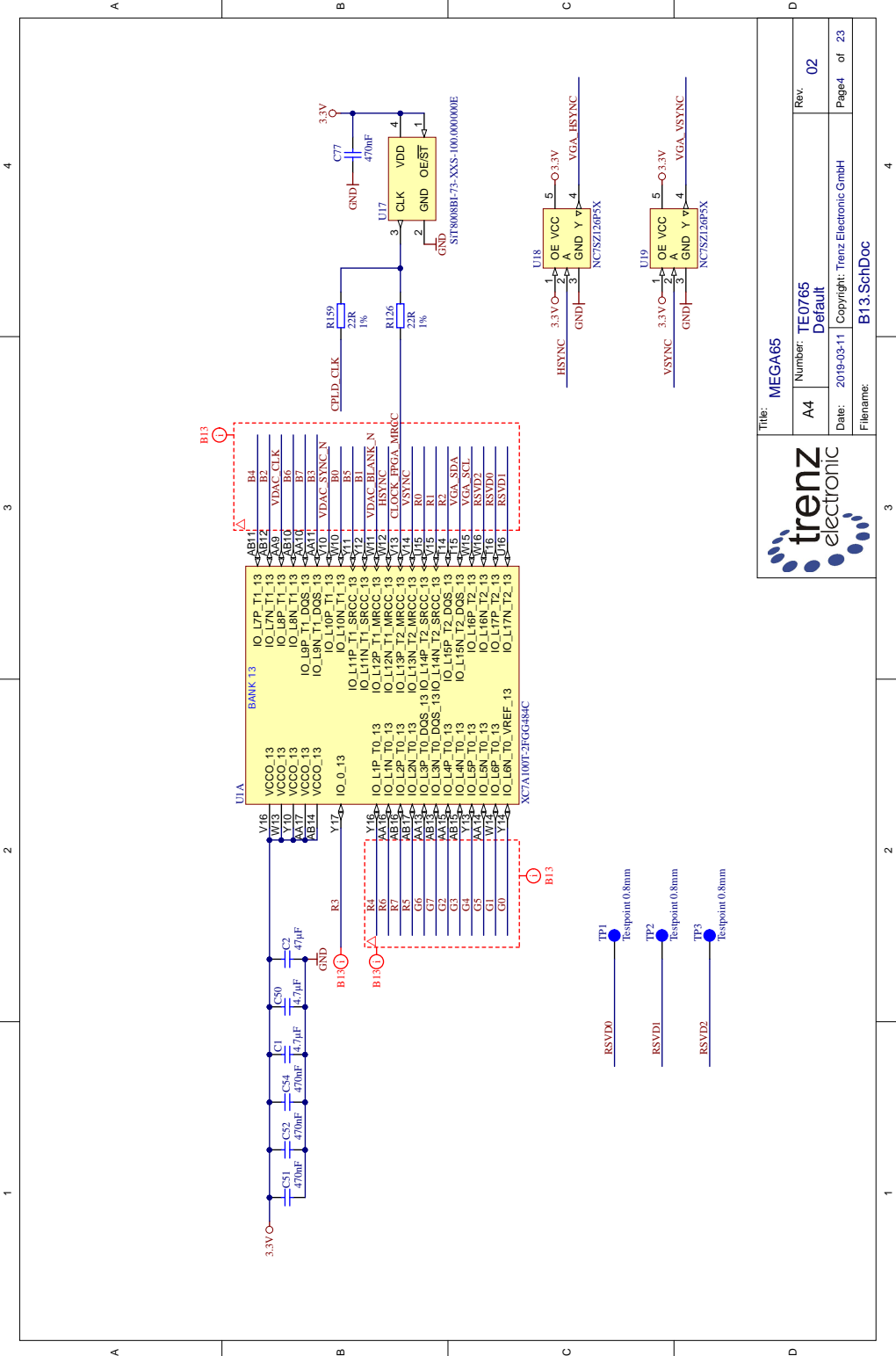

trenz electronic

Title: MEGA65
 Number: TE0765
 Default
 Date: 2019-03-11 Copyright: Trenz Electronic GmbH
 Page# of 23
 Filename: B13_SchDoc

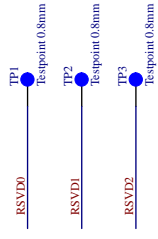

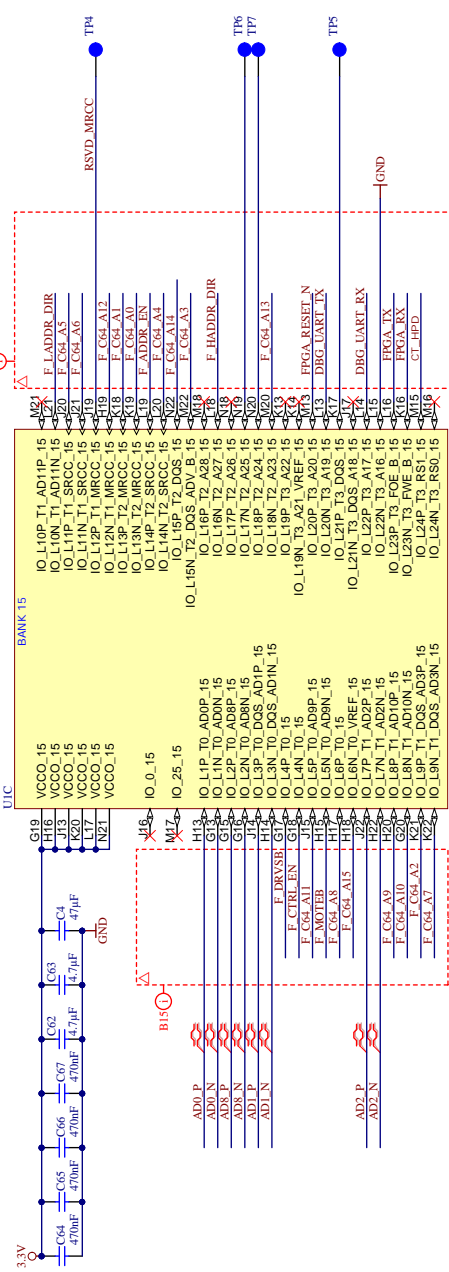

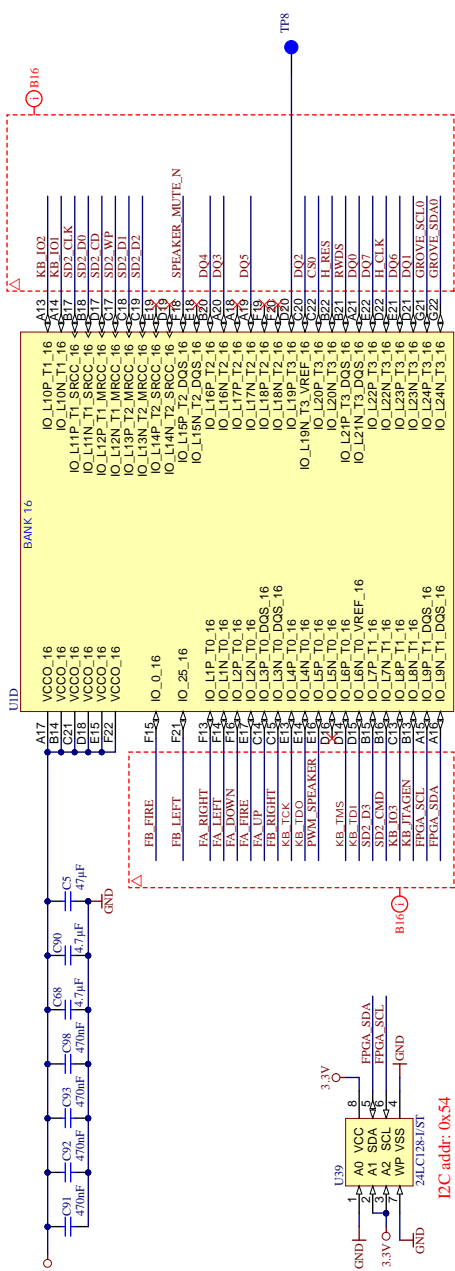

XC7A100T-2FGG484C

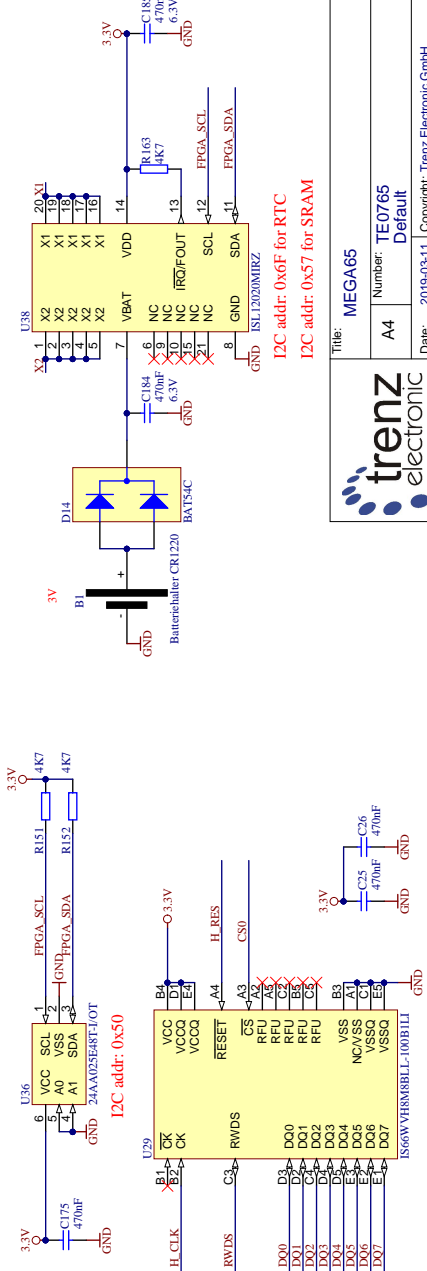

XC7A100T-2FGG484C

UID	BANK 16
A17	VCCIO_16
B14	VCCIO_16
G21	VCCIO_16
D18	VCCIO_16
E15	VCCIO_16
F22	VCCIO_16
F15	IO_0_16
F21	IO_25_16
F13	IO_L1P_T0_16
F14	IO_L1N_T0_16
E17	IO_L2P_T0_16
E18	IO_L2N_T0_16
G14	IO_L3N_T0_DQS_16
E15	IO_L4P_T0_16
E16	IO_L5P_T0_16
D18	IO_L6P_T0_16
D19	IO_L7P_T1_16
D15	IO_L8P_T1_16
B16	IO_L7N_T1_16
B17	IO_L8N_T1_16
C13	IO_L9P_T1_DQS_16
A18	IO_L9N_T1_DQS_16
A16	IO_L1P_T1_16
A17	IO_L1N_T1_16
A18	IO_L1P_T1_SRCC_16
A19	IO_L1N_T1_SRCC_16
B17	IO_L1P_T1_MRCC_16
B18	IO_L1N_T1_MRCC_16
C17	IO_L1P_T2_MRCC_16
C18	IO_L1N_T2_MRCC_16
D17	IO_L1P_T2_SRCC_16
D18	IO_L1N_T2_SRCC_16
E17	IO_L1P_T2_DQS_16
E18	IO_L1N_T2_DQS_16
F20	IO_L1P_T2
F21	IO_L1N_T2
F22	IO_L1P_T2
F23	IO_L1N_T2
F24	IO_L1P_T2
F25	IO_L1N_T2
F26	IO_L1P_T2
F27	IO_L1N_T2
F28	IO_L1P_T2
F29	IO_L1N_T2
G20	IO_L1P_T3
G21	IO_L1N_T3_VREF_16
G22	IO_L2P_T3_DQS_16
G23	IO_L2N_T3_DQS_16
H20	IO_L2P_T3
H21	IO_L2N_T3
H22	IO_L2P_T3
H23	IO_L2N_T3
H24	IO_L2P_T3
H25	IO_L2N_T3
H26	IO_L2P_T3
H27	IO_L2N_T3
H28	IO_L2P_T3
H29	IO_L2N_T3
I20	IO_L24P_T3_16
I21	IO_L24N_T3_16
I22	GROVE_SDA0
I23	IO_L24N_T3_16

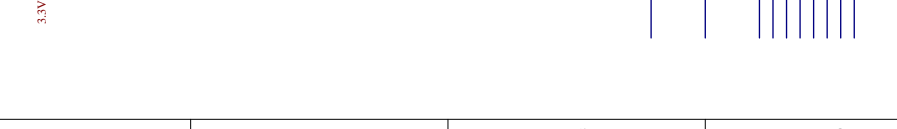
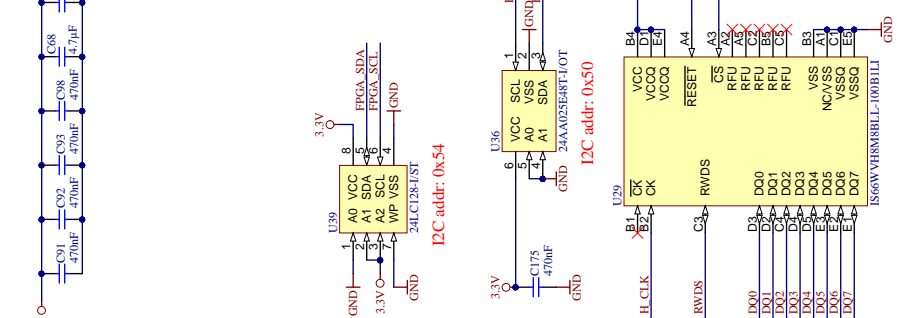
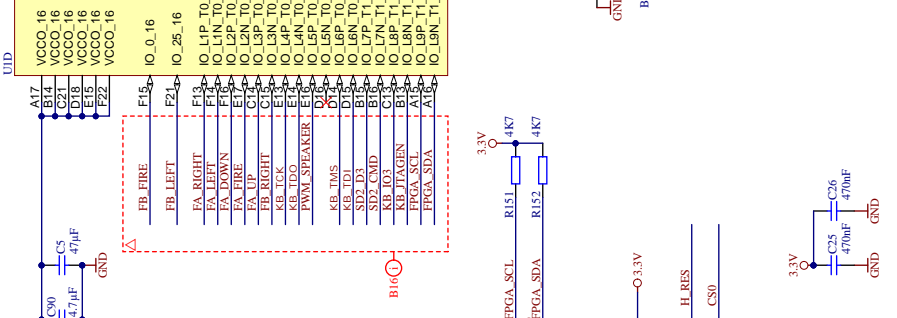
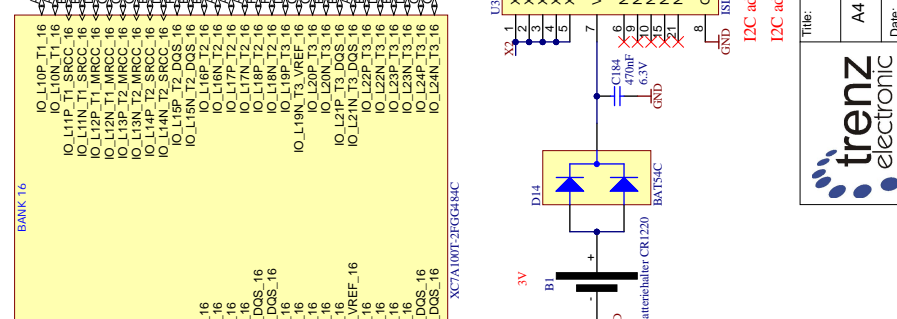

UID	A4	Number:	TE0765 Default	Rev:	02
Date:	2019-03-11		Copyright: Trenz Electronic GmbH		Page7 of 23
Filename:	B16_SchDoc				

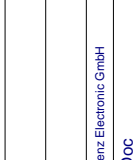

Title: MEGA65
I2C addr: 0x6F for RTC
I2C addr: 0x57 for SRAM

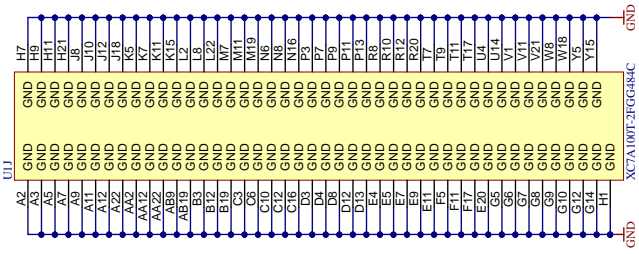
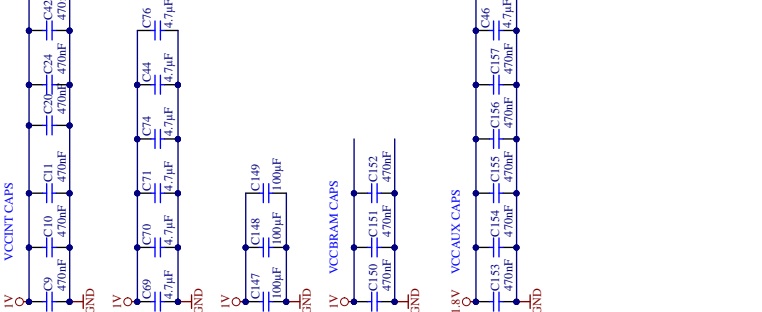
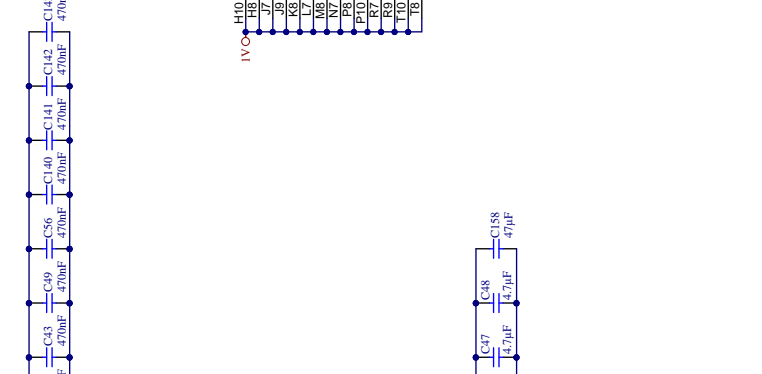
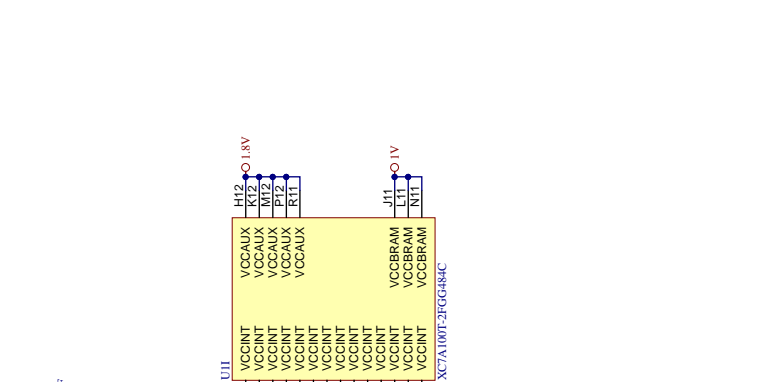
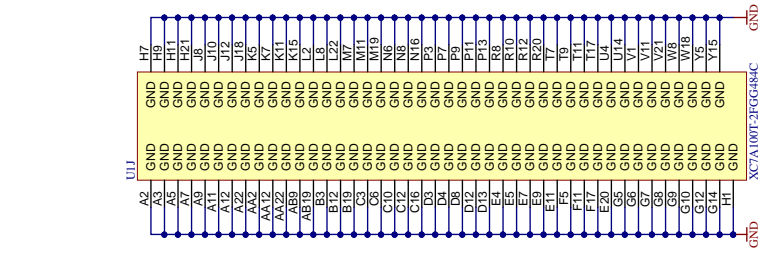

trenz electronic

Title: MEGA65

Number: TE0765

Default

Date: 2019-03-11

Copyright: Trenz Electronic GmbH

Page 11 of 23

Filename: FPGA-PWR-SchDoc

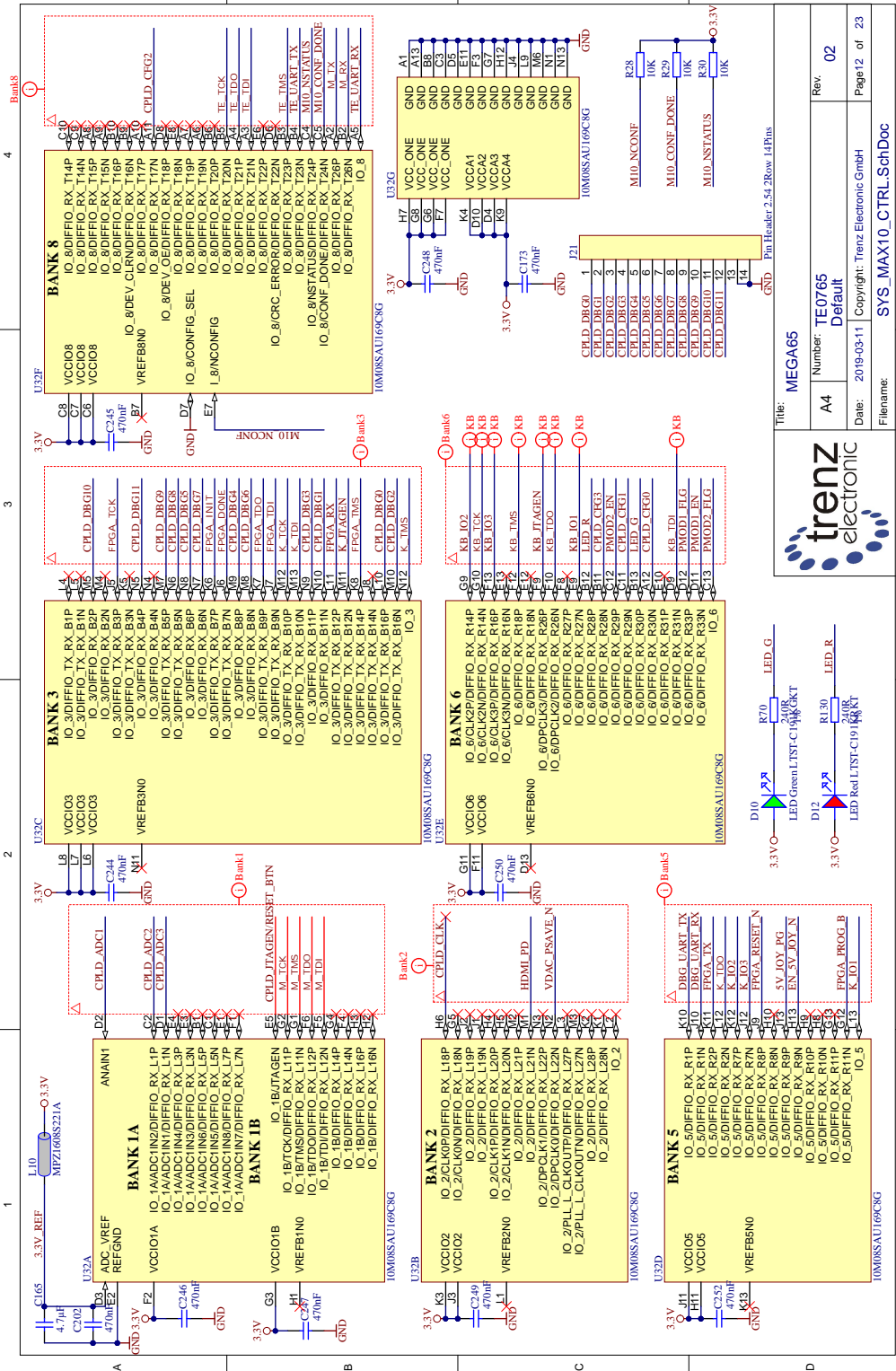

File name: SYS_MAX10_CTRL_SchDoc

Title: MEGA65	
Number: TE0765	Rev: 02
Date: 2019-03-11 Copyright: Trezz Electronic GmbH	
Page 12 of 23	

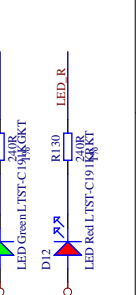

Title: MEGA65	
Number: TE0765	Rev: 02
Date: 2019-03-11 Copyright: Trezz Electronic GmbH	
Page 12 of 23	

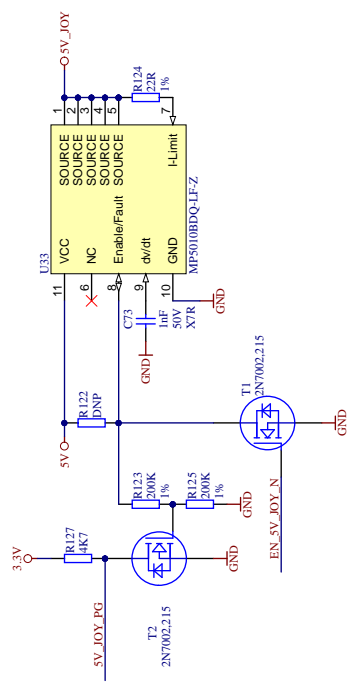
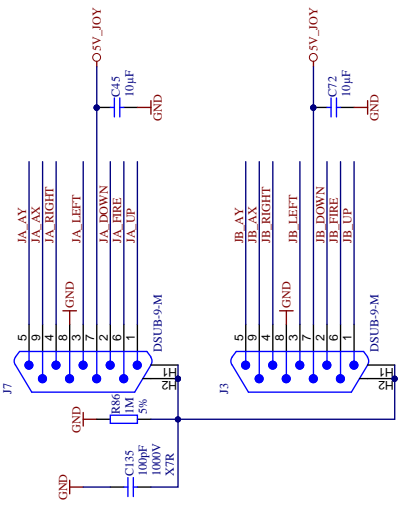
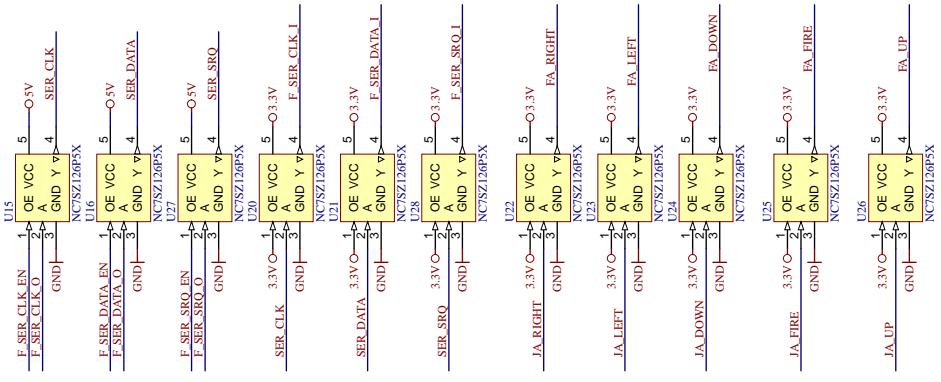
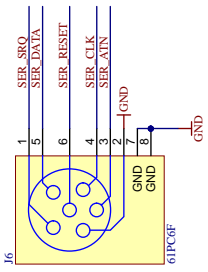

Title: MEGA65

Number: TE0765
Default

Date: 2019-03-11 Copyright: Trenz Electronic GmbH

Rev: 02

Page15 of 23

Filename: JOY_SchDoc



A

B

C

D

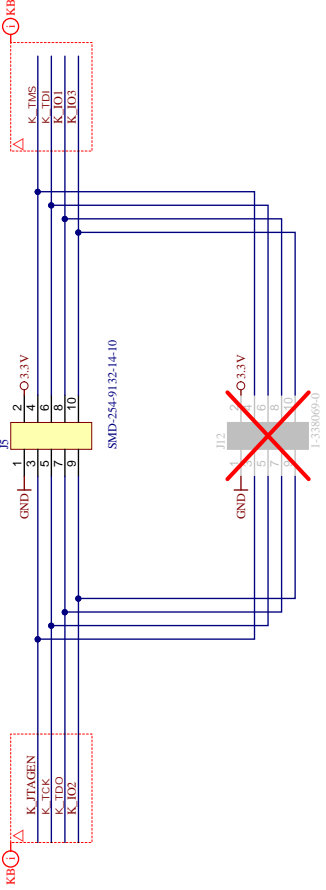

Title: MEGA65

Number: TE0765
Default

Date: 2019-03-11 Copyright: Trenz Electronic GmbH

Filename: KEYBOARD_SchDoc



Rev: 02

Page 16 of 23

A

B

C

D

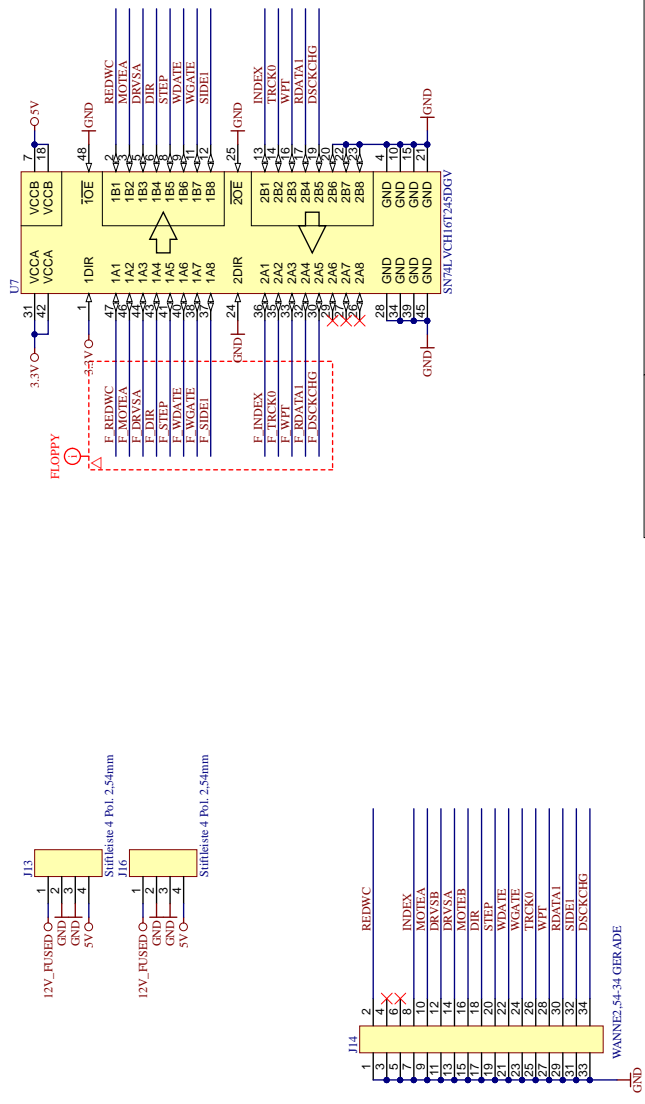

trenz electronic

Title: **MEGA65**

Number: **TE0765**

Default

Date: 2019-03-11 | Copyright: Trenz Electronic GmbH

Page 17 of 23

Filename: **Floppy_SchDoc**

Rev: **02**

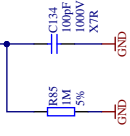
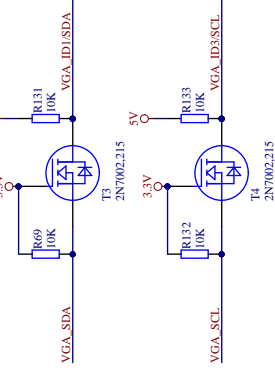
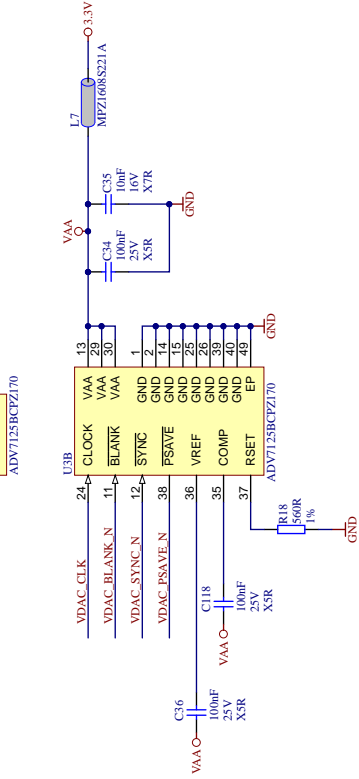
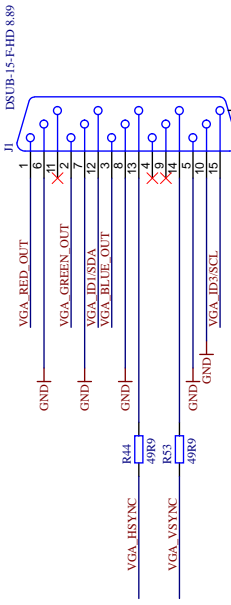
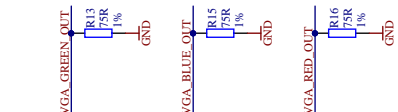
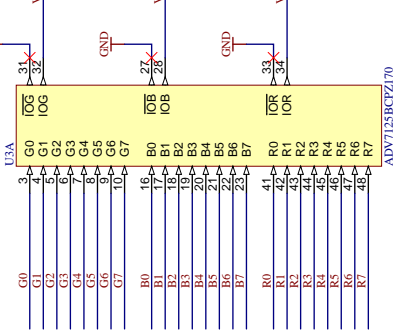

Title: MEGA65
 Number: TE0765
 Default

Date: 2019-03-11 | Copyright: Trenz Electronic GmbH
 Page 18 of 23
 Filename: VGA_SchDoc

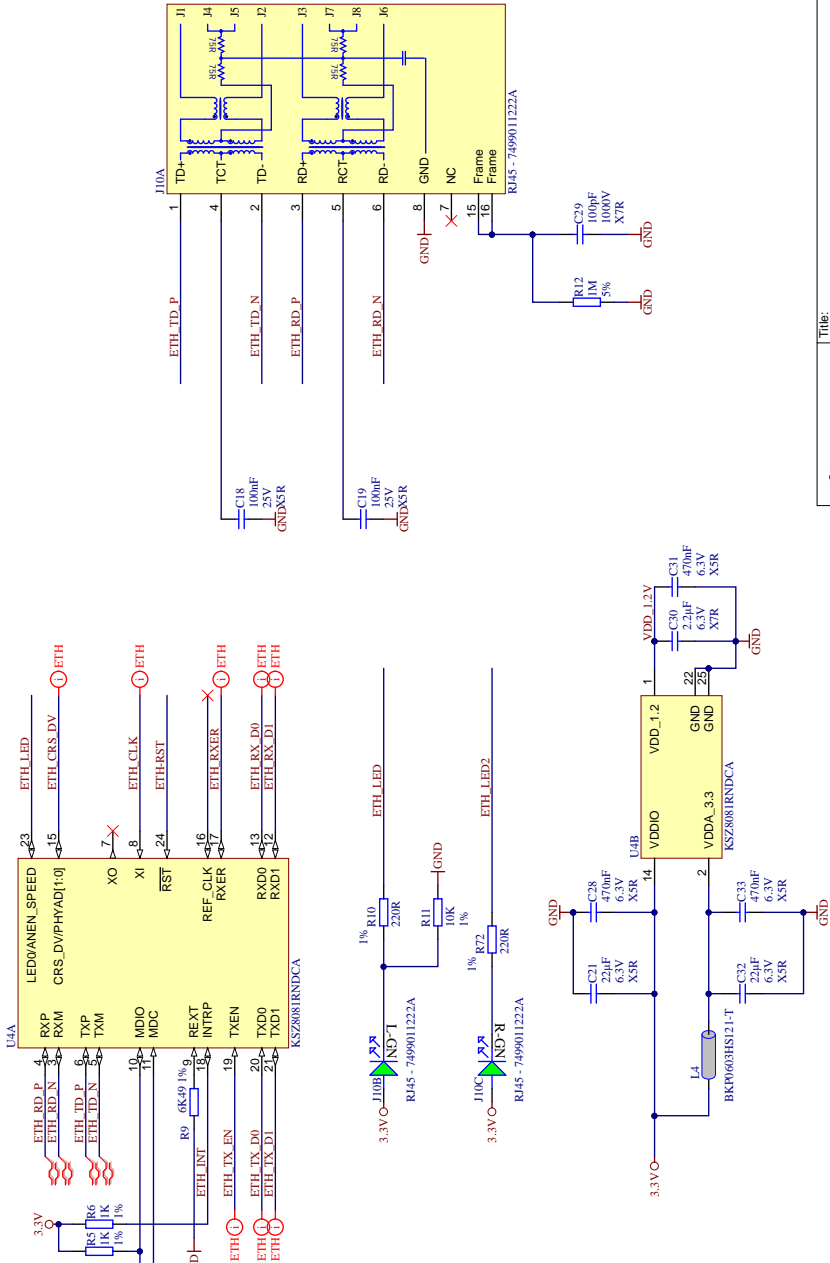

trenz electronic

Title: MEGA65

Number: TE0765

Default

Datum: 2019-03-11 Zeichner: Trenz Electronic GmbH

Filename: Ethernet_SchDoc

Rev: 02

Blatt 20 von 23

A

B

C

D

http://linux-sunxi.org/MicroSD_Breakout

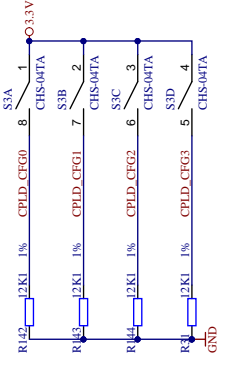
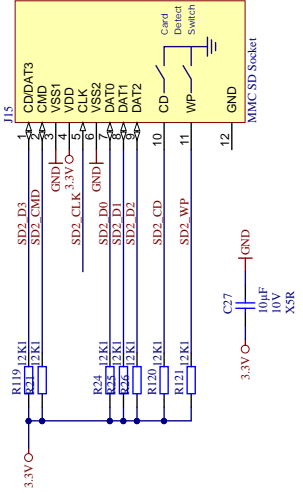
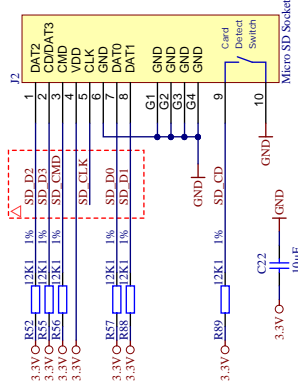
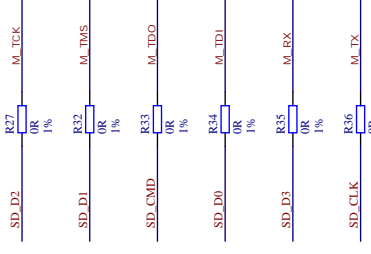

Title: MEGA65



Number: TE0765
Default

Date: 2019-03-11
Copyright: Trenz Electronic GmbH

Filename: LED_SW_BUT_SchDoc

Rev: 02

Page 21 of 23

A

B

C

D

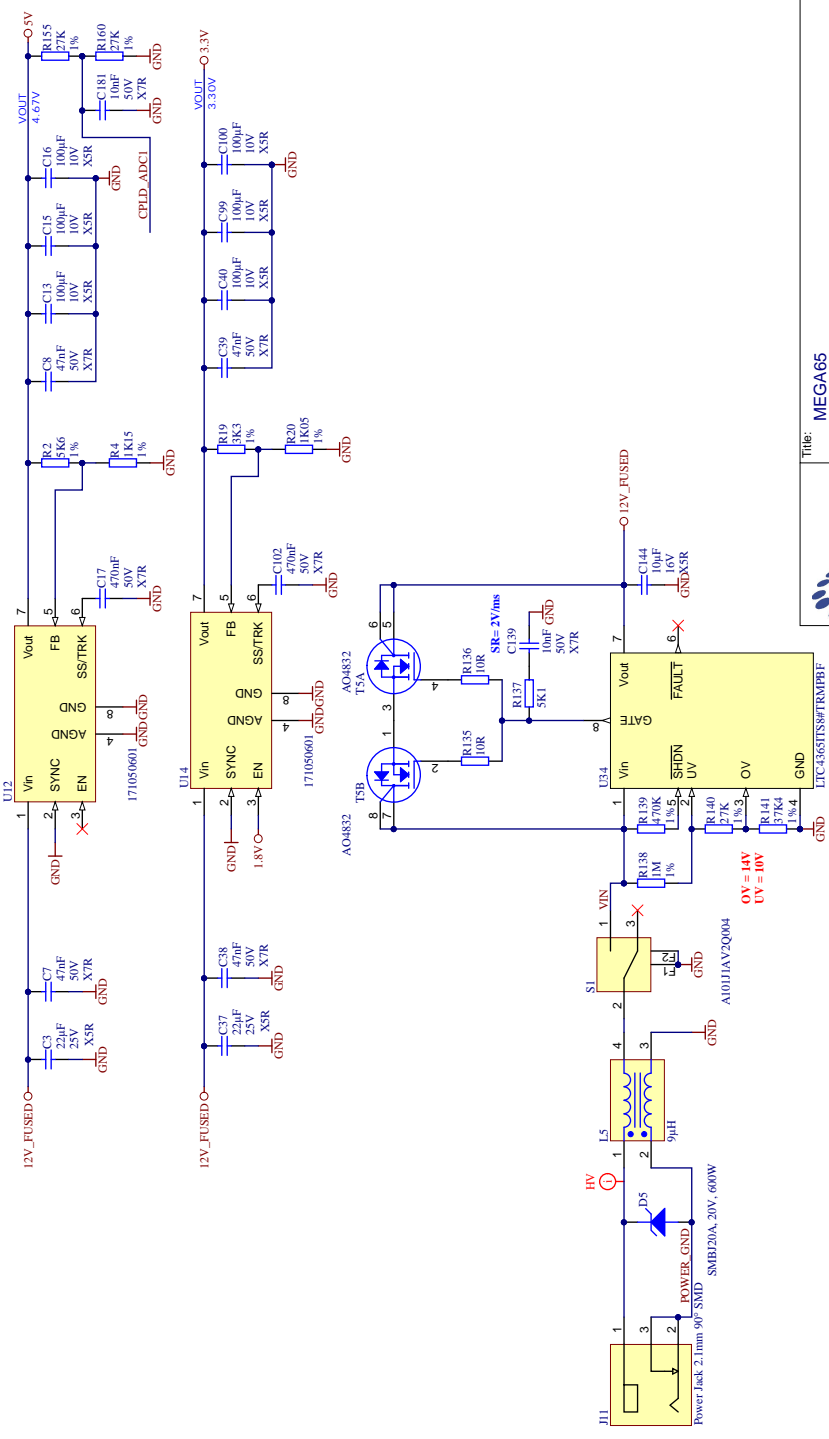

trenz electronic

Title: MEGA65
 Number: TE0765
 Default
 Date: 2019-03-11 Copyright: Trenz Electronic GmbH
 Page 22 of 23
 Filename: PowerMain_SchDoc

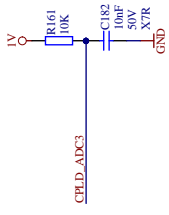
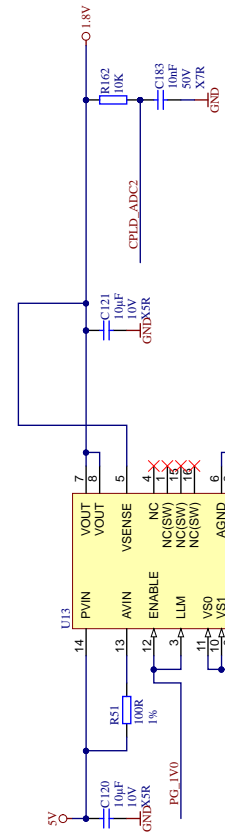
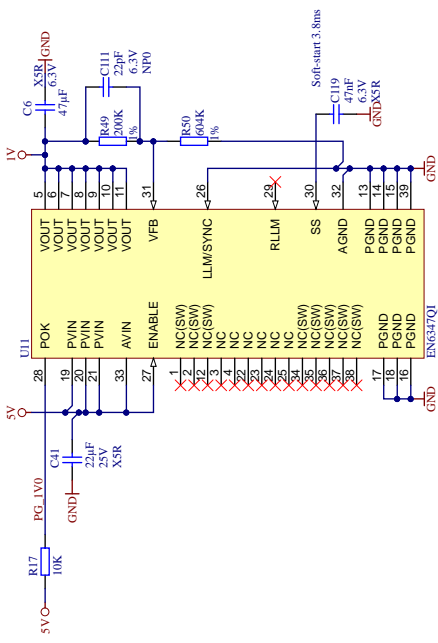

Title: MEGA65
 Number: TE0765
 Default

A4	Rev: 02
Date: 2019-03-11	Page 23 of 23
Copyright: Trenz Electronic GmbH / TT	
Filename: POWER_SchDoc	

APPENDIX

W

Supporters & Donors

- **Organisations**
- **Contributors**
- **Supporters**

The MEGA65 would not have been possible to create without the generous support of many organisations and individuals.

We are still compiling these lists, so apologies if we haven't included you yet. If you know anyone we have left out, please let us know, so that we can recognise the contribution of everyone who has made the MEGA65 possible, and into the great retro-computing project that it has become.

ORGANISATIONS

The MEGA Museum of Electronic Games & Art e.V. Germany

EVERYTHING

Trenz Elektronik, Germany

MOTHERBOARD

Hintsteiner, Austria

CASE

GMK, Germany

KEYBOARD

CONTRIBUTORS

Andreas Liebeskind

(libi in paradize)

CFO MEGA eV

Gürçe İřikyıldız

(Gurce)

Tools and enhancements

Russell Peake

(rdpeake)

Bug Herding

Alexander Nik Petra

(n0d)

Early Case Design

Ralph Egas

(0-limits)

Business Advisor

Lucas Moss

MEGAsphone PCB Design

Daren Klamer

(Impakt)

Manual proof-reading

Dr. Canan Hastik

(indica)

Chairwoman MEGA eV

Simon Jameson

(Shallan)

Platform Enhancements

Stephan Kleinert

(ubik)

Destroyer of BASIC 10

Wayne Johnson

(sausage)

Manual Additions

Lukas Kleiss

(LAK132)

MegaWAT Presentation Software

Maurice van Gils

(Maurice)

BASIC 65 example programs

SUPPORTERS

@11110110100

3c74ce64

8-Bit Classics

Aaron Smith

Achim Mrotzek

Adolf Nefischer

Adrian Esdaile

Adrien Guichard

Ahmed Kablaoui

Alan Bastian Witkowski

Alan Field

Alastair Paulin-Campbell

Alberto Mercuri

Alexander Haering

Alexander Kaufmann

Alexander Niedermeier

Alexander Soppart

Alfonso Ardire

Amiga On The Lake

André Kudra

André Simeit

André Wösten

Andrea Farolfi

Andrea Minutello

Andreas Behr

Andreas Freier

Andreas Grabski

Andreas Millinger

Andreas Nopper

Andreas Ochs

Andreas Wendel Manufaktur

Andreas Zschunke

Andrew Bingham

Andrew Dixon

Andrew Mondt

Andrzej Hłuchyj

Andrzej Sawiniec

Andrzej Śliwa

Anthony W. Leal

Arkadiusz Bronowicki

Arkadiusz Kwasny

Arnaud Léandre

Arne Drews

Arne Neumann

Arne Richard Tyarks

Axel Klahr

Balaz Ondrej

Barry Thompson

Bartol Filipovic

Benjamin Maas

Bernard Alaiz

Bernhard Zorn

Bieno Marti-Braitmaier

Bigby

Bill LaGrue

Bjoerg Stojalowski

Björn Johannesson

Bjørn Melbøe

Bo Goeran Kvamme

Boerge Noest

Bolko Beutner

Brett Hallen

Brian Gajewski

Brian Green

Brian Juul Nielsen

Brian Reiter

Bryan Pope

Burkhard Franke

Byron Goodman

Cameron Robertson (KONG)

Carl Angervall

Carl Danowski

Carl Stock

Carl Wall

Carlo Pastore

Carlos Silva

Carsten Sørensen

Çenk Miroglu Miroglu

Chang sik Park

Charles A. Hutchins Jr.

Chris Guthrey

Chris Hooper

Chris Stringer

Christian Boettcher

Christian Eick

Christian Gleinser

Christian Gräfe

Christian Heffner

Christian Kersting

Christian Schiller

Christian Streck

Christian Weyer

Christian Wyk

Christoph Haug

Christoph Huck

Christoph Pross

Christopher Christopher

Christopher Kalk

Christopher Kohlert

Christopher Nelson

Christopher Taylor

Christopher Whillock

Claudio Piccinini

Claus Skrepek

Collen Blijenberg

Constantine Lignos

Crnjaninja

Daniel Auger

Daniel Julien

Daniel Lobitz

Daniel O'Connor

Daniel Teicher

Daniel Tootill

Daniel Wedin

Daniele Benetti

Daniele Gaetano Capursi

Dariusz Szczesniak

Darrell Westbury

David Asenjo Raposo

David Dillard

David Gorgon

David Norwood

David Raulo

David Ross

de voughn accooe

Dean Scully

Dennis Jeschke

Dennis Schaffers

Dennis Schierholz

Dennis Schneck	Frank Haaland	Hendrik Fensch
denti	Frank Hempel	Henning Harperath
Dick van Ginkel	Frank Koschel	Henri Parfait
Diego Barzon	Frank Linhares	Henrik Kühn
Dierk Schneider	Frank Sleenwaert	Holger Burmester
Dietmar Krueger	Frank Wolf	Holger Sturk
Dietmar Schinnerl	FranticFreddie	Howard Knibbs
Dirk Becker	Fredrik Ramsberg	Hubert de Hollain
Dirk Wouters	Fridun Nazaradeh	Huberto Kusters
Domingo Fivoli	Friedel Kropp	Hugo Maria Gerardus v.d. Aa
DonChaos	Garrick West	Humberto Castaneda
Donn Lasher	Gary Lake-Schaal	Ian Cross
Douglas Johnson	Gary Pearson	IDE64 Staff
Dr. Leopold Winter	Gavin Jones	Igor Ianov
Dusan Sobotka	Geir Sigmund Straume	Immo Beutler
Earl Woodman	Gerd Mitlaender	Ingo Katte
Ed Reilly	Giampietro Albiero	Ingo Keck
Edoardo Auteri	Giancarlo Valente	Insanely Interested Publishing
Eduardo Gallardo	Gianluca Girelli	IT-Dienstleistungen Obsieger
Eduardo Luis Arana	Giovanni Medina	Ivan Elwood
Eirik Juliussen Olsen	Glen Fraser	Jaap HUIJSMAN
Emilio Monelli	Glen R Perye III	Jace Courville
EP Technical Services	Glenn Main	Jack Wattenhofer
Epic Sound	Gordon Rimac	Jakob Schönplflug
Erasmus Kuhlmann	GRANT BYERS	Jakub Tyszko
ergoGnomik	Grant Louth	James Hart
Eric Hilaire	Gregor Bubek	James Marshburn
Eric Hildebrandt	Gregor Gramlich	James McClanahan
Eric Hill	Guido Ling	James Sutcliffe
Eric Jutrzienka	Guido von Gösseln	Jan Bitruff
Erwin Reichel	Guillaume Serge	Jan Hildebrandt
Espen Skog	Gunnar Hemmerling	Jan Iemhoff
Evangelos Mpouras	Günter Hummel	Jan Kösters
Ewan Curtis	Guy Simmons	Jan Peter Borsje
Fabio Zanicotti	Guybrush Threepwood	Jan Schulze
Fabrizio Di Dio	Hakan Blomqvist	Jan Stoltenberg-Lerche
Fabrizio Lodi	Hans Pronk	Janne Tompuri
FARA Gießen GmbH	Hans-Jörg Nett	Jannis Schulte
FeralChild	Hans-Martin Zedlitz	Jari Loukasmäki
First Choice Auto's	Harald Dosch	Jason Smith
Florian Rienhardt	Harri Salokorpi	Javier Gonzalez Gonzalez
Forum64. de	Harry Culpan	Jean-Paul Lauque
Francesco Baldassarri	Heath Gallimore	Jeffrey van der Schilden
Frank Fechner	Heinz Roesner	Jens Schneider
Frank Glaush	Heinz Stampfli	Jens-Uwe Wessling
Frank Gulasch	Helge Förster	Jesse DiSimone

Jett Adams
Johan Arneklev
Johan Berntsson
Johan Svensson
Johannes Fitz
John Cook
John Deane
John Dupuis
John Nagi
John Rorland
John Sargeant
John Traeholt
Jon Sandelin
Jonas Bernemann
Jonathan Prosie
Joost Honig
Jordi Pakey-Rodriguez
Jöre Weber
Jörg Jungermann
Jörg Schaeffer
Jörg Weese
Josef Hesse
Josef Soucek
Josef Stohwasser
Joseph Clifford
Joseph Gerth
Jovan Crnjanin
Juan Pablo Schisano
Juan S. Cardona Iguina
JudgeBeeb
Juliussen Olsen
Juna Luis Fernandez Garcia
Jürgen Endras
Jürgen Herm Stapelberg
Jyrki Laurila
Kai Pernau
Kalle Pöyhönen
Karl Lamford
Karl-Heinz Blum
Karsten Engstler
Karsten Westebbe
katarakt
Keith McComb
Kenneth Dyke
Kenneth Joensson
Kevin Edwards

Kevin Thomasson
Kim Jorgensen
Kim Rene Jensen
Kimmo Hamalainen
Konrad Buryto
Kosmas Einbrodt
Kurt Klemm
Lachlan Glaskin
Large bits collider
Lars Becker
Lars Edelmann
Lars Slivsgaard
Lasse Lambrecht
Lau Olivier
Lee Chatt
Loan Leray
Lorenzo Quadri
Lorenzo Travagli
Lorin Millsap
Lothar James Foss
Lothar Serra Mari
Luca Papinutti
Ludek Smetana
Lukas Burger
Lutz-Peter Buchholz
Luuk Spaetgens
Mad Web Skills
MaDCz
Magnus Wiklander
Maik Diekmann
Malte Mundt
Manfred Wittemann
Manuel Beckmann
Manzano Mérida
Marc "3D-vice" Schmitt
Marc Bartel
Marc Jensen
Marc Schmidt
Marc Theunissen
Marc Tutor
Marc Wink
Marcel Buchtman
Marcel Kante
Marco Beckers
Marco Cappellari
Marco Rivela

Marco van de Water
Marcus Gerards
Marcus Herbert
Marcus Linkert
Marek Pernicky
Mario Esposito
Mario Fetka
Mario Teschke
Mariusz Tymków
Mark Adams
Mark Anderson
Mark Green
Mark Hucker
Mark Leitiger
Mark Spezzano
Mark Watkin
Marko Rizvic
Markus Bieler
Markus Bonet
Markus Dauberschmidt
Markus Fehr
Markus Fuchs
Markus Guenther-Hirn
Markus Liukka
Markus Merz
Markus Roesgen
Markus Uttenweiler
Martin Bauhuber
Martin Benke
Martin Gendera
Martin Groß
Martin Gutenbrunner
Martin Johansen
Martin Marbach
Martin Sonnleitner
Martin Steffen
Marvin Hardy
Massimo Villani
Mathias Dellacherie
Mathieu Chouinard
Matthew Adams
Matthew Browne
Matthew Carnevale
Matthew Palmer
Matthew Santos
Matthias Barthel

Matthias Dolenc	Mikael Lund	Paul Kuhnast (mindrail)
Matthias Fischer	Mike Betz	Paul Massay
Matthias Frey	Mike Kastrantas	Paul Westlake
Matthias Grandis	Mike Pikowski	Paul Wögerer
Matthias Guth	Mikko Hämäläinen	Pauline Brasch
Matthias Lampe	Mikko Suontausta	Paulo Apolonia
Matthias Meier	Mirko Roller	Pete Collin
Matthias Mueller	Miroslav Karkus	Pete of Retrohax.net
Matthias Nofer	Morgan Antonsson	Peter Eliades
Matthias Schonder	Moritz	Peter Gries
Maurice Al-Khaliedy	Morten Nielsen	Peter Habura
Max Ihlenfeldt	MUBIQUO APPS,SL	Peter Herklotz
Meeso Kim	Myles Cameron-Smith	Peter Huyoff
Michael Dailly	Neil Moore	Peter Knörzer
Michael Dötsch	Nelson	Peter Leswell
Michael Dreßel	neoman	Peter Weile
Michael Fichtner	Nicholas Melnick	Petri Alvinen
Michael Fong	Nikolaj Brinch Jørgensen	Philip Marien
Michael Geoffrey Stone	Nils Andreas	Philip Timmermann
Michael Gertner	Nils Eilers	Philipp Rudin
Michael Grün	Nils Hammerich	Pierre Kressmann
Michael Habel	Nils77	Pieter Labie
Michael Härtig	Norah Smith	Piotr Kmiecik
Michael Haynes	Norman King	Power-on.at
Michael J Burkett	Normen Zoch	Przemysław Safonow
Michael Jensen	Olaf Grunert	Que Labs
Michael Jurisch	Ole Eitels	R Welbourn
Michael Kappelgaard	Oliver Boerner	R-Flux
Michael Kleinschmidt	Oliver Brüggmann	Rafał Michno
Michael Lorenz	Oliver Graf	Rainer Kappler
Michael Mayerhofer	Oliver Smith	Rainer Kopp
Michael Nurney	Olivier Bori	Rainer Weninger
Michael Rasmussen	ONEPSI LLC	Ralf Griewel
Michael Richmond	oRdYNe	Ralf Pöscha
Michael Sachse	Osäuhing Trioflex	Ralf Reinhardt
Michael Sarbak	OSHA-PROS USA	Ralf Schenden
Michael Schneider	Padawer	Ralf Smolarek
Michael Scholz	Patrick Becher	Ralf Zenker
Michael Timm	Patrick Bürckstümmer	Ralph Bauer
Michael Traynor	Patrick de Zoete	Ralph Wernecke
Michael Whipp	Patrick Toal	Rédl Károly
Michal Ursiny	Patrick Vogt	Reiner Lanowski
Michele Chiti	Paul Alexander Warren	Remi Veilleux
Michele Perini	Paul Gerhardt (KONG)	Riccardo Bianchi
Michele Porcu	Paul Jackson	Richard Englert
Miguel Angel Rodriguez Jodar	Paul Johnson	Richard Good

Richard Menedetter
Richard Sopuch
Rick Reynolds
Rico Gruninger
Rob Dean
Robert Bernardo
Robert Eaglestone
Robert Grasböck
Robert Miles
Robert Schwan
Robert Shively
Robert Tangmar
Robert Trangmar
Rodney Xerri
Roger Olsen
Roger Pugh
Roland Attila Kett
Roland Evers
Roland Schatz
Rolf Hass
Ronald Cooper
Ronald Hunn
Ronny Hamida
Ronny Preiß
Roy van Zundert
Rüdiger Wohlfromm
Ruediger Schlenter
Rutger Willemsen
Sampo Peltonen
Sarmad Gilani
SAS74
Sascha Hesse
Scott Halman
Scott Hollier
Scott Robison
Sebastian Baranski
Sebastian Bölling
Sebastian Felzmann
Sebastian Lipp
Sebastian Rakeł
Şemseddin Moldibi
Seth Morabito
Shawn McKee
Siegfried Hartmann
Sigurbjorn Larusson
Sigurdur Finnsson

Simon Lawrence
Simon Wolf
spreen.digital
Stefan Haberl
Stefan Krampferth
Stefan Richter
Stefan Schultze
Stefan Sonnek
Stefan Theil
Stefan Vrampe
Stefano Canali
Stefano Mozzi
Steffen Reiersen
Stephan Biemann
Stephen Jones
Stephen Kew
Steve Gray
Steve Kurlin
Steve Lemieux
Steven Combs
Stewart Dunn
Stuart Marsh
Sven Neumann
Sven Stache
Sven Sternberger
Sven Wiegand
Szabolcs Bence
Tantrumedia Limited
Techvana Operations Ltd.
Teddy Turmeaux
Teemu Korvenpää
The Games Foundation
Thierry Supplisson
Thieu-Duy Thai
Thomas Bierschenk
Thomas Edmister
Thomas Frauenknecht
Thomas Gitzen
Thomas Gruber
Thomas Haidler
Thomas Jager
Thomas Karlsen
Thomas Laskowski
Thomas Marschall
Thomas Niemann
Thomas Scheelen

Thomas Schilling
Thomas Tahsin-Bey
Thomas Walter
Thomas Wirtzmann
Thorsten Knoll
Thorsten Nolte
Tim Krome
Tim Waite
Timo Weirich
Timothy Blanks
Timothy Henson
Timothy Prater
Tobias Butter
Tobias Heim
Tobias Köck
Tobias Lüthi
Tommi Vasarainen
Toni Ammer
Tore Olsen
Torleif Strand
Torsten Schröder
Tuan Nguyen
Uffe Jakobsen
Ulrich Hintermeier
Ulrik Nieland
Ulrik Kruse
Ursula Förstle
Uwe Anfang
Uwe Boschanski
Vedran Vrbanc
Verm Project
Wayne Rittimann
Wayne Sander
Wayne Steele
Who Knows
Winfried Falkenhahn
Wolfgang Becker
Wolfgang Stabla
Worblehat
www.patop69.net
Yan B
Zoltan Markus
Zsolt Zsila
Zytex Online Store

Bibliography

- [1] N. Montfort, P. Baudoin, J. Bell, I. Bogost, J. Douglass, M. C. Marino, M. Mateas, C. Reas, M. Sample, and N. Vawter, *10 PRINT CHR \$(205.5+RND(1));: GOTO 10*. MIT Press, 2012.
- [2] L. Soares and M. Stumm, "Flexsc: Flexible system call scheduling with exception-less system calls." in *Osdi*, vol. 10, 2010, pp. 1-8.
- [3] Actraiser, "Vic-ii for beginners: Screen modes, cheaper by the dozen," 2013. [Online]. Available: <http://dustlayer.com/vic-ii/2013/4/26/vic-ii-for-beginners-screen-modes-cheaper-by-the-dozen>

INDEX

, (comma), 8-22, 8-39
 .bit files, 5-4
 .cor files, 5-4
 .mcs files, 5-4
 .prm files, 5-4
 : (colon), 8-22, 8-39, 8-40
 <> (not equal to), 8-31
 \$00 (PORTDDR), G-16
 \$00 (STOPTX), P-11
 \$01 (PORT), G-16
 \$01 (STARTTX), P-11
 \$D0 (RXNORMAL), P-11
 \$D4 (DEBUGVIC), P-11
 \$DC (DEBUGCPU), P-11
 \$DE (RXONLYONE), P-11
 \$F1 (FRAME1K), P-11
 \$F2 (FRAME2K), P-11

ABS, B-12
 ADC, H-17, H-61, H-116
 ADCQ, G-14, H-117
 ALR, H-17
 altpal, 17-8
 Amiga™style audio, L-17
 ANC, H-18
 AND, 8-44, B-13, H-19, H-62, H-118
 ANDQ, G-14, H-118
 APPEND, B-14
 ARR, H-19
 ASC, B-15
 ASL, H-20, H-63
 ASLQ, G-14, H-119
 ASR, H-64
 ASRQ, H-120
 ASSEMBLE, K-10
 ASW, H-65
 ATN, B-16
 audio cross-bar switch, Q-23
 audio mixer, Q-23
 AUTO, B-17

BACKGROUND, 8-44, B-18
 BACKUP, B-19

BANK, B-20
 BASIC 65 Commands, B-210
 APPEND, B-14
 Examples, B-14
 AUTO, B-17
 Examples, B-17
 BACKGROUND, 8-44, B-18
 Examples, B-18, B-79
 BACKUP, B-19
 Examples, B-19
 BANK, B-20, F-4
 Examples, B-20, B-149,
 B-156-B-158, B-184,
 B-213, B-228, B-233
 BEGIN, B-21
 Examples, B-21, B-22, B-190
 BEND, B-22
 Examples, B-21, B-22, B-190
 BLOAD, B-23
 Examples, B-24, B-138,
 B-184, B-206, B-213,
 B-228
 BOOT, B-25
 Examples, B-25
 BORDER, 8-44, B-26
 Examples, B-26, B-40, B-79
 BOX, B-27
 Examples, B-27, B-28
 BSAVE, B-29
 Examples, B-30
 BUMP, B-31
 Examples, B-31, B-45
 BVERIFY, B-32
 Examples, B-32
 CATALOG, B-33
 Examples, B-33, B-34
 CHANGE, B-35
 Examples, B-35
 CHAR, B-36
 Examples, B-37, B-79
 CIRCLE, B-39
 Examples, B-40

CLOSE, B-41
 Examples, B-37, B-40, B-41,
 B-43, B-79, B-86, B-99,
 B-104, B-121, B-127,
 B-147, B-148, B-151,
 B-159, B-177, B-181,
 B-182, B-192, B-196
 CLR, B-42
 Examples, B-42, B-104,
 B-127, B-138, B-147,
 B-148, B-151, B-177,
 B-182, B-192, B-196,
 B-205, B-218, B-231
 CMD, B-43
 Examples, B-43, B-145
 COLLECT, B-44
 Examples, B-44
 COLLISION, B-45
 Examples, B-45
 COLOR, B-46
 Examples, B-142, B-144
 CONCAT, B-47
 Examples, B-47
 CONT, 8-39, B-48
 Examples, B-48
 COPY, B-49
 Examples, B-50, B-220
 CURSOR, B-52
 Examples, B-52, B-167, B-176
 DATA, B-53
 Examples, B-53, B-59, B-127,
 B-168, B-174, B-214
 DCLEAR, B-54
 Examples, B-54
 DCLOSE, B-55
 Examples, B-55, B-96, B-97,
 B-102, B-103, B-112,
 B-122, B-163, B-170,
 B-208
 DEF
 Examples, B-57, B-91, B-92,
 B-104, B-127, B-147,
 B-148, B-151, B-177,
 B-180, B-182, B-192,
 B-196, B-197, B-231
 DEF FN, B-57
 DELETE, B-58
 Examples, B-58
 DIM, B-59
 Examples, B-5, B-59, B-93,
 B-96, B-97, B-110, B-112,
 B-122, B-140, B-171,
 B-208
 DIR, B-60
 Examples, B-34, B-60, B-197
 DISK, B-61
 Examples, B-61, B-105, B-197
 DLOAD, B-62
 Examples, B-62, B-132, B-197
 DMA, B-63, F-4
 Examples, B-63
 DMODE, B-64
 DO, B-65
 Examples, B-65, B-86, B-98,
 B-99, B-102, B-103, B-110,
 B-130, B-205, B-225,
 B-234
 DPAT, B-68
 DSAVE, B-71
 Examples, B-71, B-111
 DVERIFY, B-73
 Examples, B-73
 EDMA, B-76
 Examples, B-76
 ELLIPSE, B-78
 Examples, B-79
 ELSE, B-80
 Examples, B-89, B-109, B-217
 END, 8-39, B-81
 Examples, B-45, B-53, B-59,
 B-77, B-81, B-84, B-85,
 B-109, B-175, B-176,
 B-186, B-214, B-217,
 B-221

ENVELOPE, B-82
 Examples, B-82, B-155
 ERASE, B-83
 Examples, B-83
 EXIT, B-86
 Examples, B-86, B-99, B-110
 FAST, B-88
 Examples, B-88
 FILTER, B-89
 Examples, B-89
 FIND, B-90
 FONT, B-92
 FOR, 8-7, B-93
 Examples, B-45, B-53, B-57,
 B-59, B-89, B-91-B-93,
 B-112, B-122, B-134,
 B-140, B-156, B-162,
 B-163, B-168, B-170,
 B-174-B-177, B-180,
 B-202, B-209, B-214,
 B-216, B-218-B-223,
 B-232, B-236
 FOREGROUND, 8-44, B-94
 Examples, B-79
 GET, B-98
 Examples, B-21, B-65, B-86,
 B-98, B-99, B-130, B-225,
 B-234
 GET#, B-99
 GETKEY, B-100
 Examples, B-37, B-40, B-79,
 B-100, B-104, B-121,
 B-147, B-148, B-151,
 B-159, B-196
 GO64, B-101
 Examples, B-101
 GOSUB, B-102
 Examples, B-65, B-89, B-102,
 B-103, B-115, B-130,
 B-144, B-176, B-225,
 B-234
 GOTO, 8-46, B-103
 Examples, B-21, B-48, B-89,
 B-98, B-100, B-102, B-103,
 B-110, B-112, B-115,
 B-122, B-144, B-183,
 B-186, B-198, B-208,
 B-216, B-220, B-232
 GRAPHIC, B-104
 Examples, B-104, B-127,
 B-147, B-148, B-151,
 B-177, B-182, B-192,
 B-196
 HEADER, B-105
 Examples, B-105
 HELP, B-106
 Examples, B-106
 HIGHLIGHT, B-108
 IF, 8-30, B-109
 Examples, B-13, B-21, B-22,
 B-31, B-40, B-69, B-70,
 B-77, B-80, B-81,
 B-84-B-86, B-89,
 B-98-B-100, B-102, B-103,
 B-109, B-110, B-112,
 B-115, B-122, B-141,
 B-144, B-146, B-160,
 B-170, B-179, B-183,
 B-186, B-190, B-208,
 B-210, B-216, B-217,
 B-232
 INPUT, 8-17, 8-24, B-110
 Examples, B-80, B-86, B-99,
 B-102, B-103, B-109,
 B-110, B-112, B-122,
 B-170, B-208, B-217
 INPUT#, B-111
 INSTR, B-113
 Examples, B-113
 KEY, B-116
 Examples, B-4, B-116, B-117,
 B-142, B-144
 LET, 8-15, B-120
 Examples, B-120

LINE, B-121
 Examples, B-86, B-99, B-104,
 B-121, B-122, B-147,
 B-148, B-151, B-177,
 B-192, B-196, B-208

LINE INPUT#, B-122

LIST, 8-11, 8-12, B-123
 Examples, B-43, B-123, B-145

LOAD, B-124
 Examples, B-117, B-125,
 B-126, B-205

LOADIFF, B-126
 Examples, B-127

LOOP, B-130
 Examples, B-65, B-86, B-98,
 B-99, B-102, B-103, B-110,
 B-130, B-225, B-234

MERGE, B-132
 Examples, B-132

MONITOR, B-135
 Examples, B-135

MOUSE, B-136
 Examples, B-136, B-142,
 B-144, B-179

MOVSPR, B-137
 Examples, B-45, B-138, B-205

NEW, B-139
 Examples, B-139

NEXT, B-140
 Examples, B-40, B-45, B-53,
 B-57, B-59, B-77, B-84,
 B-85, B-89, B-91-B-93,
 B-96, B-97, B-112, B-122,
 B-127, B-134, B-138,
 B-140, B-156, B-162,
 B-163, B-168, B-170,
 B-174-B-177, B-180,
 B-202, B-205, B-209,
 B-214, B-216,
 B-218-B-223, B-232,
 B-236

OFF, B-142
 Examples, B-17, B-111,
 B-117, B-136, B-142,
 B-176, B-179

ON, B-143
 Examples, B-52, B-111,
 B-115, B-117, B-125,
 B-126, B-136, B-144,
 B-167, B-176, B-179,
 B-197, B-198

OPEN, B-145
 Examples, B-41, B-43, B-86,
 B-99, B-104, B-127, B-145,
 B-147, B-148, B-151,
 B-177, B-182, B-192,
 B-196

PAINT, B-147
 Examples, B-147, B-148

PALETTE, B-148
 Examples, B-40, B-104,
 B-127, B-147, B-148,
 B-151, B-181, B-192,
 B-196

PEN, B-151
 Examples, B-40, B-79, B-104,
 B-121, B-147, B-148,
 B-151, B-177, B-182,
 B-192, B-196

PLAY, B-153
 Examples, B-82, B-89, B-154,
 B-155, B-183, B-216,
 B-232

POLYGON, B-159
 Examples, B-159

PRINT, 8-11, B-162
 Examples, B-4, B-12, B-13,
 B-15, B-16, B-21, B-22,
 B-31, B-38, B-41-B-43,
 B-45, B-48, B-51, B-53,
 B-56, B-57, B-59, B-70,
 B-72, B-77, B-80, B-81,
 B-83-B-87, B-89,
 B-91-B-93, B-95, B-99,

B-102, B-103, B-106,
 B-107, B-109, B-110,
 B-112, B-115, B-118,
 B-119, B-122, B-128,
 B-129, B-131, B-133,
 B-134, B-140, B-141,
 B-144, B-146, B-149,
 B-150, B-156, B-160,
 B-162, B-163, B-165,
 B-167, B-168, B-170,
 B-174-B-182, B-184,
 B-186, B-190, B-193,
 B-199, B-202,
 B-207-B-211,
 B-213-B-215,
 B-217-B-223,
 B-227-B-229, B-236

PRINT USING, B-164
 PRINT#, B-163
 RCURSOR, B-167
 Examples, B-167
 READ, B-168
 Examples, B-53, B-59, B-168,
 B-174, B-214
 RECORD, B-169
 Examples, B-170
 REM, B-171
 Examples, B-5, B-18-B-22,
 B-24, B-26, B-31, B-38,
 B-40, B-41, B-43, B-45,
 B-50, B-52, B-53, B-55,
 B-57-B-59, B-61, B-63,
 B-65, B-67, B-76, B-77,
 B-79-B-81, B-83-B-86,
 B-88, B-89, B-91, B-92,
 B-98-B-100, B-102-B-104,
 B-109, B-110,
 B-112-B-115, B-117,
 B-120-B-123,
 B-125-B-127, B-130,
 B-131, B-136, B-139,
 B-142, B-144, B-145,
 B-147-B-151,
 B-155-B-163, B-166,
 B-170-B-173, B-176,
 B-177, B-179-B-183,
 B-185-B-190, B-192,
 B-193, B-196-B-198,
 B-200-B-204, B-206,
 B-208, B-210,
 B-217-B-220, B-222,
 B-223, B-225, B-228,
 B-231, B-233-B-235

RENAME, B-172
 Examples, B-172
 RENUMBER, 8-38, B-173
 Examples, B-173
 RESTORE, B-174
 Examples, B-127, B-139,
 B-174, B-196
 RESUME, B-175
 Examples, B-77, B-84, B-85,
 B-175, B-221
 RETURN, B-176
 Examples, B-45, B-89, B-102,
 B-103, B-115, B-144,
 B-176
 RMOUSE, B-179
 Examples, B-179
 RREG, B-184
 Examples, B-184, B-213
 RUN, B-189
 Examples, B-4, B-42, B-48,
 B-53, B-57, B-59, B-91,
 B-92, B-106, B-112, B-133,
 B-156, B-167, B-170,
 B-177, B-181, B-182,
 B-189, B-202, B-214,
 B-219, B-222, B-223
 SAVE, B-191
 Examples, B-117, B-191
 SCNCLR, B-192

Examples, B-40, B-104,
B-127, B-138, B-176,
B-177, B-182, B-205

SCRATCH, B-193

Examples, B-193

SCREEN, B-194

Examples, B-37, B-40, B-79,
B-104, B-121, B-127,
B-147, B-148, B-151,
B-159, B-177, B-181,
B-182, B-192, B-196

SET, B-197

Examples, B-104, B-127,
B-147, B-148, B-151,
B-177, B-182, B-192,
B-196, B-197

SLEEP, B-200

Examples, B-89, B-127,
B-138, B-176, B-192,
B-196, B-200

SOUND, B-201

Examples, B-201

SPEED, B-203

Examples, B-203

SPRCOLOR, B-204

Examples, B-204

SPRITE, B-205

Examples, B-45, B-185,
B-187, B-188,
B-204-B-206

SPRSAY, B-206

Examples, B-206

STEP, 8-13, B-209

Examples, B-57, B-89,
B-91-B-93, B-140, B-170,
B-209, B-216, B-219,
B-232

STOP, 8-39

SYS, B-212

Examples, B-25, B-184, B-213

TEMPO, B-216

Examples, B-82, B-155,
B-216, B-232

THEN, 8-30, B-217

Examples, B-13, B-21, B-22,
B-31, B-69, B-70, B-77,
B-81, B-84-B-86, B-89,
B-98-B-100, B-102, B-103,
B-109, B-110, B-112,
B-115, B-122, B-141,
B-144, B-146, B-160,
B-170, B-179, B-183,
B-186, B-190, B-208,
B-210, B-216, B-217,
B-232

TO, B-220

Examples, B-19, B-30, B-35,
B-45, B-47, B-50, B-53,
B-57, B-59, B-89,
B-91-B-93, B-112, B-122,
B-125, B-126, B-134,
B-140, B-162, B-163,
B-168, B-170, B-172,
B-174-B-177, B-180,
B-197, B-202, B-205,
B-209, B-214, B-216,
B-218-B-223, B-232,
B-236

TRAP, B-221

Examples, B-77, B-84, B-85,
B-175, B-221

TROFF, B-222

Examples, B-222, B-223

TRON, B-223

Examples, B-222, B-223

TYPE, B-224

Examples, B-112, B-224

UNTIL, B-225

Examples, B-65, B-98, B-102,
B-103, B-110, B-130,
B-225, B-234

USING, B-226

Examples, B-57, B-91, B-92,
 B-165, B-219, B-227
 VERIFY, B-230
 Examples, B-197, B-230
 VIEWPORT, B-231
 Examples, B-231
 VOL, B-232
 Examples, B-82, B-155,
 B-216, B-232
 WAIT, B-233
 Examples, B-233
 WHILE, B-234
 Examples, B-65, B-130,
 B-225, B-234
 WINDOW, B-235
 Examples, B-235

BASIC 65 Functions
 ABS, B-12
 ASC, B-15
 ATN, B-16
 CHR\$, B-38
 COS, B-51
 DEC, B-56
 ERR\$, B-85
 EXP, B-87
 FN, B-57, B-91
 FRE, B-95
 FREAD, B-96
 FWRITE, B-97
 HEX\$, B-107
 INT, B-114
 JOY, B-115
 LEFT\$, B-118
 LEN, B-119
 LOG, B-128
 LOG10, B-129
 LPEN, B-131
 MID\$, B-133
 MOD, B-134
 PEEK, B-149
 PEEKW, B-150
 PIXEL, B-152
 POINTER, B-156
 POKE, B-157
 POKEW, B-158
 POS, B-160
 POT, B-161
 RCOLOR, B-166
 RGRAPHIC, B-177
 RIGHT\$, B-178
 RND, 8-45, B-180
 RPALETTE, B-181
 RPEN, B-182
 RPLAY, B-183
 RSPCOLOR, B-185
 RSPEED, B-186
 RSPPOS, B-187
 RSPRITE, B-188
 RWINDOW, B-190
 SGN, B-198
 SIN, B-199
 SPC, B-202
 SQR, B-207
 STR\$, B-211
 TAB, B-214
 TAN, B-215
 USR, B-228
 VAL, B-229

BASIC 65 Operators
 AND, 8-44, B-13
 NOT, B-141
 OR, B-146
 XOR, B-236

BASIC 65 System Commands
 EDIT, B-74

BASIC 65 System Variables
 DS, B-69
 DS\$, B-70
 DT\$, B-72
 EL, B-77
 ER, B-84
 ST, B-208
 TI, B-218
 TI\$, B-219

BBR0, H-65
 BBR 1, H-65
 BBR2, H-66
 BBR3, H-66
 BBR4, H-67
 BBR5, H-67
 BBR6, H-67
 BBR7, H-68
 BBS0, H-68
 BBS1, H-68
 BBS2, H-69
 BBS3, H-69
 BBS4, H-69
 BBS5, H-70
 BBS6, H-70
 BBS7, H-70
 BCC, H-20, H-71
 BCS, H-21, H-71
 BEGIN, B-21
 BEND, B-22
 BEQ, H-21, H-71
 bgcolor, 17-7
 BIT, H-22, H-72
 BITMAPS, K-11
 BITQ, G-14, H-121
 blink, 17-8
 BLOAD, B-23
 blocked, 8-21
 BMI, H-22, H-72
 BNE, H-23, H-73
 BOOT, B-25
 BORDER, 8-44, B-26
 bordercolor, 17-6
 BOX, B-27
 box, 17-11
 BPL, H-23, H-73
 BRA, H-74
 BREAKPOINT, K-16
 BRK, H-23, H-74
 BSAVE, B-29
 BSR, H-75
 BUMP, B-31
 BVC, H-24, H-75
 BVERIFY, B-32
 BVS, H-24, H-76
 CATALOG, B-33
 cellcolor, 17-8
 cgetc, 17-17
 CHANGE, B-35
 CHAR, B-36
 character, 8-13
 character set, 8-13
 CHR\$, B-38
 cinput, 17-18
 CIRCLE, B-39
 CLC, H-25, H-76
 CLD, H-25, H-76
 CLE, H-77
 clearattr, 17-8
 CLI, H-26, H-77
 CLOSE, B-41
 CLR, B-42
 clrscr, 17-5
 CLV, H-26, H-78
 CMD, B-43
 CMP, H-26, H-48, H-78, H-122
 CMPO, H-122
 COLLECT, B-44
 COLLISION, B-45
 COLOR, B-46
 CONCAT, B-47
 conionit, 17-3
 CONT, 8-39, B-48
 context dependent, 8-19
 COPY, B-49
 copyright, ii
 COS, B-51
 CPO, G-14
 cprintf, 17-17
 CPUHISTORY, K-20
 CPUMEMORY, K-15
 cputc, 17-14
 cputcxy, 17-16
 cputdec, 17-15

cputhex, 17-15
 cputnc, 17-14
 cputncxy, 17-16
 cputs, 17-15
 cputsxy, 17-16
 CPX, H-27, H-79
 CPY, H-28, H-80
 CPZ, H-80
 cross-bar switch, audio, Q-23
 CURSOR, B-52

DATA, B-53
 DCLEAR, B-54
 DCLOSE, B-55
 DCP, H-28
 DEBUGCPU, P-11
 DEBUGMON, K-18
 DEBUGVIC, P-11
 DEC, B-56, H-29, H-81
 DEF FN, B-57
 DELETE, B-58
 DEQ, G-14, H-123
 DEW, H-81
 DEX, H-30, H-82
 DEY, H-30, H-82
 DEZ, H-83
 Digital Audio, L-17
 digital video, M-9
 DIM, B-59
 DIR, B-60
 Direct Mode, 8-18
 DISASSEMBLE, K-5, K-16
 DISK, B-61
 DLOAD, B-62
 DMA, B-63
 DMA Audio, L-17
 DMODE, B-64
 DO, B-65
 DOPEN, B-66
 DPAT, B-68
 DS, B-69
 DS\$, B-70
 DSAVE, B-71

DT\$, B-72
 DVERIFY, B-73

EDIT, B-74
 EDMA, B-76
 EL, B-77
 ELLIPSE, B-78
 ELSE, B-80
 END, 8-39, B-81
 ENVELOPE, B-82
 EOM, H-83
 EOR, H-30, H-84, H-124
 EORO, G-14, H-124
 ER, B-84
 ERASE, B-83
 ERR\$, B-85
 Errors

- Extra Ignored, 8-22
- Illegal Direct, 8-18
- Syntax, 8-4
- Type mismatch, 8-17

EXIT, B-86
 EXP, B-87
 Extra Ignored, 8-22

FAST, B-88
 FILL, K-17
 fillrect, 17-10
 FILTER, B-89
 FIND, B-90
 FLAGWATCH, K-17
 Flash Menu, I-5
 flushkeybuf, 17-18
 FN, B-57, B-91
 FONT, B-92
 FOR, 8-7, B-93
 FOREGROUND, 8-44, B-94
 FRAME1K, P-11
 FRAME2K, P-11
 FRE, B-95
 FREAD, B-96
 Freeze Menu, I-5
 FWRITE, B-97

Games

 Guess the number, 8-33
GET, B-98
GET#, B-99
getcharsetaddr, 17-5
getcolramoffset, 17-4
GETKEY, B-100
getkeymodstate, 17-18
getmapedpal, 17-10
getpalbank, 17-9
getpalbanka, 17-9
getscreenaddr, 17-4
getscreensize, 17-5
GO64, B-101
gohome, 17-12
GOSUB, B-102
GOTO, 8-46, B-103
gotox, 17-12
gotoxy, 17-12
gotoy, 17-13
GRAPHIC, B-104
Guess the number, 8-33

HEADER, B-105
HELP, B-106, K-16
HEX\$, B-107
HIGHLIGHT, B-108
highlight, 17-7
hline, 17-11
HYPERTRAP, K-14

I/O

 blocking, 8-21
IF, 8-30, B-109
Illegal Direct Error, 8-18
IMDH™, M-9
INC, H-31, H-85
INPUT, 8-17, 8-24, B-110
INPUT#, B-111
INQ, G-14, H-125
INSTR, B-113
INT, B-114

Integrated Marvellous Digital

 Hookup™, M-9
INTERRUPTS, K-18
INW, H-85
INX, H-32, H-86
INY, H-32, H-86
INZ, H-86
ISC, H-32

JMP, H-33, H-87
JOY, B-115
JSR, H-34, H-87

kbhit, 17-18
KEY, B-116
Keyboard
 matrix, D-4
KIL, H-34

LAS, H-35
LAX, H-36
LDA, H-36, H-88, H-126
LDQ, G-14, H-126
LDX, H-37, H-89
LDY, H-38, H-89
LDZ, H-90
LEFT\$, B-118
LEN, B-119
LET, 8-15, B-120
light pen, Q-21
LINE, B-121
Line Drawing, L-13
 DMA Option Bytes, L-13
LINE INPUT#, B-122
Lines
 editing, 8-25
 renumbering, 8-38
 replacing, 8-25
LIST, 8-11, 8-12, B-123
LOAD, B-124
LOADIFF, B-126
LOADMEMORY, K-18
LOG, B-128

LOG10, B-129
LOOP, B-130
LPEN, B-131
LSR, H-38, H-90
LSRQ, G-14, H-127

MAP, G-8-G-10, H-91
MEGA Flash, I-5
MEMORY, K-6, K-18
Memory banking, G-8-G-10
MERGE, B-132
MID\$, B-133
mixer, audio, Q-23
MOD, B-134
MOD-file style audio, L-17
MONITOR, B-135
 Enhanced MEGA65 ROM
 Monitor, K-7
 Matrix Mode/Serial Monitor
 Interface, K-12
 Standard C65 ROM Monitor, K-3

MONITOR Commands
ASSEMBLE, K-10
BITMAPS, K-11
BREAKPOINT, K-16
CPUHISTORY, K-20
CPUMEMORY, K-15
DEBUGMON, K-18
DISASSEMBLE, K-5, K-16
FILL, K-17
FLAGWATCH, K-17
HELP, K-16
HYPERTRAP, K-14
INTERRUPTS, K-18
LOADMEMORY, K-18
MEMORY, K-6, K-18
REGISTERS, K-19
SETMEMORY, K-19
SETPC, K-17
TRACE, K-19
UARTDIVISOR, K-15
WATCHPOINT, K-19

MOUSE, B-136

movedown, 17-13
moveleft, 17-13
moveright, 17-14
moveup, 17-13
MOVSPR, B-137

name spaces, 8-17
NEG, H-92
NEW, B-139
NEXT, B-140
NO SCROLL, 8-47
NOP, H-39
NOT, B-141
not equal, 8-31

OFF, B-142
ON, B-143
OPEN, B-145
OpenROMs, 13-4
operators
 relational, 8-30

OR, B-146
ORA, H-40, H-92, H-128
ORQ, G-14, H-129

PAINT, B-147
PALETTE, B-148
PEEK, B-149
PEEKW, B-150
PEN, B-151
PHA, H-41, H-93
PHP, H-41, H-93
PHW, H-94
PHX, H-94
PHY, H-94
PHZ, H-95
PIXEL, B-152
PLA, H-42, H-95
PLAY, B-153
PLP, H-42, H-95
PLX, H-96
PLY, H-96
PLZ, H-97

POINTER, B-156	\$D014, M-35
POKE, B-157	\$D015, M-35
POKEW, B-158	\$D016, M-35
POLYGON, B-159	\$D017, M-35
PORT, G-16	\$D018, M-35
PORTDDR, G-16	\$D019, M-35
POS, B-160	\$D01A, M-35
POT, B-161	\$D01B, M-35
PRINT, 8-11, B-162	\$D01C, M-35
PRINT USING, B-164	\$D01D, M-35
PRINT#, B-163	\$D01E, M-35
Programmes	\$D01F, M-35
editing, 8-25	\$D020, M-35, M-38, M-41
replacing lines, 8-25	\$D021, M-35, M-38, M-41
quote mode, 8-35	\$D022, M-35, M-38, M-41
	\$D023, M-35, M-38, M-41
	\$D024, M-36, M-38, M-41
RCOLOR, B-166	\$D025, M-36, M-38, M-42
RCURSOR, B-167	\$D026, M-36, M-38, M-42
READ, B-168	\$D027, M-36
RECORD, B-169	\$D028, M-36
REGISTERS, K-19	\$D029, M-36
Registers	\$D02A, M-36
\$D000, M-35	\$D02B, M-36
\$D001, M-35	\$D02C, M-36
\$D002, M-35	\$D02D, M-36
\$D003, M-35	\$D02E, M-36
\$D004, M-35	\$D02F, M-38, M-42
\$D005, M-35	\$D030, M-36, M-38
\$D006, M-35	\$D031, M-38
\$D007, M-35	\$D033, M-38
\$D008, M-35	\$D034, M-39
\$D009, M-35	\$D035, M-39
\$D00A, M-35	\$D036, M-39
\$D00B, M-35	\$D037, M-39
\$D00C, M-35	\$D038, M-39
\$D00D, M-35	\$D039, M-39
\$D00E, M-35	\$D03A, M-39
\$D00F, M-35	\$D03B, M-39
\$D010, M-35	\$D03C, M-39
\$D011, M-35	\$D03D, M-39
\$D012, M-35	\$D03E, M-39
\$D013, M-35	

\$D03F, M-39
\$D040, M-39
\$D041, M-39
\$D042, M-39
\$D043, M-39
\$D044, M-39
\$D045, M-39
\$D046, M-39
\$D047, M-39
\$D048, M-42
\$D049, M-42
\$D04A, M-42
\$D04B, M-42
\$D04C, M-42
\$D04D, M-42
\$D04E, M-42
\$D04F, M-42
\$D050, M-42
\$D051, M-42
\$D052, M-42
\$D053, M-42
\$D054, M-42
\$D055, M-42
\$D056, M-42
\$D057, M-42
\$D058, M-42
\$D059, M-42
\$D05A, M-42
\$D05B, M-42
\$D05C, M-42
\$D05D, M-42
\$D05E, M-42
\$D05F, M-42
\$D060, M-42
\$D061, M-42
\$D062, M-42
\$D063, M-42
\$D064, M-42
\$D065, M-42
\$D068, M-42
\$D069, M-42
\$D06A, M-42

\$D06B, M-42
\$D06C, M-42
\$D06D, M-43
\$D06E, M-43
\$D06F, M-43
\$D070, M-43
\$D071, M-43
\$D072, M-43
\$D073, M-43
\$D074, M-43
\$D075, M-43
\$D076, M-43
\$D077, M-43
\$D078, M-43
\$D079, M-43
\$D07A, M-43
\$D07B, M-43
\$D07C, M-43
\$D080, Q-11
\$D081, Q-11
\$D082, Q-11
\$D083, Q-11
\$D084, Q-11
\$D085, Q-11
\$D086, Q-11
\$D087, Q-11
\$D088, Q-11
\$D089, Q-11
\$D08A, Q-11
\$D100 - \$D1FF, M-39
\$D200 - \$D2FF, M-39
\$D300 - \$D3FF, M-39
\$D600, O-3
\$D601, O-3
\$D602, O-3
\$D603, O-3
\$D604, O-3
\$D605, O-3
\$D606, O-3
\$D609, O-4
\$D60B, O-4
\$D60C, O-4

\$D60D, O-4	\$D653, G-17, G-34
\$D60E, O-4	\$D654, G-17, G-34
\$D60F, O-4	\$D655, G-17, G-34
\$D610, O-4	\$D656, G-17, G-34
\$D611, O-4	\$D657, G-17, G-34
\$D612, O-4	\$D658, G-17, G-34
\$D615, O-4	\$D659, G-17, G-34
\$D616, O-4	\$D65A, G-17
\$D617, O-4	\$D65B, G-17
\$D618, O-4	\$D65C, G-17
\$D619, O-4	\$D65D, G-17
\$D61A, O-4	\$D65E, G-17
\$D61D, O-4	\$D65F, G-17
\$D61E, O-4	\$D660, G-17
\$D620, O-4	\$D661, G-17
\$D621, O-4	\$D662, G-18
\$D622, O-4	\$D663, G-18
\$D623, O-4	\$D664, G-18
\$D625, O-4	\$D665, G-18
\$D626, O-4	\$D666, G-18
\$D627, O-4	\$D667, G-18
\$D628, O-4	\$D668, G-18
\$D629, O-5	\$D669, G-18
\$D640, G-17, G-33	\$D66A, G-18
\$D641, G-17, G-33	\$D66B, G-18
\$D642, G-17	\$D66C, G-18
\$D643, G-17, G-33	\$D66D, G-18
\$D644, G-17, G-34	\$D66E, G-18
\$D645, G-17, G-34	\$D66F, G-18
\$D646, G-17, G-34	\$D670, G-18, G-34
\$D647, G-17, G-34	\$D671, G-18, G-34
\$D648, G-17, G-34	\$D672, G-18, G-34
\$D649, G-17, G-34	\$D673, G-18
\$D64A, G-17, G-34	\$D674, G-18
\$D64B, G-17, G-34	\$D675, G-18
\$D64C, G-17, G-34	\$D676, G-18
\$D64D, G-17, G-34	\$D677, G-18
\$D64E, G-17, G-34	\$D678, G-18
\$D64F, G-17, G-34	\$D679, G-18
\$D650, G-17, G-34	\$D67A, G-18
\$D651, G-17, G-34	\$D67B, G-18
\$D652, G-17, G-34	\$D67C, G-18, G-34

\$D67D, G-18, G-34
\$D67E, G-18, G-34
\$D67F, G-18, G-34
\$D680, Q-19
\$D681, Q-19
\$D682, Q-19
\$D683, Q-19
\$D684, Q-19
\$D686, Q-19
\$D68A, Q-19
\$D68B, Q-14
\$D68C, Q-14
\$D68D, Q-14
\$D68E, Q-14
\$D68F, Q-14
\$D690, Q-14
\$D691, Q-15
\$D692, Q-15
\$D693, Q-15
\$D6A0, Q-13
\$D6A1, Q-15
\$D6A2, Q-13
\$D6AE, Q-19
\$D6AF, Q-19
\$D6B0, Q-21
\$D6B1, Q-21
\$D6B2, Q-21
\$D6B3, Q-21
\$D6B4, Q-21
\$D6B5, Q-21
\$D6B7, Q-21
\$D6B8, Q-21
\$D6B9, Q-21
\$D6BA, Q-21
\$D6BB, Q-21
\$D6BC, Q-21
\$D6BD, Q-22
\$D6BE, Q-22
\$D6C0, Q-22
\$D6E0, P-9
\$D6E1, P-9
\$D6E2, P-9

\$D6E3, P-9
\$D6E4, P-9
\$D6E5, P-9
\$D6E6, P-9
\$D6E7, P-9
\$D6E8, P-9
\$D6E9, P-9
\$D6EA, P-9
\$D6EB, P-9
\$D6EC, P-9
\$D6ED, P-9
\$D6EE, P-9
\$D6F4, Q-25
\$D6F5, Q-25
\$D6F8, Q-25
\$D6F9, Q-25
\$D6FA, Q-25
\$D6FB, Q-25
\$D6FC, Q-25
\$D6FD, Q-25
\$D700, L-20
\$D701, L-20
\$D702, L-20
\$D703, L-20
\$D704, L-20
\$D705, L-20
\$D70E, L-20
\$D70F, G-22
\$D710, G-18
\$D711, L-20, Q-25
\$D71C, L-20
\$D71D, L-20
\$D71E, L-20
\$D71F, L-20
\$D720, L-20
\$D721, L-20
\$D722, L-20
\$D723, L-20
\$D724, L-20
\$D725, L-20
\$D726, L-20
\$D727, L-20

\$D728, L-20
\$D729, L-20
\$D72A, L-20
\$D72B, L-20
\$D72C, L-20
\$D72D, L-20
\$D72E, L-20
\$D72F, L-21
\$D730, L-21
\$D731, L-21
\$D732, L-21
\$D733, L-21
\$D734, L-21
\$D735, L-21
\$D736, L-21
\$D737, L-21
\$D738, L-21
\$D739, L-21
\$D73A, L-21
\$D73B, L-21
\$D73C, L-21
\$D73D, L-21
\$D73E, L-21
\$D73F, L-21
\$D740, L-21
\$D741, L-21
\$D742, L-21
\$D743, L-21
\$D744, L-21
\$D745, L-21
\$D746, L-21
\$D747, L-21
\$D748, L-21
\$D749, L-21
\$D74A, L-21
\$D74B, L-21
\$D74C, L-21
\$D74D, L-21
\$D74E, L-21
\$D74F, L-21
\$D750, L-21
\$D751, L-21

\$D752, L-21
\$D753, L-21
\$D754, L-21
\$D755, L-22
\$D756, L-22
\$D757, L-22
\$D758, L-22
\$D759, L-22
\$D75A, L-22
\$D75B, L-22
\$D75C, L-22
\$D75D, L-22
\$D75E, L-22
\$D75F, L-22
\$D768, G-22
\$D769, G-22
\$D76A, G-22
\$D76B, G-22
\$D76C, G-22
\$D76D, G-22
\$D76E, G-22
\$D76F, G-22
\$D770, G-22
\$D771, G-22
\$D772, G-22
\$D773, G-22
\$D774, G-22
\$D775, G-22
\$D776, G-22
\$D777, G-22
\$D778, G-22
\$D779, G-22
\$D77A, G-22
\$D77B, G-22
\$D77C, G-22
\$D77D, G-22
\$D77E, G-22
\$D77F, G-22
\$D780, G-22
\$D781, G-22
\$D782, G-22
\$D783, G-22

\$D784, G-22
\$D785, G-22
\$D786, G-22
\$D787, G-22
\$D788, G-23
\$D789, G-23
\$D78A, G-23
\$D78B, G-23
\$D78C, G-23
\$D78D, G-23
\$D78E, G-23
\$D78F, G-23
\$D790, G-23
\$D791, G-23
\$D792, G-23
\$D793, G-23
\$D794, G-23
\$D795, G-23
\$D796, G-23
\$D797, G-23
\$D798, G-23
\$D799, G-23
\$D79A, G-23
\$D79B, G-23
\$D79C, G-23
\$D79D, G-23
\$D79E, G-23
\$D79F, G-23
\$D7A0, G-23
\$D7A1, G-23
\$D7A2, G-23
\$D7A3, G-23
\$D7A4, G-23
\$D7A5, G-23
\$D7A6, G-23
\$D7A7, G-23
\$D7A8, G-23
\$D7A9, G-23
\$D7AA, G-23
\$D7AB, G-23
\$D7AC, G-23
\$D7AD, G-23

\$D7AE, G-24
\$D7AF, G-24
\$D7B0, G-24
\$D7B1, G-24
\$D7B2, G-24
\$D7B3, G-24
\$D7B4, G-24
\$D7B5, G-24
\$D7B6, G-24
\$D7B7, G-24
\$D7B8, G-24
\$D7B9, G-24
\$D7BA, G-24
\$D7BB, G-24
\$D7BC, G-24
\$D7BD, G-24
\$D7BE, G-24
\$D7BF, G-24
\$D7C0, G-24
\$D7C1, G-24
\$D7C2, G-24
\$D7C3, G-24
\$D7C4, G-24
\$D7C5, G-24
\$D7C6, G-24
\$D7C7, G-24
\$D7C8, G-24
\$D7C9, G-24
\$D7CA, G-24
\$D7CB, G-24
\$D7CC, G-24
\$D7CD, G-24
\$D7CE, G-24
\$D7CF, G-24
\$D7D0, G-24
\$D7D1, G-24
\$D7D2, G-24
\$D7D3, G-24
\$D7D4, G-25
\$D7D5, G-25
\$D7D6, G-25
\$D7D7, G-25

\$D7D8, G-25
\$D7D9, G-25
\$D7DA, G-25
\$D7DB, G-25
\$D7DC, G-25
\$D7DD, G-25
\$D7DE, G-25
\$D7DF, G-25
\$D7E0, G-25
\$D7E1, G-25
\$D7E2, G-25
\$D7E3, G-25
\$D7FA, G-18
\$D7FB, G-18
\$D7FD, G-18
\$D7FE, G-18
\$DC00, N-3
\$DC01, N-3
\$DC02, N-3
\$DC03, N-3
\$DC04, N-3
\$DC05, N-3
\$DC06, N-3
\$DC07, N-3
\$DC08, N-3
\$DC09, N-3
\$DC0A, N-3
\$DC0B, N-3
\$DC0C, N-3
\$DC0D, N-3
\$DC0E, N-3
\$DC0F, N-3, N-4
\$DC10, N-6
\$DC11, N-6
\$DC12, N-6
\$DC13, N-6
\$DC14, N-6
\$DC15, N-6
\$DC16, N-6
\$DC17, N-6
\$DC18, N-6
\$DC19, N-6

\$DC1A, N-6
\$DC1B, N-6
\$DC1C, N-6
\$DC1D, N-6
\$DC1E, N-6
\$DC1F, N-6
\$DD00, N-4
\$DD01, N-4
\$DD02, N-4
\$DD03, N-4
\$DD04, N-4
\$DD05, N-4
\$DD06, N-4
\$DD07, N-4
\$DD08, N-4
\$DD09, N-4
\$DD0A, N-4
\$DD0B, N-4
\$DD0C, N-5
\$DD0D, N-5
\$DD0E, N-5
\$DD0F, N-5
\$DD10, N-7
\$DD11, N-7
\$DD12, N-7
\$DD13, N-7
\$DD14, N-7
\$DD15, N-7
\$DD16, N-7
\$DD17, N-7
\$DD18, N-7
\$DD19, N-7
\$DD1A, N-7
\$DD1B, N-7
\$DD1C, N-7
\$DD1D, N-7
\$DD1E, N-7
\$DD1F, N-7
53504 - 53759, M-39
53760 - 54015, M-39
54016 - 54271, M-39
53248, M-35

53249, M-35
53250, M-35
53251, M-35
53252, M-35
53253, M-35
53254, M-35
53255, M-35
53256, M-35
53257, M-35
53258, M-35
53259, M-35
53260, M-35
53261, M-35
53262, M-35
53263, M-35
53264, M-35
53265, M-35
53266, M-35
53267, M-35
53268, M-35
53269, M-35
53270, M-35
53271, M-35
53272, M-35
53273, M-35
53274, M-35
53275, M-35
53276, M-35
53277, M-35
53278, M-35
53279, M-35
53280, M-35, M-38, M-41
53281, M-35, M-38, M-41
53282, M-35, M-38, M-41
53283, M-35, M-38, M-41
53284, M-36, M-38, M-41
53285, M-36, M-38, M-42
53286, M-36, M-38, M-42
53287, M-36
53288, M-36
53289, M-36
53290, M-36
53291, M-36
53292, M-36
53293, M-36
53294, M-36
53295, M-38, M-42
53296, M-36, M-38
53297, M-38
53299, M-38
53300, M-39
53301, M-39
53302, M-39
53303, M-39
53304, M-39
53305, M-39
53306, M-39
53307, M-39
53308, M-39
53309, M-39
53310, M-39
53311, M-39
53312, M-39
53313, M-39
53314, M-39
53315, M-39
53316, M-39
53317, M-39
53318, M-39
53319, M-39
53320, M-42
53321, M-42
53322, M-42
53323, M-42
53324, M-42
53325, M-42
53326, M-42
53327, M-42
53328, M-42
53329, M-42
53330, M-42
53331, M-42
53332, M-42
53333, M-42

53334, M-42	53381, Q-11
53335, M-42	53382, Q-11
53336, M-42	53383, Q-11
53337, M-42	53384, Q-11
53338, M-42	53385, Q-11
53339, M-42	53386, Q-11
53340, M-42	54784, O-3
53341, M-42	54785, O-3
53342, M-42	54786, O-3
53343, M-42	54787, O-3
53344, M-42	54788, O-3
53345, M-42	54789, O-3
53346, M-42	54790, O-3
53347, M-42	54793, O-4
53348, M-42	54795, O-4
53349, M-42	54796, O-4
53352, M-42	54797, O-4
53353, M-42	54798, O-4
53354, M-42	54799, O-4
53355, M-42	54800, O-4
53356, M-42	54801, O-4
53357, M-43	54802, O-4
53358, M-43	54805, O-4
53359, M-43	54806, O-4
53360, M-43	54807, O-4
53361, M-43	54808, O-4
53362, M-43	54809, O-4
53363, M-43	54810, O-4
53364, M-43	54813, O-4
53365, M-43	54814, O-4
53366, M-43	54816, O-4
53367, M-43	54817, O-4
53368, M-43	54818, O-4
53369, M-43	54819, O-4
53370, M-43	54821, O-4
53371, M-43	54822, O-4
53372, M-43	54823, O-4
53376, Q-11	54824, O-4
53377, Q-11	54825, O-5
53378, Q-11	54848, G-17, G-33
53379, Q-11	54849, G-17, G-33
53380, Q-11	54850, G-17

54851, G-17, G-33
54852, G-17, G-34
54853, G-17, G-34
54854, G-17, G-34
54855, G-17, G-34
54856, G-17, G-34
54857, G-17, G-34
54858, G-17, G-34
54859, G-17, G-34
54860, G-17, G-34
54861, G-17, G-34
54862, G-17, G-34
54863, G-17, G-34
54864, G-17, G-34
54865, G-17, G-34
54866, G-17, G-34
54867, G-17, G-34
54868, G-17, G-34
54869, G-17, G-34
54870, G-17, G-34
54871, G-17, G-34
54872, G-17, G-34
54873, G-17, G-34
54874, G-17
54875, G-17
54876, G-17
54877, G-17
54878, G-17
54879, G-17
54880, G-17
54881, G-17
54882, G-18
54883, G-18
54884, G-18
54885, G-18
54886, G-18
54887, G-18
54888, G-18
54889, G-18
54890, G-18
54891, G-18
54892, G-18

54893, G-18
54894, G-18
54895, G-18
54896, G-18, G-34
54897, G-18, G-34
54898, G-18, G-34
54899, G-18
54900, G-18
54901, G-18
54902, G-18
54903, G-18
54904, G-18
54905, G-18
54906, G-18
54907, G-18
54908, G-18, G-34
54909, G-18, G-34
54910, G-18, G-34
54911, G-18, G-34
54912, Q-19
54913, Q-19
54914, Q-19
54915, Q-19
54916, Q-19
54918, Q-19
54922, Q-19
54923, Q-14
54924, Q-14
54925, Q-14
54926, Q-14
54927, Q-14
54928, Q-14
54929, Q-15
54930, Q-15
54931, Q-15
54944, Q-13
54945, Q-15
54946, Q-13
54958, Q-19
54959, Q-19
54960, Q-21
54961, Q-21

54962, Q-21
54963, Q-21
54964, Q-21
54965, Q-21
54967, Q-21
54968, Q-21
54969, Q-21
54970, Q-21
54971, Q-21
54972, Q-21
54973, Q-22
54974, Q-22
54976, Q-22
55008, P-9
55009, P-9
55010, P-9
55011, P-9
55012, P-9
55013, P-9
55014, P-9
55015, P-9
55016, P-9
55017, P-9
55018, P-9
55019, P-9
55020, P-9
55021, P-9
55022, P-9
55028, Q-25
55029, Q-25
55032, Q-25
55033, Q-25
55034, Q-25
55035, Q-25
55036, Q-25
55037, Q-25
55040, L-20
55041, L-20
55042, L-20
55043, L-20
55044, L-20
55045, L-20

55054, L-20
55055, G-22
55056, G-18
55057, L-20, Q-25
55068, L-20
55069, L-20
55070, L-20
55071, L-20
55072, L-20
55073, L-20
55074, L-20
55075, L-20
55076, L-20
55077, L-20
55078, L-20
55079, L-20
55080, L-20
55081, L-20
55082, L-20
55083, L-20
55084, L-20
55085, L-20
55086, L-20
55087, L-21
55088, L-21
55089, L-21
55090, L-21
55091, L-21
55092, L-21
55093, L-21
55094, L-21
55095, L-21
55096, L-21
55097, L-21
55098, L-21
55099, L-21
55100, L-21
55101, L-21
55102, L-21
55103, L-21
55104, L-21
55105, L-21

55106, L-21
55107, L-21
55108, L-21
55109, L-21
55110, L-21
55111, L-21
55112, L-21
55113, L-21
55114, L-21
55115, L-21
55116, L-21
55117, L-21
55118, L-21
55119, L-21
55120, L-21
55121, L-21
55122, L-21
55123, L-21
55124, L-21
55125, L-22
55126, L-22
55127, L-22
55128, L-22
55129, L-22
55130, L-22
55131, L-22
55132, L-22
55133, L-22
55134, L-22
55135, L-22
55144, G-22
55145, G-22
55146, G-22
55147, G-22
55148, G-22
55149, G-22
55150, G-22
55151, G-22
55152, G-22
55153, G-22
55154, G-22
55155, G-22

55156, G-22
55157, G-22
55158, G-22
55159, G-22
55160, G-22
55161, G-22
55162, G-22
55163, G-22
55164, G-22
55165, G-22
55166, G-22
55167, G-22
55168, G-22
55169, G-22
55170, G-22
55171, G-22
55172, G-22
55173, G-22
55174, G-22
55175, G-22
55176, G-23
55177, G-23
55178, G-23
55179, G-23
55180, G-23
55181, G-23
55182, G-23
55183, G-23
55184, G-23
55185, G-23
55186, G-23
55187, G-23
55188, G-23
55189, G-23
55190, G-23
55191, G-23
55192, G-23
55193, G-23
55194, G-23
55195, G-23
55196, G-23
55197, G-23

55198, G-23
55199, G-23
55200, G-23
55201, G-23
55202, G-23
55203, G-23
55204, G-23
55205, G-23
55206, G-23
55207, G-23
55208, G-23
55209, G-23
55210, G-23
55211, G-23
55212, G-23
55213, G-23
55214, G-24
55215, G-24
55216, G-24
55217, G-24
55218, G-24
55219, G-24
55220, G-24
55221, G-24
55222, G-24
55223, G-24
55224, G-24
55225, G-24
55226, G-24
55227, G-24
55228, G-24
55229, G-24
55230, G-24
55231, G-24
55232, G-24
55233, G-24
55234, G-24
55235, G-24
55236, G-24
55237, G-24
55238, G-24
55239, G-24

55240, G-24
55241, G-24
55242, G-24
55243, G-24
55244, G-24
55245, G-24
55246, G-24
55247, G-24
55248, G-24
55249, G-24
55250, G-24
55251, G-24
55252, G-25
55253, G-25
55254, G-25
55255, G-25
55256, G-25
55257, G-25
55258, G-25
55259, G-25
55260, G-25
55261, G-25
55262, G-25
55263, G-25
55264, G-25
55265, G-25
55266, G-25
55267, G-25
55290, G-18
55291, G-18
55293, G-18
55294, G-18
56320, N-3
56321, N-3
56322, N-3
56323, N-3
56324, N-3
56325, N-3
56326, N-3
56327, N-3
56328, N-3
56329, N-3

56330, N-3
56331, N-3
56332, N-3
56333, N-3
56334, N-3
56335, N-3, N-4
56336, N-6
56337, N-6
56338, N-6
56339, N-6
56340, N-6
56341, N-6
56342, N-6
56343, N-6
56344, N-6
56345, N-6
56346, N-6
56347, N-6
56348, N-6
56349, N-6
56350, N-6
56351, N-6
56576, N-4
56577, N-4
56578, N-4
56579, N-4
56580, N-4
56581, N-4
56582, N-4
56583, N-4
56584, N-4
56585, N-4
56586, N-4
56587, N-4
56588, N-5
56589, N-5
56590, N-5
56591, N-5
56592, N-7
56593, N-7
56594, N-7
56595, N-7

56596, N-7
56597, N-7
56598, N-7
56599, N-7
56600, N-7
56601, N-7
56602, N-7
56603, N-7
56604, N-7
56605, N-7
56606, N-7
56607, N-7
ABTPULSEL, M-43
ACCESSKEY, O-5
ADDRBANK, L-20
ADDRLSB, L-20, L-22
ADDRLSBTRIG, L-20
ADDRMB, L-20, L-22
ADDRMSB, L-20
ALGO, Q-11
ALPHADELAY, M-43
ALPHEN, M-43
ALRM, N-3, N-5
ALRMAMP, N-6, N-7
ALRMHOUR, N-6-N-8
ALRMJIF, N-6-N-8
ALRMMIN, N-6-N-8
ALRMSEC, N-6-N-8
ALT, Q-11
ASCFAST, G-34
ASCIKEY, O-4, O-5
ATTR, M-39
AUDBLKTO, L-20, L-22
AUDEN, L-22
AUDWRBLK, L-22
AUTO2XSEL, Q-19
BOADEVN, M-38, M-39
BOADODD, M-38, M-39
BOPIX, M-39
B1ADEVN, M-39
B1ADODD, M-39
B1PIX, M-39

B2ADEVN, M-39
 B2ADODD, M-39
 B2PIX, M-39, M-40
 B3ADEVN, M-39, M-40
 B3ADODD, M-39, M-40
 B3PIX, M-39, M-40
 B4ADEVN, M-39, M-40
 B4ADODD, M-39, M-40
 B4PIX, M-39, M-40
 B5ADEVN, M-39, M-40
 B5ADODD, M-39, M-40
 B5PIX, M-39, M-40
 B6ADEVN, M-39, M-40
 B6ADODD, M-39, M-40
 B6PIX, M-39, M-40
 B7ADEVN, M-39, M-40
 B7ADODD, M-39, M-40
 B7PIX, M-39, M-40
 BADEXTRA, G-18
 BASHDDR, O-4, O-5
 BBDRPOS, M-42, M-43
 BCST, P-9
 BITPBANK, M-43
 BLKD, L-22
 BLNK, M-36
 BMM, M-36
 BORDERCOL, M-35, M-36,
 M-38, M-40, M-41, M-43
 BP16ENS, M-43
 BPCOMP, M-39, M-40
 BPM, M-40
 BPX, M-39, M-40
 BPY, M-39, M-40
 BRCOST, G-19
 BSP, M-35, M-36
 BTPALSEL, M-43
 BUSY, Q-11
 C128FAST, M-36
 CALCEN, G-25
 CALXDELTALSB, Q-21, Q-22
 CALXSCALELSB, Q-21, Q-22
 CALXSCALEMSB, Q-21, Q-22
 CALYDELTALSB, Q-21, Q-22
 CALYDELTAMSB, Q-21, Q-22
 CALYSCALELSB, Q-21, Q-22
 CALYSCALEMSB, Q-21, Q-22
 CARTEN, G-19
 CB, M-35, M-36
 CDC00, Q-19
 CH0BADDR, L-20, L-22
 CH0CURADDR, L-20, L-22
 CH0EN, L-22
 CH0FREQ, L-20, L-22
 CH0LOOP, L-22
 CH0RVOL, L-20, L-22
 CH0SBITS, L-20, L-22
 CH0SGN, L-22
 CH0SINE, L-22
 CH0STP, L-22
 CH0TADDR, L-20, L-22
 CH0TMRADDR, L-20, L-21, L-23
 CH0VOLUME, L-20, L-23
 CH1BADDR, L-21, L-23
 CH1CURADDR, L-21, L-23
 CH1EN, L-23
 CH1FREQ, L-21, L-23
 CH1LOOP, L-23
 CH1RVOL, L-20, L-23
 CH1SBITS, L-21, L-23
 CH1SGN, L-23
 CH1SINE, L-23
 CH1STP, L-23
 CH1TADDR, L-21, L-23
 CH1TMRADDR, L-21, L-23
 CH1VOLUME, L-21, L-23
 CH2BADDR, L-21, L-23
 CH2CURADDR, L-21, L-23
 CH2EN, L-23
 CH2FREQ, L-21, L-23
 CH2LOOP, L-23
 CH2LVOL, L-20, L-23
 CH2SGN, L-23
 CH2SINE, L-23
 CH2STP, L-23

CH2TADDR, L-21, L-23
 CH2TMRADDR, L-21, L-23
 CH2VOLUME, L-21, L-23
 CH3BADDR, L-21, L-23
 CH3CURADDR, L-22, L-24
 CH3EN, L-24
 CH3FREQ, L-21, L-22, L-24
 CH3LOOP, L-24
 CH3LVOL, L-20, L-24
 CH3SBITS, L-21, L-24
 CH3SGN, L-24
 CH3SINE, L-24
 CH3STP, L-24
 CH3TADDR, L-22, L-24
 CH3TMRADDR, L-22, L-24
 CH3VOLUME, L-22, L-24
 CHARPTR, M-42, M-43
 CHARSZ, O-3
 CHR16, M-43
 CHRCOUNT, M-42, M-43
 CHRXSCL, M-42, M-43
 CHRYSCL, M-42, M-43
 CLOCK, Q-11
 CMDANDSTAT, Q-19
 COLPTR, M-42, M-44
 COMMAND, P-9, Q-11
 CONN41, O-5
 CPUFAST, G-34
 CRAM2K, M-40
 CRC, Q-11
 CROM9, M-40
 CSEL, M-36
 D0IMG, Q-15
 D0MD, Q-15
 D0P, Q-15
 D0STARTSEC0, Q-14, Q-15
 D0STARTSEC1, Q-14, Q-15
 D0STARTSEC2, Q-14, Q-15
 D0STARTSEC3, Q-14, Q-15
 D0WP, Q-15
 D1IMG, Q-15
 D1MD, Q-15
 D1P, Q-15
 D1STARTSEC0, Q-14, Q-15
 D1STARTSEC1, Q-15
 D1STARTSEC2, Q-15
 D1STARTSEC3, Q-15
 D1WP, Q-15
 DATA, O-3, Q-11
 DATARATE, Q-13
 DBGDIR, Q-13
 DBGMOTORA, Q-13
 DBGWDATA, Q-13
 DBGWGATE, Q-13
 DBLRR, M-44
 DD00DELAY, N-8
 DDRA, N-3-N-5
 DDRB, N-3-N-5
 DEBUGC, M-43, M-44
 DENSITY, Q-13
 DIGILEFTLSB, Q-25
 DIGILEFTMSB, Q-25
 DIGILLSB, Q-25
 DIGILMSB, Q-25
 DIGIRIGHTLSB, Q-25
 DIGIRIGHTMSB, Q-25
 DIGIRLSB, Q-25
 DIGIRMSB, Q-25
 DIR, Q-11
 DISKIN, Q-11
 DIVBUSY, G-25
 DIVISOR, O-3
 DIVOUT, G-22, G-25
 DMADSTMB, G-34
 DMALADDR, G-34
 DMASRCMB, G-34
 DRQ, Q-12
 DRXD, P-9
 DRXDV, P-9
 DS, Q-11, Q-12
 DSKCHG, Q-12
 ECM, M-36
 EN018B, L-24
 ENTEREXIT, G-34, G-35

EQ, Q-12
 ETRIG, L-20, L-24
 EV1, Q-22
 EV2, Q-22
 EXGLYPH, M-44
 EXSID, G-35
 EXTIRQS, M-44
 EXTSYNC, M-40
 F4502, G-35
 FAST, M-40
 FCLRHI, M-44
 FCLRLO, M-44
 FDC2XSEL, Q-19
 FDCVARSPD, Q-19
 FILLVAL, Q-19
 FLG, N-3, N-5
 FNRASTER, M-42, M-44
 FNRST, M-44
 FNRSTCMP, M-44
 FRAMECOUNT, G-18, G-19
 FREE, Q-12
 FRMERR, O-3
 GEORAMBASE, G-34, G-35
 GEORAMMASK, G-34, G-35
 GESTUREDID, Q-22
 GESTUREID, Q-22
 H1280, M-40
 H640, M-40
 HDSCL, O-5
 HSDA, O-5
 HICKED, G-34, G-35
 HOTREG, M-44
 HPOS, M-39, M-40
 HSYNCP, M-44
 HTRAP00, G-17, G-19
 HTRAP01, G-17, G-19
 HTRAP02, G-17, G-19
 HTRAP03, G-17, G-19
 HTRAP04, G-17, G-19
 HTRAP05, G-17, G-19
 HTRAP06, G-17, G-19
 HTRAP07, G-17, G-19
 HTRAP08, G-17, G-19
 HTRAP09, G-17, G-19
 HTRAP0A, G-17, G-19
 HTRAP0B, G-17, G-19
 HTRAP0C, G-17, G-19
 HTRAP0D, G-17, G-19
 HTRAP0E, G-17, G-19
 HTRAP0F, G-17, G-19
 HTRAP10, G-17, G-19
 HTRAP11, G-17, G-19
 HTRAP12, G-17, G-19
 HTRAP13, G-17, G-19
 HTRAP14, G-17, G-19
 HTRAP15, G-17, G-19
 HTRAP16, G-17, G-19
 HTRAP17, G-17, G-19
 HTRAP18, G-17, G-19
 HTRAP19, G-17, G-20
 HTRAP1A, G-17, G-20
 HTRAP1B, G-17, G-20
 HTRAP1C, G-17, G-20
 HTRAP1D, G-17, G-20
 HTRAP1E, G-17, G-20
 HTRAP1F, G-17, G-20
 HTRAP20, G-17, G-20
 HTRAP21, G-17, G-20
 HTRAP22, G-18, G-20
 HTRAP23, G-18, G-20
 HTRAP24, G-18, G-20
 HTRAP25, G-18, G-20
 HTRAP26, G-18, G-20
 HTRAP27, G-18, G-20
 HTRAP28, G-18, G-20
 HTRAP29, G-18, G-20
 HTRAP2A, G-18, G-20
 HTRAP2B, G-18, G-20
 HTRAP2C, G-18, G-20
 HTRAP2D, G-18, G-20
 HTRAP2E, G-18, G-20
 HTRAP2F, G-18, G-20
 HTRAP30, G-18, G-20
 HTRAP31, G-18, G-20

HTRAP32, G-18, G-20
 HTRAP33, G-18, G-20
 HTRAP34, G-18, G-20
 HTRAP35, G-18, G-21
 HTRAP36, G-18, G-21
 HTRAP37, G-18, G-21
 HTRAP38, G-18, G-21
 HTRAP39, G-18, G-21
 HTRAP3A, G-18, G-21
 HTRAP3B, G-18, G-21
 HTRAP3C, G-18, G-21
 HTRAP3D, G-18, G-21
 HTRAP3E, G-18, G-21
 HTRAP3F, G-18, G-21
 IFRXIRQ, O-3
 IFRXNMI, O-3
 IFTXIRQ, O-3
 IFTXNMI, O-3
 ILP, M-36
 IMALRM, N-7, N-8
 IMFLG, N-7, N-8
 IMODA, N-3, N-5
 IMODB, N-3, N-5
 IMRXIRQ, O-3
 IMRXNMI, O-3
 IMSP, N-7, N-8
 IMTB, N-7, N-8
 IMTXIRQ, O-3
 IMTXNMI, O-3
 INDEX, Q-12
 INT, M-41
 IR, N-3
 IRQ, Q-12
 ISBC, M-36
 ISSC, M-36
 J21H, O-4, O-5
 J21HDDR, O-4, O-5
 J21L, O-4, O-5
 J21LDDR, O-4, O-5
 JMP32EN, G-35
 JOYSWAP, O-5
 KEY, M-38, M-41, M-42, M-44
 Keyboard, O-4, O-5
 KEYEN, P-9
 KEYLEFT, O-5
 KEYUP, O-5
 KSCNRATE, O-4, O-5
 LATCHINT, G-25
 LED, Q-12
 LINESTEP, M-42, M-44
 LJOYA, O-5
 LJOYB, O-5
 LOAD, N-3, N-5
 LOST, Q-12
 LPX, M-35, M-36
 LPY, M-35, M-36
 M65MODEL, O-5
 MACADDR1, P-9
 MACADDR2, P-9, P-10
 MACADDR3, P-9, P-10
 MACADDR4, P-9, P-10
 MACADDR5, P-9, P-10
 MACADDR6, P-9, P-10
 MALT, O-5
 MAPEDPAL, M-43, M-44
 MAPHI, G-34, G-35
 MAPHIMB, G-34, G-35
 MAPLO, G-34, G-35
 MAPLOMB, G-34, G-35
 MATHIN0, G-22, G-25
 MATHIN1, G-22, G-25
 MATHIN10, G-23, G-25
 MATHIN11, G-23, G-25
 MATHIN12, G-24, G-25
 MATHIN13, G-24, G-25
 MATHIN14, G-24, G-25
 MATHIN15, G-24, G-25
 MATHIN2, G-23, G-25
 MATHIN3, G-23, G-25
 MATHIN4, G-23, G-25
 MATHIN5, G-23, G-26
 MATHIN6, G-23, G-26
 MATHIN7, G-23, G-26
 MATHIN8, G-23, G-26

MATHIN9, G-23, G-26
MATRIXEN, G-35
MC1, M-35, M-36, M-38, M-41,
M-44
MC2, M-35, M-36, M-38, M-41,
M-44
MC3, M-36, M-38, M-41, M-44
MCAPS, O-5
MCM, M-36
MCST, P-10
MCTRL, O-5
MIIMPHY, P-9, P-10
MIIMREG, P-9, P-10
MIIMVLSB, P-9, P-10
MIIMVMSB, P-9, P-10
MISBC, M-37
MISSC, M-37
MIXREGDATA, Q-25
MIXREGSEL, Q-25
MLSHFT, O-5
MMEGA, O-5
MONO, M-41
MOTOR, Q-12
MRIRQ, M-37
MRSHFT, O-6
MSCRL, O-6
MULBUSY, G-26
MULTINA, G-22, G-26
MULTINB, G-22, G-26
MULTOUT, G-22, G-26
NOBUF, Q-12
NOCRC, P-10
NOEXROM, G-21
NOGAME, G-21
NOMIX, L-24
NOPROM, P-10
NORRDEL, M-44
Number, M-43, M-44
OCEANA, G-21
OMODA, N-3, N-5
OMODB, N-3, N-5
OSKALT, O-6
OSKDEBUG, O-6
OSKDIM, O-6
OSKEN, O-6
OSKTOP, O-6
OSKZEN, O-6
OSKZON, O-6
PAL, M-41
PALBLUE, M-39, M-41
PALEMU, M-44
PALGREEN, M-39, M-41
PALNTSC, M-44
PALRED, M-39, M-41
PBONA, N-3, N-5
PBONB, N-3, N-5
PCH, G-34, G-35
PCL, G-34, G-35
PCODE, Q-11, Q-12
PFLAGS, G-34, G-35
PIRQ, G-35
PNMI, G-35
PORT00, G-34, G-35
PORT01, G-34, G-35
PORTA, N-3-N-5
PORTB, N-3-N-5
PORTF, O-4, O-6
PORTFDDR, O-4, O-6
POTAX, O-4, O-6
POTAY, O-4, O-6
POTBX, O-4, O-6
POTBY, O-4, O-6
POWEREN, G-21
PREFETCH, G-21
PROT, Q-12
PTYEN, O-3
PTYERR, O-3
PTYEVEN, O-3
PWMPDM, Q-25
RASLINE0, M-43, M-44
RASTERHEIGHT, M-43, M-44
RC, M-35, M-37
RDCMD, Q-12
RDREQ, Q-12

READBACKLSB, Q-25
 READBACKMSB, Q-25
 REALHW, O-6
 REGA, G-33, G-35
 REGB, G-34, G-35
 REGX, G-33, G-35
 REGZ, G-33, G-35
 RESERVED, G-25, G-26, M-43,
 M-44
 RIRQ, M-37
 RMODA, N-4, N-5
 RMODB, N-4, N-5
 RNF, Q-12
 ROM8, M-41
 ROMA, M-41
 ROMC, M-41
 ROME, M-41
 ROMPROT, G-35
 RSEL, M-37
 RST, M-37, P-10
 RST41, O-6
 RSTCMP, M-43, M-44
 RSTCOMP, M-43, M-45
 RSTDELEN, M-45
 RSVD, G-35
 RUN, Q-12
 RXBF, P-9, P-10
 RXBLKD, P-10
 RXEN, O-3
 RXOVRUN, O-3
 RXPH, P-9, P-10
 RXQ, P-10
 RXQEN, P-10
 RXRDY, O-3
 S0X, M-35, M-37
 S0Y, M-35, M-37
 S1X, M-35, M-37
 S1Y, M-35, M-37
 S2X, M-35, M-37
 S2Y, M-35, M-37
 S3X, M-35, M-37
 S3Y, M-35, M-37
 S4X, M-35, M-37
 S4Y, M-35, M-37
 S5X, M-35, M-37
 S5Y, M-35, M-37
 S6X, M-35, M-37
 S6Y, M-35, M-37
 S7X, M-35, M-37
 S7Y, M-35, M-37
 SBC, M-35, M-37
 SCM, M-35, M-37
 SCREENCOL, M-35, M-37, M-38,
 M-41, M-45
 SCRNPTR, M-42, M-45
 SDBSH, O-6
 SDCLK, O-6
 SDCS, O-6
 SDDATA, O-6
 SDR, N-3-N-5
 SE, M-35, M-37
 SECTOR, Q-11, Q-12
 SECTOR0, Q-19
 SECTOR1, Q-19, Q-20
 SECTOR2, Q-19, Q-20
 SECTOR3, Q-19, Q-20
 SEXX, M-35, M-37
 SEXY, M-35, M-38
 SHDEMU, M-45
 SIDBDRWD, M-42, M-45
 SIDE, Q-11, Q-12
 SMTH, M-45
 SP, N-4, N-5
 SPH, G-34, G-35
 SPL, G-34, G-36
 SPMOD, N-4, N-5
 SPR0COL, M-36, M-38
 SPR16EN, M-42, M-45
 SPR1COL, M-36, M-38
 SPR2COL, M-36, M-38
 SPR3COL, M-36, M-38
 SPR4COL, M-36, M-38
 SPR5COL, M-36, M-38
 SPR640, M-45

SPR6COL, M-36, M-38
 SPR7COL, M-36, M-38
 SPRALPHAVAL, M-43, M-45
 SPRBPMEN, M-42, M-45
 SPRENALPHA, M-43, M-45
 SPRENV400, M-43, M-45
 SPRHGHT, M-42, M-45
 SPRHGTEN, M-42, M-45
 SPRMC0, M-36, M-38, M-41,
 M-42, M-45
 SPRMC1, M-36, M-38, M-41,
 M-42, M-45
 SPRPALSEL, M-43, M-45
 SPRPTR16, M-45
 SPRPTRADR, M-42, M-43, M-45
 SPRPTRBNK, M-43, M-45
 SPRTILEN, M-42, M-45
 SPRX64EN, M-42, M-45
 SPRXSMSBS, M-42, M-45
 SPRYADJ, M-43, M-45
 SPRYSMSBS, M-43, M-45
 SPTRCONT, M-46
 SRPYMSBS, M-43, M-46
 SSC, M-35, M-38
 STEP, Q-11, Q-12
 STRM, P-10
 STRTA, N-4, N-5
 STRTB, N-4, N-5
 SWAP, Q-12
 SXMSB, M-35, M-38
 SYNCMOD, O-3, O-4
 SYSCTL, O-4, O-6
 TA, N-4, N-5
 TALATCH, N-6-N-8
 TARGANY, Q-15
 TB, N-4, N-5
 TBDRPOS, M-42, M-46
 TEXTXPOS, M-42, M-46
 TEXTYPOS, M-42, M-46
 TIMERA, N-3-N-5
 TIMERB, N-3-N-5
 TK0, Q-12
 TOD50, N-4, N-6
 TODAMPM, N-4, N-6-N-8
 TODEDIT, N-6
 TODHOUR, N-3, N-4, N-6-N-8
 TODJIF, N-3, N-4, N-6-N-8
 TODMIN, N-6-N-8
 TODSEC, N-3, N-4, N-6-N-8
 TOUCH1XLSB, Q-21, Q-22
 TOUCH1XMSB, Q-21, Q-22
 TOUCH1YLSB, Q-21, Q-22
 TOUCH1YMSB, Q-21, Q-22
 TOUCH2XLSB, Q-21, Q-22
 TOUCH2XMSB, Q-22
 TOUCH2YLSB, Q-22
 TOUCH2YMSB, Q-22
 TRACK, Q-11, Q-13
 TXEN, O-4
 TXIDLE, P-10
 TXPH, P-10
 TXQ, P-10
 TXQEN, P-10
 TXRST, P-10
 TXSZLSB, P-9, P-10
 TXSZMSB, P-9, P-10
 UARTDATA, G-34, G-36
 UFAST, O-6
 UNIT0INA, G-24, G-26
 UNIT0INB, G-24, G-26
 UNIT0OUT, G-24, G-26
 UNIT10INA, G-24, G-26
 UNIT10INB, G-24, G-26
 UNIT10OUT, G-25, G-26
 UNIT11INA, G-24, G-26
 UNIT11INB, G-24, G-26
 UNIT11OUT, G-25, G-26
 UNIT12INA, G-24, G-26
 UNIT12INB, G-24, G-26
 UNIT12OUT, G-25, G-27
 UNIT13INA, G-24, G-27
 UNIT13INB, G-24, G-27
 UNIT13OUT, G-25, G-27
 UNIT14INA, G-24, G-27

UNIT14INB, G-24, G-27
 UNIT14OUT, G-25, G-27
 UNIT15INA, G-24, G-27
 UNIT15INB, G-24, G-27
 UNIT15OUT, G-25, G-27
 UNIT1INA, G-24, G-27
 UNIT1INB, G-24, G-27
 UNIT1OUT, G-24, G-27
 UNIT2INA, G-24, G-27
 UNIT2INB, G-24, G-27
 UNIT2OUT, G-24, G-27
 UNIT3INA, G-24, G-27
 UNIT3INB, G-24, G-28
 UNIT3OUT, G-24, G-28
 UNIT4INA, G-24, G-28
 UNIT4INB, G-24, G-28
 UNIT4OUT, G-25, G-28
 UNIT5INA, G-24, G-28
 UNIT5INB, G-24, G-28
 UNIT5OUT, G-25, G-28
 UNIT6INA, G-24, G-28
 UNIT6INB, G-24, G-28
 UNIT6OUT, G-25, G-28
 UNIT7INA, G-24, G-28
 UNIT7INB, G-24, G-28
 UNIT7OUT, G-25, G-28
 UNIT8INA, G-24, G-28
 UNIT8INB, G-24, G-28
 UNIT8OUT, G-25, G-28
 UNIT9INA, G-24, G-29
 UNIT9INB, G-24, G-29
 UNIT9OUT, G-25, G-29
 UNUSED, O-4, O-6
 UPDN1, Q-21, Q-22
 UPDN2, Q-21, Q-22
 USEREA0, Q-15
 USEREA1, Q-15
 V400, M-41
 VDRO, Q-20
 VEQINH, Q-20
 VFAST, M-46
 VFDC0, Q-20
 VFDC1, Q-20
 VFLOP, G-36
 VGAHDTV, M-46
 VICIII, Q-20
 VICMODE, G-34, G-36
 VIRTKEY1, O-4, O-7
 VIRTKEY2, O-4, O-7
 VIRTKEY3, O-4, O-7
 VLOST, Q-20
 VPOS, M-39, M-41
 VRFOUND, Q-20
 VRNF, Q-20
 VS, M-35, M-38
 VSYNCP, M-46
 VWFOUND, Q-20
 WATCHDOG, G-34, G-36
 WGATE, Q-13
 WRCMD, Q-13
 WREN, G-29
 WTREQ, Q-13
 XINV, Q-22
 XPOS, M-42, M-46
 XSCL, M-35, M-38
 YINV, Q-22
 YSCL, M-35, M-38
 relational operators, 8-30
 REM, B-171
 RENAME, B-172
 RENUMBER, 8-38, B-173
 RESQ, H-129
 RESTORE, B-174
 RESUME, B-175
 RETURN, B-176
 revers, 17-7
 RGRAPHIC, B-177
 RIGHT\$, B-178
 RLA, H-43
 RMB0, H-97
 RMB1, H-97
 RMB2, H-98
 RMB3, H-98
 RMB4, H-99

RMB5, H-99
RMB6, H-99
RMB7, H-100
RMOUSE, B-179
RND, B-180
RND(), 8-45
ROL, H-43, H-100
ROLO, G-14, H-130
ROR, H-44, H-101
RORO, G-14, H-131
ROW, H-101
RPALETTE, B-181
RPEN, B-182
RPLAY, B-183
RRA, H-45
RREG, B-184
RSPCOLOR, B-185
RSPEED, B-186
RSPPOS, B-187
RSPRITE, B-188
RSVQ, H-132
RTI, H-45, H-102
RTS, H-46, H-102
RUN, B-189
RWINDOW, B-190
RXNORMAL, P-11
RXONLYONE, P-11

SAVE, B-191
SAX, H-46
SBC, H-47, H-48, H-103, H-133
SBCQ, G-14, H-134
SBX, H-48
scientific notation, 8-45
SCNCLR, B-192
SCRATCH, B-193
SCREEN, B-194
SEC, H-49, H-103
SED, H-49, H-104
SEE, H-104
SEI, H-49, H-105
SET, B-197
set16bitcharmode, 17-6
setcharsetaddr, 17-4
setcolramoffset, 17-4
setextendedattrib, 17-6
sethotregs, 17-6
setmappedpal, 17-10
SETMEMORY, K-19
setpalbank, 17-9
setpalbanka, 17-9
setpalentry, 17-10
SETPC, K-17
setscreenaddr, 17-3
setscreensize, 17-5
SGN, B-198
SHA, H-50
SHX, H-50
SHY, H-51
SIN, B-199
SLEEP, B-200
SLO, H-51
SMB0, H-105
SMB1, H-106
SMB2, H-106
SMB3, H-106
SMB4, H-107
SMB5, H-107
SMB6, H-107
SMB7, H-108
SOUND, B-201
SPC, B-202
SPEED, B-203
SPRCOLOR, B-204
SPRITE, B-205
SPRSV, B-206
SQR, B-207
SRE, H-52
ST, B-208
STA, H-53, H-108, H-135
STARTTX, P-11
STEP, 8-13, B-209
STOP, 8-39, B-210
STOPTX, P-11
STQ, G-14, H-135

STR\$, B-211
 string, 8-13
 STX, H-53, H-108
 STY, H-53, H-109
 STZ, H-109
 SYNTAX ERROR, 8-4
 SYS, B-212

TAB, B-214, H-110
 TAN, B-215
 TAS, H-54
 TAX, H-54, H-110
 TAY, H-55, H-110
 TAZ, H-111
 TBA, H-111
 TEMPO, B-216
 textcolor, 17-7
 Texture Scaling, L-15
 THEN, 8-30, B-217
 TI, B-218
 TI\$, B-219
 TIB, Q-8, Q-11
 TO, B-220
 togglecase, 17-6
 TRACE, K-19
 Track Information Block, Q-8, Q-11
 TRAP, B-221
 TRB, H-112
 TROFF, B-222
 TRON, B-223
 TSB, H-112
 TSX, H-55, H-113
 TSY, H-113
 TXA, H-56, H-114

TXS, H-56, H-114
 TYA, H-56, H-115
 TYPE, B-224
 Type mismatch error, 8-17
 TYS, H-115
 TZA, H-115

UARTDIVISOR, K-15
 underline, 17-8
 unequal, 8-31
 UNTIL, B-225
 USING, B-226
 USR, B-228
 Utility Menu, I-5

VAL, B-229
 variable, 8-8
 numeric, 8-15
 string, 8-15
 VERIFY, B-230
 VIEWPORT, B-231
 vline, 17-12
 VOL, B-232

WAIT, B-233
 Warnings
 Extra Ignored, 8-22
 WATCHPOINT, K-19
 wherex, 17-14
 wherey, 17-14
 WHILE, B-234
 WINDOW, B-235

XAA, H-57
 XOR, B-236

About the MEGA65 Book

C64 and C65 program and peripheral compatibility ... amazing sound ... true arcade-class graphics ... beautifully finished hardware ... full mechanical keyboard ... rich networking capabilities and one of the fastest 6502-class processors available make the MEGA65 truly unique for home, business or educational use.

The MEGA65 Book collects into a single huge volume all the information you need to know about your MEGA65. Collecting all of the key information of the various MEGA65 user's guides and reference manuals in once place, this book provides detailed information on every topic, including BASIC programming, sound, graphics, networking, assembly language programming, cross-platform development, including using high-level languages like C or KickC, the MEGA65's powerful 8-bit chipset, and how to use its powerful FPGA core to implement other computer systems.

This book is the must-have reference for the MEGA65, that every user, whether beginner or advanced, should have with them when exploring the full potential of the MEGA65.

With authors including professional writers, university lecturers and 8-bit experts, the content is both accessible and extensive. Beginners will find detailed explanations of how to get started, while advanced users will find highly detailed technical information on the inner workings of every aspect of the MEGA65.

In short, this book is designed for you to get the most out of the MEGA65's extensive capabilities.

