

DISKALIGNER

**VIC 1541 Floppy Disk Drive
Simple Head Alignment Instructions**

Program by Willem Kovessy

Manual edited by Stuart Allan

Copyright 1984

**G.R.Q. MARKETING LTD.,
P.O. Box 197,
THORNHILL, Ontario.
L3T 3N3**

INDEX

INTRODUCTION	2
WHAT IS "HEAD ALIGNMENT"?	4
DRIVE DISASSEMBLY PROCEDURE	8
HEAD ALIGNMENT PROCEDURE	12
ALIGNMENT METHOD ONE	15
ALIGNMENT METHOD TWO	17
VERIFICATION	17
TROUBLESHOOTING SUMMARY.....	18
CHECKING DRIVE SPEED.....	19

INTRODUCTION:

The COMMODORE VIC 1541 FLOPPY DISK DRIVE is an excellent quality disk drive capable of providing good service over many years of use. However, since you have purchased this program, you are probably experiencing some doubts in this regard. One of the more common problems encountered is the gradual misalignment of the READ/WRITE HEAD after the drive has been used for an extended period.

You probably first noticed this problem when reading from or writing to older disks (those formatted some time ago). Loading or saving takes longer, and the little red light blinks out or flashes erratically throughout the process. (Normally, the red light should be on continuously as data is being read or written, blinking out only when an error is detected and the drive retries the operation in order to obtain good data.

It is possible that other mechanical errors have occurred. Dirt may have deposited on the READ/WRITE head, your floppy may be damaged or worn, clamping and rotation may be faulty, the STEP MOTOR or some electronic component may have failed. Most frequently, however, head alignment is all that is required.

This can be done by an authorized COMMODORE repair center, and your drive should be returned to them during the warranty period (since do-it-yourself alignment will void the warranty). When the warranty has expired, however, the cost is considerable and, since Murphy's law decrees that misalignment will occur on a weekend or at that time when the drive is needed most, the "shop-time" can seem interminable.

COMMODORE'S service manual for the VIC 1541 DISK DRIVE details an alignment method utilizing a special ALIGNMENT FLOPPY and an oscilloscope. However, a reasonably dexterous computer owner can do a very good job using the DISKALIGNER program and a PHILLIPS SCREWDRIVER. The first time it may take an hour or more, but next time (and if you plan to keep and use your VIC 1541 you can be sure that there will be a next time) you should be able to do the job in less than 30 minutes.

With all electrical equipment, great care must be taken to avoid shocks, particularly when it is necessary to operate the equipment with the covers removed. Care must be taken not to touch the electrical components on the circuit board inside the drive, or the wires and switches (particularly the heavier wires and the transformer at the rear). There are several sizes of Phillips screwdrivers available, and it important to use one that gives a positive grip on the screws.

Proper alignment can be achieved by two possible methods. Both are detailed in this manual; both can be tried. The final choice of method is up to you. BEFORE YOU START, READ THESE INSTRUCTIONS COMPLETELY AND CAREFULLY.

WHAT IS "HEAD ALIGNMENT"?

When the floppy is inserted in the drive and the drive motor comes on, the plastic disk inside the protective cover is being rotated at about 300 RPM. A READ/WRITE HEAD, somewhat similar to the head in a tape recorder, is pressed against the plastic through the oblong opening in the cover.

The READ/WRITE HEAD can be moved along the length of the oblong hole to and from the center of the floppy. This movement is done in 69 individual steps by a STEP MOTOR (see figure 1). Every second of these 69 steps should center the head over one of the 35 tracks on the floppy (see figure 2). Data is then read from or written to that track as it passes the head. The logic on the circuit board is responsible for determining which track contains the data on which way the head should step to find a given track.

FIGURE 1

Movement of
Head over floppy

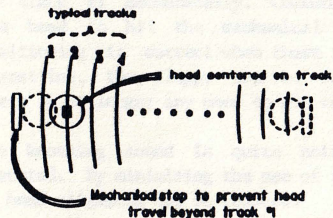
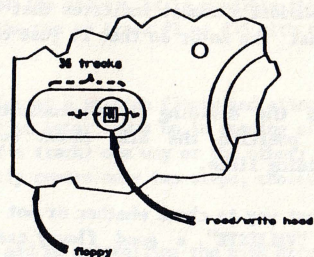

FIGURE 2

Proper Positioning of
Head over Track

If the head is not positioned on the center of the tracks, the signal may become weaker or desired data may be confused with that on the next track. Usually this misalignment occurs for all tracks equally and a single adjustment of the STEP MOTOR will correct the situation.

The STEP MOTOR is held in place by two Phillips screws on the bottom of the drive. If these are loosened, the motor can be rotated enough to change the position of the head by approximately one full track. What we need first is a method whereby we can position the STEP MOTOR so that the head is centered over the tracks.

Here are two methods:

1. Assume that the mechanical stop at track #1 is positioned properly (Commodore's manual indicates that it should be .01" past track #1) and adjust the motor so that it just touches this stop when going to track #1.
2. Find the dividing line between the tracks where nothing can be read, and position the STEP MOTOR so that head is half way between these dividing lines.

(The best way to check whether or not the head is centered over the tracks is to "VALIDATE" a good floppy created by Commodore, such as the "1541 TEST/DEMO" disk supplied with the drive. If the head is centered on the tracks, the red light will not go out until the "VALIDATE" is complete.)

- 6 -

Our second need is to position the STEP MOTOR so that all 35 tracks can be read with the 69 steps. Since the motor moves two steps for each track and its adjustment range is one track (or two steps), it is possible that the head is centered but cannot move all the way to track #1 or #35 with the 69 steps.

The best way to determine this is to format a scratch floppy and attempt to read the first and last tracks. If an error shows up in reading either, move the STEP MOTOR one step (or half a track) one way or the other; since the total possible adjustment usually covers only two steps, choices are limited.

The DISKALIGNER UTILITY PROGRAM will aid in controlling the disk drive for all the above operations.

The misalignment of the VIC 1541's head (and therefore the need to realign) appears to be increased by the use of commands that cause the head to reset to track #1 mechanically. Commands such as "FORMAT", for example, cause the head to hit the mechanical stop repeatedly, to ensure that the positioning is correct when there is no other reference available. After formatting, the floppy can be read to determine where the head is, and there is no longer any need to hit the stop.

The knocking sound is quite noticeable when the "FORMAT" command is executed. By minimizing the use of this or similar commands, the frequency of head alignment can be reduced.

DRIVE DISASSEMBLY PROCEDURE:

1. Unplug the power cable and serial bus cable from the rear of the drive. Turn the drive upside down on a smooth surface and remove four screws holding the cover on (see figure 3).
2. Turn drive right side up and remove cover. This will expose a large circuit board on the top of the drive. Great care must be exercised not to damage any of the components on this board and to avoid electrical shock. The drive must never be lifted or moved by this board.

FIGURE 3

Bottom of I54I
Floppy Disk Drive

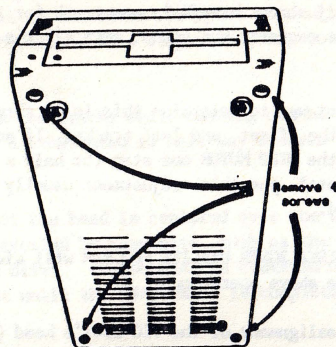

- 8 -

3. Remove the small cable connector (containing one red and one black wire) from the left front of the circuit board. The connector is pressed down on three pins and can be gently eased up (see figure 4). Remove six screws holding the drive assembly in the lower casing (see figure 4).
4. Hold the drive assembly at the front and the rear to remove it from the lower casing. By turning the lower casing upside down it can serve as an excellent support for the drive assembly while you are working on it. Place the drive assembly on its edge with one of its tabs through a vent slot in the lower casing as shown in figure 5. This will expose the lower surface of the drive while leaving it fully operational.
5. Reinsert the power and serial bus cables in the rear of the drive and turn the drive on.

NOTE: The disassembled disk drive must be located at least two feet away from the T.V. set or monitor. Magnetic fields emanating from the set can cause a "read error" that will make realignment impossible.

- 9 -

FIGURE 4

Floppy Disk Drive
with cover removed

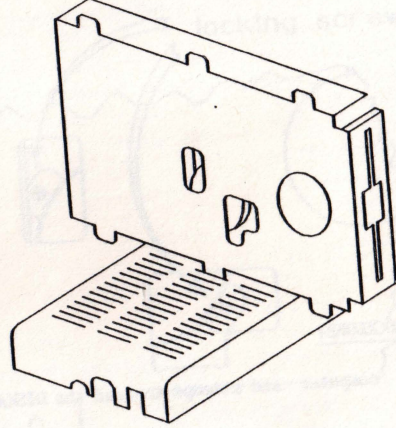
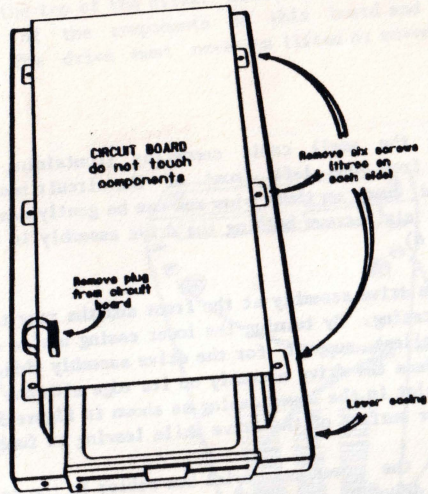

FIGURE 5

Bottom of drive
supported on
inverted lower
casing

HEAD ALIGNMENT PROCEDURE:

1. Turn on the computer and attempt to load the DISKALIGNER utility by typing:

LOAD "DISKALIGNER" ,8,1

If the DISKALIGNER will not load, it will be necessary to complete step two and repeat the loading procedure.

2. Figure 6 shows the screws locking the STEP MOTOR in position. Locate these screws on the drive assembly and, using a Phillips screwdriver, loosen both screws two turns but do not remove them. It will be necessary to support the drive from the other side while loosening the screws. Be very careful not to damage any of the components on the circuit board.

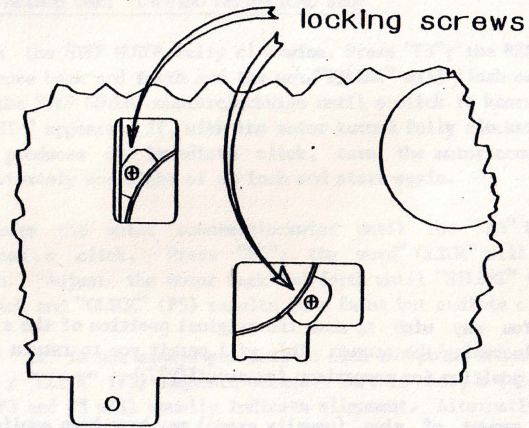
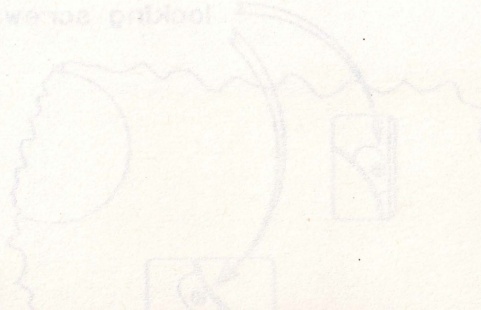

FIGURE 6

Bottom of Drive
showing screws locking
Step Motor
in position

locking screws



NOTE: You may wish to mark the original position of the step motor before loosening the screws. This will permit you to return it to its original position for comparison (or security).

A small amount of glue (usually green) may have been applied to the tops of the screws to keep them from coming loose. This should be scraped off before doing any further adjustments.

If you were unable to load the DISKALIGNER previously, rotate the step motor approximately an eighth of an inch and try loading again. Keep repeating this procedure until you reach a position where the program will load. If the program still cannot be loaded, you have a problem other than head alignment.

3. Type "RUN" to activate the DISKALIGNER. Insert the "Commodore VIC 1541 TEST/DEMO" floppy that was originally supplied with your disk drive (or any other commercially produced disk that you know was formatted and recorded accurately) and hit "RETURN". Ensure that the floppy is write-protected.

ALIGNMENT METHOD ONE: TAPPING MECHANICAL STOP

4. Rotate the STEP MOTOR fully clockwise. Press "F3"; the READ/WRITE HEAD will move back and forth and the word "SILENT" will flash on the screen. Move the STEP MOTOR counterclockwise until a click is heard as the word "SILENT" appears. If, with the motor turned fully clockwise, pressing "F3" produces an immediate click, turn the motor counterclockwise approximately one-eighth of an inch and start again.

5. Now edge the motor counterclockwise until the "F3" key no longer produces a click. Press "F5"; the word "CLICK" will flash on the screen. Adjust the motor back and forth until "SILENT" (F3) produces no click and "CLICK" (F5) results in a faint but audible click.

NOTE: It is not always possible to find the point where the "SILENT" (F3) / "CLICK" (F5) sequence occurs. In this case, a faint click with both F3 and F5 will usually indicate alignment. Alternatively, "Method Two" may be employed.

6. When the motor has been positioned, tighten the two Phillips screws and use the automatic function (F1) to verify that the adjustment is correct.

METHOD TWO: LOCATING GAPS BETWEEN TRACKS

4. Rotate the STEP MOTOR fully clockwise. Press "F2"; this will move the READ/WRITE HEAD to track 18 and read it continuously. Move the STEP MOTOR counterclockwise until the head can be heard jumping quickly back and forth between two tracks. You'll have to be in a very quiet room and listen very carefully to detect this movement.

This position will be exactly between two tracks. Mark it by drawing a fine line on the back of the STEP MOTOR housing.

5. Continue rotating the STEP MOTOR counterclockwise until the next similar point is found. Mark this point as well.
6. The correct head alignment position is either mid-way between the two marks, at a point equal to half the distance between the two points before the first mark or the same distance after the second mark. The STEP MOTOR's range of movement will limit you to one of the two latter positions, reducing total choices to two. (To determine which position is correct, see steps 7 and 8.)

VERIFICATION:

7. Use the "VALIDATE" test (F7) to confirm proper alignment. Watch the red light carefully; it should not flicker until the test is completed. If a problem is indicated, repeat the procedure from step 4 (method one) or recheck the positions between the tracks (method two).
8. One final test: format a scratch floppy and test tracks #1 and #35 by pressing "F8" and answering the appropriate prompts. If errors are encountered, rotate the motor one-eighth of an inch counterclockwise and repeat alignment procedure (method one), or use the alternative position from "method two" and repeat steps #7 and #8.

If the test runs to completion, you have successfully aligned the head on your disk drive and this program has paid for itself. CONGRATULATIONS!

9. Reassemble the drive, reversing the steps of the DRIVE DISASSEMBLY PROCEDURE.

TROUBLESHOOTING SUMMARY:

1. If the DISKALIGNER program will not load, loosen the screws on the step motor, rotate approximately one-eighth of an inch and try again. Keep repeating this procedure until you reach a position where the program will load.
2. If, using Alignment Method One, you cannot find the position where the CLICK/SILENT sequence occurs, a faint click with both F3 and F5 usually indicates alignment. If VALIDATE (F7) does not confirm alignment, try Method Two.
3. If the FORMAT test (F8) indicates an error, rotate the step motor one-eighth of an inch and repeat alignment procedure (Method One), or use alternate position (Method Two).
4. If neither Method One nor Method Two are successful, your problem is probably not misalignment. Return your drive to an authorized Repair Centre.

CHECKING DRIVE SPEED:

Another possible cause of poor performance is improper disk rotation speed. While the drive is out of the case, this can be checked and adjusted very easily.

Note the stroboscopic disk visible on the bottom of the drive chassis. When rotating, the marks on the outer ring should appear stationary under normal (60 Hz.) artificial light. (To rotate the disk, use VALIDATE (F7).)

If a problem is detected, insert a small slot-type screwdriver in the quarter inch hole in the chassis and rotate the screw inside one way or the other until the correct speed is attained. (Note: this screw may be secured with a dot of glue; you'll have to break this seal.)

WARRANTY AND LIABILITY

Neither the manufacturer nor any dealer distributing this product makes any warranty, express or implied, with respect to this manual, the DISKALIGNER disk or any related items, their quality, performance, merchantability or fitness for any use. It is the responsibility solely of the purchaser to determine suitability of these products for any purpose.

In no case will the manufacturer be held liable for damages direct, indirect or incidental resulting from any defect or omission in the manual, the disk or other related items and processes, including but not limited to any interruption of service, loss of business, anticipated profit or other consequential damages.

This statement of limited liability replaces all other warranties or guarantees, express or implied, including warranties of merchantability and fitness for any purpose. The manufacturer neither assumes any other warranty or liability nor authorizes any other person to assume any other warranty or liability for it, in connection with the sale of its products.

COPYRIGHT

Copies of this manual or this disk may not be given or sold to any person or institution except with express written permission of the manufacturer.